

# THE DEALTERNATING NUMBER AND THE ALTERNATION NUMBER OF A CLOSED 3-BRAID

TETSUYA ABE AND KENGO KISHIMOTO

ABSTRACT. We give an upper bound for the dealternating number of a closed 3-braid. As applications, we determine the dealternating numbers, the alternation numbers and the Turaev genera of some closed positive 3-braids. We also show that there exist infinitely many positive knots with any dealternating number (or any alternation number) and any braid index.

## 1. INTRODUCTION

A *link* is a disjoint union of circles embedded in  $S^3$ , and a *knot* is a link with one component. Throughout this paper, all links are oriented. A link diagram is *n-almost alternating* if  $n$  crossing changes in the diagram turn the diagram into an alternating link diagram (cf. [2]). A link is *n-almost alternating* if it has an  $n$ -almost alternating diagram and no diagram that can be turned into an alternating diagram in fewer crossings. We say that a link is *almost alternating* if it is 1-almost alternating. It is known that all non-alternating knots of eleven or fewer crossings except  $11_{n95}$  and  $11_{n118}$  are almost alternating [2], [13]. The first author showed that there exists  $n$ -almost alternating knot for any positive integer  $n$  [1]. We say that a link  $L$  has *dealternating number*  $n$  if it is  $n$ -almost alternating. We denote by  $\text{dalt}(L)$  the dealternating number of a link  $L$ . We note that all non-alternating Montesinos links and all semi-alternating links are almost alternating (see Appendix).

Kawauchi introduced the alternation number of a link [16], which measures how far it is from alternating links. Let  $L$  and  $L'$  be links. The *Gordian distance*  $d_G(L, L')$  between  $L$  and  $L'$  [23] is the minimal number of crossing changes needed to deform a diagram of  $L$  into that of  $L'$ , where the minimum is taken over all diagrams of  $L$ . The *alternation number*  $\text{alt}(L)$  of a link  $L$  is the minimal number of  $d_G(L, L')$  among all alternating links  $L'$ . By definition, we have  $\text{alt}(L) \leq \text{dalt}(L)$  for any link  $L$ . We note that the alternation number differs from the dealternating number. For example, the Whitehead double of the trefoil is 2-almost alternating [2], however it has alternation number one. The first author gave a lower bound for the alternation number of a knot, and determined the torus knots with alternation number one [1]. By using this lower bound, Kanenobu determined the alternation numbers of some torus knots [14].

In this paper, we give an upper bound for the dealternating number of a closed 3-braid (Theorem 2.5). As an application, we determine the dealternating numbers and the alternation numbers of some closed positive 3-braid knots as follows.

**Theorem 3.1.** Let  $\beta$  be a 3-braid of the form

$$\Delta^{2n} \prod_{i=1}^r \sigma_1^{p_i} \sigma_2^{q_i}$$

such that  $\widehat{\beta}$  is a knot and  $p_i, q_i \geq 2$  for  $i = 1, 2, \dots, r$ . Then we have

$$\text{alt}(\widehat{\beta}) = \text{dalt}(\widehat{\beta}) = n + r - 1.$$

The *braid index*  $b(L)$  of a link  $L$  is the minimal number of strands of any braid whose closure is equivalent to  $L$ . We show that there exist infinitely many positive knots with any dealternating number (or any

---

2000 *Mathematics Subject Classification.* Primary 57M25.

*Key words and phrases.* Dealternating number; alternation number; Turaev genus; braid index; closed 3-braid.

alternation number) and any braid index.

**Theorem 4.1.** For any  $m \in \mathbb{Z}_{\geq 0}$  and  $n \geq 3$ , there exist infinitely many positive knots  $K$  with  $\text{alt}(K) = \text{dalt}(K) = m$  and  $b(K) = n$ .

To a knot diagram  $D$ , Turaev associated a closed orientable surface embedded in  $S^3$ , called the *Turaev surface*. The definition of the Turaev surface is given in Section 5 (see also [8], [9], [20]). The *Turaev genus*  $g_T(K)$  of a knot  $K$  was first defined in [9] as the minimal number of the genera of the Turaev surfaces of diagrams of  $K$ . We determine the Turaev genera and the dealternating numbers of the  $(3, 3n + i)$ -torus knots, where  $i = 1, 2$ .

**Theorem 5.9.** Let  $T_{3,3n+i}$  be the  $(3, 3n + i)$ -torus knot, where  $i = 1, 2$ . Then we have

$$g_T(T_{3,3n+i}) = \text{dalt}(T_{3,3n+i}) = n.$$

This paper is constructed as follows: In Section 2, we give an upper bound for the dealternating number of a closed 3-braid. In Section 3, we determine the dealternating numbers and the alternation numbers of some closed positive 3-braid knots by using a lower bound introduced by the first author [1]. In Section 4, we show that there exist infinitely many positive knots with any dealternating number (or alternation number) and any braid index. In Section 5, we determine the dealternating numbers and the Turaev genera of the  $(3, 3n + i)$ -torus knots, where  $i = 1, 2$ . In Appendix, we observe that non-alternating Montesinos links and semi-alternating links are almost alternating. This Appendix is authored by the first and the second authors and In Dae Jong.

## 2. AN UPPER BOUND FOR THE DEALTERNATING NUMBER OF A CLOSED 3-BRAID

In this section, we give an upper bound for the dealternating number of a closed 3-braid. The  $n$ -braid group  $B_n$ ,  $n \in \mathbb{Z}_{>0}$ , is a group which has the following presentation.

$$\left\langle \sigma_1, \sigma_2, \dots, \sigma_{n-1} \mid \begin{array}{ll} \sigma_t \sigma_s = \sigma_s \sigma_t & (|t - s| > 1) \\ \sigma_t \sigma_s \sigma_t = \sigma_s \sigma_t \sigma_s & (|t - s| = 1) \end{array} \right\rangle.$$

Let  $\beta$  be an  $n$ -braid of the form

$$\prod_{j=1}^m \sigma_{i_j}^{a_j},$$

where  $i_j \neq i_{j+1}$  and  $a_j$  is nonzero integer for  $j = 1, 2, \dots, m$ . We call  $\sigma_{i_j}^{a_j}$  the *syllables* of  $\beta$ , which represent an  $a_j$ -half twists on two strands in  $\beta$ . We denote by  $\widehat{\beta}$  the closure of a braid  $\beta$ . Set

$$\begin{aligned} E_+(\beta) &= \{ j \mid i_j \text{ is even, and } a_j \text{ is positive} \}, \\ E_-(\beta) &= \{ j \mid i_j \text{ is even, and } a_j \text{ is negative} \}, \\ O_+(\beta) &= \{ j \mid i_j \text{ is odd, and } a_j \text{ is positive} \}, \\ O_-(\beta) &= \{ j \mid i_j \text{ is odd, and } a_j \text{ is negative} \}. \end{aligned}$$

We denote by  $|X|$  the number of elements of a set  $X$ .

**Lemma 2.1.** *Let  $\beta$  be an  $n$ -braid. Then we have*

$$\text{dalt}(\widehat{\beta}) \leq \min\{|E_+(\beta)| + |O_-(\beta)|, |E_-(\beta)| + |O_+(\beta)|\}.$$

*Proof.* Let  $D$  be the closed braid diagram of  $\widehat{\beta}$ . We may assume that  $|E_+(\beta)| + |O_-(\beta)| \leq |E_-(\beta)| + |O_+(\beta)|$  since we can prove in a similar way as in the case  $|E_+(\beta)| + |O_-(\beta)| \geq |E_-(\beta)| + |O_+(\beta)|$ . Let  $T_j$  be a 2-tangle diagram in  $D$ , which is represented by a syllable  $\sigma_{i_j}^{a_j}$  for  $j = 1, 2, \dots, m$ . For all  $j \in E_+(\beta) \cup O_-(\beta)$ , we deform  $T_j$  by the Reidemeister moves, and we apply a crossing change at the crossing  $c$  as in Figure 1.

By this deformation, we obtain an alternating diagram. Thus we have

$$\text{dalt}(\widehat{\beta}) \leq |E_+(\beta)| + |O_-(\beta)|.$$

□

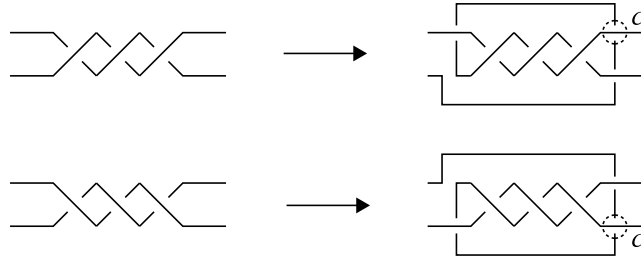

FIGURE 1.

An  $n$ -braid  $\beta$  is *positive* if  $a_j$  is positive for all  $j$ . We note that a positive 3-braid is conjugate to a braid of the form

$$\prod_{i=1}^r \sigma_1^{p_i} \sigma_2^{q_i},$$

where  $p_i, q_i \in \mathbb{Z}_{>0}$  for  $i = 1, 2, \dots, r$ .

**Lemma 2.2.** *Let  $\beta$  be a positive 3-braid of the form*

$$\prod_{i=1}^r \sigma_1^{p_i} \sigma_2^{q_i},$$

where  $p_i, q_i \in \mathbb{Z}_{>0}$  for  $i = 1, 2, \dots, r$ . Then we have

$$\text{dalt}(\widehat{\beta}) \leq r - 1.$$

*Proof.* Let  $D$  be the closed braid diagram of  $\widehat{\beta}$ . We deform  $D$  into an alternating diagram by the Reidemeister moves and a crossing change at each crossing  $c_i$  ( $i = 1, 2, \dots, r - 1$ ) as in Figure 2.

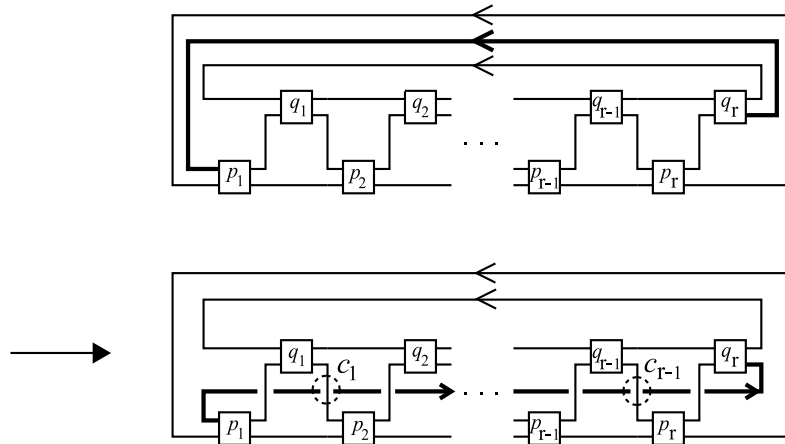

FIGURE 2.

□

Murasugi showed the following.

**Lemma 2.3** ([26]). *Every 3-braid is conjugate to an element of the following sets.*

$$\begin{aligned}
\Omega_0 &= \{\Delta^{2n} \mid n \in \mathbb{Z}\}, \\
\Omega_1 &= \{\Delta^{2n}(\sigma_1\sigma_2) \mid n \in \mathbb{Z}\}, \\
\Omega_2 &= \{\Delta^{2n}(\sigma_1\sigma_2)^2 \mid n \in \mathbb{Z}\}, \\
\Omega_3 &= \{\Delta^{2n+1} \mid n \in \mathbb{Z}\}, \\
\Omega_4 &= \{\Delta^{2n}\sigma_1^{-p} \mid n \in \mathbb{Z}, p \in \mathbb{Z}_{>0}\}, \\
\Omega_5 &= \{\Delta^{2n}\sigma_2^q \mid n \in \mathbb{Z}, q \in \mathbb{Z}_{>0}\}, \\
\Omega_6 &= \{\Delta^{2n} \prod_{i=1}^r \sigma_1^{-p_i} \sigma_2^{q_i} \mid n \in \mathbb{Z}, r, p_i, q_i \in \mathbb{Z}_{>0} \ (i = 1, 2, \dots, r)\},
\end{aligned}$$

where  $\Delta = \sigma_1\sigma_2\sigma_1$ .

We denote by  $\widehat{\Omega}_j$  ( $j = 0, \dots, 6$ ) the set of the closures of braids in  $\Omega_j$  ( $j = 0, \dots, 6$ ).

**Remark 2.4.** The closure of the 3-braid  $\Delta^{2n}(\sigma_1\sigma_2)^i \in \Omega_i$  is the  $(3, 3n+i)$ -torus link, where  $i = 0, 1, 2$ . The sets  $\Omega_j$  ( $j = 0, \dots, 6$ ) are mutually disjoint. However, the sets  $\widehat{\Omega}_j$  ( $j = 0, \dots, 6$ ) are not mutually disjoint (see [4], [26]). A closed 3-braid knot is either the  $(3, 3n+i)$ -torus knot or a knot in  $\widehat{\Omega}_6$ .

**Theorem 2.5.** *Let  $\beta$  be a 3-braid in  $\Omega_i$  ( $i = 0, \dots, 6$ ). With the notation of Lemma 2.3, we have*

$$\text{dalt}(\widehat{\beta}) \leq |n|.$$

In particular, we have

- (1)  $\text{dalt}(\widehat{\beta}) \leq |n| - 1$  if  $\beta \in \Omega_i$  ( $i = 1, 2$ ), and  $n < 0$ ,
- (2)  $\text{dalt}(\widehat{\beta}) \leq n - 1$  if  $\beta \in \Omega_4$ ,  $n \geq 0$ , and  $p = 2n - 1, 2n, 2n + 1$ ,
- (3)  $\text{dalt}(\widehat{\beta}) \leq |n| - 1$  if  $\beta \in \Omega_5$ ,  $n \leq 0$ , and  $p = 2n - 1, 2n, 2n + 1$ .

*Proof.* **Case 0:**  $\beta \in \Omega_0$ . We may assume that  $n \geq 0$ , since the mirror image of  $\Delta^{2n}$  is  $\Delta^{-2n}$ . We can modify  $\beta$  into  $\sigma_1^{2n}\sigma_2(\sigma_1^2\sigma_2^2)^{n-1}\sigma_1^2\sigma_2$  by braid relations and conjugations as follows.

$$\begin{aligned}
\beta &= \Delta^{2n} = (\sigma_1\sigma_2\sigma_1)^{2n} \\
&= (\sigma_1\sigma_2\sigma_1\sigma_1\sigma_2\sigma_1)^n \\
&= (\sigma_1^2\sigma_2\sigma_1^2\sigma_2)^n \\
&= \sigma_1^{2n}(\sigma_2\sigma_1^2\sigma_2)^n \\
&= \sigma_1^{2n}\sigma_2(\sigma_1^2\sigma_2^2)^{n-1}\sigma_1^2\sigma_2.
\end{aligned}$$

We note that  $\sigma_1(\sigma_2\sigma_1^2\sigma_2) = (\sigma_2\sigma_1^2\sigma_2)\sigma_1$ . By Lemma 2.2, we have

$$\text{dalt}(\widehat{\beta}) \leq n.$$

The rest of the proof is similar to the proof of Case 0.

**Case 1.1:**  $\beta \in \Omega_1$  and  $n \geq 0$ . We modify  $\beta$  into  $\sigma_1^{2n+1}\sigma_2(\sigma_1^2\sigma_2^2)^n$  by the following equalities.

$$\begin{aligned}
\beta &= \Delta^{2n}(\sigma_1\sigma_2) = (\sigma_1\sigma_2\sigma_1)^{2n}(\sigma_1\sigma_2) \\
&= \sigma_1^{2n}(\sigma_2\sigma_1^2\sigma_2)^n\sigma_1\sigma_2 \\
&= \sigma_1^{2n+1}(\sigma_2\sigma_1^2\sigma_2)^n\sigma_2 \\
&= \sigma_1^{2n+1}\sigma_2(\sigma_1^2\sigma_2^2)^n.
\end{aligned}$$

By Lemma 2.2, we have

$$\text{dalt}(\widehat{\beta}) \leq n.$$

**Case 1.2:**  $\beta \in \Omega_1$  and  $n < 0$ . We modify  $\beta$  into  $\sigma_1^{-2|n|-1}\sigma_2^{-1}(\sigma_1^2\sigma_2^2)^{-|n|+1}$  by the following equalities.

$$\begin{aligned}\beta &= \Delta^{-2|n|}(\sigma_1\sigma_2) = (\sigma_1\sigma_2\sigma_1)^{-2|n|}(\sigma_1\sigma_2) \\ &= (\sigma_1\sigma_2\sigma_1)^{-2|n|+2}(\sigma_1\sigma_2)^{-2} \\ &= \sigma_1^{-2|n|+2}(\sigma_2\sigma_1^2\sigma_2)^{-|n|+1}(\sigma_1\sigma_2)^{-2} \\ &= \sigma_1^{-2|n|-1}(\sigma_2\sigma_1^2\sigma_2)^{-|n|+1}\sigma_2^{-1} \\ &= \sigma_1^{-2|n|-1}\sigma_2^{-1}(\sigma_1^2\sigma_2^2)^{-|n|+1}.\end{aligned}$$

By Lemma 2.2, we have

$$\text{dalt}(\widehat{\beta}) \leq |n| - 1.$$

**Case 2.1:**  $\beta \in \Omega_2$  and  $n \geq 0$ . We modify  $\beta$  into  $\sigma_1^{2n+3}\sigma_2(\sigma_1^2\sigma_2^2)^n$  by the following equalities.

$$\begin{aligned}\beta &= \Delta^{2n}(\sigma_1\sigma_2)^2 = (\sigma_1\sigma_2\sigma_1)^{2n}(\sigma_1\sigma_2)^2 \\ &= \sigma_1^{2n}(\sigma_2\sigma_1^2\sigma_2)^n(\sigma_1\sigma_2)^2 \\ &= \sigma_1^{2n}(\sigma_2\sigma_1^2\sigma_2)^n\sigma_1^2\sigma_2\sigma_1 \\ &= \sigma_1^{2n+3}(\sigma_2\sigma_1^2\sigma_2)^n\sigma_2 \\ &= \sigma_1^{2n+3}\sigma_2(\sigma_1^2\sigma_2^2)^n.\end{aligned}$$

By Lemma 2.2, we have

$$\text{dalt}(\widehat{\beta}) \leq n.$$

**Case 2.2:**  $\beta \in \Omega_2$  and  $n < 0$ . We modify  $\beta$  into  $\sigma_1^{-2|n|+1}\sigma_2^{-1}(\sigma_1^2\sigma_2^2)^{-|n|+1}$  by the following equalities.

$$\begin{aligned}\beta &= \Delta^{-2|n|}(\sigma_1\sigma_2)^2 = (\sigma_1\sigma_2\sigma_1)^{-2|n|}(\sigma_1\sigma_2)^2 \\ &= (\sigma_1\sigma_2\sigma_1)^{-2|n|+2}(\sigma_1\sigma_2)^{-1} \\ &= \sigma_1^{-2|n|+2}(\sigma_2\sigma_1^2\sigma_2)^{-|n|+1}(\sigma_1\sigma_2)^{-1} \\ &= \sigma_1^{-2|n|+1}(\sigma_2\sigma_1^2\sigma_2)^{-|n|+1}\sigma_2^{-1} \\ &= \sigma_1^{-2|n|+1}\sigma_2^{-1}(\sigma_1^2\sigma_2^2)^{-|n|+1}.\end{aligned}$$

By Lemma 2.2, we have

$$\text{dalt}(\widehat{\beta}) \leq |n| - 1.$$

**Case 3:**  $\beta \in \Omega_3$ . We may assume that  $n \geq 0$ , since the mirror image of  $\Delta^{2n+1}$  is  $\Delta^{-(2n+1)}$ . We modify  $\beta$  into  $\sigma_1^{2n+2}\sigma_2(\sigma_1^2\sigma_2^2)^n$  by the following equalities.

$$\begin{aligned}\beta &= \Delta^{2n+1} = (\sigma_1\sigma_2\sigma_1)^{2n+1} \\ &= \sigma_1^{2n}(\sigma_2\sigma_1^2\sigma_2)^n\sigma_1\sigma_2\sigma_1 \\ &= \sigma_1^{2n+2}(\sigma_2\sigma_1^2\sigma_2)^n\sigma_2 \\ &= \sigma_1^{2n+2}\sigma_2(\sigma_1^2\sigma_2^2)^n.\end{aligned}$$

By Lemma 2.2, we have

$$\text{dalt}(\widehat{\beta}) \leq n.$$

Let  $\beta$  be a 3-braid in  $\Omega_4$ . We may assume that  $n \geq 0$ , since the mirror image of  $\Delta^{-2|n|}\sigma_1^{-p}$  is in  $\Omega_5$ . We modify  $\beta$  into  $\sigma_1^{2n-p}\sigma_2(\sigma_1^2\sigma_2^2)^{n-1}\sigma_1^2\sigma_2$  by the following equalities.

$$\begin{aligned}\beta &= \Delta^{2n}\sigma_1^{-p} = (\sigma_1\sigma_2\sigma_1)^{2n}\sigma_1^{-p} \\ &= \sigma_1^{2n-p}\sigma_2(\sigma_1^2\sigma_2^2)^{n-1}\sigma_1^2\sigma_2.\end{aligned}$$

**Case 4.1:**  $\beta \in \Omega_4$  and  $p = 2n$ . We modify  $\beta$  into  $(\sigma_1^2 \sigma_2^2)^n$  by the following equalities.

$$\begin{aligned}\beta &= \sigma_2 (\sigma_1^2 \sigma_2^2)^{n-1} \sigma_1^2 \sigma_2 \\ &= (\sigma_1^2 \sigma_2^2)^n.\end{aligned}$$

By Lemma 2.2, we have

$$\text{dalt}(\widehat{\beta}) \leq n - 1.$$

**Case 4.2:**  $\beta \in \Omega_4$  and  $p = 2n - 1$ . We modify  $\beta$  into  $\sigma_1^2 \sigma_2^4 \sigma_1 \sigma_2^3 (\sigma_1^2 \sigma_2^2)^{n-2}$  by the following equalities.

$$\begin{aligned}\beta &= \sigma_1 \sigma_2 (\sigma_1^2 \sigma_2^2)^{n-1} \sigma_1^2 \sigma_2 \\ &= \sigma_1^2 \sigma_2 \sigma_1 \sigma_2 (\sigma_1^2 \sigma_2^2)^{n-1} \\ &= \sigma_1^3 \sigma_2 \sigma_1^3 \sigma_2^2 (\sigma_1^2 \sigma_2^2)^{n-2} \\ &= \sigma_1^2 \sigma_2^4 \sigma_1 \sigma_2^3 (\sigma_1^2 \sigma_2^2)^{n-2}.\end{aligned}$$

By Lemma 2.2, we have

$$\text{dalt}(\widehat{\beta}) \leq n - 1.$$

**Case 4.3:**  $\beta \in \Omega_4$  and  $p = 2n + 1$ . We deform  $\widehat{\beta}$  into an  $(n - 1)$ -almost alternating diagram by the Reidemeister moves as in Figure 3.

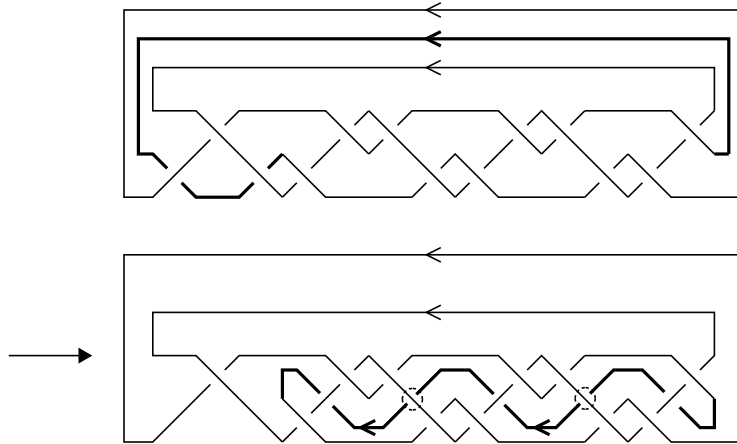

FIGURE 3. The case for  $n = 3$

Thus we have

$$\text{dalt}(\widehat{\beta}) \leq n - 1.$$

**Case 4.4:**  $\beta \in \Omega_4$  and  $p < 2n - 1$ . By Lemma 2.2, we have

$$\text{dalt}(\widehat{\beta}) \leq n.$$

**Case 4.5:**  $\beta \in \Omega_4$  and  $p > 2n + 1$ . By Lemma 2.1, we have

$$\text{dalt}(\widehat{\beta}) \leq n.$$

**Case 5:**  $\beta \in \Omega_5$ . We may assume that  $n \geq 0$ , since the closure of the mirror image of  $\Delta^{-2|n|} \sigma_2^q$  is in  $\widehat{\Omega}_4$ . We modify  $\beta$  into  $\sigma_2^{2n+q} \sigma_1 (\sigma_2^2 \sigma_1^2)^{n-1} \sigma_2^2 \sigma_1$  by the following equalities.

$$\begin{aligned}\beta &= \Delta^{2n} \sigma_2^q = (\sigma_1 \sigma_2 \sigma_1)^{2n} \sigma_2^q \\ &= \sigma_2^{2n+q} \sigma_1 (\sigma_2^2 \sigma_1^2)^{n-1} \sigma_2^2 \sigma_1.\end{aligned}$$

By Lemma 2.2, we have

$$\text{dalt}(\widehat{\beta}) \leq n.$$

**Case 6.1:**  $\beta \in \Omega_6$  and  $n \geq 0$ .

We modify  $\beta$  into  $\sigma_1(\sigma_2^2\sigma_1^2)^{n-1}\sigma_2^2\sigma_1^{-p_1+1}\sigma_2^{q_1}\left(\prod_{i=2}^{r-1}\sigma_1^{-p_i}\sigma_2^{q_i}\right)\sigma_1^{-p_r}\sigma_2^{q_r+2n}$  by the following equalities.

$$\begin{aligned}\beta &= (\sigma_1\sigma_2\sigma_1)^{2n}\prod_{i=1}^r\sigma_1^{-p_i}\sigma_2^{q_i} \\ &= \sigma_2^{2n}(\sigma_1\sigma_2^2\sigma_1)^n\prod_{i=1}^r\sigma_1^{-p_i}\sigma_2^{q_i} \\ &= \sigma_1(\sigma_2^2\sigma_1^2)^{n-1}\sigma_2^2\sigma_1^{-p_1+1}\sigma_2^{q_1}\left(\prod_{i=2}^{r-1}\sigma_1^{-p_i}\sigma_2^{q_i}\right)\sigma_1^{-p_r}\sigma_2^{q_r+2n}.\end{aligned}$$

By Lemma 2.1, we have

$$\text{dalt}(\widehat{\beta}) \leq n.$$

**Case 6.2:**  $\beta \in \Omega_6$  and  $n < 0$ .

We modify  $\beta$  into  $(\sigma_1^2\sigma_2^2)^{-|n|+1}\sigma_1^{-2}\sigma_2^{-1}\sigma_1^{-p_1-2|n|}\sigma_2^{q_1}\left(\prod_{i=2}^{r-1}\sigma_1^{-p_i}\sigma_2^{q_i}\right)\sigma_1^{-p_r}\sigma_2^{q_r-1}$  by the following equalities.

$$\begin{aligned}\beta &= (\sigma_1\sigma_2\sigma_1)^{-2|n|}\prod_{i=1}^r\sigma_1^{-p_i}\sigma_2^{q_i} \\ &= (\sigma_2\sigma_1^2\sigma_2)^{-|n|}\sigma_1^{-2|n|}\prod_{i=1}^r\sigma_1^{-p_i}\sigma_2^{q_i} \\ &= (\sigma_1^2\sigma_2^2)^{-|n|+1}\sigma_1^{-2}\sigma_2^{-1}\sigma_1^{-p_1-2|n|}\sigma_2^{q_1}\left(\prod_{i=2}^{r-1}\sigma_1^{-p_i}\sigma_2^{q_i}\right)\sigma_1^{-p_r}\sigma_2^{q_r-1}.\end{aligned}$$

By Lemma 2.1, we have

$$\text{dalt}(\widehat{\beta}) \leq n.$$

This completes the proof.  $\square$

### 3. THE ALTERNATION NUMBER AND THE DEALTERNATING NUMBER OF A CLOSED POSITIVE 3-BRAID

In this section, we determine the alternation numbers and the dealternating numbers of some closed positive 3-braid knots.

**Theorem 3.1.** *Let  $\beta$  be a positive 3-braid of the form*

$$\Delta^{2n}\prod_{i=1}^r\sigma_1^{p_i}\sigma_2^{q_i}$$

*such that  $\widehat{\beta}$  is a knot and  $p_i, q_i \geq 2$  for  $i = 1, 2, \dots, r$ , where  $n \geq 0, r \geq 1$ . Then we have*

$$\text{alt}(\widehat{\beta}) = \text{dalt}(\widehat{\beta}) = n + r - 1.$$

We recall two  $\mathbb{Z}$ -valued invariants. We denote the *signature* [25] of a link  $L$  by  $\sigma(L)$  (with the sign conventions such that the right-handed trefoil has signature two). In this paper, we define the signature of a link diagram as that of the link represented by the diagram. We denote the *Rasmussen  $s$ -invariant* of a knot by  $s(K)$  [29]. The first author gave a lower bound for the alternation number of a knot.

**Lemma 3.2** ([1]). *Let  $K$  be a knot. Then we have*

$$\frac{1}{2}|s(K) - \sigma(K)| \leq \text{alt}(K).$$

Rasmussen showed the following.

**Lemma 3.3** ([29]). *Let  $D$  be a positive diagram of a positive knot  $K$ . Then we have*

$$s(K) = c(D) - o(D) + 1,$$

*where  $c(D)$  is the crossing number of  $D$  and  $o(D)$  is the number of Seifert circles of  $D$ .*

Erle calculated the signatures of closed 3-braids.

**Lemma 3.4** ([10]). *Let  $\beta$  be a 3-braid in  $\Omega_6$ . With the notation of Lemma 2.3, we have*

$$\sigma(\widehat{\beta}) = 4n - \sum_{i=1}^r (p_i - q_i).$$

**Lemma 3.5.** *With the notation of Theorem 3.1, we have*

$$\sigma(\widehat{\beta}) = 4n - 2r + \sum_{i=1}^r (p_i + q_i).$$

*Proof.* We modify  $\beta$  into  $\Delta^{2n+2r} \prod_{i=1}^r \sigma_1^{-1} \sigma_2^{p_i-2} \sigma_1^{-1} \sigma_2^{q_i-2}$  by the following equalities.

$$\begin{aligned} \beta &= \Delta^{2n} \prod_{i=1}^r \sigma_1^{p_i} \sigma_2^{q_i} \\ &= \Delta^{2n} \prod_{i=1}^r \sigma_1 \sigma_1^{p_i-1} \sigma_2 \sigma_2^{q_i-1} \\ &= \Delta^{2n} \prod_{i=1}^r \sigma_1^{p_i-1} \sigma_2 \sigma_2^{q_i-1} \sigma_1 \\ &= \Delta^{2n} \prod_{i=1}^r \sigma_2^{-1} \sigma_1^{p_i-1} \sigma_2 \sigma_2^{q_i-1} \sigma_1 \sigma_2 \\ &= \Delta^{2n} \prod_{i=1}^r \sigma_1 \sigma_2^{p_i-1} \sigma_1^{-1} \sigma_2^{q_i-1} \sigma_1 \sigma_2 \\ &= \Delta^{2n} \prod_{i=1}^r \Delta \sigma_1^{-1} \sigma_2^{p_i-2} \sigma_1^{-1} \sigma_2^{q_i-2} \Delta \\ &= \Delta^{2n+2r} \prod_{i=1}^r \sigma_1^{-1} \sigma_2^{p_i-2} \sigma_1^{-1} \sigma_2^{q_i-2}. \end{aligned}$$

By Lemma 3.4, we have

$$\begin{aligned} \sigma(\widehat{\beta}) &= 4(n+r) + \sum_{i=1}^r (p_i + q_i - 6) \\ &= 4n - 2r + \sum_{i=1}^r (p_i + q_i). \end{aligned}$$

□

*Proof of Theorem 3.1.* First we show that  $\text{dalt}(\widehat{\beta}) \leq n+r-1$ . We modify  $\beta$  into  $\sigma_2(\sigma_1^2 \sigma_2^2)^{n-1} \sigma_1^2 \sigma_2 \sigma_1^{2n} \prod_{i=1}^r \sigma_1^{p_i} \sigma_2^{q_i}$  by the following equalities.

$$\begin{aligned} \beta &= \Delta^{2n} \prod_{i=1}^r \sigma_1^{p_i} \sigma_2^{q_i} \\ &= (\sigma_2 \sigma_1^2 \sigma_2)^n \sigma_1^{2n} \prod_{i=1}^r \sigma_1^{p_i} \sigma_2^{q_i} \\ &= \sigma_2 (\sigma_1^2 \sigma_2^2)^{n-1} \sigma_1^2 \sigma_2 \sigma_1^{2n} \prod_{i=1}^r \sigma_1^{p_i} \sigma_2^{q_i}. \end{aligned}$$

If  $r = 1$ , we modify  $\beta$  into  $(\sigma_1^2 \sigma_2^2)^{n-1} \sigma_1^2 \sigma_2 \sigma_1^{2n+p_1} \sigma_2^{q_1+1}$  by the following equalities.

$$\begin{aligned} \beta &= \sigma_2 (\sigma_1^2 \sigma_2^2)^{n-1} \sigma_1^2 \sigma_2 \sigma_1^{2n} \sigma_1^{p_1} \sigma_2^{q_1} \\ &= (\sigma_1^2 \sigma_2^2)^{n-1} \sigma_1^2 \sigma_2 \sigma_1^{2n+p_1} \sigma_2^{q_1+1}. \end{aligned}$$



If  $r \geq 2$ , we modify  $\beta$  into  $(\sigma_1^2 \sigma_2^2)^{n-1} \sigma_1^2 \sigma_2 \sigma_1^{2n+p_1} \sigma_2^{q_1} \{\prod_{i=2}^{r-1} \sigma_1^{p_i} \sigma_2^{q_i}\} \sigma_1^{p_r} \sigma_2^{q_r+1}$  by the following equalities.

$$\begin{aligned} \beta &= \sigma_2 (\sigma_1^2 \sigma_2^2)^{n-1} \sigma_1^2 \sigma_2 \sigma_1^{2n} \prod_{i=1}^r \sigma_1^{p_i} \sigma_2^{q_i} \\ &= (\sigma_1^2 \sigma_2^2)^{n-1} \sigma_1^2 \sigma_2 \sigma_1^{2n+p_1} \sigma_2^{q_1} \left\{ \prod_{i=2}^{r-1} \sigma_1^{p_i} \sigma_2^{q_i} \right\} \sigma_1^{p_r} \sigma_2^{q_r+1}. \end{aligned}$$

By Lemma 2.2, we have

$$\text{dalt}(\widehat{\beta}) \leq n + r - 1.$$

Next we show that  $\text{alt}(\widehat{\beta}) \geq n + r - 1$ . Lemmas 3.5 and 3.3 imply that

$$\begin{aligned} s(\widehat{\beta}) &= 6n - 2 + \sum_{i=1}^r (p_i + q_i), \\ \sigma(\widehat{\beta}) &= 4n - 2r + \sum_{i=1}^r (p_i + q_i). \end{aligned}$$

By Lemma 3.2, we have

$$\frac{1}{2} |s(K) - \sigma(K)| = n + r - 1 \leq \text{alt}(\widehat{\beta}).$$

Therefore, we have

$$\text{alt}(\widehat{\beta}) = \text{dalt}(\widehat{\beta}) = n + r - 1.$$

□

□

#### 4. ON $\overline{t_2}$ MOVES FOR A CLOSED POSITIVE 3-BRAID

In this section, we show that there exist infinitely many positive knots with any dealternating number (or any alternation number) and any braid index.

**Theorem 4.1.** *For any  $m \in \mathbb{Z}_{\geq 0}$  and  $n \geq 3$ , there exist infinitely many positive knots  $K$  with  $\text{alt}(K) = \text{dalt}(K) = m$  and  $b(K) = n$ .*

**Remark 4.2.** If  $L$  is a link with  $b(L) = 2$ , then we have  $\text{alt}(L) = \text{dalt}(L) = 0$  since  $L$  is a  $(2, k)$ -torus link for some integer  $k \neq 0, \pm 1$ .

A *band move* is a local move along the orientation on a link diagram as shown in Figure 4.

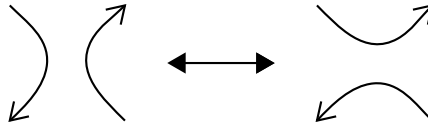

FIGURE 4. A band move

Murasugi showed the following.

**Lemma 4.3** ([24]). *Let  $D$  and  $D'$  be link diagrams which are related to each other by one band move. Then we have*

$$-1 \leq \sigma(D) - \sigma(D') \leq 1.$$

**Remark 4.4** (cf. [17]). Let  $D_+$  and  $D_-$  be link diagrams such that  $D_-$  is obtained from  $D_+$  by a crossing change at a crossing  $c$  from positive to negative. Let  $D/c$  be the diagram obtained from  $D_+$  (or  $D_-$ ) by smoothing  $c$ . The following inequalities hold.

$$\begin{aligned} 0 &\leq \sigma(D_+) - \sigma(D_-) \leq 2, \\ -1 &\leq \sigma(D_{\pm}) - \sigma(D/c) \leq 1. \end{aligned}$$

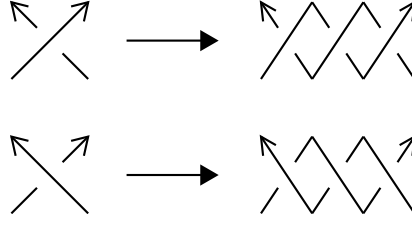
FIGURE 5. A  $\overline{t}_2$  move

A  $\overline{t}_2$  move is a local move along the orientation on a link diagram as shown in Figure 5.

**Lemma 4.5.** *Let  $D$  be a link diagram, and let  $c$  be a crossing of  $D$ . Let  $D^{c(k)}$  be the diagram obtained from  $D$  by applying a  $\overline{t}_2$  move  $k$  times at  $c$ . Then we have*

$$\sigma(D^{c(k)}) - \sigma(D) \in \{0, \text{sign}(c), 2\text{sign}(c)\},$$

where  $\text{sign} \begin{pmatrix} \nearrow & \nearrow \\ \searrow & \searrow \end{pmatrix} = 1$  and  $\text{sign} \begin{pmatrix} \nearrow & \searrow \\ \searrow & \nearrow \end{pmatrix} = -1$ .

*Proof.* We may assume that the crossing  $c$  is positive, since we can prove in a similar way as in the case  $c$  is negative. Let  $D/c$  be the diagram obtained from  $D$  by smoothing  $c$ . By smoothing one crossing of  $D^{c(k)}$ , we can obtain a diagram which is equivalent to  $D/c$ . Then we obtain the inequalities.

$$-1 \leq \sigma(D^{c(k)}) - \sigma(D/c) \leq 1.$$

Since  $D$  is obtained from  $D^{c(k)}$  by  $k$  crossing changes from positive to negative,

$$\sigma(D^{c(k)}) - \sigma(D) \geq 0.$$

Then we obtain

$$0 \leq \sigma(D^{c(k)}) - \sigma(D) \leq 2.$$

□

**Lemma 4.6.** *Let  $D$  be a link diagram, and let  $c$  be a crossing of  $D$ . Let  $D/c$  be the link diagram obtained from  $D$  by smoothing  $c$ ,  $D^{c(k)}$  the link diagram obtained from  $D$  by applying a  $\overline{t}_2$  move  $k$  times at  $c$ . If  $\sigma(D) - \sigma(D/c) = \text{sign}(c)$ , then we have*

$$\sigma(D) = \sigma(D^{c(k)}).$$

*Proof.* We may assume that the crossing  $c$  is a positive crossing, since we can prove in a similar way as in the case  $c$  is negative. Since we have

$$-1 \leq \sigma(D^{c(k)}) - \sigma(D/c) \leq 1,$$

we have the following inequalities.

$$-2 \leq \sigma(D^{c(k)}) - \sigma(D) \leq 0.$$

By Proposition 4.5, we have

$$\sigma(D) = \sigma(D^{c(k)}).$$

□

Yamada showed the following.

**Lemma 4.7** ([33]). *Let  $L$  be a link and  $D$  a diagram of  $L$ . Then we have*

$$b(L) \leq o(D).$$

The *HOMFLY polynomial*  $P_L(v, z)$  of a link  $L$  [12], [28] is a 2-variable link polynomial defined by the skein relationship

$$v^{-1}P\left(\begin{array}{c} \nearrow \\ \searrow \end{array}; v, z\right) - vP\left(\begin{array}{c} \nwarrow \\ \swarrow \end{array}; v, z\right) = zP\left(\begin{array}{c} \bigcirc \end{array}; v, z\right).$$

We denote by  $\maxdeg_v P_L$  (resp.  $\mindeg_v P_L$ ) the maximal (resp. minimal) degree of  $P_L(v, z)$  in the variable  $v$ . Franks and Williams, and Morton independently showed the following.

**Lemma 4.8** ([11], [22]). *Let  $L$  be a link. Then we have*

$$\frac{1}{2}(\maxdeg_v P_L - \mindeg_v P_L) + 1 \leq b(L).$$

For a positive link, Yokota showed the following.

**Lemma 4.9** ([34]). *Let  $D$  be a positive diagram of a positive link  $L$ . Then we have*

$$\mindeg_v P_L = c(D) - o(D) + 1.$$

Nakamura showed the following.

**Lemma 4.10** ([27]). *Let  $L$  be a closed positive 3-braid. Then we have*

$$\frac{1}{2}(\maxdeg_v P_L - \mindeg_v P_L) + 1 = b(L),$$

**Lemma 4.11.** *Let  $\beta$  be a positive 3-braid of the form*

$$\prod_{i=1}^r \sigma_1^{p_i} \sigma_2^{q_i},$$

such that  $\widehat{\beta}$  is a knot and  $p_i, q_i \geq 3$  for  $i = 1, 2, \dots, r$ . Let  $D$  be the closed braid diagram of  $\widehat{\beta}$ , and let  $c$  be a crossing of  $D$ . Let  $D^{c(k)}$  be the diagram obtained from  $D$  by applying a  $\overline{t}_2'$  move  $k$  times at  $c$ , and  $K'$  the knot represented by  $D^{c(k)}$ . Then we have

$$\begin{aligned} (1) \quad \text{alt}(K') &= \text{dalt}(K') = r - 1, \\ (2) \quad b(K') &= k + 3. \end{aligned}$$

*Proof.* (1) We show that  $\sigma(D) = \sigma(D^{c(k)})$ . We obtain the 2-component link diagram  $D/c$  by smoothing  $c$ . Then  $D/c$  is a closed positive 3-braid diagram of the form

$$\prod_{i=1}^r \sigma_1^{p'_i} \sigma_2^{q'_i},$$

such that  $p'_i, q'_i \geq 2$  for  $i = 1, 2, \dots, r$ . By Lemma 3.5, we have

$$\sigma(D) - \sigma(D/c) = 1.$$

By using Proposition 4.6, we have  $\sigma(D) = \sigma(D^{c(k)})$ . On the other hands, by Lemma 3.3,  $\overline{t}_2'$  moves preserve the Rasmussen  $s$ -invariant for a positive knot diagram. By Lemma 3.2, we have  $\text{alt}(K') \geq r - 1$ . We can deform  $D^{c(k)}$  into an  $(r - 1)$ -almost alternating diagram as in Figure 2. Then we have

$$\text{alt}(K') = \text{dalt}(K') = r - 1.$$

(2) First we show that  $b(K') \leq k + 3$ . We note that  $o(D) = 3$  and  $o(D^{c(k)}) = 2k + 3$ . We can deform  $D^{c(k)}$  into a knot diagram  $D'$  with  $o(D') = k + 3$  by the Reidemeister moves as in Figure 6. By Lemma 4.7, we have  $b(K') \leq o(D') = k + 3$ .

Next we show that  $b(K') \geq k + 3$ . Let  $D/c$  be the diagram obtained from  $D$  by smoothing  $c$ . By using the skein relationship  $k$  times, we have the following equation.

$$P_{D^{c(k)}}(v, z) = v^{2k} P_D(v, z) + vz \left( \sum_{i=1}^k v^{2(i-1)} \right) P_{D/c}(v, z).$$

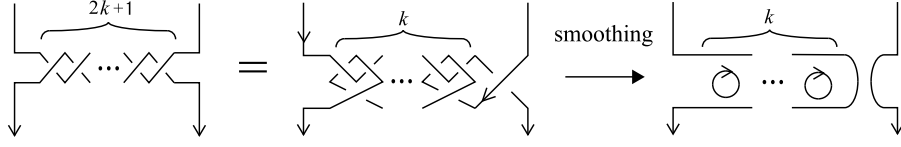

FIGURE 6.

By Lemma 4.9, we have

$$\mindeg_v P_D = \mindeg_v P_{D/c} + 1 = p + q - 2.$$

By Lemma 4.10, we have

$$\maxdeg_v P_D = \maxdeg_v P_{D/c} + 1 = p + q + 2,$$

since the braid indices of  $D$  and of  $D/c$  are equal to three. By Lemma 4.8, we have

$$\begin{aligned} b(K') &\geq \frac{1}{2} \left( \maxdeg_v P_{D^{c(k)}} - \mindeg_v P_{D^{c(k)}} \right) + 1 \\ &= \frac{1}{2} \left( (p + q + 2k + 2) - (p + q - 2) \right) + 1 = k + 3. \end{aligned}$$

This completes the proof.  $\square$

*Proof of Theorem 4.1.* We give an example of a family of infinitely many positive knots. Let  $l \in \mathbb{Z}_{\geq 0}$ ,  $m \in \mathbb{Z}_{\geq 0}$  and  $n \geq 3$ . Let  $D_i$  ( $i = 1, 2, \dots, l$ ) be the closed braid diagram of a positive braid of the form

$$\sigma_1^{2i+1} \sigma_2^3 (\sigma_1^4 \sigma_2^4)^m.$$

Let  $c$  be a crossing of  $D_i$  and  $D_i^{c(n)}$  the diagram obtained from  $D_i$  by applying a  $\overline{t}_2$  move  $n$  times at  $c$ . By Lemma 4.11,  $\text{alt}(K_i^n) = \text{dalt}(K_i^n) = m$  and  $b(K_i^n) = n + 3$ , where  $K_i^n$  is a knot which has the diagram  $D_i^{c(n)}$ . On the other hands, by Lemma 3.3, we have  $s(K_i^n) = 8m + 2i + 2$ . Then we have  $s(K_i^n) \neq s(K_j^n)$  for  $i \neq j$ . This completes the proof.  $\square$

## 5. ON THE TURAEV GENUS OF A NON-SPLIT LINK

In this section, we recall the definition of the Turaev surface and some properties.

An *A-splice* and a *B-splice* are local moves on a link diagram as in Figure 7. We denote by  $s_A D$  (resp.  $s_B D$ ) the diagram obtained from  $D$  by applying A-splices (resp. B-splices) at all crossings of  $D$ . We denote by  $|s_A D|$  (resp.  $|s_B D|$ ) the number of the circles of  $s_A D$  (resp.  $s_B D$ ).

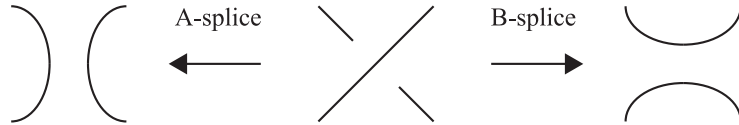

FIGURE 7. An A-splice and a B-splice

We construct the Turaev surface associated to a connected link diagram. Let  $\Gamma \subset S^2$  be the underlying 4-valent graph of a connected link diagram  $D$ , and  $V$  the union of the vertices of  $\Gamma$ . Let  $\Gamma \times [-1, 1]$  be a surface with singularities  $V \times [-1, 1]$  naturally embedded in  $S^2 \times [-1, 1]$ . Replace the neighborhoods of  $V \times [-1, 1]$  with saddle surfaces positioned in such a way that the boundary curves in  $S^2 \times \{1\}$  (resp.  $S^2 \times \{-1\}$ ) correspond to  $s_A D$  (resp.  $s_B D$ ) as in Figure 8 (see also Figure 9).

The Turaev surface is completed by attaching disjoint discs to the  $|s_A D| + |s_B D|$  boundary circles in  $S^3$ . We denote by  $g_T(D)$  the genus of the Turaev surface associated to  $D$ . The *Turaev genus*  $g_T(L)$  of a non-split link  $L$  is the minimal number of the genera  $g_T(D)$  of the Turaev surfaces associated to diagrams  $D$  of  $L$ . Turaev showed the following two lemmas.

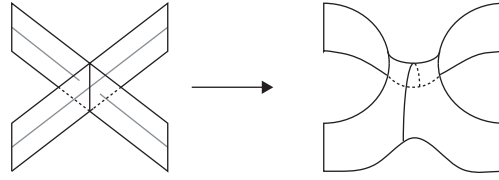

FIGURE 8. A saddle surface

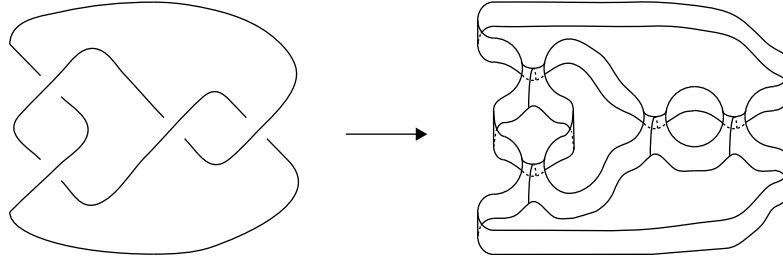

FIGURE 9. On the construction of the Turaev surface

**Lemma 5.1** ([8], [31]). *Let  $D$  be a connected link diagram. Then we have*

$$g_T(D) = \frac{1}{2}(c(D) + 2 - |s_A D| - |s_B D|).$$

**Lemma 5.2** ([31]). *Let  $D$  be a connected alternating link diagram. Then we have  $g_T(D) = 0$ .*

Lowrance showed the following.

**Lemma 5.3** ([20]). *Let  $D$  and  $D'$  be connected link diagrams which are related to each other by a crossing change. Then we have*

$$|g_T(D) - g_T(D')| \leq 1.$$

**Corollary 5.4.** *Let  $L$  be a non-split link. Then we have*

$$g_T(L) \leq \text{dalt}(L).$$

*Proof.* Set  $\text{dalt}(L) = n$ . By definition, there exists a knot diagram  $D$  of  $L$  such that  $n$  crossing changes in  $D$  turn the diagram into an alternating knot diagram  $D'$ . By Lemma 5.3, we have

$$|g_T(D) - g_T(D')| \leq n.$$

By Lemma 5.2, we obtain  $g_T(D) \leq n$ . □

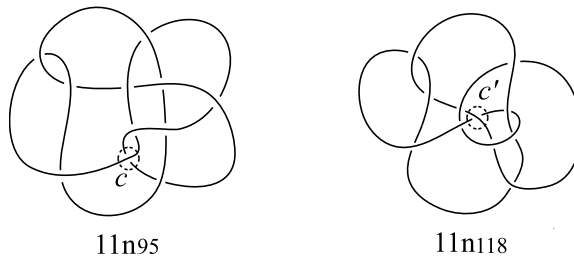

FIGURE 10.

Since all non-alternating knots of eleven or fewer crossings except  $11_{n95}$  and  $11_{n118}$  are almost alternating, by Corollary 5.4, we have the following.

**Corollary 5.5.** *Let  $K$  be a non-alternating knots of eleven or fewer crossings except  $11_{n95}$  and  $11_{n118}$ . Then we have  $g_T(K) = 1$ .*

**Remark 5.6.** By applying crossing changes at  $c$  and  $c'$  in Figure 10 (see [5]), we obtain diagrams of alternating knots. Thus we have  $\text{alt}(11_{n95}) = \text{alt}(11_{n118}) = 1$ . It implies that non-alternating knots of eleven or fewer crossings have alternation number one.

Khovanov [18] introduced an invariant of links, called the Khovanov homology, which values bigraded  $\mathbb{Z}$ -modules and whose graded Euler characteristic is the Jones polynomial. We denote by  $\omega_{Kh}(L)$  the *homological width* (or *thickness*) of the Khovanov homology of a link  $L$ . Manturov [21] and Champanerker, Kofman and Stoltzfus [6] gave the following (see also [3]).

**Lemma 5.7** ([6], [21]). *Let  $K$  be a knot. Then we have*

$$\omega_{Kh}(K) - 2 \leq g_T(K).$$

Stošić [30] and Turner [32] independently calculated the rational Khovanov homology of the  $(3, 3n + i)$ -torus link, where  $i = 0, 1, 2$ .

**Lemma 5.8** ([30], [32]). *Let  $T_{3,3n+i}$  be the  $(3, 3n + i)$ -torus link, where  $i = 0, 1, 2$ . Then we have*

$$\omega_{Kh}(T_{3,3n+i}) = n + 2.$$

By Theorems 2.5 and 5.7, we obtain the following.

**Theorem 5.9.** *Let  $T_{3,3n+i}$  be the  $(3, 3n + i)$ -torus knot, where  $i = 1, 2$ . Then we have*

$$g_T(T_{3,3n+i}) = \text{dalt}(T_{3,3n+i}) = n.$$

*Proof.* By Theorem 2.5, we have  $\text{dalt}(T_{3,3n+i}) \leq n$ . On the other hand, by Theorems 5.7 and 5.8, we have  $n \leq g_T(T_{3,3n+i})$ .  $\square$

## 6. APPENDIX (AUTHORED WITH IN DAE JONG)

Appendix is authored by the first and the second authors and In Dae Jong. In this section, we observe that non-alternating Montesinos links and semi-alternating links are almost alternating. Throughout this section, we assume that tangles and tangle diagrams have four ends. We recall some notations for tangle diagrams.

Two tangle diagrams  $T$  and  $T'$  are *equivalent*, denoted by  $T \sim T'$ , if they are related by a finite sequence of the Reidemeister moves. The *integral tangle diagram*  $[n]$  ( $n \in \mathbb{Z}$ ) is  $n$  horizontal half twists (see Figure 11).

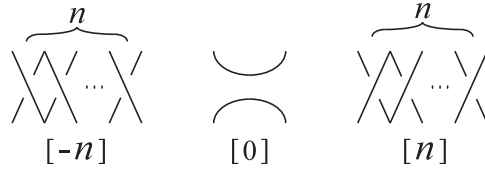

FIGURE 11. The integral tangle diagrams

The *sum* (resp. *product*) of two tangle diagrams  $T$  and  $S$  is the tangle diagram as in Figure 12. We denote the sum (resp. product) of two tangle diagrams  $T$  and  $S$  by  $T + S$  (resp.  $T * S$ ).

A *rational tangle diagram* is a tangle diagram obtained from integral tangle diagrams using only the operation of product.

**Remark 6.1.** Let  $a_1, a_2, a_3, \dots, a_n$  be integers. A rational tangle diagram  $(\dots((([a_1] * [a_2]) * [a_3]) * \dots) * [a_n])$  is alternating if and only if  $a_1, a_2, a_3, \dots, a_n$  have same sign. For any rational tangle diagram  $T$ , there exists an alternating rational tangle diagram  $T'$  such that  $T \sim T'$ ,

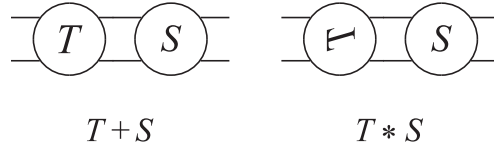

FIGURE 12. The sum and the product of tangle diagrams  $T$  and  $S$

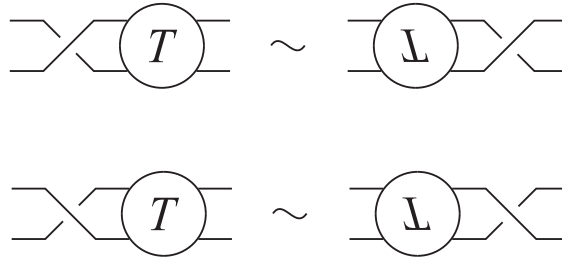

FIGURE 13. A flype

A *flype* is a local move on a tangle diagram (or a link diagram) as in Figure 13.

**Remark 6.2.** Let  $T$  be a rational tangle diagram and  $s$  an integer. By flypes, we have  $T + [s] \sim [s] + T$  (see [15]).

We depict a symbol  $o$  (resp.  $u$ ) near each end point of a tangle diagram as in Figure 14 if an over-crossing (resp. under-crossing) appears first when we traverse the component from the end point. We call a tangle diagram on the left side (resp. right side) in Figure 14 of *type 1* (resp. of *type 2*). We note that an alternating tangle diagram is of type 1 or of type 2.<sup>1</sup> For example, the integral tangle  $[1]$  is of type 1, and  $[-1]$  is of type 2. We show two lemmas needed later.

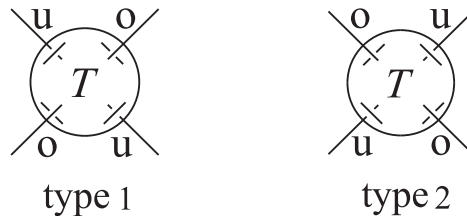

FIGURE 14. Tangles of type 1 and of type 2

**Lemma 6.3.** Let  $T$  be an alternating tangle diagram, and  $R$  an alternating rational tangle diagram. Then there exist an alternating tangle  $T'$  and an integer  $r$  such that  $T + R \sim T' + [r]$ .

*Proof.* If  $T$  and  $R$  are both of type 1 or of type 2, then we set  $T' = T + R$  and  $r = 0$ . We assume that the tangle diagram  $T$  is of type 1, and the rational tangle diagram  $R$  is of type 2. In this case,  $R$  is represented by  $(\cdots ([-a_1] * [-a_2]) * \cdots) * [-a_n]$ , where  $a_1, a_2, \dots, a_n$  are positive integers. If  $R$  is an integral tangle diagram  $[r]$ , then we set  $T' = T$  and  $[r] = R$ . If  $R$  is not an integral tangle diagram, we obtain the sum of an alternating tangle diagram of type 1 and the integral tangle diagram  $[-(a_n + 1)]$  by deforming  $T + R$  as in Figure 15. If  $T$  is of type 2 and  $R$  is of type 1, then the proof is reduced to the case treated above by taking the mirror image of  $T + R$ .  $\square$

<sup>1</sup>Use a checkerboard coloring for the diagram.

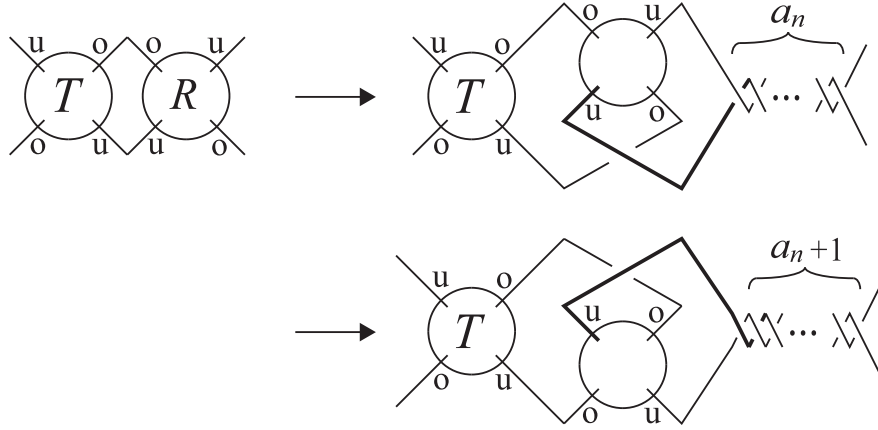

FIGURE 15.

**Lemma 6.4.** *Let  $R_i$  ( $i = 1, \dots, m$ ) be alternating rational tangle diagrams. Then there exist an alternating tangle diagram  $T$  and an integer  $s$  such that  $R_1 + \dots + R_m \sim T + [s]$ .*

*Proof.* We prove this lemma by induction on  $m$ . It is trivial for the case  $m = 1$ . The lemma is also true by Lemma 6.3 for the case  $m = 2$ .

Suppose that the lemma is true for the case  $m = n$  such that  $n \geq 2$ . We show that the lemma is true for the case  $m = n + 1$ . By the assumption, there exist an alternating tangle diagram  $T$  and  $s \in \mathbb{Z}$  such that  $R_1 + \dots + R_n \sim T + [s]$ . By Remark 6.2, we have

$$R_1 + \dots + R_{n+1} \sim T + R_{n+1} + [s].$$

By Lemma 6.3, there exist an alternating tangle diagram  $T'$  and  $r \in \mathbb{Z}$  such that  $T + R_{n+1} \sim T' + [r]$ . We obtain the sum of an alternating tangle diagram  $T'$  and an integral tangle diagram  $[r + s]$ .  $\square$

The *numerator*  $N(T)$  and the *denominator*  $D(T)$  of a tangle diagram  $T$  are closures of  $T$  as in Figure 16. A *Montesinos link* is a link which has a diagram represented by  $N(R_1 + \dots + R_m)$ , where  $R_1, \dots, R_m$  are rational tangle diagrams (see Figure 17).

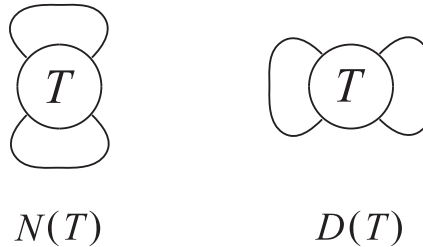
FIGURE 16. The numerator and the denominator of a tangle diagram  $T$ 

**Proposition 6.5.** *Montesinos links are alternating or almost alternating.*

*Proof.* By Remark 6.1, every Montesinos link has a diagram  $D$  represented by  $N(R_1 + \dots + R_m)$ , where  $R_1, \dots, R_m$  are alternating rational tangle diagrams. Then, by Lemma 6.4, the diagram  $D$  can be deformed into a diagram represented by the numerator  $N(T + [s])$  of the sum of an alternating tangle diagram  $T$  and an integral tangle diagram  $[s]$ .

If  $T$  and  $[s]$  are both of type 1 or of type 2, then  $N(T + [s])$  is alternating. If  $T$  is of type 1 and  $[s]$  is of type 2, then we deform  $N(T + [s])$  into an almost alternating diagram as in Figure 18. If  $T$  is of type 2



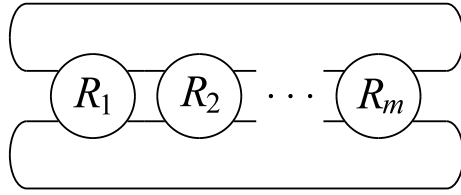

FIGURE 17. A diagram of a Montesinos link

and  $[s]$  is of type 1, then the proof is reduced to the case treated above by taking the mirror image of the diagram.

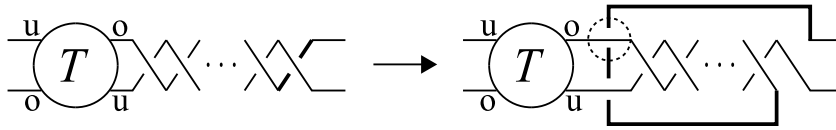

FIGURE 18.

□

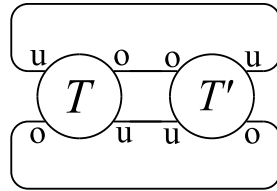

FIGURE 19. A diagram of a semi-alternating link

A tangle diagram  $T$  is *strongly alternating* if both  $N(T)$  and  $D(T)$  are reduced alternating. A link  $L$  is *semi-alternating* if  $L$  has a non-alternating diagram which is represented by  $N(T + T')$ , where  $T$  and  $T'$  are strongly alternating tangle diagrams (see Figure 19).

**Proposition 6.6.** *Semi-alternating links are almost alternating.*

*Proof.* Lickorish and Thistlethwaite [19] showed that semi-alternating links are non-alternating. On the other hand, we can obtain an almost alternating diagram of a semi-alternating link as in Figure 20. □

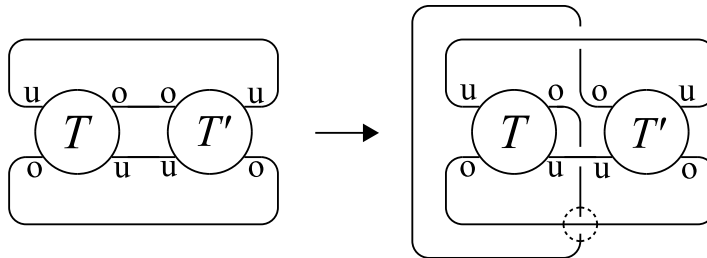

FIGURE 20.

For a non-split link  $L$ , Champanerkar and Kofman [7] showed

$$\omega_{Kh}(L) - 2 \leq \text{dalt}(L).$$

Propositions 6.5 and 6.6 imply the following.

**Corollary 6.7.** *Let  $L$  be a Montesinos link or a semi-alternating link. Then*

$$\omega_{Kh}(L) \leq 3.$$

#### ACKNOWLEDGMENTS

The authors would like to express their sincere gratitudes to Akio Kawauchi and Taizo Kanenobu for helpful advices and comments. They also would like to thank the members of Friday Seminar on Knot Theory in Osaka City University for uncounted discussions, especially Atsushi Ishii and Masahide Iwakiri.

#### REFERENCES

- [1] T. Abe, *An estimation of the alternation number of a torus knot*, to appear in *J. Knot Theory and Its Ramifications*.
- [2] C. Adams, J. Brock, J. Bugbee, T. Comar, K. Faigin, A. Huston, A. Joseph, and D. Pesikoff, *Almost alternating links*, *Topology Appl.* **46** (1992), no. 2, 151–165.
- [3] M. M. Asaeda and J. H. Przytycki, *Khovanov homology: torsion and thickness*, *Advances in topological quantum field theory*, NATO Sci. Ser. II Math. Phys. Chem., **179**, Kluwer Acad. Publ., Dordrecht, (2004), 135–166.
- [4] J. S. Birman and W. W. Menasco, *Studying links via closed braids III. Classifying links which are closed 3-braids*, *Pacific J. Math.* **161** (1993), no. 1, 25–113.
- [5] J. C. Cha and C. Livingston, *KnotInfo: Table of Knot Invariants*, <http://www.indiana.edu/~knotinfo>, (June 17, 2008).
- [6] A. Champanerkar, I. Kofman and N. Stoltzfus, *Graphs on surfaces and Khovanov homology*, *Algebr. Geom. Topol.* **7** (2007), 1531–1540.
- [7] A. Champanerkar, I. Kofman, *Spanning trees and Khovanov homology*, arXiv: math.GT/0607510, (2006).
- [8] P. R. Cromwell, *Knots and Links*, Cambridge University Press, (2004).
- [9] O. T. Dasbach, D. Futer, E. Kalfagianni, X. S. Lin, and N. Stoltzfus, *The Jones polynomial and graphs on surfaces*, *J. Combin. Theory Ser. B* **98** (2008), no. 2, 384–399.
- [10] D. Erle, *Calculation of the signature of a 3-braid link*, *Kobe J. Math.* **16** (1999), no. 2, 161–175.
- [11] J. Franks and R. F. Williams, *Braids and the Jones polynomial*, *Trans. Amer. Math. Soc.* **303** (1987), 97–108.
- [12] P. Freyd, J. Hoste, W. B. R. Lickorish, K. C. Millett, A. Ocneanu, and D. Yetter, *A new polynomial invariant of knots and links*, *Bull. Amer. Math. Soc.* **12** (1985), 239–246.
- [13] H. Goda, M. Hirasawa, and R. Yamamoto, *Almost alternating diagrams and fibered links in  $S^3$* , *Proc. London Math. Soc.* (3) **83** (2001), no. 02, 472–492.
- [14] T. Kanenobu, *Upper bound for the alternation number of a torus knot*, submitted.
- [15] L. H. Kauffman and S. Lambropoulou, *On the classification of rational tangles*, *Adv. in Appl. Math.* **33** (2004), no. 2, 199–237.
- [16] A. Kawauchi, *On alternation numbers of links*, submitted.
- [17] A. Kawauchi, *A survey of knot theory*, Birkhäuser Verlag, Basel, Switzerland (1996).
- [18] M. Khovanov, *A categorification of the Jones polynomial*, *Duke Math. J.* **101** (2000), no. 3, 359–426.
- [19] W. B. R. Lickorish and M. B. Thistlethwaite, *Some links with non-trivial polynomials and their crossing-numbers*, *Comment. Math. Helv.* **63** (1988), no. 1, 527–539.
- [20] A. Lowrance, *On knot Floer width and Turaev genus*, arXiv: math.GT/07090720, (2007).
- [21] V. O. Manturov, *Additional gradings in Khovanov homology*, arXiv: math.GT/07103741, (2007).
- [22] H. R. Morton, *Seifert circles and knot polynomials*, *Math. Proc. Cambridge Philos. Soc.* **99** (1986), 107–109.
- [23] H. Murakami, *Some metrics on classical knots*, *Math. Ann.* **270** (1985), 35–45.
- [24] K. Murasugi, *On a certain numerical invariant of link types*, *Trans. Amer. Math. Soc.* **117** (1965), 387–422.
- [25] K. Murasugi, *On the signature of links*, *Topology* **9** (1970), 283–298.
- [26] K. Murasugi, *On closed 3-braids*, American Mathematical Society, (1974).
- [27] T. Nakamura, *Notes on the braid index of closed positive braids*, *Topology Appl.* **135** (2004), no. 1, 13–31.
- [28] J. H. Przytycki and P. Traczyk., *Invariants of links of Conway type*, *Kobe J. Math.* **4** (1988), 115–139.
- [29] J. A. Rasmussen, *Khovanov homology and the slice genus*, to appear in *Invent. Math.*
- [30] M. Stošić, *Homology of torus links*, arXiv: math.QA/0606656, (2006).
- [31] V. Turaev, *A simple proof of the Murasugi and Kauffman theorems on alternating links*, *Enseign. Math.(2)* **33** (1987), no. 3–4, 203–225.

- [32] P. Turner, *A spectral sequence for Khovanov homology with an application to  $(3, q)$ -torus links*, arXiv: math.GT/0606369, (2006).
- [33] S. Yamada, *The minimal number of Seifert circles equals the braid index of a link*, Invent. Math. **89** (1987), no. 2, 347–356.
- [34] Y. Yokota, *Polynomial invariants of positive links*, Topology **31** (1992), no. 4, 805–811.

DEPARTMENT OF MATHEMATICS, OSAKA CITY UNIVERSITY, SUGIMOTO, SUMIYOSHI-KU OSAKA 558-8585, JAPAN  
*E-mail address:* `t-abe@sci.osaka-cu.ac.jp`

DEPARTMENT OF MATHEMATICS, OSAKA CITY UNIVERSITY, SUGIMOTO, SUMIYOSHI-KU OSAKA 558-8585, JAPAN  
*E-mail address:* `k-kishi@sci.osaka-cu.ac.jp`

DEPARTMENT OF MATHEMATICS, OSAKA CITY UNIVERSITY, SUGIMOTO, SUMIYOSHI-KU OSAKA 558-8585, JAPAN  
*E-mail address:* `jong@sci.osaka-cu.ac.jp`  
*URL:* <http://www.ex.media.osaka-cu.ac.jp/~d07sa009/>