

Distributing labels on infinite trees

Nicolas Gast Bruno Gaujal

November 20, 2018

Abstract

Sturmian words are infinite binary words with many equivalent definitions: They have a minimal factor complexity among all aperiodic sequences; they are balanced sequences (the labels 0 and 1 are as evenly distributed as possible) and they can be constructed using a mechanical definition. All these properties make them good candidates for being extremal points in scheduling problems over two processors. In this paper, we consider the problem of generalizing Sturmian words to trees. The problem is to evenly distribute labels 0 and 1 over infinite trees. We show that (strongly) balanced trees exist and can also be constructed using a mechanical process as long as the tree is irrational. Such trees also have a minimal factor complexity. Therefore they bring the hope that extremal scheduling properties of Sturmian words can be extended to such trees, at least partially. Such possible extensions are illustrated by one such example.

Keywords Infinite trees, Sturmian words, Sturmian trees

1 Introduction

In scheduling problems with an infinite number of tasks, the optimal strategy may no longer be to execute tasks “as soon as possible” but rather “as regularly as possible”. Keeping this in mind, let us consider the following question: how to distribute ones and zeros over an infinite sequence $w = (w_n)_{n \in \mathbb{N}}$ such that the ones (and the zeros) are spread as evenly as possible. In a more formal way, the sequence w is *balanced* if the number of ones in a factor $w_i, w_{i+1}, \dots, w_{i+\ell}$ of length ℓ , does not vary by more than 1, for all i and all ℓ . Such sequences exist and are called *Sturmian words* when they are not periodic.

Sturmian words are quite fascinating binary sequences: they have many different characterizations formulated in terms coming from as many mathematical frameworks, in which they always prove very useful. For example, Sturmian words have a geometric description as digitalized straight lines and as such have been used in computer visualization (see [13] for a review). They can also be defined using an arithmetic characterization using a repetitive rotation on a torus or continued fraction decompositions. From a combinatorial point of view, yet another characterization of Sturmian words is based on the balance between ones and zeros in all factors, as mentioned before. They are also used in symbolic dynamic system theory because they are aperiodic words with minimal factor complexity or because they have palindromic properties. Most of these equivalences have been known since the seminal work in [16].

More recently, Sturmian sequences have also been used for optimization purposes: they are extreme points of multimodular functions [12, 2]. This has applications in scheduling theory. In

[11] rather general scheduling problems with two processors are considered. A simple case is the following two processor mapping problem. An infinite number of tasks of unit size are to be executed over two processors (labeled 0 and 1) with related speeds, v_0 and v_1 such that $1/v_0 + 1/v_1 > 1$. The tasks are released every time unit. It is shown that an optimal schedule (minimizing the average flow time) allocates task i to processor w_i according to a sequence w_1, w_2, w_2, \dots that is Sturmian.

Another example solved in [10] is the following processor allocation problem: A single processor (with unit speed) is used to execute two types of tasks. Tasks of type 1 (resp. 2) are released every time unit and are all of size S_0 (resp. S_1). The allocation of the processor to the tasks can be seen as a binary sequence w_1, w_2, \dots saying which task is to be served next. Here also there exists an optimal Sturmian sequence (minimizing the average flow time of all tasks).

Actually more general scheduling problems are solved by Sturmian sequences. For instance if the tasks are released according to a stationary process and the task sizes are also stochastic, independent of the release process, then both problems mentioned above are also solved by Sturmian sequences.

A natural extension is to consider the case where more than two processors can be used to execute the tasks. This leads to the construction of generalized Sturmian words in several directions.

The first one is to study words using more than two letters. Billiard sequences in hypercubes extend the torus definition of Sturmian sequences while episturmian sequences [3] extend the palindromic characterization of Sturmian words. Unfortunately, both extensions differ substantially and none of them provides an optimal schedule for the k processor mapping problem.

Another extension is to two dimensions. A complete characterization of two-dimensional non-periodic sequences with minimal complexity is given in [6]. Here again the alternative characterizations are lost.

Yet another generalization is to trees [4], where Sturmian trees are defined as infinite binary automata such that the number of factors (sub-trees) of size n is $n + 1$. The other characterizations of Sturmian words are lost once more.

Finally, another extension of Sturmian concerns discrete planes. Here, several characterizations of Sturmian lines can be extended to discrete planes. Interesting relations between multidimensional continued fraction decomposition of the normal direction of the plane and the patterns of its discretization mimic what happens for Sturmian sequences, [8].

The aim of this paper is to do the same for trees. We introduced in [9] a new type of infinite trees: unordered trees, for which the left and right children of each node are not distinguishable and gave a brief presentation of its main properties. Here, we make an exhaustive study of such trees. We show that the balance property (distributing evenly the labels equal to one or zero over the vertex of the tree) coincides with a characterization of trees using integer parts of affine functions (called mechanicality). Furthermore these balanced trees have a minimal factor complexity. Therefore, they can be seen as a natural extension of Sturmian sequence in more than one aspect. This brings some hope to use them as extreme points for adapted optimization problems.

Our purpose in the paper is two-fold. The first part of the paper is dedicated to the study of general unordered infinite trees with binary labels. We provide definitions of the main concepts as well as the basic properties of unordered trees with a special focus on the notion of density (the average number of ones) and rationality. The second part of the paper investigates balanced unordered trees and their properties. In particular we show that strongly balanced trees (defined later) are mechanical (so that they have a density and all labels can be constructed in almost constant time). Furthermore their factor complexity is minimal among all non-periodic trees.

We also investigate rational balanced trees by showing that their density is easy to compute and

by providing an algorithm with polynomial complexity to test whether a rational tree is strongly balanced. Finally, we show that balanced trees are extremal points of some convex functions, bringing some hope that they can be used to solve optimization problems.

2 Infinite Trees

For *ordered infinite trees*, we follow the presentation given in [4]. Ordered infinite trees are automata with an infinite number of states. An automata is a tree-automaton if it has one initial state and each state has a uniform in-degree equal to one (except for the initial state, whose in-degree is 0) and a uniform out-degree d with labels a_1, \dots, a_d on the arcs. Every node v is labeled by $\ell(v) = 1$ (resp. 0) if it is final (resp. non-final).

The language accepted by the tree-automaton \mathcal{T} is a subset of \mathcal{A}^* (where the alphabet $\mathcal{A} = \{a_1, \dots, a_d\}$) and is denoted by $\mathcal{L}(\mathcal{T})$. Thus, a word w in the free monoid \mathcal{A}^* corresponds to a node in \mathcal{T} , and a word w in $\mathcal{L}(\mathcal{T})$ corresponds to a node in \mathcal{T} with label 1. Conversely, a unique tree-automaton can be associated to any subset L of \mathcal{A}^* , by labeling by one the nodes corresponding to the words in L .

Classically for automata, a family of equivalence relations can be defined over the nodes of tree \mathcal{T} : $v \sim_0 u$ if $\ell(v) = \ell(u)$, $v \sim_{n+1} u$ if $v \sim_n u$ and for all i , the i th child of u , ua_i and the i th child of v , va_i satisfy $ua_i \sim_n va_i$. By definition of \sim_n , $u \sim_n v$ if and only if the subtree rooted in u of height n is the same as the subtree rooted in v of height n .

$\mathcal{L}(\mathcal{T})$ is recognized by its minimal deterministic automaton (possibly infinite), say $A(\mathcal{T})$. Actually, $A(\mathcal{T})$ can be obtained from the tree \mathcal{T} by merging all the states in the tree in the same equivalence classes of \sim_n for all n .

An example is given in Figure 1 where the infinite tree-automaton and the minimal automaton recognizing all the prefixes of the Fibonacci word (over the alphabet $\{a, b\}$) is given together with the corresponding minimal automaton (which has an infinite number of states).

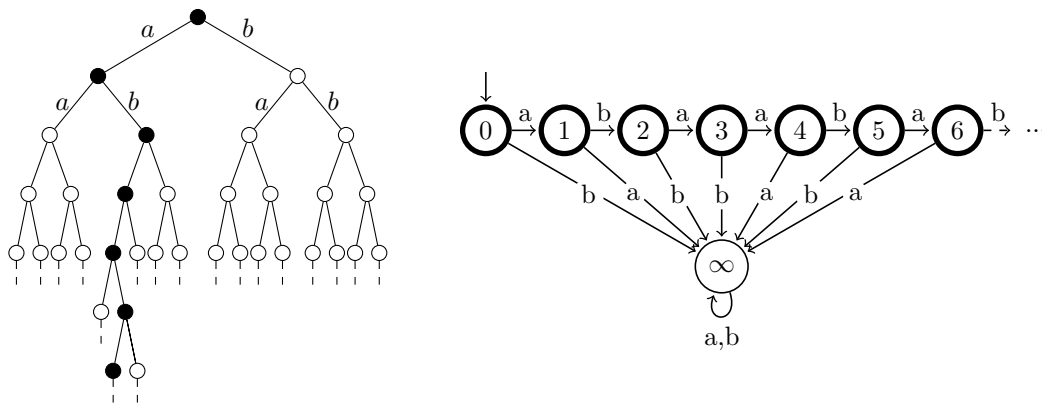

Figure 1: The tree-automaton recognizing the Fibonacci word and the corresponding minimal automaton

The number of subtrees of size k in \mathcal{T} is called the complexity $P(k)$, of \mathcal{T} . $P(k)$ is the number of equivalence classes of \sim_k . If $P(k) \leq k$ for at least one k , then it can be shown ([4]) that the

complexity is bounded by k . This implies that the minimal automaton $A(\mathcal{T})$ has k states. The tree is therefore called rational, since it recognizes a rational language.

If a tree-automaton \mathcal{T} is such that $P(k) = k + 1$ for all k , then it has a minimal complexity among all non-rational trees. Such trees have been shown to exist and are called Sturmian in [4] by analogy with the factor complexity definition of Sturmian words. In [4] several classes of Sturmian tree-automata are presented. However such trees are not balanced and cannot be defined using a mechanical construction, as with Sturmian words.

In the following we rather consider a different type of trees, namely infinite directed *graphs* with labels 0 or 1 on nodes and with uniform in-degree 1 and out-degree $d \geq 2$. Here, the children of a node are not ordered. Thus, the main difference with the previous definition is that arcs are not labeled. Therefore such trees cannot be bijectively associated with languages. However, it is possible to construct a minimal multi-graph (*i.e.* with multiples arcs) $G(T)$ associated with the tree T , mimicking the construction of the minimal automaton for ordered trees. Let us consider a family of equivalence relations over the nodes of T :

$v \equiv_0 u$ if u and v have the same label: $\ell(u) = \ell(v)$ and

$v \equiv_{n+1} u$ if $v \equiv_n u$ and the children of v are equivalent (for \equiv_n) to the children of u .

Therefore, $v \equiv_n u$ if and only if the subtree with root v of height n is isomorphic to the subtree with root u with height n . By merging the nodes of T when they belong to the same equivalence classes, for all n , one gets the minimal multi-graph $G(T)$ of the factors of T : all nodes merged in the same vertex of $G(T)$ have the same subtrees of every height.

In $G(T)$, the node corresponding to the root of T is distinguished. (graphically, this is done by adding an arrow pointing to the node).

There exists a way to associate an ordered tree-automaton \mathcal{T} to a tree T by choosing an order on the children of each node. This can be done by seeing $G(T)$ as an automaton by labeling arcs in $G(T)$ with letters a_1, \dots, a_d in an arbitrary fashion. Conversely, a tree-automaton \mathcal{T} can be converted into a graph T by removing the labels on the arcs. This graph is called the unordered version of \mathcal{T} .

An example of an unordered tree is given in Figure 2. The label of the black (white) node is 1 (0). The arcs are implicitly directed from top to bottom. Actually, most figures in this paper will represent binary trees (with out-degree $d = 2$), although all the discussion is carried throughout for arbitrary degrees. The nodes of the associated multi-graph $G(T)$ are numbered arbitrarily and nodes with label 1 are displayed with a bold circle. The node corresponding to the root of the tree is pointed by an arrow. This tree can be seen as the tree-automata recognizing the Fibonacci word where the labels on the arcs have been removed (there is no longer a left and right child at each node). Note that while the minimal automaton is infinite (see Figure 1), the minimal graph $G(T)$ is finite, with two nodes, one correspond to the tree where all labels are 0 and one with all labels equal to 0 except on one branch (see Figure 2).

2.1 Irreducibility and periodicity

By analogy with Markov chains, a tree T is *irreducible* if $G(T)$ is strongly connected. Also, an irreducible tree T is *periodic* with period p if the greatest common divisor of the lengths of all cycles in $G(T)$ is p . A tree with period 1 is also called *aperiodic*.

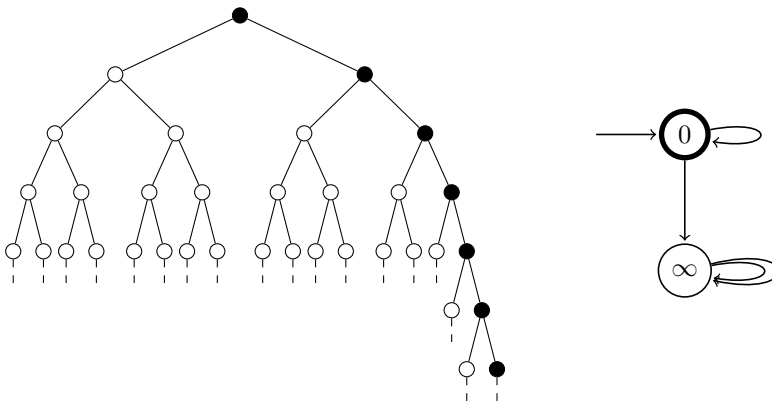

Figure 2: A tree and the associated minimal multi-graph.

2.2 Factors, complexity and Sturmian trees

A *factor of size n (and width 1)* is a subgraph of T which is a complete subtree of height n . The number of nodes in a factor of size n is denoted by $S(n) \stackrel{\text{def}}{=} \frac{d^n - 1}{d - 1}$.

A *factor of size n and width k* (with root v), is a sub-graph of T which is the subtree of height $k + n$ rooted in v minus the subtree of height k , rooted in v . The number of nodes of a factor of size n and width k is $S(n, k) \stackrel{\text{def}}{=} \frac{d^{n+k} - d^k}{d - 1}$.

Similarly to what as been done for words, the factor *complexity* $\mathcal{P}_T(n)$ of a tree T is the number of distinct factors of size n and width 1.

The complexity of a tree $\mathcal{P}_T(n)$ can be bounded by the total number of ways to label trees of height n and degree d , say A_n .

It should be clear that $A_1 = 2$ (a node can be labeled 0 or 1) and that $A_{n+1} = 2M(A_n, d)$ where $M(x, y)$ is the number of multisets with y elements taken from a set with x elements. Therefore using binomial coefficients,

$$A_{n+1} = 2 \binom{A_n + d - 1}{A_n - 1}.$$

This is a polynomial recurrence equation of degree d . A change of variable, $u_n = \log A_n + \frac{1}{d-1} \log \frac{2}{d!}$ yields a new recurrence equation $u_{n+1} = du_n + \varepsilon_n$ where $\varepsilon_n = o(1)$. This implies that $A_n = \phi^{d^n + o(d^n)}$ for some ϕ with $1 < \phi < 2$.

As for lower bounds on the complexity of a tree, it will be shown in Section 3 that trees such that $\mathcal{P}_T(n) \leq n$ for at least one n are rational, *i.e.* have a bounded number of factors of any size (this means that the minimal multi-graph is finite).

Therefore, trees T such that $G(T)$ is infinite and with a minimal complexity should satisfy $\mathcal{P}_T(n) = n + 1$. These trees will be called *Sturmian trees* by analogy with words. It is not difficult to exhibit such trees. For example, starting with a Sturmian word w a binary tree such that all nodes on level i have label w_i is Sturmian.

Another more interesting example is the Dyck tree. The Dyck tree is represented on Figure 3. This tree is the unordered version of the tree-automata recognizing the Dyck language (language generated by the context-free grammar $S \rightarrow aSbS|\epsilon$) and it is not hard to see that this tree is

Sturmian. For that, consider the graph $G(T)$ associated with the Dyck tree T , also displayed in Figure 3.

There are two factors of size 1 in T : those with a root labeled 1 (all associated with node 0 in $G(T)$) and those with a root labeled 0 (associated with nodes $\infty, 1, 2, \dots$ in $G(T)$). This corresponds to the equivalence classes for \equiv_1 .

As for factors of size n , all those with a root in node ∞ and $n, n+1, n+2$ have all their labels equal to 0: no path of length n in $G(T)$ reaches the only node with label 1, namely node 0.

As for the factors starting in node i of $G(T)$ with $0 \leq i < n$, then the first node with label 1 is at level $i+1$. This means that all these factors are distinct. In other words, the equivalence classes for \equiv_n are $\{\infty, n, n+1, \dots\}, \{0\}, \{1\}, \dots, \{n-1\}$. The number of distinct factors of size n is therefore $n+1$.

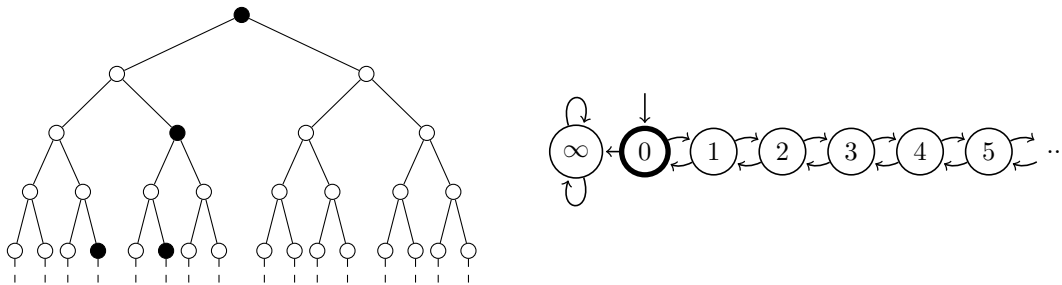

Figure 3: The Dyck tree and its minimal graph.

2.3 Density

The density of a tree T is meant to capture the average number of 1 in the tree.

For a node v and a height $n \geq 0$, we define the density of the factors of size n with root v by the average number of nodes with label 1 in this sub-tree. Let us call $d_v(n)$ the density of the factor of size n with root v and let r be the root of the tree T . In the following we will be using four notions of density.

- The *rooted density* of the tree is the limit of the density of the sub-trees of the root r (if it exists):

$$\lim_{n \rightarrow \infty} d_r(n)$$

- The *rooted average density* of the tree the Cesaro limit of these densities:

$$\lim_{n \rightarrow \infty} \frac{1}{n} \sum_{i=1}^n d_r(i)$$

- The *density* of the tree is α if it has an identical rooted density for all node v :

$$\forall v : \alpha = \lim_{n \rightarrow \infty} d_v(n)$$

Theorem 3.1. *The following proposition are equivalent*

1. *the tree T is rational;*
2. *there exists n such that $\mathcal{P}(n) \leq n$;*
3. *there exists n such that $\mathcal{P}(n) = \mathcal{P}(n + 1)$;*
4. *There exists B such that for all n , $\mathcal{P}(n) \leq B$.*

Proof. The proof of this results is similar to the proof for words.

1 implies 2: If $G(T)$ is finite, then the number of factors of size n in T is smaller than the size of $G(T)$, therefore, there exists n such that $\mathcal{P}(n) \leq n$.

2 implies 3: Since $\mathcal{P}(1) = 2$ and $\mathcal{P}(n) \leq n$ and since \mathcal{P} is non-decreasing with n , there exists $1 < k < n$ such that $\mathcal{P}(k) = \mathcal{P}(k + 1)$.

3 implies 4: If $\mathcal{P}(n) = \mathcal{P}(n + 1) = p$ then let us call by A_1^n, \dots, A_p^n all the distinct factors of size n in T . Since $\mathcal{P}(n + 1) = p$, each A_i^n is prolonged in a unique way into a tree of size $n + 1$, called A_i^{n+1} . Now, each sub-tree A_i^{n+1} is composed of a root and d factors of size n , in the set $\{A_1^n, \dots, A_p^n\}$. In turn, they are all prolonged into trees of size n in a unique way. Therefore, $\mathcal{P}(n + 2) = p$. By a direct induction, $\mathcal{P}(k) = p$ for all $k \geq n$.

4 implies 1: If the number of factors of size n is smaller than B for all n , then this means that the number of equivalence classes for \equiv_n is smaller than n for all n , this means that $G(T)$ has less than B nodes. \square

3.1 Density of rational trees

Let T be a rational tree and let $G(T)$ be its minimal multi-graph. The nodes of $G(T)$ are numbered $v_1 \dots, v_K$, with v_1 corresponding to the root of T .

$G(T)$ can be seen as the transition kernel of a Markov chain by considering each arc of $G(T)$ as a transition with probability $1/d$.

If $G(T)$ is irreducible then the Markov chain admits a unique stationary measure π on its nodes. The density of T and the stationary measure π are related by the following theorem.

Theorem 3.2. *Let T be an irreducible rational tree with a minimal multigraph $G(T)$ with K nodes. Let $\ell = (\ell_1, \dots, \ell_K)$ be the labels of the nodes of $G(T)$ and let $\pi = (\pi_1, \dots, \pi_K)$ be the stationary measure over the nodes of $G(T)$.*

If T is aperiodic, then T admits a density $\alpha = \pi \ell^t$.

If T is periodic with period p then T admits an average density $\alpha = \pi \ell^t$.

Proof. Let V_n be a Markov chain corresponding to $G(T)$. Since $G(T)$ is irreducible, V_n admits a unique stationary measure, say $\pi = (\pi_1, \dots, \pi_K)$. Let us call P the kernel of this Markov chain: $P_{i,j} = a/d$ if there are a arcs in $G(T)$ from v_i to v_j .

Now, let us consider all the paths of length n in T , starting from an arbitrary node v_i . By construction of $G(T)$, the number of paths that end up in the nodes v_1, \dots, v_K respectively, of $G(T)$, is given by the vector $e_i d^n P^n$, where e_i is the vector with all its coordinates equal to 0 except the i th coordinate, equal to 1.

Now, the number of ones in the tree of height n starting in v_i is $h_n(v_i) = e_i \sum_{k=0}^{n-1} d^k P^k \ell^t$.

Let us first consider the case where P is aperiodic. We denote by Π the matrix with all its lines equal to the stationary measure, π and by D_k the matrix $P^k - \Pi$. When P is aperiodic, then $\lim_{k \rightarrow \infty} \|D_k\|_1 = 0$. Therefore, for all $k > n$, $\|D_k\|_1 < \epsilon_n \rightarrow 0$.

Then the density of ones $d_{2n}(v_i) = \frac{d-1}{d^{2n}-1}h_{2n}(v_i)$ can be estimated by splitting the factors of size $2n$ into a factor of size n at the root and d factors of size n . One gets

$$\begin{aligned} d_{2n}(v_i) &= \frac{d-1}{d^{2n}-1}e_i \sum_{k=1}^n d^k P^k \ell^t + \frac{d-1}{d^{2n}-1}e_i \sum_{k=n+1}^{2n-1} d^k P^k \ell^t, \\ &= \frac{d-1}{d^{2n}-1}e_i \left(\sum_{k=1}^n d^k P^k + \sum_{k=n+1}^{2n-1} d^k D_k + \sum_{k=n+1}^{2n} d^k \Pi \right) \ell^t. \end{aligned}$$

when n goes to infinity, the first term goes to 0 because $e_i \sum_{k=1}^n d^k P^k \ell^t \leq d^{n+1}$. As for the second term $\frac{d-1}{d^{2n}-1}e_i \sum_{k=n+1}^{2n-1} d^k D_k \ell^t \leq \frac{1}{d^{2n}-1}d^{2n}\epsilon_n$. This goes to 0 when n goes to infinity.

As for the last term, $\frac{d-1}{d^{2n}-1}e_i \sum_{k=n+1}^{2n-1} d^k \Pi \ell^t = \frac{1}{d^{2n}-1}(d^{2n} - d^{n+2})(e_i \Pi) \ell^t$ this goes to $\pi \ell^t$ when n goes to infinity.

The same holds by computing the density of trees of size $2n+1$ by splitting them into the first $n+1$ levels and the last n levels.

This shows that the rooted density of all the trees in T is the same, equal to $\pi \ell^t$.

Let us now consider the case when the tree is periodic with period p . In that case, the kernel of p steps of the Markov chain can be put under the form

$$P^p = \left[\begin{array}{c|c|c|c} P_1 & 0 & \cdots & 0 \\ \hline 0 & P_2 & \ddots & 0 \\ \hline \vdots & \ddots & \ddots & \vdots \\ \hline 0 & 0 & \cdots & P_m \end{array} \right].$$

The sub-matrices P_1, \dots, P_m are the kernels of aperiodic chains defined on a partition $S_1 \dots S_m$ of the nodes of $G(T)$. Let us denote by $\alpha_1, \dots, \alpha_m$ the densities of the factors of size np , starting in $S_1 \dots S_m$, respectively (they exist because this has just been proved for aperiodic trees).

Starting from a node v the average density of a tree of size $n = pq_n + r_n$, $r_n < p$ is

$$\frac{1}{n} \sum_{k=0}^n d_k(v) = \frac{1}{pq_n + r_n} \left(\sum_{a=0}^{q_n} \sum_{b=0}^p d_{ap+b+r}(v) \right) + \frac{1}{pq_n + r_n} \sum_{k=0}^{r_n} d_k(v).$$

The first term goes to $(\alpha_1 + \dots + \alpha_m)/m$ while the second term goes to zero, when n goes to infinity, independently of the root. Finally, $(\alpha_1 + \dots + \alpha_m)/m = (\pi'_1 \ell'_1 + \dots + \pi'_m \ell'_m)/m = \pi \ell^t$ where π'_1, \dots, π'_m are the stationary probability for the kernels P_1, \dots, P_m and ℓ_1, \dots, ℓ_m are the vectors of the labels in $S_1 \dots S_m$. □

An example illustrating the computation of the density of an aperiodic irreducible rational tree is given in Figure 6. The stationary measure of the Markov chain is $\pi = (2/9, 3/9, 4/9)$. Therefore, the density is $\alpha = 2/9\ell_1 + 3/9\ell_2 + 4/9\ell_3 = 4/9$.

As for the reducible case, it should be easy to see that a rational tree may have different (average) densities for some of its subtrees (this is the case for the leftmost tree in Figure 4). Therefore, a reducible tree does not have a density nor an average density in general.

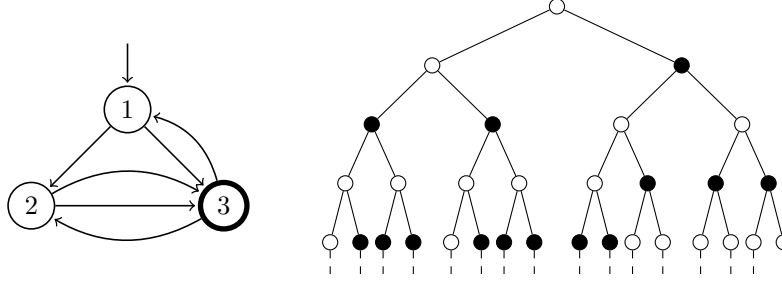

Figure 6: An irreducible aperiodic rational tree and its minimal graph. The stationary probabilities over the associated Markov chain are $\pi = (2/9, 3/9, 4/9)$. The density of the tree is $\alpha = 4/9$.

Let us call S_1, \dots, S_m the final strongly connected components of $G(T)$. Let $\alpha_1, \dots, \alpha_m$ be the average densities of the components S_1, \dots, S_m respectively. Finally, let $R = (R_1 \dots R_m)$ be the probability of reaching the components $S_1 \dots S_m$ starting from the root v_1 , in the Markov chain associated with $G(T)$. Then, the following is true.

Theorem 3.3. *A rational tree always has a rooted average density $\alpha = (\alpha_1, \dots, \alpha_m)R^t$.*

Proof. If P is reducible, P can be decomposed into

$$P = \begin{bmatrix} Q & K_1 & \dots & K_m \\ 0 & P_1 & \dots & 0 \\ \vdots & \dots & \ddots & \vdots \\ 0 & 0 & \dots & P_m \end{bmatrix} \quad \text{and} \quad P^n = \begin{bmatrix} Q^n & K'_1 & \dots & K'_m \\ 0 & P_1^n & \dots & 0 \\ \vdots & \dots & \ddots & \vdots \\ 0 & 0 & \dots & P_m^n \end{bmatrix}$$

Considering all the paths in $G(T)$ of length n , starting in the root, the number of paths ending in component S_ℓ is $N_\ell(n) = d^n \sum_{i \in S_\ell} P_{1i}^n$. Let us decompose all the paths ending in S_ℓ into two sub-paths: one (of length k) before entering S_ℓ and one (of length $n - k$) inside S_ℓ , we get from the decomposition of P^n , $N_\ell(n) = d^n \sum_{k=0}^n (1, 0, \dots, 0) Q^k K_\ell u_\ell$, where u_ℓ is a vector whose coordinates are 1 in S_ℓ and 0 everywhere else.

The number of 1 in the rooted subtree of T of size $2n$ is the number of ones in all the paths of length n plus the number of ones in the subtrees of size 1. When n is large, the number of ones in the paths can be neglected with respect to the number of ones in the end trees.

Finally, the number of one in a tree of size $2n$ is the number of ones in each possible end-tree of size n times the number of such trees, namely $N_\ell(n)$. When n goes to infinity, the density of ones goes to $\sum_{\ell=1..m} \alpha_\ell (1, 0, \dots, 0) (I - Q)^{-1} K_\ell u_\ell = (\alpha_1 \dots \alpha_m) R^t$, with $R_\ell = (1, 0, \dots, 0) (I - Q)^{-1} K_\ell u_\ell$. \square

An example illustrating the computation of the rooted average density of a tree is given in Figure 5. The graph $G(T)$ has two final components, one aperiodic component with density 1 and another one with period 2 with average density 1/2. Starting from the root, both components are reached with probability 1/2. Therefore, such a tree has an average rooted density $\alpha = 1/2(1/2) + 1/2(1) = 2/3$.

Also, it is not difficult to show that if all final component have a density (rather than an average density), then the tree has a rooted density, given by the same formula as in Theorem 3.3.

Finally, it is fairly straightforward to prove that since the $K \cdot K$ kernel P of the Markov chain associated with $G(T)$ has all its elements of the form a/d , then the stationary probabilities π as well as the average rooted density α of a rational tree are rational numbers of the form c/b with $0 \leq c \leq b \leq d^{K+1}$. This fact will be used in the algorithmic section 5 to make sure that the complexity of the algorithms does not depend on the size of the numbers.

4 Balanced and Mechanical Trees

In this section, we will introduce our most important definitions: strongly balanced and mechanical trees and explore the relations between them. In particular we will prove that in the case of irrational trees they represent the same set of trees, giving us a constructive representation of this class of trees. These results are very similar to the ones on words, which are summarized below.

4.1 Sturmian, Balanced and Mechanical Words

One definition of a Sturmian word uses the complexity of a word. The complexity of an infinite word w is a function $\mathcal{P}_w : \mathbb{N} \rightarrow \mathbb{N}$ where $\mathcal{P}_w(n)$ is the number of distinct factors of length n of the word w . A word is periodic if there exists n such that $\mathcal{P}_w(n) \leq n$. Sturmian words are aperiodic words with minimal complexity, *i.e.* such that for any n :

$$\mathcal{P}_w(n) = n + 1. \tag{1}$$

If x is a factor of w , its height $h(x)$ is the number of letters equal to 1 in x . A balanced word is a word where the letters 1 are distributed as evenly as possible:

$$\forall x, y \text{ factors of } w, |x| = |y| \Rightarrow |h(x) - h(y)| \leq 1. \tag{2}$$

A mechanical word is constructed using integer parts of affine functions. Let $\alpha \in [0; 1]$ and $\phi \in [0; 1)$. The lower (resp. upper) mechanical word of *slope* α and *phase* ϕ , $w = w_1 w_2 \dots$ (resp. $w' = w'_1 w'_2 \dots$) is defined by:

$$\forall i \geq 1 \quad \begin{aligned} w_i &= \lfloor (i+1)\alpha + \phi \rfloor - \lfloor n\alpha + \phi \rfloor, \\ w'_i &= \lceil (i+1)\alpha + \phi \rceil - \lceil i\alpha + \phi \rceil. \end{aligned} \tag{3}$$

These three definitions represent almost the same set of words. In the case of aperiodic words, they are equivalent: a word is Sturmian if and only if it is balanced and aperiodic if and only if it is mechanical of irrational slope. For periodic words, there are similar relations:

- A rational mechanical word is balanced.
- A periodic balanced word is ultimately mechanical.

A word is an ultimately mechanical word if it can be written as xw where x is a finite word and w is a mechanical word. An example of a balanced word which is not mechanical (and just ultimately mechanical) is the infinite word with all letter 0 and just one letter 1. For a more complete description of Sturmian words, we refer to [14].

4.2 Balanced and strongly balanced trees

Using the two definitions of factors of a tree, we define two notions of balance for trees: the first one and probably the most natural one, is what we call *balanced trees* and the other one is called *strongly balanced trees*.

Definition 4.1 (Balanced and strongly balanced tree). *A tree is balanced if for all $n \geq 0$, the number of nodes label by 1 in two factors of size n differ by at most 1.*

A tree is strongly balanced if for all $n, k > 0$, the number of 1 in two factors of size n and width k differ by at most 1.

As the name suggests, the strong balance property implies balance (by taking $k = 1$). In fact this notion is strictly stronger, see section 7 for an example of balanced tree that are not strongly balanced.

Although the balance property is weaker and seems more natural for a generalization from words, our results will be mainly focused on strongly balanced trees that have almost the same properties as their counterparts on words.

4.2.1 Density of a balanced tree

For all node v and all size n , we denote by $h_v(n)$ the number of 1 in the factor of root v of size n and $d_v(n)$ the density of this subtree is the number of ones divided by the cardinal $S(n)$ of the factor: $d_v(n) \stackrel{\text{def}}{=} \frac{1}{S(n)}h_v(n)$.

Proposition 4.1.1 (Density of balanced tree). *A balanced tree has a density α .*

Moreover for all node v and for all size n :

$$|h_v(n) - \lfloor S(n)\alpha \rfloor| \leq 1 \quad (4)$$

Proof. Let m_n be the minimal number of 1 in all factors of size n . As the tree is balanced, for all nodes v and $n \geq 1$:

$$m_n \leq h_v(n) \leq m_n + 1 \quad (5)$$

Now let us consider a factor of size $n + k$ and root v . It can be decomposed in a factor of size k of root v and d^k factors of size n at the leaves of the previous factor. The number of ones in these factors can be bounded by m_n and m_k , therefore we have:

$$m_k + d^k m_n \leq m_{n+k} \leq m_k + 1 + d^k(m_n + 1) \quad (6)$$

The density of a factor of size n is $\frac{m_n}{S(n)} \leq d_v(n) = \frac{h_v(n)}{S(n)} \leq \frac{m_n+1}{S(n)}$. Using these facts, we can bound $d_v(n+k) - d_v(n)$:

$$\frac{m_{n+k}}{S(n+k)} - \frac{m_n+1}{S(n)} \leq d_v(n+k) - d_v(n) \leq \frac{m_{n+k}+1}{S(n+k)} - \frac{m_n}{S(n)}$$

Using (6), the left inequality can be lower bounded by

$$\begin{aligned} (d-1)\left(\frac{d^k m_n + m_k}{d^{n+k} - 1} - \frac{m_n + 1}{d^n - 1}\right) &= (d-1)\left(\frac{m_n + m_k/d^k}{d^n - 1/d^k} - \frac{m_n + 1}{d^n - 1}\right) \\ &\geq (d-1)\left(\frac{m_n}{d^n - 1} - \frac{m_n + 1}{d^n - 1}\right) \\ &\geq -\frac{1}{S(n)} \end{aligned}$$

The same method can be used to prove that $d_v(n+k) - d_v(n) \leq \frac{1}{S(n)}$, which shows that for n big enough, $|d_v(n+k) - d_v(n)|$ is smaller than ϵ , regardless of k . Thus $d_v(n)$ is a Cauchy sequence and has a limit $\alpha = \lim_{n \rightarrow \infty} \frac{m_n}{S(n)}$. This limit does not depend on v and the tree has a density.

Lets now prove that $d_v(n) - \lfloor S(n)\alpha \rfloor \leq 1$: dividing the inequality (6) by $S(n, k)$ and taking the limit when k tends to ∞ leads to:

$$\frac{(d-1)m_n + \alpha}{d^n} \leq \alpha \leq \frac{(d-1)m_n + 1 + \alpha}{d^n}.$$

This shows that: $S(n)\alpha - 1 \leq m_n \leq S(n)\alpha$, which implies Equation (4). □

Similar ideas can be used to show that Equation (4) can be improved in the case of strongly balanced tree: for all width and size $k, n \geq 1$, the number of ones $h(n, k)$ in a factor of size n and width k satisfies:

$$|h(n, k) - \lfloor S(n, k)\alpha \rfloor| \leq 1 \tag{7}$$

4.3 Mechanical trees

Building balanced tree is not that easy. According to formula (4), each factors of size n must have $\lfloor \alpha S(n) \rfloor$ or $\lfloor \alpha S(n) \rfloor + 1$ nodes one. This leads us to the following construction, inspired by the construction of mechanical words.

Definition 4.2 (Mechanical tree). *A tree is mechanical of density $\alpha \in [0; 1]$ if for all node v , there exists a phase ϕ_v which satisfies one of the two following properties:*

$$\forall n : h_v(n) = \left\lfloor S(n)\alpha + \phi_v \right\rfloor, \tag{8}$$

$$\text{or } \forall n : h_v(n) = \left\lceil S(n)\alpha - \phi_v \right\rceil. \tag{9}$$

In the first case, we say that ϕ_v is an inferior phase of v . In the second case, we say that ϕ_v is a superior phase of v .

This definition suggests that the phases of all nodes could be arbitrary. In fact, we will see that there exists a unique mechanical tree with a given phase at the root. The second question raised by this definition is the existence and uniqueness of the phase: we call ϕ_v “a” phase of a node ϕ_v and not “the” phase of ϕ_v since there may exist several phases leading to the same tree.

We begin by a characterization of mechanical trees, given in the following formula:

Proposition 4.2.1 (Characterization of mechanical trees). *For each $\alpha \in [0; 1]$ and $\phi \in [0; 1]$, there exists a unique mechanical tree of density α such that ϕ is an inferior (resp. superior) phase of the root.*

Moreover, if ϕ is an inferior (resp. superior) phase of a node then $\phi_0 \leq \dots \leq \phi_{d-1}$ are inferior (resp. superior) phases of its d children, with

$$\phi_i = \frac{\alpha + \phi + i - \lfloor \alpha + \phi \rfloor}{d} \quad \left(\text{resp. } \phi_i = \frac{\phi + \lceil \alpha - \phi \rceil - \alpha + i}{d} \right). \tag{10}$$

The proof will be done in two steps. First we will see that if we define the phases as in (10) we have a mechanical tree, then we will see that this is the only way to do so.

Proof. Existence. Let $\alpha \in [0; 1]$ and $\phi \in [0; 1]$. We want to build a mechanical tree which root has an inferior phase ϕ (the case of a superior phase is similar and is not detailed here). Let \mathcal{A} be an infinite tree. To each node v , we associate a number ϕ_v defined by:

- $\phi_{\text{root}} = \phi$.
- If the phase of a node v is ϕ_v , its d children satisfy Equation (10).

Then we build a labeled tree by associating to each node v the label $\lfloor \alpha + \phi_v \rfloor$. Let us prove by induction on n that the following relation holds.

$$\text{For all } v : h_v(n) = \lfloor S(n)\alpha + \phi_v \rfloor. \quad (11)$$

By definition of the labels, (11) holds when $n = 1$. Let $n \geq 0$ and let us assume that (11) holds for n . Let v be a node with phase ϕ_v and let $\phi_0 \dots \phi_{d-1}$ be the phases of its children. We assume that $\alpha + \phi_v < 1$ (which means that the label of the node is 0) a similar calculation can be done in the other case, $\alpha + \phi_v > 1$.

Using the well-known formula $\sum_{i=0}^{d-1} \lfloor x + \frac{i}{d} \rfloor = \lfloor dx \rfloor$, we can compute $h_v(n+1)$:

$$\begin{aligned} h_v(n+1) &= \sum_{i=0}^{d-1} \lfloor S(n)\alpha + \phi_i \rfloor \\ &= \sum_{i=0}^{d-1} \lfloor \frac{d^n - 1}{d - 1} \alpha + \frac{\alpha + \phi + i}{d} \rfloor \\ &= \lfloor d \left(\frac{d^n - 1}{d - 1} \alpha + \frac{\alpha + \phi}{d} \right) \rfloor \\ &= \lfloor S(n+1)\alpha + \phi \rfloor. \end{aligned}$$

Therefore, (11) holds for all n which means that the tree is mechanical.

Uniqueness. Now, let \mathcal{A} be a mechanical tree of density α . Let v be a node and $\phi_0, \dots, \phi_{d-1}$ be the phases of its children. Let i and j be two children and let $h_i(n)$ be the number of ones in the i th child subtree (of phase ϕ_i). We want to prove that either for all n : $h_i(n) \leq h_j(n)$ or for all n : $h_i(n) \geq h_j(n)$. If the two nodes are both inferior (resp. superior), this is clearly true: $h_i(n) \leq h_j(n)$ if and only if $\phi_i \leq \phi_j$ (resp. $\phi_i \geq \phi_j$). If i is inferior and j is superior, it is not difficult to show that $\phi_i < 1 - \phi_j$ implies $h_i(n) \leq h_j(n)$ and $\phi_i \geq 1 - \phi_j$ implies $h_i(n) \geq h_j(n)$.

Therefore we can assume (otherwise we exchange the order of the children) that for all n :

$$h_0(n) \leq h_1(n) \leq \dots \leq h_{d-1}(n).$$

Moreover as $h_{d-1}(n) - h_0(n) \leq 1$, there exists k such that $h_0(n) = h_1(n) = \dots = h_k(n) < h_{k+1}(n) = \dots = h_{d-1}(n)$. As $\sum_{i=0}^{d-1} h_i(n)$ does not depend on $\phi_0, \dots, \phi_{d-1}$, then for each n there is only one k that works and therefore there are only one possibility for $h_i(n)$ for all n and all i . This implies that the tree with root v is unique

As we have seen in the beginning of the proof, the phase ϕ_i defined in (10) defines correct values for $h_i(\cdot)$. Therefore such a phase ϕ_i is a possible phase for the i th child. \square

This theorem shows that when the phase is fixed the tree is unique. The converse is false and one can find several phases that lead to the same tree (for example, when $\alpha = 0$ all phases define the tree with label 0 everywhere) but we will show next that the set of densities α for which the phases are not necessarily unique has Lebesgue measure zero.

If for all n , $S(n)\alpha + \phi \notin \mathbb{N}$, then $\lfloor S(n)\alpha + \phi \rfloor = \lceil S(n)\alpha + \phi - 1 \rceil$. In that case, if ϕ is an inferior phase of a node then $1 - \phi$ is a superior phase of the node. Therefore except particular cases, there exists at least two phases of a node: one inferior and one superior. Let us now look at the possible uniqueness of the inferior phase.

Let us call $\text{frac}(x)$ the fractional part of a real number x and let us consider the sequence $\{\text{frac}(S(n)\alpha + \phi)\}_{n \in \mathbb{N}}$. If this sequence can be arbitrary close to 0, this means that for all $\psi < \phi$, there exists k such that $\lfloor S(k)\alpha + \psi \rfloor < \lfloor S(k)\alpha + \phi \rfloor$ and ψ can not be a phase of the tree. Also, if this sequence can be arbitrary close to 1, then one can show similarly that for all $\psi > \phi$, ψ is not a phase of the node. Conversely, if there exists $\delta > 0$ such that $\text{frac}(S(n)\alpha + \phi) > \delta$ (resp. $< 1 - \delta$) for all n , then let $\phi' = \phi - \varepsilon$ (resp. $\phi' = \phi + \varepsilon$), with $\varepsilon < \delta$. Then $\lfloor S(n)\alpha + \phi \rfloor = \lfloor S(n)\alpha + \phi' \rfloor$ for all n .

Finally, a phase ϕ is unique if and only if 0 and 1 are accumulation points of the sequence $\{\text{frac}(S(n)\alpha + \phi)\}_{n \in \mathbb{N}}$.

Let us call $x \stackrel{\text{def}}{=} \frac{1}{d-1}\alpha$ and $y \stackrel{\text{def}}{=} \phi - x$ and let us consider the sequence

$$\text{frac}(S(n)\alpha + \phi) = \text{frac}(xd^n - y).$$

Let x_1, \dots, x_k, \dots (resp. y_1, y_2, \dots) be the sequence of the digits of x (resp. y) in base d (also called the d -decomposition). We have:

$$xd^n - y = \underbrace{\sum_{k=1}^n x_k d^{n-k}}_{\in \mathbb{N}} + \sum_{k=1}^{\infty} (x_{k+n} - y_k) d^{-k}$$

$\text{frac}(xd^n - y)$ is arbitrarily close to 0 implies that for arbitrarily big k , there exists n such that

$$x_n, \dots, x_{n+k-2} = y_1, \dots, y_k, \quad x_{n+k-1} > y_n, \quad (12)$$

or

$$\text{frac}(xd^n - y) = 0. \quad (13)$$

Also, $xd^n - y$ is arbitrarily close to 1 implies that for arbitrarily big k , there exists n such that

$$x_n, \dots, x_{n+k-2} = y_1, \dots, y_{n-1}, \quad x_{n+k-1} < y_n, \quad (14)$$

or the d -development of y is finite (with only zeros after some point $\ell : y = y_1, \dots, y_\ell, 1, 0, 0, \dots$) and that for arbitrarily big k , there exists n such that

$$x_n, \dots, x_{n+k-2} = y_1, \dots, y_\ell, 0, 1, \dots, 1. \quad (15)$$

Using this characterization, three cases can be distinguished.

- If $\frac{\alpha}{d-1}$ is a number such that all finite sequences over $0, \dots, d-1$ appear in its d -decomposition, then every phase is unique. In particular, all *normal numbers*¹ in base d verify this property and it is known that almost every number in $[0, 1]$ is normal (see [5] or [7]).

¹A number is normal in base d if all sequences of length k appear uniformly in its d -decomposition

- If $\alpha \in \mathbb{Q}$, then the sequence $\text{frac}(S(k)\alpha + \phi)$ is periodic and there are no phase ϕ such that ϕ is unique.
- If α is neither rational nor has the property that all binary sequences appear in α , then some ϕ can be unique and some others may not. For example, for $d = 2$, if α is (in base 2) the number

$$\alpha = 0.101100111000111100001111100000\dots,$$

then if $\text{frac}(\alpha - \phi) = 0$, ϕ is unique (because α satisfies both properties 12 and 15). However ϕ_1 and ϕ_2 such that $\text{frac}(\alpha - \phi_1) = 0.10100$ and $\text{frac}(\alpha - \phi_2) = 0.1010$ are equivalent (generate the same tree).

Other examples of the same type are the *rewind trees*, drawn on figure 16. The sequence of digits in base 2 of the density of trees is a Sturmian word with irrational density. Half of the nodes of the tree are associated with node 0 in the minimal graph and therefore could have the same phase whereas the phases computed using Equation 10 are not all the same. Therefore, phases are not unique here.

4.3.1 Phases of a tree

Let us call Φ_v the set of numbers that can be phases of a node v and Φ , the set of the possible phases of a tree is the union of all possible phases of its nodes: $\Phi = \cup_b \Phi_v$. The set Φ may be countable or uncountable. Countable for example when $\alpha/(d-1)$ is normal since there are at most as many phases as nodes. Uncountable for example for the tree with all label 0, for which for each node, all phases in $[0; 1)$ work. Nevertheless, the set of possible phases is dense in $[0; 1)$.

Indeed, at least all phases defined by the relation (10) are in Φ . If ϕ is the phase of the root, then all nodes at level k have a phase which is the fractional part of:

$$\frac{\frac{\phi + \alpha + i_k}{d} + \alpha + i_{k-1}}{d} + \dots + \alpha + i_1 = \alpha \left(\frac{1}{d^k} \dots \frac{1}{d} \right) + \frac{\phi}{d^k} + \frac{i_k}{d^k} + \dots + \frac{i_1}{d^1}, \quad (16)$$

with $0 \leq i_j < d$ for all j . Conversely all of these numbers are the phases of some node at level k .

As k tends to infinity, by a proper choice of i_1, \dots, i_k the fractional part of this number can be as close as possible to any number in $[0; 1]$. Thus the set of phases of the tree is dense in $[0; 1]$.

If the density is $\frac{p(d-1)}{d^{n+k}-d^k}$ (with $n+k$ minimal) one can show that the set of all possible phases for a given node is $[\frac{d^m-1}{d-1}\alpha; \min(\frac{d^{m+1}-1}{d-1}\alpha, 1))$ for some $m \in 0, \dots, n+k-1$. As Φ is dense in $[0; 1)$, it contains all of these intervals. Therefore, $\Phi = [0; 1)$ and the tree has exactly $n+k$ different factors of size greater than $n+k$. Hence its minimal graph has exactly $n+k$ nodes.

4.4 Equivalence between strongly balanced and mechanical trees

As we have seen in section 4.1, there are strong relations between balanced and mechanical words. In this part, we will see that we can prove the same results between strongly balanced and mechanical trees. This result is formally stated in the following theorem.

A tree is *ultimately mechanical* if all nodes (except finitely many) are mechanical (*i.e.* satisfies the equations 8 or 9).

Theorem 4.1. *The following statements are true.*

- (i) *A mechanical tree is strongly balanced.*
- (ii) *An irrational strongly balanced tree is mechanical.*
- (iii) *A rational strongly balanced tree is ultimately mechanical.*

This theorem is the analog of the theorem linking balanced and mechanical words. We have seen that the word 0^k10^∞ is balanced but not mechanical, only ultimately mechanical. Its counterpart for trees would be a tree with all label equal to 0 except for one node which has a label 1. The number 1 can be chosen as deep as desired, which shows that we can not bound the size of the “non-mechanical” beginning of the tree. A more complicated example is drawn Figure 8.

Let us begin by the proof the first part of the theorem:

Lemma 4.2.1. *A mechanical tree is strongly balanced.*

Proof. Let $n, k \in \mathbb{N}$. For all node v , $h_v(n, k)$ is the number of 1 in the factor of size n and width k rooted in v . We want to prove that for all pairs of nodes v and v' : $|h_v(n, k) - h_{v'}(n, k)| \leq 1$.

We assume that the nodes v and v' are inferior of phase ϕ and ϕ' (the proof with superior phases is similar).

$$h_v(n, k) - h_{v'}(n, k) = \lfloor \frac{d^{n+k} - 1}{d - 1} \alpha + \phi \rfloor - \lfloor \frac{d^k - 1}{d - 1} \alpha + \phi \rfloor - \lfloor \frac{d^{n+k} - 1}{d - 1} \alpha + \phi' \rfloor + \lfloor \frac{d^k - 1}{d - 1} \alpha + \phi' \rfloor.$$

Using the well-known inequality $x - x' - 1 < \lfloor x \rfloor - \lfloor x' \rfloor < x - x' + 1$, one can show that

$$-2 < h_v(n, k) - h_{v'}(n, k) < 2.$$

As $h_v(n, k)$ and $h_{v'}(n, k)$ are integers, we have $-1 \leq h_v(n, k) - h_{v'}(n, k) \leq 1$ which ends the proof of the lemma. \square

We will see in the next section 4.5 that a tree is rational if and only if its density can be written as $\frac{p}{S(n, k)}$ ($p, k, n \in \mathbb{N}$), therefore we will do the proof of theorem 4.1 distinguishing strongly balanced tree with density of this form or not.

Lemma 4.2.2. *If \mathcal{A} is a strongly balanced tree of density α which can not be written as $\frac{p}{S(n, k)}$ ($p, k, n \in \mathbb{N}$) then \mathcal{A} is mechanical.*

Proof. let τ be a real number and v a node. At least one of the two following properties is true:

$$\forall n \geq 1 : h_v(n) \leq \lfloor S(n)\alpha + \tau \rfloor, \tag{17}$$

$$\forall n \geq 1 : h_v(n) \geq \lfloor S(n)\alpha + \tau \rfloor. \tag{18}$$

To prove this, assume that it is not true. Then there exists k, n such that $h_v(n) < \lfloor S(n)\alpha + \tau \rfloor$ and $h_v(k) > \lfloor S(k)\alpha + \tau \rfloor$. In that case the number of 1 in the factor of size $n, n - k$ (or $k, k - n$ if $k > n$) is $h_v(n) - h_v(k) \leq \lfloor S(n)\alpha + \phi \rfloor - \lfloor S(k)\alpha + \phi \rfloor - 2 < \frac{d^n - d^k}{d - 1} \alpha - 1$ which violates the formula (7).

Let us define now the number ϕ as the minimum τ that satisfies (17)

$$\phi = \inf_{\tau} \left\{ \text{For all } n : h_v(n) \leq \lfloor S(n)\alpha + \tau \rfloor \right\}.$$

For all $\tau > \phi$, the equation (17) is true, while for all $\tau' < \phi$, the equation (18) is true. This means that for all $\epsilon > 0$ and all n :

$$S(n)\alpha + \phi - \epsilon - 1 \leq \lfloor S(n)\alpha + \phi - \epsilon \rfloor \leq h_v(n) \leq \lfloor S(n)\alpha + \phi + \epsilon \rfloor \leq S(n)\alpha + \phi + \epsilon. \quad (19)$$

Taking the limit when ϵ tends to 0 shows that:

$$S(n)\alpha + \phi - 1 \leq h_v(n) \leq S(n)\alpha + \phi. \quad (20)$$

Therefore, unless $S(n)\alpha + \phi \in \mathbb{N}$, $h_v(n) = \lfloor S(n)\alpha + \phi \rfloor = \lceil S(n)\alpha + \phi - 1 \rceil$.

If there exists $n \in \mathbb{N}$ such that $S(n)\alpha + \phi \in \mathbb{N}$, then there are no other $k \in \mathbb{N}$ ($k \neq n$) such that $S(k)\alpha + \phi \in \mathbb{N}$ – otherwise that would violate the condition $\alpha \notin \{\frac{p}{S(n,k)}, p, k, q \in \mathbb{N}\}$. Therefore, for this particular n , either $h_v(n) = S(n)\alpha + \phi = \lfloor S(n)\alpha + \phi \rfloor$ – in that case the node is inferior of phase ϕ – or $h_v(n) = S(n)\alpha + \phi - 1 = \lceil S(n)\alpha + \phi - 1 \rceil$ – in that case the node is superior of phase $1 - \phi$. \square

Lemma 4.2.3. *Let \mathcal{A} be a tree such that there exist n and k such that all factors of size (n, k) have the same number of nodes with label 1. Then the tree is mechanical.*

Proof. Let us take n and k satisfying the property, such that $n+k$ is minimal and let us call p is the common number of ones in the factors of size (n, k) . Obviously, the tree as a density $\alpha = \frac{p(d-1)}{d^k(d^n-1)}$.

Let v be the root of the tree. The same proof as in the irrational case can be used to establish that there exists ϕ such that

$$S(n)\alpha + \phi - 1 \leq h_v(n) \leq S(n)\alpha + \phi,$$

and that the root is inferior of phase ϕ if there is no j such that $h_v(j) = \frac{d^j-1}{d-1}\alpha + \phi - 1$ and superior of phase $1 - \phi$ if there is no i such that $h_v(i) = \frac{d^i-1}{d-1}\alpha + \phi$. Therefore the tree is mechanical unless there exist i and j satisfying these equalities. Let us show that if there exist such i and j , there is a contradiction.

Let $i = \min_{i'} \{h_v(i') = \frac{d^{i'}-1}{d-1}\alpha + \phi\}$ and $j = \min_{j'} \{h_v(j') = \frac{d^{j'}-1}{d-1}\alpha + \phi - 1\}$. Either $i < j$ or $i > j$, let us assume that $j < i$, the other case is similar. The number of ones in the factor of size $i - j$ and width j is $p' = \frac{d^i-d^j}{d-1}\alpha + 1$. In that case we have $i \geq k + n$, otherwise that would violate the minimal property of $n + k$. If $j - i > n$ the factor of size $i - j$ and width j is composed of a factor of size $i - n$ and width j and d^{i-n-k} factors of size n and width k – that have exactly p nodes one as assumed in the previous paragraph – and then the number of 1 in this subtree is:

$$h_v(i) - h_v(j) - d^{i-n-k}p + \phi + 1 = \alpha \frac{d^{i-n} - d^j}{d-1} + \phi + 1,$$

which violates the minimality of i .

Then if all factors of size (k, n) have exactly p nodes 1, the tree is mechanical. \square

Lemma 4.2.4. *If \mathcal{A} is a strongly balanced tree with a density $\alpha = \frac{p}{S(n,k)}$ then it has at most n factors of size n, k with $p + 1$ ones.*

Proof. Using Eq. (7), each factor of size (n, k) has $p - 1$, p or $p + 1$ nodes labeled by 1. As the tree is strongly balanced, either there is no factor with $p - 1$ ones or no factor with $p + 1$ ones. Let us

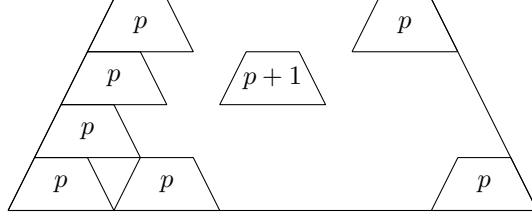

Figure 7: A block of size $(n' = \ell n, k')$ is made of j blocks of size (n, k) .

assume that there is no factor with $p - 1$ ones (the other case is similar). We claim that there are at most n factors of size (n, k) with $p + 1$ nodes labeled by 1.

Indeed, let f be a factor of size (n', k') with $n' = \ell n, i \in \mathbb{N}, k' \geq k$. This tree is composed of j blocks of size (n, k) (where j depends on ℓ and k' , see Figure 7) and using Eq. (7) again, the number of nodes with label 1 is either $jp - 1, jp$ or $jp + 1$. Therefore at most one of the (n, k) blocks has $p + 1$ nodes labeled by 1.

Now, in the whole tree, if there were more than $n + 1$ blocks of size (n, k) with $p + 1$ ones, each of these blocks starting at line l_1, \dots and l_{n+1} , there would be two blocks with $l_i = l_j \pmod n$ and the block of size $l_j - l_i + n, l_i$ would have $jp + 2$ ones, which is not possible. Therefore there are at most n blocks of size n, k with $p + 1$ nodes labelled by 1 in the whole tree. \square

An example of a rational tree strongly balanced but not mechanical is presented in Figure 8.

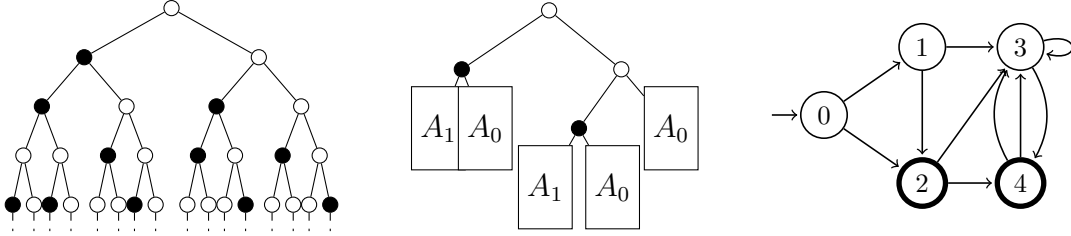

Figure 8: Example of a rational tree that is strongly balanced but not mechanical. On the left is the tree itself. In the middle the mechanical suffixes of the tree are displayed and its corresponding minimal graph (reducible) is displayed on the right.

One can verify on the picture that the beginning of this tree is strongly balanced and as it continues with density exactly $1/3$, the whole tree is strongly balanced. However this tree is ultimately mechanical but not mechanical since in a mechanical tree of density $1/3$, all factors of size 2 should have $\lfloor 1 + \phi \rfloor = 1$ node labeled by one.

Lemma 4.2.5. *A strongly balanced tree with density $\alpha = \frac{p}{S(n,k)}$ is ultimately mechanical. Furthermore, if the tree is irreducible, it is mechanical.*

Proof. Using Lemma 4.2.4, there are at most n factors of size n and width k with $p + 1$ nodes 1, in the rest of the tree all factors of size (n, k) have exactly p ones. Then the tree is ultimately mechanical by Lemma 4.2.3.

If the tree is irreducible, a factor appears either 0 or an infinite number of times. As there are at most n factors of size (k, n) with $p + 1$ nodes 1, there are no such factors and the tree is mechanical by Lemma 4.2.3.

Note that this lemma concludes the proof of Theorem 4.1. \square

4.5 Link with Sturmian trees

In the case of words, Sturmian words are exactly the balanced (or mechanical) aperiodic words. The case of trees does not work as well since the Dyck Tree (Figure 3) and more generally all examples of Sturmian trees given in [4] are not balanced. However, the other implication holds as seen in the following theorem:

Theorem 4.2. *The following propositions are true.*

- A strongly balanced tree of density different from $\frac{p}{S(n,k)}$ for any $p, n, k \in \mathbb{N}$ is Sturmian.
- A strongly balanced tree of density $\frac{p}{S(n,k)}$ for any $p, n, k \in \mathbb{N}$ is rational.

This result has a simple implication: a strongly balanced tree is rational if and only if there exist $p, n, k \in \mathbb{N}$ such that its density is $\frac{p}{S(n,k)}$.

Proof. Let us consider the case of inferior mechanical trees (the superior case being similar).

Let \mathcal{A} be a mechanical tree of density α , let v be a node and let $n \geq 0$. According to Proposition 4.2.1, the factor of size n only depends on the phase ϕ_v of its root. In fact, one can show that this factor only depends on the values $\lfloor \frac{d^i-1}{d-1}\alpha + \phi_v \rfloor$. For all $i \geq 0$ and $\phi \in [0 : 1]$, we define the quantities $f_i(\phi) \stackrel{\text{def}}{=} \lfloor \frac{d^i-1}{d-1}\alpha + \phi \rfloor$. The number of factors of size n only depends on the values $f_1(\phi), \dots, f_n(\phi)$.

As seen in (16), the set of phases is dense in $[0; 1]$, therefore they are exactly as many trees as tuples $f_1(\phi), \dots, f_n(\phi)$ when $\phi \in [0; 1]$ by right-continuity of f_i .

Each f_i is an increasing function taking integer values and $h_i(1) - h_i(0) = 1$. Thus there are at most $n + 1$ different tuples and then at most $n + 1$ factors of size n and a mechanical tree is either rational or Sturmian.

Moreover if $\alpha \notin \left\{ \frac{p}{d^k S(n)} / p, n, k \in \mathbb{N} \right\}$, we neither have $i \neq j$ and $\frac{d^i-1}{d-1}\alpha + \phi, \frac{d^j-1}{d-1}\alpha + \phi \in \mathbb{N}$ and then there are exactly $n + 1$ factors of size n .

If $\alpha = \frac{p}{S(n,k)}$, then the number of factors of size n is at most n (see Section 4.3.1). Therefore the tree is rational using Theorem 3.1.

If the tree is not mechanical, then Theorem 4.1 says that the tree has density $\alpha = \frac{p}{S(n,k)}$ and is ultimately mechanical: There exists a depth $D \geq 1$ after which the tree is mechanical. Therefore, there are at most $S(D) + n$ factors of any size (n in the mechanical children because of the value of α plus $S(D)$ in the prefix sub-tree). In that case the tree is rational by Theorem 3.1. \square

5 Algorithmic issues

5.1 Testing if a rational tree is strongly balanced

Given a finite description of a rational tree, let us consider the problem of checking whether this tree is balanced. An algorithm that works in time $O(n^3)$ where n is the number of vertices of the minimal graph of the tree is presented.

The first focus is on the description of the special structure of the minimal graph of a rational strongly balanced tree. Then an algorithm for irreducible rational trees is described as well as a sketch of the algorithm for the general case.

5.1.1 Graph of rational strongly balanced trees

Let us first consider a rational mechanical tree of density α . We know that there exist $p, k, n \geq 0$ such that $\alpha = \frac{p(d-1)}{d^k(d^n-1)}$. Using section 4.3.1, the minimal graph has exactly $n+k$ nodes, and for any node, the set of all possible phases of all its descendants is $[0; 1)$. Therefore, the graph is strongly connected and unique. The only difference between two rational mechanical trees of the same density is to which node the root of the tree is associated. Figure 9 displays several examples. The (unique) minimal graph of the mechanical trees of density $1/3, 1/7, 4/15$ and $2/15$ are displayed.

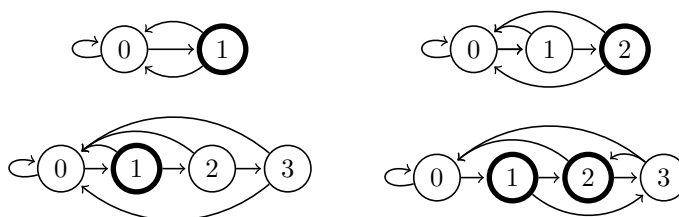

Figure 9: These graphs represent all mechanical trees of density $1/3, 1/7, 4/15$ and $6/15 = 2/5$. For all graphs with n nodes, there are exactly n different mechanical trees of this particular density, depending on which node is associated to the root. Note that the first three graphs have a very similar structure (Figure 16 displays more mechanical trees with this structure).

If the tree is strongly balanced but not mechanical, it is ultimately mechanical (see proposition 4.2.5) which means that after a finite depth k , all suffixes are mechanical trees with the same density. All of these tree have the same graph, therefore the minimal graph has a unique final strongly connected component which is reached in at most k steps. Therefore, the minimal graph of a strongly balanced tree can be decomposed into a finite acyclic graph and one final strongly connected component, like in Figure 10.

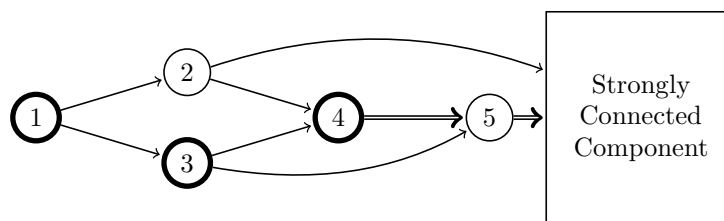

Figure 10: General form of the graph of a reducible strongly balanced tree: an acyclic graph ending in a unique strongly connected component.

5.1.2 Irreducible trees

Testing if two graphs with a given fixed out-degree are isomorphic can be done in polynomial time [15]. Therefore using the result shown in the previous section 5.1.1, an algorithm to test if a graph represents a mechanical tree can be obtained by computing the density α of the graph and testing if the graph is isomorphic to the graph of all mechanical trees with density α . However this is not very efficient and here we propose an algorithm that tests the balance property directly.

Consider an irreducible rational tree \mathcal{A} and let n_0 be the number of vertices of its minimal graph. Theorem 4.2 says that it is strongly balanced if and only if it is mechanical. In that case its density is $\frac{p}{S(n_0, k_0)}$ for some $p, k_0 \in \mathbb{N}$ and all sub-trees of size k_0, n_0 have exactly p nodes with label 1. Such factors will be called *basic blocks* in the following.

Recall that the tree is strongly balanced if all factors of size (n, k) have $\lfloor \alpha S(n, k) \rfloor$ or $\lfloor \alpha S(n, k) + 1 \rfloor$ nodes of label one. We want to show that testing it for all $n, k < n_0 + k_0$ is sufficient.

Let v be a node and $n, k \geq 0$ and let $h_v(F)$ be the number of labels 1 in the factor F of size (n, k) with root v .

Starting from F , we construct a new factor F' by adding a new factor on top of F of size $n_0, k - n_0$. This new factor can be partitioned into $d^{k-n_0-k_0}$ basic blocks. The total factor F' is of size $(n + n_0, k - n_0)$ and its number of ones is $h_v(F') = h_v(F) + d^{k-n_0-k_0}p$ (see Figure 11).

The augmentation of the factor can be repeated until its size n', k' is such that $k' \leq k_0 + n_0$. Its number of ones is $h_v(F') = h_v(F) + H$ where H does not depend on v .

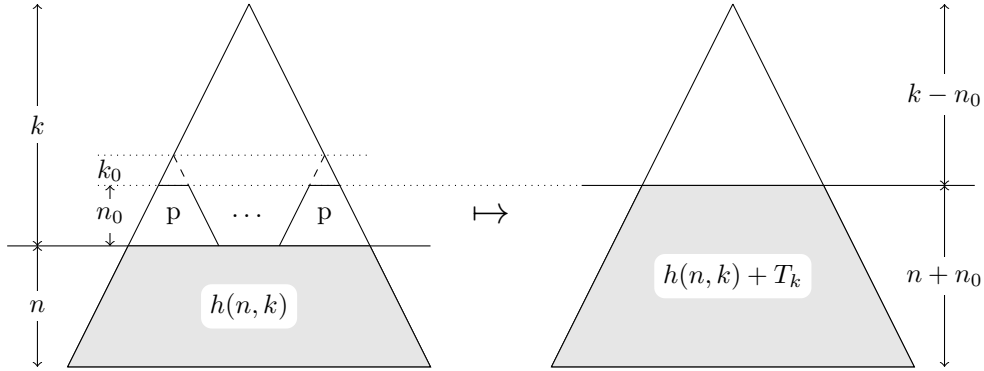

Figure 11: The first transformation: if $k > n_0 + k_0$, we add a level of factors of size n_0, k_0 that all contain exactly p ones. The size of the factor becomes $(n + n_0, k - n_0)$. We repeat the transformation until the size is (n', k') with $k' < n_0 + k_0$. In the figure, T_k stands for $pd^{k-n_0-k_0}$.

The second phase consists in building a new factor F'' by removing a factor from F' of size $n_0, k' + n' - n_0$. The removed part can be partitioned into $d^{n'-n_0-k_0}$ basic blocks. Therefore the number of ones in F'' is $h_v(F'') = h_v(F') - d^{n'-n_0-k_0}p$. This transformation is illustrated in Figure 12.

By repeating this transformation as long as $n'' > n_0 + k_0$, we get a final factor F'' whose size is (n'', k'') with $n'' < n_0 + k_0, k'' < n_0 + k_0$ and whose number of ones is $h_v(F'') = h_v(F) + H - K$, where H and K do not depend on v but only on n and k .

Since $h_v(F) = h_v(F'') - H + K$, it is enough to compute the number of ones in all factors with size (n'', k'') where $n'' < n_0 + k_0, k'' < n_0 + k_0$, to be able to obtain the number of ones in all

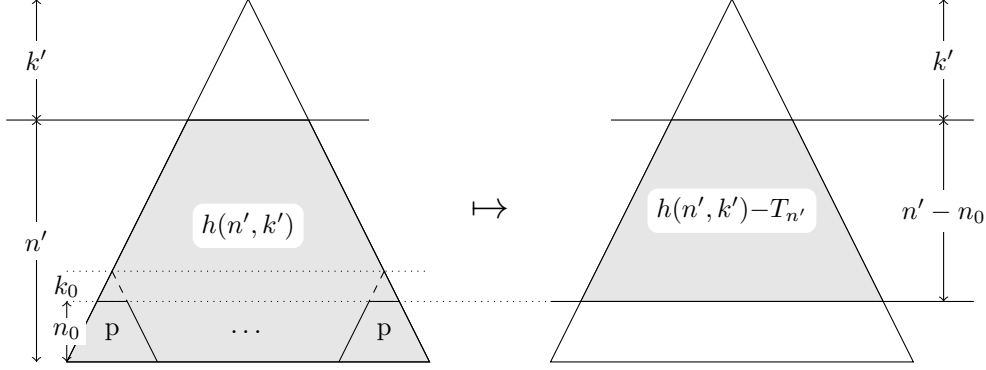

Figure 12: The second transformation: if $n' > n_0 + k_0$, we can remove a level of factors of size (n_0, k_0) . The size of the factor becomes $(n' - n_0, k')$. We repeat the transformation until the size is (n', k') with $n' < n_0 + k_0$ (here, $T_{n'} = pd^{n'-n_0-k_0}$).

factors on any size.

Also, it is enough to test if all factors with size (n'', k'') where $n'' < n_0 + k_0$, $k'' < n_0 + k_0$ satisfy the strong balance property for all factors on any size to have the same property.

There are at most n sub-trees of a given height and width. For $\ell < m$, let us call $h_{i,\ell,m}$ the number of 1 in the i^{th} sub-tree of height ℓ and width $\ell + m$. Let us call $v(i) = (v_1(i), \dots, v_d(i))$ the set of the d children of the tree i . $h_{i,\ell,m}$ can be computed using the formula:

$$h_{i,\ell,m} = \begin{cases} h_{i,1,0} & = \gamma_i \\ h_{i,\ell,0} & = \gamma_i + \sum_{j \in v(i)} h_{j,\ell-1,0} \\ h_{i,\ell,m} & = \sum_{j \in v(i)} h_{j,\ell-1,m-1} \end{cases} \quad (21)$$

These considerations yield the following algorithm 1.

Algorithm 1 Testing if a rational tree is strongly balanced

Require: Minimal graph G of a irreducible rational tree

Ensure: The tree corresponding to G is strongly balanced

N := number of vertices of G

Compute the density α of the Markov Chain

if for all k : $\frac{d^N - d^k}{d-1} \alpha \notin \mathbb{N}$ **then**

return “not strongly balanced”

end if

for $1 \leq i, n, k \leq N$ **do**

 Compute $h_{i,n,k}$ according to (21)

if $h_{i,n,k} \neq \lfloor \frac{d^n - d^k}{d-1} \alpha \rfloor$ and $h_{i,n,k} \neq \lfloor \frac{d^n - d^k}{d-1} \alpha \rfloor + 1$ **then**

return “not strongly balanced”

end if

end for

return “strongly balanced”

Solving the Markov chain to get α takes at most $O(N^3)$ operations. Writing the density under the form $\frac{p}{dN-dk}$ is linear in N and computing all $h_{i,\ell,m}$ takes $O(N^3)$ operations using the formula (21). Therefore the algorithm runs in time $O(N^3)$.

5.1.3 General case

The general case is more complicated since there can be some factors of size (n_0, k_0) with $p+1$ (or $p-1$) nodes labeled by 1. However the structure of the minimal graph of strongly balanced trees made in Section 5.1.1 can be useful.

- Indeed, the minimal graph must have only one strongly connected component and it must correspond to a strongly balanced tree.
- If the density of the strongly connected component is $\frac{p}{2^{n_0} C k_0}$, all factors of size n_0, k_0 in the strongly component have exactly p nodes labeled by 1.

Therefore, using the same techniques of reduction of the size as in Figure 11, one can show that we just have to test the balanced property for factors of size at most (n, n) where n is the number of vertices in the graph.

5.2 Counting

In this part, we address the problem of counting all possible factors of a mechanical tree. We will focus on trees of degree 2 and will compare this to the total number of possible factors of binary trees.

There are 2^n finite words of length n . Not all these words can be factors of a Sturmian words – for example 0011 can not be since it is not balanced. In fact, the number of factors of length n of Sturmian words is

$$1 + \sum_{i=1}^m (m-i+1)\phi(i) \quad (22)$$

where ϕ is the Euler function – $\phi(i)$ is the number of integers less than i and coprime with i . Asymptotically, this number is equal to m^3/π^2 .

The number a_n of unordered complete binary trees of height n satisfies the equation:

$$a_{n+1} = a_n(a_n + 1) \quad (23)$$

According to [17], there is no simple solution of this equation but using the method described in [1], one can show that a_n is the nearest integer close to $\theta^{2^n} - 1/2$, where $\theta \approx 1.597910218$ is the exponential of the rapidly convergent series $\ln(3/2) + \sum_{n \geq 0} \ln(1 + (2a_n + 1)^{-2})$.

In section 4.5, we have seen that the number of factors of size n of a Sturmian tree is the number of tuple $(f_1(\phi, \alpha), \dots, f_n(\phi, \alpha))$ where $f_i(\phi, \alpha) = \lfloor (2^n - 1)\alpha + \phi \rfloor$. Let us call u_n this number. To

Figure 13: Lines $\phi = (2^n - 1)\alpha - i$ for $n \geq 0$ and $0 \leq i < 2^n - 1$

count the number of these tuples, we draw the lines for which $(2^n - 1)\alpha - \phi \in \mathbb{N}$, (see Figure 13). The number of tuples is the number of different zones on this figure.

An exact count u_n is cumbersome to obtain but good bounds can be computed easily. $u_{n+1} - u_n$ corresponds to the number of zones added by the adding the lines $\alpha \mapsto (2^{n+1} - 1)\alpha - i$. Each of these $2^{n+1} - 1$ lines:

- at least add a new zone if it only crosses other lines at points $\phi = 0$ or $\phi = 1$. This is a very low estimate since it is only true for $i = 0$ or $i = 2^n - 2$, in the other cases it crosses at least the line $\alpha \mapsto \phi$.
- at most add $1 + n$ zones if it crosses the n lines corresponding to $\alpha \mapsto (2^j - 1)\alpha - i_j$, $1 \leq j \leq n$ and if all these points are pairwise distinct.

Therefore we have an estimation for all $n \geq 2$:

$$2 + 2(2^{n+1} - 3) \leq u_{n+1} - u_n \leq (n + 1)(2^{n+1} - 1) \quad (24)$$

This leads to the bounds for $n \geq 3$:

$$2^n \leq u_n \leq (n - 1)u_n. \quad (25)$$

Improving these bounds seems difficult. To do so, one would have to count whether a “new” intersection has already been counted or if it is on the boundary $\phi = 0$. By simulation, it seems that the number of trees is closer to $n2^n$ than to 2^n .

6 Extremal properties

In this section, we show that strongly balanced trees are extremal for certain convex cost functions that can be used in scheduling problems.

Let $g : \mathbb{R}^+ \rightarrow \mathbb{R}^+$ be a convex function. Let us assume that g has a minimum in $0 < \alpha < 1$.

For each node v and each factor of size n rooted in v , we define a cost of the factor rooted in v as a convex function of the density of ones: $d_v(n) = h_v(n)/S(n)$:

$$C_v(n) \stackrel{\text{def}}{=} g(d_v(n)).$$

We can define a cost C^k of order k of the total tree by considering all nodes in the sub tree of height ℓ rooted in r , \mathcal{A}_ℓ as the Cezaro limit:

$$C^k \stackrel{\text{def}}{=} \limsup_{\ell \rightarrow \infty} \frac{\sum_{v \in \mathcal{A}_\ell} C_v(k)}{S(\ell)}.$$

For each k , this cost is minimized when the number of 1 in a tree of height k is between $S(k)$ and $S(k)$. This means that a strongly balanced tree will minimize any increasing function of all C_k (for example the average value over all k).

This has potential applications in optimization problem in distributed systems with a binary causal structure and would generalize some results in [2].

Consider for example a scheduling problem with two processors (with related speeds u_0 and u_1) and an infinite set of tasks with a dependency pattern for forms a tree with degree d . Tasks at level k in the tree have size $1/d^k$ and are released 1 unit of time after their father.

Theorem 6.1. *Under the ongoing assumptions, there exists an optimal density $\alpha \in (0, 1)$ such that a strongly balanced tree with density α is the optimal allocation of tasks to processors 0 and 1, in terms of average flowtime.*

Proof. (sketch) First, one should notice that at each second a load of one unit of work arrives in the system. Also note that every second, the allocation pattern forms a balanced sequence prefix with density α . Finally, up to level k , all tasks can be seen as clusters of tasks of size $1/d^k$.

In [2], it is shown that the optimal allocation (for the average flow time) when tasks come in clusters of size m (for any m) is a balanced sequence over the clusters.

Using a diagonal process over all sizes of clusters that up to level k show that strongly balanced trees are optimal up to level k . This is true for any k .

The end of the proof comes from taking the limit when k goes to infinity. □

Note that an arrival pattern that forms a tree of degree d may arise when tasks are generated by a recursive program. Actually, this result can be generalized to more general arrival patterns. If tasks at level k in the tree are released after iid stochastic times (with an arbitrary distribution but expectation equal to one), yet again an allocation of the tasks to processors 0 and 1 according to a strongly balanced tree is optimal, however the proof of this result is beyond the scope of this paper.

7 Glossary

The aim of this part is to give the big picture and to provide several examples of trees that are either balanced, strongly balanced, reducible, irreducible, rational or Sturmian. In particular, we will give counter-examples that shows that the inclusions between these notions are strict. The Figure 14 illustrates these results.

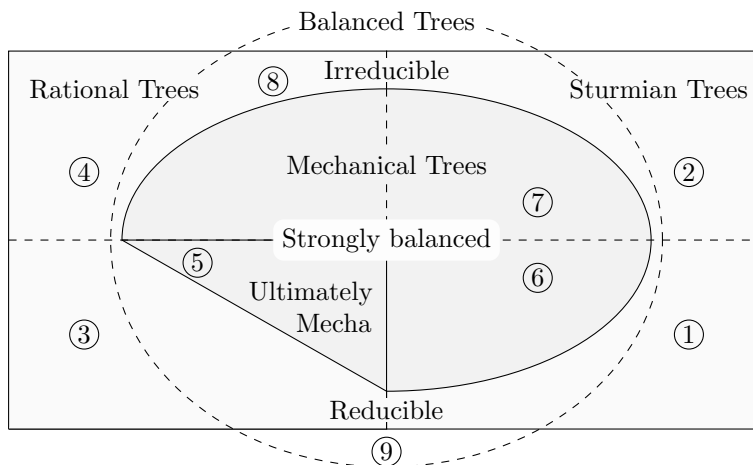

Figure 14: Relations of inclusion linking the different definitions that we presented. Each number refers to an example detailed in section 7. For example 5 is the set of trees that are rational, reducible, ultimately mechanical, strongly balanced, balanced and neither mechanical nor Sturmian.

1. *Reducible Sturmian tree that is not balanced* – contrarily to the case of words where Sturmian words are balanced, there exist Sturmian trees that are not balanced. The Dyck tree, see Figure 3, is one of them.
2. *Irreducible Sturmian trees that are not balanced* – An example of a Sturmian tree that is irreducible (but not balanced) is the *reflected random walk* tree represented in Figure 15. It is Sturmian since the equivalence classes of the relation \equiv_n are $\{0\}, \dots, \{n-1\}, \{n, n+1, \dots\}$.

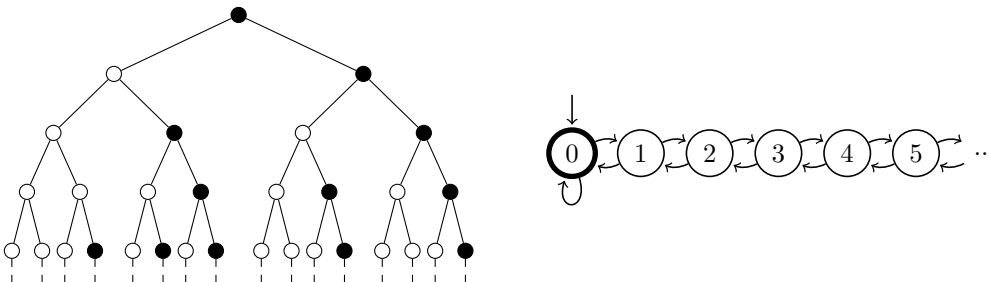

Figure 15: The reflected random walk tree: each node of type n is followed by one of type $n-1$ and one of type $n+1$ (except for 0 that is followed by 0 and 1).

3. *Irreducible rational trees* – see Figure 6.
4. *Reducible rational trees* – see Figure 5.
5. *Rational reducible strongly balanced tree that is not mechanical* – strongly balanced tree are not necessarily mechanical in the case of reducible rational trees but only ultimately mechanical, see Figure 8 for an example.
6. *Reducible mechanical trees* – let α be a normal number and consider the mechanical tree of density α and phase 0 at the root. As α is normal, there is a unique phase corresponding to each node of order k which is the fractional part of:

$$\alpha \left(\frac{1}{d^k} + \dots + \frac{1}{d} \right) + \frac{i_k}{d^k} + \dots + \frac{i_1}{d} \quad (26)$$

for a unique sequence i_1, \dots, i_k . One can show that if two sequences of i_1, \dots, i_k are different, then these phases are different, which shows that the minimal graph of the tree is exactly the tree itself.

7. *Irreducible mechanical trees* – let w be a mechanical word and consider a graph with vertices $\{0, 1, \dots\}$, where a node $i \geq 0$ has label one if and only if $w_i = 1$. The node i has two outgoing arcs: one ending in $i+1$, one ending in 0. We call this graph a *restart tree* since for a node n , we have the choice between restarting back in 0 or continuing in $n+1$, an example is displayed in Figure 16.

As seen in Figure 17, the number of ones in a factor of size n that corresponds to the node i is

$$h_i(n) = w_i + \dots + w_{i+n-1} + h_0(n-1) + \dots + h_0(1), \quad (27)$$

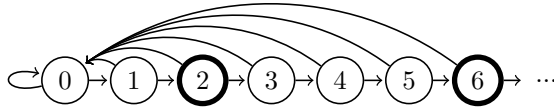

Figure 16: Example of the restart tree corresponding to the word $ababaaab\dots$

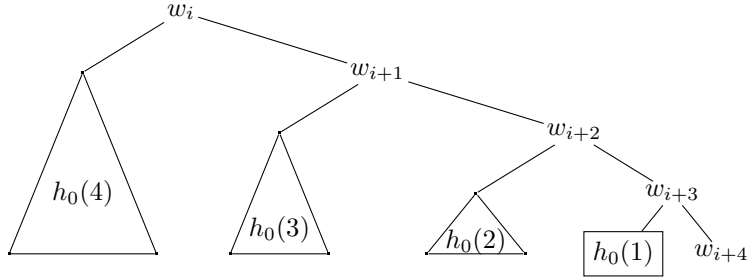

Figure 17: Number of ones in a factor of the restart tree of size 5

and the number of ones in a factor of size n and width k is

$$h_i(n, k) = h_i(n) - h_i(k) = w_k + \dots + w_{i+n-1} + h_0(n-1) + \dots + h_0(k). \quad (28)$$

Therefore the tree is strongly balanced if and only if the word w is balanced. Since the tree is irreducible, in that case the tree is also mechanical. Moreover we can show that for any word w the tree has a density which is $\lim_{n \rightarrow \infty} \frac{h_0(n)}{2^{n-1}} = \frac{w_0}{2} + \frac{w_1}{4} + \frac{w_2}{8} + \dots$.

Thus for any aperiodic balanced word, this gives us an example of irreducible irrational strongly balanced tree.

8. *Rational balanced tree that is not strongly balanced* – An example of rational trees balanced but not strongly balanced is presented in Figure 18. One can show that all of its factors of size 3 have exactly 4 nodes of label one. Using this fact, one can show that the number of ones in a factor of size $3n + i$ ($0 \leq i \leq 3$) rooted in a node j is:

Size	Node 1	Node 2	Node 3	Node 4
$3n$	$4 \frac{8^n - 1}{7}$	$4 \frac{8^n - 1}{7}$	$4 \frac{8^n - 1}{7}$	$4 \frac{8^n - 1}{7}$
$3n + 1$	$1 + 2 \cdot 4 \frac{8^n - 1}{7}$	$0 + 2 \cdot 4 \frac{8^n - 1}{7}$	$0 + 2 \cdot 4 \frac{8^n - 1}{7}$	$1 + 2 \cdot 4 \frac{8^n - 1}{7}$
$3n + 2$	$1 + 4 \cdot 4 \frac{8^n - 1}{7}$	$1 + 4 \cdot 4 \frac{8^n - 1}{7}$	$2 + 4 \cdot 4 \frac{8^n - 1}{7}$	$2 + 4 \cdot 4 \frac{8^n - 1}{7}$

This shows that the tree is balanced. It is not strongly balanced since there are factors of size (1,1) with 2 nodes labeled by one and others with 0 nodes labeled by one as seen in the bottom right part of figure 18. Also its minimal graph is not isomorphic to the unique minimal graph of a mechanical tree of density $4/7$ that has only 3 nodes (see the discussion about graphs of strongly balanced tree section 5.1.1).

9. *Irrational balanced tree that is not strongly balanced* – Building an irrational tree not strongly balanced requires more work. We consider a tree that which has a root r labeled by 0 and

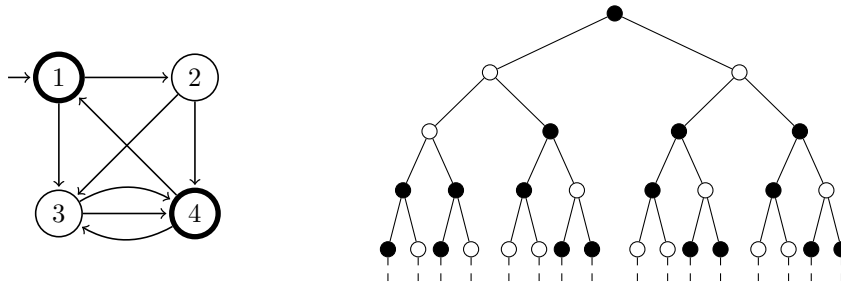
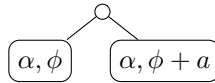

Figure 18: A Rational Balanced Tree that is not strongly balanced

two children that are mechanical trees of density α and respective phases ϕ and $\phi + a$. We will see that under some conditions on α, ϕ and a this will give us an example of an irrational tree that is balanced but not strongly balanced neither rational nor Sturmian.



The two children of the root are balanced trees which means that the tree is balanced if and only if for all n :

$$\lfloor (2^{n+1} - 1)\alpha \rfloor \leq h_r(n+1) \leq \lfloor (2^{n+1} - 1)\alpha \rfloor + 1 \quad (29)$$

Let us call $k = \lfloor (2^n - 1)\alpha + \phi \rfloor$ and $x = \text{frac}((2^n - 1)\alpha + \phi)$.

$$\begin{aligned} h_r(n+1) &= \lfloor (2^n - 1)\alpha + \phi \rfloor + \lfloor (2^n - 1)\alpha + \phi + a \rfloor \\ &= k + \lfloor k + x + a \rfloor \end{aligned}$$

As $(2^{n+1} - 1)\alpha = 2k + 2x + \alpha - 2\phi$, the equation 29 holds if for all $x \in [0; 1)$, we have:

$$0 \leq k + \lfloor k + x + a \rfloor - \lfloor 2k + 2x + \alpha - 2\phi \rfloor \leq 1$$

which holds if for all $x \in [0; 1)$:

$$0 \leq \lfloor x + a \rfloor - \lfloor 2x + \alpha - 2\phi \rfloor \leq 1$$

This equation is satisfied if and only if

$$(x + a < 1 \text{ and } -1 \leq 2x - 2\phi + \alpha < 1) \text{ or } (x + a \geq 1 \text{ and } 0 \leq 2x - 2\phi + \alpha < 2)$$

Looking at the extremal cases for $x + a < 1$ and $x + a \geq 1$ which are $x = 0, 1 - a, 1$, one gets 4 relations:

$$\begin{aligned} 2(1 - a) - 2\phi + \alpha &< 1 \\ -1 &\leq -2\phi + \alpha \\ 2 - 2\phi + \alpha &< 2 \\ 0 &\leq 2(1 - a) - 2\phi + \alpha. \end{aligned}$$

Therefore the tree is balanced if and only if

$$\frac{\alpha}{2} < \phi \leq \frac{\alpha+1}{2} < \phi + a < 1. \quad (30)$$

Moreover if $\alpha + \phi \geq 1$ and $3\alpha + \phi < 2$, the tree is not strongly balanced since its beginning is

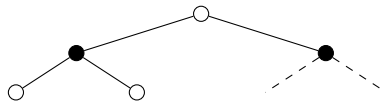

There are lots of triples α, ϕ, a satisfying conditions (30). For example a tree with $\alpha = \frac{1}{3} + \epsilon$, $\phi = 0.6$ and $a = 0.2$ where $\epsilon \in \mathbb{R} \setminus \mathbb{Q}$ with ϵ small enough (for example $\epsilon < 0.01$ works since $\frac{\alpha}{2} \approx 0.21 < 0.6 < \frac{\alpha+1}{2} \approx 0.71 \leq 0.8 < 1$ and $\alpha + \phi > 1$, $3\alpha + \phi \approx 1.9 < 2$).

References

- [1] A.V. Aho and N.J.A. Sloane. Some doubly exponential sequences. *Fibonacci Quarterly*, 11(4):429–437, 1973.
- [2] E. Altman, B. Gaujal, and A. Hordijk. *Discrete-Event Control of Stochastic Networks: Multimodularity and Regularity*. Number 1829 in LNM. Springer-Verlag, 2003.
- [3] J. Berstel. Sturmian and episturmian words (a survey of some recent result results). In G. Rahonis S. Bozpalidis, editor, *Conference on Algebraic Informatics*, Lecture Notes Comput. Sci. 4728, pages 23–47, 2007.
- [4] J. Berstel, L. Boasson, O. Carton, and I. Fagnot. A First Investigation of Sturmian Trees. *LECTURE NOTES IN COMPUTER SCIENCE*, 4393:73, 2007.
- [5] E. Borel. Lesprobabilites denombrables et leurs applications arithmetiques. *Rend. Circ. Mat. Palermo*, 27:247–271, 1909.
- [6] J. Cassaigne. Double sequences with complexity $mn+1$. *J. Autom. Lang. Comb.*, 4(3):153–170, 1999.
- [7] R. Durrett. *Probability: theory and examples*. Wadsworth & Brooks/Cole, 1991.
- [8] T. Fernique. *Pavages, Fractions continues et géométrie discrète*. PhD thesis, University of Montpellier, 2007.
- [9] Nicolas Gast and Bruno Gaujal. Balanced labeled trees: density, complexity and mechanicity. In *Words, 6th international conference on words*, Marseille, France, 2007.
- [10] B. Gaujal, A. Hordijk, and D. Van der Laan. On the optimal open-loop control policy for deterministic and exponential polling systems. *Probability in Engineering and Informational Sciences*, 21:157–187, 2007.
- [11] B. Gaujal and E. Hyon. Optimal routing policy in two deterministic queues. *Calculateurs Parallèles*, 2001.

- [12] B. Hajek. Extremal splittings of point processes. *Mathematics of Operation Research*, 10(4):543–556, 1985.
- [13] R. Klette and A. Rosenfeld. Digital straightness- a review. *Discrete Appl. Math.*, 139:197–230, 2004.
- [14] M. Lothaire. *Algebraic combinatorics on words*. Cambridge University Press New York, 2002.
- [15] E. Luks. Isomorphism of graphs of bounded valence can be tested in polynomial time. *Journal of Computer and System Sciences*, 25:42–65, 1982.
- [16] M. Morse and G.A. Hedlund. Symbolic dynamics ii. sturmian trajectories. *Amer. J. Math.*, 62:1–42, 1940.
- [17] N.J.A. Sloane et al. The On-Line Encyclopedia of Integer Sequences, 2003.