

Linear Time Encoding of LDPC Codes

Jin Lu and José M. F. Moura, *Fellow, IEEE*

Abstract

In this paper, we propose a linear complexity encoding method for arbitrary LDPC codes. We start from a simple graph-based encoding method “label-and-decide.” We prove that the “label-and-decide” method is applicable to Tanner graphs with a hierarchical structure—pseudo-trees— and that the resulting encoding complexity is linear with the code block length. Next, we define a second type of Tanner graphs—the encoding stopping set. The encoding stopping set is encoded in linear complexity by a revised label-and-decide algorithm—the “label-decide-recompute.” Finally, we prove that any Tanner graph can be partitioned into encoding stopping sets and pseudo-trees. By encoding each encoding stopping set or pseudo-tree sequentially, we develop a linear complexity encoding method for general LDPC codes where the encoding complexity is proved to be less than $4 \cdot M \cdot (\bar{k} - 1)$, where M is the number of independent rows in the parity check matrix and \bar{k} represents the mean row weight of the parity check matrix.

Index Terms

LDPC codes, linear complexity encoding, pseudo-tree, encoding stopping set, Tanner graphs.

Jin Lu

Sun Microsystems

1, StorageTek Drive, Louisville, CO 80026

Ph: +(303) 661-6961 Fax:+(303) 673-2431

Email: j.lu@sun.com

José M. F. Moura

Department of Electrical and Computer Engineering

Carnegie Mellon University, Pittsburgh, PA 15213

Ph: +(412) 268-6341 Fax:+(412) 268-3890

Email: moura@ece.cmu.edu

I. INTRODUCTION

Low Density Parity Check (LDPC) codes [1] are excellent error correcting codes with performance close to the Shannon Capacity [2]. The key weakness of LDPC codes is their apparently high encoding complexity. The conventional way to encode LDPC codes is to multiply the data words \vec{s} by the code generator matrix \mathbf{G} , i.e., the code words are $\vec{x} = \mathbf{G} \cdot \vec{s}$. Though the parity-check matrix \mathbf{H} for LDPC codes is sparse, the associated generator matrix \mathbf{G} is not. The encoding complexity of LDPC codes is $\mathcal{O}(n^2)$ where n is the block length of the LDPC code. For moderate to high code block length n , this quadratic behavior is very significant and it severely affects the application of LDPC codes. For example, LDPC codes have advantages over turbo codes [3] in almost every aspect except that LDPC codes have $\mathcal{O}(n^2)$ encoding complexity, while turbo codes have $\mathcal{O}(n)$ encoding complexity. It is highly desirable to reduce the $\mathcal{O}(n^2)$ encoding complexity of LDPC codes.

Several authors have addressed the issue of speeding encoding of LDPC codes and, largely speaking, they follow three different paths. The first path designs efficient encoding methods for particular types of LDPC codes. We list a few typical representers. Reference [4] proposes a linear complexity encoding method for cycle codes—LDPC codes with column weight 2. Reference [5] presents an efficient encoder for quasi-cyclic LDPC codes. In [6], an efficient encoding approach is proposed for Reed-Solomon-type array codes. Reference [7] shows that there exists a linear time encoder for turbo-structured LDPC codes. Reference [8] constructs LDPC codes based on finite geometries and proves that this type of structured LDPC codes can be encoded in linear time. In [9], [11], two families of irregular LDPC Codes with cyclic structure and low encoding complexity are designed. In addition, an approximately lower triangular ensemble of LDPC Codes [10] was proposed to facilitate almost linear complexity encoding. The above low complexity encoders are only applicable to a small subset of LDPC codes, and some of the LDPC codes discussed above have performance loss when compared to randomly constructed LDPC codes. The second path borrows the decoder architecture and encodes LDPC codes iteratively on their Tanner graphs [12], [13]. The iterative LDPC encoding algorithm is easy to implement. However, there is no guarantee that iterative encoding will successfully get the codeword. In particular, the iterative encoding method will get trapped at the stopping set. The third path utilizes the sparseness of the parity check matrix to design a low complexity encoder. In [14],

the authors present an algorithm named “greedy search” that reduces the coefficient of the quadratic term. This encoding method is relatively efficient. Its computation complexity and matrix storage need to be further reduced for most practical applications.

In this paper, we develop an *exact* linear complexity encoding method for arbitrary LDPC codes. We start from two particular Tanner graph structures—“pseudo-tree” and “encoding stopping set”—and prove that both the pseudo-tree and the encoding stopping set LDPC codes can be encoded in linear time. Next, we prove that any LDPC code with maximum column weight three can be decomposed into pseudo-trees and encoding stopping sets. Therefore, LDPC codes with maximum column weight three can be encoded in linear time and the encoding complexity is no more than $2 \cdot M \cdot (\bar{k} - 1)$ where M denotes the number of independent rows of the parity check matrix and \bar{k} represents the average row weight. Finally, we extend the $\mathcal{O}(n)$ complexity encoder to LDPC codes with arbitrary row weight distributions and column weight distributions. For arbitrary LDPC codes, we achieve $\mathcal{O}(n)$ encoding complexity, not exceeding $4 \cdot M \cdot (\bar{k} - 1)$.

The remaining of the paper is organized as follows. In Section II, we introduce relevant definitions and notation. Section III proposes a simple encoding algorithm “label-and-decide” that directly encodes an LDPC code on its Tanner graph. Section IV presents a particular type of Tanner graph with multi-layers—“pseudo-tree” and proves that any pseudo-tree can be encoded successfully in linear time by the label-and-decide algorithm. Section V studies the complement of the pseudo-tree—“encoding stopping set.” Section VI proves that the encoding stopping set can also be encoded in linear time by an encoding method named “label-decide-recompute.” Section VII demonstrates that any LDPC code with column weight at most three can be decomposed into pseudo-trees and encoding stopping sets. By encoding each pseudo-tree or encoding stopping set sequentially using the label-and-decide or the label-decide-recompute algorithms, we achieve linear complexity encoding for LDPC codes with maximum column weight three. Finally, we extend in this Section this linear time encoding method to LDPC codes with arbitrary column weight distributions and row weight distributions. Section VIII concludes the paper.

II. NOTATION

LDPC codes. LDPC codes can be described by their parity-check matrix or their associated Tanner graph [15]. In the Tanner graph, each bit becomes a bit node and each parity-check

constraint becomes a check node. If a bit is involved in a parity-check constraint, there is an edge connecting the bit node and the corresponding check node. The degree of a check node in a Tanner graph is equivalent to the number of one's in the corresponding row of the parity check matrix, or, in another words, the row weight of the corresponding row. We will use the term “degree of a check node” and “row weight” interchangeably in this paper. Similarly, the degree of a bit node in a Tanner graph is equivalent to the column weight of the corresponding column of the parity check matrix, and we will interchangeably use the term “degree of a bit node” and “column weight” in this paper. The LDPC codes discussed in this paper may be irregular, i.e., different columns of the parity check matrix have different column weights and different rows of the parity check matrix have different row weights. The parity check matrix of an LDPC code may not be of full rank. If a row in the parity check matrix can be written as the binary sums of some other rows in the parity check matrix, this row is said to be *dependent* on the other rows. Otherwise, it is an *independent* row.

Arithmetic over the binary field. We represent by “ \oplus ” the summation over the binary field, i.e., an XOR operation. For example, $0 \oplus 1 = \text{mod}(0+1, 2) = 1$. Similarly, we have $0 \oplus 0 = 0$, $1 \oplus 0 = 1$, $1 \oplus 1 = 0$. In addition, we have the following equation $-x = x$ in the binary field.

Generalized parity check equation. A conventional parity check equation is shown in (1). The right-hand side of the parity check equation is always 0.

$$x_1 \oplus x_2 \oplus \dots \oplus x_k = 0 \quad (1)$$

In this paper, we define the *generalized parity check equation*, as shown in (2)

$$x_1 \oplus x_2 \oplus \dots \oplus x_k = b \quad (2)$$

On the right-hand side of equation (2), b is a constant that can be either 0 or 1.

Let C be a standard parity check equation. If the values of some of the bits in the left-hand side of C are already known, then C can be equivalently rewritten as a generalized parity check equation. For example, if the values of the bits $x_{p+1}, x_{p+2}, \dots, x_k$ are known, we move these bits from the left-hand side of equation (1) to its right-hand side and rewrite it as follows.

$$x_1 \oplus x_2 \oplus \dots \oplus x_p = x_{p+1} \oplus x_{p+2} \oplus \dots \oplus x_k = b \quad (3)$$

Let C_1, C_2, \dots, C_p be p generalized parity check equations, as shown in (4)

$$\begin{aligned} C_1 &: x_{1,1} \oplus x_{1,2} \oplus \dots \oplus x_{1,a_1} = b_1 \\ C_2 &: x_{2,1} \oplus x_{2,2} \oplus \dots \oplus x_{2,a_2} = b_2 \\ &\vdots \qquad \qquad \qquad \vdots \qquad \qquad \qquad \vdots \\ C_p &: x_{p,1} \oplus x_{p,2} \oplus \dots \oplus x_{p,a_p} = b_p \end{aligned} \quad (4)$$

We say C_1, C_2, \dots, C_p are dependent on each other if the corresponding homogeneous equations in (5) are dependent on each other.

$$\begin{aligned} x_{1,1} \oplus x_{1,2} \oplus \dots \oplus x_{1,a_1} &= 0 \\ x_{2,1} \oplus x_{2,2} \oplus \dots \oplus x_{2,a_2} &= 0 \\ \vdots \qquad \qquad \qquad \vdots \qquad \qquad \qquad \vdots &\vdots \\ x_{p,1} \oplus x_{p,2} \oplus \dots \oplus x_{p,a_p} &= 0 \end{aligned} \quad (5)$$

From equations (4) and (5), we derive that

$$b_1 \oplus b_2 \oplus \dots \oplus b_p = 0 \quad (6)$$

when the p generalized parity check equations C_1, C_2, \dots, C_p are dependent on each other.

Connected graph. A graph is *connected* if there exists a path from any vertex to any other vertices in the graph. If a graph is not connected, we call it a *disjoint* graph.

Relative complement of a subgraph \mathcal{S} in a Tanner graph \mathcal{G} . Let \mathcal{G} be a Tanner graph and \mathcal{S} be a subgraph of \mathcal{G} , i.e., $\mathcal{S} \subset \mathcal{G}$. We use the symbol $\mathcal{G} \setminus \mathcal{S}$ to denote the subgraph that contains the nodes and edges in \mathcal{G} , but not in \mathcal{S} . For example, let C_1, C_2, \dots, C_k be k check nodes in a Tanner graph \mathcal{G} . The subgraph $\mathcal{G} \setminus \{C_1, C_2, \dots, C_k\}$ represents the remaining graph after deleting check nodes C_1, C_2, \dots, C_k from \mathcal{G} . Assume $\mathcal{G}_1, \mathcal{G}_2, \dots, \mathcal{G}_k$ are k subgraphs in a Tanner graph \mathcal{G} . The notation $\mathcal{G} \setminus \{\mathcal{G}_1 \cup \mathcal{G}_2 \cup \dots \cup \mathcal{G}_k\}$ represents the subgraph where nodes and edges are in \mathcal{G} , but not in \mathcal{G}_i , $1 \leq i \leq k$.

III. “LABEL-AND-DECIDE” ENCODING ALGORITHM

Initially, Tanner graphs [15] were developed to explain the decoding process for LDPC codes; in fact, they can be used for the encoding of LDPC codes as well [12]. To encode an LDPC code using its Tanner graph, we identify information bits and parity bits through a labeling process on the graph. After determining the information bits and the parity bits, we start by assigning numerical values to the bit nodes labeled as information bits and then in a second step, calculate

the missing values of the parity bits sequentially. This encoding approach is named *label-and-decide*. It is described in Algorithm 1.

Algorithm 1 Label-and-decide algorithm

Preprocessing (carry out only once):

Label every bit node either as information bit or parity bit on the Tanner graph.

Encoding:

$Flag \leftarrow 0$;

Get the values of all the bits labeled as information bits;

while there are parity bits undetermined **do**

if there exists one undetermined parity bit x that can be uniquely computed from the values of the information bits and the already determined parity bits **then**

 Compute the value of x .

else

$Flag \leftarrow 1$, exit the while loop.

end if

end while

if $Flag = 1$ **then**

 Encoding is unsuccessful.

else

 Output the encoded codeword.

end if

Example. Figure 1 shows on the left an LDPC code whose Tanner graph is a tree. Initially, all its bit nodes are unlabeled. First, we randomly pick bit nodes x_1 , x_2 , and x_3 to be information bits. According to the parity check equation C_1 , the value of bit x_4 depends on the values of the bits x_1 , x_2 , and x_3 such that $x_4 = x_1 \oplus x_2 \oplus x_3$. Therefore, x_4 should be labeled as a parity bit. Similarly, we label bits x_5 , x_6 , x_8 , x_9 as information bits and label bits x_7 , x_{10} as parity bits. We represent information bits by solid circles and parity bits by empty circles. The labeling result is shown on the right in Figure 1.

By the above labeling process, we decide the systematic component of the code word $\vec{x} =$

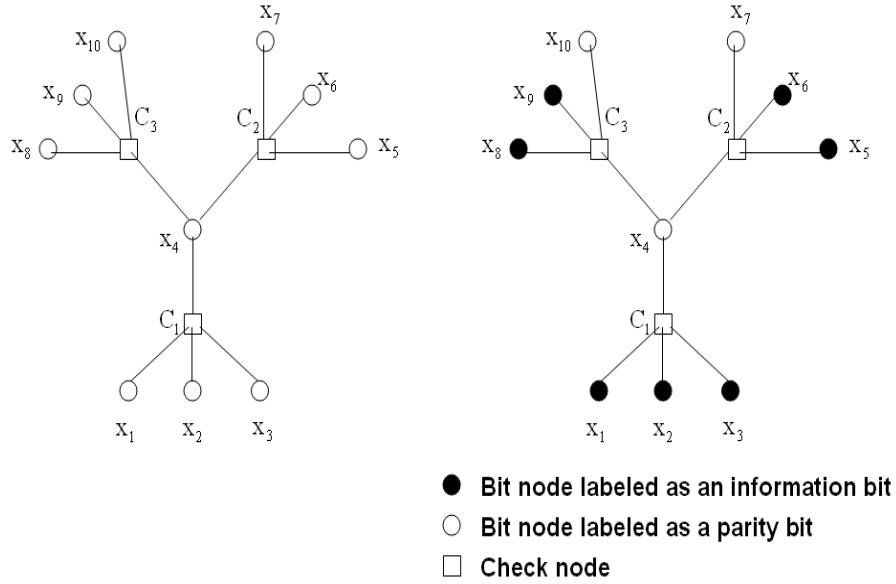

Fig. 1. Left: A Tanner graph. Right: Labeling bit nodes on the Tanner graph shown on the left.

$(x_1 \ x_2 \ x_3 \ x_4 \ x_5 \ x_6 \ x_7 \ x_8 \ x_9 \ x_{10})$ to be $\vec{s} = (x_1 \ x_2 \ x_3 \ x_5 \ x_6 \ x_8 \ x_9)$ and the parity component to be $\vec{p} = (x_4 \ x_7 \ x_{10})$. The label-and-decode encoding on the code in Figure 1 then has the following steps:

- Step 1. Get the values of the information bits $x_1, x_2, x_3, x_5, x_6, x_8,$ and x_9 from the encoder input;
- Step 2. Compute the parity bit x_4 from the parity check equation $C_1 : x_4 = x_1 \oplus x_2 \oplus x_3$;
- Step 3. Compute the parity bit x_7 from the parity check equation $C_2 : x_7 = x_4 \oplus x_5 \oplus x_6$; compute the parity bit x_{10} from the parity check equation $C_3 : x_{10} = x_4 \oplus x_8 \oplus x_9$.

In fact, any tree code (whose Tanner graph is cycle-free) can be encoded in linear complexity by the label-and-decode algorithm. We will prove this fact in Corollary 2 in Section V. Further, the label-and-decode algorithm can be used to encode a particular type of Tanner graphs with cycles, i.e., the pseudo-tree we propose in the next section.

IV. PSEUDO-TREE

A *pseudo-tree* is a connected Tanner graph that satisfies the following conditions (A1) through (A4).

- (A1) It is composed of $2P + 1$ tiers where P is a positive integer. We number these tiers from 1 to $2P + 1$, starting from the top. The $(2i - 1)$ -th tier ($i = 1, 2, \dots, P + 1$) contains only bit nodes, while the $(2i)$ -th tier ($i = 1, 2, \dots, P$) contains only check nodes.

- (A2) Each bit node in the first tier has degree one and is connected to one and only one check node in the second tier.
- (A3) For each check node C_α in the $(2i)$ -th tier, where i can take any value from 1 to P , there is one and only one bit node x_α in the $(2i - 1)$ -th tier (immediate upper tier) that connects to C_α , and there are no other bit nodes in the upper tiers that connect to C_α . We call x_α the *parent* of C_α and C_α the *child* of x_α .
- (A4) For each bit node x_β in the $(2i - 1)$ -th tier, where i can take any value from 2 to P , there is at most one check node C_β in the $(2i)$ -th tier (immediate lower tier) that connects to x_β , and there are no other check nodes in the lower tiers that connect to x_β .

For example, Figure 2 shows a pseudo-tree with seven tiers. It contains many cycles. Each check node C_i in the pseudo-tree is connected to a unique bit node in the immediate upper tier, while each bit node x_i in the pseudo-tree may connect to multiple check nodes in the upper tiers.

An important characteristic of a pseudo-tree is that it can be encoded in linear complexity by the label-and-decide algorithm. This is proved in the following lemma.

Lemma 1 *Any LDPC code whose Tanner graph is a pseudo-tree is linear time encodable.*

Proof: Let a pseudo-tree contain $2P + 1$ tiers, N bit nodes, and M check nodes. Condition (A3) guarantees that each check node is connected to one and only one parent bit node in the immediate upper tier. Condition (A4) guarantees that different check nodes are connected to different parent bit nodes. Therefore, there are M parent bit nodes for the check nodes. We label these M parent bit nodes as parity bits and the other $N - M$ bit nodes as information bits.

The inputs of the encoder provide the values for all the information bits. The task of the encoder is to compute the values for all the parity bits. Let x_α be an arbitrary parity bit in the $(2i - 1)$ -th tier. By conditions (A3) and (A4), there is only one check node C_α in the lower tiers that connects to x_α . The value of x_α is uniquely determined by the parity check equation represented by C_α . According to condition (A3), all the bit nodes constrained by C_α except for x_α are in tiers below the $(2i - 1)$ -th tier. Therefore, the value of x_α depends only on the values of the bit nodes below the $(2i - 1)$ -th tier. For example, as shown in Figure 2, parity bit x_9 is the parent bit node of the check node C_6 . From the parity check equation C_6 , we see that the value of x_9 is computed from the values of x_{11} , x_{12} , x_{16} , and x_{13} , which are located

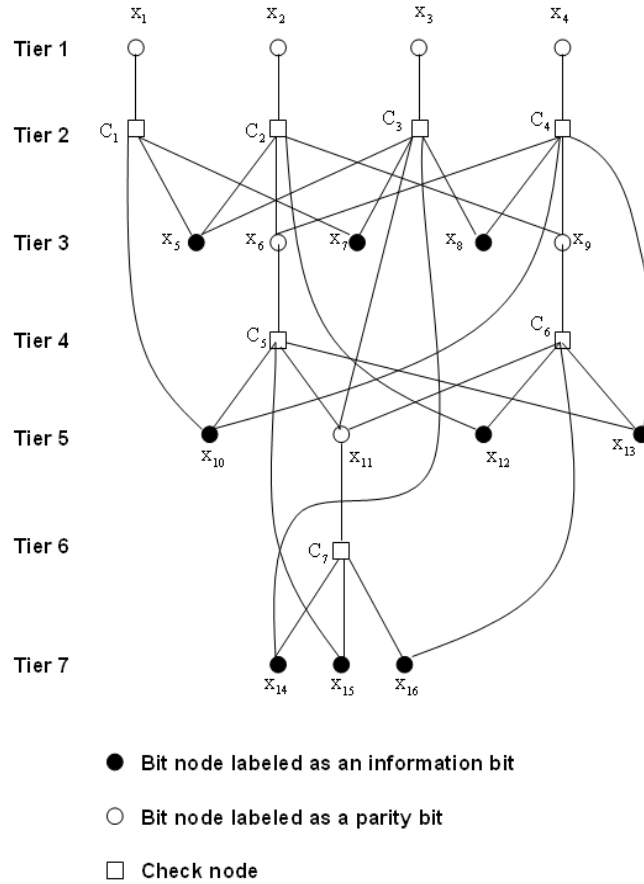

Fig. 2. A pseudo-tree.

below x_9 . We compute the values of the parity bits tier by tier, starting from the $(2P - 1)$ -th tier (bottom tier) and then progressing upwards. Each time we compute the value of a parity bit, we only need the values of those bits (both information bits and parity bits) in lower tiers, which are already known. Hence, this encoding process can proceed. The encoding process is repeated until the values of all the parity bits in the first tier are known.

We evaluate the computation complexity of the above encoding process. Let $k_i, i = 1, 2, \dots, M$, denote the number of bits contained in the i -th parity check equation. The i -th parity check equation determines the value of a parity bit with $(k_i - 2)$ XOR operations. So, $\sum_{i=1}^M (k_i - 2)$ XOR operations are required to obtain all the M parity bits. Let $\bar{k} = \frac{1}{M} \sum_{i=1}^M k_i$ denote the average number of bits in the M parity check equations, then the encoding complexity is $\mathcal{O}(M(\bar{k} - 2))$. For LDPC codes with uniform row weight k , the encoding complexity is $\mathcal{O}(M(k - 2))$. The

above analysis shows that the encoding process is accomplished in linear time. This completes the proof. \square

We look at an example. We encode the pseudo-tree in Figure 2 as follows:

- Step 1. Determine the values of all the information bits $x_{14}, x_{15}, x_{16}, x_{10}, x_{12}, x_{13}, x_5, x_7$, and x_8 ;
- Step 2. Compute the parity bit x_{11} from the parity check equation $C_7 : x_{11} = x_{14} \oplus x_{15} \oplus x_{16}$;
- Step 3. Compute the parity bit x_6 from the parity check equation $C_5 : x_6 = x_{10} \oplus x_{15} \oplus x_{11} \oplus x_{13}$;
compute the parity bit x_9 from the parity check equation $C_6 : x_9 = x_{11} \oplus x_{12} \oplus x_{16} \oplus x_{13}$;
- Step 4. Compute the parity bits x_1, x_2, x_3 , and x_4 in the first tier by the parity check equations C_1, C_2, C_3 , and C_4 respectively: $x_1 = x_{10} \oplus x_5 \oplus x_7$, $x_2 = x_5 \oplus x_6 \oplus x_{12} \oplus x_9$, $x_3 = x_5 \oplus x_7 \oplus x_{11} \oplus x_{14} \oplus x_8$, $x_4 = x_6 \oplus x_8 \oplus x_{10} \oplus x_9 \oplus x_{13}$.

The above encoding process requires only 21 XOR operations.

V. ENCODING STOPPING SET

An *encoding stopping set* in a Tanner graph is a connected subgraph such that:

- (B1) If a check node C is in an encoding stopping set, then all its associated bit nodes and the edges that are incident on C are also in the encoding stopping set.
- (B2) Any bit node in an encoding stopping set is connected to at least two check nodes in the encoding stopping set.
- (B3) All the check nodes included in an encoding stopping set are independent of each other, i.e., any parity check equation can not be represented as the binary sums of other parity check equations.

The number of check nodes in an encoding stopping set is called its size. If a connected Tanner graph satisfies conditions (B1) and (B2) but not condition (B3), we call this Tanner graph a *pseudo encoding stopping set*. For example, the Tanner graph shown in Figure 3 is not an encoding stopping set but a pseudo encoding stopping set since it satisfies conditions (B1) and (B2) but not condition (B3). The Tanner graph shown in Figure 4 is an encoding stopping set. Its size is 9. Every bit node in this encoding stopping set has degree greater than or equal to 2, and every check node is independent of each other. Please note that the “encoding stopping set” defined in this paper is different from the “stopping set” defined in [16]. Stopping sets are used for the finite-length analysis of LDPC codes on the binary erasure channel, while encoding stopping sets are used here to develop efficient encoding methods for LDPC codes. From the

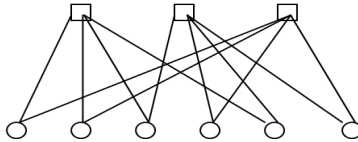

Fig. 3. A pseudo encoding stopping set.

above definitions of pseudo-tree and encoding stopping set, we have the following lemma.

Lemma 2 *Any pseudo-tree or union of pseudo-trees does not contain encoding stopping sets.*

The proof of Lemma 2 is straightforward. We omit it here.

We will show next that the label-and-decide algorithm can not successfully encode encoding stopping sets.

Theorem 1 *An encoding stopping set can not be encoded successfully by the label-and-decide algorithm.*

Proof: Let \mathcal{E}_f be an encoding stopping set and suppose \mathcal{E}_f can be encoded successfully by the label-and-decide algorithm. Let x_α be the last parity bit being determined during the encoding process. Since \mathcal{E}_f is an encoding stopping set, x_α is connected to at least two check nodes C_β and C_γ by condition (B2). Further, by condition (B3), all the check nodes in \mathcal{E}_f , including C_β and C_γ , are independent of each other. Hence, for certain encoder inputs, C_β and C_γ provide different values for the parity bit x_α . This contradicts the fact that every parity bit can be uniquely determined successfully by the label-and-decide algorithm. Hence, the label-and-decide algorithm can not encode an encoding stopping set. This completes the proof. \square

Conversely, if a Tanner graph does not contain any encoding stopping set, there must exist a linear complexity encoder for the corresponding code.

Theorem 2 *If a Tanner graph \mathcal{G} does not contain any encoding stopping set, then it can be encoded in linear time by the label-and-decide algorithm.*

Proof: We first delete all redundant check nodes (i.e., dependent on other check nodes) from the Tanner graph \mathcal{G} . Next, we restrict our attention to the case that \mathcal{G} is a connected graph. We will show that \mathcal{G} can be equivalently transformed into a pseudo-tree if it is free of any encoding

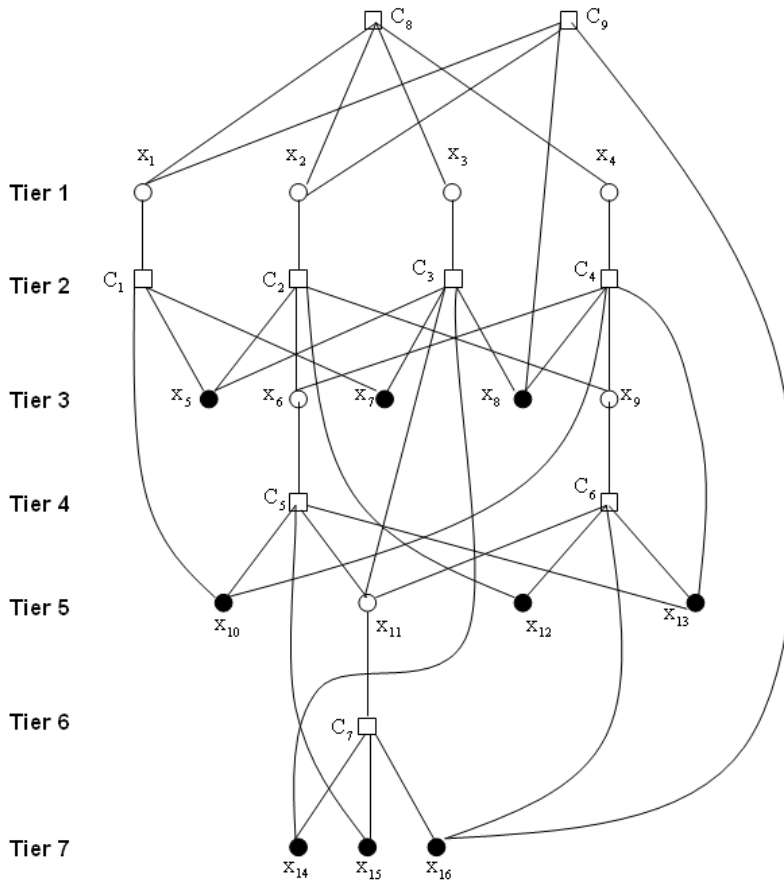

Fig. 4. An encoding stopping set whose proper subgraph is a pseudo-tree shown in Figure 2.

stopping set. Since \mathcal{G} does not contain any encoding stopping set, \mathcal{G} itself is not an encoding stopping set. Hence, there exist some degree-one bit nodes in \mathcal{G} . We generate a multi-layer graph \mathcal{T} and place those degree-one bit nodes in the first tier of \mathcal{T} . Next, the check nodes that connect to the degree-one bit nodes in the first tier of \mathcal{T} are placed in the second tier of \mathcal{T} . Notice that there exist at least one bit node x_α in $\mathcal{G} \setminus \mathcal{T}$ such that x_α connects to at most one check node in $\mathcal{G} \setminus \mathcal{T}$. This statement is true. Otherwise, $\mathcal{G} \setminus \mathcal{T}$ becomes an encoding stopping set, which contradicts the fact that \mathcal{G} does not contain any encoding stopping set. We pick all the bit nodes in $\mathcal{G} \setminus \mathcal{T}$ that connect to at most one check node in $\mathcal{G} \setminus \mathcal{T}$ and place them in the third tier of \mathcal{T} . Correspondingly, those check nodes in $\mathcal{G} \setminus \mathcal{T}$ that connect to the bit nodes in the third tier of \mathcal{T} are placed in the fourth tier of \mathcal{T} . Each time we find bit nodes in $\mathcal{G} \setminus \mathcal{T}$ that connect to at most one check node in $\mathcal{G} \setminus \mathcal{T}$, we place those bit nodes in a new tier $2s + 1$ of \mathcal{T} and

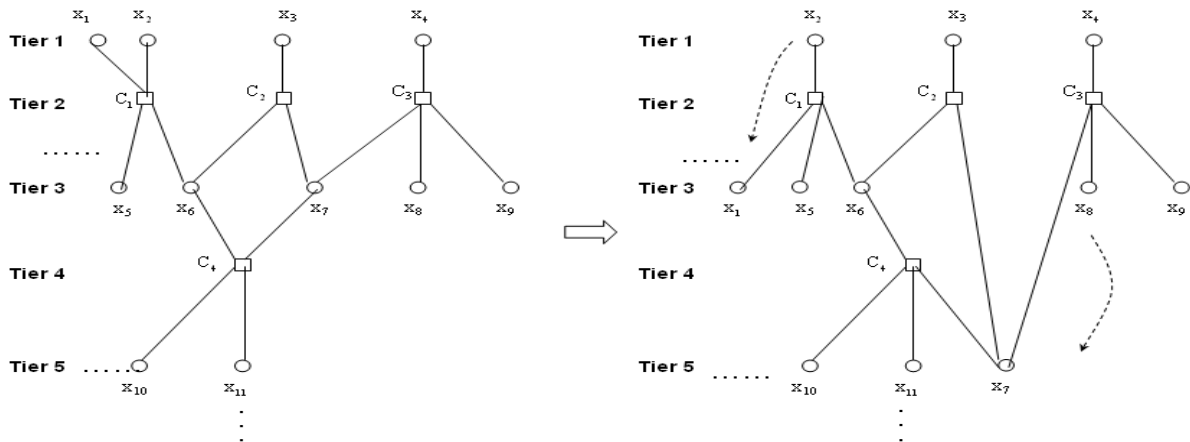

Fig. 5. Left: A multi-layer structure but not a pseudo-tree. (Note that C_4 has two parents x_6 and x_7 and C_1 has two parents x_1 and x_2 .) Right: The pseudo-tree that evolves from the multi-layer structure shown on the left.

place the check nodes connecting to those bit nodes in the following new tier $2s + 2$ of \mathcal{T} . We continue finding such bit nodes and increasing tiers till all the nodes in \mathcal{G} are included in \mathcal{T} . Up to now, the multi-layer structure constructed so far satisfies the conditions (A1), (A2), and (A4). Condition (A3) may fail to be satisfied. For example, as shown on the left in Figure 5, the check node C_4 in tier 4 is connected to two bit nodes x_6 and x_7 in tier 3, which contradicts condition (A3). To satisfy condition (A3), we further adjust the positions of the bit nodes. If a check node in tier $2i$ is connected to k bit nodes in the upper tiers of \mathcal{T} , we pick one bit node in tier $2i - 1$ from these k bit nodes and leave its position unchanged. Next, we drag the other $k - 1$ bit nodes from their initial positions in tier $2i - 1$ to the $(2i + 1)$ -th tier. To illustrate, let us focus on Figure 5 again. We drag the bit node x_7 from tier 3 to tier 5 and drag the bit node x_1 from tier 1 to tier 3. The newly formed graph is shown on the right in Figure 5, which follows condition (A3). By tuning the positions of the bit nodes in this way, the resulting hierarchical graph satisfies conditions (A1) to (A4). In this way, we transform \mathcal{G} into a pseudo-tree. By Lemma 1, a pseudo-tree is linear time encodable. Therefore, the encoding complexity of \mathcal{G} is $\mathcal{O}(M)$ where M denotes the number of independent check nodes contained in \mathcal{G} .

We now prove the case that \mathcal{G} is a disjoint graph. Let \mathcal{G} contain p connected subgraphs: $\mathcal{G}_1, \mathcal{G}_2, \dots, \mathcal{G}_p$. By the above analysis, the complexity of encoding \mathcal{G}_i is $\mathcal{O}(M_i), i = 1, 2, \dots, p$,

where M_i denotes the number of independent check nodes contained in \mathcal{G}_i . Since $\mathcal{G} = \mathcal{G}_1 \cup \mathcal{G}_2 \cup \dots \cup \mathcal{G}_p$, then the encoding complexity of \mathcal{G} is $\sum_{i=1}^p \mathcal{O}(M_i) = \mathcal{O}(\sum_{i=1}^p M_i) = \mathcal{O}(M)$ where M is the number of independent check nodes in \mathcal{G} . This completes the proof. \square

From Theorem 2, we easily derive the following corollaries.

Corollary 1 *If a Tanner graph does not contain any encoding stopping set, then it can be represented by a union of pseudo-trees.*

The proof of Corollary 1 can be found in the proof of Theorem 2.

Corollary 2 *The label-and-decide algorithm can encode any tree LDPC codes (whose Tanner graphs are cycle-free) with linear complexity.*

Proof: Let \mathcal{T} be the Tanner graph of a tree LDPC code and \mathcal{S} be an arbitrary subgraph of \mathcal{T} . Since the Tanner graph \mathcal{T} is a tree, its subgraph \mathcal{S} is either a tree or a union of trees. Therefore, the graph \mathcal{S} contains at least one bit leaf node with degree one. Since the graph \mathcal{S} contains a degree-one bit node, \mathcal{S} can not be an encoding stopping set. Since no subgraph of \mathcal{T} is an encoding stopping set, by Theorem 2, the tree code \mathcal{T} can be encoded in linear complexity by the label-and-decide algorithm. This completes the proof. \square

Corollary 3 *A regular LDPC code with column weight 2 (cycle code) can be encoded in linear complexity by the label-and-decide algorithm.*

Proof: We prove Corollary 3 by showing that a cycle code does not contain any encoding stopping set. Assume the cycle code contains an encoding stopping set \mathcal{E}_f . By the definition of cycle code and condition (B2), all the bit nodes in \mathcal{E}_f have uniform degree two. It follows that the binary sum of all the parity check equations in \mathcal{E}_f is a vector of 0's. Then, at least one check node in \mathcal{E}_f is dependent on the other check nodes. This contradicts condition (B3) that all the check nodes in an encoding stopping set are independent of each other. Hence, a cycle code does not contain any encoding stopping set. By Theorem 2, a cycle code is linear time encodable by the label-and-decide algorithm. This completes the proof. \square

An alternative proof can be found in [4].

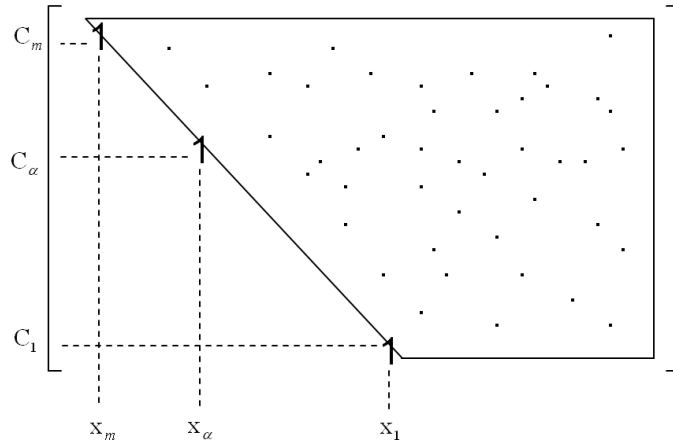

Fig. 6. A parity check matrix in upper triangular form.

Corollary 4 *Let \mathbf{H} be the parity check matrix of an LDPC code. If \mathbf{H} can be transformed into an upper triangular matrix \mathbf{U} by row and column permutations, then the LDPC code can be encoded in linear time by the label-and-decide algorithm.*

Proof: We label the rows of the upper triangular matrix \mathbf{U} one by one as C_1, C_2, \dots, C_m , from the bottom to the top, as shown in Figure 6. We notice that if $i > j$, then there exists at least one bit that is contained in C_i but not in C_j . Assume the Tanner graph of the code contains an encoding stopping set \mathcal{E}_f that contains check nodes $C_{i_1}, C_{i_2}, \dots, C_{i_p}$. Let $q = \max(i_1, i_2, \dots, i_p)$. There exists at least one bit node x_q in \mathcal{E}_f that only connects to C_q . This contradicts the fact that every bit node in an encoding stopping set is connected to at least two check nodes in the encoding stopping set. Hence, \mathcal{E}_f is not an encoding stopping set. Since the Tanner graph of the LDPC code does not contain any encoding stopping set, by Theorem 2 it is linear time encodable. This completes the proof. \square

Theorems 1 and 2 show that encoding stopping sets prevent the application of the label-and-decide algorithm. However, we will show in the next section that encoding stopping sets can also be encoded in linear complexity.

VI. LINEAR COMPLEXITY ENCODING APPROACH FOR ENCODING STOPPING SETS

Let \mathcal{E}_f be an encoding stopping set. We say \mathcal{E}_f is a *k-fold-constraint encoding stopping set* if the following two conditions hold.

- (C1) There exist k check nodes C_1, C_2, \dots, C_k in \mathcal{E}_f such that $\mathcal{E}_f \setminus \{C_1, C_2, \dots, C_k\}$ does not contain any encoding stopping set. We call the k check nodes C_1, C_2, \dots, C_k *key check nodes*.
- (C2) For any $k - 1$ check nodes C_1, C_2, \dots, C_{k-1} in \mathcal{E}_f , $\mathcal{E}_f \setminus \{C_1, C_2, \dots, C_{k-1}\}$ contains an encoding stopping set.

The notation $\mathcal{E}_f \setminus \{C_1, C_2, \dots, C_k\}$ denotes the remaining graph after deleting check nodes C_1, C_2, \dots, C_k from \mathcal{E}_f . Figure 4 shows a 2-fold-constraint encoding stopping set. After deleting the two key check nodes C_8 and C_9 from this encoding stopping set, the Tanner graph turns into a pseudo-tree, see Figure 2. We will focus on 1-fold-constraint and 2-fold-constraint encoding stopping sets in this paper, since we will show later that all types of LDPC codes can be decomposed into 1-fold or 2-fold constraint encoding stopping sets and pseudo-trees.

Let us first look at a 2-fold-constraint encoding stopping set \mathcal{E}_f of size M . By definition, there exist two key check nodes C_α and C_β in \mathcal{E}_f such that $\mathcal{E}_f \setminus \{C_\alpha, C_\beta\}$ does not contain any encoding stopping set. We encode \mathcal{E}_f in three steps. In the first step, we encode $\mathcal{E}_f \setminus \{C_\alpha, C_\beta\}$ using the label-and-decide algorithm according to Theorem 2. During encoding, $M - 2$ bit nodes are labeled as parity bits and the remaining bit nodes are labeled as information bits. In the second step, we verify the two key check nodes C_α and C_β based on the bit values acquired in Step 1. The key check nodes C_α and C_β indicate that two bits x_γ and x_δ that were previously labeled as information bits are actually parity bits, and their values are determined by C_α and C_β . We call the two bits x_γ and x_δ *reevaluated bits*. The bits x_γ and x_δ satisfy the following three conditions.

- (D1) x_γ is constrained by the parity check equation C_α .
- (D2) x_δ is constrained by the parity check equation C_β .
- (D3) x_γ and x_δ are not both contained in C_α and C_β .

Since C_α, C_β , and the other check nodes in \mathcal{E}_f are independent of each other, there must exist bit nodes x_γ and x_δ that satisfy conditions (D1) to (D3). An algorithm for finding reevaluated bits x_γ and x_δ from a 2-fold-constraint encoding stopping set is presented in Appendix A. Notice that the work load to find the two key check nodes and the two reevaluated bits is a preprocessing step that is carried out only once. Assume in step 1 that x_γ and x_δ are randomly assigned initial values x_γ^0 and x_δ^0 , respectively. If the parity check equations C_α and C_β are both satisfied, the initial values x_γ^0 and x_δ^0 are the correct values for x_γ and x_δ . If C_α , or C_β , or both, are

not satisfied, we need to recompute the values of x_γ and x_δ from the values of the key check nodes C_α and C_β . Let $\Delta x_\gamma = \widetilde{x}_\gamma - x_\gamma^0$ and $\Delta x_\delta = \widetilde{x}_\delta - x_\delta^0$ where \widetilde{x}_γ and \widetilde{x}_δ are the correct values of x_γ and x_δ , respectively, and let \widetilde{C}_α and \widetilde{C}_β be the values of the key check nodes C_α and C_β , respectively. If x_γ is contained in both C_α and C_β , and x_δ is only contained in C_β , we derive the following equations.

$$\begin{aligned}\Delta x_\gamma &= -\widetilde{C}_\alpha = \widetilde{C}_\alpha \\ \Delta x_\gamma \oplus \Delta x_\delta &= -\widetilde{C}_\beta = \widetilde{C}_\beta\end{aligned}\tag{7}$$

If x_δ is contained in both C_α and C_β , and x_γ is only contained in C_α , we derive the following equations.

$$\begin{aligned}\Delta x_\gamma \oplus \Delta x_\delta &= -\widetilde{C}_\alpha = \widetilde{C}_\alpha \\ \Delta x_\delta &= -\widetilde{C}_\beta = \widetilde{C}_\beta\end{aligned}\tag{8}$$

If x_γ is only contained in C_α and x_δ is only contained in C_β , we have the following equations.

$$\begin{aligned}\Delta x_\gamma &= -\widetilde{C}_\alpha = \widetilde{C}_\alpha \\ \Delta x_\delta &= -\widetilde{C}_\beta = \widetilde{C}_\beta\end{aligned}\tag{9}$$

From equations (7) to (9), we can get the correct values of x_γ and x_δ . In the third step, we recompute those parity bits that are affected by the new values of x_γ and x_δ . This encoding method is named *label-decide-recompute* and is described in Algorithm 2.

Next, we analyze the computation complexity of the label-decide-recompute algorithm when encoding a 2-fold-constraint encoding stopping set. Every check node except for the two key check nodes C_α and C_β are computed at most twice in the label-decide-recompute encoding (label-and-decide step and recompute step) while the two key check nodes C_α and C_β need to be computed only once. In addition, we need one extra XOR operation to compute the two reevaluated bits x_γ and x_δ by equations (7) to (9). Hence, the encoding complexity of the label-decide-recompute algorithm is less than or equal to $2 \cdot \sum_{i=1}^{M-2} (k_i - 2) + (k_\alpha - 1) + (k_\beta - 1) + 1$ where k_i , $1 \leq i \leq M - 2$, are the degrees of the check nodes other than C_α , C_β and k_α , k_β are the degrees of the check nodes C_α and C_β , respectively. The encoding complexity of the label-decide-recompute algorithm can be further simplified to be less than $2 \cdot M \cdot (\bar{k} - 1)$ where M is the number of check nodes in the encoding stopping set and \bar{k} is the average number of bit nodes contained in each check node in the encoding stopping set. This shows that the label-decide-recompute algorithm encodes any 2-fold-constraint encoding stopping set in linear

Algorithm 2 Label-decide-recompute algorithm for a 2-fold-constraint encoding stopping set \mathcal{E}_f of size M

Preprocessing (carry out only once):

Find two check nodes C_α and C_β such that $\mathcal{E}_f \setminus \{C_\alpha, C_\beta\}$ does not contain any encoding stopping set;

Using Algorithm 8 to pick two information bits x_γ and x_δ that satisfy conditions (D1) to (D3).

Determine the parity bits $x_{p_1}, x_{p_2}, \dots, x_{p_s}$ that are affected by the values of x_γ and x_δ ;

Encoding:

Fill the values of the information bits except for x_γ and x_δ ;

Assign $x_\gamma = 0$ and $x_\delta = 0$;

Encode $\mathcal{E}_f \setminus \{C_\alpha, C_\beta\}$ using Algorithm 1. Compute the values of the $M - 2$ parity bits;

Compute the values \widetilde{C}_α and \widetilde{C}_β of the key check nodes C_α and C_β , respectively;

if $\widetilde{C}_\alpha \neq 0$ or $\widetilde{C}_\beta \neq 0$ **then**

Recompute the values of x_γ and x_δ from \widetilde{C}_α and \widetilde{C}_β by equations (7) to (9);

for $i = 1$ to s **do**

Recompute the value of the parity bit x_{p_i} based on the new values of x_γ and x_δ ;

end for

end if

Output the encoding result.

time. The pre-processing (determining key check nodes, reevaluated bits, and parity bits affected by the reevaluated bits) is done offline and does not count towards encoder complexity.

We look at an example. Figure 4 shows a 2-fold-constraint encoding stopping set \mathcal{E}_f . After deleting the two check nodes C_8 and C_9 , \mathcal{E}_f becomes the pseudo-tree shown in Figure 2. In addition, the value of the bit node x_5 affects C_8 and the value of the bit node x_8 affects C_9 . Hence, the two bits x_5 and x_8 are reevaluated bits. We use the label-decide-recompute algorithm to encode \mathcal{E}_f as follows.

Step 1. Assign $x_5 = 0$ and $x_8 = 0$. Encode the pseudo-tree part following the procedures on page 10.

Step 2. Compute the values of the key check nodes C_8 and C_9 , e.g., $\widetilde{C}_8 = x_1 \oplus x_2 \oplus x_3 \oplus x_4$ and $\widetilde{C}_9 = x_1 \oplus x_2 \oplus x_8 \oplus x_{16}$.

Step 3a. If $\widetilde{C}_8 = 0$ and $\widetilde{C}_9 = 0$, stop encoding and output the codeword $[x_1 \ x_2 \ \dots \ x_{16}]$.

Step 3b. If $\widetilde{C}_8 = 1$ or $\widetilde{C}_9 = 1$, recompute the values of x_5 and x_8 as follows: $x_5 = \widetilde{C}_8$ and $x_8 = \widetilde{C}_9$, where \widetilde{C}_8 and \widetilde{C}_9 are the values of the parity check equations C_8 and C_9 , respectively. Recompute the parity bits x_1 , x_2 , x_3 , and x_4 based on the new values of x_5 and x_8 . Output the codeword $[x_1 \ x_2 \ \dots \ x_{16}]$.

The label-decide-recompute algorithm can be further simplified. We restudy the third step of the label-decide-recompute method. Assume p_1, p_2, \dots, p_m are the parity bits whose values need to be updated. In order to get the new values of the parity bits p_1, p_2, \dots, p_m , we need to recompute those parity check equations that relate to p_1, p_2, \dots, p_m . In fact, instead of recomputing the parity check equations relating to p_1, p_2, \dots, p_m , we can directly flip the values of the parity bits p_1, p_2, \dots, p_m since in the binary field the value of a bit is either 0 or 1. For example, if the correct value of x_γ is different from its original value x_γ^0 , we simply flip the values of those parity bits that are affected by x_γ . We name the above encoding method *label-decide-flip* and describe it in Algorithm 3. The encoding complexity of Algorithm 3 is $M \cdot (\bar{k} - 1)$ XOR operations plus two vector flipping operations. We, again, look at an example. The 2-fold-constraint encoding stopping set shown in Figure 4 can be encoded by Algorithm 3 as follows.

Step 1. Assign $x_5 = 0$ and $x_8 = 0$. Encode the pseudo-tree part following the procedures on page 10.

Step 2. Compute the values of the parity check equations C_8 and C_9 , e.g., $\widetilde{C}_8 = x_1 \oplus x_2 \oplus x_3 \oplus x_4$ and $\widetilde{C}_9 = x_1 \oplus x_2 \oplus x_8 \oplus x_{16}$.

Step 3a. If $\widetilde{C}_8 = 0$ and $\widetilde{C}_9 = 0$, stop encoding and output the codeword $[x_1 \ x_2 \ \dots \ x_{16}]$.

Step 3b. If $\widetilde{C}_8 = 1$ or $\widetilde{C}_9 = 1$, recompute the values of x_5 and x_8 as the following: $x_5 = \widetilde{C}_8$ and $x_8 = \widetilde{C}_9$ where \widetilde{C}_8 and \widetilde{C}_9 are the values of the parity check equations C_8 and C_9 , respectively. If $x_5 = 1$, flip the vector $[x_1 \ x_2 \ x_3]$ to be $[\sim x_1 \ \sim x_2 \ \sim x_3]$. If $x_8 = 1$, flip the vector $[x_3 \ x_4]$. If $x_5 \oplus x_8 = 1$, flip the vector $[x_4]$. Output the codeword $[x_1 \ x_2 \ \dots \ x_{16}]$.

Algorithm 3 Label-decide-flip algorithm for a 2-fold-constraint encoding stopping set \mathcal{E}_f of size M

Preprocessing (carry out only once):

Find two check nodes C_α and C_β such that $\mathcal{E}_f \setminus \{C_\alpha, C_\beta\}$ does not contain any encoding stopping set;

Using Algorithm 8 to pick two information bits x_γ and x_δ that satisfy conditions (D1) to (D3).

Determine the parity bits $x_{u_1}, x_{u_2}, \dots, x_{u_r}$ that are affected by the value of x_γ and group $x_{u_1}, x_{u_2}, \dots, x_{u_r}$ in a vector $\vec{X}_\gamma = [x_{u_1} \ x_{u_2} \ \dots \ x_{u_r}]$. Determine the parity bits $x_{p_1}, x_{p_2}, \dots, x_{p_s}$ that are affected by the value of x_δ and group $x_{p_1}, x_{p_2}, \dots, x_{p_s}$ in a vector $\vec{X}_\delta = [x_{p_1} \ x_{p_2} \ \dots \ x_{p_s}]$.

Determine the parity bits $x_{q_1}, x_{q_2}, \dots, x_{q_t}$ that are affected by the value of $x_\gamma \oplus x_\delta$ and group $x_{q_1}, x_{q_2}, \dots, x_{q_t}$ in a vector $\vec{X}_\epsilon = [x_{q_1} \ x_{q_2} \ \dots \ x_{q_t}]$.

Encoding:

Fill the values of the information bits except for x_γ and x_δ ;

Assign $x_\gamma = 0$ and $x_\delta = 0$;

Encode $\mathcal{E}_f \setminus \{C_\alpha, C_\beta\}$ using Algorithm 1. Compute the values of the $M - 2$ parity bits;

Compute the values \widetilde{C}_α and \widetilde{C}_β of the parity check equations C_α and C_β , respectively;

if $\widetilde{C}_\alpha \neq 0$ or $\widetilde{C}_\beta \neq 0$ **then**

Recompute the values of x_γ and x_δ from \widetilde{C}_α and \widetilde{C}_β by equations (7) to (9);

if $x_\gamma = 1$ **then**

Flip the vector \vec{X}_γ .

end if

if $x_\delta = 1$ **then**

Flip the vector \vec{X}_δ .

end if

if $x_\gamma \oplus x_\delta = 1$ **then**

Flip the vector \vec{X}_ϵ .

end if

end if

Output the encoding result.

It is easy to revise Algorithm 2 and Algorithm 3 to encode a 1-fold-constraint encoding stopping set. For example, Algorithm 4 shows the label-decide-recompute algorithm for a 1-fold-constraint encoding stopping set. The encoding complexity of Algorithm 4 is less than $2 \cdot M \cdot (\bar{k} - 1)$ where M is the number of check nodes in the encoding stopping set and \bar{k} is the average number of bit nodes contained in each check node in the encoding stopping set.

Algorithm 4 Label-decide-recompute algorithm for a 1-fold-constraint encoding stopping set \mathcal{E}_f of size M

Preprocessing (carry out only once):

Find a check node C^* such that $\mathcal{E}_f \setminus C^*$ does not contain any encoding stopping set.

Pick an information bit x^* that is constrained by the parity check equation C^* .

Determine the parity bits $x_{p_1}, x_{p_2}, \dots, x_{p_s}$ that are affected by x^* .

Encoding:

Fill the values of the information bits except for x^* .

Assign $x^* = 0$.

Encode $\mathcal{E}_f \setminus C^*$ using Algorithm 1, compute the values of the $M - 1$ parity bits.

Verify the parity check equation C^* .

if the parity check equation C^* is not satisfied **then**

$x^* \leftarrow 1$.

for $i = 1$ to s **do**

Recompute the value of the parity bit x_{p_i} based on the new value of x^* ;

end for

end if

Output the encoding result.

VII. LINEAR COMPLEXITY ENCODING FOR GENERAL LDPC CODES

In this section, we propose a linear complexity encoding method for general LDPC codes. We will show that any Tanner graph can be decomposed into pseudo-trees and encoding stopping sets that are 1-fold-constraint or 2-fold-constraint. By encoding each pseudo-tree or encoding stopping set using Algorithm 1 or Algorithm 2, we achieve linear time encoding for arbitrary LDPC codes.

To proceed, we provide the following definition. Given a Tanner graph \mathcal{G} and its subgraph \mathcal{S} , we call the bit nodes in \mathcal{G} but not in \mathcal{S} the *outsider nodes of \mathcal{S}* . For example, Figure 7 shows a Tanner graph \mathcal{G} and its subgraph \mathcal{S} . Since in Figure 7 the two bit nodes x_1 and x_2 are in \mathcal{G} but not in \mathcal{S} , x_1 and x_2 are outsider nodes of \mathcal{S} . The check node C_2 contains two outsider nodes of \mathcal{S} , i.e., is connected to two outsider nodes. The check node C_1 contains zero outsider nodes of \mathcal{S} .

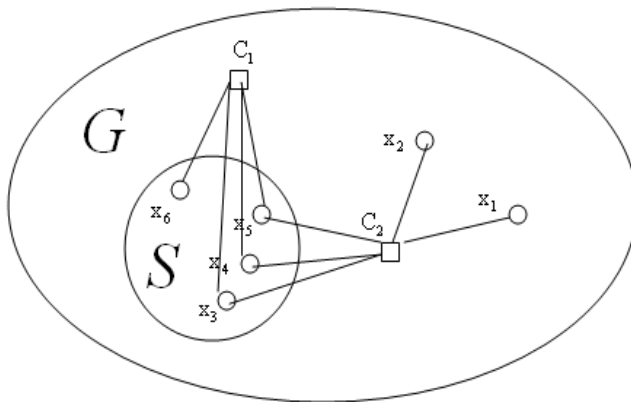

Fig. 7. Outsider nodes.

We start from LDPC codes with maximum column weight 3 by proving the following lemma.

Lemma 3 *Assume the maximum bit node degree of a Tanner graph \mathcal{G} is three, then one of the following statements must be true.*

- (E1) *There are no pseudo encoding stopping sets or encoding stopping sets in \mathcal{G} .*
- (E2) *There exists a pseudo encoding stopping set in \mathcal{G} . All the bit nodes in the pseudo encoding stopping set have uniform degree 2.*
- (E3) *There exists a 1-fold-constraint or a 2-fold-constraint encoding stopping set in \mathcal{G} .*

Proof: We only need to prove either condition (E2), or condition (E3), is true if \mathcal{G} contains a pseudo encoding stopping set, or an encoding stopping set, respectively. We prove this statement by constructing a subgraph \mathcal{S} from the Tanner graph \mathcal{G} . Initially \mathcal{S} is empty. We pick a check node C_1 from \mathcal{G} that contains the smallest number of bit nodes. Next, we add C_1 and all the bit

nodes contained in C_1 to \mathcal{S} . We keep adding check nodes and their associated bit nodes to \mathcal{S} till \mathcal{S} contains a pseudo encoding stopping set or an encoding stopping set. Each time we add a check node to \mathcal{S} , we always pick the check node that contains the fewest outsider nodes of \mathcal{S} . If \mathcal{S} contains an encoding stopping set, we also add all the check nodes in $\mathcal{G} \setminus \mathcal{S}$ that contain zero outsider nodes to \mathcal{S} . Next, we discuss two different cases.

\mathcal{S} contains an encoding stopping set. Assume \mathcal{S} contains k check nodes and the j -th added check node C_j is the last check node that introduces outsider nodes to \mathcal{S} . We will show that $k - j \leq 2$. Assume C_j adds p outsider nodes $x_{j_1}, x_{j_2}, \dots, x_{j_p}$ to \mathcal{S} . We will prove that the $(j + 1)$ -th added check node C_{j+1} connects to all the p bit nodes $x_{j_1}, x_{j_2}, \dots, x_{j_p}$. If C_{j+1} does not connect to all the p bit nodes, then C_{j+1} contains a smaller number of outsider nodes than C_j and should be added earlier than C_j since we always pick the check node that contains the smallest number of outsider nodes and add it first to \mathcal{S} . This contradicts the fact that C_{j+1} is added to \mathcal{S} after C_j . Therefore, C_{j+1} should connect to all the p bit nodes $x_{j_1}, x_{j_2}, \dots, x_{j_p}$. Similarly, C_{j+2}, \dots, C_k connect to all the p bit nodes $x_{j_1}, x_{j_2}, \dots, x_{j_p}$. Since any bit node can connect to at most three check nodes, it follows that $k - j \leq 2$, which means at most two check nodes are added to \mathcal{S} after C_j . Notice that \mathcal{S} does not contain any encoding stopping set before adding C_{j+1} . Hence, the encoding stopping set in \mathcal{S} is either a 1-fold-constraint encoding stopping set or a 2-fold-constraint encoding stopping set. Condition (E2) is satisfied.

\mathcal{S} is a pseudo encoding stopping set. It follows that the binary sum of all the check nodes in \mathcal{S} is zero. So, the degree of every bit node in \mathcal{S} is an even number. Since the maximum bit node degree is three, the degree of each bit node in \mathcal{S} is two. Condition (E3) is satisfied.

This completes the proof. □

We detail the method of determining a pseudo encoding stopping set or an encoding stopping set in Algorithm 5.

Theorem 3 *Let \mathcal{G} be the Tanner graph of an LDPC code. If the maximum bit node degree of \mathcal{G} is three, then the LDPC code can be encoded in linear time and the encoding complexity is less than $2 \cdot M \cdot (\bar{k} - 1)$ where M is the number of independent check nodes in \mathcal{G} and \bar{k} is the average number of bit nodes contained in each check node.*

Proof: If the Tanner graph \mathcal{G} does not contain any encoding stopping set, then the corresponding LDPC code can be encoded in linear time by Theorem 2. Therefore, we only need to prove

Algorithm 5 Find a pseudo encoding stopping set or an encoding stopping set (1-fold-constraint or 2-fold-constraint) from a Tanner graph \mathcal{G} with maximum bit node degree 3.

$\mathcal{S} = \phi$.

$Flag \leftarrow 0$.

$i = 1$.

while $Flag = 0$ and $\mathcal{G} \neq \mathcal{S}$ **do**

Find a check node C_i in $\mathcal{G} \setminus \mathcal{S}$ that contains the smallest number of outsider nodes of \mathcal{S} .

Add C_i and all its associated outsider nodes to \mathcal{S} .

if C_i does not introduce new bit nodes to \mathcal{S} **then**

$\mathcal{A} \leftarrow \mathcal{S}$.

while there exists a bit node x of degree one in \mathcal{A} **do**

Delete the degree-one bit node x and the check node connecting to x from \mathcal{A} .

end while

if $\mathcal{A} = \phi$ **then**

\mathcal{S} does not contain any pseudo encoding stopping set or encoding stopping set.

else

$Flag \leftarrow 1$.

end if

end if

$i = i + 1$.

end while

if $Flag = 1$ **then**

if all the bit nodes in \mathcal{A} are of degree 2 **then**

The subgraph \mathcal{A} is a pseudo encoding stopping set.

else

The subgraph \mathcal{A} is an encoding stopping set.

end if

Output \mathcal{A} .

else

The Tanner graph \mathcal{G} does not contain pseudo encoding stopping sets or encoding stopping sets.

end if

Theorem 3 for the case that \mathcal{G} contains encoding stopping sets. Since the maximum bit node degree of \mathcal{G} is three, by Lemma 3 there exists a pseudo encoding stopping set or an encoding stopping set \mathcal{G}_1 in \mathcal{G} . If \mathcal{G}_1 is a pseudo encoding stopping set, we simply delete a redundant check node from \mathcal{G}_1 and \mathcal{G}_1 becomes a pseudo-tree. If \mathcal{G}_1 is an encoding stopping set, it is either a 1-fold-constraint or a 2-fold-constraint encoding stopping set by Lemma 3.

Next, we look at the subgraph $\mathcal{G} \setminus \mathcal{G}_1$. We first transform the parity check equations in $\mathcal{G} \setminus \mathcal{G}_1$ into generalized parity check equations by moving the bits contained in \mathcal{G}_1 from the left-hand side of the equation to the right-hand side of the equation. Let a parity check equation C contain k bit nodes x_1, x_2, \dots, x_k where the bits x_{q+1}, \dots, x_k are also in \mathcal{G}_1 , then the parity check equation C can be rewritten as

$$x_1 \oplus x_2 \oplus \dots \oplus x_k = 0 \implies x_1 \oplus x_2 \oplus \dots \oplus x_q = x_{q+1} \oplus x_{q+2} \oplus \dots \oplus x_k = b \quad (10)$$

In equation (10), b becomes a constant after we encode \mathcal{G}_1 and get the values of all the bits in \mathcal{G}_1 . Since the maximum bit node degree of $\mathcal{G} \setminus \mathcal{G}_1$ is less than or equal to three, we, again, find a pseudo encoding stopping set or an encoding stopping set \mathcal{G}_2 from $\mathcal{G} \setminus \mathcal{G}_1$. If \mathcal{G}_2 is an encoding stopping set, \mathcal{G}_2 is either a 1-fold-constraint or a 2-fold-constraint encoding stopping set by Lemma 3. If \mathcal{G}_2 is a pseudo encoding stopping set and we assume \mathcal{G}_2 contains the following m generalized parity check equations,

$$\begin{aligned} x_{1,1} \oplus x_{1,2} \oplus \dots \oplus x_{1,a_1} &= b_1 \\ x_{2,1} \oplus x_{2,2} \oplus \dots \oplus x_{2,a_2} &= b_2 \\ \vdots & \\ x_{m,1} \oplus x_{m,2} \oplus \dots \oplus x_{m,a_m} &= b_m \end{aligned} \quad (11)$$

we derive that

$$b_1 \oplus b_2 \oplus \dots \oplus b_m = 0 \quad (12)$$

Hence, we can replace any generalized parity check equation in (11) by the new parity check equation (12). From the above analysis, we can delete any check node from \mathcal{G}_2 to make \mathcal{G}_2 a pseudo-tree. To maintain the code structure, we also generate a new check node C^* that represents the parity check equation (12). Since the parity check equation (12) only contains bits in \mathcal{G}_1 , we add the new check node C^* to \mathcal{G}_1 and regenerate encoding stopping sets or pseudo-trees in the graph $\mathcal{G}_1 \cup C^*$.

Generally, we can find a pseudo encoding stopping set or an encoding stopping set \mathcal{G}_{i+1} from the subgraph $\mathcal{G} \setminus \{\mathcal{G}_1 \cup \mathcal{G}_2 \cup \dots \cup \mathcal{G}_i\}$. If \mathcal{G}_{i+1} is an encoding stopping set, \mathcal{G}_{i+1} is either a 1-fold-constraint or a 2-fold-constraint encoding stopping set by Lemma 3. If \mathcal{G}_{i+1} is a pseudo encoding stopping set, we operate in three steps. In the first step, we sum up all the generalized parity check equations in \mathcal{G}_{i+1} to generate a new parity check equation C^* . In the second step, we delete one check node from \mathcal{G}_{i+1} to make \mathcal{G}_{i+1} a pseudo-tree. In the third step, we add the new check node C^* to \mathcal{G}_i and regenerate pseudo-tree or encoding stopping sets in $\mathcal{G}_i \cup C^*$. Notice that the new parity check equation C^* in (12) does not incur extra cost to compute variables b_1, b_2, \dots, b_m since these variables have already been computed in those generalized parity check equations in \mathcal{G}_{i+1} , as shown in (11). Practically, we can compute these variables b_1, b_2, \dots, b_m only once and store them. Later, we can apply the stored values b_1, b_2, \dots, b_m to both equation (12) and equation (11). Hence, the new parity check equation C^* only needs $m - 1$ additional XOR operations to compute the summation of b_1, b_2, \dots, b_m . Since the cost of encoding the pseudo-tree \mathcal{G}_{i+1} is $(m - 1) \cdot (\bar{k} - 2)$ where \bar{k} is the average degree of the remaining $m - 1$ check nodes in \mathcal{G}_{i+1} , the overall cost of encoding \mathcal{G}_{i+1} and the new parity check equation C^* is $(m - 1) \cdot (\bar{k} - 1)$.

By continuing to find pseudo-tree or encoding stopping sets in this way, we reach the stage where $\mathcal{G} \setminus \{\mathcal{G}_1 \cup \mathcal{G}_2 \cup \dots \cup \mathcal{G}_i\} = \phi$ or $\mathcal{G} \setminus \{\mathcal{G}_1 \cup \mathcal{G}_2 \cup \dots \cup \mathcal{G}_i\}$ does not contain pseudo encoding stopping sets or encoding stopping sets.

By the above analysis, we decompose the Tanner graph \mathcal{G} into a sequence of p subgraphs $\mathcal{G}_1, \mathcal{G}_2, \dots, \mathcal{G}_p$ where $\mathcal{G}_i, 1 \leq i \leq p$, is either a 1-fold-constraint encoding stopping set, a 2-fold-constraint encoding stopping set, or a pseudo-tree. If \mathcal{G}_i is a 1-fold-constraint or a 2-fold-constraint encoding stopping set, we apply Algorithm 2 or Algorithm 4 to encode \mathcal{G}_i and the resulting encoding complexity is less than $2 \cdot M_i \cdot (\bar{k}_i - 1)$ where M_i denotes the number of independent check nodes in \mathcal{G}_i and \bar{k}_i denotes the average number of bit nodes contained in each check node in \mathcal{G}_i . If \mathcal{G}_i is a pseudo-tree, we apply Algorithm 1 to encode \mathcal{G}_i and the corresponding encoding complexity is less than $M_i \cdot (\bar{k}_i - 1)$. The overall computation complexity of encoding \mathcal{G} is linear on the number of independent check nodes M in \mathcal{G} and is bounded by $\sum_{i=1}^p (2 \cdot M_i \cdot (\bar{k}_i - 1)) = 2 \cdot M \cdot (\bar{k} - 1)$ where \bar{k} denotes the average number of bits contained in each independent check node of \mathcal{G} . This completes the proof. \square

We summarize the algorithm of decomposing a Tanner graph with maximum bit node degree 3

into pseudo-trees and encoding stopping sets in Algorithm 6 and the algorithm to encode such LDPC codes in Algorithm 7.

Algorithm 6 Decompose a Tanner graph \mathcal{G} with maximum bit node degree 3 into 1-fold-constraint encoding stopping sets, 2-fold-constraint encoding stopping sets, and pseudo-trees.

Find a pseudo encoding stopping set or an encoding stopping set \mathcal{G}_1 from \mathcal{G} using Algorithm 5.

$\mathcal{G} = \mathcal{G} \setminus \mathcal{G}_1$.

if \mathcal{G}_1 is a pseudo encoding stopping set **then**

Delete a check node in \mathcal{G}_1 . \mathcal{G}_1 becomes a pseudo-tree.

end if

$i = 1$.

while there exists a pseudo encoding stopping set or an encoding stopping set in \mathcal{G} **do**

Find a pseudo encoding stopping set or an encoding stopping set \mathcal{G}_{i+1} from \mathcal{G} using Algorithm 5. Assume \mathcal{G}_{i+1} contain m check nodes C_1, C_2, \dots, C_m .

$\mathcal{G} = \mathcal{G} \setminus \mathcal{G}_{i+1}$

if \mathcal{G}_{i+1} is a pseudo encoding stopping set **then**

$\mathcal{G}_{i+1} = \mathcal{G}_{i+1} \setminus C_m$. \mathcal{G}_{i+1} becomes a pseudo-tree.

Generate a new check node $C^* = C_1 \oplus C_2 \oplus \dots \oplus C_m$.

Add C^* to \mathcal{G}_i and regenerate pseudo-trees and encoding stopping sets in $\mathcal{G}_i \cup C^*$.

end if

$i = i + 1$.

end while

$\mathcal{G}_{i+1} = \mathcal{G}$.

Output a sequence of subgraphs $\mathcal{G}_1, \mathcal{G}_2, \dots, \mathcal{G}_p$ where $\mathcal{G}_i, 1 \leq i \leq p$, is either a pseudo-tree or an encoding stopping set (1-fold-constraint or 2-fold-constraint.)

Next, we extend the linear time encoding method described in Theorem 3 to LDPC codes with arbitrary column weight and row weight.

Algorithm 7 linear complexity encoding algorithm for LDPC codes with maximum bit node degree 3

Preprocessing (carry out only once):

Apply Algorithm 6 to decompose the Tanner graph \mathcal{G} of the code into p subgraphs $\mathcal{G}_1, \mathcal{G}_2, \dots, \mathcal{G}_p$ where $\mathcal{G}_i, i = 1, 2, \dots, p$, is either a pseudo-tree or a 1-fold-constraint encoding stopping set or a 2-fold-constraint encoding stopping set.

Encoding:

for $i = 1$ to p **do**

 Compute the constants on the right-hand side of the generalized parity check equations of \mathcal{G}_i based on the already known bit values of $\mathcal{G}_1, \mathcal{G}_2, \dots, \mathcal{G}_{i-1}$.

if \mathcal{G}_i is a pseudo-tree **then**

 Encode \mathcal{G}_i using Algorithm 1.

else

 Encode \mathcal{G}_i using Algorithm 2.

end if

end for

Output the encoded codeword.

Theorem 4 Any LDPC code \mathcal{C} with arbitrary column weight distribution and row weight distribution can be encoded in linear time, and the encoding complexity is less than $4 \cdot M \cdot (\bar{k} - 1)$ where M is the number of independent check nodes in \mathcal{C} and \bar{k} is the average degree of check nodes.

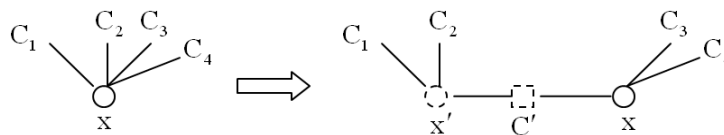

Fig. 8. Transform a bit node of degree 4 into two bit nodes of degree 3 and an auxiliary check node.

Proof: We first show that an LDPC code with arbitrary column weight distribution and row weight distribution can be equivalently transformed into an LDPC code with maximum column

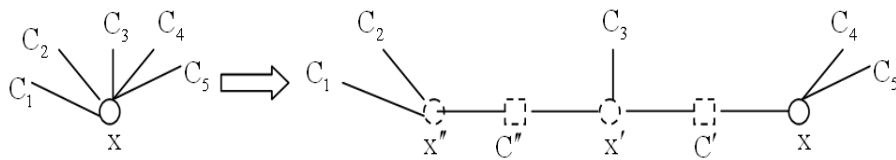

Fig. 9. Transform a bit node of degree 5 into three bit nodes of degree 3 and two auxiliary check nodes.

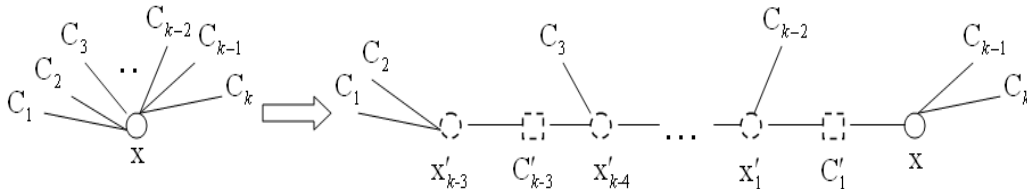

Fig. 10. Transform a bit node of degree k into $k - 2$ bit nodes of degree 3 and $k - 3$ auxiliary check nodes.

weight three. For example, Figure 8 on the left shows a bit node x of degree 4. It can be split into two bit nodes x and x' of degree 3 and an auxiliary check node C' , as shown on the right in Figure 8. The auxiliary check node C' is represented as $x \oplus x' = 0$, which means x is equivalent to x' . Originally the bit node x connects to four check nodes $C_1, C_2, C_3,$ and C_4 . After node splitting, x' connects to $C_1, C_2,$ and x connects to C_3, C_4 . Hence, the Tanner graph on the left in Figure 8 is equivalent to the Tanner graph on the right in Figure 8. Similarly, a bit node of degree 5 can be split into three bit nodes $x, x',$ and x'' and two auxiliary check nodes C' and C'' , as shown in Figure 9. Generally, a bit node of degree k can be equivalently transformed into $k - 2$ bit nodes of degree 3 and $k - 3$ auxiliary check nodes, as shown in Figure 10. Assume an LDPC code \mathcal{C} contains M check nodes and N bit nodes. The M check nodes have degrees k_1, k_2, \dots, k_M , respectively. The N bit nodes have degrees j_1, j_2, \dots, j_N , respectively. Among the N bit nodes in \mathcal{C} , there are s bit nodes whose degrees are greater than 3 and their degrees are j_1, j_2, \dots, j_s . This LDPC code can be equivalently transformed into another LDPC code \mathcal{C}' with maximum column weight 3. The new code \mathcal{C}' has $M + (\sum_{i=1}^s j_i - 3s)$ check nodes and $N + (\sum_{i=1}^s j_i - 3s)$ bit nodes. By Theorem 3, the LDPC code \mathcal{C}' can be encoded in linear time and the encoding complexity is less than $2 \cdot M' \cdot (\overline{k'} - 1)$, where M' is the number of independent check nodes in \mathcal{C}' and $\overline{k'}$ is the average degree of independent check nodes in \mathcal{C}' . Since there

are $\sum_{i=1}^s j_i - 3s$ auxiliary check nodes in \mathcal{C}' that have degree 2, we derive that

$$\begin{aligned}
2 \cdot M' \cdot (\bar{k}' - 1) &= 2 \cdot \left(M \cdot (\bar{k} - 1) + \left(\sum_{i=1}^s j_i - 3s \right) \cdot (2 - 1) \right) \\
&< 2 \cdot \left(M \cdot (\bar{k} - 1) + \left(\sum_{i=1}^N j_i - N \right) \right) \\
&< 2 \cdot \left(M \cdot (\bar{k} - 1) + \left(\sum_{i=1}^M k_i - M \right) \right) \\
&= 4 \cdot M \cdot (\bar{k} - 1)
\end{aligned} \tag{13}$$

Therefore, the overall computation cost of encoding \mathcal{C}' is less than $4 \cdot M \cdot (\bar{k} - 1)$. As the LDPC code \mathcal{C} is equivalent to the LDPC code \mathcal{C}' , the complexity of encoding \mathcal{C} is less than $4 \cdot M \cdot (\bar{k} - 1)$.

This completes the proof. \square

Let's look at an example. The parity check matrix of a (13,26) LDPC code with column weight 3 is shown in (14). Assume the values of the 13 information bits are 0, 1, 1, 1, 0, 1, 1, 0, 0, 1, 0, 1, and 1. We apply the proposed linear complexity encoding method to encode this code.

$$\mathbf{H} = \begin{bmatrix}
1 & 0 & 0 & 0 & 0 & 0 & 0 & 0 & 1 & 0 & 0 & 0 & 1 & 0 & 0 & 0 & 0 & 0 & 0 & 1 & 1 & 1 & 0 & 0 & 0 \\
0 & 0 & 0 & 1 & 0 & 0 & 0 & 1 & 0 & 0 & 0 & 1 & 0 & 0 & 0 & 1 & 0 & 1 & 0 & 0 & 0 & 0 & 1 & 0 & 0 & 0 \\
0 & 0 & 1 & 0 & 0 & 0 & 0 & 0 & 0 & 0 & 1 & 0 & 0 & 0 & 1 & 0 & 0 & 0 & 0 & 1 & 0 & 0 & 0 & 0 & 1 & 1 \\
0 & 0 & 0 & 0 & 0 & 0 & 1 & 1 & 0 & 1 & 0 & 0 & 0 & 1 & 0 & 0 & 0 & 0 & 0 & 0 & 1 & 0 & 0 & 1 & 0 & 0 \\
0 & 0 & 0 & 0 & 0 & 1 & 0 & 0 & 0 & 0 & 0 & 0 & 0 & 0 & 0 & 1 & 0 & 0 & 0 & 1 & 1 & 0 & 0 & 0 & 0 & 1 & 1 \\
0 & 0 & 0 & 0 & 1 & 0 & 1 & 0 & 0 & 0 & 0 & 1 & 1 & 0 & 0 & 0 & 1 & 0 & 0 & 0 & 0 & 0 & 1 & 0 & 0 & 0 & 0 \\
0 & 0 & 0 & 0 & 1 & 0 & 0 & 0 & 1 & 0 & 0 & 0 & 1 & 1 & 0 & 1 & 0 & 1 & 0 & 0 & 0 & 0 & 0 & 0 & 0 & 0 & 0 \\
0 & 0 & 1 & 0 & 0 & 1 & 0 & 0 & 0 & 0 & 1 & 0 & 0 & 0 & 0 & 0 & 0 & 0 & 0 & 1 & 0 & 0 & 0 & 0 & 1 & 1 & 1 \\
0 & 1 & 0 & 1 & 0 & 0 & 1 & 0 & 0 & 0 & 0 & 0 & 0 & 0 & 0 & 0 & 1 & 0 & 0 & 0 & 0 & 0 & 1 & 0 & 1 & 0 & 0 \\
0 & 1 & 0 & 0 & 0 & 0 & 0 & 0 & 1 & 1 & 0 & 1 & 0 & 1 & 0 & 0 & 0 & 1 & 0 & 0 & 0 & 0 & 0 & 0 & 0 & 0 & 0 \\
0 & 0 & 1 & 0 & 0 & 1 & 0 & 0 & 0 & 0 & 1 & 0 & 0 & 0 & 1 & 0 & 0 & 0 & 1 & 1 & 0 & 0 & 0 & 0 & 0 & 0 & 0 \\
1 & 1 & 0 & 0 & 0 & 0 & 0 & 1 & 0 & 0 & 0 & 0 & 0 & 0 & 0 & 0 & 1 & 0 & 0 & 0 & 1 & 0 & 0 & 0 & 0 & 0 & 0 \\
1 & 0 & 0 & 1 & 1 & 0 & 0 & 0 & 0 & 1 & 0 & 0 & 0 & 0 & 0 & 0 & 0 & 1 & 0 & 0 & 0 & 0 & 1 & 0 & 0 & 0 & 0 & 0
\end{bmatrix} \tag{14}$$

Preprocessing. We construct an encoding stopping set from (14) using Algorithm 5. We start from an empty graph \mathcal{S} and add check nodes and their associated bit nodes to \mathcal{S} . Each time

we add a check node, we always pick the check node that contains the smallest number of outsider nodes of \mathcal{S} . After adding 7 check nodes, the resulting graph is a pseudo-tree, as shown in Figure 11. When 9 check nodes are considered, we get the 2-fold-constraint encoding stopping set \mathcal{E}_1 shown in Figure 12. The bits $x_9, x_{13}, x_{22}, x_{23}, x_5, x_{16}, x_4, x_{12}, x_{17}$ are information bits. The two check nodes C_{10} and C_{12} are key check nodes, and the two bit nodes x_1 and x_{18} are reevaluated bits.

After finding the encoding stopping set \mathcal{E}_1 , the remaining Tanner graph of the code can be constructed to be a 2-fold-constraint encoding stopping set \mathcal{E}_2 , as shown in Figure 13. Therefore, the LDPC code can be partitioned into two encoding stopping sets \mathcal{E}_1 and \mathcal{E}_2 that are shown in Figure 13. The bits $x_{11}, x_{15}, x_{19}, x_{25}$ in the encoding stopping set \mathcal{E}_2 are information bits. The two check nodes C_3 and C_5 are key check nodes of \mathcal{E}_2 , and the two bit nodes x_3 and x_6 are reevaluated bits of \mathcal{E}_2 .

Encoding.

Encode \mathcal{E}_1 :

- Step 1. Fill the values of the information bits, i.e., $[x_9 \ x_{13} \ x_{22} \ x_{23} \ x_5 \ x_{16} \ x_4 \ x_{12} \ x_{17}] = [0 \ 1 \ 1 \ 1 \ 0 \ 1 \ 1 \ 0 \ 0]$. Assign $x_1 = 0$ and $x_{18} = 0$.
- Step 2. Encode the pseudo-tree shown in Figure 11. Compute the parity bits $x_{21}, x_{14}, x_8, x_7, x_{10}, x_{24}, x_2$ as follows.

$$x_{21} = x_1 \oplus x_9 \oplus x_{13} \oplus x_{22} \oplus x_{23} = 1$$

$$x_{14} = x_9 \oplus x_{13} \oplus x_5 \oplus x_{16} \oplus x_{18} = 0$$

$$x_8 = x_{23} \oplus x_{16} \oplus x_{18} \oplus x_4 \oplus x_{12} = 1$$

$$x_7 = x_{13} \oplus x_{23} \oplus x_5 \oplus x_{12} \oplus x_{17} = 0$$

$$x_{10} = x_1 \oplus x_{22} \oplus x_5 \oplus x_4 \oplus x_{17} = 0$$

$$x_{24} = x_{21} \oplus x_{14} \oplus x_8 \oplus x_7 \oplus x_{10} = 0$$

$$x_2 = x_{22} \oplus x_{24} \oplus x_{16} \oplus x_7 \oplus x_4 = 1$$

- Step 3. Compute the values of the parity check equations C_{10} and C_{12} . $\widetilde{C}_{10} = x_2 \oplus x_9 \oplus x_{10} \oplus x_{12} \oplus x_{14} \oplus x_{18} = 1$, and $\widetilde{C}_{12} = x_1 \oplus x_2 \oplus x_8 \oplus x_{17} \oplus x_{21} = 1$.

- Step 4. Since $\widetilde{C}_{10} = 1$ and $\widetilde{C}_{12} = 1$, the correct values of x_1 and x_{18} are $x_1 = \widetilde{C}_{10} = 1$ and $x_{18} = \widetilde{C}_{12} = 1$.

Step 5. Recompute the parity bits x_{21} , x_{14} , x_8 , and x_{10} based on the new values of x_1 and x_{18} . We derive that $x_{21} = 0$, $x_{14} = 1$, $x_8 = 0$, $x_{10} = 1$.

Encode \mathcal{E}_2 :

Step 6. Fill the values of the information bits, i.e., $[x_{11} \ x_{15} \ x_{19} \ x_{25}] = [1 \ 0 \ 1 \ 1]$. Assign $x_3 = 0$ and $x_6 = 0$.

Step 7. Compute the parity bits x_{20} , x_{26} as follows.

$$x_{20} = x_3 \oplus x_6 \oplus x_{11} \oplus x_{15} \oplus x_{19} = 0$$

$$x_{26} = x_3 \oplus x_6 \oplus x_{11} \oplus x_{19} \oplus x_{25} \oplus x_{24} = 1$$

Notice that the value of the parity bit x_{26} is based on the value of the bit x_{24} in \mathcal{E}_1 .

Step 8. Compute the values of the parity check equations C_3 and C_5 . $\widetilde{C}_3 = x_3 \oplus x_{20} \oplus x_{11} \oplus x_{15} \oplus x_{26} \oplus x_{25} = 1$, and $\widetilde{C}_5 = x_6 \oplus x_{20} \oplus x_{15} \oplus x_{19} \oplus x_{26} \oplus x_{25} = 1$.

Step 9. Since $\widetilde{C}_3 = 1$ and $\widetilde{C}_5 = 1$, the correct values of x_3 and x_6 are $x_3 = \widetilde{C}_3 = 1$ and $x_6 = \widetilde{C}_5 = 1$.

The encoded codeword is

$$[x_9 \ x_{13} \ x_{22} \ x_{23} \ x_5 \ x_{16} \ x_4 \ x_{12} \ x_{17} \ x_1 \ x_{18} \ x_{21} \ x_{14} \ x_8 \ x_7 \ x_{10} \ x_{24} \ x_2 \ x_{11} \ x_{15} \ x_{19} \ x_{25} \ x_3 \ x_6 \ x_{20} \ x_{26}] = [0 \ 1 \ 1 \ 1 \ 0 \ 1 \ 1 \ 0 \ 0 \ 1 \ 1 \ 0 \ 1 \ 0 \ 0 \ 1 \ 0 \ 1 \ 1 \ 0 \ 1 \ 1 \ 1 \ 1 \ 0 \ 1]$$

VIII. CONCLUSION

This paper proposes a linear complexity encoding method for general LDPC codes by analyzing and encoding their Tanner graphs. We show that two particular types of Tanner graphs—pseudo-trees and encoding stopping sets can be encoded in linear time. Then, we prove that any Tanner graph can be decomposed into pseudo-trees and encoding stopping sets. By encoding the pseudo-trees and encoding stopping sets in a sequential order, we achieve linear complexity encoding for arbitrary LDPC codes. The proposed method can be applied to a wide range of codes; it is not limited to LDPC codes. It is applicable to both regular LDPC codes and irregular LDPC codes. It is also good for both “low density” parity check nodes and “medium-to-high density” parity check nodes. In fact, the proposed linear time encoding method is applicable to any type of block codes. It removes the problem of high encoding complexity for all long block codes that historically are commonly encoded by matrix multiplication.

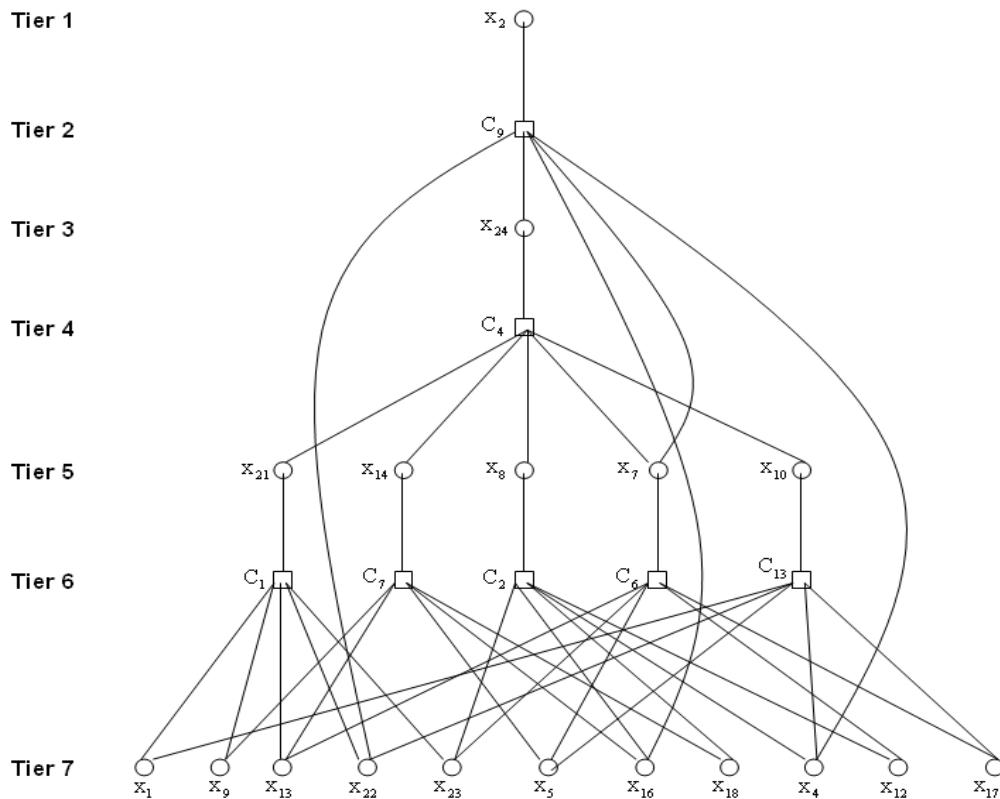

Fig. 11. A pseudo-tree built from the LDPC code described in (14).

APPENDIX A

FINDING REEVALUATED BITS x_γ AND x_δ IN A 2-FOLD-CONSTRAINT ENCODING STOPPING SET

The details are described in Algorithm 8.

REFERENCES

- [1] R. G. Gallager, *Low-Density Parity Check Codes*, MIT Press, Cambridge, MA, 1963.
- [2] D. J. C. Mackay, "Good error-correcting codes based on very sparse matrices," *IEEE Trans. Inform. Theory*, vol. 45, no. 2, pp. 399–431, March 1999.
- [3] G. Berrou and A. Glavieux and P. Thitimajshima, "Near Shannon limit error-correcting coding: Turbo codes," *Proc. 1993 International Conf. Comm.*, pp. 1064–1070, Geneva, Switzerland, May, 1993.
- [4] J. Lu, José M. F. Moura, and H. Zhang, "Efficient encoding of cycle codes: a graphical approach," *Proc. of 37th Asilomar Conference on Signals, Systems, and Computers*, pp. 69–73, PACIFIC GROVE, CA, Nov. 9–12, 2003.

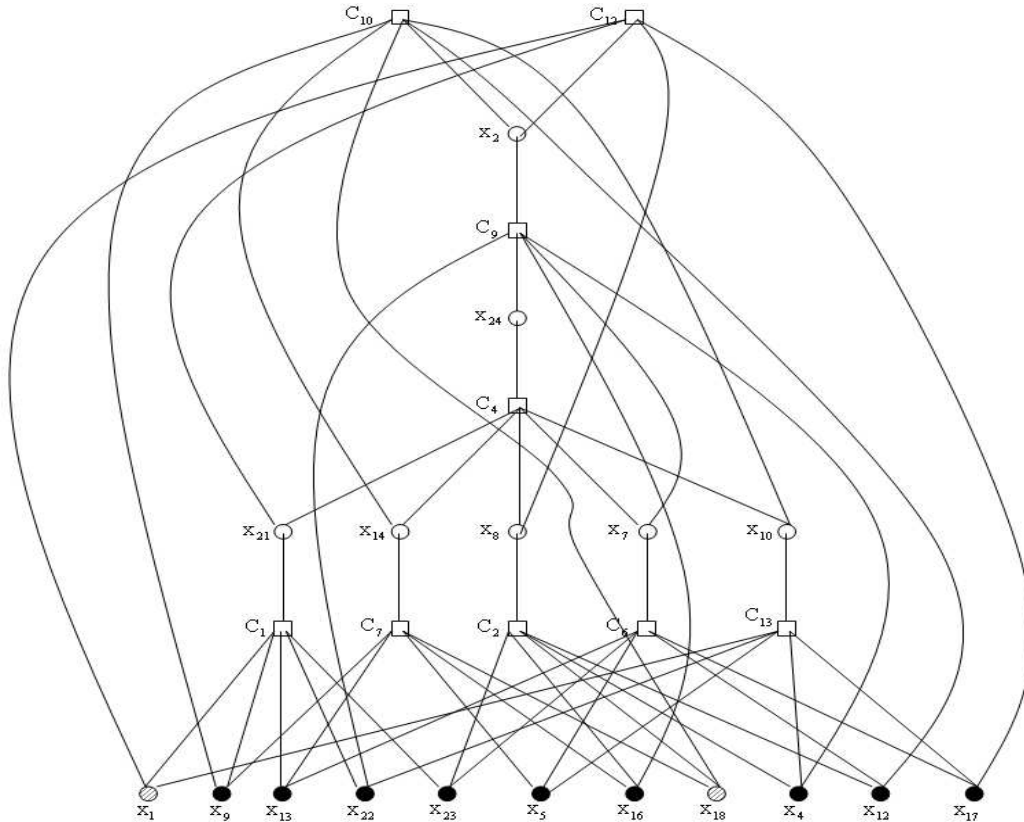

Fig. 12. An encoding stopping set developed from the LDPC code described in (14).

- [5] Z. Li, L. Chen, L. Zeng, S. Lin, and W. H. Fong, "Efficient encoding of quasi-cyclic low-density parity-check codes," *IEEE Trans. Comm.*, vol. 54, no. 1, pp. 71–81 Jan. 2006.
- [6] T. Mittelholzer, "Efficient encoding and minimum distance bounds of Reed-Solomon-type array codes," *Proc. of ISIT 2002*, pp. 282, Lausanne, Switzerland, 2002.
- [7] J. Lu and José M. F. Moura, "TS-LDPC codes: Turbo-structured codes with large girth," *IEEE Trans. Inform. Theory*, vol. 53, no. 3, pp. 1080–1094, Mar. 2007.
- [8] Y. Kou, S. Lin, and M. P. C. Fossorier, "Low-density parity-check codes based on finite geometries: a rediscovery and new results," *IEEE Trans. Inform. Theory*, vol. 47, no. 7, pp. 2711–2736, Nov. 2001.
- [9] S. J. Johnson and S. R. Weller "A Family of irregular LDPC codes with low encoding complexity," *IEEE Comm. Letters*, vol. 7, no. 2, pp. 79–81, Feb. 2003.
- [10] S. Freundlich, D. Burshtein, and S. Litsyn, "Approximately lower triangular ensembles of LDPC codes with linear encoding complexity," *IEEE Trans. Inform. Theory*, vol. 53, no. 4, pp. 1484–1494, Apr. 2007.
- [11] M. Yang, W. E. Ryan, and Y. Li "Design of efficiently encodable moderate-length high-rate irregular LDPC codes," *IEEE Trans. Comm.*, vol. 52, no. 4, pp. 564–570, Apr. 2004.
- [12] D. Haley, A. Grant, and J. Buetefuer, "Iterative encoding of low-density parity-check codes," in *Proc. of IEEE Globecom 2002*, vol. 2, pp. 1289–1293, Taipei, Taiwan, R.O.C., Nov. 2002.

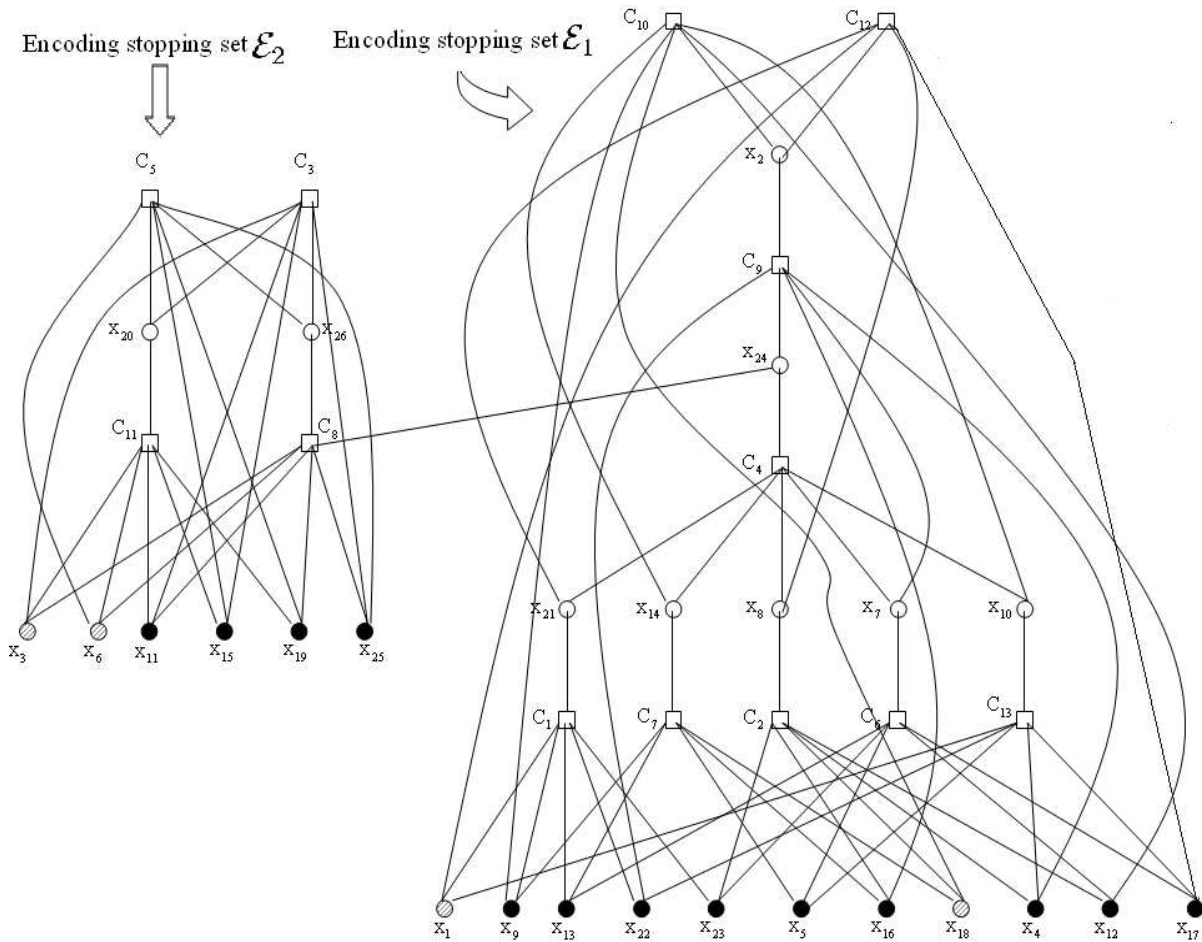

Fig. 13. Two encoding stopping sets developed from the LDPC code described in (14).

- [13] D. Haley and A. Grant, "High rate reversible LDPC codes," *Proc. of 5th Australian Communications Theory Workshop*, pp. 114-117, Newcastle, Australia, Feb. 2004.
- [14] T. J. Richardson and R. L. Urbanke, "Efficient encoding of low-density parity-check codes," *IEEE Trans. Inform. Theory*, vol. 47, no. 2, pp. 638-656, Feb. 2001.
- [15] R. M. Tanner, "A recursive approach to low complexity codes," *IEEE Trans. Inform. Theory*, vol. IT-27, no. 5, pp. 533-547, Sep. 1981.
- [16] C. Di, D. Proietti, E. Telatar, T. Richardson, and R. Urbanke, "Finite-length analysis of low-density parity-check codes on the binary erasure channel," *IEEE Trans. Inform. Theory*, vol. 48, no. 6, pp. 1570-1579, June 2002.

Algorithm 8 Finding reevaluated bits x_γ and x_δ in a 2-fold-constraint encoding stopping set

Represent the two key check equations C_α and C_β as functions of the information bits only.

Assume C_α is associated with q information bits $x_{\alpha_1}, x_{\alpha_2}, \dots, x_{\alpha_q}$ and C_β is associated with p information bits $x_{\beta_1}, x_{\beta_2}, \dots, x_{\beta_p}$.

$Flag \leftarrow 0$.

for $i = 1$ to q **do**

if x_{α_i} is contained in C_α but not in C_β **then**

$Flag \leftarrow 1$.

 Choose the reevaluated bit x_γ to be $x_\gamma = x_{\alpha_i}$.

 exit the for loop.

end if

end for

if $Flag = 1$ **then**

 Choose the reevaluated bit x_δ to be $x_\delta = x_{\beta_p}$.

else

 Choose the reevaluated bit x_γ to be $x_\gamma = x_{\alpha_q}$.

for $i = 1$ to p **do**

if x_{β_i} is contained in C_β but not in C_α **then**

 Choose the reevaluated bit x_δ to be $x_\delta = x_{\beta_i}$.

 exit the for loop.

end if

end for

end if

Output the two chosen reevaluated bits x_γ and x_δ .
