THE SPACE OF CLOSED SUBGROUPS OF \mathbb{R}^n

by

Benoît Kloeckner

Abstract. — The Chabauty space of a topological group is the set of its closed subgroups, endowed with a natural topology. As soon as $n > 2$, the Chabauty space of \mathbb{R}^n has a rather intricate topology and is not a manifold. By an investigation of its local structure, we fit it into a wider, but not too wild, class of topological spaces (namely Goresky-MacPherson stratified spaces). Thanks to a localization theorem, this local study also leads to the main result of this article: the Chabauty space of \mathbb{R}^n is simply connected for all n . Last, we give an alternative proof of the Hubbard-Pourezza Theorem, which describes the Chabauty space of \mathbb{R}^2 .

1. Introduction

Let G be a topological group whose neutral element is denoted by 0 (although G need not be abelian). Its *Chabauty space* $\mathcal{C}(G)$ is the set of closed subgroups of G endowed with the following topology: the neighborhoods of a point $\Gamma \in \mathcal{C}(G)$ are the sets

$$\mathcal{N}_U^K(\Gamma) = \{\Gamma' \in \mathcal{C}(G) \mid \Gamma' \cap K \subset \Gamma \cdot U \text{ and } \Gamma \cap K \subset \Gamma' \cdot U\}$$

where K runs over the compact subsets of G and U runs over the neighborhoods of 0. In words, Γ' is very close to Γ if, on a large compact set, every of its elements is in a uniformly small neighborhood of an element of Γ , and conversely. The preprint [10] contains a more detailed account of this topology.

The Chabauty space is named after Claude Chabauty, who introduced it in [3] to generalize Mahler's compactness criterion to lattices in locally compact groups. If G is locally compact, then $\mathcal{C}(G)$ is compact and can therefore be used to define a compactification of any space whose points are naturally associated to closed subgroups of G . For example, this is the case of a symmetric space of noncompact type: one maps a point to its stabilizer in the isometry group. The corresponding compactification is isomorphic to the Satake compactification [16, 1]. This compactification was generalized to buildings thanks to the Chabauty topology point of view in [9].

The simplest example of a Chabauty space is that of the line: $\mathcal{C}(\mathbb{R})$ contains the trivial subgroup $\{0\}$, the discrete groups $\alpha\mathbb{Z}$ and the total group \mathbb{R} . Two discrete

groups $\alpha\mathbb{Z}$ and $\beta\mathbb{Z}$ are close one to another when α and β are close, a neighborhood of $\{0\}$ consists in the set of $\alpha\mathbb{Z}$ with large α (and we define $\infty\mathbb{Z} = \{0\}$) and a neighborhood of \mathbb{R} consists in the set of $\alpha\mathbb{Z}$ with small α (and we define $0\mathbb{Z} = \mathbb{R}$). Putting all this together, we see that $\mathcal{C}(\mathbb{R})$ is homeomorphic to a closed interval.

$$\mathbb{R} = 0\mathbb{Z} \quad \alpha\mathbb{Z} \quad \{0\} = \infty\mathbb{Z}$$

FIGURE 1. Chabauty space of \mathbb{R} .

Only for a few groups G is known a precise description of $\mathcal{C}(G)$. Recent work of Bridson, de la Harpe and Kleptsyn adds to the list the three-dimensional Heisenberg group [2], but the topology of $\mathcal{C}(\mathbb{R}^n)$ is *terra incognita* for $n > 2$. Even $\mathcal{C}(\mathbb{R}^2)$ is uneasy to describe; it was tackled by Hubbard and Pourezza [14] who proved the following.

Theorem A (Hubbard-Pourezza). — *Let \mathcal{C} be the Chabauty space of \mathbb{R}^2 and \mathcal{L} be the subset of lattices. The topological pair $(\mathcal{C}, \mathcal{C} \setminus \mathcal{L})$ is homeomorphic to the suspension of (S^3, K) where K is a trefoil knot in the 3-sphere. In particular, \mathcal{C} is a 4-sphere.*

Let us recall some definitions. A *topological pair* is a pair (X, Y) of topological spaces where Y is a subset of X (endowed with the induced topology). Two topological pairs (X, Y) and (X', Y') are *homeomorphic* if there is a homeomorphism $\Phi : X \rightarrow X'$ that maps Y onto Y' . The (*open*) *cone* over X is the quotient cX of $X \times [0, 1]$ by the relation $(x_0, 0) \sim (x_1, 0)$, while the *suspension* of X is the quotient sX of $X \times [0, 1]$ by the relations $(x_0, 0) \sim (x_1, 0)$ and $(x_0, 1) \sim (x_1, 1)$ for all $x_0, x_1 \in X$. If Y is a subset of X , then sY embeds naturally in sX and the resulting topological pair (sX, sY) is called the suspension of (X, Y) .

The Hubbard-Pourezza theorem shows in particular that the set of non-lattices is a 2-sphere that is *non-tamely* embedded in $\mathcal{C}(\mathbb{R}^2)$. At the end of the paper we shall give a proof of Theorem A using Seifert fibrations. It is likely to be a variation of the alternative proof alluded to in [14], but we provide it so that this article is self-contained; we shall indeed see that Theorem A gives information on the “links” of some points in $\mathcal{C}(\mathbb{R}^n)$ for higher n .

Our main goal is to investigate the space $\mathcal{C}(\mathbb{R}^n)$. It is not a manifold when $n > 2$, and our first aim is to show that it fits into the more general framework of stratified spaces.

Theorem B. — *For all n , the Chabauty space of \mathbb{R}^n admits a Goresky-MacPherson stratification. If $n \geq 2$ it is moreover a pseudo-manifold.*

We shall give Goresky and MacPherson’s definitions of a stratification and pseudo-manifold later on; roughly, it means that $\mathcal{C}(\mathbb{R}^n)$ is a union of manifolds nicely glued together. Compact Goresky-MacPherson stratified spaces have for example a well-defined intersection homology, locally contractible homeomorphism group and extension of isotopy properties.

To prove Theorem B we shall unveil part of the *local* topology of $\mathcal{C}(\mathbb{R}^n)$. Its global topology seems difficult to make completely explicit. It might be possible to describe precisely $\mathcal{C}(\mathbb{R}^3)$, but as n grows the space becomes more and more complicated. Even if one describes each of its strata, the way they glue together is quite involved (even if locally trivial in some sense). In such a case, one tries to compute some topological invariants to get a grip on the space, the first one being its fundamental group. Our main result is the following.

Theorem C. — *For all n , the Chabauty space of \mathbb{R}^n is simply connected.*

Let us give a sketch of the proof of this result; in the sequel we often use the notation $\mathcal{C} := \mathcal{C}(\mathbb{R}^n)$. The subset $\mathcal{R}_m \subset \mathcal{C}$ of maximal rank subgroups (that is, subgroups containing a basis of vectors of \mathbb{R}^n) is open, dense and contractible. Its complement $\mathcal{R}_\ell := \mathcal{C} \setminus \mathcal{R}_m$ is a subspace of codimension n . If \mathcal{C} were a differentiable manifold, we could have proceeded by transversality arguments: any loop based in a point of \mathcal{R}_m would be homotopic to a generic smooth loop, transversal to \mathcal{R}_ℓ . But transversality between a submanifold of codimension > 1 and a curve would imply that they do not meet, and since \mathcal{R}_m is contractible the loop would then be nullhomotopic.

One must be very careful when trying to apply these arguments in more general spaces. For example, the cone over a disconnected manifold is a stratified space, and it is not true that a generic curve avoids its apex.

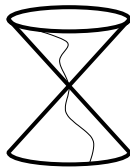

FIGURE 2. A generic curve does not avoid the apex.

This example is however very local in nature, and one guesses that if no such phenomenon occurs, then one should be able to proceed almost as if \mathcal{C} were a manifold. This guess is true, as is shown by the following relative homotopy localization result.

Theorem D (localization). — *Let X be a Hausdorff topological space and Y be a closed subset of X .*

If every point $y \in Y$ admits a neighborhood system $(U_\varepsilon)_\varepsilon$ such that each pair $(U_\varepsilon, U_\varepsilon \setminus Y)$ is k -connected, then the pair $(X, X \setminus Y)$ is k -connected.

In other words, under very mild assumptions a pair that is locally k -connected must be globally k -connected. Let us recall that a pair (X, U) is 0-connected if any point in X can be connected by a continuous path to a point in U . The pair is k -connected if moreover for all $\ell \leq k$, every map $(I^\ell, \partial I^\ell) \rightarrow (X, U)$ from the closed cube I^ℓ that maps its boundary into U is homotopic (relative to its boundary) to a map $I^\ell \rightarrow U$.

It would be very surprising that such a simple and helpful result be new, however I could not find a reference in the literature (except [4] where it is proved only for polyhedral pairs) and we shall therefore provide a proof.

The topics of the next sections are: some preliminaries and definitions (Section 2), stratifications (Section 3), the local study of $\mathcal{C}(\mathbb{R}^n)$ –including the proof of Theorem B (Section 4), proofs of Theorems C and D (Section 5), alternative proof of Theorem A (Section 6), and some open questions (Section 7).

Acknowledgements. — I wish to thank Lucien Guillou for topological discussions, Patrick Massot for patiently explaining Seifert fibration to me, and Pierre de la Harpe for both his comments on this article and his talk during the fourteenth Tripode meeting in Lyon, which made me discover the nice topic of Chabauty spaces.

2. Types and norms

We fix $n \in \mathbb{N}$ and consider the Chabauty space $\mathcal{C} = \mathcal{C}(\mathbb{R}^n)$.

Let \cdot denote the canonical scalar product on \mathbb{R}^n and $|\cdot|$ denote the corresponding Euclidean norm. It defines a distance not only on \mathbb{R}^n , but also on the Grassmannian $G(p; n)$ of all its p -dimensional sub-vector spaces (p -planes, for short). There are several classical ways to do this, but they do not differ for our purpose.

We denote under brackets $\langle \cdot \rangle$ the vector space generated by a subset of \mathbb{R}^n .

2.1. Types. — Let Γ be a point in \mathcal{C} . It is isomorphic to $\mathbb{R}^p \times \mathbb{Z}^q$ for some integers p, q . The pair (p, q) is called the *type* of Γ . The *rank* of Γ is the dimension of the vector space $\langle \Gamma \rangle$ it generates, that is $p + q$. An element of rank $< n$ is said to be of lower rank. We denote by \mathcal{R}_ℓ the set of lower rank elements of \mathcal{C} , by \mathcal{R}_m its complement and by $\mathcal{C}^{(p,q)}$ the set of type (p, q) elements. The Lie group $\mathrm{GL}(n; \mathbb{R})$ acts naturally on \mathcal{C} and its orbits are exactly the $\mathcal{C}^{(p,q)}$.

2.2. Norms. — Let Γ be a type (p, q) point in \mathcal{C} . For all positive r , let $\Gamma(r)$ be the subgroup of \mathbb{R}^n generated by $\Gamma \cap \overline{B}(0, r)$ where $\overline{B}(0, r)$ is the closed ball of radius r centered at the origin. Let $\Gamma_0 := \bigcap_{r>0} \Gamma(r)$ be the *continuous part* of Γ . It is a p -plane of \mathbb{R}^n .

If $p > 0$, then define

$$N_1(\Gamma) = \dots = N_p(\Gamma) = 0.$$

Let r_1 be the least number r such that $\Gamma(r) \neq \Gamma_0$ and p_1 be the rank of $\Gamma(r_1)$. Then define

$$N_{p+1}(\Gamma) = \dots = N_{p_1}(\Gamma) = r_1.$$

Define similarly $(r_2, p_2), \dots, (r_k, p_k)$ until $\Gamma(r_k) = \Gamma$. Then one has $q = p_k - p$. At last, define

$$N_{p+q+1}(\Gamma) = \dots = N_n(\Gamma) = \infty.$$

The number $N_i(\Gamma)$ is called the i -th norm of Γ . The norms are continuous functions $N_i : \mathcal{C} \rightarrow [0, \infty]$.

2.3. Decomposition. — Any $\Gamma \in \mathcal{C}$ has a *canonical decomposition* $\Gamma = \Gamma_0 + \Gamma_D$, where $\Gamma_D := \Gamma \cap \Gamma_0^\perp$ is a discrete rank q subgroup of \mathbb{R}^n .

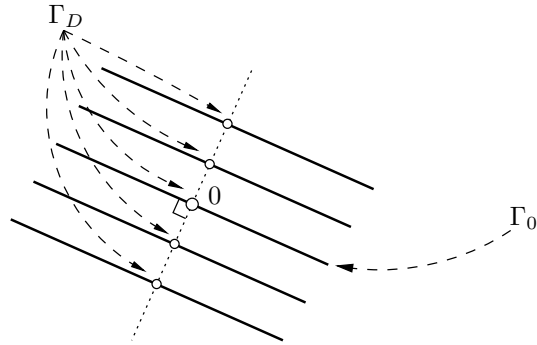
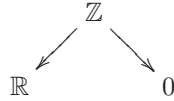

FIGURE 3. Canonical decomposition of a type (1,1) subgroup of \mathbb{R}^2 .

2.4. Combinatorial Structure. — Let us consider the incidence scheme of the different $\mathcal{C}^{(p,q)}$; these subsets are natural “strata” of \mathcal{C} .

If $n = 1$, there are three types, namely those of \mathbb{R} , \mathbb{Z} and the trivial group, from now on denoted by 0 . The closure of the second one contains the two other (both reduced to a point). We sum this up into the diagram:



If $n = 2$, there are six types, organized according to the diagram:

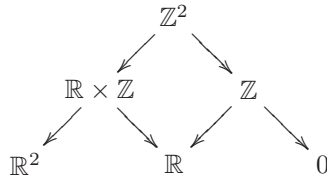

The diagram in the general case is:

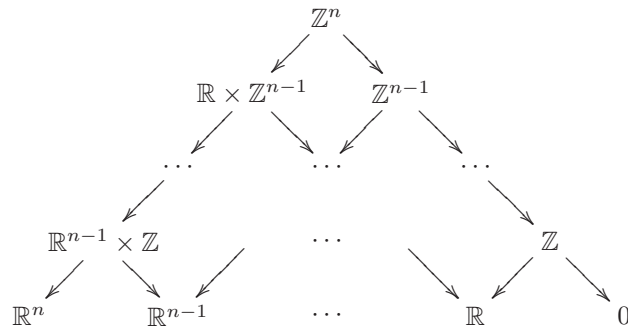

to be read as follows: the closure of the orbit of type (r, s) intersects the orbit of type (p, q) if and only if there is a sequence of arrows $\mathbb{R}^r \times \mathbb{Z}^s \rightarrow \cdots \rightarrow \mathbb{R}^p \times \mathbb{Z}^q$ (in which case we write $(r, s) \geq (p, q)$). A sequence of type (r, s) elements can indeed converge to a point of a different type in two (possibly simultaneous) ways: some of the non-zero, finite N_i go to 0 or to ∞ . In both cases s decreases; in the first one the rank is constant and r increases while in the second one r is constant and the rank decreases. In other words, $(r, s) \geq (p, q)$ if and only if $r \leq p$ and $r + s \geq p + q$: this is exactly what the diagram tells.

Note that for example each (lower left)-(upper right) diagonal corresponds to the subgroups of a given rank. In particular the largest of these diagonals corresponds to the set R of higher rank subgroups. Similarly, each (upper left)-(lower right) diagonal corresponds to the subgroups with continuous part of a given dimension, in particular the largest of these diagonals correspond to the set of discrete subgroups.

2.5. Duality. — There is a well-known duality on the space of lattices of \mathbb{R}^n . It extends word by word to the larger space $\mathcal{C}(\mathbb{R}^n)$: the duality map

$$\begin{aligned} * : \mathcal{C}(\mathbb{R}^n) &\rightarrow \mathcal{C}(\mathbb{R}^n) \\ \Gamma &\mapsto \Gamma^* = \{y \in \mathbb{R}^n \mid \forall x \in \Gamma \quad x \cdot y \in \mathbb{Z}\} \end{aligned}$$

is an involutory homeomorphism. The dual of a type (p, q) element is of type $(n - (p + q), q)$. In particular, in the terminology to be introduced in the next section, $*$ is a stratified isomorphism. On the above diagrams, duality induces a reflexion with respect to a vertical axis and one only needs to understand half of the types to understand them all.

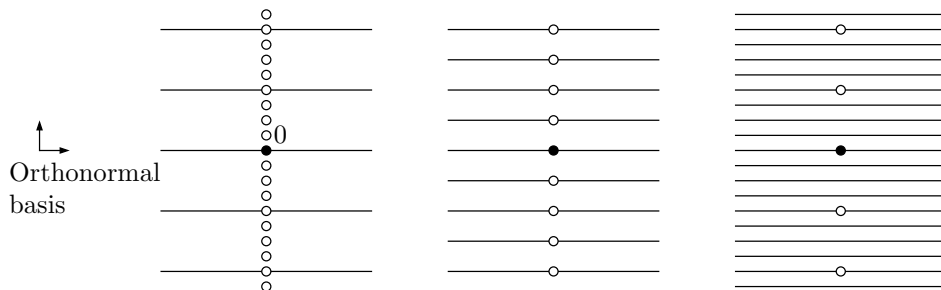

FIGURE 4. In \mathbb{R}^2 , three type $(1, 1)$ subgroups (dark lines) and their duals (white points).

3. Stratifications

There are many different types of stratifications; we shall use that of Mark Goresky and Robert MacPherson [6], but we also introduce more general definitions and that of Larry Siebenmann [17].

3.1. General definitions. —

Definition 3.1. — Let X be a metrizable separable topological space. A *stratification* of X is a locally finite partition $\mathcal{S} = (X^{(s)})_{s \in S}$ into locally closed subsets called *strata* such that the *frontier condition* holds: for all s, t in S , if $X^{(t)} \cap \overline{X^{(s)}} \neq \emptyset$ then $X^{(t)} \subset \overline{X^{(s)}}$. In other words, the closure of a stratum is a union of strata. The couple (X, \mathcal{S}) , often simply denoted by X , is called a *stratified space*.

In the works of Siebenmann and Goresky and MacPherson, the stratification are filtered by $\{0, 1, \dots, n\}$ rather than a more general set S . However, in the considered cases (CAT stratifications of finite dimension, see below) one can recover such a filtration, so that the above definition is in fact consistent with [17] and [6].

The point in stratifying a space is to divide it into simple pieces, and the strata should not be arbitrary for the stratification to be of interest. Most of the time, one asks that the strata belong to a category of manifolds and think of stratified spaces as an extension of manifolds that includes some singularities. The main motivation when Hassler Whitney introduced the first definition of a stratified space was to study the topology of analytic varieties [20, 21, 22]. René Thom used this concept to investigate the smooth maps between manifolds and their singularities [18]. Denote respectively by TOP, PL and DIFF the categories of topological, piecewise linear and smooth manifolds.

Definition 3.2. — Let CAT be a category of manifolds (TOP, PL, or DIFF). A stratification $(X^{(s)})_{s \in S}$ is a *CAT stratification* if all strata are objects of CAT and $X^{(t)} \subset \overline{X^{(s)}}$ implies $\dim X^{(t)} < \dim X^{(s)}$.

The *dimension* d of a CAT stratification is the supremum of the dimensions of the strata (possibly ∞). Its *singular codimension* is the difference $d - d'$ where d' is the second largest dimension of the strata.

The frontier condition is not very surprising since it is similar to a property of polyhedra (that is, topological realisation of simplicial complexes), where the closure of a face is a union of faces. To show its particular relevance, let us introduce a relation on the index set S of a stratification. Given two strata $X^{(s)}$ and $X^{(t)}$, one writes $t \leq s$ if $X^{(t)} \cap \overline{X^{(s)}} \neq \emptyset$. It is easy to see that the frontier condition implies that \leq is an ordering (the local closedness of strata is needed as well).

3.2. Goresky-MacPherson stratifications. — The class of stratified spaces is stable under several natural operations. The fact that the partitions given below are genuine stratifications is straightforward.

Definition 3.3. — If X and Y are stratified spaces with stratifications

$$\mathcal{S} = (X^{(s)})_{s \in S} \text{ and } \mathcal{T} = (Y^{(t)})_{t \in T}$$

the *product* $X \times Y$ is defined as the usual topological product endowed with the stratification

$$\mathcal{S} \times \mathcal{T} = \left(X^{(s)} \times Y^{(t)} \right)_{(s,t) \in S \times T}$$

Every open subset U of X inherits of the induced stratification $(U \cap X^{(s)})_{s \in S'}$ where S' is the set of indices s such that $X^{(s)}$ meets U .

The open cone $cX = X \times [0, 1) / X \times \{0\}$ of a compact stratified space has a natural stratification, whose strata are the apex and the products $X^{(s)} \times (0, 1)$. Such a cX is called a *stratified cone*. The cone on the empty set is defined to be a point.

Recall that the *join* of the topological spaces X and Y is the quotient of $X \times Y \times [0, 1]$ by the relations $(x, y, 0) \sim (x', y, 0)$ and $(x, y, 1) \sim (x, y', 1)$ (figure 5 shows examples). We simply denote by $A \times \{1\}$ the image in this quotient of a set $A \times Y \times \{1\}$ when $A \subset X$. When X and Y are stratified, their join $X \star Y$ can be endowed with a natural stratification. Let $S \star T$ be the disjoint union of S, T and $S \times T$; the desired stratification $\mathcal{S} \star \mathcal{T}$ is indexed by $S \star T$, with strata

$$\begin{aligned} (X \star Y)^{(s)} &= X^{(s)} \times \{1\} \\ (X \star Y)^{(t)} &= Y^{(t)} \times \{0\} \\ (X \star Y)^{(s,t)} &= X^{(s)} \times Y^{(t)} \times (0, 1) \end{aligned}$$

Remark that the suspension of a space is simply its join with S^0 , a pair of distinct points.

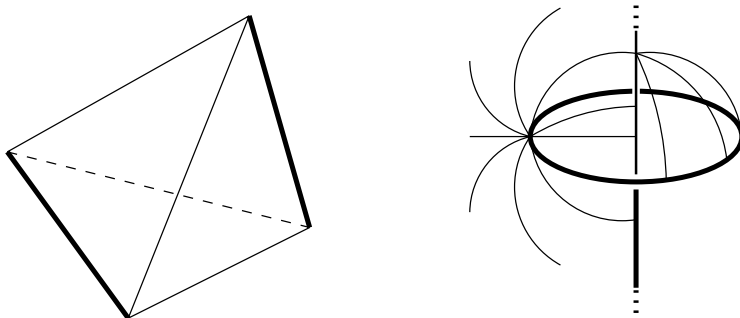

FIGURE 5. The join of two segments is a 3-simplex. The join of two circles is a 3-sphere, the contracted part being two Hopf fibers.

Next we need to define isomorphisms.

Definition 3.4. — If X and Y are stratified spaces, a continuous map $f : X \rightarrow Y$ is said to be *stratified* if the inverse image of every stratum of Y is a stratum of X . It is a *stratified isomorphism* (or simply, an isomorphism) if it is stratified and a homeomorphism.

One defines in an obvious way *PL* and *DIFF* stratified maps and isomorphisms.

We are now able to introduce a local triviality condition on which the notions of Siebenmann and Goresky-MacPherson stratified spaces rely.

Definition 3.5. — A stratified space X is *locally cone-like* if for any point $x \in X$, there is an open neighborhood U of x in its stratum $X^{(s)}$, a stratified cone cL and an

isomorphism of $U \times cL$ onto an open neighborhood of x in X such that $U \times \{\text{apex}\}$ is mapped identically onto U . The stratified space L is called a *link* of x (it need not be unique since there exist non homeomorphic spaces whose cones are homeomorphic).

A *Siebenmann stratified space* is a finite-dimensional, locally cone-like, TOP stratified space.

A *Goresky-MacPherson stratified space* of dimension n is defined recursively as a n -dimensional Siebenmann stratified space, whose points admit links that are lesser-dimensional Goresky-MacPherson stratified spaces. One can define similarly PL and DIFF Siebenmann and Goresky-MacPherson stratified spaces.

A *pseudo-manifold* is a Goresky-MacPherson stratified space where the union of maximal dimensional strata is dense, and whose singular codimension is at least 2.

What we call a Siebenmann stratified space is a “CS set” in Siebenmann’s terminology. Due to the numerous definitions introduced by different authors, it seems better to use the authors’ names to distinguish between them. Note that in [5], contrary to [6], the stratified spaces considered are PL.

It seems to be an open question whether it exists a Siebenmann stratified space that is not Goresky-MacPherson stratified.

Simple examples of Goresky-MacPherson stratified spaces are manifold with boundary (the strata being the interior and the boundary) and polyhedron (stratified by their faces). A consequence of Thom’s “first isotopy lemma” is that analytic varieties can be endowed with a Goresky-MacPherson stratification, see for example [7] Section I.1.4. In particular, complex analytic varieties are pseudo-manifolds.

3.3. Some properties. — Compact Siebenmann stratified spaces have several nice properties. For example, their homeomorphism groups are locally contractible. See [17] for more details. More important to us, it gives a very natural way to describe $\mathcal{C} = \mathcal{C}(\mathbb{R}^n)$ locally: the types will index the strata $\mathcal{C}^{(p,q)}$ and since their dimension is easy to compute, the description of neighborhoods of a point reduces to a link.

Among Goresky-MacPherson stratified spaces, pseudo-manifolds are of utmost importance since they have a so-called intersection homology satisfying some sort of Poincaré duality. It encodes in particular the usual homology. Since it is not much more difficult to prove that $\mathcal{C}(\mathbb{R}^n)$ is Goresky-MacPherson than to prove that it is Siebenmann, it seemed better to use this definition even if we do not compute the intersection homology of $\mathcal{C}(\mathbb{R}^n)$. Note that the codimensions of the strata need not be even, so that there is no self-dual perversity for $\mathcal{C}(\mathbb{R}^n)$.

Let us turn to a remarkable fact: the product of two Siebenmann stratified space is Siebenmann stratified. The only part that is not obvious in this statement is that a product of two cones is again a cone.

Lemma 3.6. — *Let X and Y be stratified spaces. Then we have an isomorphism of stratified spaces $cX \times cY \simeq c(X \star Y)$.*

Proof. — We write the elements of cX in the form (x, h) where $h \in [0, 1[$ and $x \in X$, the latter being meaningless when $h = 0$.

The subset $\{(x, h), (y, \ell) \in cX \times cY; h + \ell < 1\}$ is isomorphic to $cX \times cY$, and is the cone over the subset $\Delta = \{(x, h), (y, \ell) \in cX \times cY; h + \ell = \delta\}$ for any $\delta < 1$.

To see that Δ is isomorphic to $X \star Y$, simply consider the map

$$\begin{aligned} X \times Y \times [0, \delta] &\rightarrow \Delta \\ (x, y, m) &\mapsto ((x, m), (y, \delta - m)) \end{aligned}$$

(see figure 6). □

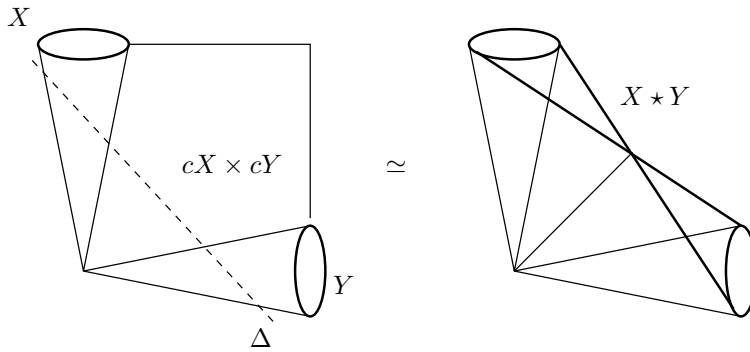

FIGURE 6. The product of cones is a cone.

Since a join is locally a product (possibly involving a cone), the join of two Siebenmann stratified spaces is again Siebenmann stratified. Then a straightforward induction leads to : the product, the join and the cone of Goresky-MacPherson stratified spaces are Goresky-MacPherson stratified.

3.4. Stratified bundles. — Some of the links in $\mathcal{C}(\mathbb{R}^n)$ shall be described as some sort of fiber bundles, where the fiber depends upon the strata. Note that we define such bundles only in the category of Goresky-MacPherson stratified spaces.

Definition 3.7. — A *stratified bundle* is defined inductively as a surjective continuous map $\pi : E \rightarrow B$ where:

- E is a metrizable separable topological space called the *total space*,
- B is a Goresky-MacPherson stratified space (with stratification $(B^{(s)})_{s \in S}$) called the *base*,
- there are topological manifolds F_s called the *fibers* such that all $x \in B$ (in the s strata, with link L say) has a conical neighborhood $V \simeq \mathbb{R}^k \times cL$ such that $\pi^{-1}(V) \simeq \mathbb{R}^k \times F_s \times cL'$ where L' is a compact Goresky-MacPherson stratified space and π writes in the form

$$\pi(b, f, (t, l')) = (b, (t, \pi'(l'))) \quad \forall b \in \mathbb{R}^k, \forall f \in F_s, \forall (t, l') \in cL'$$

where $\pi' : L' \rightarrow L$ is a stratified bundle.

One defines similarly PL or DIFF stratified bundles in the category of PL or DIFF Goresky-MacPherson stratified spaces.

We could have assumed E to be a Goresky-MacPherson stratified space and π to be a stratified map, but this is not necessary.

Lemma 3.8. — *If $\pi : E \rightarrow B$ is a stratified bundle, the partition $E^{(s)} = \pi^{-1}(B^{(s)})$ is a Goresky-MacPherson stratification.*

Proof. — First, let us show that the frontier condition holds. Let s and t be indices such that $E^{(t)} \cap \overline{E^{(s)}} \neq \emptyset$ and $z \in E^{(t)}$. Then $B^{(t)} \subset \overline{B^{(s)}}$ and there is a sequence $x_n \in B^{(s)}$ that converges to $\pi(z)$. Thanks to the local form of π , we can lift x_n to a sequence $z_n \in E^{(s)}$ that converges to z .

Local closedness of strata and local finiteness of the partition are direct consequences of the definition, as well as the strata being topological manifolds and satisfying the dimension condition. The partition $(E^{(s)})_{s \in S}$ is therefore a TOP stratification.

The local form of π implies readily that it is also a Siebenmann stratification, and an induction on the dimension of B shows at last that it is Goresky-MacPherson. \square

This definition of a stratified bundle is a generalization of fiber bundles over manifolds, since the restriction of π to $E^{(s)} \rightarrow B^{(s)}$ is a fiber bundle in the usual sense for all $s \in S$. It is however quite restrictive, in particular the family of fibers cannot be arbitrary: if $s \geq t$, then F_s must be homeomorphic to $F_t \times F'_s$ where F'_s is the fiber over $L^{(s)}$ for the bundle π' . In the stratified bundles that appear in the local study of $\mathcal{C}(\mathbb{R}^n)$, the fibers are tori whose dimension depends upon the strata.

4. Local study of $\mathcal{C}(\mathbb{R}^n)$

4.1. Stratification of $\mathcal{C}(\mathbb{R}^n)$. — Let us start with the simplest part of Theorem B.

Proposition 4.1. — *The partition $(\mathcal{C}^{(p,q)})_{(p,q) \in S}$ is a DIFF stratification of \mathcal{C} .*

Proof. — First, \mathcal{C} is known to be metrizable and compact (see for example [10]).

To see that the strata are locally closed, it is sufficient to have a look at a neighborhood U of a point $\Gamma \in \mathcal{C}^{(p,q)}$ that is sufficiently small to ensure that

$$N_{p+1}, \dots, N_{p+q} \in (0, \infty)$$

for all elements of U . There the strata is defined by the equations $N_1 = \dots = N_p = 0$ and $N_{p+q+1} = \dots = N_n = \infty$, thus $U \cap \mathcal{C}^{(p,q)}$ is closed in U .

The frontier condition, anyway simple to get from a direct study, comes for free from the description of strata as orbits of the action of $\mathrm{GL}(n; \mathbb{R})$: if $\mathcal{C}^{(p,q)}$ intersects $\overline{\mathcal{C}^{(r,s)}}$, then there is a sequence $\Gamma_n \in \mathcal{C}^{(r,s)}$ that converges to some $\Gamma_\infty \in \mathcal{C}^{(p,q)}$. For all $\Gamma \in \mathcal{C}^{(p,q)}$ there is a $g \in \mathrm{GL}(n; \mathbb{R})$ such that $\Gamma = g(\Gamma_\infty)$, and the sequence $g(\Gamma_n)$ converges to Γ , hence $\mathcal{C}^{(p,q)} \subset \overline{\mathcal{C}^{(r,s)}}$.

We also get the manifold structures on strata from this action: for all (p, q) , the stabilizer of the element $\mathbb{R}^p \times \mathbb{Z}^q = e_1\mathbb{R} + \dots + e_p\mathbb{R} + e_{p+1}\mathbb{Z} + \dots + e_{p+q}\mathbb{Z}$ (where (e_i) is the canonical basis of \mathbb{R}^n) of $\mathcal{C}^{(p,q)}$ is a closed subgroup $H_{(p,q)}$ of $\mathrm{GL}(n; \mathbb{R})$, thus a Lie subgroup. We can endow $\mathcal{C}^{(p,q)}$ with the manifold structure of $\mathrm{GL}(n; \mathbb{R})/H_{(p,q)}$.

Last, the dimension of $\mathcal{C}^{(p,q)}$ is easily computed: the continuous part is an element of $G(p;n)$, which has dimension $p(n-p)$, and the discrete part is defined by the choice of q vectors in a $(n-p)$ plane. We get that

$$\dim \mathcal{C}^{(p,q)} = (p+q)(n-p)$$

in particular $\dim \mathcal{C}^{(r,s)} > \dim \mathcal{C}^{(p,q)}$ as soon as $(r,s) > (p,q)$. \square

Note that in the sequel it will be simpler to prove only the TOP stratification of links, so we mainly think of $\mathcal{C}(\mathbb{R}^n)$ as a TOP stratified space.

4.2. Decomposition at a given scale. — Let us introduce a number of definitions to be used in the next subsection. They aim to give a parametrization of neighborhoods in $\mathcal{C}(\mathbb{R}^n)$, by decomposing subgroups at three scales. We could define more general definitions, involving more different scales but the following is sufficient for our purpose.

4.2.1. δ -decomposability. — A *scale* is a number $\delta \in (0, 1)$, usually small. An element $\Gamma \in \mathcal{C}(\mathbb{R}^n)$ is said to be *decomposable at scale δ* if for all i , $N_i(\Gamma) \notin \{\delta, \delta^{-1}\}$. We then say that Γ has *δ -type (p, q)* if

$$\begin{cases} N_1(\Gamma), \dots, N_p(\Gamma) < \delta \\ N_{p+1}(\Gamma), \dots, N_{p+q}(\Gamma) \in (\delta, \delta^{-1}) \\ N_{p+q+1}(\Gamma), \dots, N_n(\Gamma) > \delta^{-1} \end{cases}$$

Note that the δ -type of Γ is always at most its type (with respect to the order of Section 2.4, that is the order given by the frontier condition).

4.2.2. Local trivialisation. — The motivation for this paragraph is the following. We shall associate to a δ -decomposable element a triple of vector spaces, generated by three parts of Γ (one at small scale, one at medium scale and one at large scale). To compare close δ -decomposable elements, we need to fix an identification between close subspaces of \mathbb{R}^n .

A *linear decomposition* of type (p, q) of \mathbb{R}^n is a triple (V_1, V_2, V_3) where V_1 is a p -plane, V_2 is a q -plane, V_3 is a $(n - (p + q))$ -plane and

$$\mathbb{R}^n = V_1 \oplus V_2 \oplus V_3$$

A linear decompositions of type (p, q) can be naturally identified with the $(p, p + q)$ flag $(V_1, V_1 + V_2)$. We therefore denote by $G(p, p + q; n)$ the set of all type (p, q) linear decomposition. It is a manifold, and inherits a metric from the Euclidean structure of \mathbb{R}^n .

Given a type (p, q) linear decomposition (V_1^0, V_2^0, V_3^0) , there is a small ball V in $G(p, p + q; n)$ centered at (V_1^0, V_2^0, V_3^0) and a small ball U around the identity in a submanifold of $\text{SO}(n)$ such that for all (V_1, V_2, V_3) in V , there is a unique $\tau \in U$ (called the trivialisation of (V_1, V_2, V_3)) such that $\tau(V_1, V_2, V_3) = (V_1^0, V_2^0, V_3^0)$. Moreover the mapping $(V_1, V_2, V_3) \mapsto \tau$ can be chosen a diffeomorphism. From now on, we assume that for all (V_1^0, V_2^0, V_3^0) we have chosen such a mapping (called a *local trivialisation*).

Let Γ be a δ -decomposable element of δ -type (p, q) . The *linear decomposition* (at scale δ) of Γ is defined as follows. First, $V_1 = \langle \Gamma(\delta) \rangle$ is the p -plane generated by

the element of γ of norm less than δ . We denote by P'_2 the orthogonal projection on V_1^\perp . Then $V_2 = \langle P'_2 \Gamma(\delta^{-1}) \rangle$ is a q -plane orthogonal to V_1 . At last, V_3 is defined as $(V_1 + V_2)^\perp$, and by construction (V_1, V_2, V_3) is a linear decomposition.

4.2.3. Parametrization of a neighborhood. — Let us define a parametrization of a neighborhood of a type (p, q) element Γ^0 in $\mathcal{C}(\mathbb{R}^n)$. Let $V_1^0 = \Gamma_0^0$ be its continuous part and $V_2^0 = \langle \Gamma_D^0 \rangle$ be the q -plane generated by its discrete part (which is orthogonal to V_1^0). We define $V_3^0 = (V_1^0 + V_2^0)^\perp$ and we assume that a basis $(e_{p+1}, \dots, e_{p+q})$ of Γ_D has been fixed. In what follows the dependence on this basis is not crucial. For convenience, we also assume that we have fixed linear isomorphisms $V_0^1 \simeq \mathbb{R}^p$, $\Gamma_D^0 \simeq \mathbb{Z}^q$ (identifying $(e_{p+1}, \dots, e_{p+q})$ with the canonical basis) and $V_0^1 \simeq \mathbb{R}^{n-(p+q)}$. We may use these identifications without notice.

Choose a small scale δ . The required smallness will be precised at several steps below. First we assume that $\delta < N_{p+1}(\Gamma^0)$ and $\delta^{-1} > N_{p+q}(\Gamma^0)$, so that Γ^0 has δ -type (p, q) and (V_1^0, V_2^0, V_3^0) is its linear decomposition at scale δ .

Then define U as the set of all $\Gamma \in \mathcal{C}(\mathbb{R}^n)$ such that:

- Γ is δ -decomposable,
- its linear decomposition (V_1, V_2, V_3) is δ -close to (V_1^0, V_2^0, V_3^0) ,
- denoting by τ the corresponding trivialisation and by P_2 the orthogonal projection onto V_2 , $\tau P_2(\Gamma(\delta^{-1})) \subset V_2^0$ is generated by vectors v_{p+1}, \dots, v_{p+q} such that $|e_i - v_i| < \delta$ for all i ,

It is an open neighborhood of Γ^0 . From a $\Gamma \in U$ we construct its *local decomposition* $(\Gamma_1, \Gamma_2, \Gamma_3, \Phi_2, \Phi_3)$ as follows. First, $\Gamma_1 = \tau \Gamma(\delta)$ is a closed subgroup of $V_1^0 \simeq \mathbb{R}^p$ of maximal rank in $\mathcal{C}(\mathbb{R}^p)$. Second, $\Gamma_2 = \tau P_2(\Gamma(\delta^{-1}))$ is a discrete subgroup of V_2^0 close to $\Gamma_D \simeq \mathbb{Z}^q$. The *distinguished basis* of Γ_2 is the basis v_{p+1}, \dots, v_{p+q} that satisfies $|e_i - v_i| < \delta$ for all i (we assume δ is small enough to ensure that this basis is uniquely defined). This distinguished basis defines an identification between Γ_2 and \mathbb{Z}^q . Third, denoting by P_3 the orthogonal projection onto V_3 , $\Gamma_3 = \tau P_3(\Gamma)$ is a discrete subgroup of $V_3^0 \simeq \mathbb{R}^{n-(p+q)}$.

Now $\Phi_2 : \mathbb{Z}^q \rightarrow V_1^0/\Gamma_1$ is the unique homomorphism such that $\Gamma(\delta^{-1})$ is generated by the sets $\tau^{-1}(v_i + \Phi_2(e_i))$ for $p < i \leq p+q$. Note that here we consider $\Phi_2(e_i)$ as a Γ_1 coset in V_1^0 . Figure 7 illustrates this map. Last, $\Phi_3 : \Gamma_3 \rightarrow (V_1^0 + V_2^0)/(\Gamma_1 + \Gamma_2)$ (where the range can be identified with $\mathbb{R}^p/\Gamma_1 \times \mathbb{R}^q/\mathbb{Z}^q$) is the unique homomorphism such that Γ is the union of the $\tau^{-1}(v + \Phi_3(v))$ for $v \in \Gamma_3$. It can be useful to further decompose Φ_3 into $\Phi'_3 : \Gamma_3 \rightarrow V_1^0/\Gamma_1$ and $\Phi''_3 : \Gamma_3 \rightarrow V_2^0/\Gamma_2 \simeq \mathbb{R}^q/\mathbb{Z}^q$.

From the linear and local decompositions of Γ , it is easy to reconstruct Γ . The map

$$\Gamma \mapsto ((V_1, V_2, V_3), (\Gamma_1, \Gamma_2, \Gamma_3, \Phi_2, \Phi_3))$$

and its inverse are moreover continuous.

It will be simpler in the sequel to use the part of U defined by

$$N_p(\Gamma_1) + N_{p+q+1}(\Gamma_3)^{-1} < \delta$$

(note that $N_{p+q+1}(\Gamma_3)$ is the first norm of Γ_3 viewed as an element of $\mathcal{C}(\mathbb{R}^{n-(p+q)})$). This neighborhood is denoted by $U_\delta^n(\Gamma^0)$.

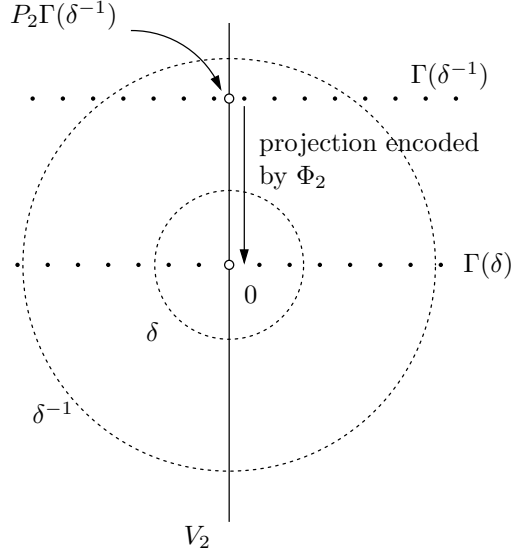

FIGURE 7. The map Φ_2 enables the recovering of $\Gamma(\delta^{-1})$ from Γ_1 , Γ_2 and the local trivialisation τ (in this example, Γ has δ -type $(1, 1)$).

4.3. Neighborhoods in $\mathcal{C}(\mathbb{R}^n)$. —

Now are now ready to prove Theorem B.

Lemma 4.2. — *The trivial subgroup $0 \in \mathcal{C}(\mathbb{R}^n)$ has a neighborhood of the form $cL^n(0)$ where the link $L^n(0)$ is the set of subgroups of unit (first) norm, stratified by its intersection with the strata of $\mathcal{C}(\mathbb{R}^n)$.*

Proof. — The neighborhood $U_1^n(0)$ defined above is the set of elements of norm greater than 1. The map

$$\begin{aligned} [0, 1) \times L^n(0) &\rightarrow U_1^n(0) \\ (t, \Gamma) &\mapsto t^{-1}\Gamma \end{aligned}$$

(with the convention $\infty\Gamma = \Gamma_0$, here $\Gamma_0 = 0$) is continuous and induces a homeomorphism $cL^n(0) \rightarrow U_1^n(0)$.

Since $U_1^n(0) \setminus \{0\} \simeq (0, 1) \times L^n(0)$ is open, it inherits a stratification from that of $\mathcal{C}(\mathbb{R}^n)$. It follows that the intersections of $L^n(0)$ with the strata $\mathcal{C}^{(p,q)}$ does define a stratification. The above homeomorphism becomes a stratified isomorphism when $L^n(0)$ is given this stratification. \square

Note that we could do the same with any fixed value for the first norm instead of 1.

The local study of the total group follows immediately from that of 0.

Lemma 4.3. — *The total group $\mathbb{R}^n \in \mathcal{C}(\mathbb{R}^n)$ has a neighborhood $cL^n(\mathbb{R}^n)$ where $L^n(\mathbb{R}^n) \simeq L^n(0)$ is the set of subgroups of n -th norm 1.*

Proof. — The duality map $*$ is a stratified isomorphism and maps 0 to \mathbb{R}^n . It must therefore map $U_1^n(0)$ onto a neighborhood of \mathbb{R}^n . We can also reproduce the proof of Lemma 4.2: the neighborhood $U_1^n(\mathbb{R}^n)$ is the set of elements of n -th norm at most 1 and the map

$$\begin{aligned} [0, 1) \times L^n(\mathbb{R}^n) &\rightarrow U_1^n(\mathbb{R}^n) \\ (t, \Gamma) &\mapsto t\Gamma \end{aligned}$$

(with the convention $0\Gamma = \langle \Gamma \rangle$, here $\langle \Gamma \rangle = \mathbb{R}^n$) induces an isomorphism $cL^n(\mathbb{R}^n) \rightarrow U_1^n(\mathbb{R}^n)$. \square

Lemma 4.4. — *Any type (p, q) element $\Gamma^0 \in \mathcal{C}(\mathbb{R}^n)$ has a neighborhood of the form $\mathbb{R}^{(n-p)(p+q)} \times cL$ where the link $L = L^n(\Gamma^0)$ is defined in $U_\delta^n(\Gamma^0)$ (where δ is any small enough scale) by the equations*

$$\begin{aligned} (V_1, V_2, V_3) &= (V_1^0, V_2^0, V_3^0) \\ \Gamma_2 &= \Gamma_D^0 \\ N_p(\Gamma_1) + N_{p+q+1}(\Gamma_3)^{-1} &= \delta/2 \end{aligned}$$

where we use the notations of Section 4.2.3.

Implicitly, L is stratified by its intersection with the strata of $\mathcal{C}(\mathbb{R}^n)$.

Proof. — By homogeneity of strata we can restrict to $\Gamma^0 = \mathbb{R}^p \times \mathbb{Z}^q$. Consider its neighborhood $U_\delta^n(\mathbb{R}^p \times \mathbb{Z}^q)$: an element Γ there has a linear decomposition at scale δ (V_1, V_2, V_3) and a local decomposition $(\Gamma_1, \Gamma_2, \Gamma_3, \Phi_2, \Phi_3)$. Its projection to $\mathcal{C}^{(p,q)}$ is defined as $V_1 + \tau^{-1}(\Gamma_2) \subset V_1 + V_2$. It can be arbitrary in a neighborhood of $\mathbb{R}^p \times \mathbb{Z}^q$ in $\mathcal{C}^{(p,q)}$. As a consequence, $U_\delta^n(\mathbb{R}^p \times \mathbb{Z}^q)$ is isomorphic the product of two sets, the set of possible choice of $(V_1, V_2, V_3, \Gamma_2)$, which is a $(n-p)(p+q)$ -dimensional ball, and the set M of possible choices of $(\Gamma_1, \Gamma_3, \Phi_2, \Phi_3)$. This last set is of course stratified by the type (r, s) of the corresponding point Γ . This type depends only upon (Γ_1, Γ_3) .

Apart from the choice of Φ_2 and Φ_3 , M looks like the product of two cones $cL^p(\mathbb{R}^p)$ and $cL^{n-(p+q)}(0)$, and we proceed as in the proof of Lemma 3.6. The map

$$\begin{aligned} [0, 2) \times L^n(\mathbb{R}^p \times \mathbb{Z}^q) &\rightarrow M \\ (t, \Gamma_1, \Gamma_3, \Phi_2, \Phi_3) &\mapsto (t\Gamma_1, t^{-1}\Gamma_3, t\Phi_2, \Phi_3^t) \end{aligned}$$

(where $\Phi_3^t(t^{-1}\gamma) := (t\Phi_3'(\gamma), \Phi_3''(\gamma))$ for all $\gamma \in \Gamma_3$) induces the required isomorphism $cL^n(\mathbb{R}^p \times \mathbb{Z}^q) \rightarrow M$. \square

Note that Lemmas 4.2, 4.3 are included in this result. We now can tell that $\mathcal{C}(\mathbb{R}^n)$ is Siebenmann stratified, but we can get more.

Lemma 4.5. — *Let $\Gamma_0 \in \mathcal{C}(\mathbb{R}^n)$ and consider an element $\Gamma \in \mathcal{C}(\mathbb{R}^n)$ that lies on the link $L^n(\Gamma_0)$. For small enough δ , the neighborhood $U_\delta^n(\Gamma) \cap L^n(\Gamma_0)$ of Γ in $L^n(\Gamma_0)$ is of the form $\mathbb{R}^k \times cL^n(\Gamma)$ (where k depends on the types of Γ_0 and Γ).*

Proof. — This follows directly from previous lemma. Let (p, q) and (r, s) be the types of Γ_0 and Γ . Up to a change of scale $cL^n(\Gamma) \subset L^n(\Gamma_0)$ and $L^n(\Gamma_0)$ intersects the (r, s) strata of $U_\delta^n(\Gamma)$ along a submanifold of $\mathbb{R}^{(n-r)(r+s)}$. \square

The following last lemma settles the proof of Theorem B and shows how the general links are related to the $L^k(0)$.

Lemma 4.6. — *For all (p, q) , the link $L = L^n(\mathbb{R}^p \times \mathbb{Z}^q)$ is a Goresky-MacPherson stratified space.*

Moreover, if (p, q) is different from $(0, 0)$ and $(n, 0)$, then the map

$$\begin{aligned} \pi = \pi(n, p, q) : L = L^n(\mathbb{R}^p \times \mathbb{Z}^q) &\rightarrow L^p(\mathbb{R}^p) \star L^{n-(p+q)}(0) \\ (\Gamma_1, \Gamma_3, \Phi_2, \Phi_3) &\mapsto \left(N_p(\Gamma_1)^{-1} \cdot \Gamma_1; N_{p+q+1}(\Gamma_3) \cdot \Gamma_3; \frac{2}{\delta} N_p(\Gamma_1) \right) \end{aligned}$$

is a stratified bundle and for all $(r, s) > (p, q)$ the fiber over the stratum $L^{(r,s)}$ is a torus of dimension

$$q(p-r) + (r+s-p-q)(p+q-r)$$

Proof. — The proof of the first part is by decreasing induction on (p, q) , with respect to the usual ordering obtained from the condition of frontier.

If $(p, q) = (0, n)$, the link $L^n(\mathbb{Z}^n)$ is empty. If $(p, q) < (0, n)$, Lemma 4.5 shows that the link $L = L^n(\mathbb{R}^p \times \mathbb{Z}^q)$ is a cone-like TOP stratified space with links of the form $L^n(\mathbb{R}^r \times \mathbb{Z}^s)$ with $(r, s) > (p, q)$, which are Goresky-MacPherson stratified by induction hypothesis.

For the second part, first remark that the map π restricts to a (classical) fiber bundle on each strata, and the fibers corresponds to the choice of Φ_2 and Φ_3 when given Γ_1 and Γ_3 . Each of these maps is defined by the image in a torus (of respective dimension $p-r$ and $p+q-r$) of a basis of a lattice (of respective rank q and $(r+s-p-q)$); this gives the claimed topology for the fibers.

Next we proceed by a similar induction than above. If $(p, q) \leq (0, n)$ and $(\Gamma_1, \Gamma_3, \lambda)$ is a point in $L^p(\mathbb{R}^p) \star L^{n-(p+q)}(0)$, then $(r, s) > (p, q)$ where r is the dimension of the continuous part of Γ_1 and $r+s-p-q$ is the rank of Γ_3 . If U is a small enough neighborhood of $(\Gamma_1, \Gamma_3, \lambda)$ and $V = \pi^{-1}(U)$, then the restriction of π to $V \rightarrow U$ writes in the form required by Definition 3.7 with $\pi' = \pi(n, r, s)$, thus is a stratified bundle by induction hypothesis. \square

Note that the singular codimension of $\mathcal{C}(\mathbb{R}^n)$ is n , thus it is a pseudo-manifold if $n \geq 2$: the proof of Theorem B is over.

The following will be central in the proof of Theorem C (recall that \mathcal{R}_m is the subset of rank n element of $\mathcal{C}(\mathbb{R}^n)$ and \mathcal{R}_ℓ is its complement).

Corollary 4.7. — *Any type (p, q) element $\Gamma \in \mathcal{C}(\mathbb{R}^n)$ has a neighborhood system $(U_\varepsilon)_\varepsilon$ such that U_ε is contractible and $U_\varepsilon \setminus \mathcal{R}_\ell$ is pathwise connected.*

Proof. — First, the links $L^n(0)$ are pathwise connected. Indeed $L^n(0) \cap \mathcal{R}_m$ is a dense strata, so that any point in $L^n(0)$ can be connected to a point in $L^n(0) \cap \mathcal{R}_m$, which is pathwise connected (homeomorphic to $\text{GL}(n; \mathbb{R}) / \text{GL}(n; \mathbb{Z})$).

Taking a neighborhood of Γ isomorphic to $U = \mathbb{R}^{(n-p)(p+q)} \times cL$ where $L = L^n(\mathbb{R}^p \times \mathbb{Z}^q)$ and for U_ε ($\varepsilon \in (0, 1)$) the product of the radius ε ball in $\mathbb{R}^{(n-p)(p+q)}$ by the part $\{(t, l) \in cL \mid t < \varepsilon\}$ of the cone cL , we get a neighborhood system such that U_ε is

contractible and $U_\varepsilon \setminus \mathcal{R}_\ell$ is a deformation retract of the total space of a stratified bundle with tori as fibers and base

$$L^p(0) \star (L^{n-(p+q)}(0))^{(0, n-(p+q))}$$

The tori are pathwise connected as well as $L^p(0)$. Moreover $(L^{n-(p+q)}(0))^{(0, n-(p+q))}$ is the set of unit norm lattices in $\mathbb{R}^{n-(p+q)}$ and is therefore pathwise connected. The pathwise connectedness of $U_\varepsilon \setminus \mathcal{R}_\ell$ follows. \square

4.4. Complete description of a few links. — Let us consider some explicit examples. We use Lemmas 4.2, 4.3 and 4.6. First, as already noticed,

$$L^1(0) \simeq \{\mathbb{Z}\}$$

is reduced to a point and the case of the open strata is trivial:

$$L^n(\mathbb{Z}^n) = \emptyset$$

for all n .

4.4.1. Description of links when $n = 2$. — We already said that

$$L^2(0) \simeq L^2(\mathbb{R}^2) \simeq S^3$$

where S^3 is stratified with strata a trefoil knot and its complement. The proof is contained in that of the Hubbard-Pourezza theorem, see the last section.

The duality maps type $(1, 1)$ elements to type $(0, 1)$ ones, so that we have left to consider only $L^2(\mathbb{Z})$ and $L^2(\mathbb{R})$. The link $L^2(\mathbb{Z})$ is isomorphic to the set of couples (Γ_3, Φ_3) where $\Gamma_3 \in L^1(0) \simeq \{\mathbb{Z}\}$ and Φ_3 is a homomorphism $\Gamma_3 \rightarrow \mathbb{R}/\mathbb{Z}$. As a consequence,

$$L^2(\mathbb{Z}) \simeq S^1$$

where S^1 is stratified with one strata.

The link $L^2(\mathbb{R})$ is isomorphic to the set of triples $(\Gamma_1, \Gamma_3, \Phi_3)$ where $\Gamma_1 \in U_\varepsilon^1(\mathbb{R})$ is defined by its norm α , $\Gamma_3 \in U_\varepsilon^1(0)$ is defined by the inverse β of its norm, Φ_3 is a homomorphism from $\Gamma_3 \simeq \beta^{-1}\mathbb{Z}$ to $\mathbb{R}/\Gamma_1 \simeq \mathbb{R}/\alpha\mathbb{Z}$, and moreover $\alpha + \beta$ is constrained to be equal to a constant $\delta/2$. As a consequence,

$$L^2(\mathbb{R}) \simeq S^2$$

where S^2 is stratified with three strata, two of them being reduced to a point (see figure 8).

4.4.2. Description of links $L^n(\mathbb{Z}^{n-1})$. — The link $L^3(\mathbb{Z}^2)$ is isomorphic to the set of couples (Γ_3, Φ_3) such that $\Gamma_3 \in L^1(0) \simeq \{1\}$ and Φ_3 is a homomorphism from \mathbb{Z} to $\mathbb{R}^2/\mathbb{Z}^2$. Therefore

$$L^3(\mathbb{Z}^2) \simeq T^2$$

where T^2 is the 2-torus stratified with a single stratum. This case is important, since it shows very simply that $\mathcal{C}(\mathbb{R}^3)$ is not a manifold: \mathbb{Z}^2 has a neighborhood homeomorphic to $\mathbb{R}^6 \times cT^2$. The same argument shows

$$L^n(\mathbb{Z}^{n-1}) \simeq T^{n-1}$$

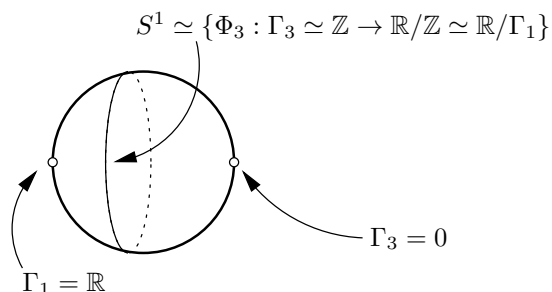
FIGURE 8. The link $L^2(\mathbb{R})$.

thus the same conclusion holds for all $n > 2$. We see that $\mathcal{C}(\mathbb{R}^2)$ is a manifold only because of a “happy accident”: the cone over T^1 is a 2-ball.

4.4.3. *Description of some links in $\mathcal{C}(\mathbb{R}^3)$.* — Let us give a few more examples without details. We have

$$L^3(\mathbb{R} \times \mathbb{Z}) \simeq T^1 \times T^1 \times T^1 \times [0, 1] / \sim$$

where the quotient is by the relations $(x, y, z, 0) \sim (x', y', z, 0)$ and $(x, y, z, 1) \sim (x, y', z', 1)$.

There is a stratified bundle

$$L^3(\mathbb{Z}) \rightarrow S^3$$

where S^3 is stratified by a trefoil knot and its complement, the fibers of this bundle being T^2 (over generic points) and T^1 (over singular points).

There is a stratified bundle

$$L^3(\mathbb{R}) \rightarrow \bar{c}S^3$$

where S^3 is again stratified by a trefoil knot and its complement and $\bar{c}S^3 = \{\bullet\} \star S^3$ is the closed cone over S^3 , the fibers of this bundle being T^2 (over generic points), T^1 (over $K \times (0, 1)$) and a point (over the apex of the cone and $S^3 \times \{1\}$).

5. Localization and simple connectedness

In this section we prove our main result. We start with the localization theorem D and then prove that $\mathcal{C}(\mathbb{R}^n)$ is simply connected.

5.1. Localization. — Let X be a Hausdorff topological space, Y be a closed subset of X and m be any non-negative integer. Assume that each point $y \in Y$ has a neighborhood system (U_ε) in X such that the topological pair $(U_\varepsilon, U_\varepsilon \setminus Y)$ is m -connected. Let us prove by induction on $k \leq m$ that the pair $(X, X \setminus Y)$ is k -connected. In fact, we shall prove a stronger property to run the induction.

For all $k \leq m$, we denote by I^k the cube $[0, 1]^k$ and by ∂I^k its boundary, while 0 denotes the point $(0, 0, \dots, 0)$.

Fix some point $x_0 \in X \setminus Y$ and let us prove by induction on k that any map $\alpha : (I^k, \partial I^k, 0) \rightarrow (X, X \setminus Y, x_0)$ is homotopic (with fixed boundary) to a map $\alpha_1 :$

$I^k \rightarrow X \setminus Y$ through a arbitrarily small homotopy (α_t) . More precisely, we shall prove that for any compact subsets K_1, \dots, K_ℓ of I^k and any open subsets W_1, \dots, W_ℓ of X such that $\alpha(K_j) \subset W_j$, we can ask that for all t , $\alpha_t(K_j) \subset W_j$.

For any point x in the interior of I^k , an *open box* around x is a neighborhood of x that writes $I_1 \times I_2 \times \dots \times I_k$ where I_i are open intervals of $[0, 1]$ that contain neither 0 nor 1. The *lower corner* of an open box $]a_1, b_1[\times \dots \times]a_k, b_k[$ is the point (a_1, a_2, \dots, a_k) .

We start with the case $k = 0$. We have to prove that any point in X is connected by an arbitrarily small path to a point in $X \setminus Y$. This follows directly from the hypothesis that U_ε is a neighborhood system and $(U_\varepsilon, U_\varepsilon \setminus Y)$ is 0-connected.

Assume now that we proved the desired result for maps $(I^{k-1}, \partial I^{k-1}, 0) \rightarrow (X, X \setminus Y, x_0)$ and let α , (K_j) and (W_j) be as above.

Denote by $\Sigma := \alpha^{-1}(Y)$ the *singular set*. It is a closed subset of I^k , thus is compact. For all $s \in \Sigma$, there is a neighborhood $U(s)$ of $\alpha(s)$ that is pathwise connected and such that $(U(s), U(s) \setminus Y)$ is m -connected. When $s \in K_j$, we can moreover assume that $U(s) \subset W_j$. Let $V(s) = \alpha^{-1}(U(s))$ and $B(s)$ be an open box around s such that $\overline{B}(s) \subset V(s)$. If $s \notin K_j$, we moreover assume that $\overline{B}(s) \cap K_j = \emptyset$.

Since Σ is compact, there exist a finite number of points $s_1, \dots, s_N \in \Sigma$ such that the $B_i := B(s_i)$ cover Σ . Let us prove that α is homotopic to a map α_1 for which N can be reduced. This will prove the theorem by induction on N , since $N = 0$ means that α avoids Y .

Up to a reordering, we can assume that B_1 has its lower corner x_1 outside all of the B_i . In particular, $x_1 \notin \Sigma$. The restriction β of α to the boundary of B_1 defines a element in $\pi_{k-1}(U_1, x_1)$ where $U_1 := U(s_1)$. Since $(U_1, U_1 \setminus Y)$ is m -connected, β is homotopic to a map $\beta_1 : \partial B_1 \rightarrow U_1 \setminus Y$. The induction hypothesis moreover enables us to assume that the homotopy (β_t) is small enough to ensure $\beta_t(K_j \cap \partial B_1) \subset W_j$ and

$$\beta_t(\partial B_1 \setminus \bigcup_{i=2}^N B_i) \subset X \setminus Y$$

for all t . In particular, the homotopy β_t will not add any new singular part at the next step.

Composing as in figure 9 the part of α exterior to B_1 with the homotopy from β to β' , then with its inverse, finally with the restriction of α to \overline{B}_1 , we can assume that α maps ∂B_1 in $U_1 \setminus Y$ while ensuring that Σ is still covered by the B_i .

Now the restriction of α to \overline{B}_1 defines an element of $\pi_k(U_1, U_1 \setminus Y, x_1)$ and there is a homotopy $H : [0, 1] \times (B_1, \partial B_1, x_1) \rightarrow (U_1, U_1 \setminus Y, \alpha(x_1))$ such that $H(0, \cdot) = \alpha|_{\overline{B}_1}$ and $H(1, \cdot)$ takes its values in $U_1 \setminus Y$. This homotopy extends to a homotopy between α and a map α_1 whose singular set Σ_1 is covered by the $N - 1$ boxes B_2, B_3, \dots, B_N . Moreover, our assumptions ensure that for all j , either $B_1 \cap K_j = \emptyset$ or $U_1 \subset W_j$, therefore our homotopy is small enough to carry the induction. This finishes the proof.

5.2. Simple connectedness. — We note $\mathcal{C} = \mathcal{C}(\mathbb{R}^n)$ and recall that \mathcal{R}_m is the set of closed subgroups of maximal rank and \mathcal{R}_ℓ is its complement.

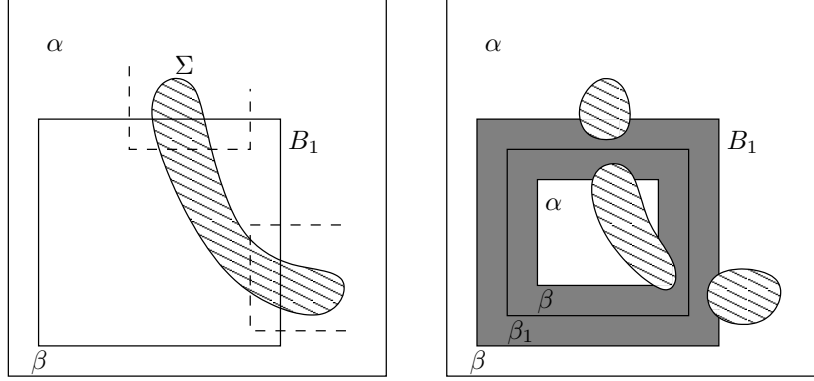

FIGURE 9. On the left, dashed lines represent boxes B_i for $i > 1$. On the right, in the gray region we composed α with the homotopy from β to β_1 and back to β .

Lemma 5.1. — For each $\Gamma \in \mathcal{R}_\ell$, if we denote by (U_ε) the neighborhood system given in Corollary 4.7, the pair

$$(U_\varepsilon, U_\varepsilon \setminus \mathcal{R}_\ell)$$

is 1-connected.

Proof. — We know that U_ε is contractible, thus pathwise connected and simply connected. The pair $(U_\varepsilon, U_\varepsilon \setminus \mathcal{R}_\ell)$ is in particular 0-connected. Moreover $U_\varepsilon \setminus \mathcal{R}_\ell$ is pathwise connected. But we have an exact sequence

$$1 = \pi_1(U_\varepsilon) \rightarrow \pi_1(U_\varepsilon, U_\varepsilon \setminus \mathcal{R}_\ell) \rightarrow \pi_0(U_\varepsilon \setminus \mathcal{R}_\ell) = 1$$

thus $\pi_1(U_\varepsilon, U_\varepsilon \setminus \mathcal{R}_\ell)$ is trivial, as desired.

This classical exact sequence is very easy to understand in this case: any curve in U_ε whose ends lie in $U_\varepsilon \setminus \mathcal{R}_\ell$ is homotopic to a curve whose ends coincide and lie in $U_\varepsilon \setminus \mathcal{R}_\ell$, simply because this set is arc-connected. But since U_ε is simply connected, this curve is nullhomotopic, thus homotopic to a curve entirely lying in $U_\varepsilon \setminus \mathcal{R}_\ell$. \square

We can now complete the proof of Theorem C. Since \mathcal{R}_ℓ is the closure of the strata of type $(0, n-1)$ and thanks to the preceding lemma, the localization theorem implies that $(\mathcal{C}, \mathcal{R}_m)$ is simply connected. This means that any loop of \mathcal{C} based at \mathbb{R}^n is homotopic to a loop in \mathcal{R}_m .

The map defined on $\mathcal{R}_m \times [0, 1]$ by $H(\Gamma, t) = t\Gamma$ is a continuous homotopy between the constant map with value \mathbb{R}^n and the identity map. Therefore, any loop of \mathcal{C} is nullhomotopic. Note that the extension of H on the whole of \mathcal{C} would not be continuous at $t = 0$, since it fixes 0 but retracts lattices of arbitrarily large norm to \mathbb{R}^n .

We cannot prove this way that \mathcal{C} is 2-connected. We would indeed need the 2-connectedness of $(U_\varepsilon, U_\varepsilon \setminus \mathcal{R}_\ell)$ which does not hold. For example, a typical neighborhood for \mathbb{Z}^{n-1} in \mathbb{R}^n has the homotopy type of the cone over a $(n-1)$ -torus, its

intersection with \mathcal{R}_ℓ being the apex. The torus is not simply connected, thus the pair (cT^{n-1}, T^{n-1}) is not 2-connected.

6. The Chabauty space of \mathbb{R}^2 is a 4-sphere

6.1. Definitions and notations. — In this section, we denote by \mathcal{C} the Chabauty space of \mathbb{R}^2 . A closed subgroup of \mathbb{R}^2 is of one of the following types:

- $(0, 0)$: the trivial subgroup 0 ;
- $(0, 1)$: isomorphic to \mathbb{Z} ;
- $(0, 2)$: isomorphic to \mathbb{Z}^2 (these are the lattices) ;
- $(1, 0)$: isomorphic to \mathbb{R} ;
- $(1, 1)$: isomorphic to $\mathbb{R} \times \mathbb{Z}$;
- $(2, 0)$: the total group \mathbb{R}^2 .

Each type is an orbit of the action of $\mathrm{GL}(2; \mathbb{R})$ on \mathcal{C} . The set of lattices is $\mathcal{L} := \mathcal{C}^{(0,2)}$, its complement is denoted by \mathcal{H} .

A closed subgroup Γ of \mathbb{R}^2 has a determinant, or covolume, $\mathrm{covol}(\Gamma)$. If Γ is a lattice, it is its usual determinant, that is the determinant of any direct base of Γ . It is 0 if Γ is isomorphic to $\mathbb{R} \times \mathbb{Z}$ or \mathbb{R}^2 , and ∞ if Γ is isomorphic to \mathbb{Z} or 0 . In other words, it is the 2-dimensional volume of the quotient \mathbb{R}^2/Γ . By convention, $\mathrm{covol}(\Gamma)$ takes simultaneously all values in $[0, \infty]$ if Γ is isomorphic to \mathbb{R} . So defined, the levels of covol are closed in \mathcal{C} . Outside the set $\mathcal{R} := \mathcal{C}^{(1,0)}$ of such subgroups, covol is a continuous function. Beware that here, the letter \mathcal{R} refers to \mathbb{R} (and not to the rank).

Let $\mathcal{C}_{\geq 1}$, respectively $\mathcal{C}_{\leq 1}$, be the subsets of \mathcal{C} defined by $\mathrm{covol} \geq 1$ and $\mathrm{covol} \leq 1$. These set both contain \mathcal{R} . Let $\mathcal{H}_{\geq 1} = \mathcal{H} \cap \mathcal{C}_{\geq 1}$ be the set of subgroups isomorphic to \mathbb{R} , \mathbb{Z} or 0 , and $\mathcal{H}_{\leq 1} = \mathcal{H} \cap \mathcal{C}_{\leq 1}$ be the set of subgroups isomorphic to \mathbb{R} , $\mathbb{R} \times \mathbb{Z}$ or \mathbb{R}^2 .

Let \mathcal{L}_1 be the set of covolume 1 lattices, and \mathcal{C}_1 its closure. Then \mathcal{C}_1 is the union of \mathcal{L}_1 and of the set \mathcal{R} .

We use the usual identification $\mathbb{R}^2 \simeq \mathbb{C}$, so that any subgroup isomorphic to \mathbb{R} can be written in the form $e^{i\theta}\mathbb{R}$.

We also define as before the norm (or systol)

$$N(\Gamma) = N_1(\Gamma) = \inf \{|x| \mid x \in \Gamma \setminus \{0\}\}$$

It is a continuous functions taking its values in $[0, \infty]$. Let \mathcal{C}^1 be the set of norm 1 subgroups of \mathbb{R}^2 . A point of \mathcal{C}^1 is either isomorphic to \mathbb{Z} , or a lattice. We denote by \mathcal{L}^1 the set $\mathcal{C}^1 \setminus \mathcal{L}$.

Figure 10 sums up this notations.

The proof of Theorem A is in two parts. We first prove that the topological pair $(\mathcal{C}, \mathcal{H})$ is the suspension of $(\mathcal{C}^1, \mathcal{L}^1)$, then that the latter is homeomorphic to (S^3, K) where K is a trefoil knot.

6.2. The Chabauty space of \mathbb{R}^2 is a suspension. —

Lemma 6.1. — *The topological pair $(\mathcal{C}_{\geq 1}, \mathcal{H}_{\geq 1})$ is homeomorphic to the cone over $(\mathcal{C}_1, \mathcal{R})$.*

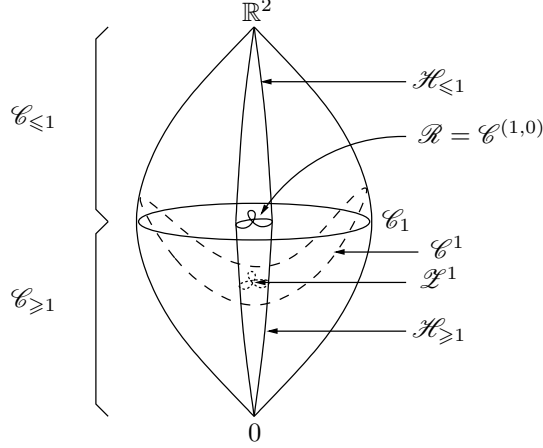

FIGURE 10. Sum up of notations

Proof. — We consider the map

$$\begin{aligned} \Phi : \mathcal{C}_1 \times [0, \infty] &\rightarrow \mathcal{C}_{\geq 1} \\ (\Gamma_1, t) &\mapsto \begin{cases} \left(\frac{t}{N(\Gamma_1)} + 1\right) \Gamma_1 & \text{if } \Gamma_1 \in L_1 \\ te^{i\theta} \mathbb{Z} & \text{if } \Gamma_1 = e^{i\theta} \mathbb{R} \end{cases} \end{aligned}$$

where by convention $0e^{i\theta} \mathbb{Z} = e^{i\theta} \mathbb{R}$ and $\infty \Gamma = 0$ if Γ is discrete.

This map is continuous, maps $\mathcal{C}_1 \times \{0\}$ onto \mathcal{C}_1 and $\mathcal{R} \times [0, \infty]$ onto $\mathcal{H}_{\geq 1}$. It induces a continuous bijection $\tilde{\Phi}$ from the quotient of $\mathcal{C}_1 \times [0, \infty]$ by the relation $(\Gamma_1, \infty) \sim (\Gamma'_1, \infty)$ onto $\mathcal{C}_{\geq 1}$. Since the latter is compact, $\tilde{\Phi}$ is a homeomorphism between the cone over $(\mathcal{C}_1, \mathcal{R})$ and $(\mathcal{C}_{\geq 1}, \mathcal{H}_{\geq 1})$. \square

Lemma 6.2. — *The topological pair $(\mathcal{C}_1, \mathcal{R})$ is homeomorphic to $(\mathcal{C}^1, \mathcal{Z}^1)$.*

Proof. — The map $\Psi : \mathcal{C}^1 \rightarrow \mathcal{C}_1$ that assigns to Γ the only $t\Gamma$ of unit covolume ($t = 0$ if Γ is isomorphic to \mathbb{Z} , $t = \text{covol}(\Gamma)^{-1/2}$ otherwise) is continuous and a bijection. By compactness of \mathcal{C}_1 , closed in \mathcal{C} , it is a homeomorphism. \square

Proposition 6.3. — *The topological pair $(\mathcal{C}, \mathcal{H})$ is homeomorphic to the suspension of $(\mathcal{C}^1, \mathcal{Z}^1)$.*

Proof. — We can either reproduce the previous arguments to prove that $(\mathcal{C}_{\leq 1}, \mathcal{H}_{\leq 1})$ is also a cone over $(\mathcal{C}^1, \mathcal{Z}^1)$ or use the duality $*$ which maps $\mathcal{C}_{\geq 1}$ on $\mathcal{C}_{\leq 1}$ and preserves \mathcal{L} . \square

6.3. Subgroups of unit norm. — To get Theorem A, we have left to prove the following.

Proposition 6.4. — *The topological pair $(\mathcal{C}^1, \mathcal{Z}^1)$ is homeomorphic to (S^3, K) .*

The proof runs over the rest of the Section. We shall describe \mathcal{C}^1 as a Seifert fibration. Let Γ be a point of \mathcal{C}^1 . The isometry group $\text{SO}(2)$ acts on \mathcal{C}^1 , and up to a rotation we can assume that $1 \in \Gamma \subset \mathbb{C}$. Then Γ is determined by the choice of a second vector in the fundamental domain

$$D = \{z \in \mathbb{C}; |z| \geq 1 \text{ and } -1/2 \geq \text{Re}(z) \geq 1/2\} \cup \{\infty\}$$

where $z = \infty$ means that Γ is isomorphic to \mathbb{Z} (figure 11). Identifying the points of D that represent the same Γ leads to the quotient of D by the relation $z \sim z - 1$ if $\text{Re}(z) = 1/2$ and $z \sim -\bar{z}$ if $|z| = 1$, turning it into a 2-sphere denoted by B , that will be the base of the Seifert fibration.

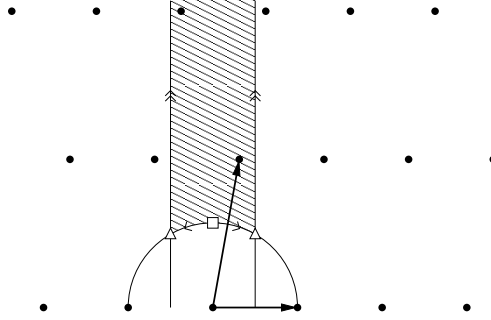

FIGURE 11. Fundamental domain: the vertical lines and the circle arcs are glued according to the arrows, \square and \triangle are the singular points.

The kernel of the action of $\text{SO}(2)$ is reduced to $\{\pm 1\}$, and the quotient gives an action of the circle that is almost free: the only points of \mathcal{C}^1 that have nontrivial stabilizers are the triangular lattices (stabilizer of order 3) and the square lattices (stabilizer of order 2). It follows that \mathcal{C}^1 is a Seifert fibration with base $B \simeq S^2$ and two singular fibers of order 2 and 3, and where \mathcal{Z}^1 is a regular fiber. The unnormalized Seifert invariants of \mathcal{C}^1 are $(0|(2, \beta_1); (3, \beta_2))$ and we have left to find the rational Euler number $\beta_1/2 + \beta_2/3$ to determine $(\mathcal{C}^1, \mathcal{Z}^1)$.

We first choose a cross-section of the regular part of the Seifert fibration. It would be natural to lift each point u in the fundamental domain to the subgroup generated by u and 1, but this would not define a continuous cross-section. The gluing of the unit circle indeed identifies, for all $\theta \in [0, \pi/6]$, the subgroups $1\mathbb{Z} + e^{i(\pi/2-\theta)}\mathbb{Z}$ and $1\mathbb{Z} + e^{i(\pi/2+\theta)}\mathbb{Z}$ by a rotation of angle $\pi/2 + \theta$. We shall therefore modify this cross-section in a neighborhood of one of the circular arcs of D .

Let $S^1 = \mathbb{R}/\pi\mathbb{Z}$ be the quotient $\text{SO}(2)/\{\pm 1\}$, D' be the fundamental domain D minus the singular points (i , $e^{i\pi/3}$ and $e^{2i\pi/3}$) and B' be the base B minus the two singular points (corresponding to i and $e^{i\pi/3} \sim e^{2i\pi/3}$). We choose a continuous map $f : D' \rightarrow [0, \pi/2]$ that is constant with value 0 except in a neighborhood of the arc $\{e^{i(\pi/2+\theta)} \mid \theta \in]0, \pi/6[\}$, where it satisfies $f(e^{i(\pi/2+\theta)}) = \pi/2 - \theta$. We then define a cross-section $\sigma : B' \rightarrow \mathcal{C}^1$ by $\sigma(u) = e^{if(u)}(1\mathbb{Z} + u\mathbb{Z})$. It is continuous since

$$\sigma(e^{i(\pi/2+\theta)}) = e^{i(\pi/2-\theta)}(1\mathbb{Z} + e^{i(\pi/2+\theta)}\mathbb{Z}) = e^{i(\pi/2-\theta)}\mathbb{Z} + 1\mathbb{Z} = \sigma(e^{i(\pi/2-\theta)})$$

Let b be the homotopy class in \mathcal{C}^1 of a regular fiber, d_1 and d_2 be the homotopy classes defined by σ on the boundary of $\mathcal{C}_\bullet^1 = \mathcal{C}^1 \setminus \{F_1, F_2\}$ where F_1 and F_2 are invariant neighborhoods of the singular fibers of order 2 and 3, respectively.

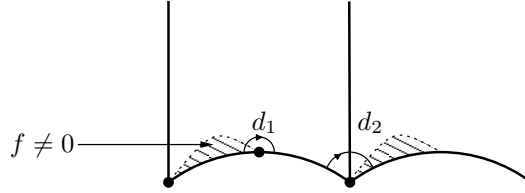

FIGURE 12. The cross-section σ defines homotopy classes in the boundary of \mathcal{C}_\bullet^1 .

In ∂F_1 and ∂F_2 respectively, we get that $2d_1 + b$ and $3d_2 - b$ are homotopic to meridians (see figure 13 where F_1 and F_2 are pictured with coordinates $(u, \varphi) \in B \times \mathbb{R}/\pi\mathbb{Z} \mapsto e^{i\varphi}(1\mathbb{Z} + u\mathbb{Z})$, with the suitable identifications). It follows that \mathcal{C}^1 has unnormalized Seifert invariants $(0|(2, 1), (3, -1))$ and rational Euler number equal to $1/2 - 1/3 = 1/6$.

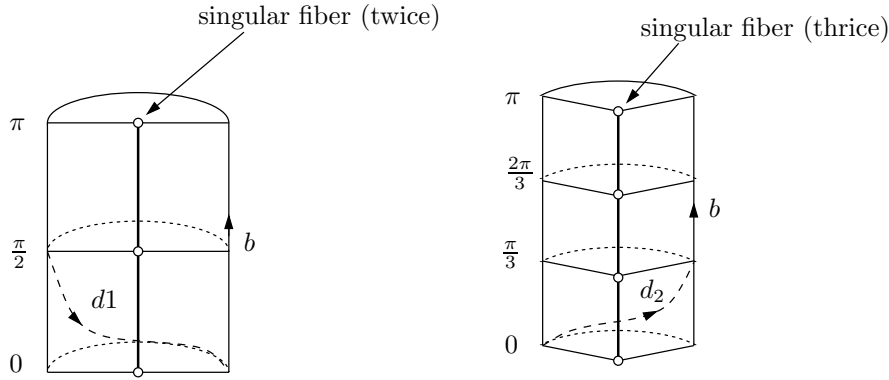

FIGURE 13. Neighborhood F_1 and F_2 of the singular fibers

We shall now exhibit a very classical Seifert fibration on S^3 whose regular fibers are trefoil knots, that has base S^2 , two singular fibers of order 2 and 3 and rational Euler number $1/6$. Since a Seifert fibration is determined by these data, we will conclude that $(\mathcal{C}^1, \mathcal{Z}^1)$ is homeomorphic to (S^3, K) .

Consider the following action of the circle \mathbb{R}/\mathbb{Z} on S^3 , identified to the unit sphere of \mathbb{C}^2 :

$$s \cdot (z_1, z_2) = (e^{2\pi m_1 i s} z_1, e^{2\pi m_2 i s} z_2)$$

with $m_1 = 2$ and $m_2 = 3$. The stabilizer of almost every point is trivial, the exceptions being the polar orbits $(z_1, 0)$ and $(0, z_2)$. If m_1 and m_2 were equal to 1, we would

get the Hopf fibration where the non-polar orbits are Villarceau circles of the tori $|z_1/z_2| = c$, where c runs over $[0, \infty]$. Taking $m_1 = 2$ and $m_2 = 3$, we replaced the Villarceau circle by toric knots, here trefoil knots (figure 14).

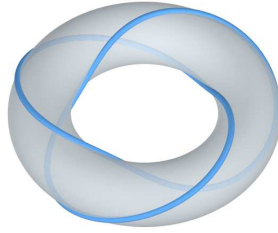

FIGURE 14. The torus knot $(2, 3)$ is a trefoil knot.

We see that the regular part of the base is foliated by the circles obtained by quotienting the tori $|z_1/z_2| = c$ by the action of S^1 , and is therefore an annulus. One can see this annulus as the S^2 base of the Hopf fibration minus two points for the singular fibers.

Let us compute the Seifert invariants of this action, which are surprisingly difficult to find in the literature. We use a representation found in [12].

Let $T^2 = \mathbb{R}/\mathbb{Z} \times \mathbb{R}/\mathbb{Z}$ be the standard 2-torus equipped with the foliation by straight lines of slope $3/2$. If we denote by x the homotopy class of

$$\begin{aligned} \mathbb{R}/\mathbb{Z} &\rightarrow T^2 \\ t &\mapsto (t, 0) \end{aligned}$$

and by y the homotopy class of

$$\begin{aligned} \mathbb{R}/\mathbb{Z} &\rightarrow T^2 \\ t &\mapsto (0, t) \end{aligned}$$

the homotopy class of any leaf of this foliation is $\ell = 2x + 3y$.

In the space $T^2 \times [0, 1]$ define $T_t := \mathbb{T}^2 \times \{t\}$, endowed with the above foliation for $t \in (0, 1)$. Let $\Pi : T^2 \times [0, 1] \rightarrow S^3$ be the mapping defined as follows. First, Π contracts T_0 to the singular fiber $\{(0, z_2) \mid |z_2| = 1\}$ and T_1 to the singular fiber $\{(z_1, 0) \mid |z_1| = 1\}$ with $\Pi(a, b, 0) = (0, e^{2i\pi b})$ and $\Pi(a, b, 1) = (e^{2i\pi a}, 0)$. Second, it maps T_t to a torus defined by $|z_1/z_2| = c(t)$ with c an increasing continuous function such that $c(t) \rightarrow 0$ (resp. $+\infty$) when $t \rightarrow 0$ (resp. 1), and maps the foliation of T_t to the Seifert foliation in S^3 . Think of $T^2 \times [0, 1]$ as a blow-up of S^3 along the singular fibers.

The point is that in this presentation, one can give explicitly a cross-section of the Seifert fibration over the regular part: just consider the set

$$\{(s, 2s, t) \mid s \in \mathbb{R}/\mathbb{Z}, t \in (0, 1)\} \subset T^2 \times (0, 1)$$

This set intersects each of the T_t along a straight line homotopic to $x + 2y$, which intersects each $2x + 3y$ line once, thus it does define a section.

In the boundary of a neighborhood of T_0 , the section defines a curve homotopic to $d_0 = -x - 2y$ (the sign depends upon the choice of orientation). Since $\ell = 2x + 3y$ is the homotopy class of a regular fiber, we have $3d_0 + 2\ell = x$, a meridian. Similarly, in the boundary of a neighborhood of T_1 , the section defines a curve homotopic to $d_1 = x + 2y$ and $2d_1 - \ell = y$ is a meridian.

Therefore, this Seifert fibration has unnormalized invariants $(0|(3, 2), (2, -1))$ and rational Euler number $2/3 - 1/2 = 1/6$ as needed.

Remark 6.5. — It is well known (see e.g. [15]) that $\mathrm{SL}(2; \mathbb{R})/\mathrm{SL}(2; \mathbb{Z})$ is homeomorphic to the complement of a trefoil knot in S^3 . This can be given an alternative proof using the same methods we used to prove Theorem A. Lemma 6.2 indeed shows that this homogeneous space is homeomorphic to $\mathcal{C}^1 \setminus \mathcal{Z}^1$. The study of the Seifert fibration on \mathcal{C}^1 implies this result, but the study of $\mathcal{C}^1 \setminus \mathcal{Z}^1$ is in fact simpler. More precisely, we do not need to study how the singular fibers are glued to the regular part, the non-compactness enabling one to assume $\beta_1 = 1$ and $\beta_2 = 1$ or 2 . Moreover, the difference between $\beta_2 = 1$ and $\beta_2 = 2$ ($\equiv -1 \pmod{3}$) lies only in the orientation, and the result holds regardless (but then we do not know if, for a given orientation of $\mathrm{SL}(2; \mathbb{R})/\mathrm{SL}(2; \mathbb{Z})$, we obtain the complement of a right or left trefoil knot).

Remark 6.6. — Christopher Tuffley studied [19] the spaces $\exp_k(S^1)$ of all non-empty subset of the circle of cardinality at most k . In particular, he proved using Seifert fibrations that $\exp_3(S^1)$ is a 3-sphere, its subset $\exp_1(S^1)$ being a trefoil knot.

The similarity with Proposition 6.4 is not fortuitous: Jacob Mostovoy proved [13] by a simple geometric argument that $(\exp_3(S^1), \exp_1(S^1))$ is homeomorphic to $(\mathcal{C}^1, \mathcal{Z}^1)$. Combining these two results one gets another Seifert fibration proof of Proposition 6.4. Note that even the Seifert part is somewhat different from ours, since it is first proved that $\exp_3(S^1)$ is simply connected, which reduces drastically its possible Euler numbers.

Remark 6.7. — A nice feature of the study of $\exp_3(S^1)$ is that its subset $\exp_2(S^1)$ is easily seen to be a Möbius strip, with boundary $\exp_1(S^1)$: we recover the fact that a trefoil knot bounds a Möbius strip. This can be seen in $(\mathcal{C}^1, \mathcal{Z}^1)$ as well: over the vertical line $L = \{iy \mid y \in [1, +\infty)\}$ of the base B , the Seifert fibration is a closed Möbius strip with boundary \mathcal{Z}^1 , obtained by identifying antipodal points of the $(y = 1)$ boundary component of the strip $L \times S^1$.

7. A few open questions

There are many question left open concerning $\mathcal{C}(\mathbb{R}^n)$. Let us consider some of them that seem of special interest.

1. Determine whether $\mathcal{C}(\mathbb{R}^n)$ is stratified in the sense of Thom or Mather. It would for example imply that it can be triangulated ([11, 8]). More ambitiously, determine if we can endow $\mathcal{C}(\mathbb{R}^n)$ with the structure of an algebraic variety. This

question is motivated by the original proof of the Hubbard-Pourezza theorem, where the link $L^2(0)$ is described by algebraic means.

2. Compute the intersection homology of $\mathcal{C}(\mathbb{R}^n)$.
3. Describe explicitly $\mathcal{C}(\mathbb{R}^3)$, or at least the set $L^3(0)$ of unit norm subgroups of \mathbb{R}^3 .

References

- [1] A. BOREL & L. JI – *Compactifications of symmetric and locally symmetric spaces*, Mathematics: Theory & Applications, Birkhäuser Boston Inc., Boston, MA, 2006.
- [2] M. R. BRIDSON, P. DE LA HARPE & V. KLEPTSYN – “The chabauty space of closed subgroups of the three-dimensional heisenberg group”, 2007, arXiv:0711.3736, to appear in *Pacific J. Math.*
- [3] C. CHABAUTY – “Limite d’ensembles et géométrie des nombres”, *Bull. Soc. Math. France* **78** (1950), p. 143–151.
- [4] C. EYRAL – “Profondeur homotopique et conjecture de Grothendieck”, *Ann. Sci. École Norm. Sup. (4)* **33** (2000), no. 6, p. 823–836.
- [5] M. GORESKY & R. MACPHERSON – “Intersection homology theory”, *Topology* **19** (1980), no. 2, p. 135–162.
- [6] ———, “Intersection homology. II”, *Invent. Math.* **72** (1983), no. 1, p. 77–129.
- [7] ———, *Stratified Morse theory*, Ergebnisse der Mathematik und ihrer Grenzgebiete (3) [Results in Mathematics and Related Areas (3)], vol. 14, Springer-Verlag, Berlin, 1988.
- [8] R. M. GORESKY – “Triangulation of stratified objects”, *Proc. Amer. Math. Soc.* **72** (1978), no. 1, p. 193–200.
- [9] Y. GUIVARC’H & B. RÉMY – “Group-theoretic compactification of Bruhat-Tits buildings”, *Ann. Sci. École Norm. Sup. (4)* **39** (2006), no. 6, p. 871–920.
- [10] P. DE LA HARPE – “Spaces of closed subgroups of locally compact groups”, 2008, arXiv:0807.2030.
- [11] F. E. A. JOHNSON – “On the triangulation of stratified sets and singular varieties”, *Trans. Amer. Math. Soc.* **275** (1983), no. 1, p. 333–343.
- [12] P. MASSOT – “Geodesible contact structures on 3-manifolds”, *Geom. Topol.* **12** (2008), no. 3, p. 1729–1776.
- [13] J. MOSTOVOY – “Lattices in \mathbb{C} and finite subsets of a circle”, *Amer. Math. Monthly* **111** (2004), no. 4, p. 357–360.
- [14] I. POUREZZA & J. HUBBARD – “The space of closed subgroups of \mathbb{R}^2 ”, *Topology* **18** (1979), no. 2, p. 143–146.
- [15] J. H. RUBINSTEIN & C. GARDINER – “A note on a 3-dimensional homogeneous space”, *Compositio Math.* **39** (1979), no. 3, p. 297–299.
- [16] I. SATAKE – “On representations and compactifications of symmetric Riemannian spaces”, *Ann. of Math. (2)* **71** (1960), p. 77–110.
- [17] L. C. SIEBENMANN – “Deformation of homeomorphisms on stratified sets. I, II”, *Comment. Math. Helv.* **47** (1972), p. 123–136; *ibid.* **47** (1972), 137–163.
- [18] R. THOM – “Ensembles et morphismes stratifiés”, *Bull. Amer. Math. Soc.* **75** (1969), p. 240–284.
- [19] C. TUFFLEY – “Finite subset spaces of S^1 ”, *Algebr. Geom. Topol.* **2** (2002), p. 1119–1145 (electronic).

- [20] H. WHITNEY – “Complexes of manifolds”, *Proc. Nat. Acad. Sci. U. S. A.* **33** (1947), p. 10–11.
- [21] ———, “Local properties of analytic varieties”, *Differential and Combinatorial Topology (A Symposium in Honor of Marston Morse)*, Princeton Univ. Press, Princeton, N. J., 1965, p. 205–244.
- [22] ———, “Tangents to an analytic variety”, *Ann. of Math. (2)* **81** (1965), p. 496–549.