

Automatic Road Lighting System (ARLS) model based on image processing of moving object

SUPRIJADI¹, T. MULIAWAN¹, and S. VIRIDI²

¹Theoretical High Energy Physics and Instrumentation Research Division,
Institut Teknologi Bandung, Bandung 40132 (Indonesia);
Email : supri@fi.itb.ac.id

²Nuclear Physics and Biophysics Research Division,
Institut Teknologi Bandung, Bandung 40132 (Indonesia);
Email : dudung@fi.itb.ac.id

ABSTRACT

Using a vehicle toy (in next future called vehicle) as a moving object an automatic road lighting system (ARLS) model is constructed. A digital video camera with 25 fps is used to capture the vehicle motion as it moves in the test segment of the road. Captured images are then processed to calculate vehicle speed. This information of the speed together with position of vehicle is then used to control the lighting system along the path that passes by the vehicle. Length of the road test segment is 1 m, the video camera is positioned about 1.1 m above the test segment, and the vehicle toy dimension is 13 cm × 9.3 cm. In this model, the maximum speed that ARLS can handle is about 1.32 m/s, and the highest performance is obtained about 91 % at speed 0.93 m/s.

Keywords: : Road lighting system, image processing, vehicle toy, automatic system.

Mathematics Subject Classification: 62H32, 68U10

Computing Classification System: I.4.1

1. INTRODUCTION

Road lighting system, especially in the night or in bad weather, plays important role in safety of people that is using the street: walking and driving. Unfortunately, in a big city like Jakarta, Indonesia, there are 205.852 lamp units registered which operate about 12 hours/day and cost 142.3 billion IDR for their operation in 2007, and in 2010 additional 262 thousand points will be executed. This cost can be reduced using scheduled system, e.g. at 01.00 – 03.00 AM only 50 % of road lamps are operated, but it still dangerous and not responsible since we can not predict whether there are vehicles or not at that time passing the road. Other solution is to build an automatic road lighting system (ARLS) which can detect existence of vehicle on the road and then switch the lamps on or of according in where direction the vehicle moves. Many light control systems were developed, for example based on infra red, time schedule, or other sensors]. In the last decade, image processing techniques were growing fast. The supporting by a new microprocessor and hardware, the technologies were applied in many

filed including for control and security. Some applications of image processing were reported by authors in Indonesia journal. The other opportunity in control system sensor can be replaced by an image from digital camera. We proposed the opportunity to replace an usual sensor with an image to make a control system. We developed an ARLS model using image processing as main control system. The model consists of vehicle toy, video camera as input, processing unit to calculate and predict vehicle motion parameters, and controller to switch the lamps on and off. A vehicle toy is used as the motion object.

2. SYSTEM SETUP

Automatic road lighting system (ARLS) consists of four main parts: vehicle toy as moving object, video camera as input part, a personal computer (PC) as processing part, and electronic actuator circuit 555 based as output part with road lamp. Relations between these parts are shown in Figure 1.

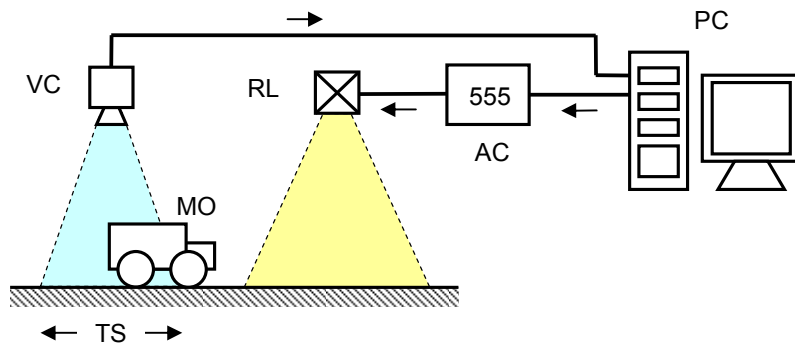

Figure 1. Illustration of ARLS: vehicle as moving object (MO), video camera (VC) which operates at road test segment (TS) as input part, a personal computer (PC) as processing part, and electronic actuator circuit 555 based (AC) which controls road lamp (RL) as output.

A typical webcam with 25 fps specification is used as input part of the ARLS. It feeds the processing part (PC) with series of captured images as the vehicle toy (MO) is passing the road test segment (TS). As the processing unit a PC with Intel® Core™ 2 6400 processor, 2.13 GHz clock speed, FSB 133.2 MHz, L2 cache 3.2 kB, and 1014 MB DDR-SDRAM memory. For the operating system a Microsoft Windows XP Professional (2002) with Service Pack 2 is used.

In order to calibrate distance in captured image two blue lines are drawn as illustrated in Figure 2. One of the image processing tasks is to distinguish these two lines out of other object in captured image. If distance in real world is l and in the captured image is L , then a scaling factor c can be defined

$$c = \frac{l}{L}, \quad (1)$$

which is used to transform all positions of pixels in the captured image (X, Y) which are represented in pixels to (x, y) which are represented in m through

$$\begin{pmatrix} x \\ y \end{pmatrix} = c \begin{pmatrix} X \\ Y \end{pmatrix}. \quad (2)$$

Value of c is dependent on position of VC above the TS. The next task of image processing is to identify the MO as it is passing the TS. The identifying process is performed by subtracting pixels value a captured image at time t with a referenced image (indeks R) which the background image (Figure 2) is, but the subtracting is forced to be 1 if value of the pixels in a captured image is different than value of pixels in referenced image. This information is place in a new image (indeks N),

$$\begin{pmatrix} X_N \\ Y_N \end{pmatrix}^{(t)} = \text{ceila} \left[\begin{pmatrix} X \\ Y \end{pmatrix}^{(t)} - \begin{pmatrix} X_R \\ Y_R \end{pmatrix} \right], \quad (3)$$

where the $\text{ceila}(x)$ function (or ceil from absolute) is defined as

$$\text{ceila}(x) = \begin{cases} 0, & x = 0 \\ 1, & x \neq 0 \end{cases}. \quad (4)$$

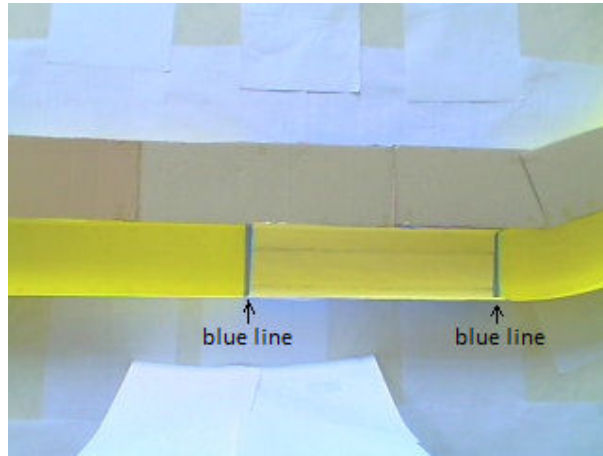

Figure 2. Original captured image of road test segment (TS) without passing vehicle toy which is used as default background image in processing the series of capture images as the vehicle is passing this TS.

The next step is to find the center of MO in every captured image. It can be done by putting incremental value I_x from 1 to some value for X as the new image scanned in horizontal direction and I_y for Y in vertical direction. Illustration for rectangular object is given Figure 3. Then center of MO is found using

$$X_{MO} = \frac{\max(I_x) - \min(I_x)}{A}, \quad (5)$$

$$Y_{MO} = \frac{\max(I_y) - \min(I_y)}{A}, \quad (6)$$

where are area A is found as number of steps needed to cover all pixels in the new image that have value 1. This algorithm holds also for non-rectangular form.

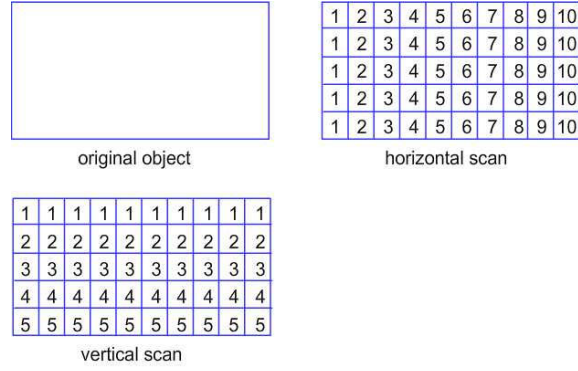

Figure 3. A sample of rectangular form in new image for $I_X = 1..10$ and $I_Y = 1..5$ with $A = 50$ (all are in pixels unit).

The displacement of MO for time difference Δt is then found to be

$$\Delta r = c\sqrt{\left[X_{MO}^{(t+\Delta t)} - X_{MO}^{(t)}\right]^2 + \left[Y_{MO}^{(t+\Delta t)} - Y_{MO}^{(t)}\right]^2}, \quad (5)$$

by using the scaling factor in Equation (1), that makes Δr already in m. Equation (5) tells us that the displacement holds also for non-vertical or non-horizontal motion, but in Δt the MO is considered has a straight motion. Speed of the MO is then obtained by dividing Equation (5) with Δt , which is

$$v = \frac{\Delta r}{\Delta t}. \quad (6)$$

The last step of processing part is to calculate or predicted position of MO in the future, for example at $t + \Delta t'$ position of MO is at

$$r(t + \Delta t') = r(t) + v\Delta t', \quad (7)$$

where r is distance along the path of the road. Using this information the road lamps that are positioned at $t + \Delta t'$, $t + \Delta t''$, .. can be switched on and off as they are needed to. The processing unit will send a signal to AC to turn the light on or of at some distance r the position of the VC.

The algorithm:

Start

$N \leftarrow$ took image

$N + 1 \leftarrow$ took 2nd image

'detect MO, 1st

while $(N + 1) - N \neq 0$

switch on (trigger)

'detect MO, 2nd in 2nd line

while $(N + 1) - N \neq 0$

switch off (reset)

In order to process the input, to calculate the displacement and speed of MO, and to actuate the road lamps a program written in Java is built, whose user interface is shown in Figure 4.

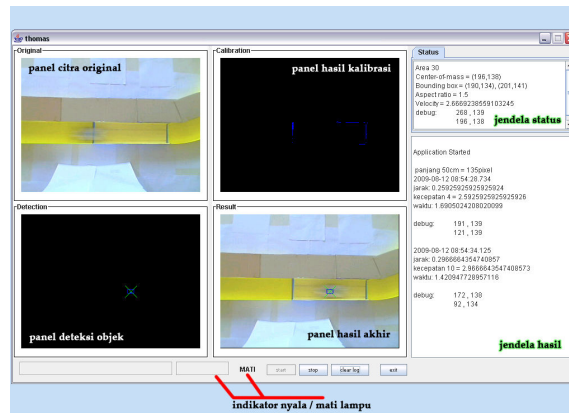

Figure 4. User interface of program used in ARLS consists of live captured image window, scaling factor (calibration) window, MO position detection, overlay (original image + MO position) window, motion parameter window, and calculation result and actuating window.

The AC which is based on a bistable multivibrator using NE555 is illustrated in Figure 5. This electronic actuator job is to receive signal from processing part and that switch the road lamp on or off. Since ARLS designed here using a parallel port [9] to actuate the road lamps, it is possible to control up to 8 lamps. Further detail of 555 based electronic circuit can be found in some sources.

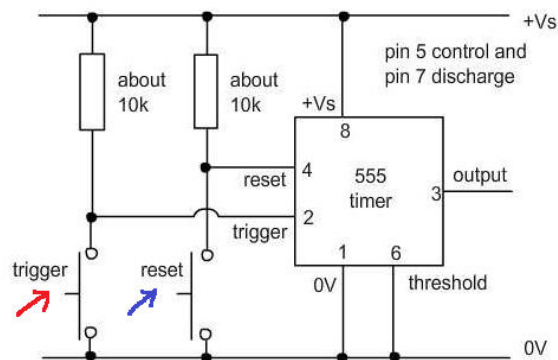

Figure 5. Electronic actuator circuit 555 based (AC) is a bistable multivibrator whose states are controlled by a signal fed to trigger and reset pins.

3. RESULTS AND DISCUSSION

The ARLS is illustrated in Figure 6. The calibration step with position of VC about 1.075 m above the TS and length of TS about 1 m gives $c = 2.7$ cm/pixels.

The realization of this work supposes the availability of a great number of repetitions of samples responding to the same known theoretical model. In practice, as the theoretical model is unknown, we use the Monte-Carlo method based on the generation of the data by computer according to a fixed theoretical model.

To check the result of speed calculation for ARLS ($\langle v_{ARLS} \rangle$) an observation using bare eye and stopwatch is conducted and results are labeled $\langle v_S \rangle$ as shown in Table 1. Both speeds are averaged from several observations. Since the speed of MO is varied, some captured image (image quality) is so blur that can not be further processing or gives a bad results. The performance of ARLS is counted by doing a 100 trials and the number of success is registered. For example, 91 % performance mean that 91 success out of 100 trials. The parameter $r_{MO} - r_{RL}$ is used to indicated whether ARLS switch on the light as the MO pass the lamp (~ 0), or before (< 0), or after (> 0).

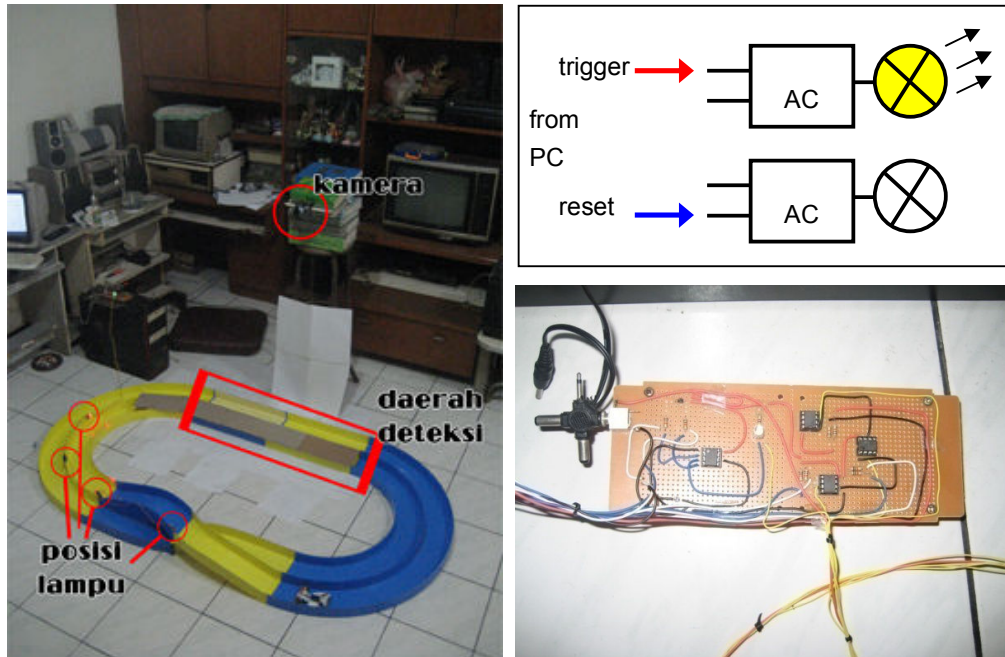

Figure 6. Whole system of ARLS: vehicle toy tracks, VC, PC, and TS (left), the AC part with cables for road lamps (RL) (lower right), and function of trigger and reset pins on AC (upper right).

Table 1: Measurements variable using stopwatch (index S) and ARLS, image quality, and performance of ARLS.

$\langle v_S \rangle$ (m/s)	$\langle v_{ARLS} \rangle$ (m/s)	Image quality (% blur)	$ \Delta v $ (%)	$r_{MO} - r_{RL}$	Performance (%)
0.93	1.03	10	10.75	~ 0	91
1.32	1.63	25	23.48	~ 0	74
1.41	1.85	33	31.21	< 0	54
1.52	2.19	40	44.08	< 0	36
2.03	1.13	> 50	44.33	> 0	0

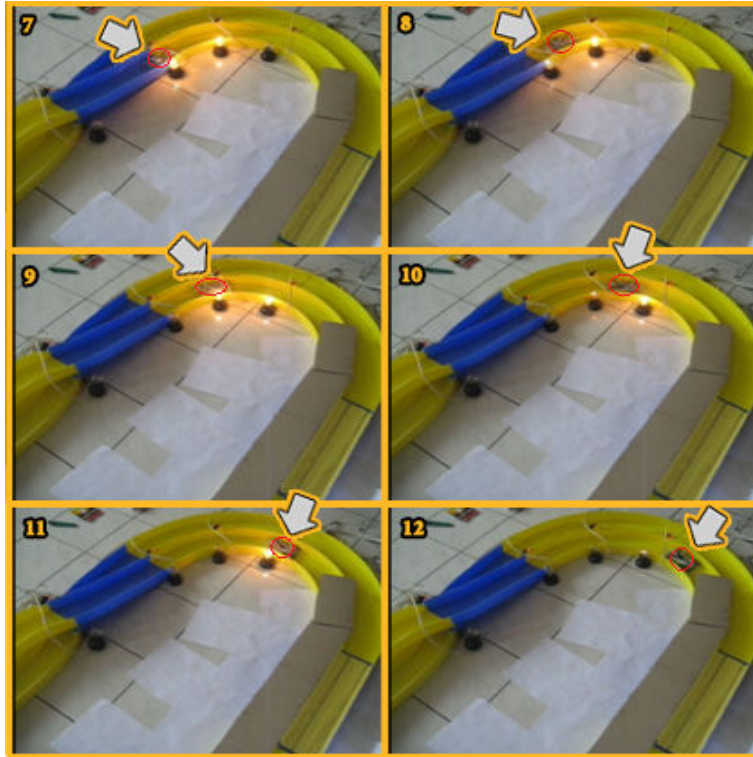

Figure 7. Illustration of good performance of switched on RL (white spots) as MO (indicating by white arrow) is passing it.

It can be seen from Figure 8 that correlation between v_S and v_{ARLS} in range of $\pm 45\%$. The jump at about 2 m/s velocity is due the low PC execution time compared to the velocity of the vehicle. Further investigation is needed to confirm the performance dependence MO speed which should not arise in a ARLS.

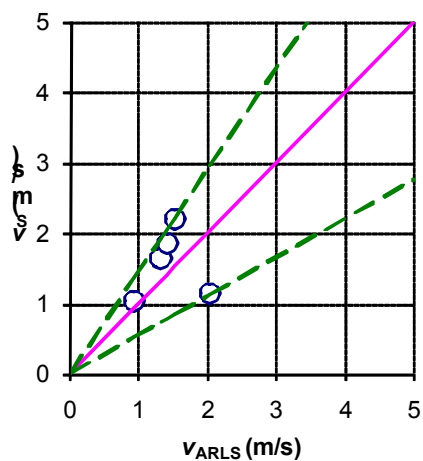

Figure 8. Correlation of measured speed of the vehicle toy (MO) using stopwatch (index S) and ARLS (index ARLS) in range of $\pm 45\%$ (dashed lines) of equality (solid line).

4. DISCUSSION AND CONCLUSION

The highest performance of our automatic road lighting system (ARLS) model, which is about 91 %, is measured at vehicle toy speed 0.93 m/s with camera height 1.075 m, video recording setting 25 fps, road length of test segment 1 m, and vehicle toy dimension 13 cm × 9.3 cm. By setting the limit of acceptable good performance at value above 70%, with previous configuration, the maximum speed of vehicle toy allowed in the ARLS model is about 1.32 m/s. Distance calibration in several road segments are urgently needed and must be not only relied on color distinction since it is really dependent on ambient light which is different in every road segment and can be controlled and predicted. There is no correlation between v_S and v_{ARLS} observed but they are out of proportional in range of ± 45 %.

5. REFERENCES

Archarya, Tinku, and Ray, Ajoy K. 2005. Image Processing. Principles and Applications. USA: John Wiley & Sons, Inc.

Artikel non-personal, 16 Juli 2009 pada 16:06, RGB color model, [online], Wikipedia, (<http://en.wikipedia.org/wiki/Rgp>, diakses 23 Juli 2009.)

Artikel non-personal, 27 Juli 2009 pada 22:31, Digital image processing, [online], Wikipedia, (http://en.wikipedia.org/wiki/Digital_image_processing, diakses 30 Juli 2009.)

Beymer, Davit et all. A Real-time Computer Vision System for Measuring Traffic Parameters. University of California, California

Bovik, Al. Ed. 2000. Handbook of Image & Video Processing. Canada: Academic Press.

Gonzales, Rafael C. and Woods, Richard E. 1987. Digital Image Processing. 2nd Ed. New Jersey: Prentice-Hall.

Hewes, John, 2009, 555 and 556 Timer Circuits.[online], The Electronics Club (<http://www.kpsec.freeuk.com/555timer.html>, diakses 20 Agustus 2009 pada 21:12).

Jain, Anil K. 1989. Fundamentals of Digital Image Processing. New Jersey: Prentice-Hall.

JimPrice.com, 7 November 2008, DB-25 Connector [online], Nulmodem.com (<http://www.nullmodem.com/DB-25.htm>, diakses 20 Agustus 2009 pada 21:12).

Mulkan, Nusantara HK, 31 Mei 2008 pada 21:59, Lampu Jalan Kuras Anggaran, [online], Inilah.com (<http://www.inilah.com/berita.php?id=31026>, diakses 23 Mei 2009.)

Munir, Rinaldi. 2004. Pengolahan Citra Digital. Bandung: Informatika.

Nelson, David and staff. 2004. Mobile Autonomous System Laboratory 6.186 Image Processing Tutorial. <http://maslab.lcs.mit.edu>. MIT.

Storr, Wayne, Agustus 2009, 555 Timer [online], Electronics-Tutorial (<http://www.electronicstutorials.ws/waveforms/bistable.html>, diakses 20 Agustus 2009 pada 21:12).

Tan, Rui, et all. Traffic Video Segmentation Using Adaptive-K Gaussian Mixture Model. University of Shanghai, China.

Thomas Muliawan, "Model Otomatisasi Lampu Jalan Berbasis Pengolahan Citra", Bachelor Thesis, Institut Teknologi Bandung, Indonesia.