

# Neutrinoless Double Beta Decay

Heinrich Päs<sup>1</sup> and Werner Rodejohann<sup>2</sup>

<sup>1</sup> Fakultät für Physik, Technische Universität Dortmund, D-44221 Dortmund, Germany

<sup>2</sup> Max-Planck-Institut für Kernphysik, Postfach 103980, D-69029 Heidelberg, Germany

E-mail: [heinrich.paes@tu-dortmund.de](mailto:heinrich.paes@tu-dortmund.de), [werner.rodejohann@mpi-hd.mpg.de](mailto:werner.rodejohann@mpi-hd.mpg.de)

**Abstract.** We review the potential to probe new physics with neutrinoless double beta decay  $(A, Z) \rightarrow (A, Z + 2) + 2e^-$ . Both the standard long-range light neutrino mechanism as well as short-range mechanisms mediated by heavy particles are discussed. We also stress aspects of the connection to lepton number violation at colliders and the implications for baryogenesis.

Submitted to: *New J. Phys.*

## 1. Introduction

Neutrinoless double beta decay ( $0\nu\beta\beta$ ) experiments are not simply neutrino mass experiments, but have a much more fundamental goal, namely the quest for lepton number violation (LNV). The basic decay mode is

$$(A, Z) \rightarrow (A, Z + 2) + 2e^-, \quad (1)$$

which obviously violates electron lepton number  $L_e$  by two units. At present this endeavor is entering a particular exciting stage, with numerous experiments operating or being under development, using different isotopes and experimental techniques (see Table 1). The previous best limit on the decay, set by the Heidelberg-Moscow experiment in 2001 [1], has finally been improved from 2012 on [2–5], and the limits will be further and further increased, with the potential of discovery always present. A large number of reviews has been written in the last few years [6–16], adding to the important earlier ones [17–21], and emphasizing the importance of the decay and the strong interest of various communities.

In this review we discuss the main physics potential and the conceptual implications that neutrinoless double beta decay brings along. We consider not only the standard three neutrino paradigm, but also different frameworks, including situations associated with heavy particle exchange, so-called short range mechanisms. Tests of such mechanisms are possible for instance in collider experiments. In turn, observation of lepton number violation, either in  $0\nu\beta\beta$  decay or at colliders, has important ramifications for baryogenesis, which we will outline as well.

Why is it important to look for lepton number violation? One could give several reasons, for instance:

- lepton number (as well as baryon number) is only an accidentally conserved global symmetry in the Standard Model<sup>‡</sup>, and its conservation in extended theories seems very unlikely. Indeed, the lowest higher dimensional operator one can write down,  $\mathcal{L} = 1/\Lambda (\Phi L) (\Phi L)$ , immediately violates lepton number and generates neutrino mass. In this language, neutrino mass and lepton number violation are the leading order new physics effects that one might expect to appear, as all other operators are suppressed by additional powers of the cut-off scale  $\Lambda$ . As neutrino mass has been observed in the form of neutrino oscillations, hopes are high that lepton number violation is present as well;
- the Universe contains more matter than antimatter. In order to generate this baryon asymmetry of the Universe, baryon number conservation has to be violated. Unless nature treats baryon and lepton number in a completely different manner, also lepton number violation can be expected;

<sup>‡</sup> Though not really connected to double beta decay or Majorana neutrinos that require lepton number violation by two units, one should note that even within the Standard Model lepton number is actually not conserved: chiral anomalies related to instanton tunneling break global lepton and baryon number by three units each.

Name	Isotope	source = detector			source $\neq$ detector topology
		$\Delta E$ high	$\Delta E$ low	topology	
AMoRE	$^{100}\text{Mo}$	✓	–	–	–
CANDLES	$^{48}\text{Ca}$	–	✓	–	–
COBRA	$^{116}\text{Cd}$ (and $^{130}\text{Te}$ )	–	–	✓	–
CUORE	$^{130}\text{Te}$	✓	–	–	–
CUPID	$^{82}\text{Se}$ / $^{100}\text{Mo}$ / $^{116}\text{Cd}$ / $^{130}\text{Te}$	✓	–	–	–
DCBA/MTD	$^{82}\text{Se}$ / $^{150}\text{Nd}$	–	–	–	✓
EXO	$^{136}\text{Xe}$	–	–	✓	–
GERDA	$^{76}\text{Ge}$	✓	–	–	–
KamLAND-Zen	$^{136}\text{Xe}$	–	✓	–	–
LUCIFER	$^{82}\text{Se}$ / $^{100}\text{Mo}$ / $^{130}\text{Te}$	✓	–	–	–
LUMINEU	$^{100}\text{Mo}$	✓	–	–	–
MAJORANA	$^{76}\text{Ge}$	✓	–	–	–
MOON	$^{82}\text{Se}$ / $^{100}\text{Mo}$ / $^{150}\text{Nd}$	–	–	–	✓
NEXT	$^{136}\text{Xe}$	–	–	✓	–
SNO+	$^{130}\text{Te}$	–	✓	–	–
SuperNEMO	$^{82}\text{Se}$ / $^{150}\text{Nd}$	–	–	–	✓
XMASS	$^{136}\text{Xe}$	–	✓	–	–

**Table 1.** Overview of present and future  $0\nu\beta\beta$  decay experiments, their energy resolution and sensitivity to event topology.

- in Grand Unified Theories lepton and baryon number are often connected, based on the fact that their difference can be gauged in an anomaly-free way when right-handed neutrinos are introduced. Thus baryon number violation typically implies lepton number violation. Moreover, GUTs usually implement a seesaw mechanism and thus Majorana neutrinos, leading eventually to  $0\nu\beta\beta$  decay;
- almost all mechanisms that generate and suppress neutrino masses result in Majorana neutrinos and thus eventually induce  $0\nu\beta\beta$  decay;
- all theories beyond the Standard Model that violate lepton number by one or two units lead to neutrinoless double beta decay. Those include supersymmetric theories with  $R$ -parity violation, left-right symmetry theories, models with spontaneously broken lepton number, etc§;
- in general, global symmetries are not expected to be conserved in quantum gravity theories. One could thus gauge lepton number, and in order to avoid long range forces one would need to break the gauge symmetry, leading again typically to lepton number violation.

All in all, lepton number is not expected to be conserved, and the observation of lepton number violation would be as important as baryon number violation, e.g. proton decay.

§ We note here that if lepton number is violated not by two units but by three or more, there will be no neutrinoless double beta decay, but rather processes with  $\Delta L = 3, 4, \dots$ . One explicit example is “neutrinoless quadruple beta decay” presented in Ref. [22].

The decay width of double beta decay for a single operator inducing the decay can always be written as

$$\Gamma = G(Q, Z) |\mathcal{M} \varepsilon|^2, \quad (2)$$

where  $G(Q, Z)$  is a calculable phase space factor typically scaling with the endpoint energy as  $Q^5$  and  $\mathcal{M}$  is the nuclear matrix element, which is notoriously difficult to calculate. The particle physics parameter  $\varepsilon$ , which depends on particle masses, mixing parameters etc., is most important from the point of view of this review. Note that more than one mechanism can contribute, hence the amplitude of the decay can actually be

$$\mathcal{A} = \sum_x \mathcal{M}_x \varepsilon_x, \quad (3)$$

i.e. a sum over different mechanisms, which can potentially interfere with each other.

The review is organized as follows: in Section 2 we summarize double beta decay mediated by light massive Majorana neutrinos while Section 3 deals with alternative and short-range mechanisms, including potential tests. The connection between  $0\nu\beta\beta$  decay, lepton number violation at colliders and baryogenesis is discussed in Section 4, before we conclude<sup>||</sup> in Section 5.

## 2. Neutrinoless Double Beta Decay and Neutrino Masses

We begin with the arguably best motivated possibility for the decay, the “standard interpretation” or “mass mechanism”, namely that the light massive neutrinos that we observe to oscillate in terrestrial experiments mediate double beta decay. In this case, searches for the process are searches for neutrino mass, complementing the other approaches to determine neutrino masses. Those approaches include direct searches in classical Kurie-plot experiments like the upcoming KATRIN [23], Project 8 [24], ECHo [25] or MARE [26] experiments, and cosmological observations, see [27] for a review in this Focus Issue. Cosmology probes the sum of neutrino masses,

$$\Sigma = \sum m_i, \quad (4)$$

Kurie-plot experiments test the incoherent sum

$$m_\beta = \sqrt{\sum |U_{ei}|^2 m_i^2}, \quad (5)$$

whereas neutrinoless double beta decay in the standard interpretation tests the quantity (see Fig. 1)

$$|m_{ee}| = \left| \sum U_{ei}^2 m_i \right|, \quad (6)$$

which is usually called the effective mass and coincides with the  $ee$  element of the neutrino mass matrix in flavor space.

<sup>||</sup> Topics that are not covered in this review are the experimental and nuclear physics aspects, where the interested reader should consult e.g. the review articles [7, 14, 16] and [13], respectively.

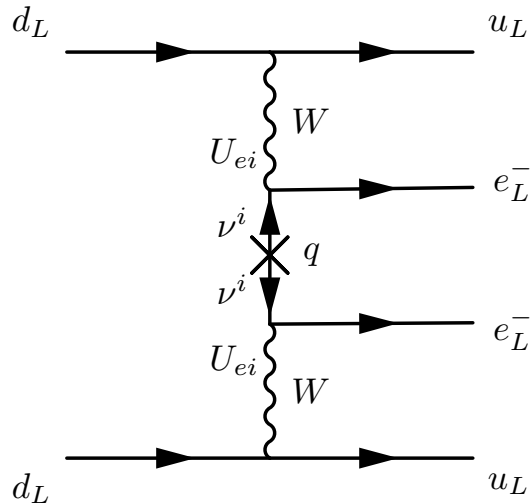

**Figure 1.** Feynman diagram for the standard interpretation (mass mechanism) of neutrinoless double beta decay.

Here  $m_i$  are the neutrino masses, and  $U_{ei}$  are elements of the leptonic mixing, or PMNS, matrix that is usually parametrized as

$$U = \begin{pmatrix} c_{12}c_{13} & s_{12}c_{13} & s_{13}e^{-i\delta} \\ -s_{12}c_{23} - c_{12}s_{23}s_{13}e^{i\delta} & c_{12}c_{23} - s_{12}s_{23}s_{13}e^{i\delta} & s_{23}c_{13} \\ s_{12}s_{23} - c_{12}c_{23}s_{13}e^{i\delta} & -c_{12}s_{23} - s_{12}c_{23}s_{13}e^{i\delta} & c_{23}c_{13} \end{pmatrix} P, \quad (7)$$

where  $s_{ij} = \sin \theta_{ij}$ ,  $c_{ij} = \cos \theta_{ij}$  and  $\delta$  is the ‘‘Dirac phase’’ responsible for CP violation in neutrino oscillation experiments. The diagonal phase matrix  $P = \text{diag}(1, e^{i\alpha}, e^{i(\beta+\delta)})$  contains the two Majorana phases  $\alpha$  and  $\beta$ , which are associated with the Majorana nature of neutrinos and thus only show up in lepton number violating processes (a review on properties of Majorana particles can be found in [28]). For three neutrinos we have therefore 9 physical parameters, three masses  $m_{1,2,3}$ , three mixing angles  $\theta_{12}, \theta_{13}, \theta_{23}$  and three phases  $\delta, \alpha, \beta$ . The effective mass depends thus on 7 out of those 9 physical neutrino parameters:

$$|m_{ee}| = f(\theta_{12}, \theta_{13}, \alpha, \beta, m_1, m_2, m_3). \quad (8)$$

Of these seven parameters, we currently do not know the phases and the lightest mass, where in addition the mass ordering is unknown, i.e. it could be either  $m_3 > m_2 > m_1$  (normal ordering) or  $m_2 > m_1 > m_3$  (inverted ordering). Global fits of all available neutrino data can be found in Refs. [29–31]. One can then use Eqs. (4, 5, 6) to plot the three neutrino mass observables against each other [32], see Fig. 2, and interpret potential current and future experimental results.

For instance, in case one finds positive results for  $m_\beta$  and  $|m_{ee}|$  in any of the green or red areas in the upper plot of Fig. 2, then this would be a convincing confirmation of the paradigm that there are three massive Majorana neutrinos mixing among each other. Even more spectacular would be if inconsistencies arise, e.g. a measurement of

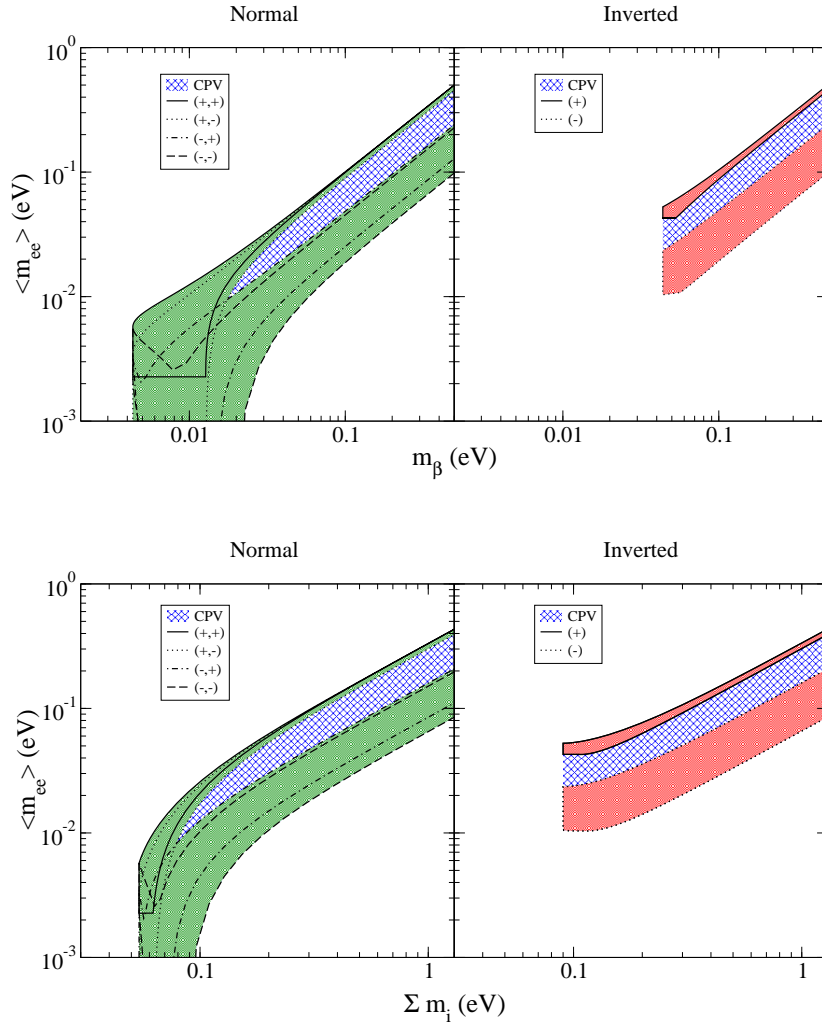

**Figure 2.** Neutrino mass observables within the standard three neutrino paradigm. The upper plot shows the effective mass against the kinematical neutrino mass accessible in Kurie-plot experiments, the lower plot depicts the effective mass against the sum of masses accessible in cosmological measurements. The values for relative signs of the mass eigenvalues, and the areas which only can be realized for non-trivial CP phases are indicated.

the effective mass that is incompatible with limits from KATRIN or cosmology. This would imply that something in our interpretation of double beta decay goes amiss, i.e. that another mechanism causes the decay. Therefore, the complementarity of the various approaches to determine the neutrino mass offers exciting possibilities, since different assumptions enter their interpretation. KATRIN-like experiments are essentially model-independent, as only bizarre things like tachyonic neutrinos could spoil the results, and moreover the interpretation is “clean” as beta decay is theoretically well under control. However, in terms of numbers the limits are and will be the weakest, and further improvement beyond 0.1 eV seems impossible. Cosmology yields the best limits

Method	observable	now [eV]	near [eV]	far [eV]	pro	con
Kurie	$\sqrt{\sum  U_{ei} ^2 m_i^2}$	2.3	0.2	0.1	model-indep.; theo. clean	final?; worst
Cosmo.	$\sum m_i$	0.7	0.3	0.05	best; NH/IH	systemat.; model-dep.
$0\nu\beta\beta$	$ \sum U_{ei}^2 m_i $	0.3	0.1	0.05	fundament.; NH/IH	model-dep.; theo. dirty

**Table 2.** Summary of the main approaches to neutrino mass.

in terms of numbers, and can even contribute to the question of mass ordering. However, it suffers from difficult systematics and relies on model input, e.g. departures from simple  $\Lambda$ CDM models can weaken limits considerably. Double beta decay is the most fundamental approach as it is connected to lepton number violation, and can even say something about the mass ordering (see below). However, it is very model-dependent as many mechanisms apart from the standard neutrino mass mechanism can mediate the decay. Furthermore, the process is theoretically “dirty”, as nuclear matrix element introduce a sizable uncertainty. The pros and cons of the different approaches and their current as well as near and far future limits are summarized in Table 2.

It is important to note that for the normal mass ordering the effective mass can vanish, whereas for the inverted ordering the effective mass cannot vanish [35]. Hence, the lifetime in this latter case is necessarily finite, though of course an experimental challenge. The lower limit is given by

$$|m_{ee}|_{\min}^{\text{IH}} = \sqrt{\Delta m_{31}^2 c_{13}^2 (1 - 2 \sin^2 \theta_{12})} \simeq (0.01 \dots 0.02) \text{ eV}, \quad (9)$$

corresponding to half-lives around  $10^{27}$  yrs, see Fig. 3. This minimal value depends rather strongly on the solar neutrino mixing angle  $\theta_{12}$ . Hence, a more precise determination of  $\theta_{12}$  in future oscillation experiments would be rather welcome [36]. Within the well-motivated three Majorana neutrino paradigm the upper and lower value of the effective mass in the inverted ordering are the natural medium-term goal for neutrinoless double beta decay searches. In case the mass ordering turns out to be normal, this motivation is lost. However, the value of neutrino mass remains unknown, and consistency checks with cosmological or Kurie-plot limits are necessary. Moreover, as argued in the introduction, the highly important search for lepton number violation needs to be pursued further.

What is the current limit on the effective mass? To answer this question, a comparison of different isotopes and matrix elements is necessary. One of the most competitive lifetime limits is set by GERDA [4],  $T_{1/2}^{\text{Ge}} > 2.1 \cdot 10^{25}$  yrs, or, combined with earlier Germanium experiments [1, 37],  $T_{1/2}^{\text{Ge}} > 3.0 \cdot 10^{25}$  yrs. A similarly strong limit is obtained by the KamLAND-Zen experiment [3], namely  $T_{1/2}^{\text{Xe}} > 2.6 \cdot 10^{25}$  yrs. Using Eq. (2), one finds that experiments using  $^{136}\text{Xe}$  give a better limit than experiments with

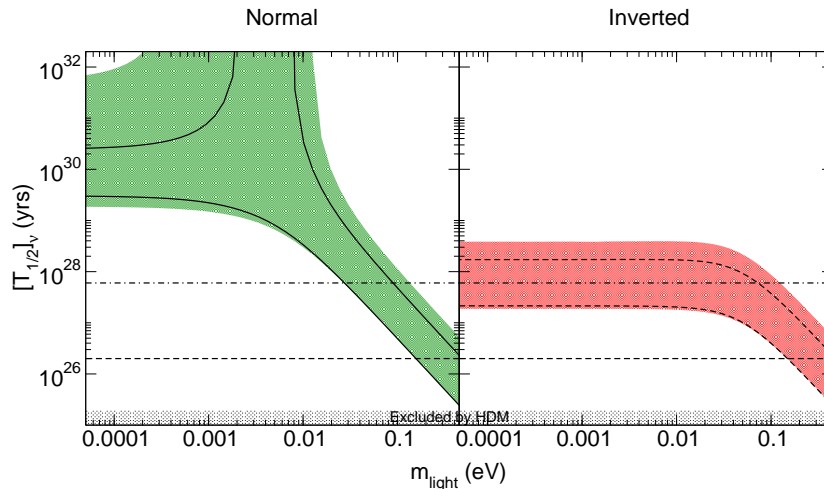

**Figure 3.** Example for typical half lives corresponding to  $^{76}\text{Ge}$  and a matrix element of  $\mathcal{M}_{\text{Ge}} = 4.6$ .

$^{76}\text{Ge}$  if their lifetime limit fulfills the condition:

$$T_{1/2}^{\text{Xe}} > T_{1/2}^{\text{Ge}} \frac{G_{\text{Ge}}}{G_{\text{Xe}}} \left| \frac{\mathcal{M}_{\text{Ge}}}{\mathcal{M}_{\text{Xe}}} \right|^2 \text{ yrs.} \quad (10)$$

Using the phase space factors of Refs. [38,39], and the matrix elements of various groups, the limits on the effective mass in Table 3 are obtained, adapted from [40]. Some matrix element approaches have a better limit from Germanium, others from Xenon. Taking correctly the conservative values, both isotopes give essentially the same limit of ¶

$$|m_{ee}| \lesssim 0.3 \text{ eV.} \quad (11)$$

Future improvement of this limit goes with the square root of lifetime limits.

So far the effective mass has simply been used as a phenomenological parameter. Of course, in case one has a model at hand, one can predict  $|m_{ee}|$  to some extent. One example are popular flavor symmetry models to explain the peculiar features of lepton mixing [49, 50]. While the neutrino mass itself cannot be predicted in this framework, relations between neutrino masses are possible to predict, so-called neutrino mass sum-rules such as  $\tilde{m}_1 + \tilde{m}_2 = \tilde{m}_3$ . Here the masses are understood to be complex, i.e. including the Majorana phases. These relations exclude some possible combinations of masses and phases, and thus only certain areas in parameter space are possible, which allows to rule out certain models. Many sum-rule examples have been discussed in the literature [51–54]. Even more predictive are some Grand Unified Theories, where the Yukawa matrices of all fermions are related and fitting the constrained matrices to the observed mass and mixing parameters allows to predict unknown parameters such as

¶ See also Ref. [41] for an approach to combine different experiments in a statistical manner.



NME	$^{76}\text{Ge}$		$^{136}\text{Xe}$
	GERDA	combined	KamLAND-Zen
<b>EDF(U)</b> [42]	<b>0.32</b>	<b>0.27</b>	<b>0.13</b>
<b>ISM(U)</b> [43]	<b>0.52</b>	<b>0.44</b>	<b>0.24</b>
<b>IBM-2</b> [44]	<b>0.27</b>	<b>0.23</b>	<b>0.16</b>
<b>pnQRPA(U)</b> [45]	<b>0.28</b>	<b>0.24</b>	<b>0.17</b>
<b>SRQRPA-B</b> [46]	<b>0.25</b>	<b>0.21</b>	<b>0.15</b>
<b>SRQRPA-A</b> [46]	<b>0.31</b>	<b>0.26</b>	<b>0.23</b>
<i>QRPA-A</i> [47]	<i>0.28</i>	<i>0.24</i>	<i>0.25</i>
<i>SkM-HFB-QRPA</i> [48]	<i>0.29</i>	<i>0.24</i>	<i>0.28</i>

**Table 3.** Limits on the effective mass  $m_{ee}$  (in eV) from Germanium and Xenon experiments and different matrix element calculations. The calculations listed in bold face yield a better limit for  $^{136}\text{Xe}$ , the ones in italic give a better limit for  $^{76}\text{Ge}$ . Adapted from [40].

$|m_{ee}|$ , see [55].

While the three neutrino paradigm is very attractive and robust, there are longstanding hints that light sterile neutrinos with mass around an eV and mixing around 10% exist, see Ref. [56] for a review of the various hints and ongoing as well as future tests. Such a fourth neutrino would modify all neutrino mass observables, in particular the effective mass:

$$|m_{ee}| = \left| \underbrace{|U_{e1}|^2 m_1 + |U_{e2}|^2 m_2 e^{2i\alpha} + |U_{e3}|^2 m_3 e^{2i\beta}}_{m_{ee}^{\text{act}}} + \underbrace{|U_{e4}|^2 m_4 e^{2i\gamma}}_{m_{ee}^{\text{st}}} \right|, \quad (12)$$

where  $\gamma$  is an additional Majorana phase and  $m_{ee}^{\text{act}}$  the three neutrino contribution discussed so far. The sterile contribution  $|m_{ee}|^{\text{st}}$  to  $0\nu\beta\beta$  (assuming a 1+3 scenario) generates typical values of the same order as  $m_{ee}^{\text{act}}$  for the inverted ordering:

$$|m_{ee}|^{\text{st}} \simeq \sqrt{\Delta m_{\text{st}}^2} |U_{e4}|^2 \begin{cases} \gg |m_{ee}|_{\text{NH}}^{\text{act}} \\ \simeq |m_{ee}|_{\text{IH}}^{\text{act}} \end{cases}. \quad (13)$$

Thus, in contrast to the three-generation case, for a normal mass ordering of the active neutrinos the effective mass cannot vanish anymore, whereas for an inverted ordering of the active neutrinos the effective mass can vanish now [57–60]. The phenomenology has completely turned around! This demonstrates that any physics output of neutrinoless double beta decay depends dramatically on the assumptions.

We are thus naturally lead to discuss alternative mechanisms of double beta decay, to be addressed in the following Section.

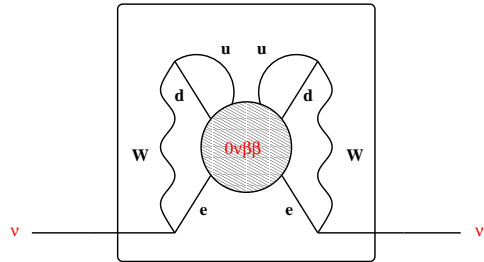
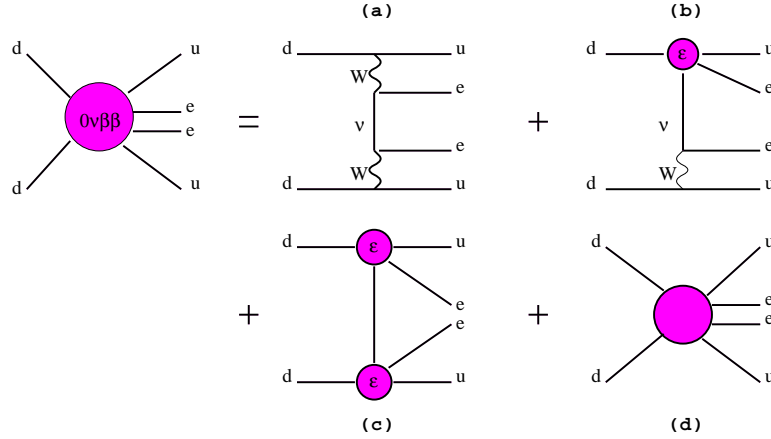

**Figure 4.** Black box theorem depicted as a Feynman diagram: neutrinoless double beta decay always induces a neutrino Majorana mass (from [12]).

### 3. Neutrinoless Double Beta Decay and Short-Range Mechanisms

Apart from the standard interpretation where a massive Majorana neutrino is being exchanged between Standard Model (SM)  $V - A$  vertices, in principle any operator violating lepton number by two units and transforming two neutrons into two protons, two electrons and nothing else will induce the decay. This does not mean, however, that neutrinoless double beta decay and the question whether the neutrino possesses a Majorana mass are totally decoupled: the observation of neutrinoless double beta decay demonstrates that lepton number is violated by two units. Such lepton number violation implies that neutrinos have to be Majorana particles. That the two are inseparably connected can be proven by what is known as the black box theorem [61–65]. Graphically the theorem can be depicted as shown in Fig. 4: If double beta decay has been seen, a Majorana neutrino mass term is generated at 4-loop order, even if the underlying particle physics model does not contain a tree-level neutrino mass. Of course this contribution to the neutrino mass is rather small [66], namely of order  $G_F^4/(16\pi^2)^4 m_{u,d,e}^5 \sim 10^{-25}$  eV, and thus clearly neither the dominant contribution to neutrinoless double beta decay nor to neutrino mass itself. Note that this 4-loop contribution is only the minimal, guaranteed connection between neutrino mass and double beta decay arising in any scenario with  $\Delta L_e = 2$  LNV. Explicit models leading to  $0\nu\beta\beta$  can generate neutrino mass at tree, 1-, 2- or 3-loop level. Depending on the model, the neutrino masses generated in this way can lead to a comparable, sub-dominant or dominant neutrino contribution to the decay, and/or to a main, sub-leading or negligible contribution to neutrino mass. For a comparative analysis of all scalar-mediated models based on the SM gauge group see [67].

The most general operator inducing the decay can be parametrized in terms of effective couplings  $\varepsilon$  (see Fig. 5) [68,69]. The diagram depicts the standard interpretation exchange of a light Majorana neutrino between two SM vertices (contribution a)), the exchange of a light Majorana neutrino between an SM vertex and an effective operator which is point-like at the nuclear Fermi momentum scale (the inverse size of the nucleon)  $\mathcal{O}(100)$  MeV (contribution b)), contribution c), which contains two non-SM vertices and can be neglected when compared to contribution b), and a short-range contribution triggered by a single dimension 9 operator being point-like at the Fermi momentum



**Figure 5.** Mechanisms for neutrinoless double beta decay: the most general effective operator triggering the decay can be decomposed into diagrams with SM vertices and effective vertices being point-like at the nuclear Fermi momentum scale  $\mathcal{O}(100)$  MeV (from [68]).

scale (contribution d)).

We can estimate the energy scale of short-range diagrams which can lead to comparable double beta decay lifetimes compared with the standard interpretation. The standard diagram discussed in Section 2 has an amplitude of order  $G_F^2 |m_{ee}|/q^2$ . If the decay is mediated by particles heavier than the characteristic momentum scale of  $q \simeq 100$  MeV, then the corresponding amplitude is  $c/M^5$ , where  $M$  is the mass of those particles and  $c$  a combination of flavor and possible gauge coupling parameters. Hence, for  $c$  of order one and  $M$  of order TeV this amplitude equals the current limit on the standard amplitude (ignoring here a small suppression of the nuclear matrix elements for short-range diagrams):

$$T_{1/2}^{0\nu\beta\beta}(m_\nu = 1 \text{ eV}) \simeq T_{1/2}^{0\nu\beta\beta}(M = 1 \text{ TeV}). \quad (14)$$

We thus can test short-range diagrams for double beta decay with the LHC or lepton flavor violation experiments, which are also sensitive to the TeV scale.

The most general decay rate contains all combinations of leptonic and hadronic currents induced by the operators

$$\mathcal{O}_{V\mp A} = \gamma^\mu(1 \mp \gamma_5), \quad \mathcal{O}_{S\mp P} = (1 \mp \gamma_5), \quad \mathcal{O}_{T_{L/R}} = \frac{i}{2}[\gamma_\mu, \gamma_\nu](1 \mp \gamma_5), \quad (15)$$

allowed by Lorentz invariance.

Examples for contribution b) are the leptoquark and  $R$ -parity violating SUSY accompanied decay modes, examples for contribution d) are decay modes where only SUSY particles or heavy neutrinos and gauge bosons in left-right-symmetric models are exchanged between the decaying nucleons. Present experiments have a sensitivity to the effective couplings of

$$\varepsilon < \text{few} \cdot (10^{-7} - 10^{-10}). \quad (16)$$

For a more detailed, recent overview on this approach to double beta decay see [12].

As has been pointed out above for the  $d = 9$  operator triggering the contribution d) it can be estimated that an observation of  $0\nu\beta\beta$  decay with present-day experiments would involve TeV scale particles and thus would offer good chances to see new physics associated with LNV at the LHC. A crucial prerequisite for such a conclusion is of course a possibility to discriminate among the various mechanisms which may be responsible for the decay. This is a difficult task but may be possible at least for some of the mechanisms by observing neutrinoless double beta decay in multiple isotopes [46, 70–72]. or by measuring the decay distribution, for example in the SuperNEMO experiment [73]. Another possibility to discriminate between various short-range contributions to neutrinoless double beta decay at the LHC itself is to identify the invariant mass peaks of particles produced resonantly in the intermediate state or to analyze the charge asymmetry between final states involving particles and/or anti-particles [74, 75].

### 3.1. Left-Right Symmetry

In Left-Right Symmetric Models the Standard Model gauge symmetry is extended to the group  $SU(2)_L \otimes SU(2)_R \otimes U(1)_{B-L}$ . Right-handed neutrinos are a necessary ingredient to realize this extended symmetry and are included in an  $SU(2)_R$  doublet. A generation of leptons is assigned to the multiplets  $L_i = (\nu_i, l_i)$  with the quantum numbers  $Q_{LL} = (1/2, 0, -1)$  and  $Q_{LR} = (0, 1/2, -1)$  under  $SU(2)_L \otimes SU(2)_R \otimes U(1)_{B-L}$ . The Higgs sector contains a bidoublet  $\phi$  and two triplets  $\Delta_L$  and  $\Delta_R$ . The VEV  $v_R$  of the neutral component of  $\Delta_R$  breaks  $SU(2)_R \otimes U(1)_{B-L}$  to  $U(1)_Y$  and generates masses for the right-handed  $W_R$  and  $Z_R$  gauge bosons, and the heavy neutrinos. Since right-handed currents and particles have not been observed,  $v_R$  has to be sufficiently large. Neutrino masses are then generated within a type-I+II seesaw,

$$m_\nu = m_L - m_D M_R^{-1} m_D^T, \quad (17)$$

where  $m_L = f v_L$  and  $M_R = f v_R$  are the VEVs of the triplets. Within left-right symmetric models several diagrams mediating double beta decay exist, see Fig. 6.

The right-handed neutrinos and  $W_R$  bosons can mediate the right-handed analogue of the standard mechanism discussed above [18, 76, 77]. As the particles exchanged are much heavier than the nuclear Fermi momentum, this is a realization of the short-range operator. The now heavy neutrino mass will appear in the denominator of the amplitude instead of the numerator. The effective coupling is denoted  $\varepsilon_3^{RRz}$ . Assuming manifest left-right symmetry, i.e. identical gauge couplings, in terms of the left-right-symmetric model parameters it is given by

$$\varepsilon_3^{RRz} = \sum_{i=1}^3 V_{ei}^2 \frac{m_p}{m_{N_i}} \frac{m_{W_L}^4}{m_{W_R}^4}, \quad (18)$$

where  $V$  denotes the matrix describing the mixing among the heavy right-handed neutrinos. Searches for  $0\nu\beta\beta$  yield the limit  $|\varepsilon_3^{RRz}| \lesssim 1 \cdot 10^{-8}$ .

Moreover, because of the presence of right-handed currents, the exchange of light neutrinos does not necessarily require a chirality violating mass insertion. The coupling

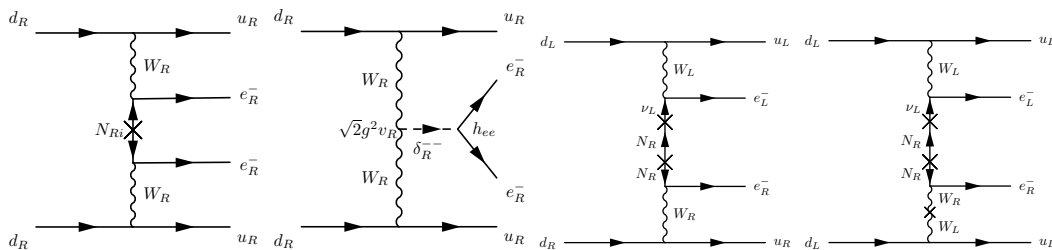

**Figure 6.** Feynman diagrams for the leading diagrams of neutrinoless double beta decay in left-right symmetric theories: heavy neutrino exchange with right-handed currents, triplet exchange, the  $\lambda$ - and the  $\eta$ -diagram (from left to right).

parameters of the corresponding effective long-range operators can be written as

$$\varepsilon_{V+A}^{V+A} = \sum_{i=1}^3 U_{ei} S_{ei} \frac{m_{W_L}^2}{m_{W_R}^2}, \quad \varepsilon_{V-A}^{V+A} = \sum_{i=1}^3 U_{ei} S_{ei} \tan \zeta, \quad (19)$$

with the current experimental limits  $|\varepsilon_{V+A}^{V+A}| \lesssim 5 \cdot 10^{-7}$  and  $|\varepsilon_{V-A}^{V+A}| \lesssim 3 \cdot 10^{-9}$ , respectively, and where  $S$  describes the mixing between left- and right-handed neutrinos. The diagram governed by  $\varepsilon_{V+A}^{V+A}$  is often called the  $\lambda$ -diagram, the one governed by  $\varepsilon_{V-A}^{V+A}$  the  $\eta$ -diagram. While the mixing  $S$  is small in the simplest seesaw scenarios, one can easily arrange for large left-right (or equivalently light-heavy) mixing. In this case both diagrams can be expected to dominate over the heavy neutrino exchange diagram with right-handed currents [78, 79]. Analyses of the type-I seesaw mechanism with sizable light-heavy mixing can be found in [80, 81].

Finally, there exists a contribution from the exchange of a right-handed doubly-charged Higgs triplet  $\Delta_R$ , which has the same effective operator structure as heavy neutrino exchange. The effective short-range coupling strength is here given as

$$\varepsilon_3^{RRz} = \sum_{i=1}^3 V_{ei}^2 \frac{m_{N_i} m_p}{m_{\Delta_R}^2} \frac{m_{W_L}^4}{m_{W_R}^4} \lesssim 1.1 \cdot 10^{-8}, \quad (20)$$

Since the Higgs triplet can mediate  $\mu \rightarrow 3e$  at tree level there are strong constraints on this diagram by lepton flavor violation bounds [78].

A particularly predictive case occurs if type-II seesaw dominance holds, i.e. if the neutrino mass matrix is generated by the  $SU(2)_L$  triplet term  $m_L$ . Due to the discrete left-right symmetry this term is directly proportional to the heavy neutrino mass matrix, hence  $V$  in Eq. (20) equals the PMNS matrix  $U$  and  $m_i \propto M_i$ . It follows [82] that typically for a normal mass ordering the lifetime of double beta decay is finite while for an inverted mass ordering it can be infinite due to possible cancellations. Just as for the case of light sterile neutrinos (see Eq. (13)) the standard phenomenology has turned around.

Obviously many diagrams can contribute at the same time and interference between the different diagrams can arise. This nicely demonstrates the importance of the ideas discussed above to discriminate the various mechanisms. Another example for the

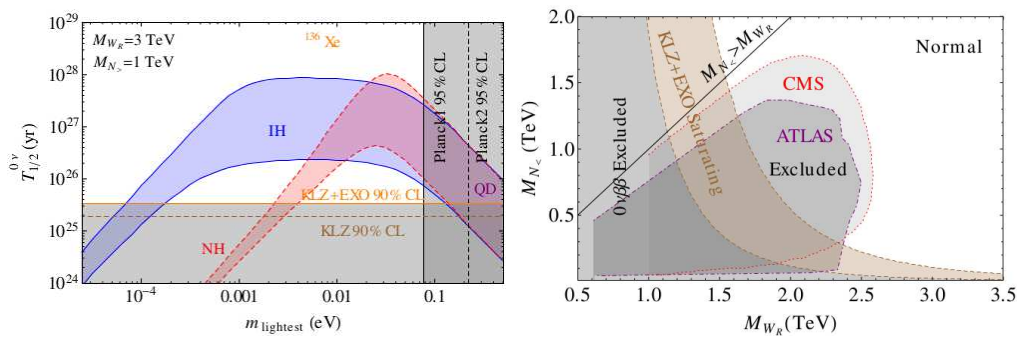

**Figure 7.** Left: Lifetime of double beta decay if the standard and the heavy neutrino exchange with right-handed current diagrams are added in type-II dominance. Right: Comparison of double beta decay and LHC limits on heavy neutrino masses and right-handed  $W_R$  mass, demonstrating their complementarity (from [40]).

consequences of several diagrams, adding for instance the heavy neutrino exchange with right-handed currents to the standard amplitude in the case of type-II dominance is illustrated in Fig. 7. A lower limit on the smallest neutrino mass results, in contrast to the upper limit deduced if only the standard diagram was taken into account.

### 3.2. $R$ -Parity Violating Supersymmetry

The MSSM (minimal supersymmetric extension of the Standard Model) assumes the existence of a discrete  $Z_2$  symmetry, called  $R$ -parity. This symmetry guarantees the lightest supersymmetric particle to be stable, providing a dark matter candidate for cosmology and avoiding too fast proton decay. Since a convincing theoretical reason for  $R$ -parity conservation is lacking, one can investigate the consequences of its violation. Using discrete symmetries one can avoid terms that lead to proton decay and is left with a superpotential including the LNV terms

$$W_{RPV} = \lambda'_{ijk} L_i Q_j \bar{D}_k, \quad (21)$$

where  $i, j, k$  are generation indices. Note that the lepton number violation is by one unit, hence two vertices are required for  $0\nu\beta\beta$ , which occurs through long- and short-range Feynman graphs involving the exchange of superpartners [83–87]. The short-range contribution has been discussed in [83–85]. Combining the half-life limit [4] with the corrected numerical values [12] of the nuclear matrix elements first calculated in [85] leads to the limit on  $\lambda'_{111}$  given by

$$\lambda'_{111} \leq 2 \cdot 10^{-4} \left( \frac{m_{\tilde{q}}}{100 \text{ GeV}} \right)^2 \left( \frac{m_{\tilde{g}}}{100 \text{ GeV}} \right)^{1/2}, \quad (22)$$

where we have assumed dominance of the gluino exchange diagram and took  $m_{\tilde{d}_R} = m_{\tilde{u}_L} \equiv m_{\tilde{q}}$  for the exchanged squarks.

In addition  $0\nu\beta\beta$  decay is also sensitive to other combinations of the couplings  $\lambda'_{ijk}$ . Taking into account the fact that the SUSY partners of the left- and right-handed quark states can mix with each other, new diagrams appear in which the neutrino-mediated

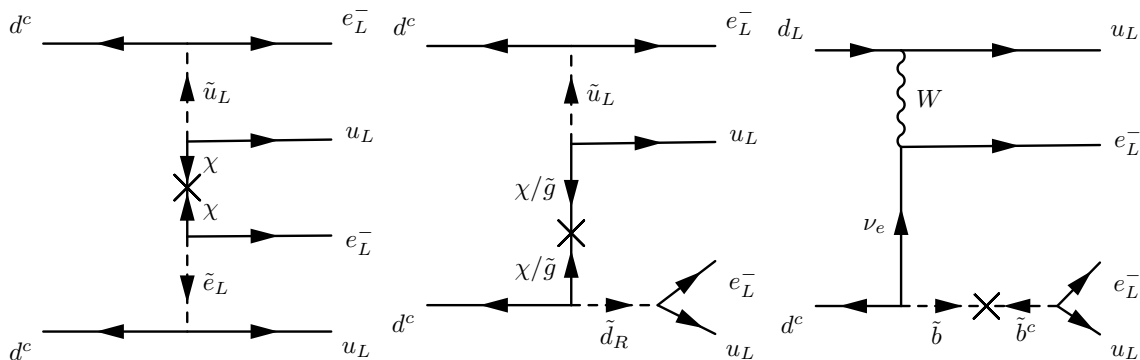

**Figure 8.** Left and center: exemplary short-range diagrams for neutrinoless double beta decay in  $R$ -parity violating SUSY. Right: long-range diagram.

double beta decay is accompanied by SUSY exchange in the vertices [86–88], see Fig. 8 and note that this is a long-range diagram. Assuming the supersymmetric mass parameters of order 100 GeV, the present GERDA half life limit implies:  $\lambda'_{113}\lambda'_{131} \leq 3 \cdot 10^{-8}$ ,  $\lambda'_{112}\lambda'_{121} \leq 1 \cdot 10^{-6}$ . Comparable bounds can be deduced from  $B$  and  $K$  physics which depend however on different superpartner masses and are thus complementary to the bounds derived here [89]. Recently, the lepton non-universality anomaly at LHCb [90] and the CMS anomaly in the search for right-handed  $W$  bosons have been explained within  $R$ -parity violating SUSY with  $\lambda'_{113} = \mathcal{O}(10^{-3} - 10^{-2})$  and  $\lambda'_{112} = \mathcal{O}(10^{-1})$  and scalar masses in the TeV range [91].

### 3.3. Leptoquarks

Leptoquarks (LQs) are hypothetical bosons (scalar or vector particles) with couplings to both leptons and quarks which appear for instance in GUTs, extended technicolor or compositeness models. LQs which conserve baryon number can be possibly within reach of accelerator experiments [92]. For a detailed list on constraints from non-accelerator searches see, for example [93] and [94]. The mixing of different LQ multiplets by a possible leptoquark-Higgs coupling [95] can lead to long-range contributions to  $0\nu\beta\beta$  decay, if these couplings violate lepton number [96]. From the lower limit on the  $0\nu\beta\beta$  lifetime, bounds on effective couplings can be derived [96] which are typically of order

$$Y_{LQ\text{-Higgs}} = \text{few} \cdot 10^{-6} \quad (23)$$

for LQ masses of the order of  $\mathcal{O}(200)\text{GeV}$ .

### 3.4. Extra Dimensions

Models with more than three space dimensions became popular in recent years as a way to reduce the four-dimensional Planck scale and alleviate this way the hierarchy problem. Extra dimensions have also been suggested as a way to generate small Dirac neutrino masses by utilizing the volume suppressed wave function overlap of a

left-handed neutrino confined to a three-dimensional subspace called the brane and a right-handed neutrino propagating in the extra-dimensional hyperspace called the bulk [97, 98]. A minimal higher-dimensional model implementing LNV compactifies a 5-dimensional theory on an  $S^1/Z_2$  orbifold, and adds a single (bulk) sterile neutrino to the field content of the SM [99]. While the singlet neutrinos can freely propagate in the bulk, all SM particles are localized on the  $(3 + 1)$ -dimensional brane.

An interesting feature of such extra-dimensional models is that the excitations of the sterile neutrino in the compactified extra dimensions, a so-called Kaluza-Klein tower of states, contribute to the  $0\nu\beta\beta$  decay rate. The masses of these Kaluza-Klein states are obtained by diagonalizing the infinitely dimensional Kaluza-Klein mass matrix and result approximately as

$$m_{(n)} \approx \frac{n}{R} + \varepsilon. \quad (24)$$

Here  $n$  is the index denoting the Kaluza-Klein excitation,  $R$  is the radius of the extra dimension and  $\varepsilon$  is the smallest diagonal entry in the neutrino mass matrix. As the  $m_{(n)}$  range from small masses giving rise to long-range contributions over the 100 MeV region up to large masses with short-range contributions, such scenarios constitute a special case which is not included in the effective operator parametrization described above.

An important problem of such extra-dimensional models is the generic prediction of a Kaluza-Klein neutrino spectrum with approximately degenerate masses and opposite CP parities that leads to an extremely suppressed contribution to double beta decay and only one  $\Delta m^2$  insufficient to explain solar and atmospheric neutrino oscillations. If the brane was located at one of the two orbifold fixed points, the lepton number violating operators thus would be absent as a consequence of the  $Z_2$  discrete symmetry. If, however, the brane is shifted away from the orbifold fixed points, the Kaluza-Klein neutrinos can couple to the  $W$  bosons with unequal strength, thus avoiding CP-parity cancellations in the  $0\nu\beta\beta$  amplitude. This breaking of lepton number can lead to observable effects in neutrinoless double beta decay experiments. The size of the brane-shift can then be determined from the  $0\nu\beta\beta$  lifetime or its upper bound.

This leads to a nuclear matrix element depending on the Kaluza-Klein neutrino masses  $m_{(n)}$ , and thus to predictions for the double beta decay observable that depend on the double beta emitter isotope used in the experiment. Another interesting property of this model is that the amplitude of the decay is not bounded from above by the mass eigenvalues of the light neutrinos: It can be close to the experimental limit even for an almost vanishing lightest neutrino mass which constitutes a rather unique property of such extra-dimensional brane-shifted scenarios.

#### 4. Lepton Number Violation at Colliders, Double Beta Decay and the Baryon Asymmetry of the Universe

In this Section we deal with the links between neutrinoless double beta decay and lepton number violation processes at colliders and in cosmology, with the latter ones having



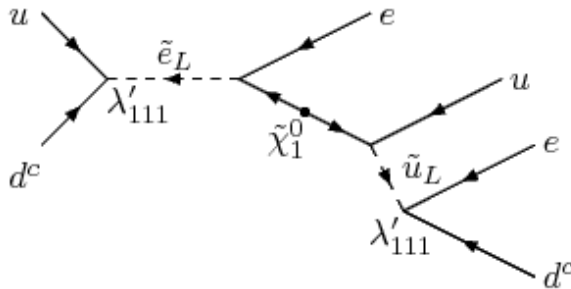

**Figure 9.** Neutrinoless double beta decay at the LHC: the case for  $R$ -parity violation. Two quarks in the initial state are converted into a same-sign di-lepton signal and two jets (from [101]).

important consequences for baryogenesis. As mentioned already in the last Section, while  $0\nu\beta\beta$  decay provides the best possibility to search for light massive Majorana neutrinos, lepton number violation as featured in the short-range contributions can in general be probed also in collider processes. For example, as discussed for left-right symmetric models [82,100] (see Fig. 7) and  $R$ -parity violating supersymmetry [89,101], the short-range contribution can easily be crossed into a diagram with two quarks in the initial state where resonant production of a heavy particle leads to a same-sign dilepton signature plus two jets at the LHC, see Fig. 9. If one wants to discuss the LHC bounds in a model-independent way it is necessary to specify which particles are propagating in the inner legs, which requires a decomposition of the  $d = 9$  operator in the effective mass approach discussed above. Such a decomposition has been worked out in [102] where two different possible topologies have been identified. While topology 1 contains two bosons and a fermion in the internal lines (like the right-handed analogue of the standard diagram), topology 2 contains an internal 3-boson-vertex (like the triplet exchange diagram). This decomposition was applied to the LHC analogue of  $0\nu\beta\beta$  decay and first results for topology 1 have been worked out in [74,75]. The conclusion reached was that with the exception of leptoquark exchange, the LHC was typically more sensitive than  $0\nu\beta\beta$  decay on the short-range operators. Thus one could infer that typically and with some exceptions either an observation of  $0\nu\beta\beta$  decay would imply an LHC signal of LNV as well (in turn, no sign of LNV at the LHC would exclude an observation of  $0\nu\beta\beta$  decay), or  $0\nu\beta\beta$  decay would be triggered by a long-range mechanism.

In addition, as has been mentioned before, lepton number violation and baryon number violation are closely interrelated. More concretely, an observation of lepton number violation at low energies has important consequences for a pre-existing lepton asymmetry in the Universe as the observation of LNV at the LHC will yield a lower bound on the washout factor for the lepton asymmetry in the early Universe. In [103] it has thus been pointed out that any observation of lepton number violation at the LHC will falsify high-scale leptogenesis. It is easy to see that this argument can be extended even further (for further details see [104,105]).

Just like the combination of  $B - L$  violating heavy neutrino decays in leptogenesis with  $B + L$  violating sphaleron processes can generate a baryon asymmetry, low energy  $B - L$  violation observed at the LHC or elsewhere in combination with  $B + L$  violating sphaleron processes will wash out any pre-existing baryon asymmetry, whatever of the concrete mechanism of baryogenesis is.

By combining this argument with the results of [74, 75] discussed above, one can conclude that an observation of short-range  $0\nu\beta\beta$  decay will typically imply that LNV processes should be detected at the LHC as well, and this in turn will falsify standard thermal leptogenesis and in general any high-scale scenario of baryogenesis. While the observation that low-energy LNV is dangerous for baryogenesis is not new (see e.g. [106–110]), only quite recently it has been realized in [105] that the argument applies for all short range contributions d) and also for the long-range contribution b) in Fig. 5.

It should be stressed of course that these arguments are rather general and various loopholes exist in specific models:

- Scenarios where LNV exists only for (a) specific flavor(s). As  $0\nu\beta\beta$  decay probes  $\Delta L_e = 2$  LNV, only, it may be possible that lepton number could still be conserved in the  $\tau$  flavor which is not necessarily in equilibrium with the  $e$  and  $\mu$  flavors in the early Universe [103]. It has been discussed in [105], however, that an observation of lepton flavor violating (LFV) decays such as  $\tau \rightarrow \mu\gamma$  may require LFV couplings large enough to wash out such a flavor specific lepton asymmetry when combined with LNV observed in a different flavor sector;
- Models with hidden sectors, new symmetries and/or conserved charges may protect a baryon asymmetry against LNV washout as proposed for the example of hypercharge by [111];
- Models where lepton number is broken at a scale below the electroweak phase transition where sphalerons are no longer active.

As in general an observation of low energy LNV would invalidate any high-scale generation of the baryon asymmetry though, such protection mechanisms should be addressed explicitly in any model combining low-scale LNV with high-scale baryogenesis.

By building up on the arguments given above, one can conclude, keeping the above mentioned loopholes in mind, that if  $0\nu\beta\beta$  decay is observed, it is either triggered by a long-range mechanism, such as the standard interpretation with a light Majorana neutrino mass, or due to a short-range mechanism. In this latter case it is very probable that lepton number is observed at the LHC. This further implies that baryogenesis is a low-scale phenomenon which also may be observable at the LHC or other experiments.

If, on the other hand, the baryon asymmetry is generated at a high scale, LNV will not be observable at the LHC. If, in this case,  $0\nu\beta\beta$  decay will be found, it will typically be triggered by a long-range mechanism. In combination with the assumption that we do not have a hint for lepton number violation at a low-scale and that on the other hand a high scale mechanism is responsible for the generation of the baryon asymmetry, this

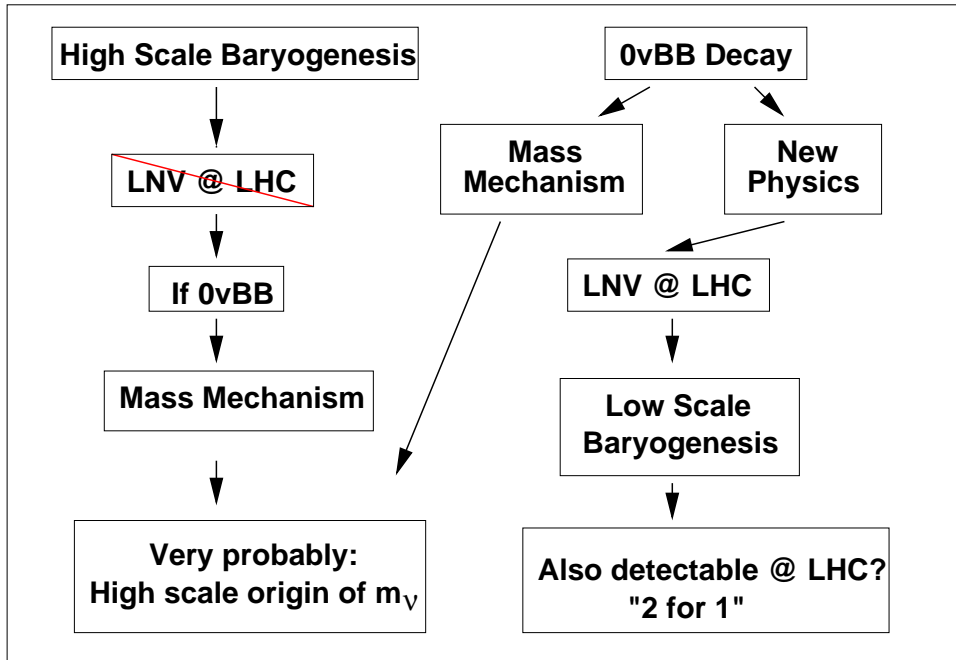

**Figure 10.** The relation of  $0\nu\beta\beta$  decay, LNV at the LHC and baryogenesis depicted as a logic tree. For details, see text (from [104]).

case will probably point towards a high-scale origin of the neutrino mass as well, such as a type-I seesaw mechanism in combination with leptogenesis.

To summarize this discussion, an observation of  $0\nu\beta\beta$  decay will (see Fig. 10) either imply LNV at the LHC and low-scale baryogenesis and thus a possible observation of both processes in the near future, or very probably point towards a high-scale origin of both neutrino masses and baryogenesis.

## 5. Conclusions

The discovery of lepton number violation would have far-reaching consequences affecting deeply our thinking about fundamental physics, including our ideas about unification and our understanding of the generation of the baryon asymmetry of the Universe. Neutrinoless double beta decay and lepton number violation thus remain fields that enjoy large interest from both experimental and theoretical communities in nuclear and particle physics. In this review we have tried to summarize the multifaceted relations between neutrinoless double beta decay, neutrino physics and new physics beyond the Standard Model. The continuous theoretical and experimental efforts around the world justify the hope that we may not be too far away from identifying the origin of lepton number violation.

## Acknowledgments

WR was supported by the Max Planck Society in the project MANITOP.

## References

- [1] H. V. Klapdor-Kleingrothaus, A. Dietz, L. Baudis, G. Heusser, I. V. Krivosheina, S. Kolb, B. Majorovits and H. Päs *et al.*, Eur. Phys. J. A **12** (2001) 147 [hep-ph/0103062].
- [2] M. Auger *et al.* [EXO Collaboration], Phys. Rev. Lett. **109** (2012) 032505 [arXiv:1205.5608 [hep-ex]].
- [3] A. Gando *et al.* [KamLAND-Zen Collaboration], Phys. Rev. Lett. **110** (2013) 6, 062502 [arXiv:1211.3863 [hep-ex]].
- [4] M. Agostini *et al.* [GERDA Collaboration], Phys. Rev. Lett. **111** (2013) 12, 122503 [arXiv:1307.4720 [nucl-ex]].
- [5] J. B. Albert *et al.* [EXO-200 Collaboration], Nature **510** (2014) 229234 [arXiv:1402.6956 [nucl-ex]].
- [6] W. Rodejohann, Int. J. Mod. Phys. E **20** (2011) 1833 [arXiv:1106.1334 [hep-ph]].
- [7] J. J. Gomez-Cadenas, J. Martin-Albo, M. Mezzetto, F. Monrabal and M. Sorel, Riv. Nuovo Cim. **35** (2012) 29 [arXiv:1109.5515 [hep-ex]].
- [8] S. R. Elliott, Mod. Phys. Lett. A **27** (2012) 1230009 [arXiv:1203.1070 [nucl-ex]].
- [9] S. M. Bilenky and C. Giunti, Mod. Phys. Lett. A **27** (2012) 1230015 [arXiv:1203.5250 [hep-ph]]; arXiv:1411.4791 [hep-ph].
- [10] J. D. Vergados, H. Ejiri and F. Simkovic, Rept. Prog. Phys. **75** (2012) 106301 [arXiv:1205.0649 [hep-ph]].
- [11] W. Rodejohann, J. Phys. G **39** (2012) 124008 [arXiv:1206.2560 [hep-ph]].
- [12] F. F. Deppisch, M. Hirsch and H. Päs, J. Phys. G **39** (2012) 124007 [arXiv:1208.0727 [hep-ph]].
- [13] P. Vogel, J. Phys. G **39** (2012) 124002 [arXiv:1208.1992 [nucl-th]].
- [14] B. Schwingenheuer, Annalen Phys. **525** (2013) 269 [arXiv:1210.7432 [hep-ex]].
- [15] S. T. Petcov, Adv. High Energy Phys. **2013** (2013) 852987 [arXiv:1303.5819 [hep-ph]].
- [16] O. Cremonesi and M. Pavan, arXiv:1310.4692 [physics.ins-det].
- [17] W. C. Haxton and G. J. Stephenson, Prog. Part. Nucl. Phys. **12** (1984) 409.
- [18] M. Doi, T. Kotani and E. Takasugi, Prog. Theor. Phys. Suppl. **83** (1985) 1.
- [19] J. D. Vergados, Phys. Rept. **361** (2002) 1 [hep-ph/0209347].
- [20] F. T. Avignone, III, S. R. Elliott and J. Engel, Rev. Mod. Phys. **80** (2008) 481 [arXiv:0708.1033 [nucl-ex]].
- [21] F. Simkovic, A. Faessler, V. Rodin, P. Vogel and J. Engel, Phys. Rev. C **77** (2008) 045503 [arXiv:0710.2055 [nucl-th]].
- [22] J. Heeck and W. Rodejohann, Europhys. Lett. **103** (2013) 32001 [arXiv:1306.0580 [hep-ph]].
- [23] A. Osipowicz *et al.* [KATRIN Collaboration], hep-ex/0109033.
- [24] B. Monreal and J. A. Formaggio, Phys. Rev. D **80** (2009) 051301 [arXiv:0904.2860 [nucl-ex]].
- [25] K. Blaum, A. Doerr, C. E. Duellmann, K. Eberhardt, S. Eliseev, C. Enss, A. Faessler and A. Fleischmann *et al.*, arXiv:1306.2655 [physics.ins-det].
- [26] A. Monfardini, C. Arnaboldi, C. Brofferio, S. Capelli, F. Capozzi, O. Cremonesi, C. Enss and E. Fiorini *et al.*, Nucl. Instrum. Meth. A **559** (2006) 346 [hep-ex/0509038].
- [27] J. Lesgourgues and S. Pastor, New J. Phys. **16** (2014) 065002 [arXiv:1404.1740 [hep-ph]].
- [28] E. Akhmedov, arXiv:1412.3320 [hep-ph].
- [29] D. V. Forero, M. Tortola and J. W. F. Valle, Phys. Rev. D **90** (2014) 9, 093006 [arXiv:1405.7540 [hep-ph]].
- [30] F. Capozzi, G. L. Fogli, E. Lisi, A. Marrone, D. Montanino and A. Palazzo, Phys. Rev. D **89** (2014) 9, 093018 [arXiv:1312.2878 [hep-ph]].
- [31] M. C. Gonzalez-Garcia, M. Maltoni and T. Schwetz, JHEP **1411** (2014) 052 [arXiv:1409.5439 [hep-ph]].
- [32] G. L. Fogli, E. Lisi, A. Marrone, A. Melchiorri, A. Palazzo, P. Serra and J. Silk, Phys. Rev. D **70** (2004) 113003 [hep-ph/0408045].
- [33] F. Feruglio, A. Strumia and F. Vissani, Nucl. Phys. B **637** (2002) 345 [Nucl. Phys. B **659** (2003) 359] [hep-ph/0201291].

- [34] S. Dell’Oro, S. Marcocci, M. Viel and F. Vissani, arXiv:1505.02722 [hep-ph].
- [35] S. Pascoli and S. T. Petcov, Phys. Lett. B **544** (2002) 239 [hep-ph/0205022].
- [36] A. Dueck, W. Rodejohann and K. Zuber, Phys. Rev. D **83** (2011) 113010 [arXiv:1103.4152 [hep-ph]].
- [37] C. E. Aalseth *et al.* [IGEX Collaboration], Phys. Rev. D **65** (2002) 092007 [hep-ex/0202026].
- [38] J. Kotila and F. Iachello, Phys. Rev. C **85** (2012) 034316 [arXiv:1209.5722 [nucl-th]].
- [39] M. Mirea, T. Pahomi and S. Stoica, arXiv:1411.5506 [nucl-th].
- [40] P. S. Bhupal Dev, S. Goswami, M. Mitra and W. Rodejohann, Phys. Rev. D **88** (2013) 091301 [arXiv:1305.0056 [hep-ph]].
- [41] P. Guzowski, L. Barnes, J. Evans, G. Karagiorgi, N. McCabe and S. Soldner-Rembold, arXiv:1504.03600 [hep-ex].
- [42] T. R. Rodriguez and G. Martinez-Pinedo, Phys. Rev. Lett. **105** (2010) 252503.
- [43] J. Menendez, A. Poves, E. Caurier and F. Nowacki, Nucl. Phys. A **818** (2009) 139.
- [44] J. Barea, J. Kotila and F. Iachello, Phys. Rev. C **87** (2013) 014315.
- [45] J. Suhonen and O. Civitarese, Nucl. Phys. A **847** (2010) 207.
- [46] A. Meroni, S. T. Petcov and F. Simkovic, JHEP **1302** (2013) 025.
- [47] F. Simkovic, V. Rodin, A. Faessler and P. Vogel, Phys. Rev. C **87** (2013) 045501.
- [48] M. T. Mustonen and J. Engel, Phys. Rev. C **87** (2013) 6, 064302 [arXiv:1301.6997 [nucl-th]].
- [49] G. Altarelli and F. Feruglio, Rev. Mod. Phys. **82** (2010) 2701 [arXiv:1002.0211 [hep-ph]].
- [50] H. Ishimori, T. Kobayashi, H. Ohki, Y. Shimizu, H. Okada and M. Tanimoto, Prog. Theor. Phys. Suppl. **183** (2010) 1 [arXiv:1003.3552 [hep-th]].
- [51] J. Barry and W. Rodejohann, Nucl. Phys. B **842** (2011) 33 [arXiv:1007.5217 [hep-ph]].
- [52] L. Dorame, D. Meloni, S. Morisi, E. Peinado and J. W. F. Valle, Nucl. Phys. B **861** (2012) 259 [arXiv:1111.5614 [hep-ph]].
- [53] L. Dorame, S. Morisi, E. Peinado, J. W. F. Valle and A. D. Rojas, Phys. Rev. D **86** (2012) 056001 [arXiv:1203.0155 [hep-ph]].
- [54] S. F. King, A. Merle and A. J. Stuart, JHEP **1312** (2013) 005 [arXiv:1307.2901 [hep-ph]].
- [55] A. Dueck and W. Rodejohann, JHEP **1309** (2013) 024 [arXiv:1306.4468 [hep-ph]].
- [56] K. N. Abazajian, M. A. Acero, S. K. Agarwalla, A. A. Aguilar-Arevalo, C. H. Albright, S. Antusch, C. A. Argüelles and A. B. Balantekin *et al.*, arXiv:1204.5379 [hep-ph].
- [57] J. Barry, W. Rodejohann and H. Zhang, JHEP **1107** (2011) 091 [arXiv:1105.3911 [hep-ph]].
- [58] C. Giunti, M. Laveder, Y. F. Li, Q. Y. Liu and H. W. Long, Phys. Rev. D **86** (2012) 113014 [arXiv:1210.5715 [hep-ph]].
- [59] I. Girardi, A. Meroni and S. T. Petcov, JHEP **1311** (2013) 146 [arXiv:1308.5802 [hep-ph]].
- [60] C. Giunti and E. M. Zavanin, arXiv:1505.00978 [hep-ph].
- [61] J. Schechter and J. W. F. Valle, Phys. Rev. D **25** (1982) 2951.
- [62] J. F. Nieves, Phys. Lett. B **147** (1984) 375.
- [63] E. Takasugi, Phys. Lett. B **149** (1984) 372.
- [64] M. Hirsch, H. V. Klapdor-Kleingrothaus and S. G. Kovalenko, Nucl. Phys. Proc. Suppl. **62** (1998) 224.
- [65] M. Hirsch, S. Kovalenko and I. Schmidt, Phys. Lett. B **642** (2006) 106 [hep-ph/0608207].
- [66] M. Duerr, M. Lindner and A. Merle, JHEP **1106** (2011) 091 [arXiv:1105.0901 [hep-ph]].
- [67] J. C. Helo, M. Hirsch, T. Ota and F. A. P. d. Santos, JHEP **1505** (2015) 092 [arXiv:1502.05188 [hep-ph]].
- [68] H. Päs, M. Hirsch, H. V. Klapdor-Kleingrothaus and S. G. Kovalenko, Phys. Lett. B **453** (1999) 194.
- [69] H. Päs, M. Hirsch, H. V. Klapdor-Kleingrothaus and S. G. Kovalenko, Phys. Lett. B **498** (2001) 35 [hep-ph/0008182].
- [70] F. Deppisch and H. Päs, Phys. Rev. Lett. **98** (2007) 232501 [hep-ph/0612165].
- [71] V. M. Gehman and S. R. Elliott, J. Phys. G **34**, 667 (2007) [Erratum-ibid. G **35**, 029701 (2008)].
- [72] A. Faessler, A. Meroni, S. T. Petcov, F. Simkovic and J. Vergados, Phys. Rev. D **83** (2011) 113003

- [arXiv:1103.2434 [hep-ph]].
- [73] R. Arnold *et al.* [SuperNEMO Collaboration], *Eur. Phys. J. C* **70** (2010) 927.
- [74] J. C. Helo, M. Hirsch, S. G. Kovalenko and H. Päs, *Phys. Rev. D* **88** (2013) 1, 011901 [arXiv:1303.0899 [hep-ph]].
- [75] J. C. Helo, M. Hirsch, H. Päs and S. G. Kovalenko, *Phys. Rev. D* **88** (2013) 073011 [arXiv:1307.4849 [hep-ph]].
- [76] K. Muto, E. Bender and H. Klapdor, *Z.Phys.* **A334**, 187 (1989).
- [77] M. Hirsch, H. Klapdor-Kleingrothaus and O. Panella, *Phys.Lett.* **B374**, 7 (1996), [hep-ph/9602306].
- [78] J. Barry and W. Rodejohann, *JHEP* **1309** (2013) 153 [arXiv:1303.6324 [hep-ph]].
- [79] P. S. B. Dev, S. Goswami and M. Mitra, *Phys. Rev. D* **91** (2015) 11, 113004 [arXiv:1405.1399 [hep-ph]].
- [80] A. Ibarra, E. Molinaro and S. T. Petcov, *JHEP* **1009** (2010) 108 [arXiv:1007.2378 [hep-ph]].
- [81] M. Mitra, G. Senjanovic and F. Vissani, *Nucl. Phys. B* **856** (2012) 26 [arXiv:1108.0004 [hep-ph]].
- [82] V. Tello, M. Nemevsek, F. Nesti, G. Senjanovic and F. Vissani, *Phys. Rev. Lett.* **106** (2011) 151801 [arXiv:1011.3522 [hep-ph]].
- [83] R. N. Mohapatra, *Phys. Rev. D* **34** (1986) 3457.
- [84] M. Hirsch, H. Klapdor-Kleingrothaus and S. Kovalenko, *Phys.Rev.Lett.* **75**, 17 (1995).
- [85] M. Hirsch, H. Klapdor-Kleingrothaus and S. Kovalenko, *Phys.Rev.* **D53**, 1329 (1996), [hep-ph/9502385].
- [86] M. Hirsch, H. Klapdor-Kleingrothaus and S. Kovalenko, *Phys.Lett.* **B372**, 181 (1996), [hep-ph/9512237].
- [87] H. Päs, M. Hirsch and H. Klapdor-Kleingrothaus, *Phys.Lett.* **B459**, 450 (1999), [hep-ph/9810382].
- [88] K. Babu and R. Mohapatra, *Phys.Rev.Lett.* **75**, 2276 (1995), [hep-ph/9506354].
- [89] B. C. Allanach, C. H. Kom and H. Päs, *JHEP* **0910** (2009) 026 [arXiv:0903.0347 [hep-ph]].
- [90] G. Hiller and M. Schmaltz, *Phys. Rev. D* **90** (2014) 054014 [arXiv:1408.1627 [hep-ph]].
- [91] S. Biswas, D. Chowdhury, S. Han and S. J. Lee, *JHEP* **1502** (2015) 142 [arXiv:1409.0882 [hep-ph]].
- [92] W. Buchmüller, R. Rückl and D. Wyler, *Phys.Lett.* **B191**, 442 (1987).
- [93] S. Davidson, D. C. Bailey and B. A. Campbell, *Z.Phys.* **C61**, 613 (1994), [hep-ph/9309310].
- [94] Particle Data Group, K. Nakamura *et al.*, *J.Phys.G* **G37**, 075021 (2010).
- [95] M. Hirsch, H. Klapdor-Kleingrothaus and S. Kovalenko, *Phys.Lett.* **B378**, 17 (1996), [hep-ph/9602305].
- [96] M. Hirsch, H. Klapdor-Kleingrothaus and S. Kovalenko, *Phys.Rev.* **D54**, 4207 (1996), [hep-ph/9603213].
- [97] K. R. Dienes, E. Dudas and T. Gherghetta, *Nucl. Phys. B* **557** (1999) 25 [hep-ph/9811428].
- [98] N. Arkani-Hamed, S. Dimopoulos, G. R. Dvali and J. March-Russell, *Phys. Rev. D* **65** (2002) 024032 [hep-ph/9811448].
- [99] G. Bhattacharyya, H. Klapdor-Kleingrothaus, H. Päs and A. Pilaftsis, *Phys.Rev.* **D67**, 113001 (2003), [hep-ph/0212169].
- [100] W. Y. Keung and G. Senjanovic, *Phys. Rev. Lett.* **50** (1983) 1427.
- [101] B. C. Allanach, C. H. Kom and H. Päs, *Phys. Rev. Lett.* **103** (2009) 091801 [arXiv:0902.4697 [hep-ph]].
- [102] F. Bonnet, M. Hirsch, T. Ota and W. Winter, *JHEP* **1303** (2013) 055 [JHEP **1404** (2014) 090] [arXiv:1212.3045 [hep-ph]].
- [103] F. F. Deppisch, J. Harz and M. Hirsch, *Phys. Rev. Lett.* **112** (2014) 221601 [arXiv:1312.4447 [hep-ph]].
- [104] J. Harz, W. C. Huang and H. Päs, arXiv:1505.07632 [hep-ph].
- [105] F. F. Deppisch, J. Harz, M. Hirsch, W. C. Huang and H. Päs, arXiv:1503.04825 [hep-ph].
- [106] M. Fukugita and T. Yanagida, *Phys. Rev. D* **42** (1990) 1285.
- [107] G. Gelmini and T. Yanagida, *Phys. Lett. B* **294**, 53 (1992).
- [108] H. V. Klapdor-Kleingrothaus, S. Kolb and V. A. Kuzmin, *Phys. Rev. D* **62** (2000) 035014

- [hep-ph/9909546].
- [109] J. M. Frere, T. Hambye and G. Vertongen, JHEP **0901** (2009) 051 [arXiv:0806.0841 [hep-ph]].
- [110] S. Hollenberg, H. Päs and D. Schalla, arXiv:1110.0948 [hep-ph].
- [111] A. Antaramian, L. J. Hall and A. Rasin, Phys. Rev. D **49** (1994) 3881 [hep-ph/9311279].