

Dynamics and Control of a Spherical Robot with an Axisymmetric Pendulum Actuator

Tatyana B. Ivanova*, Elena N. Pivovarova†

Udmurt State University

ul. Universitetskaya 1, Izhevsk, 426034 Russia

Abstract

This paper investigates the possibility of the motion control of a ball with a pendulum mechanism with non-holonomic constraints using gaits — the simplest motions such as acceleration and deceleration during the motion in a straight line, rotation through a given angle and their combination. Also, the controlled motion of the system along a straight line with a constant acceleration is considered. For this problem the algorithm for calculating the control torques is given and it is shown that the resulting reduced system has the first integral of motion.

Introduction

For the last ten years an enormous amount of research has been devoted to the dynamics and control of such vehicles as single wheel robot and spherical robot moving due to changes in the position of the center of mass (see, for example, [1, 6, 7, 10, 11, 12, 13, 14]). Also, the possibility of controlling such systems by using other internal mechanisms, for example, rotors [3, 4], is actively studied. The interest in such systems is determined by the presence of some advantages in maneuverability over wheeled vehicles. For a detailed literature review on spherical robots with various moving mechanisms, their description and application areas see [9, 13, 14].

The motion of spherical robots moving due to pendulum oscillations is studied in [5, 1, 7, 8, 11, 12, 13, 14]. In particular, Nagai [13] considers the control of the motion of a pendulum spherical robot on an inclined plane and finds the maximum inclination angle of the plane at which the vehicle can move up the plane (a similar problem is considered in [7] for a single wheel robot). Schroll [14] addresses the problem of obstacle negotiation and finds the maximum height of the obstacle which

*tbesp@rcd.ru

†archive@rcd.ru

such a robot can overcome. In [11] Kayacan et al. consider the control of the motion of a ball in a straight line and a circle for various types of controllers.

In [1] the authors consider the problems of controlling a spherical robot with a pendulum drive in the case of slipping at the contact point and in the non-holonomic case. The focus is on determining an algorithm for an additional control to approach the given trajectory from an arbitrary point in the case of a singular matrix defining the control. However, this investigation [1] leads to a physically strange conclusion that introduction of a small parameter can lead to the controllability of this system, whereas vanishing of this parameter corresponds to the absence of controllability, which casts some doubts on the accuracy of the results obtained.

This work is a continuation of analysis of the dynamics of a spherical shell rolling without slipping on a horizontal plane with Lagrange's top fixed at the center of the shell [5, 8]. Previously in [5] the equations of motion for a free system were obtained (the equations of motion for the system situated inside the rolling ball were also obtained in [2]), all necessary first integrals and an invariant measure were found, the reduction to quadratures is given. In [8] the *free* motion of the ball with Lagrange's top was considered, the stability of periodic solutions was analyzed and the trajectories of the contact point were constructed.

This paper investigates the *controlled* motion of a ball with a pendulum. Special attention is paid to the control of the ball using gaits — the simplest motions (such as acceleration to a certain velocity and deceleration in a straight line and rotation through a given angle) and their combination for one oscillation of the pendulum and specific examples of such motions are shown. In the last part of the paper we consider the controlled motion of the ball along a straight line with fixed parameters according to a predetermined law of motion, indicate shortcomings of this approach and consider an algorithm for computing the control torques by example.

1 Equations of motion

We consider a spherical shell (Fig. 1) relative to a fixed reference frame (the axis Oz is directed vertically downwards). Let G_s be the center of mass of the shell, G_t the center of mass of the top and let $R_t = |G_s G_t|$ denote the distance between them. The vector \mathbf{n} is directed along the axis of symmetry of the pendulum (here and in the sequel, the vectors are denoted by bold italic letters).

Assuming that in the system of the tops principal axes its tensor of inertia is $\hat{\mathbf{i}} = \text{diag}(i, i, i + j)$, we can represent the kinetic energy of the system as [5, 8]:

$$T = \frac{1}{2} (M \mathbf{V}^2 + I \boldsymbol{\Omega}^2) + \frac{1}{2} (m \mathbf{v}^2 + i \boldsymbol{\omega}^2 + j (\boldsymbol{\omega}, \mathbf{n})^2),$$

where \mathbf{V} and $\boldsymbol{\Omega}$ are the linear velocity of the center of the shell and the shells angular velocity, M and I stand for its mass and moment of inertia, \mathbf{v} and $\boldsymbol{\omega}$ are

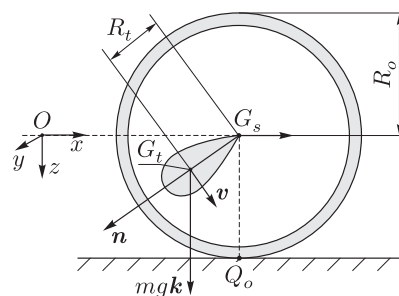

Figure 1: Spherical shell with an axisymmetric pendulum fixed at its center.

the linear velocity of the center of mass of the top and its angular velocity, and m is the mass of the top.

In this paper we will investigate the controlled motion of the system. The control torque can be generated by the engine which is installed at the point of attachment of the pendulum to the ball and sets the pendulum and, accordingly, the ball in motion. Let \mathbf{Q} be the torque generated by the engine.

Then the change of the angular momentum relative to G_s and the momentum of the shell can be written as

$$\begin{aligned}\frac{d}{dt} \frac{\partial T}{\partial \dot{\boldsymbol{\Omega}}} &= I \dot{\boldsymbol{\Omega}} = R_o \mathbf{k} \times \mathbf{N}_o - \mathbf{Q}, \\ \frac{d}{dt} \frac{\partial T}{\partial \dot{\mathbf{V}}} &= M \dot{\mathbf{V}} = \mathbf{N}_o + \mathbf{N}_t + Mg \mathbf{k},\end{aligned}\tag{1}$$

where \mathbf{N}_o and \mathbf{N}_t are the reaction forces acting on the shell at the contact point Q_o and the point of attachment of the top G_s . For the top relative to its center of mass we have

$$\begin{aligned}\frac{d}{dt} \frac{\partial T}{\partial \dot{\boldsymbol{\omega}}} &= i \dot{\boldsymbol{\omega}} + j(\boldsymbol{\omega}, \mathbf{n}) \dot{\mathbf{n}} = R_t \mathbf{n} \times \mathbf{N}_t + \mathbf{Q}, \\ \frac{d}{dt} \frac{\partial T}{\partial \dot{\mathbf{v}}} &= m \dot{\mathbf{v}} = mg \mathbf{k} - \mathbf{N}_t,\end{aligned}\tag{2}$$

The linear velocity of the center of mass of the top is determined by the relation

$$\mathbf{v} = \mathbf{V} + R_t \boldsymbol{\omega} \times \mathbf{n} = R_o \mathbf{k} \times \boldsymbol{\Omega} + R_t \boldsymbol{\omega} \times \mathbf{n}.$$

The linear velocity of the center of mass of the shell \mathbf{V} is related with the angular velocity of the shell $\boldsymbol{\Omega}$ by the no-slip condition at the contact point Q_o :

$$\mathbf{V} = \dot{\mathbf{r}}_s = R_o \mathbf{k} \times \boldsymbol{\Omega},\tag{3}$$

where \mathbf{r}_s is the radius vector of the contact point.

The evolution of the vector \mathbf{n} can be found from the equation

$$\dot{\mathbf{n}} = \boldsymbol{\omega} \times \mathbf{n}.$$

Eliminating the reaction forces \mathbf{N}_o and \mathbf{N}_t from Eqs. (1) and (2), we obtain the equations of controlled motion for the spherical shell with the axisymmetric top fixed at its geometrical center:

$$\begin{aligned}\mathbf{J} \dot{\boldsymbol{\Omega}} + m R_o^2 \mathbf{k} \times (\dot{\boldsymbol{\Omega}} \times \mathbf{k}) - m R_o R_t \mathbf{k} \times (\dot{\boldsymbol{\omega}} \times \mathbf{n}) &= m R_o R_t \mathbf{k} \times (\boldsymbol{\omega} \times \dot{\mathbf{n}}) - \mathbf{Q}, \\ i \dot{\boldsymbol{\omega}} + m R_t^2 \mathbf{n} \times (\dot{\boldsymbol{\omega}} \times \mathbf{n}) - m R_o R_t \mathbf{n} \times (\dot{\boldsymbol{\Omega}} \times \mathbf{k}) &= \\ &= -j(\boldsymbol{\omega}, \mathbf{n}) \dot{\mathbf{n}} - m R_t^2 \mathbf{n} \times (\boldsymbol{\omega} \times \dot{\mathbf{n}}) + mg R_t \mathbf{n} \times \mathbf{k} + \mathbf{Q}, \\ \dot{\mathbf{n}} &= \boldsymbol{\omega} \times \mathbf{n},\end{aligned}\tag{4}$$

where $\mathbf{J} = \text{diag}(I + MR_o^2, I + MR_o^2, I)$, $\mathbf{k} = (0, 0, 1)^T$.

Differentiating Eq. (3) with respect to time, we obtain the expression for $\dot{\boldsymbol{\Omega}}$:

$$\dot{\boldsymbol{\Omega}} = \frac{1}{R_o} \dot{\mathbf{V}} \times \mathbf{k} = \frac{1}{R_o} \mathbf{a} \times \mathbf{k}, \quad (5)$$

where \mathbf{a} is the acceleration of the contact point.

Our goal is to determine a control torque \mathbf{Q} such that the contact point (and thus the center of the ball) moves according to the specified law of motion $\mathbf{r}_s(t) = (x(t), y(t), 0)^T$. The velocity of the center of mass $\mathbf{V}(t) = (\dot{x}(t), \dot{y}(t), 0)^T$ and its acceleration $\mathbf{a}(t) = (\ddot{x}(t), \ddot{y}(t), 0)^T$ are prescribed functions as well.

By prescribing the law of motion of the contact point on a plane $\mathbf{r}_s(t)$ from (4) and (5), we obtain a system of nine equations for the projections of the vectors \mathbf{n} , $\boldsymbol{\omega}$, and \mathbf{Q} which can be represented as

$$\mathbf{F}\mathbf{y} = \mathbf{A}, \quad (6)$$

where $\mathbf{y} = (\dot{\boldsymbol{\omega}}, \dot{\mathbf{n}}, \mathbf{Q})^T$, \mathbf{F} is the matrix whose elements depend on $\boldsymbol{\omega}$ and \mathbf{n} ; \mathbf{A} is the vector function depending on $\boldsymbol{\omega}$, \mathbf{n} , and $\dot{\boldsymbol{\Omega}}$.

For the system (6) to have a solution, i.e., for a controlled motion to be possible, it is necessary that there exist the inverse matrix \mathbf{F}^{-1} , i.e., that the condition $\det \mathbf{F} \neq 0$ be satisfied, which requires the fulfilment of the condition (see also [1])

$$i + mR_t^2 > mR_oR_t. \quad (7)$$

The condition (7) can be satisfied by choosing the corresponding geometrical characteristics of the system. For definiteness we choose as the pendulum a thin disk suspended on a massless rod, whose parameters satisfy the condition (7): the radius of the disk is $R_d = 0.92R_o$ and the length of the rod is $R_t = 0.25R_o$. Note that this system is similar to a vehicle rolling without friction on the inner surface of a spherical shell.

Thus, to determine the control torque $\mathbf{Q}(t)$, it is necessary to solve the system (6) of differential equations with the corresponding initial conditions. However, by prescribing only the law of motion $\mathbf{r}_s(t)$, the system cannot start a new maneuver, for example, for changing the motion direction when bypassing an obstacle. In addition, it is necessary that the ball stop at the end point of a trajectory, and this requires that the pendulum be in the lower position and the velocity and acceleration be equal to zero at the final instant of time. As a rule, it is very difficult to satisfy such conditions beforehand, since this substantially complicates the determination of the function $\mathbf{r}_s(t)$ for the entire trajectory of motion.

Another approach to the control in maneuvering along a general trajectory is to use gaits. This approach implies that each motion must be performed *for one oscillation of the pendulum*, which is the necessary condition for a new motion to start. By combining such motions we can get any complex trajectory (which is useful, for example, for bypassing an obstacle).

In this paper we will consider both approaches — the control using gaits (Section 2) and the motion control with fixed parameters (such as acceleration, Section 3).

For ease of use, we will write all the equations of motion in dimensionless form. For this we take the mass of the pendulum m as the unit of mass, the quantity $t_0 = \sqrt{\frac{i+j}{mgR_t}}$ as the unit of time and the quantity $x_0 = gt_0^2$ as the unit of length,

where g is the free-fall acceleration, i.e., in the equations of motion we make the changes

$$\frac{t}{t_0} \rightarrow t, \quad \frac{x}{x_0} \rightarrow x, \quad \frac{M}{m} \rightarrow M, \quad \Omega t_0 \rightarrow \Omega, \quad \omega t_0 \rightarrow \omega, \quad \frac{Q t_0^2}{m x_0^2} \rightarrow Q.$$

Also, to abbreviate some of our forthcoming formulae, we introduce the following notation:

$$i_0 = i + R_t^2, \quad I_0 = I + (1 + M)R_o^2.$$

2 The control using gaits and their connection

We represent the vector \mathbf{n} directed along the axis of symmetry of the pendulum as

$$\mathbf{n} = (\sin \theta \cos \varphi, \sin \theta \sin \varphi, \cos \theta)^T,$$

where θ is the angle of deviation of the pendulum from the vertical and φ is the angle between the axis Ox and the direction of oscillation of the pendulum (Fig. 2).

To determine $\mathbf{Q}(t)$, we will specify the angle of deviation of the pendulum from the vertical θ such that at the start and the end of a maneuver the pendulum is in the lower position:

$$\theta(t, \alpha, T) = \alpha \sin^2 \left(\frac{\pi t}{T} \right), \quad \theta(\alpha, T)|_{t=0} = \theta(\alpha, T)|_{t=T} = 0. \quad (8)$$

where α is an as yet unknown parameter defining the amplitude of oscillation, T is the specified time of one oscillation of the pendulum which is equal to the time of one maneuver.

To determine the parameter α corresponding to the specified change of velocity, it is necessary to express from the system (4) using (5) and (8) the acceleration $a(t, \alpha, T)$ on which the additional condition is imposed

$$\Delta V(\alpha, T) = \int_0^T a(t, \alpha, T) dt. \quad (9)$$

Integrating (9) for different values of the parameter α and the period of oscillations T , we obtain the dependence $\Delta V(\alpha, T)$ (quadric surface), from which we find the parameter α by choosing the required velocity and the duration of the maneuver T .

Then, knowing the value α , we can explicitly determine the acceleration $a(t, \alpha, T)$ and express the control torques from equations (4).

We will consider the described algorithm in the specific cases: acceleration of the ball to a given velocity in a straight line and rotation for one oscillation of the pendulum.

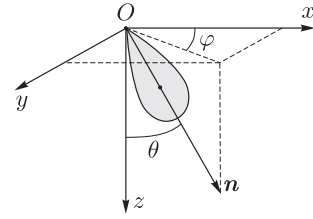

Figure 2: Determination of the angles θ and φ .

2.1 Acceleration in a straight line

We direct the axis Ox along the direction of motion. It is obvious that during the motion in a straight line the pendulum will oscillate in one plane, in this case in the plane Oxz , therefore, the vector \mathbf{n} directed along the axis of symmetry of the pendulum can be written as

$$\mathbf{n} = (\sin \theta, 0, \cos \theta)^T,$$

where θ is the angle of deviation of the pendulum from the vertical specified by the expression (8).

Only three of nine equations of motion (4) are nontrivial:

$$\begin{aligned} I_0 \dot{\Omega}_2 - R_o R_t (\dot{\omega}_2 \cos \theta - \omega_2^2 \sin \theta) + Q_2 &= 0, \\ i_0 \dot{\omega}_2 - R_o R_t \dot{\Omega}_2 \cos \theta + R_t \sin \theta - Q_2 &= 0, \\ \dot{\theta} &= \omega_2. \end{aligned} \quad (10)$$

The value of $\dot{\Omega}_2$ is determined from (5):

$$\dot{\Omega}_2 = -\frac{a(t)}{R_o}, \quad \dot{\Omega}_1 = \dot{\Omega}_3 = 0 \quad (11)$$

Substituting (11) into (10), we obtain the expression for acceleration of the ball in the form

$$a(t, \alpha, T) = R_o \frac{\ddot{\theta} (R_o R_t \cos \theta - i_0) + R_o R_t \dot{\theta}^2 \sin \theta - R_t \sin \theta}{I_0 - R_o R_t \cos \theta}, \quad (12)$$

where θ , $\dot{\theta}$ and $\ddot{\theta}$ are explicit functions of time and the parameters α and T defined from (8).

Numerically integrating (9) using (12), we obtain the surface illustrated in Fig. 3(a). This surface $\Delta V(\alpha, T)$ is antisymmetric relative to the change $\alpha \rightarrow -\alpha$ (this can be easily shown by substituting the function $\theta(t, \alpha_1, T)$ into (12) in the explicit form (8)).

In addition, $\Delta V_{\max} \rightarrow \infty$ as $T \rightarrow 0$, i.e., the quicker the oscillation of the pendulum occurs, the more the velocity increases.

Figure 3(b) shows sections of the surface for different values of T . From these graphs we can see that at least two values of α correspond to given ΔV and T :

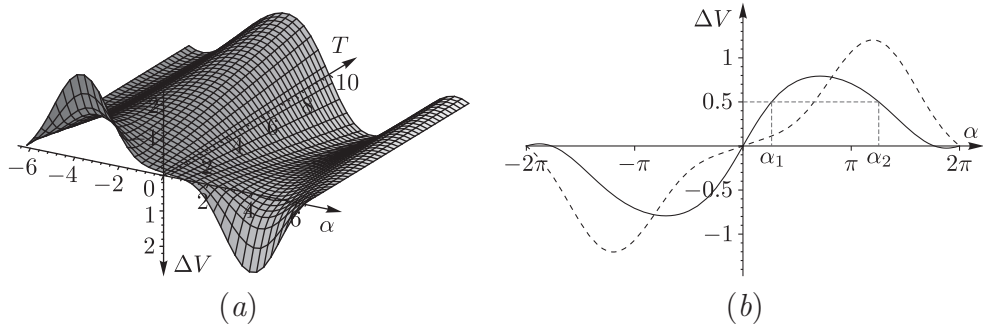

Figure 3: (a) The surface $\Delta V(\alpha, T)$. (b) Section formed by the intersection of the surface $\Delta V(\alpha, T)$ with the planes $T = 5$ (solid line) and $T = 1$ (dashed line).

at $\alpha = \alpha_1$ the pendulum performs an oscillation by a smaller angle than at $\alpha = \alpha_2$ (because of this the velocity varies non-monotonically at $\alpha = \alpha_2$).

Choosing the specific value of α , for example α_1 , substituting (12) into the equations of motion (10) and numerically integrating them, we obtain the control torques in the form

$$Q_1 = Q_3 = 0,$$

$$Q_2 = \frac{a(t, \alpha, T)}{R_o} I_0 + R_o R_t (\cos \theta \ddot{\theta} - \sin \theta \dot{\theta}^2).$$

Thus, for acceleration in a straight line it is necessary to generate a control torque which is orthogonal to the direction of motion and to the plane of oscillations of the pendulum.

EXAMPLE 1. We consider the acceleration of the ball from rest to the velocity $V_1 = 0.5$ for the time interval $T = 5$. The value of the parameter $\alpha = 0.83$ corresponds to such a motion (see Fig. 3(b)). Since the ball moves from rest and the pendulum is in the lower position, the initial conditions have the form

$$\mathbf{n} = (0, 0, 1)^T, \quad \boldsymbol{\omega} = (0, 0, 0)^T, \quad \mathbf{r} = (0, 0, 0)^T, \quad \mathbf{V} = (0, 0, 0)^T.$$

Substituting the computed value α into the equations of motion (10) and numerically integrating them (with the specified initial conditions), we obtain the corresponding control $\mathbf{Q} = (0, Q_2, 0)^T$ for such acceleration (Fig. 4).

Figure 4 also shows the time-dependence of non-zero components of the vector \mathbf{n} , velocity \mathbf{V} and acceleration $a(t)$ of the ball and angular velocity of the pendulum $\boldsymbol{\omega}$. As seen in the figure, the ball has gained the speed $\Delta V = 0.5$ for the time interval $T = 5$ moving further with constant velocity. The pendulum has executed one full oscillation and returned to the initial condition.

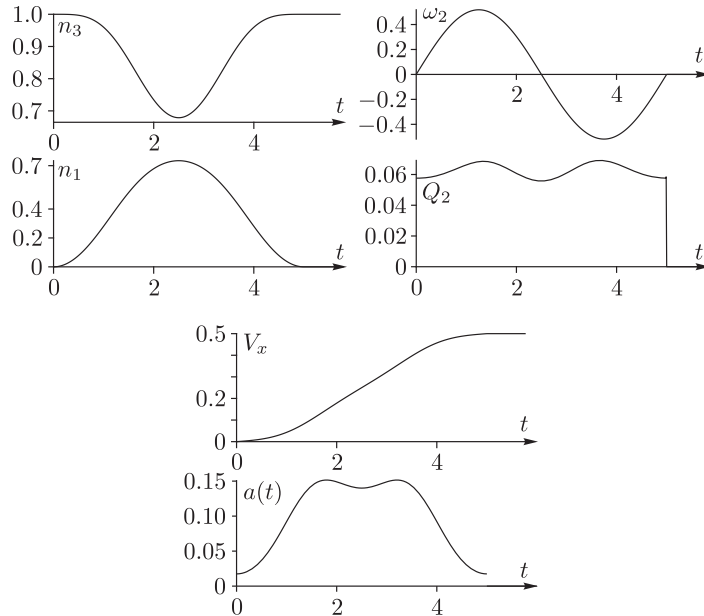

Figure 4: Time dependence of the vectors \mathbf{n} , $\boldsymbol{\omega}$, \mathbf{Q} , as well as the velocity and acceleration of the ball by acceleration for one oscillation of the pendulum.

To stop the ball, it is necessary to cause the pendulum to perform an oscillation in the opposite direction with the same amplitude and for the same time interval (i.e. $\alpha = -0.83$ and $T = 5$). At the end of the maneuver the pendulum is in the lower vertical position as during acceleration.

2.2 Motion with change of the direction

For simplicity we assume that at the initial instant of time the ball moves along the axis Ox with some constant velocity V_s . We consider a motion where the pendulum executes one oscillation in an arbitrarily predetermined direction (at an angle φ to the direction of motion, see Fig. 2). The ball deviates from the initial trajectory by some angle ψ (see Fig. 5). The vector \mathbf{n} directed along the symmetry axis of the pendulum can be written as

$$\mathbf{n} = (\sin \theta \cos \varphi, \sin \theta \sin \varphi, \cos \theta)^T,$$

where θ is the angle of deviation of the pendulum from the vertical, φ is the angle between the initial direction of motion and the direction of oscillation of the pendulum.

The equations of motion (4) in projections onto the axes of the fixed coordinate system can be written as

$$\begin{aligned} \dot{\Omega}_1 I_0 - R_o R_t (\dot{\omega}_1 \cos \theta - \omega_1 \sin \theta \dot{\theta}) + Q_1 &= 0, \\ \dot{\Omega}_2 I_0 - R_o R_t (\dot{\omega}_2 \cos \theta - \omega_2 \sin \theta \dot{\theta}) + Q_2 &= 0, \\ i_0 \dot{\omega}_1 - R_o R_t \dot{\Omega}_1 \cos \theta - R_t \sin \theta \sin \varphi - Q_1 &= 0, \\ i_0 \dot{\omega}_2 - R_o R_t \dot{\Omega}_2 \cos \theta + R_t \sin \theta \cos \varphi - Q_2 &= 0, \\ \dot{\theta} &= \omega_2 \cos \varphi - \omega_1 \sin \varphi. \end{aligned}$$

The derivatives of the angular velocities of the ball have the form

$$\dot{\Omega}_1 = \frac{\dot{V}_2}{R_o} = \frac{a_2(t)}{R_o}, \quad \dot{\Omega}_2 = -\frac{\dot{V}_1}{R_o} = -\frac{a_1(t)}{R_o}, \quad \dot{\Omega}_3 = 0. \quad (13)$$

We can represent the accelerations $a_1(t)$ and $a_2(t)$ as

$$a_1(t) = a(t, \alpha, T) \cos \varphi, \quad a_2(t) = a(t, \alpha, T) \sin \varphi, \quad (14)$$

where $a(t, \alpha, T)$ is defined by the expression (12) and θ is the function of time and parameters α and T and is defined by the expression (8) as before.

Differentiating Eq. (3) with respect to time using (13) and (14) yields

$$\ddot{\mathbf{r}} = R_o \mathbf{k} \times \dot{\boldsymbol{\Omega}} = R_o \left(-\dot{\Omega}_2, \dot{\Omega}_1, 0 \right)^T = a(t) \mathbf{s},$$

where $\mathbf{s} = (\cos \varphi, \sin \varphi, 0)^T = \frac{\Delta \mathbf{V}}{\Delta V}$ is the unit vector (constant for an one maneuver) along which the velocity changes (see Fig. 5). Since φ is the angle between the initial direction of motion and the direction of oscillation of the pendulum, the following proposition holds.

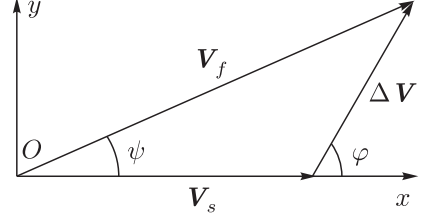

Figure 5: \mathbf{V}_s is the initial velocity of motion, $\Delta \mathbf{V}$ is the change of the velocity, \mathbf{V}_f is the velocity of the ball after termination of a maneuver.

Proposition 1. *The velocity of the ball changes in the direction of oscillation of the pendulum.*

If $\varphi = 0$, we obtain acceleration of the ball in a straight line considered in Section 2.1.

Now we consider another case — oscillation at the angle $\varphi = \frac{\pi}{2}$ to the initial direction of motion. Then the vector directed along the symmetry axis of the pendulum can be represented as

$$\mathbf{n} = (0, \sin \theta, \cos \theta)^T.$$

The equations of motion (4) can be rewritten as

$$\begin{aligned} I_0 \dot{\Omega}_1 - R_o R_t (\dot{\omega}_1 \cos \theta + \omega_1^2 \sin \theta) + Q_1 &= 0, \\ i_0 \dot{\omega}_1 - R_o R_t \dot{\Omega}_1 \cos \theta - R_t \sin \theta - Q_1 &= 0, \\ \dot{\theta} &= -\omega_1. \end{aligned} \quad (15)$$

As in the previous case, we specify the angle of deviation of the pendulum from the vertical in the form (8). The derivatives of the angular velocities of the ball have the form

$$\dot{\Omega}_1 = \frac{\dot{V}_2}{R_o} = \frac{a(t)}{R_o}, \quad \dot{\Omega}_2 = \dot{\Omega}_3 = 0. \quad (16)$$

The expression for the acceleration of the ball $a(t, \alpha, T)$ has the same form as during acceleration in a straight line (12) and the controls can be written as

$$\begin{aligned} Q_1 &= -\frac{a(t, \alpha, T)}{R_o} I_0 - R_o R_t \left(\cos \theta \ddot{\theta} - \sin \theta \dot{\theta}^2 \right), \\ Q_2 &= Q_3 = 0. \end{aligned} \quad (17)$$

Thus, similarly to acceleration in a straight line, for rotation through the specified angle it is necessary to generate a control torque which is orthogonal to the plane of oscillation of the pendulum and, accordingly, to the direction of the vector of change of the velocity.

Differentiating Eq. (3) with respect to time and using (12) and (16), we obtain

$$\ddot{\mathbf{r}} = R_o \mathbf{k} \times \dot{\mathbf{\Omega}} = R_o \left(-\dot{\Omega}_2, \dot{\Omega}_1, 0 \right)^T = (0, a(t, \alpha, T), 0)^T, \quad (18)$$

i.e., the velocity changes only in the direction of the axis Oy — in the direction of oscillation of the pendulum.

Our goal is to find a value of the parameter α at which a rotation through a given angle ψ is performed. To this end we integrate Eq. (18) between 0 and T and compute the projections of the velocity V_1 and V_2 onto the axes Ox and Oy , respectively, at the final instant of time, which are related with the angle of rotation in the absolute coordinate system by the relation (see Fig. 6)

$$\psi = \operatorname{arctg} \frac{V_2}{V_1}.$$

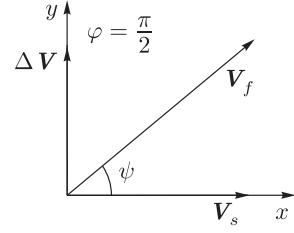

Figure 6: Change of the velocity of the ball.

Changing the parameters α and T , we obtain the dependence $\psi(\alpha, T)$ shown in Fig. 7(a). The function $\psi(\alpha, T)$ is also antisymmetric relative to the plane $\alpha = 0$, and $\psi_{\max} \rightarrow \frac{\pi}{2}$ as $T \rightarrow 0$.

Figure 7(b) shows sections of this surface for different values of T . As seen from the graphs, at least two values of α correspond to the given ψ and T as in the previous case.

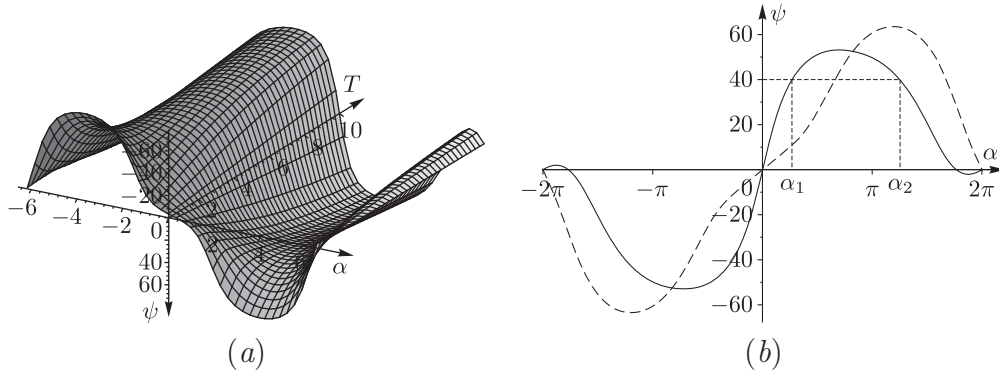

Figure 7: (a) The surface $\psi(\alpha, T)$. (b) Section formed by the intersection of the surface $\psi(\alpha, T)$ with the planes $T = 5$ (solid line) and $T = 1$ (dashed line).

Substituting the computed value of the parameter α , for example α_1 , into the equations of motion (15) and numerically integrating them using (12), we obtain the controls (17).

EXAMPLE 2. We consider the rotation of the ball through the angle $\psi = 40^\circ$ for the time $T = 5$ with the initial conditions in the form

$$\mathbf{n} = (0, 0, 1)^T, \quad \boldsymbol{\omega} = (0, 0, 0)^T, \quad \mathbf{r} = (0, 0, 0)^T, \quad \mathbf{V} = (V_s, 0, 0)^T,$$

where V_s is the initial velocity.

We choose the initial velocity such that the change of velocity ΔV and the parameter α are the same as in the previous example, i.e., $V_s = \Delta V \operatorname{ctg} \psi = 0.6$.

The trajectory of such a motion is shown in Fig. 8.

Since all parameters are similar to those in the previous example, all functions have the form shown in Fig. 4 up to the change of variables $n_1 \rightarrow n_2$, $\omega_2 \rightarrow -\omega_1$, $V_x \rightarrow V_y$ and $Q_2 \rightarrow -Q_1$.

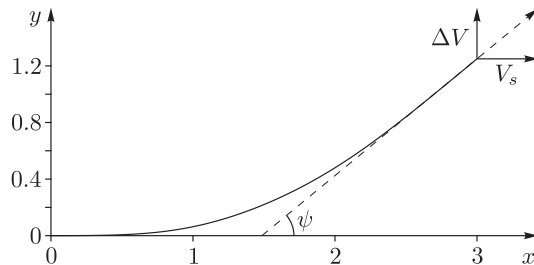

Figure 8: The trajectory of motion by rotation through the angle $\psi = 40^\circ$, $V_s = 0.6$.

3 Motion with fixed parameters

In this section we will consider a control which prescribes the motion with constant acceleration along a given straight line (or a given curve in the more general case). Such a control is used, for example, in usual vehicles, i.e., in fact it is defined in a body-fixed reference frame. As will be shown below, in this case such an approach has some shortcomings which stem from the conservatism of the resulting system.

We demonstrate by a specific example an algorithm for determining the control torque. For this, we consider the uniformly accelerated motion of the ball in a straight line along the axis Ox under the law

$$x(t) = \frac{a_0 t^2}{2},$$

where $a_0 = \text{const}$ is the given acceleration of the ball.

Assume that the ball rolls without spinning, i.e., $\Omega_3 = 0$. Similarly to (11) using (3) we obtain

$$\dot{\Omega}_1(t) = 0, \quad \dot{\Omega}_2(t) = -\frac{a_0}{R_o},$$

i.e., during acceleration along the axis Ox the pendulum performs oscillations only in the plane Oxz , therefore, the vector \mathbf{n} has the form

$$\mathbf{n} = (\sin \theta, 0, \cos \theta)^T,$$

where θ is the angle of deviation of the pendulum from the vertical, which is the unknown function of time. The angular velocity of the pendulum has the form $\omega_2 = \dot{\theta}$.

Substituting the resulting expressions into the equations of motion, we find the control torques which ensure uniformly accelerated motion in a straight line along the axis Ox

$$Q_1 = Q_3 = 0, \\ Q_2 = \frac{a_0}{R_o} I_0 + R_o R_t \left(\cos \theta \ddot{\theta} - \sin \theta \dot{\theta}^2 \right)$$

and the equation for determining the dependence of the angle θ :

$$\ddot{\theta} = \frac{a_0 I_0 - a_0 R_o R_t \cos \theta - R_o R_t \left(R_o \sin \theta \dot{\theta}^2 + \sin \theta \right)}{R_o (i_0 - R_o R_t \cos \theta)}. \quad (19)$$

In addition to the geometrical integral $\mathbf{n}^2 = 1$, this system admits another integral of motion quadratic in angular velocity

$$C = -\frac{R_o}{2} (i_0 - R_o R_t \cos \theta)^2 \dot{\theta}^2 + R_o R_t \left(i_0 - \frac{R_o R_t}{2} \cos \theta \right) (\cos \theta - a_0 \sin \theta) + \\ + a_0 \theta \left(I_0 i_0 + \frac{R_o^2 R_t^2}{2} \right) - a_0 R_o R_t I_0 \sin \theta,$$

which is an analog of an integral of generalized energy in a uniformly accelerated reference frame.

Figure 9 shows a phase portrait of the system (19) on the plane $(\theta, \dot{\theta})$ for uniformly accelerated motion of the ball in a straight line with the acceleration $a_0 = 0.1$. For the given system parameters, there are two fixed points on the phase plane one of which corresponds to a stable equilibrium position (at $\theta = 0.38$, $\dot{\theta} = 0$ of center type), while the other is an unstable saddle point (at $\theta = 2.56$ and $\dot{\theta} = 0$).

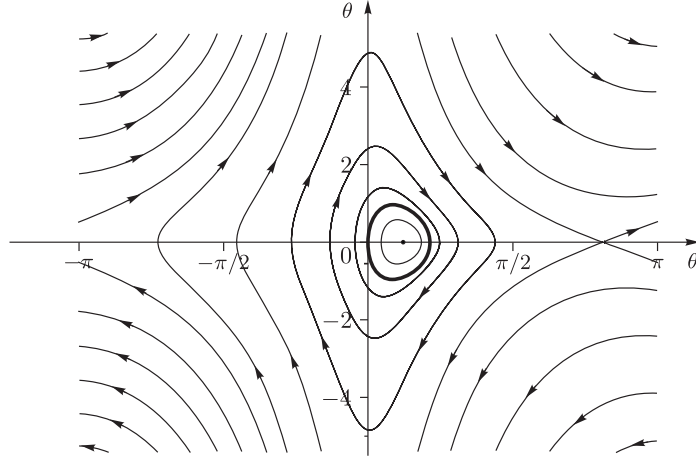

Figure 9: Phase portrait of the system for uniformly accelerated motion of the ball in a straight line.

As seen from Fig. 9, there exists a single trajectory corresponding to a state of rest at the initial instant of time (it passes through the point $(0,0)$ — bold line). Periodic motion along this trajectory is ensured by the periodic control torque. Figure 10 shows the time dependence of the vectors $\mathbf{n}, \boldsymbol{\omega}$ and \mathbf{Q} for the initial conditions $\theta(0) = \dot{\theta}(0) = 0$. From these graphs we can see that the pendulum performs oscillations in the plane Oxz , and the vector of the control torque changes periodically and is directed along the axis Oy .

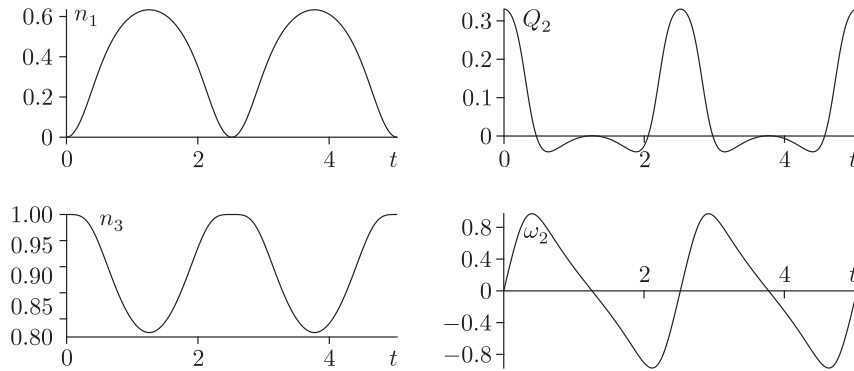

Figure 10: Time dependence of non-zero components of the vectors $\mathbf{n}, \boldsymbol{\omega}, \mathbf{Q}$ when the ball moves in a straight line with the constant acceleration $a_0 = 0.1$ and the initial conditions $\theta = \dot{\theta} = 0$.

If at the initial instant of time we define the angle of deviation corresponding to the stable fixed point, then the ball will move with uniform acceleration. The deviation of the pendulum by a constant angle will be maintained by a constant value of the control torque. To any other (arbitrary) initial conditions there correspond closed periodic trajectories whose realization requires constantly applying

the periodical control, which is inconvenient for the user. That is, it is difficult to manually maintain the motion with constant acceleration.

In addition, a significant shortcoming of this control method is the difficulty of switching to another motion mode at any instant of time (for example, if the velocity reaches the given value), because it may happen that the pendulum is not in the lower position.

The authors are grateful to A. V. Borisov, I. S. Mamaev and A. A. Kilin for fruitful discussions and useful remarks.

References

- [1] Balandin, D. V., Komarov, M. A., and Osipov, G. V., A Motion Control for a Spherical Robot with Pendulum Drive, *Izv. Ross. Akad. Nauk. Teor. Sist. Upr.*, 2013, no. 4, pp. 150–163 [*J. Comput. Sys. Sc. Int.*, 2013, vol. 52, no. 4, pp. 650–663].
- [2] Bolotin, S. V. and Popova, T. V., On the Motion of a Mechanical System Inside a Rolling Ball, *Regul. Chaotic Dyn.*, 2013, vol. 18, nos. 1–2, pp. 159–165.
- [3] Borisov, A. V., Kilin, A. A., and Mamaev, I. S., How To Control Chaplygin’s Sphere Using Rotors, *Regul. Chaotic Dyn.*, 2012, vol. 17, nos. 3–4, pp. 258–272.
- [4] Borisov, A. V., Kilin, A. A., and Mamaev, I. S., How To Control the Chaplygin Ball Using Rotors: 2, *Regul. Chaotic Dyn.*, 2013, vol. 18, nos. 1–2, pp. 144–158.
- [5] Borisov, A. V. and Mamaev, I. S., Two Non-Holonomic Integrable Problems Tracing Back to Chaplygin, *Regul. Chaotic Dyn.*, 2012, vol. 17, no. 2, pp. 191–198.
- [6] Martynenko, Yu. G. and Formal’skii, A. M., The Theory of the Control of a Monocycle, *Prikl. Mat. Mekh.*, 2005, vol. 69, no. 4, pp. 569–583 [*J. Appl. Math. Mech.*, 2005, vol. 69, no. 4, pp. 516–528].
- [7] Martynenko, Yu. G. and Formal’skii, A. M., A Control of the Longitudinal Motion of a Single-Wheel Robot on an Uneven Surface, *Izv. Ross. Akad. Nauk. Teor. Sist. Upr.*, 2005, no. 4, pp. 165–173 [*J. Comput. Sys. Sc. Int.*, 2005, vol. 44, no. 4, pp. 662–670].
- [8] Pivovarova, E. N. and Ivanova, T. B., Stability Analysis of Periodic Solutions in the Problem of the Rolling of a Ball with a Pendulum, *Vestn. Udmurtsk. Univ. Mat. Mekh. Komp. Nauki*, 2012, no. 4, pp. 146–155 (Russian).
- [9] Chase, R. and Pandya, A., A Review of Active Mechanical Driving Principles of Spherical Robots, *Robotics*, 2012, vol. 1, no. 1, pp. 3–23.
- [10] Das, T. and Murkherjee, R., Dynamic Analysis of Rectilinear Motion of a Self-Propelling Disk with Unbalance Masses, *Trans. ASME. J. Appl. Mech.*, 2001, vol. 68, pp. 58–66.
- [11] Kayacan, E., Bayraktaroglu, Z. Y., and Saeys, W., Modeling and Control of a Spherical Rolling Robot: A Decoupled Dynamics Approach, *Robotica*, 2012, vol. 30, no. 12, pp. 671–680.

- [12] Michaud, F. and Caron, S., Roball, the Rolling Robot, *Auton. Robots*, 2002, vol. 12, pp. 211–222.
- [13] Nagai, M., Control System of a Spherical Robot, *Master Thesis*, Espoo: Lulea Univ. of Technology, 2008.
- [14] Schroll, G. C., Dynamic Model of a Spherical Robot from First Principles, *Master Thesis*, Boulder, CO: Colorado State Univ., 2010.