

A CATEGORICAL SEMANTICS FOR CAUSAL STRUCTURE

ALEKS KISSINGER AND SANDER UIJLEN

iCIS, Radboud University
e-mail address: aleks@cs.ru.nl

University of Oxford
e-mail address: suijlen@cs.ru.nl

ABSTRACT. We present a categorical construction for modelling causal structures within a general class of process theories that include the theory of classical probabilistic processes as well as quantum theory. Unlike prior constructions within categorical quantum mechanics, the objects of this theory encode fine-grained causal relationships between subsystems and give a new method for expressing and deriving consequences for a broad class of causal structures. We show that this framework enables one to define families of processes which are consistent with arbitrary acyclic causal orderings. In particular, one can define one-way signalling (a.k.a. semi-causal) processes, non-signalling processes, and quantum n -combs. Furthermore, our framework is general enough to accommodate recently-proposed generalisations of classical and quantum theory where processes only need to have a fixed causal ordering locally, but globally allow indefinite causal ordering. To illustrate this point, we show that certain processes of this kind, such as the quantum switch, the process matrices of Oreshkov, Costa, and Brukner, and a classical three-party example due to Baumeler, Feix, and Wolf are all instances of a certain family of processes we refer to as SOC_n in the appropriate category of higher-order causal processes. After defining these families of causal structures within our framework, we give derivations of their operational behaviour using simple, diagrammatic axioms.

CONTENTS

1. Introduction	2
2. Preliminaries	5
2.1. Compact closed categories and higher-order string diagrams	6
2.2. $*$ -autonomous categories	8
2.3. Discarding, causality, and non-signalling	9
3. Precausal categories	12
4. Constructing $\text{Caus}[\mathcal{C}]$	18
5. First order systems	21
6. Higher-order systems with definite causal order	22
6.1. Linear causal orders via combs	26
6.2. Directed acyclic causal orders via pullback	30
7. Higher-order systems with indefinite causal order	34

8. Conclusion and Future Work	37
References	39
Appendix A. Omitted proofs	41
A.1. Proof that $\text{Caus}[\mathcal{C}]$ is $*$ -autonomous	41
A.2. Proofs that $\mathbf{Mat}(\mathbb{R}_+)$ and \mathbf{CPM} are pre-causal	44
A.3. Proofs that \mathbf{Rel} is only weakly pre-causal	46
A.4. Proof of embedding into the type of all causal processes	47

1. INTRODUCTION

Broadly, causal structures identify which events or processes taking place across space and time can, in principle, serve as causes or effects of one another. In the field of statistical causal inference, directed acyclic graphs (or generalisations thereof) have been used to capture that fact that certain random variables may have causal influences on others. That is, forcefully changing a certain variable (e.g., whether a patient takes a drug or placebo in randomised trial) may have an effect on another variable (e.g., whether the patient recovers). Intuitively, it may seem impossible to draw such causal conclusions without making such an intervention, however it has been shown in recent years that, under certain assumptions, one can draw causal conclusions from purely observational data [33]. For instance, the *constraint-based approach* to causal discovery uses conditional independences present in statistical data to iteratively rule out possible causal relationships by removing edges from a (typically very large) directed graph. This sits at the heart of modern, graph-based causal discovery algorithms such as FCI [39], and has been successful in a wide variety of real-world applications, including the study of ADHD [38], neural connectivity [20], gene regulation networks [36], and climate change [18].

In recent years, it has been asked whether, and to what extent, concepts from classical causal reasoning can be transferred to quantum theory, or more generalised theories of interacting processes. A major obstacle to employing classical techniques comes from the presence of *quantum non-locality*, i.e., the possibility of correlations observed between distant, non-communicating agents which cannot be explained by a classical common cause. Indeed, Wood and Spekkens showed that quantum theory allows correlations which admit no faithful classical causal model [42]. Roughly speaking, this means that any attempt to naïvely reproduce quantum correlations with a classical causal model will necessarily include spurious causal relationships. Hence, there have been numerous attempts to extend classical causal models to quantum [35, 16, 2] or even more general [24] models.

In the context of quantum theory, causal relationships between inputs and outputs to quantum processes have been expressed in a variety of ways. Perhaps the simplest are in the form of non-signalling constraints, which guarantee that distant agents are not capable of sending information faster than the speed of light, e.g., to affect each other's measurement outcomes [4]. Quantum strategies [22] and more recently quantum combs [5] offer a means of expressing more intricate causal relationships, in the form of chains of causally ordered inputs and outputs. Furthermore, it has been shown recently that one can formulate a theory that is locally consistent with quantum theory yet assumes no fixed background causal

structure [32]. Interestingly, such a theory admits *indefinite* causal structures. Namely, it allows one to express processes which inhabit a quantum superposition of causal orders.

Such processes are especially interesting for two reasons. First, indefinite causal structure seems to be an inevitable property of any theory that attempts to combine causal dynamics of general relativity with the irreducible non-determinism of quantum theory [23]. Hence, indefinite causal structures can provide interesting ‘toy models’ that exhibit quantum gravity-like features. Second, if physically realisable, processes with indefinite causal ordering can be exploited to gain an advantage in communication problems, such as the ‘guess your neighbour’s input’ game [32] and computational tasks, such as single-shot quantum channel discrimination [8]. Perhaps surprisingly, this phenomenon is not unique to quantum processes: it has been shown recently that, in the presence of three or more parties, causal bounds can be violated even within a theory that behaves locally like classical probability theory [3]. The key ingredient in studying (and varying) causal structures of processes is the development of a coherent theory of *higher order causal processes*. That is, if we treat local agents (or events, laboratories, etc.) as first order causal processes, then the act of composing these processes in a particular causal order should be treated as a second-order process.

This paper aims to represent causal relationships within ‘black box’ processes (which could be classical, quantum, or more general) in a uniform way, and provide some of the first tools for ‘generalised causal reasoning’ which can be applied in both the classical and quantum contexts. To do this, we start from a category \mathcal{C} of ‘raw materials’—whose morphisms should be thought of as processes without any causal constraints—and construct a new category $\text{Caus}[\mathcal{C}]$ of first and higher-order processes which are consistent with certain given causal constraints.

For \mathcal{C} , we introduce a new kind of category called a *precausal category*, which is a compact closed category with a bit of extra structure enabling us to reason about causal relationships between systems. Most notably, precausal categories have a special *discarding process* defined on each object, which enables one to say when a process is *causal*, namely when it satisfies the following equation:

$$\begin{array}{c} \overline{\overline{\mid}}_B \\ \boxed{\Phi} \\ \mid_A \end{array} = \begin{array}{c} \overline{\overline{\mid}}_A \end{array}$$

This has a clear operational intuition:

If the output of a causal process is discarded, it doesn’t matter which process occurred.

...or put a slightly different way:

The only influence a causal process has is on its output.

In particular, causality rules out the possibility of hidden side effects or the ‘backwards flow’ of information from a given process. While seemingly obvious, the causality condition, originally given by [7] in the context of operational probabilistic theories, is surprisingly powerful. For instance, it is equivalent to the non-signalling property for joint processes arising from shared correlations [13].

It is thus natural to consider the subcategory of \mathcal{C} consisting of all causal processes. However, we take this a step further and consider not only (first-order) causal processes, but also higher-order mappings which preserve certain kinds of causal processes. This yields a *-autonomous category $\text{Caus}[\mathcal{C}]$, into which the category of all first-order causal processes

embeds fully and faithfully. We therefore call categories of the form $\text{Caus}[\mathcal{C}]$ *higher-order causal categories* (HOCCs). Our main examples start from the precausal categories of matrices of positive real numbers and completely positive maps, which will yield HOCCs of higher-order classical stochastic processes and higher-order quantum channels, respectively.

While categorical quantum mechanics [1] has typically focussed on compact closed categories of quantum processes, we show that this $*$ -autonomous structure yields a much richer type system for describing causal relationships between systems. Whereas compact closed categories have only one way to form joint systems, namely \otimes , $*$ -autonomous categories have two: \otimes and \mathfrak{A} . A simple, yet striking example of the difference in these two connectives in $\text{Caus}[\mathcal{C}]$ comes from forming types of processes on a joint system:

$$\begin{aligned} (\mathbf{A} \multimap \mathbf{A}') \otimes (\mathbf{B} \multimap \mathbf{B}') &\leftarrow \text{non-signalling processes} \\ (\mathbf{A} \multimap \mathbf{A}') \mathfrak{A} (\mathbf{B} \multimap \mathbf{B}') &\leftarrow \text{all processes} \end{aligned}$$

Using the richer type system afforded by $*$ -autonomous categories, we are able to give logical characterisations of many kinds of first- and higher-order causality constraints, and show, for example, when certain constraints imply others.

The paper is structured as follows. In section 2, we outline the basics of compact closed categories, string diagrams, $*$ -autonomous categories, discarding, and (non-)signalling processes. In section 3, we introduce precausal categories and prove some basic properties, such as the *no time-travel* theorem for precausal categories. In section 4, we construct the higher-order causal category $\text{Caus}[\mathcal{C}]$ and show that it is $*$ -autonomous. In section 5, we develop various properties of first-order systems, most notably the coincidence of \otimes and \mathfrak{A} . In section 6, we demonstrate the aforementioned dichotomy of \otimes and \mathfrak{A} at the level of second-order systems: namely that \otimes can be used to construct a type of non-signalling processes whereas \mathfrak{A} yields all processes. Furthermore, we show that one-way signalling processes can be captured in a HOCC using a generalisation of quantum combs, and processes satisfying arbitrary acyclic causal structures can be captured using pullbacks of combs. In section 7, we show that HOCCs also enable us to capture bipartite and n -partite second-order causal processes. We give several examples which are known to exhibit indefinite causal structure, namely the OCB process from [32], the classical tripartite process from [3], and an abstract version of the quantum switch defined in [8]. Finally, we prove using just the structure of $\text{Caus}[\mathcal{C}]$ that the switch does not admit a causal ordering by reducing to no time-travel.

Related work. This work was inspired by [34], which aims for a uniform description of higher-order *quantum* operations in terms of generalised Choi operators. However, rather than relying on the linear structure of spaces of operators, we work purely in terms of the $*$ -autonomous structure and the precausal axioms, which concern the compositional behaviour of discarding processes. The construction of $\text{Caus}[\mathcal{C}]$ is a variant of the *double gluing construction* used in [25] to construct models of linear logic. In the language of that paper, our construction consists of building the ‘tight orthogonality category’ induced by a focussed orthogonality on $\{1_I\} \subseteq \mathcal{C}(I, I)$, and then restricting to objects satisfying the flatness condition in Definition 4.2. Since it is $*$ -autonomous, $\text{Caus}[\mathcal{C}]$ indeed gives a model of multiplicative linear logic, enabling us to enlist the aid of linear-logic based tools for proving theorems about causal types. We comment briefly on this in the conclusion. When fixing $\mathcal{C} = \mathbf{Mat}(\mathbb{R}_+)$, the category $\text{Caus}[\mathbf{Mat}(\mathbb{R}_+)]$ is closely related to (the finite-dimensional subcategory of) probabilistic coherence spaces, introduced in [21] and refined in [17]. The main difference, aside from allowing matrices over infinite sets of indices, is that the latter defines duals with respect to $[0, 1] \subseteq \mathbf{Mat}(\mathbb{R}_+)(I, I) \cong \mathbb{R}_+$ rather than $\{1\}$, which allows

one to capture sub-normalised probability distributions as well as normalised ones. Our construction indeed extends to incorporate sub-normalised processes, but understanding the structure of the resulting, larger category and its relationship to the one we define is a subject of future work. It is worth noting however, that the correspondence with coherence spaces does not extend to the quantum case. In particular, $\text{Caus}[\mathbf{CPM}]$ is better behaved than the quantum coherence spaces defined by Gerard in [21], as it inherits the quantum tensor product—and hence the usual notions of positivity for states and complete positivity for morphisms—from the underlying category \mathbf{CPM} .

Acknowledgements. Both authors are grateful to Paulo Perinotti for his input and sharing a draft version of [34]. We would also like to thank Časlav Brukner, Matty Hoban, and Sam Staton for useful discussions. This work is supported by the ERC under the European Union’s Seventh Framework Programme (FP7/2007-2013) / ERC grant n° 320571.

This is an extended version of a conference paper with the same title [28]. While the overall structure is the same, it has been expanded with additional examples and explanation and provides two new technical contributions. The first is a proof that \mathbf{Rel} is ‘weakly’ precausal, in that it satisfies all of the precausal axioms except $(C5')$. The second and more substantial contribution is the pullback construction in Section 6.2 which is used to capture all acyclic causal structures, rather than just linear ones as in [28].

2. PRELIMINARIES

We work in the context of *symmetric monoidal categories* (SMCs). An SMC consists of a collection of objects $\text{ob}(\mathcal{C})$, for every pair of objects, $A, B \in \text{ob}(\mathcal{C})$ a set $\mathcal{C}(A, B)$ of morphisms, associative sequential composition ‘ \circ ’ with units 1_A for all $A \in \text{ob}(\mathcal{C})$, associative (up to isomorphism) parallel composition ‘ \otimes ’ for objects and morphisms with unit $I \in \text{ob}(\mathcal{C})$, and swap maps $\sigma_{A,B} : A \otimes B \rightarrow B \otimes A$, satisfying the usual equations one would expect for composition and tensor product. For simplicity, we furthermore assume \mathcal{C} is *strict*, i.e.

$$(A \otimes B) \otimes C = A \otimes (B \otimes C) \quad A \otimes I = A = I \otimes A$$

This is no loss of generality since every SMC is equivalent to a strict one. For details, [31] is a standard reference.

We wish to treat SMCs as theories of physical processes, hence we often refer to objects as *systems* and morphisms as *processes*. We will also extensively use *string diagram* notation for SMCs, where systems are depicted as wires, processes as boxes, and:

$$\begin{array}{ccc}
 g \circ f := \begin{array}{c} \boxed{g} \\ | \\ \boxed{f} \\ | \end{array} & f \otimes g := \begin{array}{cc} \boxed{f} & \boxed{g} \\ | & | \end{array} \\
 1_A := \begin{array}{c} | \\ A \end{array} & 1_I := \begin{array}{c} \\ \end{array} & \sigma_{A,B} := \begin{array}{c} \\ \end{array}
 \end{array}$$

Note that diagrams should be read from bottom-to-top. A process $\rho : I \rightarrow A$ is called a *state*, a process $\pi : A \rightarrow I$ is called an *effect*, and $\lambda : I \rightarrow I$ is called a *number* or *scalar*. Depicted as string diagrams:

$$state := \begin{array}{c} \downarrow \\ \triangle \\ \rho \end{array} \quad effect := \begin{array}{c} \triangle \\ \uparrow \\ \pi \end{array} \quad number := \lambda$$

Numbers in an SMC always form a commutative monoid with ‘multiplication’ \circ and unit the identity morphism 1_I . We typically write 1_I simply as 1.

2.1. Compact closed categories and higher-order string diagrams.

We will begin with a category \mathcal{C} and construct a new category $\text{Caus}[\mathcal{C}]$ of higher-order causal processes. In order to make this construction, we first need a mechanism for expressing higher-order processes. *Compact closure* provides such a mechanism that is convenient within the graphical language and already familiar within the literature on quantum channels, in the guise of the Choi-Jamiołkowski isomorphism.

Definition 2.1. An SMC \mathcal{C} is called *compact closed* if every object A has a *dual* object A^* . That is, for every A there exists morphisms $\eta_A : I \rightarrow A^* \otimes A$ and $\epsilon_A : A \otimes A^* \rightarrow I$, satisfying:

$$(\epsilon_A \otimes 1_A) \circ (1_A \otimes \eta_A) = 1_A \quad (1_{A^*} \otimes \epsilon_A) \circ (\eta_A \otimes 1_{A^*}) = 1_{A^*}$$

We refer to η_A and ϵ_A as a cup and a cap, denoted graphically as \cup and \cap , respectively. In this notation, the equations in Definition 2.1 become:

$$\begin{array}{c} \cup \\ \text{---} A^* \text{---} \\ \cap \\ \text{---} A \text{---} \end{array} = \begin{array}{c} | \\ A \end{array} \quad \begin{array}{c} \cap \\ \text{---} A^* \text{---} \\ \cup \\ \text{---} A \text{---} \end{array} = \begin{array}{c} | \\ A^* \end{array}$$

It is always possible to choose cups and caps in such a way that the canonical isomorphisms $I^* \cong I$, $(A \otimes B)^* \cong A^* \otimes B^*$, and $A \cong A^{**}$ are all in fact equalities. We will assume this is the case throughout this paper.

Crucially, two morphisms in a free compact closed category are equal if and only if their string diagrams are the same. That is, if one diagram can be continuously deformed into the other while maintaining the connections between boxes. Hence, when we draw a string diagram, we mean *any* composition of boxes via cups, caps, and swaps which yields the given diagram, up to deformation. See [37] for an overview of string diagram languages for monoidal categories.

Compact closed categories exhibit *process-state duality*, that is, processes $f : A \rightarrow B$ are in 1-to-1 correspondence with states $\rho_f : I \rightarrow A^* \otimes B$:

$$\begin{array}{c} \downarrow \\ \boxed{f} \\ \uparrow \end{array} \mapsto \begin{array}{c} \downarrow \\ \boxed{f} \\ \uparrow \\ \rho_f \end{array} \quad (2.1)$$

Hence, we treat everything as a ‘state’ in \mathcal{C} and write $f : X$ as shorthand for $f : I \rightarrow X$. In this notation, states are of the form $\rho : A$, effects $\pi : A^*$, and general processes $f : A^* \otimes B$. Furthermore, we won’t require ‘output’ wires to exit upward, and we allow irregularly-shaped boxes. For example, we can write a process $w : A^* \otimes B \otimes C^* \otimes D$ using ‘comb’ notation:

$$\begin{array}{c}
 \begin{array}{|c}
 \hline
 D \\
 \hline
 \begin{array}{|c}
 \hline
 C \\
 \hline
 \end{array} \\
 \hline
 \begin{array}{|c}
 \hline
 B \\
 \hline
 \end{array} \\
 \hline
 A \\
 \hline
 \end{array}
 \end{array}
 \quad := \quad
 \begin{array}{c}
 \begin{array}{|c|c|c|c}
 \hline
 A^* & B & C^* & D \\
 \hline
 \end{array} \\
 \hline
 w \\
 \hline
 \end{array}
 \end{array}
 \tag{2.2}$$

Note that we adopt the convention that an A -labelled ‘input’ wire is of the same type as an A^* -labelled ‘output’.

While both the LHS and the RHS in equation (2.2) are notation for the same process w , the LHS is strongly suggestive of a second-order mapping from processes $B \rightarrow C$ to processes $A \rightarrow D$. Composition in this notation simply means applying the appropriate ‘cap’ processes to plug wires together:

$$\begin{array}{c}
 \begin{array}{|c}
 \hline
 D \\
 \hline
 \begin{array}{|c}
 \hline
 C \\
 \hline
 \end{array} \\
 \hline
 \begin{array}{|c}
 \hline
 \Phi \\
 \hline
 \end{array} \\
 \hline
 \begin{array}{|c}
 \hline
 B \\
 \hline
 \end{array} \\
 \hline
 A \\
 \hline
 \end{array}
 \end{array}
 \quad := \quad
 \begin{array}{c}
 \begin{array}{|c|c|c|c}
 \hline
 A^* & B & C^* & D \\
 \hline
 \end{array} \\
 \hline
 w \\
 \hline
 \end{array}
 \quad
 \begin{array}{c}
 \begin{array}{|c|c}
 \hline
 B^* & C \\
 \hline
 \end{array} \\
 \hline
 \Phi \\
 \hline
 \end{array}
 \end{array}$$

Remark 2.2. Since oddly-shaped boxes don’t uniquely fix any ordering of systems with respect to \otimes , we will often ‘name’ each system by giving it a unique type and assume systems are permuted via σ -maps whenever necessary. This is a common practice e.g., in the quantum information literature.

Our key examples of compact closed categories to which we will apply our construction to obtain categories of higher-order causal types, will be $\mathbf{Mat}(\mathbb{R}_+)$ and \mathbf{CPM} , which we introduce now. They contain stochastic matrices and quantum channels, respectively.

Example 2.3. The category $\mathbf{Mat}(\mathbb{R}_+)$ has as objects natural numbers. Morphisms $f : m \rightarrow n$ are $n \times m$ matrices. Composition is given by matrix multiplication: $(g \circ f)_i^j := \sum_k f_i^k g_k^j$, and the tensor is given by $m \otimes n := mn$ and $f \otimes g$ is the Kronecker product of matrices:

$$(f \otimes g)_{ij}^{kl} := f_i^k g_j^l$$

Consequently, the tensor unit I is the natural number 1, so that states are column vectors $\rho : 1 \rightarrow n$, effects are row vectors $\pi : n \rightarrow 1$, and scalars are positive numbers $\lambda \in \mathbb{R}_+$.

$\mathbf{Mat}(\mathbb{R}_+)$ is compact closed with $n = n^*$, where cups and caps are given by the Kronecker delta, δ_{ij} , $\delta_{ij} = 1$ if $i = j$, $\delta_{ij} = 0$ otherwise. That is:

$$\eta^{ij} := \delta_{ij} =: \epsilon_{ij}$$

Example 2.4. The category \mathbf{CPM} has as objects the sets of linear operators, $\mathcal{L}(H)$, $\mathcal{L}(K), \dots$, on finite dimensional complex Hilbert spaces H, K, \dots and morphisms $\Phi : \mathcal{L}(H) \rightarrow \mathcal{L}(K)$ are completely positive maps (i.e., positive maps which are still positive when tensored with other maps) with the usual composition: $\Phi \circ \Psi(a) = \Phi(\Psi(a))$.

The tensor product on objects satisfies $\mathcal{L}(H) \otimes \mathcal{L}(K) \cong \mathcal{L}(H \otimes K)$, and on morphisms it is given by linear extension of $\Phi \otimes \Psi(a \otimes b) = \Phi(a) \otimes \Psi(b)$. Consequently, the tensor unit is $I = \mathcal{L}(\mathbb{C}) \cong \mathbb{C}$ and a state is a (completely) positive map $\rho : \mathbb{C} \rightarrow \mathcal{L}(H)$. Identifying such a map with its image on 1, we may say that a state is positive operator in $\mathcal{L}(H)$. Effects are (un-normalised) quantum effects, i.e., (completely) positive maps $\pi : \mathcal{L}(H) \rightarrow \mathbb{C}$, and are of

the form: $\pi(a) := \text{Tr}(Pa)$, for some positive operator P . As with $\mathbf{Mat}(\mathbb{R}_+)$, the scalars are \mathbb{R}_+ .

CPM is also compact closed, with cups and caps given by the (un-normalised) Bell state:

$$\eta = |\Phi_0\rangle\langle\Phi_0| \quad \epsilon(\rho) = \text{Tr}(\rho|\Phi_0\rangle\langle\Phi_0|)$$

where $|\Phi_0\rangle = \sum_i |i\rangle \otimes |i\rangle$. Consequentially, $\mathcal{L}(H)^* = \mathcal{L}(H)$ and equation (2.1) gives the basis-dependent version, i.e., ‘Choi-style’, of the Choi-Jamiołkowski isomorphism [29].

2.2. *-autonomous categories.

The biggest convenience of a compact closed structure is also its biggest drawback: all higher-order structure collapses to first-order structure! For example, if we (temporarily) take $A \multimap B := A^* \otimes B$ to be the object whose states correspond to processes from A to B , we have:

$$\begin{aligned} (A \multimap B) \multimap C &:= (A \multimap B)^* \otimes C \\ &:= (A^* \otimes B)^* \otimes C \\ &\cong A^{**} \otimes B^* \otimes C \\ &\cong A \otimes B^* \otimes C \\ &\cong B^* \otimes A \otimes C \\ &=: B \multimap A \otimes C \end{aligned}$$

As we will soon see, there is a pronounced difference between first-order causal processes which we introduce in the next section, and genuinely higher-order causal processes (see Chapter 6). Hence, we would not expect such a collapse. If we look carefully at the calculation above, we see that things went wrong in the third step above. Because in any compact closed category, we always have $(A \otimes B)^* \cong A^* \otimes B^*$, we are able to distribute $(-)^*$ over \otimes . If we remove this condition, we obtain a new, weaker kind of category:

Definition 2.5. A **-autonomous category* is a symmetric monoidal category equipped with a full and faithful functor $(-)^* : \mathcal{C}^{\text{op}} \rightarrow \mathcal{C}$ such that, by letting:

$$A \multimap B := (A \otimes B^*)^* \tag{2.3}$$

there exists a natural isomorphism:

$$\mathcal{C}(A \otimes B, C) \cong \mathcal{C}(A, B \multimap C) \tag{2.4}$$

As the notation and the isomorphism (2.4) suggest, $A \multimap B$ is the system whose states correspond to processes from A to B . Indeed, take $A = I$ in (2.4).

Note that the definition we gave for $A \multimap B$ differs from the one we gave for compact closed categories. Indeed any compact closed category is *-autonomous, where it additionally holds that:

$$A \otimes B \cong (A^* \otimes B^*)^* \tag{2.5}$$

in which case:

$$A \multimap B := (A \otimes B^*)^* \cong A^* \otimes B^{**} \cong A^* \otimes B$$

However, in a *-autonomous category, the RHS of (2.5) is not $A \otimes B$, but something new, called the ‘par’ of A and B :

$$A \wp B := (A^* \otimes B^*)^* \quad (2.6)$$

This new operation inherits its good behaviour from \otimes :

$$A \wp (B \wp C) \cong (A \wp B) \wp C \quad A \wp B \cong B \wp A$$

So a compact closed category is just a $*$ -autonomous category where $\otimes = \wp$. However, this little tweak yields a much richer structure of higher-order maps. We think of $A \otimes B$ as the joint state space of A and B , whereas $A \wp B$ is like taking the space of maps from A^* to B . For (first order) state spaces, these are basically the same, but as we go to higher order spaces, $A \wp B$ tends to be much bigger than $A \otimes B$.

We adopt the programmers' convention that \otimes has precedence over \multimap and that \multimap associates to the right:

$$A \otimes B \multimap C := (A \otimes B) \multimap C \quad A \multimap B \multimap C := A \multimap (B \multimap C)$$

Either expression above represents the system whose states are processes with two inputs. Indeed (2.4) implies that $A \otimes B \multimap C \cong A \multimap B \multimap C$. Since \mathcal{C} is symmetric, we can re-arrange the inputs at will, i.e.,

$$A \multimap B \multimap C \cong B \multimap A \multimap C \quad (2.7)$$

2.3. Discarding, causality, and non-signalling.

As noted in [12, 14, 15, 7], the crucial ingredient for defining causality is a preferred *discarding* process $\overline{\top}_A$ from every system A into I , which is compatible with the monoidal structure, in that

$$\overline{\top}_{A \otimes B} := \overline{\top}_A \overline{\top}_B \quad \overline{\top}_I := 1 \quad (2.8)$$

Using this effect, we can define causality as follows:

Definition 2.6. For systems A and B with discarding processes, a process $\Phi : A \rightarrow B$ is said to be *causal* if:

$$\overline{\top}_B \begin{array}{c} \square \\ \Phi \\ \square \\ \downarrow \\ A \end{array} = \overline{\top}_A \quad (2.9)$$

Intuitively, causality means that if we disregard the output of a process, it does not matter which process occurred.

Hence *causal states* produce 1 when discarded:

$$\begin{array}{c} \downarrow \\ \rho \\ \nabla \end{array} \text{ causal} \iff \overline{\top}_I \begin{array}{c} \downarrow \\ \rho \\ \nabla \end{array} = 1$$

Since discarding the 'output' of an effect $\pi : A \rightarrow I$ is the identity, there is a unique causal effect for any system, namely discarding itself:

$$\begin{array}{c} \uparrow \\ \pi \\ \uparrow \end{array} \text{ causal} \iff \begin{array}{c} \uparrow \\ \pi \\ \uparrow \end{array} = \overline{\top}_A$$

Example 2.7. For $\text{Mat}(\mathbb{R}_+)$, the discarding process is a row vector consisting entirely of 1's; it sends a state to the sum over its vector entries:

$$\overline{\top}_I = (1 \ 1 \ \dots \ 1) \quad \overline{\top}_I \begin{array}{c} \downarrow \\ \rho \\ \nabla \end{array} = \sum_i \rho^i$$

So, causality is precisely the statement that a vector of positive numbers sums to 1, i.e., forms a probability distribution. Consequentially, the causality equation (2.9) for a process Φ states that each column of Φ must sum to 1. That is, Φ is a stochastic map.

Example 2.8. For **CPM**, discard is the trace. Hence causal states are positive operators with unit trace a.k.a. density operators and causal processes are trace-preserving completely positive maps, a.k.a. quantum channels.

Discarding not only allows us to express when a process is causal, it also allows us to represent causal relationships between the systems involved.

For example

Definition 2.9. A causal process $\Phi : A \otimes B \rightarrow A' \otimes B'$ is *one-way signalling* with **A** before **B** (written $\mathbf{A} \preceq \mathbf{B}$ where $\mathbf{A} := (A, A')$ and $\mathbf{B} := (B, B')$) if there exists a process $\Phi' : A \rightarrow A'$ such that

$$\begin{array}{c} \overline{\overline{A'}} \overline{\overline{B'}} \\ \boxed{\Phi} \\ \overline{\overline{A}} \overline{\overline{B}} \end{array} = \begin{array}{c} \overline{\overline{A'}} \\ \boxed{\Phi'} \\ \overline{\overline{A}} \end{array} \overline{\overline{B}} \quad (2.10)$$

It is one-way signalling with $\mathbf{B} \preceq \mathbf{A}$ if there exists Φ'' such that

$$\begin{array}{c} \overline{\overline{A'}} \overline{\overline{B'}} \\ \boxed{\Phi} \\ \overline{\overline{A}} \overline{\overline{B}} \end{array} = \overline{\overline{A'}} \begin{array}{c} \overline{\overline{B'}} \\ \boxed{\Phi''} \\ \overline{\overline{B}} \end{array} \quad (2.11)$$

Such a process is called *non-signalling* if it is both one-way signalling with $\mathbf{A} \preceq \mathbf{B}$ and $\mathbf{B} \preceq \mathbf{A}$.

At first, this might seem like curious terminology, since non-signalling processes are a special case of one-way signalling processes. This is because the term ‘one-way signalling’ does not imply that there *is* communication from Alice to Bob, but rather that communication is *only allowed* from Alice to Bob (and not from Bob to Alice). Contrast this with arbitrary causal processes $\Phi : A \otimes B \rightarrow A' \otimes B'$, which allow two-way communication in general.

Note that the expressions $\mathbf{A} \preceq \mathbf{B}$ and $\mathbf{B} \preceq \mathbf{A}$ in Definition 2.9 are not written in terms of individual inputs or outputs of Φ , but rather input/output pairs $\mathbf{A} := (A, A')$ and $\mathbf{B} := (B, B')$. We call such an input/output pair from a given process an *event*. If we think of an event in operational terms, it corresponds to a single agent giving an input to his or her black box (e.g., making a measurement choice) and then reading the output.

The definition of one-way signalling readily generalises from two events to n events:

Definition 2.10. A process Φ is *one-way signalling* with $\mathbf{A}_1 \preceq \dots \preceq \mathbf{A}_{n-1} \preceq \mathbf{A}_n$ if

$$\begin{array}{c} \overline{\overline{A'_1}} \dots \overline{\overline{A'_n}} \\ \boxed{\Phi} \\ \overline{\overline{A_1}} \dots \overline{\overline{A_n}} \end{array} = \begin{array}{c} \overline{\overline{A'_1}} \dots \overline{\overline{A'_{n-1}}} \\ \boxed{\Phi'} \\ \overline{\overline{A_1}} \dots \overline{\overline{A_{n-1}}} \end{array} \overline{\overline{A_n}}$$

with Φ' one-way signalling with $\mathbf{A}_1 \preceq \dots \preceq \mathbf{A}_{n-1}$.

Intuitively, this captures that fact that Φ is consistent with the linear causal ordering of events $\mathbf{A}_i = (A_i, A'_i)$. Following [26], we can extend this from linear causal orderings to arbitrary (acyclic) causal orderings. For a process $\Phi : A_1 \otimes \dots \otimes A_n \rightarrow A'_1 \otimes \dots \otimes A'_n$, let \mathcal{O} be a partially ordered set whose elements are the pairs $\{\mathbf{A}_i := (A_i, A'_i)\}_{1 \leq i \leq n}$, which we call a

Definition 2.11 generalises the other (non)signalling conditions given before. For example, one-way signalling $A \preceq B$ and $B \preceq A$ can be stated respectively as:

$$\begin{array}{c} |A'|B' \\ \boxed{\Phi} \\ |A|B \end{array} \models \begin{array}{c} B \\ | \\ A \end{array} \quad \text{and} \quad \begin{array}{c} |A'|B' \\ \boxed{\Phi} \\ |A|B \end{array} \models \begin{array}{c} A \\ | \\ B \end{array}$$

whereas non-signalling is equivalent to the following:

$$\begin{array}{c} |A'|B' \\ \boxed{\Phi} \\ |A|B \end{array} \models A \quad B$$

There is a close connection between causality (2.6) and consistency with a causal ordering \mathcal{O} . Namely, any (acyclic) string diagram has an evident causal ordering on the inputs/outputs of each of the component boxes, where $A \preceq B$ if and only if there is a forward-directed path from the box with inputs/outputs (A, A') to the box with inputs/outputs (B, B') . For example:

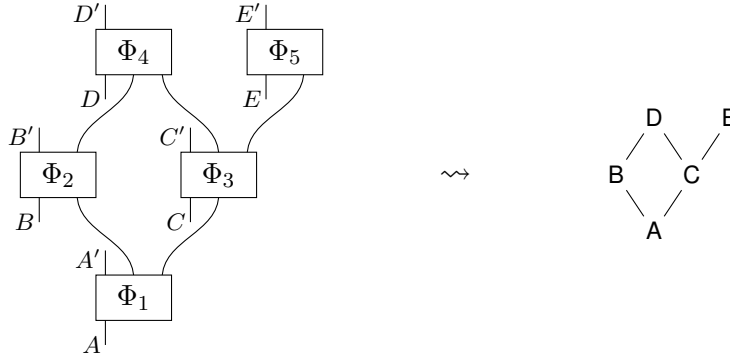

It was shown in [26] that all acyclic diagrams in a category \mathcal{C} respect their associated causal ordering if and only if all processes in \mathcal{C} satisfy the causality equation (2.9).

In the coming sections, we will show that consistency with a causal ordering can be expressed within the logic of a higher-order causal category. As a consequence, higher-order constraints such as *preserving* processes which are consistent with a causal ordering can also be expressed.

3. PRECAUSAL CATEGORIES

Precausal categories give a universe of all processes, and provide enough structure for us to identify which of those processes satisfy first-order and higher-order causality constraints. They are defined as compact closed categories satisfying four extra axioms, which involve discarding and its transpose:

$$\underline{\underline{A}} := \bigcup_A \overline{\overline{A^*}} \tag{3.1}$$

which we call the (unnormalised) *uniform state*.

Definition 3.1. A *precausal category* is a compact closed category \mathcal{C} such that:

(C1) \mathcal{C} has discarding processes for every system, compatible with the monoidal structure as in (2.8).

(C2) For every (non-zero) system A , the *dimension* of A :

$$d_A := \underline{\underline{\downarrow}} A$$

is an invertible scalar.

(C3) \mathcal{C} has *enough causal states*:

$$\left(\forall \rho \text{ causal . } \begin{array}{c} \boxed{f} \\ \downarrow \rho \end{array} = \begin{array}{c} \boxed{g} \\ \downarrow \rho \end{array} \right) \implies \begin{array}{c} \boxed{f} \\ \downarrow \end{array} = \begin{array}{c} \boxed{g} \\ \downarrow \end{array}$$

(C4) *Second-order causal processes factorise*:

$$\left(\forall \Phi \text{ causal . } \begin{array}{c} \underline{\underline{\downarrow}} \\ \boxed{w} \\ \boxed{\Phi} \\ \underline{\underline{\downarrow}} \end{array} = \underline{\underline{\downarrow}} \right) \implies \left(\exists \Phi_1, \Phi_2 \text{ causal . } \begin{array}{c} \boxed{w} \\ \boxed{\Phi_2} \\ \boxed{\Phi_1} \\ \downarrow \end{array} \right)$$

(C1) enables one to talk about causal processes within \mathcal{C} . (C2) enables us to renormalise certain processes to produce causal ones. For example, every non-zero system has at least one causal state, called the *uniform state*. It is obtained by normalising (3.1):

$$\underline{\underline{\downarrow}} A := d_A^{-1} \underline{\underline{\downarrow}} A$$

Then:

$$\underline{\underline{\downarrow}} A = d_A^{-1} \underline{\underline{\downarrow}} A = d_A^{-1} d_A = 1 \quad (3.2)$$

Remark 3.2. Note that by ‘non-zero’ in (C2), we mean ‘not a zero object’. For our examples, it will be convenient to allow \mathcal{C} to have a zero object (e.g. the natural number 0 in $\mathbf{Mat}(\mathbb{R}_+)$ and the zero-dimensional Hilbert space in \mathbf{CPM}), in which case $d_0 = 0$ is certainly not invertible.

(C3) says that processes are characterised by their behaviour on causal states. In the following proposition, we will show that (C3) implies that it suffices to consider only product states to identify a process.

Proposition 3.3. For any compact closed category \mathcal{C} , (C3) is equivalent to:

$$\left(\forall \rho_1, \rho_2 \text{ causal . } \begin{array}{c} \boxed{\Phi} \\ \downarrow \rho_1 \quad \downarrow \rho_2 \end{array} = \begin{array}{c} \boxed{\Phi'} \\ \downarrow \rho_1 \quad \downarrow \rho_2 \end{array} \right) \implies \begin{array}{c} \boxed{\Phi} \\ \downarrow \end{array} = \begin{array}{c} \boxed{\Phi'} \\ \downarrow \end{array} \quad (3.3)$$

Proof. (C3) follows from (3.3) by taking one of the two systems involved to be trivial. Conversely, assume the premise of (3.3). Applying (C3) one time yields:

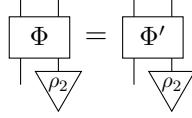

for all causal states ρ_2 . Bending the wire yields:

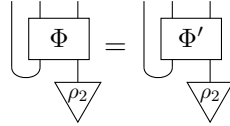

Hence we can apply (C3) a second time. Bending the wire back down gives the result. \square

(C4) is perhaps the least transparent. It says that the only mappings from causal processes to causal processes are ‘circuits with holes’, i.e., those mappings which arise from plugging a causal process into a larger circuit of causal processes. This can equivalently be split into two smaller pieces, which will be helpful in showing $\mathbf{Mat}(\mathbb{R}_+)$ and \mathbf{CPM} form examples of precausal categories.

Proposition 3.4. For a compact closed category \mathcal{C} satisfying (C1), (C2), and (C3), condition (C4) is equivalent to the following two conditions:

(C4') Causal *one-way signalling* processes factorise:

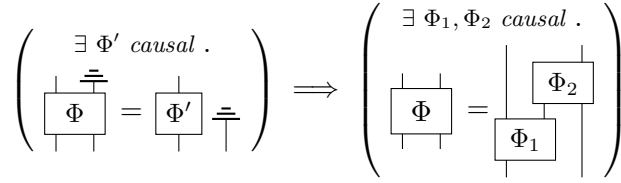

(C5') For all $w : A \otimes B^*$:

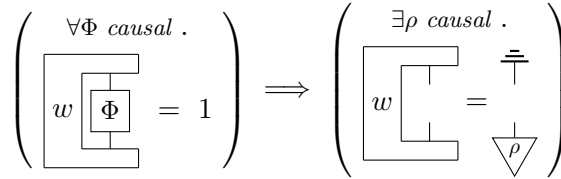

Proof. Assume (C4) holds, and let Φ satisfy the premise of (C4'). Then, for causal Ψ , we have:

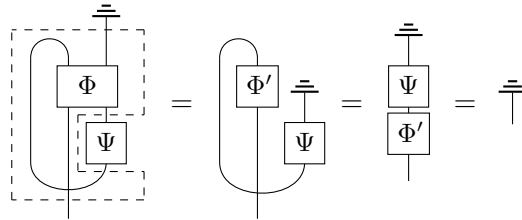

Hence, by (C4) there exist causal Φ'_1, Φ_2 such that:

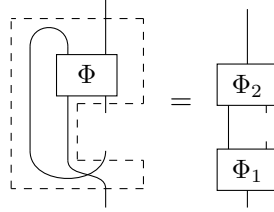

Deforming then gives the factorisation in (C4').

To get to (C5') from (C4), we take the input and output systems of w trivial, which gives:

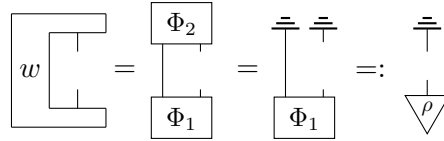

where the second '=' follows from the fact that discarding is the unique causal effect. Conversely, suppose (C4') and (C5') hold. Let w be a second order causal process. Then, for any causal ρ and Φ :

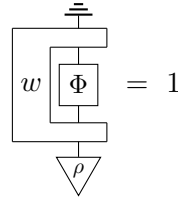

So, by (C5'):

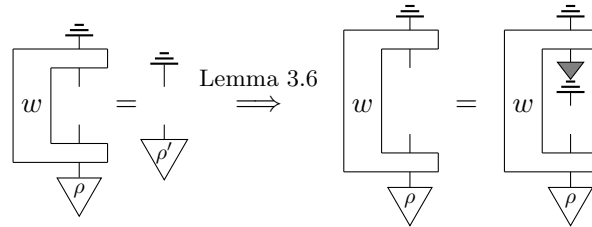

Then, by (C3):

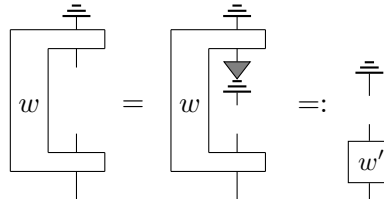

Hence w satisfies the premise of (C4'), up to diagram deformation, where $\Phi := w$ and $\Phi' := w'$, which implies that it factors as in (C4). \square

Remark 3.5. Whereas axiom (C5') is just the restriction of (C4) to a special case, (C4') is an abstract version of a familiar result about quantum channels. In the literature, one-way signalling is sometimes called *semi-causal*, whereas the factorisation of Φ into processes Φ_1, Φ_2 in (C4') is referred to a *semi-localisable*. Whereas it is immediately clear that semi-localisable implies semi-causal, the converse, i.e. condition (C4'), is non-trivial. It was conjectured for

for some one way signalling process Φ' with $A_1 \preceq \dots \preceq A_{n-1}$, we have by (C4') that there exists Φ'_{n-1} and Φ_n such that

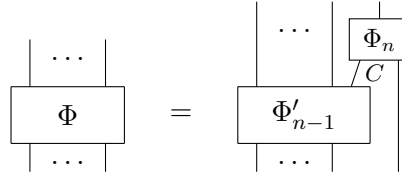

It follows that Φ' equals Φ'_{n-1} with the C system discarded, so that $\Phi'_{n-1} : A_1 \otimes \dots \otimes A_{n-1} \rightarrow A'_1 \otimes \dots \otimes (A'_{n-1} \otimes C)$ is again one-way signalling. By assumption Φ'_{n-1} now factors and hence so does Φ . \square

While, as we shall soon see, precausal categories give us a source of processes exhibiting many varieties of definite and indefinite causal structure, the axioms rule out certain, paradoxical causal structures. To see this, we state our first no-go result for a precausal category \mathcal{C} .

Theorem 3.10 (No time-travel). No non-trivial system A in a precausal category \mathcal{C} admits *time travel*. That is, if there exist systems B and C such that for all processes Φ we have:

$$\begin{array}{c} A \\ | \\ \boxed{\Phi} \\ | \\ A \end{array} \begin{array}{c} C \\ | \\ \\ \\ B \end{array} \text{ causal} \implies A \begin{array}{c} \text{---} \\ | \\ \boxed{\Phi} \\ | \\ B \end{array} \begin{array}{c} C \\ | \\ \\ \\ B \end{array} \text{ causal} \tag{3.4}$$

then $A \cong I$.

Proof. For any causal process $\Psi : A \rightarrow A$, we can define:

$$\begin{array}{c} A \\ | \\ \boxed{\Phi} \\ | \\ A \end{array} \begin{array}{c} C \\ | \\ \\ \\ B \end{array} := \begin{array}{c} A \\ | \\ \boxed{\Psi} \\ | \\ A \end{array} \begin{array}{c} C \\ | \\ \blacktriangledown \\ | \\ B \end{array}$$

which is also a causal process. Then implication (3.4) gives:

$$A \begin{array}{c} \text{---} \\ | \\ \boxed{\Psi} \\ | \\ A \end{array} = A \begin{array}{c} \text{---} \\ | \\ \boxed{\Phi} \\ | \\ B \end{array} \begin{array}{c} \text{---} \\ | \\ C \\ | \\ \blacktriangledown \\ | \\ B \end{array} = \text{---} \begin{array}{c} \text{---} \\ | \\ B \\ | \\ \blacktriangledown \end{array} = 1$$

Applying (C5'), we have:

$$\begin{array}{c} \text{---} \\ | \\ \boxed{\Psi} \\ | \\ A \end{array} = \text{---} \begin{array}{c} \text{---} \\ | \\ A \\ | \\ \blacktriangledown \\ | \\ \rho \end{array} \implies \begin{array}{c} \text{---} \\ | \\ A \\ | \\ \blacktriangledown \\ | \\ \rho \end{array} = \begin{array}{c} \text{---} \\ | \\ A \\ | \\ \blacktriangledown \\ | \\ \rho \end{array}$$

for some causal state $\rho : I \rightarrow A$. That is, $\rho \circ \text{---} = 1_A$, and by definition of causality for ρ , $\text{---} \circ \rho = 1_I$. \square

Note that a special case of Theorem 3.10 implies that if for all causal processes $\Phi : A \rightarrow A$ we have

$$A \begin{array}{c} \updownarrow \\ \boxed{\Phi} \\ \updownarrow \end{array} = 1$$

then $A \cong I$.

4. CONSTRUCTING CAUS[\mathcal{C}]

We will now describe our main construction, the category $\text{Caus}[\mathcal{C}]$ of higher-order causal processes for a precausal category \mathcal{C} . To motivate this construction, we begin by looking at the properties of the set of causal states for some system A :

$$\left\{ \rho : A \mid \begin{array}{c} \overline{\overline{\overline{\rho}}} \\ \downarrow \\ \rho \end{array} = 1 \right\} \subseteq \mathcal{C}(I, A) \quad (4.1)$$

In the classical and quantum cases, these form convex subsets of real vector spaces (probability distributions in \mathbb{R}^n and density matrices in SA_n , the self adjoint $n \times n$ operators, respectively). We would like to recapture the fact that this set is suitably closed without referring to convexity, so we appeal to duals instead.

Definition 4.1. For any set of states $c \subseteq \mathcal{C}(I, A)$, we can define the dual set $c^* \subseteq \mathcal{C}(I, A^*)$ as follows:

$$c^* := \left\{ \pi : A^* \mid \forall \rho \in c. \begin{array}{c} \triangle \pi \\ \updownarrow \\ \rho \end{array} = 1 \right\}$$

Taking the dual again, we get back to a set of states in A . It immediately follows from the definition that $c \subseteq c^{**}$. For the set of all causal states (4.1), we see that furthermore $c = c^{**}$. Assuming this property, which we call *closure*, for all objects will play an important role in obtaining $*$ -autonomous structure in $\text{Caus}[\mathcal{C}]$.

However, this property alone only refers to the compact closed structure of \mathcal{C} and not the precausal structure. By definition, the discarding process is contained in the dual c^* of the set of all causal states. We also showed in equation (3.2) that the transpose of discarding is contained in the set of causal states, up to a scalar (namely d_A^{-1}). Generalising this to a property that is symmetric in the roles of c and c^* , we obtain the notion of *flatness*.

Definition 4.2. A set of states $c \subseteq \mathcal{C}(I, A)$ is *closed* if $c = c^{**}$ and *flat* if there exist invertible scalars λ, μ such that:

$$\lambda \begin{array}{c} \perp \\ \overline{\overline{\overline{\perp}}} \end{array} \in c \quad \mu \begin{array}{c} \overline{\overline{\overline{\perp}}} \\ \perp \end{array} \in c^*$$

As we have already noted, the set of all causal states is closed and flat. Many other sets turn out to be closed and flat, including the sets of causal processes and higher-order generalisations thereof. We now use these two properties to define a category which incorporates all of these higher-order types.

Definition 4.3. For a precausal category \mathcal{C} , the category $\text{Caus}[\mathcal{C}]$ has as objects pairs:

$$\mathbf{A} := (A, c_A \subseteq \mathcal{C}(I, A))$$

where c_A is closed and flat. A morphism $f : \mathbf{A} \rightarrow \mathbf{B}$ is a morphism $f : A \rightarrow B$ in \mathcal{C} such that:

$$\rho \in c_A \implies f \circ \rho \in c_B \quad (4.2)$$

We refer to categories of the form $\text{Caus}[\mathcal{C}]$ for some precausal category \mathcal{C} as *higher-order causal categories* (HOCCs).

While condition (4.2) is given in terms of states, closure allows us to equivalently present it in terms of effects or numbers:

Proposition 4.4. For objects \mathbf{A}, \mathbf{B} in $\text{Caus}[\mathcal{C}]$ and a morphism $f : A \rightarrow B$ in \mathcal{C} , the following are equivalent:

- (i) $\rho \in c_{\mathbf{A}} \implies f \circ \rho \in c_{\mathbf{B}}$
- (ii) $\pi \in c_{\mathbf{B}}^* \implies \pi \circ f \in c_{\mathbf{A}}^*$
- (iii) $\rho \in c_{\mathbf{A}}, \pi \in c_{\mathbf{B}}^* \implies \pi \circ f \circ \rho = 1$

Proof. (i) \implies (ii) and (ii) \implies (iii) follow immediately from the definition of $(-)^*$, so assume (iii) and take any $\rho \in c_{\mathbf{A}}$. Then for all $\pi \in c_{\mathbf{B}}^*$, $\pi \circ (f \circ \rho) = 1$. Hence $f \circ \rho \in c_{\mathbf{B}}^{**} = c_{\mathbf{B}}$. \square

Since a set of states is closed when $c = c^{**}$, it is natural to ask if $(-)^{**}$ forms a closure operation, namely if it is idempotent. This is an immediate result of the following:

Lemma 4.5. For any set of states c we have $c^* = c^{***}$.

Proof. First, note that:

$$c \subseteq d \implies d^* \subseteq c^*.$$

Applying this to $c \subseteq c^{**}$ yields $c^{***} \subseteq c^*$. But then, it is already the case that c^* is contained in c^{***} , so $c^{***} = c^*$. \square

We will now show that $\text{Caus}[\mathcal{C}]$ has the structure of a $*$ -autonomous category. To do this, we will first define the tensor $\mathbf{A} \otimes \mathbf{B}$. For the sets of states $c_{\mathbf{A}}$ and $c_{\mathbf{B}}$, we denote the set of all product states as follows:

$$c_{\mathbf{A}} \otimes c_{\mathbf{B}} := \{\rho_1 \otimes \rho_2 \mid \rho_1 \in c_{\mathbf{A}}, \rho_2 \in c_{\mathbf{B}}\}$$

Then, $c_{\mathbf{A} \otimes \mathbf{B}}$ is the closure of the set of all product states:

$$c_{\mathbf{A} \otimes \mathbf{B}} := (c_{\mathbf{A}} \otimes c_{\mathbf{B}})^{**}$$

Lemma 4.6. For any effect $\pi : A^* \otimes B^*$ in \mathcal{C} :

$$\left(\begin{array}{c} \forall \rho \in c_{\mathbf{A} \otimes \mathbf{B}} . \\ \begin{array}{c} \triangle \\ \pi \\ \hline \rho \\ \triangle \end{array} = 1 \end{array} \right) \iff \left(\begin{array}{c} \forall \rho_1 \in c_{\mathbf{A}}, \rho_2 \in c_{\mathbf{B}} . \\ \begin{array}{c} \triangle \\ \pi \\ \hline \begin{array}{cc} \triangle & \triangle \\ \rho_1 & \rho_2 \end{array} \\ \triangle \end{array} = 1 \end{array} \right) \quad (4.3)$$

Proof. The LHS of (4.3) states that

$$\pi \in c_{\mathbf{A} \otimes \mathbf{B}}^* := ((c_{\mathbf{A}} \otimes c_{\mathbf{B}})^{**})^* = (c_{\mathbf{A}} \otimes c_{\mathbf{B}})^{***}$$

whereas the RHS states that $\pi \in (c_{\mathbf{A}} \otimes c_{\mathbf{B}})^*$. Hence, (4.3) follows from Lemma 4.5. \square

Theorem 4.7. $\text{Caus}[\mathcal{C}]$ is an SMC, with tensor given by:

$$\mathbf{A} \otimes \mathbf{B} := (A \otimes B, c_{\mathbf{A} \otimes \mathbf{B}})$$

and tensor unit $\mathbf{I} := (I, \{1\})$.

Proof. The proof is in the appendix. \square

Now define objects $\mathbf{A}^* := (A^*, c_{\mathbf{A}^*})$ in the obvious way, by letting $c_{\mathbf{A}^*} := c_{\mathbf{A}}^*$. Then

Lemma 4.8. The transposition functor $(-)^* : \mathcal{C}^{\text{op}} \rightarrow \mathcal{C}$:

$$A \mapsto A^* \quad \begin{array}{c} |B \\ \boxed{f} \\ |A \end{array} \mapsto \begin{array}{c} |A^* \\ \boxed{f^*} \\ |B^* \end{array} := \begin{array}{c} |A^* \\ \boxed{f} \\ |B^* \end{array} \quad (4.4)$$

lifts to a full and faithful functor $(-)^* : \text{Caus}[\mathcal{C}]^{\text{op}} \rightarrow \text{Caus}[\mathcal{C}]$, where $\mathbf{A}^* := (A^*, c_{A^*})$.

Proof. The main part is showing that f^* is again a morphism, but this follows from the definition of the star on sets of states. A full proof is in the appendix. \square

We now have enough structure to define $\mathbf{A} \multimap \mathbf{B} := (\mathbf{A} \otimes \mathbf{B}^*)^*$. However, it is enlightening to give an explicit characterisation of the set $c_{\mathbf{A} \multimap \mathbf{B}}$. This will be no surprise:

Lemma 4.9. For objects $\mathbf{A}, \mathbf{B} \in \text{Caus}[\mathcal{C}]$:

$$c_{\mathbf{A} \multimap \mathbf{B}} = \left\{ f : A^* \otimes B \mid \forall \rho \in c_{\mathbf{A}}, \pi \in c_{\mathbf{B}}^* . \begin{array}{c} \triangle \pi \\ | \\ \boxed{f} \\ | \\ \triangle \rho \end{array} = 1 \right\}$$

Proof. This follows by simplifying:

$$c_{(\mathbf{A} \otimes \mathbf{B}^*)^*} = c_{(\mathbf{A} \otimes \mathbf{B}^*)}^* = (c_{\mathbf{A}} \otimes c_{\mathbf{B}^*})^{***} = (c_{\mathbf{A}} \otimes c_{\mathbf{B}}^*)^*$$

and noting that $f \in (c_{\mathbf{A}} \otimes c_{\mathbf{B}}^*)^*$ is precisely the statement given in the lemma. \square

Theorem 4.10. For any precausal category \mathcal{C} , $\text{Caus}[\mathcal{C}]$ is a $*$ -autonomous category where $\mathbf{I} = \mathbf{I}^*$.

Proof. Since compact closed categories already admit an interpretation for \multimap satisfying (2.4), it suffices to show that this isomorphism lifts to $\text{Caus}[\mathcal{C}]$. This follows from the application of Lemma 4.6. The complete proof is in the appendix. \square

Since $\text{Caus}[\mathcal{C}]$ is $*$ -autonomous, we can also define the ‘par’ of two systems $\mathbf{A} \wp \mathbf{B}$. Since \wp is related to \multimap via $\mathbf{A} \wp \mathbf{B} \cong \mathbf{A}^* \multimap \mathbf{B}$, Lemma 4.9 also yields an explicit form for $c_{\mathbf{A} \wp \mathbf{B}}$ by replacing \mathbf{A} with \mathbf{A}^* :

$$c_{\mathbf{A} \wp \mathbf{B}} = \left\{ \rho : A \otimes B \mid \forall \pi \in c_{\mathbf{A}}^*, \xi \in c_{\mathbf{B}}^* . \begin{array}{c} \triangle \pi \quad \triangle \xi \\ | \quad | \\ \rho \end{array} = 1 \right\}$$

Note that the process $f : A^* \otimes B$ has become a bipartite state $\rho : A \otimes B$. That is, the states $\rho : \mathbf{A} \wp \mathbf{B}$ are states which are normalised for all product effects. Symbolically, the two monoidal products are defined as follows:

$$c_{\mathbf{A} \otimes \mathbf{B}} = (c_{\mathbf{A}} \otimes c_{\mathbf{B}})^{**} \quad c_{\mathbf{A} \wp \mathbf{B}} = (c_{\mathbf{A}}^* \otimes c_{\mathbf{B}}^*)^*$$

One can easily check that $(c_{\mathbf{A}}^* \otimes c_{\mathbf{B}}^*) \subseteq (c_{\mathbf{A}} \otimes c_{\mathbf{B}})^*$. Thus, since $(-)^*$ reverses subset inclusions, that $c_{\mathbf{A} \otimes \mathbf{B}} \subseteq c_{\mathbf{A} \wp \mathbf{B}}$. Consequently, the identity $1_{\mathbf{A} \otimes \mathbf{B}}$ in \mathcal{C} lifts to a canonical embedding $\mathbf{A} \otimes \mathbf{B} \hookrightarrow \mathbf{A} \wp \mathbf{B}$ in $\text{Caus}[\mathcal{C}]$. This agrees with the intuition given in Section 3 that $\mathbf{A} \wp \mathbf{B}$ is the ‘larger’ of the two ways to combine A and B into a joint system.

Remark 4.11. A $*$ -autonomous category with coherent isomorphism $I \cong I^*$, such as $\text{Caus}[\mathcal{C}]$, is also called an ISOMIX category [10]. This innocent-looking extra condition actually gives a great deal more structure. For instance, even though we showed it concretely, the existence of a canonical morphism $A \otimes B \rightarrow A \wp B$ is implied purely from this extra structure.

Rather than thinking of $\text{Caus}[\mathcal{C}]$ as a totally new category constructed from \mathcal{C} , it is useful to think of it as endowing the processes in \mathcal{C} with a much richer type system. As in the compact closed case, it suffices to consider only processes out of \mathbf{I} and we use $\rho : \mathbf{X}$ as shorthand for $\rho : \mathbf{I} \rightarrow \mathbf{X}$. However, unlike before, we will often use a statement of the form $\rho : \mathbf{X}$ as a *proposition* about a state $\rho \in \mathcal{C}(I, X)$.

Proposition 4.12. For a system $\mathbf{X} = (X, c_{\mathbf{X}})$ in $\text{Caus}[\mathcal{C}]$ and a state $\rho \in \mathcal{C}(I, X)$, $\rho : \mathbf{X}$ if and only if $\rho \in c_{\mathbf{X}}$.

Proof. Since 1 is the unique state in $c_{\mathbf{I}}$, the result follows immediately from the definition of morphism in $\text{Caus}[\mathcal{C}]$:

$$\rho : \mathbf{X} \iff \rho \circ 1 \in c_{\mathbf{X}} \iff \rho \in c_{\mathbf{X}} \quad \square$$

From now on, we will use $\rho : \mathbf{X}$ and $\rho \in c_{\mathbf{X}}$ interchangeably without further comment. We will also mix the graphical notation with the type-theoretic. So, for instance, if we write:

$$: \mathbf{A} \multimap (\mathbf{B} \multimap \mathbf{C}) \multimap \mathbf{D}$$

this should be interpreted as a morphism in $\mathcal{C}(I, A^* \otimes B \otimes C^* \otimes D)$, along with the assertion that this morphism has type $\mathbf{A} \multimap (\mathbf{B} \multimap \mathbf{C}) \multimap \mathbf{D}$. In particular, diagrams always depict \mathcal{C} -morphisms, as opposed to $\text{Caus}[\mathcal{C}]$ -morphisms, so there is no ambiguity about whether parallel composition means \otimes or \wp .

Furthermore, if we state that two types are isomorphic without giving the isomorphism explicitly, it should be understood that the underlying isomorphism in \mathcal{C} is just the identity, up to a possible permutation of systems. In particular, $\mathbf{X} \cong \mathbf{Y}$ implies that $\rho : \mathbf{X}$ if and only if $\rho : \mathbf{Y}$.

5. FIRST ORDER SYSTEMS

For any precausal category \mathcal{C} , we can always form the SMC of (first-order) causal processes \mathcal{C}_c by restricting just to those processes satisfying the causality equation (2.9). Since $\text{Caus}[\mathcal{C}]$ is supposed to contain first and higher-order causal processes, one would naturally expect \mathcal{C}_c to embed in $\text{Caus}[\mathcal{C}]$.

Definition 5.1. A system $\mathbf{A} = (A, c_{\mathbf{A}})$ in $\text{Caus}[\mathcal{C}]$ is called *first order* if it is of the form $(A, \{\bar{\top}_A\}^*)$.

Note that $\{\ddot{\tau}_A\}^*$ is precisely the set (4.1) of causal states of type A . Clearly this set is flat and closed. Indeed, this was the motivation for these conditions in the first place. Now, we show that the processes between first-order systems in $\text{Caus}[\mathcal{C}]$ are exactly as expected.

Proposition 5.2. Let \mathbf{A}, \mathbf{B} be first-order systems. Then f is a morphism from \mathbf{A} to \mathbf{B} if and only if it is causal.

Proof. We first compute $c_{\mathbf{A}}^*$ for a first-order system. Suppose $\pi \in c_{\mathbf{A}}^*$. Then for all causal states ρ , $\pi \circ \rho = 1 = \ddot{\tau}_A \circ \rho$, so by (C3) $\pi = \ddot{\tau}_A$. Hence $c_{\mathbf{A}}^* = \{\ddot{\tau}_A\}$.

Now, by Proposition 4.4, $\Phi \in \mathcal{C}(A, B)$ is a morphism from \mathbf{A} to \mathbf{B} if and only if for every $\pi \in c_{\mathbf{B}}^*$, $\pi \circ \Phi \in c_{\mathbf{A}}^*$. Since both of these sets of effects only contain discarding, this reduces to the causality equation (2.9). \square

Furthermore, first-order systems are closed under \otimes .

Proposition 5.3. For first order systems \mathbf{A}, \mathbf{B} , $\mathbf{A} \otimes \mathbf{B}$ is also a first-order system, given by:

$$\mathbf{A} \otimes \mathbf{B} = (A \otimes B, \{\ddot{\tau}_A \ddot{\tau}_B\}^*)$$

Proof. It suffices to show that $c_{\mathbf{A} \otimes \mathbf{B}}^* = \{\ddot{\tau}_A \ddot{\tau}_B\}$. Let $\pi \in c_{\mathbf{A} \otimes \mathbf{B}}^*$, then for all causal states $\rho_1 \in c_{\mathbf{A}}, \rho_2 \in c_{\mathbf{B}}$:

$$\begin{array}{c} \triangle \\ \pi \\ \hline \begin{array}{cc} \rho_1 & \rho_2 \end{array} \end{array} = 1$$

Hence, by Proposition 3.3, $\pi = \ddot{\tau}_A \ddot{\tau}_B$. \square

Corollary 5.4. There exists a full, faithful, monoidal embedding of the category \mathcal{C}_c of causal processes into $\text{Caus}[\mathcal{C}]$ via:

$$A \mapsto (A, \{\ddot{\tau}_A\}^*) \quad f \mapsto f$$

Hence, the full sub-category of first-order systems and processes behaves as expected; it is equivalent to \mathcal{C}_c . Perhaps a more surprising corollary to Proposition 5.3 is the following.

Corollary 5.5. Let \mathbf{A} and \mathbf{B} be first order systems, then:

$$\mathbf{A} \otimes \mathbf{B} \cong \mathbf{A} \wp \mathbf{B}$$

Proof. $c_{\mathbf{A} \wp \mathbf{B}} := (c_{\mathbf{A}}^* \otimes c_{\mathbf{B}}^*)^* = \{\ddot{\tau}_A \ddot{\tau}_B\}^* = c_{\mathbf{A} \otimes \mathbf{B}}^*$. \square

So for first-order systems, there is really only one way to form the ‘joint system’. However, we will now see that for higher-order systems, this is very much not the case.

6. HIGHER-ORDER SYSTEMS WITH DEFINITE CAUSAL ORDER

While it is important that the category of causal processes embeds fully and faithfully in $\text{Caus}[\mathcal{C}]$ when one restricts to first-order systems, the chief interest of $\text{Caus}[\mathcal{C}]$ are its higher-order systems. The goal of this section is to show that certain collections of maps fit nicely within the developed type theory.

The first non-trivial second-order system that it is natural to consider is $\mathbf{A} \multimap \mathbf{B}$ for first-order systems \mathbf{A}, \mathbf{B} . The isomorphism (2.4) for $*$ -autonomous categories restricts to:

$$\text{Caus}[\mathcal{C}](\mathbf{A}, \mathbf{B}) \cong \text{Caus}[\mathcal{C}](\mathbf{I}, \mathbf{A} \multimap \mathbf{B})$$

$$\begin{array}{c} \overline{\overline{A'}} \\ \overline{\overline{B'}} \\ \hline \Phi \\ \hline A \quad B \end{array} : (\mathbf{A} \multimap \mathbf{A}') \otimes (\mathbf{B} \multimap \mathbf{I})$$

Then we can transform to an equivalent type as follows:

$$\begin{aligned} (\mathbf{A} \multimap \mathbf{A}') \otimes (\mathbf{B} \multimap \mathbf{I}) &\cong (\mathbf{A} \multimap \mathbf{A}') \otimes \mathbf{B}^* \\ &\cong ((\mathbf{A} \multimap \mathbf{A}')^* \wp \mathbf{B})^* \\ &\cong ((\mathbf{A} \multimap \mathbf{A}') \multimap \mathbf{B})^* \end{aligned}$$

Hence, by Lemma 6.1, Φ splits as $\overline{\overline{\uparrow}}_B : \mathbf{B}$ and $\Phi' : \mathbf{A} \multimap \mathbf{A}'$. This gives exactly the first non-signalling equation:

$$\begin{array}{c} \overline{\overline{A'}} \\ \overline{\overline{B'}} \\ \hline \Phi \\ \hline A \quad B \end{array} = \begin{array}{c} \overline{\overline{A'}} \\ \hline \Phi' \\ \hline A \end{array} \overline{\overline{\uparrow}}_B$$

The second equation is shown similarly, by plugging in $\overline{\overline{\uparrow}}_{A'}$.

Conversely, suppose that Φ is causal and non-signalling. Then it satisfies the two non-signalling equations in Definition 2.9. Hence by (C4'), it can be factored in two ways:

$$\begin{array}{c} \Phi \\ \hline \hline \end{array} = \begin{array}{c} \Phi_2 \\ \hline \Phi_1 \\ \hline \hline \end{array} = \begin{array}{c} \Psi_2 \\ \hline \Psi_1 \\ \hline \hline \end{array}$$

for causal processes Φ_i, Ψ_i .

Now, take any effect $w : ((\mathbf{A} \multimap \mathbf{A}') \otimes (\mathbf{B} \multimap \mathbf{B}'))^* \cong (\mathbf{B} \multimap \mathbf{B}') \multimap (\mathbf{A} \multimap \mathbf{A}')^*$. For any causal state ρ ,

$$\begin{array}{c} \Phi_2 \\ \hline \rho \\ \hline \end{array} : \mathbf{B} \multimap \mathbf{B}'$$

Plugging this into one side of w gives:

$$\begin{array}{c} \hline w \\ \hline \hline \Phi_2 \\ \hline \rho \\ \hline \hline \end{array} : (\mathbf{A} \multimap \mathbf{A}')^*$$

Applying equation (6.2) gives:

$$\begin{array}{c} \hline w \\ \hline \hline \Phi_2 \\ \hline \rho \\ \hline \hline \end{array} = \begin{array}{c} \hline w \\ \hline \hline \hline \Phi_2 \\ \hline \rho \\ \hline \hline \end{array}$$

Hence by enough causal states we have

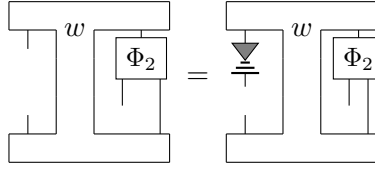

It then follows that

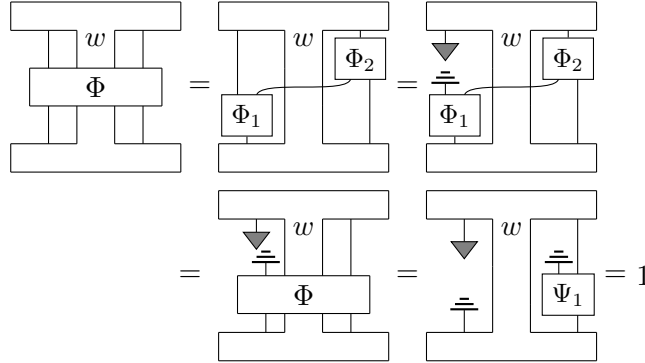

Therefore $\Phi : ((\mathbf{A} \multimap \mathbf{A}') \otimes (\mathbf{B} \multimap \mathbf{B}'))^{**} = (\mathbf{A} \multimap \mathbf{A}') \otimes (\mathbf{B} \multimap \mathbf{B}')$. \square

The proof above also generalises straightforwardly to show that a process is n -paritite non-signalling, i.e., for all i :

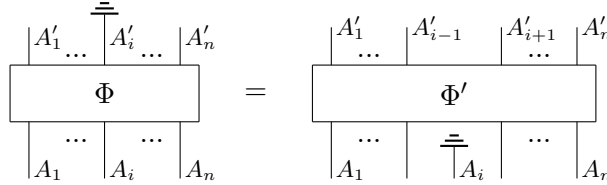

if and only if:

$$\Phi : (\mathbf{A}_1 \multimap \mathbf{A}'_1) \otimes (\mathbf{A}_2 \multimap \mathbf{A}'_2) \otimes \dots \otimes (\mathbf{A}_n \multimap \mathbf{A}'_n)$$

Theorem 6.3. For first-order systems $\mathbf{A}, \mathbf{A}', \mathbf{B}, \mathbf{B}'$, a process Φ is of type $(\mathbf{A} \multimap \mathbf{A}') \wp (\mathbf{B} \multimap \mathbf{B}')$ if and only if it is causal. That is:

$$(\mathbf{A} \multimap \mathbf{A}') \wp (\mathbf{B} \multimap \mathbf{B}') \cong \mathbf{A} \otimes \mathbf{B} \multimap \mathbf{A}' \otimes \mathbf{B}'$$

Proof. We rely on the relationship between \multimap and \wp :

$$\begin{aligned} (\mathbf{A} \multimap \mathbf{A}') \wp (\mathbf{B} \multimap \mathbf{B}') &\cong \mathbf{A}^* \wp \mathbf{A}' \wp \mathbf{B}^* \wp \mathbf{B}' \\ &\cong \mathbf{A}^* \wp \mathbf{B}^* \wp \mathbf{A}' \wp \mathbf{B}' \\ &\cong (\mathbf{A}^* \wp \mathbf{B}^*)^* \multimap \mathbf{A}' \wp \mathbf{B}' \\ &\cong \mathbf{A} \otimes \mathbf{B} \multimap \mathbf{A}' \wp \mathbf{B}' \end{aligned}$$

Then, since \mathbf{A}' and \mathbf{B}' are first-order, $\mathbf{A}' \wp \mathbf{B}' \cong \mathbf{A}' \otimes \mathbf{B}'$, which completes the proof. \square

So $(\mathbf{A} \multimap \mathbf{A}') \wp (\mathbf{B} \multimap \mathbf{B}')$ forms the joint system consisting of *all* causal processes from $\mathbf{A} \otimes \mathbf{B}$ to $\mathbf{A}' \otimes \mathbf{B}'$, including the signalling ones, e.g.

$$\begin{array}{c} \text{B} \\ \swarrow \quad \searrow \\ \text{A} \end{array} : (\mathbf{A} \multimap \mathbf{B}) \wp (\mathbf{B} \multimap \mathbf{A})$$

Hence, \otimes and \wp represent two extremes by which $A \multimap A'$ and $B \multimap B'$ can be combined, namely by requiring them to be non-signalling or imposing no non-signalling conditions. In the next section, we will see how to recover types that live in between these two extremes: the one-way signalling processes.

6.1. Linear causal orders via combs.

Theorem 6.4. For first order systems A, A', B, B' , a process w is one-way signalling ($A \preceq B$) if and only if:

$$\begin{array}{c} |A' \quad |B' \\ \boxed{w} \\ |A \quad |B \end{array} : A \multimap (A' \multimap B) \multimap B'$$

Proof. Suppose Φ is $A \preceq B$. First, we deform Φ to put the two A -labelled systems below the two B -labelled systems:

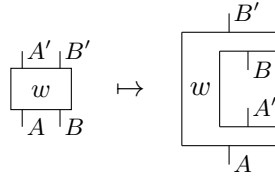

The one-way signalling equation (2.10) then becomes:

$$\begin{array}{c} \equiv \\ \boxed{w} \\ |A \end{array} \begin{array}{c} \equiv \\ |B' \\ \boxed{\Phi} \\ |B \\ \boxed{A'} \\ |A \end{array} = \begin{array}{c} \equiv \\ |B \\ \boxed{w'} \\ |A \end{array} \quad (6.3)$$

Now, by (2.7) we have:

$$A \multimap (A' \multimap B) \multimap B' \cong (A' \multimap B) \multimap A \multimap B'$$

So, for w to be a member of the above type, it must send all causal processes $\Psi : A' \multimap B$ to causal processes. This immediately follows from (6.3):

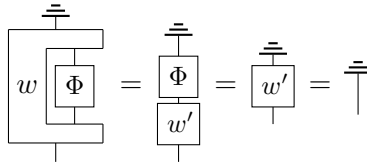

Conversely, if w sends causal processes to causal processes, it factorises as in (C4), which implies (6.3):

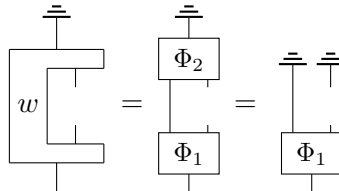

□

Hence, one-way signalling admits a more general class of processes than (two-way) non-signalling.

Remark 6.5. One can show the embedding of non-signalling processes into one-way signalling processes purely at the level of types by relying on the *linear distributivity* property of $*$ -autonomous categories [11]. Namely, in any $*$ -autonomous category, there exists a canonical mapping:

$$(\mathbf{X} \wp \mathbf{Y}) \otimes \mathbf{Z} \rightarrow \mathbf{X} \wp (\mathbf{Y} \otimes \mathbf{Z})$$

We can use this to construct an embedding of non-signalling processes into one-way signalling processes:

$$\begin{aligned} (\mathbf{A} \multimap \mathbf{A}') \otimes (\mathbf{B} \multimap \mathbf{B}') &\cong (\mathbf{A}^* \wp \mathbf{A}') \otimes (\mathbf{B}^* \wp \mathbf{B}') \\ &\rightarrow \mathbf{A}^* \wp (\mathbf{A}' \otimes (\mathbf{B}^* \wp \mathbf{B}')) \\ &\rightarrow \mathbf{A}^* \wp (\mathbf{A}' \otimes \mathbf{B}^*) \wp \mathbf{B}' \\ &\cong \mathbf{A} \multimap (\mathbf{A}' \multimap \mathbf{B}) \multimap \mathbf{B}' \end{aligned}$$

Similarly, we can use the embedding $\mathbf{X} \otimes \mathbf{Y} \rightarrow \mathbf{X} \wp \mathbf{Y}$ noted in section 4 to show that one-way signalling processes embed in the type $(\mathbf{A} \multimap \mathbf{A}') \wp (\mathbf{B} \multimap \mathbf{B}')$ of all processes.

$$\begin{aligned} \mathbf{A} \multimap (\mathbf{A}' \multimap \mathbf{B}) \multimap \mathbf{B}' &\cong \mathbf{A}^* \wp ((\mathbf{A}')^* \wp \mathbf{B})^* \wp \mathbf{B}' \\ &\cong \mathbf{A}^* \wp (\mathbf{A}' \otimes \mathbf{B}^*) \wp \mathbf{B}' \\ &\rightarrow \mathbf{A}^* \wp \mathbf{A}' \wp \mathbf{B}^* \wp \mathbf{B}' \\ &\cong (\mathbf{A} \multimap \mathbf{A}') \wp (\mathbf{B} \multimap \mathbf{B}') \end{aligned}$$

Following [34], we generalise from 2-party, one-way signalling processes to n -party processes by recursively defining the type of n -combs.

Definition 6.6. The n -combs C_n are defined by

- $C_0 = \mathbf{I}$,
- $C_{i+1} = \mathbf{B}_{-i} \multimap C_i \multimap \mathbf{B}_{i+1}$.

A 1-comb has type $\mathbf{B}_0 \multimap \mathbf{I} \multimap \mathbf{B}_1 \cong \mathbf{B}_0 \multimap \mathbf{B}_1$, so it is just a causal process. For higher combs, the ‘ $-i$ ’ is employed to maintain the left-to-right order of indices. For example, a 3-comb has type:

$$\begin{array}{c} \begin{array}{|c} \hline B_3 \\ \hline \end{array} \\ \left. \begin{array}{|c} \hline B_2 \\ \hline \end{array} \right\} \\ \left. \begin{array}{|c} \hline B_1 \\ \hline \end{array} \right\} \\ w \left. \begin{array}{|c} \hline B_0 \\ \hline \end{array} \right\} \\ \left. \begin{array}{|c} \hline B_{-1} \\ \hline \end{array} \right\} \\ \left. \begin{array}{|c} \hline B_{-2} \\ \hline \end{array} \right\} \end{array} : \mathbf{B}_{-2} \multimap (\mathbf{B}_{-1} \multimap (\mathbf{B}_0 \multimap \mathbf{B}_1) \multimap \mathbf{B}_2) \multimap \mathbf{B}_3$$

When necessary, we rename $\mathbf{A}_i := \mathbf{B}_{2i-n-1}$ and $\mathbf{A}'_i := \mathbf{B}_{2i-n}$ to obtain e.g.,

$$\mathbf{A}_1 \multimap (\mathbf{A}'_1 \multimap (\mathbf{A}_2 \multimap \mathbf{A}'_2) \multimap \mathbf{A}_3) \multimap \mathbf{A}'_3$$

This recursive definition carries the following intuition. If we think of an n comb as a communication protocol with n input/output steps, then an $(n+1)$ -comb is an $(n+1)$ step communication protocol, namely something which takes an initial input, then runs an

n -step communication protocol, and produces a final output. Hence, we can represent the overall process of two agents running a communication protocol by plugging together Alice's n -comb and Bob's $(n - 1)$ -comb:

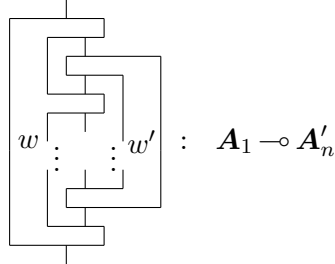

We give an alternative characterisation for combs in $\text{Caus}[\mathcal{C}]$, which will relate to one-way signalling processes.

Lemma 6.7. For any n -comb $w : C_n$, discarding the output A'_n separates as follows, for some w' :

Proof. Plugging any causal state into the first input of w and discarding the last output yields:

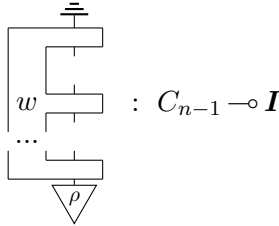

Then:

$$C_{n-1} \multimap \mathbf{I} \cong C_{n-1}^* \cong (\mathbf{B}_{-(n-2)} \multimap C_{n-2} \multimap \mathbf{B}_{n-1})^* \cong (\mathbf{B}_{-(n-2)} \otimes C_{n-2} \multimap \mathbf{B}_{n-1})^*$$

Hence by Lemma 6.1, in particular equation (6.2), we obtain:

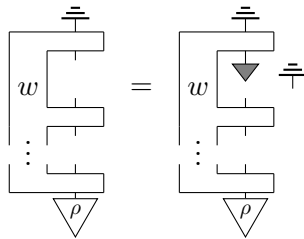

The result then follows from enough causal states. □

Note that we haven't actually said that w' is itself an $(n - 1)$ -comb. We will show this now.

Theorem 6.8. w is an n -comb, i.e., $w : C_n$, if and only if it separates as in equation (6.4) for some $w' : C_{n-1}$.

Proof. By induction. For $n = 1$ the theorem is true because a 0-comb is always I . Suppose the theorem is true for n . Let w be an $(n + 1)$ -comb. We need to show that w' is an n -comb. So let y be any $(n - 1)$ -comb. Then, if we form the process:



then clearly discarding the top output results in an $(n - 1)$ comb (namely y) and a discard. So by the induction hypotheses, (6.5) is an n -comb. Therefore we have

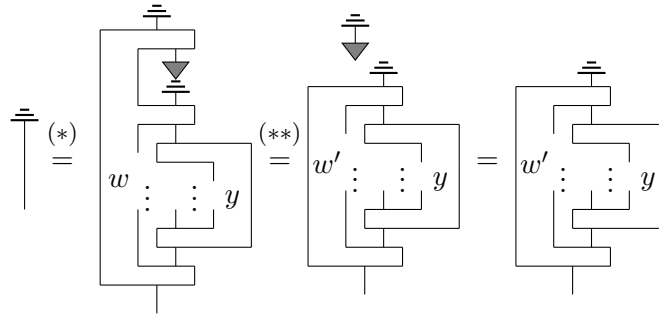

where $(*)$ follows from the definition of $(n + 1)$ -comb and $(**)$ is Lemma 6.7. Hence w' sends any $(n - 1)$ -comb to a causal map, so w' is itself an n -comb.

Conversely, let w' in equation (6.4) be an n -comb, and take any n -comb y . Then by the induction hypothesis, discarding the top output of y separates as discarding and an $(n - 1)$ -comb y' . Hence:

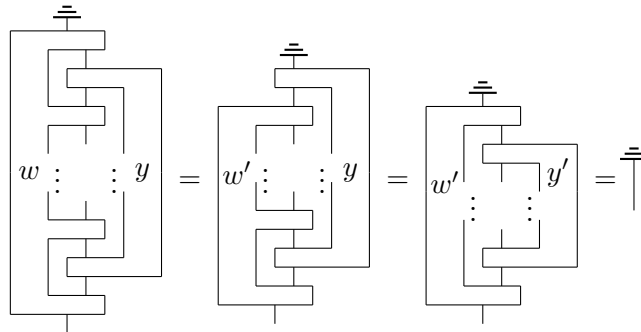

so w is an $(n + 1)$ -comb. □

Hence, n -combs can be characterised inductively in exactly the same way as n -party one-way signalling processes. Since 1-combs are just causal processes, the following is immediate.

Corollary 6.9. For first order systems $\mathbf{A}_1, \mathbf{A}'_1, \dots, \mathbf{A}_n, \mathbf{A}'_n$, a map $w : A_1 \otimes \dots \otimes A_n \rightarrow A'_1 \otimes \dots \otimes A'_n$ is one-way signalling ($\mathbf{A}_1 \preceq \dots \preceq \mathbf{A}_n$) if and only if it is of type $\mathbf{A}_1 \multimap (\mathbf{A}'_1 \multimap (\dots \multimap \mathbf{A}_n) \multimap \mathbf{A}'_n$). That is, it is an n -comb.

Stated in terms of consistency with causal orderings, as defined in section 2.3, the above corollary says that $\Phi : \mathbf{A}_1 \multimap (\mathbf{A}'_1 \multimap (\dots \multimap \mathbf{A}_n) \multimap \mathbf{A}'_n$ if and only if:

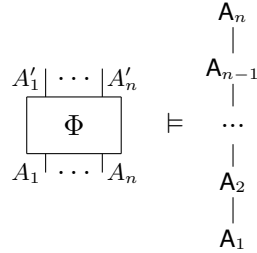

Proposition 3.9, then generalises the characterisation theorem for quantum combs in [6] to $\text{Caus}[\mathcal{C}]$ for any precausal \mathcal{C} : an n -comb always factors as a sequence of ‘memory channels’, i.e., a composition of causal processes of the form:

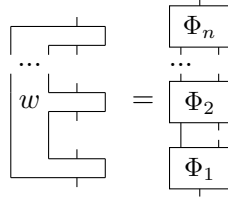

6.2. Directed acyclic causal orders via pullback.

We now extend from types which express consistency with arbitrary, linear causal orderings to all acyclic causal orderings. To do so, we first give a new characterisation of the consistency relation $\Phi \models \mathcal{O}$ defined in section 2.3 in terms of all of the total orders refining the partial order \mathcal{O} . Recall the following standard definition:

Definition 6.10. For a partial order \mathcal{O} , a *totalisation* \mathcal{O}' is a total order with the same elements as \mathcal{O} such that $e \preceq_{\mathcal{O}} e' \implies e \preceq_{\mathcal{O}'} e'$.

Totalisations are not unique. For example, a typical ‘common cause’ ordering admits two possible totalisations:

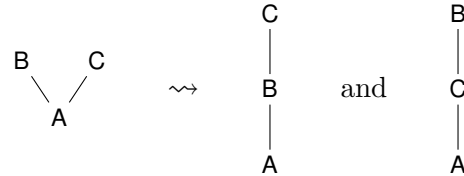

corresponding to imposing the (extraneous) causal orderings $\mathbf{B} \preceq \mathbf{C}$ or $\mathbf{C} \preceq \mathbf{B}$. Its important to note that causal constraints come from the *absence* of edges in the Hasse diagrams (i.e., diagrams to visualize a partial order) above, rather than the presence. That is, the absence of an edge between \mathbf{B} and \mathbf{C} in the leftmost diagram asserts the independence of the output of \mathbf{B} from the input of \mathbf{C} and vice-versa. Hence, consistency with \mathcal{O} implies consistency with any totalisation of \mathcal{O} .

Lemma 6.11. For a process Φ , a causal ordering \mathcal{O} , and a totalisation \mathcal{O}' of \mathcal{O} , we have $\Phi \models \mathcal{O} \implies \Phi \models \mathcal{O}'$.

Proof. Assume $\Phi \models \mathcal{O}$. Then, for any subset $\mathcal{E} \subseteq \mathcal{O}$, there exists a process Φ' such that:

$$\begin{array}{ccc}
 \begin{array}{c} \overbrace{\dots}^{\pi_2(\mathcal{E})} \quad \overline{\overline{}} \quad \dots \quad \overline{\overline{}} \\ \hline \Phi \\ \hline \underbrace{\dots}_{\pi_1(\mathbf{past}_{\mathcal{O}}(\mathcal{E}))} \end{array} & = & \begin{array}{c} \overbrace{\dots}^{\pi_2(\mathcal{E})} \\ \hline \Phi' \\ \hline \underbrace{\dots}_{\pi_1(\mathbf{past}_{\mathcal{O}}(\mathcal{E}))} \quad \overline{\overline{}} \quad \dots \quad \overline{\overline{}} \end{array}
 \end{array} \tag{6.6}$$

But since $e \preceq_{\mathcal{O}} e' \implies e \preceq_{\mathcal{O}'} e'$, we have $\mathbf{past}_{\mathcal{O}}(\mathcal{E}) \subseteq \mathbf{past}_{\mathcal{O}'}(\mathcal{E})$. Hence (6.6) implies that Φ factors as required by Definition 2.11:

$$\begin{array}{ccc}
 \begin{array}{c} \overbrace{\dots}^{\pi_2(\mathcal{E})} \quad \overline{\overline{}} \quad \dots \quad \overline{\overline{}} \\ \hline \Phi \\ \hline \underbrace{\dots}_{\pi_1(\mathbf{past}_{\mathcal{O}'}(\mathcal{E}))} \end{array} & = & \begin{array}{c} \overbrace{\dots}^{\pi_2(\mathcal{E})} \\ \hline \Phi' \\ \hline \underbrace{\dots}_{\pi_1(\mathbf{past}_{\mathcal{O}'}(\mathcal{E}))} \quad \overline{\overline{}} \quad \overline{\overline{}} \quad \overline{\overline{}} \quad \overline{\overline{}} \end{array}
 \end{array}$$

Therefore $\Phi \models \mathcal{O}'$. □

Combining this with its converse yields the following theorem.

Theorem 6.12. For a process Φ and a causal ordering \mathcal{O} , $\Phi \models \mathcal{O}$ if and only if, for every totalisation \mathcal{O}' of \mathcal{O} , $\Phi \models \mathcal{O}'$.

Proof. (\implies) follows immediately from Lemma 6.11. For (\impliedby), let $\mathcal{E} \subseteq \mathcal{O}$ be any subset. Split \mathcal{O} into two parts, $\mathcal{O}_1 := \mathbf{past}_{\mathcal{O}}(\mathcal{E})$ and $\mathcal{O}_2 := \mathcal{O} \setminus \mathbf{past}_{\mathcal{O}}(\mathcal{E})$. Define a total ordering \mathcal{O}' on $\mathcal{O}_1 \cup \mathcal{O}_2$ by requiring that every element in \mathcal{O}_1 is below every element in \mathcal{O}_2 and taking any totalization on \mathcal{O}_1 and \mathcal{O}_2 . This order refines \mathcal{O} because $\mathbf{past}_{\mathcal{O}}(\mathcal{E})$ is downward-closed, and by construction $\mathbf{past}_{\mathcal{O}}(\mathcal{E}) = \mathbf{past}_{\mathcal{O}'}(\mathcal{E})$. Hence $\Phi \models \mathcal{O}'$ implies:

$$\begin{array}{ccc}
 \begin{array}{c} \overbrace{\dots}^{\pi_2(\mathcal{E})} \quad \overline{\overline{}} \quad \dots \quad \overline{\overline{}} \\ \hline \Phi \\ \hline \underbrace{\dots}_{\pi_1(\mathbf{past}_{\mathcal{O}}(\mathcal{E}))} \end{array} & = & \begin{array}{c} \overbrace{\dots}^{\pi_2(\mathcal{E})} \\ \hline \Phi' \\ \hline \underbrace{\dots}_{\pi_1(\mathbf{past}_{\mathcal{O}}(\mathcal{E}))} \quad \overline{\overline{}} \quad \dots \quad \overline{\overline{}} \end{array}
 \end{array}$$

Since we can find a suitable totalisation to give the equation above for any subset $\mathcal{E} \subseteq \mathcal{O}$, we have $\Phi \models \mathcal{O}$. □

Hence, we can always replace consistency with a causal ordering with consistency with all of its totalisations, i.e., all of the linear orders which refine it. For example:

$$\begin{array}{c} \begin{array}{|c|c|c|} \hline A' & B' & C' \\ \hline \Phi \\ \hline A & B & C \\ \hline \end{array} \vDash \begin{array}{c} B & C \\ \diagdown \quad / \\ A \end{array} \iff \left(\begin{array}{c} \begin{array}{|c|c|c|} \hline A' & B' & C' \\ \hline \Phi \\ \hline A & B & C \\ \hline \end{array} \vDash \begin{array}{c} C \\ | \\ B \\ | \\ A \end{array} \wedge \begin{array}{c} \begin{array}{|c|c|c|} \hline A' & B' & C' \\ \hline \Phi \\ \hline A & B & C \\ \hline \end{array} \vDash \begin{array}{c} B \\ | \\ C \\ | \\ A \end{array} \right) \end{array} \quad (6.7)$$

We already showed in the previous section that we can capture any linear ordering via combs. Hence, to capture any causal ordering, we only need to be able to take conjunctions of linear causal orders. This can be accomplished via *intersections* of types, much like those defined in [34] for the quantum case.

The types on the RHS of (6.7) are, respectively:

$$\mathbf{X} := \mathbf{A} \multimap (\mathbf{A}' \multimap (\mathbf{B} \multimap \mathbf{B}') \multimap \mathbf{C}) \multimap \mathbf{C}' \quad \text{and} \quad \mathbf{X}' := \mathbf{A} \multimap (\mathbf{A}' \multimap (\mathbf{C} \multimap \mathbf{C}') \multimap \mathbf{B}) \multimap \mathbf{B}'$$

Our goal now is to form the intersection $\mathbf{X} \cap \mathbf{X}'$, which will consist precisely of those causal processes consistent with the causal ordering given by \mathbf{X} and the one given by \mathbf{X}' . Categorically, intersections are given by pullback, so our first goal will be to find an object in which both \mathbf{X} and \mathbf{X}' embed. Since combs are special cases of causal processes, we can embed both \mathbf{X} and \mathbf{X}' into the system of *all* causal processes of the appropriate type, namely:

$$\mathbf{X} \hookrightarrow (\mathbf{A} \otimes \mathbf{B} \otimes \mathbf{C} \multimap \mathbf{A}' \otimes \mathbf{B}' \otimes \mathbf{C}') \hookleftarrow \mathbf{X}'$$

In fact, we can always find such embeddings for any system built inductively from first-order systems:

Theorem 6.13. Any object \mathbf{X} built inductively from first order systems has a canonical embedding of the form:

$$e : \mathbf{X} \rightarrow (\mathbf{A}_1 \otimes \dots \otimes \mathbf{A}_m \multimap \mathbf{A}'_1 \otimes \dots \otimes \mathbf{A}'_n)$$

for some first-order systems $\mathbf{A}_1, \dots, \mathbf{A}_m, \mathbf{A}'_1, \dots, \mathbf{A}'_n$. Furthermore, the underlying \mathcal{C} -morphism is just a permutation of systems.

The proof is a straightforward application of the embedding $\mathbf{A} \otimes \mathbf{B} \hookrightarrow \mathbf{A} \wp \mathbf{B}$ and the special property of first order systems that $\mathbf{A} \otimes \mathbf{B} \cong \mathbf{A} \wp \mathbf{B}$. It is given explicitly in the appendix.

We will construct $\mathbf{X} \cap \mathbf{X}'$ essentially in terms of a set-theoretic intersection of their associated states $c_{\mathbf{X}}$ and $c_{\mathbf{X}'}$. For that, we we make use of the following lemma.

Lemma 6.14. Let c and d be sets of states for the same object A which are flat, closed, and furthermore satisfy the property that $\lambda \perp \in c$ and $\lambda \perp \in d$ for a fixed scalar λ . Then $c \cap d$ is also flat and closed.

Proof. For both properties, we rely on the fact that $(-)^*$ is order-reversing. That is, $a \subseteq b \Rightarrow b^* \subseteq a^*$. For flatness, we have by assumption that $\lambda \perp \in c \cap d$. Since $c \cap d \subseteq c$, we have $c^* \subseteq (c \cap d)^*$. So by flatness of c , $\mu \dagger \in c^*$ for some μ . Hence $\mu \dagger \in (c \cap d)^*$ and $c \cap d$ is flat.

For closure, first note that any set of states is contained in its double dual, so we have $c \cap d \subseteq (c \cap d)^{**}$. For the converse, $c \cap d \subseteq c$ implies $c^* \subseteq (c \cap d)^*$ and similarly $d^* \subseteq (c \cap d)^*$. Hence, $c^* \cup d^* \subseteq (c \cap d)^*$, so $(c \cap d)^{**} \subseteq (c^* \cup d^*)^*$. It therefore suffices to show that

$(c^* \cup d^*)^* \subseteq c \cap d$. This follows from the fact that $c^* \subseteq c^* \cup d^*$, so $(c^* \cup d^*)^* \subseteq c^{**} = c$ and similarly $(c^* \cup d^*)^* \subseteq d^{**} = d$. \square

Theorem 6.15. Let \mathbf{X}, \mathbf{X}' be a pair of objects with canonical embeddings e, f into a fixed system $\mathbf{Y} := \mathbf{A}_1 \otimes \dots \otimes \mathbf{A}_m \multimap \mathbf{A}'_1 \otimes \dots \otimes \mathbf{A}'_n$, as in Theorem 6.13. Then there exists an object $\mathbf{X} \cap \mathbf{X}'$ and morphisms p_1, p_2 in $\text{Caus}[\mathcal{C}]$ making the following pullback:

$$\begin{array}{ccc} \mathbf{X} \cap \mathbf{X}' & \xrightarrow{p_1} & \mathbf{X} \\ \downarrow p_2 & & \downarrow e \\ \mathbf{X}' & \xrightarrow{f} & \mathbf{Y} \end{array} \quad (6.8)$$

Proof. Let $\mathbf{Y} := (Y, c_Y)$ and define the following two sets of states for \mathbf{Y} :

$$\begin{aligned} \bar{c}_{\mathbf{X}} &:= \{e \circ \rho \mid \rho \in c_{\mathbf{X}}\} \\ \bar{c}_{\mathbf{X}'} &:= \{f \circ \rho \mid \rho \in c_{\mathbf{X}'}\} \end{aligned}$$

Since e and f are just permutations of systems, it is straightforward to show that both of these sets are flat, closed, and both contain $\lambda \perp$ for some fixed λ . Hence, applying Lemma 6.14, we have that $\bar{c}_{\mathbf{X}} \cap \bar{c}_{\mathbf{X}'}$ is flat and closed. Then, let $\mathbf{X} \cap \mathbf{X}' := (Y, \bar{c}_{\mathbf{X}} \cap \bar{c}_{\mathbf{X}'})$, $p_1 := e^{-1}$ and $p_2 := f^{-1}$. It is straightforward to check that p_1, p_2 are indeed $\text{Caus}[\mathcal{C}]$ -morphisms and diagram (6.8) clearly commutes.

It only remains to show that, for any $g : \mathbf{Z} \rightarrow \mathbf{X}$ and $h : \mathbf{Z} \rightarrow \mathbf{X}'$ such that $e \circ g = f \circ h$, there is a unique mediating morphism $z : \mathbf{Z} \rightarrow \mathbf{X} \cap \mathbf{X}'$:

$$\begin{array}{ccc} \mathbf{Z} & & \\ & \searrow g & \\ & \mathbf{X} \cap \mathbf{X}' & \xrightarrow{e^{-1}} \mathbf{X} \\ & \downarrow f^{-1} & \downarrow e \\ & \mathbf{X}' & \xrightarrow{f} \mathbf{Y} \end{array}$$

(Note: A dashed arrow labeled z points from \mathbf{Z} to $\mathbf{X} \cap \mathbf{X}'$, and a solid arrow labeled h points from \mathbf{Z} to \mathbf{X}' .)

Since e and f are isomorphisms, the only possibility is $z := e \circ g = f \circ h$. So, it suffices to show that z is a morphism in $\text{Caus}[\mathcal{C}]$. For any $\rho \in c_{\mathbf{Z}}$, $g \circ \rho \in c_{\mathbf{X}}$, so $z \circ \rho = e \circ g \circ \rho \in \bar{c}_{\mathbf{X}}$. Similarly, $z \circ \rho = f \circ h \circ \rho \in \bar{c}_{\mathbf{X}'}$. Hence $z \circ \rho \in \bar{c}_{\mathbf{X}} \cap \bar{c}_{\mathbf{X}'}$, which completes the proof. \square

Since combs embed into all causal processes, it immediately follows that we can take intersections of combs via pullback. Hence, the condition on Φ stated in (6.7) can equivalently be given in terms of Φ having the following type:

$$\begin{array}{c} \begin{array}{|c|c|c|} \hline A' & B' & C' \\ \hline \Phi & & \\ \hline A & B & C \\ \hline \end{array} & : & (\mathbf{A} \multimap (\mathbf{A}' \multimap (\mathbf{B} \multimap \mathbf{B}') \multimap \mathbf{C}) \multimap \mathbf{C}') \cap (\mathbf{A} \multimap (\mathbf{A}' \multimap (\mathbf{C} \multimap \mathbf{C}') \multimap \mathbf{B}) \multimap \mathbf{B}') \end{array}$$

This generalises in the obvious way to any causal ordering \mathcal{O} .

The fact that \cap arises as a pullback also gives us some properties of intersections ‘for free’. For instance, any functor with a left adjoint necessarily preserves limits. By the definition of $*$ -autonomous categories, $(\mathbf{B} \multimap -)$ has a left adjoint given by $(- \otimes \mathbf{B})$, so the following is immediate:

Corollary 6.16. For objects \mathbf{A}, \mathbf{A}' and \mathbf{B} in $\text{Caus}[\mathcal{C}]$ we have

$$\mathbf{B} \multimap (\mathbf{A} \cap \mathbf{A}') \cong (\mathbf{B} \multimap \mathbf{A}) \cap (\mathbf{B} \multimap \mathbf{A}')$$

7. HIGHER-ORDER SYSTEMS WITH INDEFINITE CAUSAL ORDER

Quantum theory, as it is typically understood, assumes a fixed background time, and hence a fixed causal ordering. However, in the context of higher-order processes, this restriction is not necessary to obtain a theory which behaves *locally* like classical or quantum theory. In this section we shall take a look at *process matrices*, introduced in [32], to investigate processes which do not have a definite causal order. Such processes were called bipartite second-order causal in [27].

Definition 7.1. A process $w : (A^* \otimes A') \otimes (B^* \otimes B') \rightarrow C^* \otimes C$ is called *bipartite second-order causal* (SOC_2) if for all causal Φ_A, Φ_B the following map is causal:

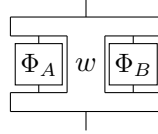

So SOC_2 maps send products of causal processes to a causal process. The following shows that SOC_2 processes are actually normalized on *all* non-signalling maps, not just product maps.

Theorem 7.2. For first order systems $\mathbf{A}, \mathbf{A}', \mathbf{B}, \mathbf{B}', \mathbf{C}, \mathbf{C}'$, a process w is SOC_2 if and only if it is of type $(\mathbf{A} \multimap \mathbf{A}') \otimes (\mathbf{B} \multimap \mathbf{B}') \multimap (\mathbf{C} \multimap \mathbf{C}')$.

Proof. Since products of causal processes are non-signalling, they are in $(\mathbf{A} \multimap \mathbf{A}') \otimes (\mathbf{B} \multimap \mathbf{B}')$, so any process of the above type is indeed SOC_2 .

For the converse, let π be an effect of type $(\mathbf{C} \multimap \mathbf{C}')^*$. Then $\pi \circ w$ is an effect on products of causal processes. Now Lemma 4.6 states that $\pi \circ w$ yields 1 for product states if and only if it yields 1 for any state in the tensor product. Hence it is an effect for $(\mathbf{A} \multimap \mathbf{A}') \otimes (\mathbf{B} \multimap \mathbf{B}')$, which by Theorem 6.2 are precisely the non-signalling maps. By Proposition 4.4 this means $w : (\mathbf{A} \multimap \mathbf{A}') \otimes (\mathbf{B} \multimap \mathbf{B}') \multimap (\mathbf{C} \multimap \mathbf{C}')$ \square

This represents a significant strengthening of the result in [27], which was only able to show that SOC_2 extends to all so-called *strongly non-signalling* processes, which are a special case of non-signalling processes.

Special cases of SOC_2 processes are 3-combs which arise from fixing a causal ordering between \mathbf{A} and \mathbf{B} :

$$\begin{aligned} \mathbf{C} \multimap (\mathbf{A} \multimap (\mathbf{A}' \multimap \mathbf{B}) \multimap \mathbf{B}') \multimap \mathbf{C}' \\ \mathbf{C} \multimap (\mathbf{B} \multimap (\mathbf{B}' \multimap \mathbf{A}) \multimap \mathbf{A}') \multimap \mathbf{C}' \end{aligned}$$

Indeed one can show the containment of either of these types into the type of SOC_2 processes using a simple calculation on types much like in Remark 6.5. However, the most interesting SOC_2 processes are those which do not arise from combs.

Example 7.3. The *OCB process* is defined as follows:

We now see some concrete examples of the switch, as a higher-order stochastic map and as a quantum channel.

Example 7.6. For $\mathcal{C} = \mathbf{Mat}(\mathbb{R}_+)$, the *classical switch* process is uniquely fixed by (7.2) if we let $\mathbf{X} = 2$ and:

$$\rho_0 := \begin{pmatrix} 1 \\ 0 \end{pmatrix} \quad \rho_1 := \begin{pmatrix} 0 \\ 1 \end{pmatrix}$$

Indeed, s is given by:

(7.3)

where $\rho'_i := \rho_i^T$. Then, since $\rho'_0 + \rho'_1 = \ddagger$, we have:

Hence s has the correct type shown in (7.1).

Example 7.7. For $\mathcal{C} = \mathbf{CPM}$, a switch process can be defined just as in (7.3), by letting $\mathbf{X} = \mathcal{L}(\mathbb{C}^2)$ and replacing ρ_i and ρ_i^T with the appropriate qubit projections and their associated quantum effects:

$$\rho_i := |i\rangle\langle i| \quad \rho'_i(\mu) := \text{Tr}(|i\rangle\langle i| \mu)$$

This is precisely the \mathcal{Z} superoperator defined in [8], which defines a (decoherent) switch for quantum channels.

However, unlike Example 7.6, this channel is *not* uniquely fixed by (7.2), since ρ_0, ρ_1 do not form a basis for $\mathcal{L}(\mathbb{C}^2)$. For instance, plugging $\rho := |+\rangle\langle +|$ into \mathbf{X} of this process yields a classical mixture of the two possible wirings:

One can also define a *coherent* quantum switch which does satisfy (7.2), but where inputting the state $|+\rangle\langle +|$ into \mathbf{X} yields a quantum superposition of causal orderings. See [8] for details.

Theorem 7.8. A switch cannot be causally ordered. That is, the type of s does not restrict to one of the following:

$$\begin{aligned} \mathbf{X} \otimes \mathbf{C} &\multimap (\mathbf{A} \multimap (\mathbf{A}' \multimap \mathbf{B}) \multimap \mathbf{B}') \multimap \mathbf{C}' \\ \mathbf{X} \otimes \mathbf{C} &\multimap (\mathbf{B} \multimap (\mathbf{B}' \multimap \mathbf{A}) \multimap \mathbf{A}') \multimap \mathbf{C}' \end{aligned}$$

```

Terminal — swipl llprover.pl — 98x23
Trying to prove with threshold = 0 1
Succeed in proving 1-> (a1-> (a2->b1)->b2)->1 --> ~ ((a1->a2)* (b1->b2)) (5341 msec.)
twosided:pretty:1 =
----- Ax ----- Ax ----- Ax ----- Ax
a1 --> a1      a2 --> a2      b1 --> b1      b2 --> b2
----- L-> ----- L-> ----- L-> ----- L->
a1,a1->a2 --> a2      b1,b1->b2 --> b2
----- L-> ----- L-> ----- L-> ----- L->
a2->b1,a1,a1->a2,b1->b2 --> b2      ----- R1 ----- L0
----- R-> ----- R-> ----- R-> ----- R->
a1,a1->a2,b1->b2 --> (a2->b1)->b2      --> 1->0      Axiom      1->0 -->
----- R-> ----- R-> ----- R-> ----- R->
a1->a2,b1->b2 --> a1-> (a2->b1)->b2      ----- L1 ----- Cut
----- R1 ----- L-> ----- L-> ----- L->
--> 1      a1->a2,b1->b2,(a1-> (a2->b1)->b2)->1 -->
----- L-> ----- L-> ----- L-> ----- L->
a1->a2,b1->b2,1-> (a1-> (a2->b1)->b2)->1 -->
----- L* ----- L-> ----- L-> ----- L->
(a1->a2)* (b1->b2),1-> (a1-> (a2->b1)->b2)->1 -->
----- R~ ----- R~ ----- R~ ----- R~
1-> (a1-> (a2->b1)->b2)->1 --> ~ ((a1->a2)* (b1->b2))
yes
cll(full)> |: █

```

Figure 1: Proving a 3-comb with trivial input and output systems embeds in SOC_2 using `llprover`.

$\mathbf{Mat}(\mathbb{R}_+)$, $\mathcal{I} = \mathbb{R}_+$. Taking \mathcal{M} to be the unit interval, $\text{Caus}_{[0,1]}[\mathbf{Mat}(\mathbb{R}_+)]$ gives us the full subcategory of probabilistic coherence spaces on finite sets [17]. Similarly, $\text{Caus}_{[0,1]}[\mathbf{CPM}]$ has trace non-increasing CP maps as its first-order processes, and generalisations thereof at higher orders. Alternatively, we can build a category of ‘causal processes with failure’ by letting \mathcal{M} be $\{0, 1\}$. Exploring the properties of these categories, and how they relate to $\text{Caus}[\mathcal{C}]$ is a subject of future work. Another subject for future research is the relation between the types of causal systems and multiplicative linear logic (MLL). Since $*$ -autonomous categories are a model of MLL, MLL provides a (decidable) fragment of the logic of type containment in $\text{Caus}[\mathcal{C}]$. This opens up possibilities to automate many proofs using existing automated linear logic provers. Indeed many of the type relationships in this paper were discovered with the help of such a tool, called `llprover` [40] (see Fig. 1).

A third direction for future work is to understand exactly how expressive the internal logic of a HOCC is. We showed in this paper that it is possible to express generalised conditional independences of a ‘non-signalling’ variety, which always takes a certain form for a process with inputs and outputs (e.g., a conditional probability distribution):

$$(\text{outputs}) \perp\!\!\!\perp (\text{inputs}) \mid (\text{other inputs})$$

For example, the usual 2-party non-signalling conditions for a process $\Phi : A \otimes B \rightarrow A' \otimes B'$ are of the form:

$$A' \perp\!\!\!\perp B \mid A \quad \text{and} \quad B' \perp\!\!\!\perp A \mid B$$

However, classical conditional independences can be of the form $\mathcal{A} \perp\!\!\!\perp \mathcal{B} \mid \mathcal{C}$ for arbitrary sets of random variables $\mathcal{A}, \mathcal{B}, \mathcal{C}$. It is therefore natural to ask if we could express such independences within a HOCC, possibly with some extra structure. One possible approach is to interconvert inputs and outputs via the probabilistic operation of *disintegration*. This classical technique of converting a joint state into a reduced state and a conditional distribution

is a crucial ‘subroutine’ in Bayesian inference, and has recently given a categorical/string-diagrammatic characterisation by Cho and Jacobs [9] and showed that categories that admit disintegration enable various equivalent expressions of (arbitrary) conditional independences of systems, and can even recover the graphoid axioms of Verma and Pearl [41]. Thus, considering precausal categories with disintegration should enable one to say much more about conditional independences (and processes which preserve them) than just plain precausal categories. Unfortunately, disintegration in its usual form relies crucially on the copiability of classical data, so it does not have a straightforward quantum analogue. Nonetheless, quantum analogues to Bayesian conditioning [30] and more recently quantum common causes [2] could provide a solution analogous to the classical case.

Pushing this a bit further, one not only wishes to talk about independences within a HOCC, but also draw causal conclusions. That is, one not only wishes to rule out possible causal explanations, but also one wants to say when a causal influence is present (and possibly even measure it). Exploring the connection with techniques in classical causal inference of a logical or equational flavour, such as Pearl’s *do-calculus* [33], may give some clues.

REFERENCES

- [1] S. Abramsky and B. Coecke. In *Proceedings of the 19th Annual IEEE Symposium on Logic in Computer Science (LICS)*, pages 415–425. arXiv:quant-ph/0402130.
- [2] John-Mark A. Allen, Jonathan Barrett, Dominic C. Horsman, Ciarán M. Lee, and Robert W. Spekkens. Quantum common causes and quantum causal models. *Phys. Rev. X*, 7:031021, Jul 2017.
- [3] Á. Baumeler, A. Feix, and S. Wolf. Maximal incompatibility of locally classical behavior and global causal order in multiparty scenarios. *Phys. Rev. A*, 90:042106, Oct 2014.
- [4] D. Beckman, D. Gottesman, M. A. Nielsen, and J. Preskill. Causal and localizable quantum operations. *Phys Rev A*, 64:052309, Nov 2001.
- [5] G. Chiribella, G. M. D’Ariano, and P. Perinotti. Quantum circuit architecture. *Phys. Rev. Lett.*, 101:060401, Aug 2008.
- [6] G. Chiribella, G. M. D’Ariano, and P. Perinotti. Theoretical framework for quantum networks. *Phys. Rev. A*, 80:022339, Aug 2009.
- [7] G. Chiribella, G. M. D’Ariano, and P. Perinotti. Informational derivation of quantum theory. *Physical Review A*, 84(1):012311, 2011.
- [8] G. Chiribella, G. M. D’Ariano, P. Perinotti, and B. Valiron. Quantum computations without definite causal structure. *Physical Review A*, 88:022318, August 2013.
- [9] K. Cho and B. Jacobs. Disintegration and Bayesian Inversion, Both Abstractly and Concretely. *ArXiv e-prints*, August 2017.
- [10] J.R.B. Cockett and R.A.G. Seely. Proof theory for full intuitionistic linear logic, bilinear logic, and mix categories. *Theory and Applications of Categories*, 1991.
- [11] J.R.B. Cockett and R.A.G. Seely. Weakly distributive categories. *Journal of Pure and Applied Algebra*, 114(2):133 – 173, 1997.
- [12] B. Coecke. Terminality equals non-signalling. 2014.
- [13] B. Coecke. Terminality implies no-signalling ...and much more than that. *New Generation Computing*, 34(1):69–85, 2016.
- [14] B. Coecke and A. Kissinger. In *Categories for the Working Philosopher*.
- [15] Bob Coecke and Raymond Lal. Causal categories: Relativistically interacting processes. *Foundations of Physics*, 43(4):458, 2013.
- [16] Fabio Costa and Sally Shrapnel. Quantum causal modelling. *New Journal of Physics*, 18(6):063032, 2016.
- [17] Vincent Danos and Thomas Ehrhard. Probabilistic coherence spaces as a model of higher-order probabilistic computation. *Information and Computation*, 209(6):966 – 991, 2011.
- [18] I. Ebert-Uphoff and Y. Deng. Causal discovery for climate research using graphical models. *Journal of Climate*, 25(17):5648–5665, 2012.

- [19] T. Eggeling, D. Schlingemann, and R. F. Werner. Semicausal operations are semilocalizable. *EPL (Europhysics Letters)*, 57(6):782, 2002.
- [20] Karl Friston, Rosalyn Moran, and Anil K. Seth. Analysing connectivity with granger causality and dynamic causal modelling. *Journal*, Year.
- [21] Jean-Yves Girard. Between logic and quantic: a tract. *Linear logic in computer science*, 316:346–381, 2004.
- [22] G. Gutoski and J. Watrous. Toward a general theory of quantum games.
- [23] L. Hardy. Towards quantum gravity: a framework for probabilistic theories with non-fixed causal structure. *J. Phys. A*, 40(12):3081, 2007.
- [24] J. Henson, R. Lal, and M. F. Pusey. Theory-independent limits on correlations from generalized bayesian networks. *New Journal of Physics*, 16(11):113043, 2014.
- [25] M. Hyland and A. Schalk. Glueing and orthogonality for models of linear logic. *Theoretical Computer Science*, 294(1–2):183 – 231, 2003.
- [26] A. Kissinger, M. Hoban, and B. Coecke. Equivalence of relativistic causal structure and process terminality. *ArXiv e-prints*, 2017.
- [27] A. Kissinger and S. Uijlen. Picturing indefinite causal structure. In *Quantum Physics and Logic, 2016*.
- [28] Aleks Kissinger and Sander Uijlen. A categorical semantics for causal structure. In *32nd Annual ACM/IEEE Symposium on Logic in Computer Science, LICS 2017, Reykjavik, Iceland, June 20-23, 2017*, pages 1–12, 2017.
- [29] M. Leifer. The Choi-Jamiołkowski Isomorphism: You’re Doing it Wrong! Blog post, <http://mattleifer.info/2011/08/01/the-choi-jamiolkowski-isomorphism-youre-doing-it-wrong>.
- [30] M. S. Leifer and R. W. Spekkens. Towards a formulation of quantum theory as a causally neutral theory of bayesian inference. *Phys. Rev. A*, 88:052130, Nov 2013.
- [31] S. Mac Lane. *Categories for the working mathematician*.
- [32] O. Oreshkov, F. Costa, and C. Brukner. Quantum correlations with no causal order. *Nature Communication*, 1092(3).
- [33] J. Pearl. *Causality: Models, Reasoning and Inference*. Cambridge University Press, 2000.
- [34] P. Perinotti. Causal structures and the classification of higher order quantum computations. 2016.
- [35] Jacques Pienaar and Časlav Brukner. A graph-separation theorem for quantum causal models. *New Journal of Physics*, 17(7):073020, 2015.
- [36] N. Soranzo Pinna, A. and A. De La Fuente. From knockouts to networks: establishing direct cause-effect relationships through graph analysis. *PLoS one*, 5(10):e12912, 2010.
- [37] P. Selinger. In *New Structures for Physics*.
- [38] Elena Sokolova, Perry Groot, Tom Claassen, Kimm J. van Hulzen, Jeffrey C. Glennon, Barbara Franke, Tom Heskes, and Jan Buitelaar. Statistical evidence suggests that inattention drives hyperactivity/impulsivity in attention deficit-hyperactivity disorder. *PLoS one*, 11(10):e0165120, 2016.
- [39] Peter Spirtes and Clark Glymour. An algorithm for fast recovery of sparse causal graphs. *Social Science Computer Review*, 9(1):62–72, 1991.
- [40] N. Tamura. User’s guide of a linear logic theorem prover (llprover). Technical report, 1995.
- [41] Thomas VERMA and Judea PEARL. Causal networks: Semantics and expressiveness. In Ross D. SHACHTER, Tod S. LEVITT, Laveen N. KANAL, and John F. LEMMER, editors, *Uncertainty in Artificial Intelligence*, volume 9 of *Machine Intelligence and Pattern Recognition*, pages 69 – 76. North-Holland, 1990.
- [42] Christopher J Wood and Robert W Spekkens. The lesson of causal discovery algorithms for quantum correlations: causal explanations of bell-inequality violations require fine-tuning. *New Journal of Physics*, 17(3):033002, 2015.

APPENDIX A. OMITTED PROOFS

A.1. Proof that $\text{Caus}[\mathcal{C}]$ is $*$ -autonomous.

In this part of the appendix we will give full proofs leading up to the fact that $\text{Caus}[\mathcal{C}]$ is indeed a $*$ -autonomous category.

Theorem. $\text{Caus}[\mathcal{C}]$ is an SMC, with tensor given by:

$$\mathbf{A} \otimes \mathbf{B} := (A \otimes B, c_{\mathbf{A} \otimes \mathbf{B}})$$

and tensor unit $\mathbf{I} := (I, \{1\})$.

Proof. First we show that $\mathbf{A} \otimes \mathbf{B}$ and \mathbf{I} are indeed objects in $\text{Caus}[\mathcal{C}]$, namely the $c_{\mathbf{A} \otimes \mathbf{B}}$ and $c_{\mathbf{I}}$ are flat and closed. This is immediate for $c_{\mathbf{I}}$, so we focus on $c_{\mathbf{A} \otimes \mathbf{B}}$.

Closure follows immediately from Lemma 4.5, so it remains to show flatness. Since $c_{\mathbf{A}}$ and $c_{\mathbf{B}}$ are flat, then for some λ, λ' :

$$\lambda \perp\!\!\!\perp \in c_{\mathbf{A}}, \lambda' \perp\!\!\!\perp \in c_{\mathbf{B}}$$

hence:

$$\lambda \lambda' \perp\!\!\!\perp \perp\!\!\!\perp \in c_{\mathbf{A}} \otimes c_{\mathbf{B}} \subseteq c_{\mathbf{A} \otimes \mathbf{B}}$$

Similarly, for some μ, μ' :

$$\mu \overline{\perp\!\!\!\perp} \in c_{\mathbf{A}}^*, \mu' \overline{\perp\!\!\!\perp} \in c_{\mathbf{B}}^*$$

So, for all $\rho \in c_{\mathbf{A}}, \rho' \in c_{\mathbf{B}}$, we have:

$$\mu \mu' \overline{\perp\!\!\!\perp} \overline{\perp\!\!\!\perp} \rho \rho' = 1$$

which implies, by Lemma 4.5:

$$\mu \mu' \overline{\perp\!\!\!\perp} \overline{\perp\!\!\!\perp} \in (c_{\mathbf{A}} \otimes c_{\mathbf{B}})^* = (c_{\mathbf{A}} \otimes c_{\mathbf{B}})^{***} =: c_{\mathbf{A} \otimes \mathbf{B}}^*$$

Next, we show associativity and unit laws for \otimes . For any object \mathbf{A} , the unit laws $\mathbf{A} \otimes \mathbf{I} = \mathbf{A} = \mathbf{I} \otimes \mathbf{A}$ follow from the closure of $c_{\mathbf{A}}$. Associativity is a bit trickier. We first work in terms of effects in order to take advantage of Lemma 4.6. Applying this to an effect $\pi \in c_{(\mathbf{A} \otimes \mathbf{B}) \otimes \mathbf{C}}^*$ gives:

$$\begin{aligned} \left(\forall \Psi \in c_{(\mathbf{A} \otimes \mathbf{B}) \otimes \mathbf{C}} \cdot \right) & \left(\begin{array}{c} \triangle \\ \pi \\ \hline \Psi \\ \triangle \end{array} = 1 \right) & \iff & \left(\forall \Psi \in c_{\mathbf{A} \otimes \mathbf{B}}, \xi \in c_{\mathbf{C}} \cdot \right) & \left(\begin{array}{c} \triangle \\ \pi \\ \hline \Psi \quad \xi \\ \triangle \end{array} = 1 \right) \\ & & & \iff & \left(\forall \psi \in c_{\mathbf{A}}, \phi \in c_{\mathbf{B}}, \xi \in c_{\mathbf{C}} \cdot \right) & \left(\begin{array}{c} \triangle \\ \pi \\ \hline \psi \quad \phi \quad \xi \\ \triangle \end{array} = 1 \right) \end{aligned}$$

Similarly, for $\pi \in c_{\mathbf{A} \otimes (\mathbf{B} \otimes \mathbf{C})}^*$

$$\begin{aligned} \left(\forall \Psi \in c_{\mathbf{A} \otimes (\mathbf{B} \otimes \mathbf{C})} \cdot \right) & \left(\begin{array}{c} \triangle \\ \pi \\ \hline \Psi \\ \triangle \end{array} = 1 \right) \iff \left(\begin{array}{c} \forall \psi \in c_{\mathbf{A}}, \Phi \in c_{\mathbf{B} \otimes \mathbf{C}} \cdot \\ \triangle \\ \pi \\ \hline \psi \quad \Phi \\ \triangle \quad \triangle \end{array} = 1 \right) \\ & \iff \left(\begin{array}{c} \forall \psi \in c_{\mathbf{A}}, \phi \in c_{\mathbf{B}}, \xi \in c_{\mathbf{C}} \cdot \\ \triangle \\ \pi \\ \hline \psi \quad \phi \quad \xi \\ \triangle \quad \triangle \quad \triangle \end{array} = 1 \right) \end{aligned}$$

Hence $c_{(\mathbf{A} \otimes \mathbf{B}) \otimes \mathbf{C}}^* = c_{\mathbf{A} \otimes (\mathbf{B} \otimes \mathbf{C})}^*$ so $c_{(\mathbf{A} \otimes \mathbf{B}) \otimes \mathbf{C}} = c_{\mathbf{A} \otimes (\mathbf{B} \otimes \mathbf{C})}$, which implies associativity of \otimes .

Next we show that \otimes is well-defined on morphisms. For morphisms $f : \mathbf{A} \rightarrow \mathbf{A}'$, $g : \mathbf{B} \rightarrow \mathbf{B}'$, and an effect $\pi \in c_{\mathbf{A}' \otimes \mathbf{B}'}$, we have by Lemma 4.6:

$$\left(\forall \Psi \in c_{\mathbf{A}' \otimes \mathbf{B}'} \cdot \right) \left(\begin{array}{c} \triangle \\ \pi \\ \hline f \quad g \\ \hline \Psi \\ \triangle \end{array} = 1 \right) \iff \left(\begin{array}{c} \forall \psi \in c_{\mathbf{A}'}, \phi \in c_{\mathbf{B}'} \cdot \\ \triangle \\ \pi \\ \hline f \quad g \\ \hline \psi \quad \phi \\ \triangle \quad \triangle \end{array} = 1 \right)$$

The RHS holds since $f \circ \psi \in c_{\mathbf{A}'}$ and $g \circ \phi \in c_{\mathbf{B}'}$. From the LHS above, we can conclude that $f \otimes g : \mathbf{A} \otimes \mathbf{B} \rightarrow \mathbf{A}' \otimes \mathbf{B}'$ is a morphism in $\text{Caus}[\mathcal{C}]$.

Finally, it remains to show that the swap is a morphism in $\text{Caus}[\mathcal{C}]$. By Proposition 4.4, this is the case when, for all $\pi \in c_{\mathbf{B} \otimes \mathbf{A}}^*$, we have:

$$\begin{array}{c} \triangle \\ \pi \\ \hline B \quad A \\ \hline A \quad B \\ \triangle \end{array} \in c_{\mathbf{A} \otimes \mathbf{B}}^*$$

This again follows by relying on Lemma 4.6. □

Lemma. The transposition functor $(-)^* : \mathcal{C}^{\text{op}} \rightarrow \mathcal{C}$:

$$A \mapsto A^* \quad \begin{array}{c} |B \\ \boxed{f} \\ |A \end{array} \mapsto \begin{array}{c} |A^* \\ \boxed{f^*} \\ |B^* \end{array} := \begin{array}{c} |A^* \\ \boxed{f} \\ |B^* \end{array} \quad (\text{A.1})$$

lifts to a full and faithful functor $(-)^* : \text{Caus}[\mathcal{C}]^{\text{op}} \rightarrow \text{Caus}[\mathcal{C}]$, where $\mathbf{A}^* := (A^*, c_{\mathbf{A}^*})$.

Proof. Note that $c_{\mathbf{B}}^* = c_{\mathbf{B}^*}$, by definition, and $c_{\mathbf{A}} = c_{\mathbf{A}^*}^* = (c_{\mathbf{A}^*})^*$. Hence, for $f : \mathbf{A} \rightarrow \mathbf{B}$ we have:

$$\left(\forall \rho \in c_{\mathbf{A}}, \pi \in c_{\mathbf{B}}^* \cdot \right) \left(\begin{array}{c} \triangle \\ \pi \\ \hline \rho \\ \hline \boxed{f} \\ \hline \rho \\ \triangle \end{array} = 1 \right) \iff \left(\begin{array}{c} \forall \pi \in c_{\mathbf{B}^*}, \rho \in (c_{\mathbf{A}^*})^* \cdot \\ \triangle \\ \rho \\ \hline \boxed{f} \\ \hline \pi \\ \triangle \end{array} = 1 \right)$$

so $f^* : \mathbf{B}^* \rightarrow \mathbf{A}^*$ is a morphism in $\text{Caus}[\mathcal{C}]$. Just as with the functor $(-)^*$ in \mathcal{C} , $((-)^*)^* = \text{Id}_{\text{Caus}[\mathcal{C}]}$, so fullness and faithfulness is immediate. \square

Theorem. For any precausal category \mathcal{C} , $\text{Caus}[\mathcal{C}]$ is a $*$ -autonomous category where $\mathbf{I} = \mathbf{I}^*$.

Proof. We have already shown that $\text{Caus}[\mathcal{C}]$ is an SMC (Theorem 4.7) with a full and faithful functor $(-)^* : \text{Caus}[\mathcal{C}]^{\text{op}} \rightarrow \text{Caus}[\mathcal{C}]$ (Lemma 4.8). Consider objects $\mathbf{A}, \mathbf{B}, \mathbf{C}$ in $\text{Caus}[\mathcal{C}]$. The underlying object of $\mathbf{B} \multimap \mathbf{C}$ is:

$$(\mathbf{B} \otimes \mathbf{C}^*)^* = \mathbf{B}^* \otimes \mathbf{C}^{**} = \mathbf{B}^* \otimes \mathbf{C}$$

Since \mathcal{C} is compact closed, there is a natural isomorphism:

$$\mathcal{C}(\mathbf{A} \otimes \mathbf{B}, \mathbf{C}) \cong \mathcal{C}(\mathbf{A}, \mathbf{B}^* \otimes \mathbf{C})$$

given by:

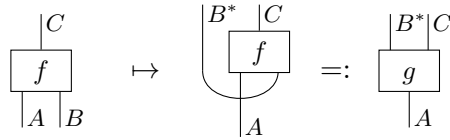

whose inverse is:

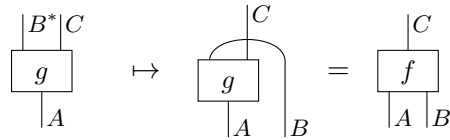

Indeed this is how one shows that compact closed categories are in fact closed. Thus, it suffices to show that:

$$f \in \text{Caus}[\mathcal{C}](\mathbf{A} \otimes \mathbf{B}, \mathbf{C}) \iff g \in \text{Caus}[\mathcal{C}](\mathbf{A}, \mathbf{B} \multimap \mathbf{C})$$

This follows from Lemma (4.6):

$$\begin{aligned}
f \in \text{Caus}[\mathcal{C}](\mathbf{A} \otimes \mathbf{B}, \mathbf{C}) &\iff \left(\begin{array}{c} \forall \rho \in c_{\mathbf{A} \otimes \mathbf{B}}, \pi \in c_{\mathbf{C}}^* . \\ \begin{array}{c} \triangle \pi \\ | \\ \square f \\ | \\ \nabla \rho \end{array} = 1 \end{array} \right) \\
&\iff \left(\begin{array}{c} \forall \rho_1 \in c_{\mathbf{A}}, \rho_2 \in c_{\mathbf{B}}, \pi \in c_{\mathbf{C}}^* . \\ \begin{array}{c} \triangle \pi \\ | \\ \square f \\ | \\ \nabla \rho_1 \quad \nabla \rho_2 \end{array} = 1 \end{array} \right) \\
&\iff \left(\begin{array}{c} \forall \rho_1 \in c_{\mathbf{A}}, \rho_2 \in c_{\mathbf{B}^*}, \pi \in c_{\mathbf{C}}^* . \\ \begin{array}{c} \triangle \rho_2 \quad \triangle \pi \\ | \quad | \\ \square f \\ | \\ \nabla \rho_1 \end{array} = 1 \end{array} \right) \\
&\iff g \in \text{Caus}[\mathcal{C}](\mathbf{A}, \mathbf{B} \multimap \mathbf{C})
\end{aligned}$$

Finally, $\mathbf{I} = \mathbf{I}^*$ follows from the fact that $I = I^*$ and

$$c_{\mathbf{I}}^* = \{\lambda \mid 1\lambda = 1\} = \{1\} = c_{\mathbf{I}}$$

□

A.2. Proofs that $\text{Mat}(\mathbb{R}_+)$ and CPM are precausal.

Theorem. $\text{Mat}(\mathbb{R}_+)$ is a precausal category.

Proof. (C1) was given in Example 2.7. (C2) is immediate, and (C3) follows from the fact that one can always construct a basis for a vector space out of probability distributions, e.g., by taking the point distributions. To show (C4), we will decompose into (C4') and (C5') via Proposition 3.4.

So, we turn to (C4'):

$$\left(\begin{array}{c} \exists \Phi' \text{ causal} . \\ \begin{array}{c} \equiv \\ \square \Phi \\ \equiv \end{array} = \begin{array}{c} \square \Phi' \\ \equiv \end{array} \end{array} \right) \implies \left(\begin{array}{c} \exists \Phi_1, \Phi_2 \text{ causal} . \\ \begin{array}{c} \square \Phi \\ \equiv \end{array} = \begin{array}{c} \square \Phi_2 \\ | \\ \square \Phi_1 \end{array} \end{array} \right)$$

In terms of a conditional probability distribution $P(A'B'|AB)$, the premise above amounts to the usual non-signalling condition:

$$P(A'|AB) = P(A'|A)$$

Hence the conclusion follows from the product rule:

$$\begin{aligned} P(A'B'|AB) &= P(A'|AB)P(B'|A'AB) \\ &= P(A'|A)P(B'|A'AB) \end{aligned}$$

More precisely, suppose Φ_{ij}^{kl} is a stochastic matrix such that there exists another stochastic matrix $(\Phi')_i^k$ where:

$$\sum_l \Phi_{ij}^{kl} = (\Phi')_i^k$$

Then, let:

$$\begin{aligned} (\Phi_1)_i^{k'i'k'} &= (\Phi')_i^k \delta_{ii'} \delta_{kk'} \\ (\Phi_2)_{i'l'k'j} &= \begin{cases} \delta_{0l} & \text{if } (\Phi')_i^{k'} = 0 \\ \Phi_{ij}^{k'l} / (\Phi')_i^{k'} & \text{otherwise} \end{cases} \end{aligned}$$

where δ_{ij} is the Kronecker delta. One can straightforwardly verify that these are both stochastic matrices. Let Ψ_{ij}^{kl} be the result of plugging outputs i', k' of Φ_1 into those inputs for Φ_2 , i.e.

$$\Psi_{ij}^{kl} := \sum_{i'k'} (\Phi_1)_i^{k'i'k'} (\Phi_2)_{i'l'k'j}^l = (\Phi')_i^k (\Phi_2)_{ikj}^l$$

If $(\Phi')_i^k = 0$, then both Φ_{ij}^{kl} and Ψ_{ij}^{kl} are 0 for all j, l . So, suppose $(\Phi')_i^k \neq 0$. Then:

$$\Psi_{ij}^{kl} = (\Phi')_i^k (\Phi_{ij}^{kl} / (\Phi')_i^k) = \Phi_{ij}^{kl}$$

For (C5'), let w_j^i be the matrix of a second-order causal effect $w : A \otimes B^*$. Then for all stochastic matrices Φ_i^j , we have:

$$\sum_{ij} w_j^i \Phi_i^j = 1$$

For some fixed column m , and fixed rows $n \neq n'$, the following matrix:

$$1 = \Phi_i^j = \begin{cases} p & i = m, j = n \\ 1 - p & i = m, j = n' \\ 0 & i = m, j \neq n, j \neq n' \\ \delta_i^j & i \neq m \end{cases}$$

defines a stochastic map for any $p \in [0, 1]$. Then:

$$\sum_{ij} w_j^i \Phi_i^j = pw_n^m + (1 - p)w_{n'}^m + K = 1$$

where K doesn't depend on p . Since we can freely vary p between 0 and 1, the only way to preserve normalisation is if $w_n^m = w_{n'}^m$. Hence, for all j , we have $w_j^i = w_0^i$. Defining $\rho^i := w_0^i$ gives factorisation (C5'). \square

Theorem. The category **CPM** is a precausal category.

Proof. As noted in Example 2.8, discarding processes satisfying (C1) are given by the trace. For (C2), $d_{\mathcal{L}(H)} = \dim(H)^2$, which is invertible whenever $\dim(H) \neq 0$. (C3) follows from the fact that for any finite-dimensional Hilbert space H , we can find a basis of positive operators spanning $\mathcal{L}(H)$. Hence, by renormalising, we can also find a basis of trace-1 positive operators.

For (C4), we shall show (C4') and (C5').

Condition (C4') states that

$$\text{tr}_{B'}(\Phi) = \Phi' \implies \Phi = (1_{A'} \otimes \Phi_2) \circ (\Phi_1 \otimes 1_B)$$

This is precisely the result of [19] and is based on the fact that minimal Stinespring dilations are related by a unitary.

For (C5'), a causal map $\Phi : A \rightarrow B$ in **CPM** is a completely positive trace preserving map. Such a map can always be written as

$$\begin{array}{c} | \\ \boxed{\Phi} \\ | \end{array} = \frac{1}{d_B} \begin{array}{c} \underline{\text{---}} \\ | \\ \underline{\text{---}} \end{array} + \sum_{i \neq 0, j} r_{i,j} \begin{array}{c} \triangleleft i \\ \triangleleft j \\ | \end{array}$$

where the states and effects labeled with i (j) form a basis for B (A^*), with the 0-th basis element the maximally mixed state (discard effect). Now if any second order causal effect w does not split as in (C5'), we can always change the value of some of the $r_{i,j}$ such that Φ is still positive, but $w(\Phi) \neq 1$. \square

A.3. Proofs that **Rel** is only weakly pre-causal.

Theorem. The category **Rel** satisfies axioms (C1)-(C3) and (C4').

Proof. It will be convenient to write relations as (possibly infinite) matrices taking entries the booleans. That is, a relation $f \subseteq A \times B$ is equivalently represented as the following boolean matrix:

$$\left\{ f_i^j \in \mathbb{B} \mid i \in A, j \in B \right\}$$

Relation composition then becomes:

$$h_i^k := \sum_j f_i^j g_j^k$$

where we interpret multiplication as meet and (possibly infinite) summation as join.

For (C1), the discarding map for any system A is the relation which relates every $i \in A$ to $*$ in $I := \{*\}$. That is:

$$\underline{\text{---}}_i = 1$$

This clearly respects the monoidal structure. Using this definition of discarding, causal relations are those f such that for all $i \in A$ there exists $j \in B$ such that $f_i^j = 1$.

The empty set is the zero object in **Rel**. The definition of discarding yields that $d_A = 1$ for all non-empty sets A , hence (C2) is satisfied.

(C3) is immediate consequence of the fact that all singletons $\{i\} \subseteq A$ are causal states in **Rel**.

(C4') can be proven in almost the same way as for **Mat**(\mathbb{R}_+). That only difference is we no longer need to use division in the definition of Φ_2 , because 0 and 1 are the only possible values that $(\Phi')_i^{k'}$ can take:

$$\begin{aligned} (\Phi_1)_i^{k'k} &= (\Phi')_i^k \delta_{ii'} \delta_{kk'} \\ (\Phi_2)_{i'k'j}^l &= \begin{cases} \delta_{0l} & \text{if } (\Phi')_i^{k'} = 0 \\ \Phi_{ij}^{k'l} & \text{if } (\Phi')_i^{k'} = 1 \end{cases} \end{aligned}$$

These are causal, and by case distinction on $(\Phi^l)_i^{k'} \in \{0, 1\}$, we can see that:

$$\sum_{i'k'} (\Phi_1)_{i'}^{k'i'k'} (\Phi_2)_{i'l'k'j}^l = \Phi_{ij}^{kl} \quad \square$$

Theorem. The category **Rel** does not satisfy (C5').

Proof. Causality means for all i , there exists j such that $f_i^j = 1$. The dual condition for causality is obtained by reversing the quantifies. That is, for some relation w :

$$f \text{ causal} \implies \sum_{ij} f_i^j w_j^i = 1 \quad (\text{A.2})$$

if and only if there exists some j such that for all i , $w_j^i = 1$.

(C5') requires that any such w must be independent of i . That is, $w_j^i = \rho^i$. However, $w \subseteq \mathbb{B} \times \mathbb{B}$ defined by $w_j^i := \neg(i \wedge j)$ satisfies (A.2), but is not independent of i . \square

A.4. Proof of embedding into the type of all causal processes.

Theorem (6.13). Any object X built inductively from first order systems $A_1, \dots, A_m, A'_1, \dots, A'_n$ has a canonical embedding of the form:

$$e : X \rightarrow (A_1 \otimes \dots \otimes A_m \multimap A'_1 \otimes \dots \otimes A'_n)$$

whose underlying \mathcal{C} -morphism is just a permutation of systems.

Proof. Given X built inductively from first-order types via the *-autonomous structure, we can replace $A \multimap B$ with $A^* \wp B$ and push the $(-)^*$ inside as far as possible via application of the following isomorphisms from left-to-right:

$$(A \otimes B)^* \cong A^* \wp B^* \quad (A \wp B)^* \cong A^* \otimes B^*$$

We can then apply $A^{**} \cong A$ to reduce X to an expression consisting of either first-order types or their duals, combined with \otimes and \wp . For example, if $X := A_1 \multimap (A'_1 \multimap A_2) \multimap A'_2$, we have:

$$\begin{aligned} X &:= A_1 \multimap (A'_1 \multimap A_2) \multimap A'_2 \\ &\cong A_1^* \wp ((A'_1)^* \wp A_2)^* \wp A'_2 \\ &\cong A_1^* \wp ((A'_1)^{**} \otimes A_2^*) \wp A'_2 \\ &\cong A_1^* \wp (A'_1 \otimes A_2^*) \wp A'_2 \end{aligned}$$

It was then noted in section 4 that there is a canonical embedding $A \otimes B \hookrightarrow A \wp B$. We then apply this embedding to eliminate all \otimes 's, and then apply a permutation in \mathcal{C} to sort all of the dual first-order systems to the left. Continuing the example, we have:

$$\begin{aligned} X &\cong A_1^* \wp (A'_1 \otimes A_2^*) \wp A'_2 \\ &\hookrightarrow A_1^* \wp A'_1 \wp A_2^* \wp A'_2 \\ &\stackrel{(\dagger)}{\cong} A_1^* \wp A_2^* \wp A'_1 \wp A'_2 \end{aligned}$$

We can then pull the $(-)^*$ out as far as possible and re-introduce the \multimap . Then, by Corollary 5.5, we can always replace a \wp of first-order systems with a \otimes , which completes the embedding. Applying these steps to the running example yields:

$$\begin{aligned} X &\cong \mathbf{A}_1^* \wp \mathbf{A}_2^* \wp \mathbf{A}'_1 \wp \mathbf{A}'_2 \\ &\cong (\mathbf{A}_1 \otimes \mathbf{A}_2)^* \wp \mathbf{A}'_1 \wp \mathbf{A}'_2 \\ &\cong \mathbf{A}_1 \otimes \mathbf{A}_2 \multimap \mathbf{A}'_1 \wp \mathbf{A}'_2 \\ &\cong \mathbf{A}_1 \otimes \mathbf{A}_2 \multimap \mathbf{A}'_1 \otimes \mathbf{A}'_2 \end{aligned}$$

We complete the proof by noting that the only step not arising from an identity morphism in \mathcal{C} is the step marked (\dagger) above, which is a permutation. \square