

RENORMALIZED HENNINGS INVARIANTS AND 2+1-TQFTS

MARCO DE RENZI, NATHAN GEER, AND BERTRAND PATUREAU-MIRAND

ABSTRACT. We construct non-semisimple 2 + 1-TQFTs yielding mapping class group representations in Lyubashenko’s spaces. In order to do this, we first generalize Beliakova, Blanchet and Geer’s logarithmic Hennings invariants based on quantum \mathfrak{sl}_2 to the setting of finite-dimensional non-degenerate unimodular ribbon Hopf algebras. The tools used for this construction are a Hennings-augmented Reshetikhin-Turaev functor and modified traces. When the Hopf algebra is factorizable, we further show that the universal construction of Blanchet, Habegger, Masbaum and Vogel produces a 2+1-TQFT on a not completely rigid monoidal subcategory of cobordisms.

1. INTRODUCTION

Following Atiyah [2] a $d + 1$ -dimensional Topological Quantum Field Theory (TQFT) assigns to every closed oriented d -dimensional manifold Σ a vector space $V(\Sigma)$ and assigns to every compact oriented $d + 1$ -dimensional cobordism M from Σ to Σ' a linear map $V(M) : V(\Sigma) \rightarrow V(\Sigma')$. These vector spaces and maps should satisfy certain conditions, including tensor multiplicativity with respect to disjoint union and functoriality with respect to gluing of cobordisms. Atiyah’s axioms can then be stated as follows: a $d + 1$ -TQFT is a symmetric monoidal functor V from a category of cobordisms to the category of vector spaces over a field \mathbb{k} .

Understanding TQFTs in low dimensions has been especially successful. In particular, the Witten-Reshetikhin-Turaev 3-manifold invariants [58] coming from quantized simple Lie algebras are known to extend to 2 + 1-TQFTs, see [63]. These invariants and their TQFT extensions rely on a semisimple version of the representation theory of these algebraic structures. In [32], Hennings constructed an invariant of 3-manifolds from certain finite-dimensional quasitriangular Hopf algebras H which need not be semisimple (see also [34], where Kauffman and Radford gave a reformulation of the invariant avoiding the use of orientations). This construction is similar to the Reshetikhin-Turaev construction, except that Hennings uses the algebra H directly instead of its representation theory. Hennings’ invariant recovers the Reshetikhin-Turaev invariant when H is semisimple (see Lemma 1 of [36]).

If H is not semisimple then Hennings’ invariant is zero for manifolds with positive first Betti number, see [37, 53]. In particular, Hennings invariant vanishes on $S^1 \times S^2$, so it cannot be extended to a TQFT with Atiyah’s axioms and cobordisms, see [36]. However, Lyubashenko and Kerler [44, 45, 39, 36] showed that this invariant can still be associated to representations of the genus g mapping class group in the space of invariants of the g -fold tensor product of the coadjoint

All the authors would like to thank F. Costantino and the CIMI Excellence Laboratory for organizing the conference “Quantum Topology and Geometry” during the thematic semester “Invariants in Low Dimensional Geometry and Topology” in Toulouse, May 2017, where this work was initiated.

representation of H and, more generally, to a TQFT for cobordisms between connected surfaces with one boundary component. In the general case, Kerler [37] defined a *half-projective* TQFT which has weaker functoriality and monoidality properties. According to Kerler, the relation with the Reshetikhin-Turaev TQFT could pass through homological TQFT (see [38, 18]).

More recently, motivated by the volume conjecture, Jun Murakami combined the Hennings invariant associated with quantum \mathfrak{sl}_2 with the techniques of renormalized Reshetikhin-Turaev invariants to define a *generalized Kashaev invariant* of links in a 3-manifold [49]. These ideas were further generalized by Beliakova, Blanchet and the second author in [3].

This paper is organized into two main sections:

- (i) In the first part we generalize the logarithmic Hennings invariant of closed 3-manifolds given in [3] to the setting of finite-dimensional non-degenerate unimodular ribbon Hopf algebras;
- (ii) In the second part we extend the previous 3-manifold invariant to a full $2+1$ -TQFT satisfying all functoriality and monoidality properties in the case of finite-dimensional factorizable ribbon Hopf algebras.

To explain this work more precisely we will recall some past results.

Our construction relies on the *modified trace* defined in [28, 29, 31]. In non-semisimple representation theory the categorical trace can vanish for many modules. The modified trace is designed to replace the categorical trace in such situations. It is used to define Reshetikhin-Turaev-style 3-manifold invariants and TQFTs from the representation theory of the unrolled quantum group of \mathfrak{sl}_2 , see [11, 5, 13]. These TQFTs are based on the universal construction of Blanchet, Habegger, Masbaum and Vogel given in [6].

For the restricted version of quantum \mathfrak{sl}_2 , Beliakova, Blanchet and the second author construct a family of invariants of 3-manifolds endowed with bichrome colored links by combining Hennings' approach with the modified trace methods (see [3]). As we will now explain, our first major result is to give a further generalization and a reformulation of this construction.

We start with a finite-dimensional non-degenerate unimodular ribbon Hopf algebra H . Hopf algebras have been studied extensively, see for example the books [54, 61, 47]. Of particular interest for us are the references [10, 15, 41, 51, 42, 43, 52, 55, 56, 57, 59, 60, 62]. These papers contain many examples of the kinds of Hopf algebras we are considering.

If \mathcal{C} denotes the category of finite-dimensional left H -modules, then the associated Reshetikhin-Turaev functor $F_{\mathcal{C}}$ maps \mathcal{C} -colored ribbon graphs to H -module morphisms in \mathcal{C} . We think of edges of such graphs as being “blue”. In Subsection 2.2, we define an extension F_{λ} of $F_{\mathcal{C}}$ to bichrome graphs where we also allow “red” edges. These red edges are colored with the regular representation of H and have to be evaluated with a special element $\lambda \in H^*$ called the right integral, as in the Hennings invariant. We call F_{λ} the Hennings-Reshetikhin-Turaev functor. A closed \mathcal{C} -colored bichrome graph is *admissible* if it features at least one blue edge whose color is a projective module. By renormalizing with the modified trace, we also define a renormalized invariant F'_{λ} of admissible closed \mathcal{C} -colored bichrome graphs in S^3 .

We use F'_λ to define an invariant of closed 3-manifolds M containing admissible closed \mathcal{C} -colored bichrome graphs T . If $L \subset S^3$ is a surgery presentation for M then we can think of its ℓ components as being red and colored with the regular representation H , so that $L \cup T$ becomes a \mathcal{C} -colored bichrome graph in S^3 . Then we define

$$H'_\mathcal{C}(M, T) = \mathcal{D}^{-1-\ell} \delta^{-\sigma(L)} F'_\lambda(L \cup T)$$

where the first two factors are scalars depending only on the linking matrix of L , see Subsection 2.3. Properties of the Hennings-Reshetikhin-Turaev functor, of the modified trace and of the integral imply that this assignment is an isotopy invariant of $L \cup T$. Moreover, the integral and the normalization factor assure it is independent of the choice of the surgery link L . Thus, $H'_\mathcal{C}$ is a well-defined invariant of the pair (M, T) which can be thought of as a combination of Hennings' algebraic invariant with Reshetikhin and Turaev's categorical invariant which is renormalized by the modified trace.

As we mentioned before, the invariant $H'_\mathcal{C}$ is a generalization of the work of [3] to the setting of finite-dimensional non-degenerate unimodular ribbon Hopf algebras. More precisely, in Subsection 4.3 we show the following: when H is (a quasi-triangular extension of) the restricted version of quantum \mathfrak{sl}_2 , if the bichrome graph T has all of its blue edges colored with the regular representation H , and if it only has $(1, 1)$ -coupons, then the invariant $H'_\mathcal{C}$ recovers the *logarithmic Hennings invariant* of [3]. In addition, if the bichrome graph is a blue knot colored by the Steinberg-Kashaev representation of \mathfrak{sl}_2 , the invariant $H'_\mathcal{C}$ recovers Jun Murakami's *generalized Kashaev invariant* [49] of links in 3-manifolds, see Subsection 4.4. Finally, our invariant contains via connected sums the Hennings invariant H_H associated with H : if M and M' are closed connected 3-manifolds and T' is an admissible closed \mathcal{C} -colored bichrome graph inside M' then

$$H'_\mathcal{C}(M \# M', T) = H_H(M) H'_\mathcal{C}(M', T').$$

As explained above, when H is not semisimple the Hennings invariant can not be extended to a TQFT (in Atiyah's strict definition). However, the admissibility requirement on T and the modified trace allow us to obtain non-trivial vectors which are zero for the Hennings-Kerler-Lyubashenko TQFT. As we will now explain, this is the main tool we use to produce a fully monoidal functor.

In [6] Blanchet, Habegger, Masbaum and Vogel provide a universal TQFT construction which is completely determined, once a quantum invariant of closed 3-manifolds has been fixed, by the choice of the source cobordism category. In [5, 13] this procedure is applied to a setting of quantum invariants arising from generically semisimple categories. Suitable restrictions on the cobordism category allow for the integration of the modified trace in the process. Here we show that the universal construction can also be combined with the use of the integral to construct TQFTs from Hopf algebras with no semisimplicity requirements.

We consider a category of decorated cobordisms satisfying a certain admissibility condition, see Subsection 3.3. Loosely speaking, a decorated cobordism is obtained by generically cutting a 3-manifold containing an admissible graph along surfaces. Therefore objects in our category, denoted \mathbb{S} , are surfaces decorated with marked points corresponding to where the graph is cut. We use the admissibility requirements to dissymmetrize the category of cobordisms: there are

more restrictions for cobordisms with empty incoming boundary than for cobordisms with empty outgoing boundary. In other words, there are less morphisms of the form $\mathbb{M} : \emptyset \rightarrow \Sigma$ than morphisms of the form $\mathbb{M}' : \Sigma \rightarrow \emptyset$. This breaks Atiyah's involutory axiom asking that the TQFT space of $\overline{\Sigma}$ be dual to the TQFT space of Σ . The closed 3-manifold invariant $H'_{\mathcal{G}}$ induces a bilinear pairing

$$\langle \cdot, \cdot \rangle_{\Sigma} : \mathcal{V}'(\Sigma) \times \mathcal{V}(\Sigma) \rightarrow \mathbb{k}$$

on the vector spaces

$$\mathcal{V}(\Sigma) = \text{Span}_{\mathbb{k}}\{\mathbb{M} : \emptyset \rightarrow \Sigma\}, \quad \mathcal{V}'(\Sigma) = \text{Span}_{\mathbb{k}}\{\mathbb{M}' : \Sigma \rightarrow \emptyset\}.$$

The universal construction defines the vector spaces $V_{\mathcal{G}}(\Sigma)$ and $V'_{\mathcal{G}}(\Sigma)$ as the quotients of $\mathcal{V}(\Sigma)$ and $\mathcal{V}'(\Sigma)$ with respect to the right and left radicals of $\langle \cdot, \cdot \rangle_{\Sigma}$ respectively. We prove that properties of $H'_{\mathcal{G}}$ make $V_{\mathcal{G}}$ and $V'_{\mathcal{G}}$ into symmetric monoidal functors, and hence TQFTs.

Usually the vector spaces produced by the universal construction are not easy to determine. This is not the case in our situation. In fact they are isomorphic to the images of Lyubashenko's modular functor for H (see [45]). In particular, we denote with X the Hopf algebra H equipped with the left H -module structure whose dual is the coadjoint representation (X^* is the coend for the functor mapping every pair (V, V') of left H -modules to $V^* \otimes V'$). Then the space assigned to a genus g surface with no marked points is isomorphic to the space of H -invariant vectors in $X^{\otimes g}$. More generally, the TQFT vector space of an object Σ given by a genus g surface equipped with k marked points labeled by finite-dimensional H -modules V_1, \dots, V_k is isomorphic to $\text{Hom}_{\mathcal{G}}(V_1 \otimes \dots \otimes V_k, X^{\otimes g})$. Indeed, in Subsection 3.7 we give a bilinear pairing

$$\langle \cdot, \cdot \rangle_X : \mathcal{X}'_{g, \underline{V}} \times \tilde{\mathcal{X}}_{g, \underline{V}} \rightarrow \mathbb{k}$$

on the algebraic spaces

$$\tilde{\mathcal{X}}_{g, \underline{V}} = \text{Hom}_{\mathcal{G}}(H, X^{\otimes g} \otimes \underline{V}), \quad \mathcal{X}'_{g, \underline{V}} = \text{Hom}_{\mathcal{G}}((X^*)^{\otimes g} \otimes \underline{V}, \mathbb{1})$$

where $\underline{V} = V_1 \otimes \dots \otimes V_k$. Then the TQFT vector spaces $V_{\mathcal{G}}(\Sigma)$ and $V'_{\mathcal{G}}(\Sigma)$ are isomorphic to the quotients of $\tilde{\mathcal{X}}_{g, \underline{V}}$ and $\mathcal{X}'_{g, \underline{V}}$ with respect to the right and left radicals of $\langle \cdot, \cdot \rangle_X$ respectively, see Corollary 3.21. Since this pairing has trivial left radical we have isomorphisms

$$\mathcal{X}'_{g, \underline{V}} \cong V'_{\mathcal{G}}(\Sigma) \cong V_{\mathcal{G}}(\Sigma)^*.$$

If one of the modules V_i is projective then Σ is dualizable and there is a Verlinde formula (see Remark 3.16) expressing the dimension of Lyubashenko's spaces:

$$\dim_{\mathbb{k}}(\text{Hom}_{\mathcal{G}}((X^*)^{\otimes g} \otimes \underline{V}, \mathbb{1})) = H'_{\mathcal{G}}(\mathbb{S}^1 \times \Sigma).$$

With this in mind, we ask if there are applications of our work in the area of two-dimensional conformal quantum field theory (CFT). Modular (semisimple) tensor categories and their associated quantum invariants have been very useful tools in studying rational CFTs. As explained in [21], the analysis of non-rational CFTs is less understood. However, recently there has been several results proven in this area, see for example [7, 8, 12, 17, 19, 21, 22, 23, 24, 27, 25]. We can ask: does the non-semisimple TQFT of this paper play a similar role in non-rational CFTs as does the modular TQFT in rational CFTs?

Finally, the action of a Dehn twist along a curve $\gamma \subset \Sigma$ on $V'_{\mathcal{C}}(\Sigma)$ is given by the insertion of a red surgery curve parallel to γ with appropriate framing inside a cobordism from Σ to \emptyset , see Remark 3.22. These encircling red curves look similar to the operators introduced by Lyubashenko to define its modular functor. This leads us to conjecture that the modular functor induced by $V'_{\mathcal{C}}$ is equivalent to Lyubashenko's modular functor.

2. 3-MANIFOLD INVARIANTS FROM UNIMODULAR RIBBON HOPF ALGEBRAS

In this section we generalize the logarithmic Hennings 3-manifold invariants of [3] via a construction which applies to every finite-dimensional non-degenerate unimodular ribbon Hopf algebra.

2.1. Modified traces and stabilized categories of left modules. We start by recalling classical results on ribbon Hopf algebras. Standard references for the theory are provided by [61] and [54].

Let us fix for this section a finite-dimensional non-degenerate unimodular ribbon Hopf algebra H over a field \mathbb{k} . We briefly recall some of the definitions involved. The Hopf algebra H is a finite-dimensional vector space endowed with a multiplication $m : H \otimes H \rightarrow H$, a unit $\eta : \mathbb{k} \rightarrow H$, a coproduct $\Delta : H \rightarrow H \otimes H$, a counit $\varepsilon : H \rightarrow \mathbb{k}$, an antipode $S : H \rightarrow H$, an R-matrix $R = \sum_{i=1}^r a_i \otimes b_i \in H \otimes H$ and a ribbon element $v \in Z(H)$. We denote with u the Drinfeld element $\sum_{i=1}^r S(b_i)a_i \in H$ and with g the pivotal element $uv^{-1} \in H$. For the coproduct we will use Sweedler's notation $\Delta^{n-1}(x) = x_{(1)} \otimes \dots \otimes x_{(n)}$ which hides the summation. As a consequence of the finite-dimensionality of H , the antipode S is invertible.

A right integral of H is a linear form $\lambda \in H^*$ satisfying $\lambda f = f(1_H) \cdot \lambda$ for every $f \in H^*$. This means that $(\lambda f)(x) = (\lambda \otimes f)(\Delta(x)) = f(1_H)\lambda(x)$ for every $f \in H^*$ and every $x \in H$, or equivalently that $\lambda(x_{(1)}) \cdot x_{(2)} = \lambda(x) \cdot 1_H$ for every $x \in H$. A left cointegral of H is a vector $\Lambda \in H$ satisfying $x\Lambda = \varepsilon(x)\Lambda$ for every $x \in H$. Since H is finite-dimensional, right integrals form a 1-dimensional ideal in H^* and left cointegrals form a 1-dimensional ideal in H . Moreover every non-zero right integral $\lambda \in H^*$ and every non-zero left cointegral $\Lambda \in H$ satisfy $\lambda(\Lambda) \neq 0$. We fix therefore for the rest of the paper a choice of a right integral $\lambda \in H^*$ and of a left cointegral $\Lambda \in H$ satisfying $\lambda(\Lambda) = 1$. The Hopf algebra H being *unimodular* means that $S(\Lambda) = \Lambda$. Unimodularity of H implies λ is a *quantum character*: $\lambda(xy) = \lambda(S^2(y)x)$ for all $x, y \in H$. Finally, the fact that H is *non-degenerate* means that $\Delta_+ \Delta_- \neq 0$ where

$$\Delta_+ := \lambda(v^{-1}), \quad \Delta_- := \lambda(v).$$

Let \mathcal{C} be the ribbon linear category $H\text{-mod}$ of finite-dimensional left H -modules. For V an object of \mathcal{C} , we denote by $\rho_V : H \rightarrow \text{End}_{\mathbb{k}}(V)$ the associated representation. The unit of \mathcal{C} is $\mathbb{1} = \mathbb{k}$ with $\rho_{\mathbb{1}}(h) = \varepsilon(h) \cdot \text{id}_{\mathbb{k}}$ for every $h \in H$, and the dual of V is $V^* = \text{Hom}_{\mathbb{k}}(V, \mathbb{k})$ with $\rho_{V^*}(h) = (\rho_V(S(h)))^*$ for every $h \in H$. The duality structural morphisms of \mathcal{C} are denoted

$$\begin{aligned} \overleftarrow{\text{ev}}_V : V^* \otimes V &\rightarrow \mathbb{1}, & \overleftarrow{\text{coev}}_V : \mathbb{1} &\rightarrow V \otimes V^* \\ \overrightarrow{\text{ev}}_V : V \otimes V^* &\rightarrow \mathbb{1}, & \overrightarrow{\text{coev}}_V : \mathbb{1} &\rightarrow V^* \otimes V \end{aligned}$$

where the first two maps are given by the duality in $\text{Vect}_{\mathbb{k}}$, while the second two are twisted with the action of the pivotal element g .

We will denote with H the *regular representation of H* , which is the left H -module structure on H itself determined by the action $L : H \rightarrow \text{End}_{\mathbb{k}}(H)$ given by $L_h(x) = hx$ for all $h, x \in H$. Both H and its dual left module H^* are free rank one modules generated by 1_H and λ respectively. They are thus isomorphic via the *Radford map*

$$\begin{aligned} \varphi : H &\rightarrow H^* \\ x &\mapsto L_{S(x)}^*(\lambda). \end{aligned}$$

It is well known that $\varphi(\Lambda) = \varepsilon$ and that $\varphi^{-1}(f) = f(\Lambda_{(1)}) \cdot \Lambda_{(2)}$ for every $f \in H^*$, see [54, Section 10.2].

We will now recall the theory of modified traces. The *right partial trace* of an endomorphism $f \in \text{End}_{\mathcal{C}}(V \otimes V')$ is the endomorphism $\text{ptr}(f) \in \text{End}_{\mathcal{C}}(V)$ given by

$$\text{ptr}(f) := (\text{id}_V \otimes \overrightarrow{\text{ev}}_{V'}) \circ (f \otimes \text{id}_{V'^*}) \circ (\text{id}_V \otimes \overleftarrow{\text{coev}}_{V'}).$$

A *modified trace* t on the ideal of projective modules $\text{Proj}(\mathcal{C})$ is a family

$$t := \{t_V : \text{End}_{\mathcal{C}}(V) \rightarrow \mathbb{C} \mid V \in \text{Proj}(\mathcal{C})\}$$

of linear maps satisfying:

- (i) $t_V(f' \circ f) = t_{V'}(f \circ f')$ for all objects V, V' of $\text{Proj}(\mathcal{C})$ and all morphisms $f \in \text{Hom}_{\mathcal{C}}(V, V')$ and $f' \in \text{Hom}_{\mathcal{C}}(V', V)$,
- (ii) $t_{V \otimes V'}(f) = t_V(\text{ptr}(f))$ for all objects V of $\text{Proj}(\mathcal{C})$ and V' of \mathcal{C} and every morphism $f \in \text{End}_{\mathcal{C}}(V \otimes V')$.

Since \mathcal{C} is ribbon then it follows that a modified trace also satisfies an analogous left version of second condition of the definition, see [28, 31]. The existence of a modified trace was known under some conditions on H (see [26, 29]). The following result is a weaker version, for ribbon categories, of Theorem 1 in [4] by Beliakova, Blanchet and Gainutdinov.

Theorem 2.1. *There exists a unique modified trace t on $\text{Proj}(\mathcal{C})$ satisfying*

$$t_H(f) = \lambda(gf(1_H))$$

for every endomorphism f of the projective left H -module H , where g is the pivotal element of H . Furthermore, t is non-degenerate.¹

We fix from now on the choice of this modified trace. Remark that we get $t_H(\Lambda \circ \varepsilon) = \varepsilon(g)\lambda(\Lambda) = 1$ where $\Lambda : \mathbb{k} \rightarrow H$ denotes the unique morphism determined by $\Lambda(1) = \Lambda$.

We denote with $[n]\mathcal{C}$ the *n -th stabilized subcategory of \mathcal{C}* , which is the linear subcategory of \mathcal{C} whose objects are of the form $[n]V := H^{\otimes n} \otimes V$ for some object V of \mathcal{C} and whose morphisms from $[n]V$ to $[n]V'$ are linear combinations of the form $\sum_{i=1}^m L_{\underline{x}_i} \otimes f_i$ for some elements $\underline{x}_1, \dots, \underline{x}_m \in H^{\otimes n}$ and for some linear maps $f_1, \dots, f_m : V \rightarrow V'$. Remark that if $\sum_{i=1}^m L_{\underline{x}_i} \otimes f_i$ is a morphism of $[n]\mathcal{C}$ then neither $L_{\underline{x}_i}$, nor f_i , nor their tensor product is required to be H -invariant for any $i \in \{1, \dots, m\}$, but the linear combination $\sum_{i=1}^m L_{\underline{x}_i} \otimes f_i$ is.

¹There might exist modified traces on more general ideals of \mathcal{C} , but the non-degeneracy of t is related to the fact that $\text{Proj}(\mathcal{C})$ is the smallest non-zero ideal of \mathcal{C} .

If V and V' are objects of \mathcal{C} and if $n > 0$ then for every morphism $\sum_{i=1}^m L_{x_i} \otimes f_i$ in $\text{Hom}_{[n]\mathcal{C}}([n]V, [n]V')$ let us define

$$\int_{\mathcal{C}} \left(\sum_{i=1}^m L_{x_i} \otimes f_i \right) := \sum_{i=1}^m (\lambda \otimes \text{id}_{[n-1]V'}) \circ (L_{x_i} \otimes f_i) \circ (\eta \otimes \text{id}_{[n-1]V})$$

where $\eta : \mathbb{k} \rightarrow H$ is the unit of H .

Lemma 2.2. *The above assignment defines a linear map*

$$\int_{\mathcal{C}} : \text{Hom}_{[n]\mathcal{C}}([n]V, [n]V') \rightarrow \text{Hom}_{[n-1]\mathcal{C}}([n-1]V, [n-1]V').$$

Proof. Every morphism in $\text{Hom}_{[n]\mathcal{C}}([n]V, [n]V')$ can be written as $\sum_{i=1}^m L_{x_i} \otimes f_i$ for some $x_1, \dots, x_m \in H$ and some linear maps $f_1, \dots, f_m : [n-1]V \rightarrow [n-1]V'$, and we need to show that $\int_{\mathcal{C}}(\sum_{i=1}^m L_{x_i} \otimes f_i)$ is H -invariant. To do this we will use the properties of the Hopf algebra H : for every $h \in H$ we have

$$\varepsilon(h_{(1)}) \cdot h_{(2)} = h, \quad S(h_{(1)})h_{(2)} = \varepsilon(h) \cdot 1_H, \quad h_{(2)}S^{-1}(h_{(1)}) = \varepsilon(h) \cdot 1_H.$$

Now for every $h \in H$ we have

$$\begin{aligned} \int_{\mathcal{C}} \left(\sum_{i=1}^m L_{x_i} \otimes f_i \right) \circ \rho_W(h) &= \sum_{i=1}^m \lambda(x_i) \cdot f_i \circ \rho_W(h) \\ &= \sum_{i=1}^m \varepsilon(h_{(1)}) \lambda(x_i) \cdot f_i \circ \rho_W(h_{(2)}) \\ &= \sum_{i=1}^m \lambda(x_i h_{(2)} S^{-1}(h_{(1)})) \cdot f_i \circ \rho_W(h_{(3)}) \\ &= \sum_{i=1}^m \lambda(S(h_{(1)}) x_i h_{(2)}) \cdot f_i \circ \rho_W(h_{(3)}) \\ &= \sum_{i=1}^m \lambda(S(h_{(1)}) h_{(2)} x_i) \cdot \rho_{W'}(h_{(3)}) \circ f_i \\ &= \sum_{i=1}^m \varepsilon(h_{(1)}) \lambda(x_i) \cdot \rho_{W'}(h_{(2)}) \circ f_i \\ &= \sum_{i=1}^m \lambda(x_i) \cdot \rho_{W'}(h) \circ f_i \\ &= \rho_{W'}(h) \circ \int_{\mathcal{C}} \left(\sum_{i=1}^m L_{x_i} \otimes f_i \right), \end{aligned}$$

where the fourth equality follows from the fact that λ is a quantum character and the fifth equality results from $\sum_{i=1}^m L_{x_i} \otimes f_i$ being H -invariant. \square

2.2. Hennings-Reshetikhin-Turaev functor for string link graphs. In this subsection we construct a family of functors defined on certain categories of \mathcal{C} -colored ribbon graphs featuring red and blue edges. Red edges are related to the Hennings invariant: they are colored with the regular representation of H and when they form closed components they are evaluated using the right integral λ . Blue edges are somewhat more standard: they can be colored with any representation of H and they are evaluated using the Reshetikhin-Turaev functor $F_{\mathcal{C}}$.

The standard reference for ribbon graphs, ribbon categories and their associated Reshetikhin-Turaev functors is [63].

By a *closed manifold* we mean a compact manifold without boundary. Every manifold we will consider in this paper will be oriented, every diffeomorphism of manifolds will be positive, and every link will be oriented and framed. If Y is a manifold then we denote with \bar{Y} the manifold obtained from Y by reversing its orientation. The interval $[0, 1]$ will always be denoted I .

An *n -string link* is an (n, n) -tangle whose i -th incoming boundary vertex is connected to the i -th outgoing boundary vertex by an edge directed from bottom to top for every $1 \leq i \leq n$.

A *bichrome graph* is a ribbon graph with edges divided into two groups, red and blue, satisfying the following condition: for every coupon there exists a number $k \geq 0$ such that the first k input legs and the first k output legs are red with positive orientation, meaning incoming and outgoing respectively, while all the other ones are blue. Red edges will be represented graphically by dashed-dotted lines. This will allow the reader to distinguish them from blue edges also in black and white versions of the paper.

The *smoothing* of a bichrome graph is the red tangle obtained by throwing away every blue edge and by replacing every coupon with red vertical strands connecting every red input leg with the corresponding red output leg as shown in Figure 1.

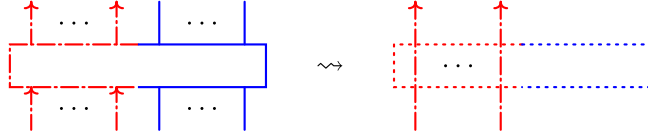

FIGURE 1. Smoothing of a coupon.

An *n -string link graph* is a bichrome graph satisfying the following conditions:

- (i) the first n incoming boundary vertices and the first n outgoing boundary vertices are red, while all the other ones are blue;
- (ii) the red tangle obtained by smoothing is an n -string link.

For an example of a 2-string link graph see Figure 2.

Next we define the *category $[n]\mathcal{R}_\lambda$ of \mathcal{C} -colored n -string link graphs*. An object $[n](\underline{\varepsilon}, \underline{V})$ of $[n]\mathcal{R}_\lambda$ is a finite sequence

$$\underbrace{((+, H), \dots, (+, H))}_n, (\varepsilon_1, V_1), \dots, (\varepsilon_k, V_k)$$

where $\varepsilon_i \in \{+, -\}$ is a sign and V_i is an object of \mathcal{C} for all $i \in \{1, \dots, k\}$. A morphism $T : [n](\underline{\varepsilon}, \underline{V}) \rightarrow [n](\underline{\varepsilon}', \underline{V}')$ of $[n]\mathcal{R}_\lambda$ is an isotopy class of embeddings in $\mathbb{R}^2 \times [0, 1]$ of \mathcal{C} -colored n -string link graphs from $[n](\underline{\varepsilon}, \underline{V})$ to $[n](\underline{\varepsilon}', \underline{V}')$, where \mathcal{C} -colorings of bichrome graphs are required to assign the color H to every red edge and to assign a morphism of $[k]\mathcal{C}$ to every coupon having $2k$ red legs. The category $[0]\mathcal{R}_\lambda$ will just be denoted \mathcal{R}_λ .

A morphism of $[n]\mathcal{R}_\lambda$ is *open* if its smoothing features no closed component. We denote with $[n]\mathcal{R}_\mathcal{E}$ the subcategory of $[n]\mathcal{R}_\lambda$ having the same objects but featuring only open morphisms.

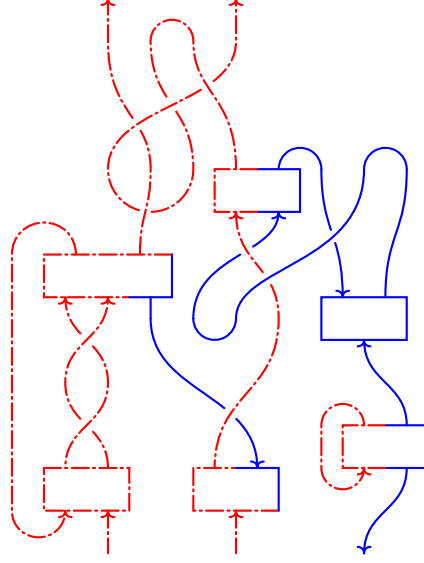

FIGURE 2. A 2-string link graph.

Remark 2.3. The forgetful functor from $[n]\mathcal{R}_{\mathcal{C}}$ to the ribbon category $\mathcal{R}_{\mathcal{C}}$ of \mathcal{C} -colored ribbon graphs allows us to define the Reshetikhin-Turaev functor $F_{\mathcal{C}}$ on $[n]\mathcal{R}_{\mathcal{C}}$ by dropping the distinction between red and blue edges.

Proposition 2.4. *The Reshetikhin-Turaev functor $F_{\mathcal{C}} : [n]\mathcal{R}_{\mathcal{C}} \rightarrow \mathcal{C}$ factors through $[n]\mathcal{C}$ for every $n \in \mathbb{N}$.*

Proof. Let us consider the category $\mathcal{B}_{\text{Vect}_k}$ defined as the quotient of the free linear category generated by $\mathcal{R}_{\text{Vect}_k}$ with respect to the Reshetikhin-Turaev functor F_{Vect_k} . This means $\mathcal{B}_{\text{Vect}_k}$ has the same objects as $\mathcal{R}_{\text{Vect}_k}$, while vector spaces of morphisms of $\mathcal{B}_{\text{Vect}_k}$ are given by quotients of free vector spaces generated by morphism spaces of $\mathcal{R}_{\text{Vect}_k}$ with respect to kernels of the linear maps defined by F_{Vect_k} . In the category $\mathcal{B}_{\text{Vect}_k}$ we represent certain morphisms in bead notation. A bead is a dot labeled with an element of H lying on an edge colored with an object of \mathcal{C} inside a morphism of $\mathcal{B}_{\text{Vect}_k}$. It represents a coupon in $\mathcal{R}_{\text{Vect}_k}$ determined as follows: if $\rho_V : H \rightarrow \text{End}_k(V)$ is a finite-dimensional representation of H then a bead labeled with $x \in H$ on a strand colored with V represents a coupon colored with $\rho_V(x)$ if the strand is directed upwards, while it represents a coupon colored with $\rho_V(S(x))^*$ if the strand is directed downwards. See Figure 3 for a graphical representation. Remark that these coupons are not in general coupons in $\mathcal{R}_{\mathcal{C}}$ because $\rho_V(x)$ may not be an H -module morphism.

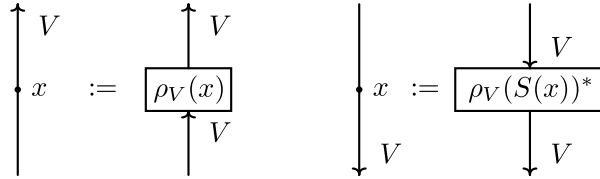

FIGURE 3. Beads.

We claim the functor $F_{\mathcal{C}} : [n]\mathcal{R}_{\mathcal{C}} \rightarrow \mathcal{C}$ factors through $\mathcal{B}_{\text{Vect}_k}$. Indeed we have a bead functor $B_{\mathcal{C}} : [n]\mathcal{R}_{\mathcal{C}} \rightarrow \mathcal{B}_{\text{Vect}_k}$ which is the identity on objects and which has the following behaviour on morphisms: given a diagram for a morphism of $[n]\mathcal{R}_{\mathcal{C}}$ which is presented as a composition of tensor products of elementary ribbon graphs, the functor $B_{\mathcal{C}}$ introduces beads on crossings, caps and cups and takes linear combinations of the morphisms thus obtained. Figure 4 contains a graphical definition for the image under $B_{\mathcal{C}}$ of some of the generating morphisms of $[n]\mathcal{R}_{\mathcal{C}}$.

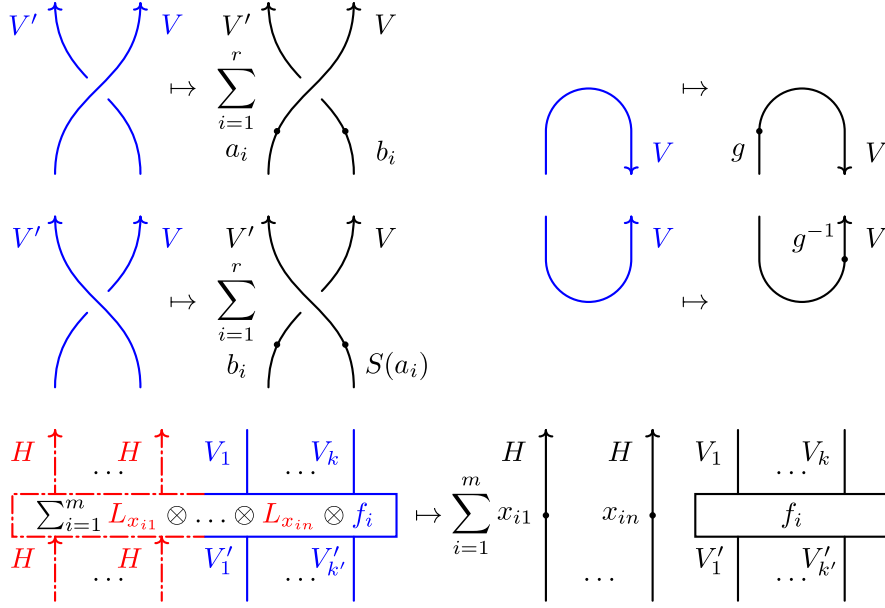
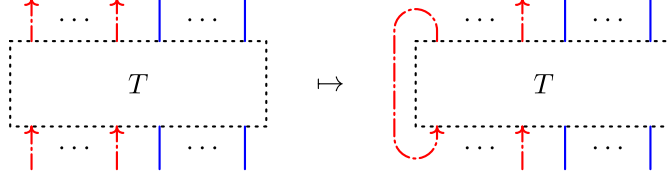

FIGURE 4. Graphical definition of the functor $B_{\mathcal{C}}$.

The functor $B_{\mathcal{C}}$ introduces no bead on left caps and cups. If a crossing is obtained from one of the two represented in Figure 4 by reversing the orientation of an edge then the label of the corresponding bead has to be replaced with its image under the antipode S . The definition is the same for crossings involving red edges and for red caps and cups.

Now the composition of the Reshetikhin-Turaev functor $F_{\mathcal{C}} : [n]\mathcal{R}_{\mathcal{C}} \rightarrow \mathcal{C}$ with the forgetful functor from \mathcal{C} to Vect can be computed as the composition of the bead functor $B_{\mathcal{C}} : [n]\mathcal{R}_{\mathcal{C}} \rightarrow \mathcal{B}_{\text{Vect}_k}$ with the functor from $\mathcal{B}_{\text{Vect}_k}$ to Vect induced on the quotient by F_{Vect_k} . This makes it clear that morphisms in the image of $F_{\mathcal{C}}$ are linear combinations of the form $\sum_{i=1}^m L_{x_{i1}} \otimes \dots \otimes L_{x_{in}} \otimes f_i$ for some elements $\underline{x}_1, \dots, \underline{x}_m$ of $H^{\otimes n}$ and for some linear maps f_1, \dots, f_m . \square

Now if $(\underline{\varepsilon}, \underline{V})$ and $(\underline{\varepsilon}', \underline{V}')$ are objects of $\mathcal{R}_{\mathcal{C}}$ and $n > 0$ let us consider the map $\int_{\mathcal{R}} : \text{Hom}_{[n]\mathcal{R}_{\lambda}}([n](\underline{\varepsilon}, \underline{V}), [n](\underline{\varepsilon}', \underline{V}')) \rightarrow \text{Hom}_{[n-1]\mathcal{R}_{\lambda}}([n-1](\underline{\varepsilon}, \underline{V}), [n-1](\underline{\varepsilon}', \underline{V}'))$ defined by the braid closure of the leftmost red strand represented in Figure 5.

FIGURE 5. Graphical definition of the map $\int_{\mathcal{R}}$.

Proposition 2.5. *There exists a unique family of functors $F_\lambda : [n]\mathcal{R}_\lambda \rightarrow \mathcal{C}$ extending $F_{\mathcal{C}} : [n]\mathcal{R}_{\mathcal{C}} \rightarrow \mathcal{C}$ for every $n \in \mathbb{N}$ and satisfying*

$$\int_{\mathcal{C}} \circ F_\lambda = F_\lambda \circ \int_{\mathcal{R}}.$$

Proof. When T is a morphism of $[n]\mathcal{R}_\lambda$ then we say a morphism T' of $[n+k]\mathcal{R}_{\mathcal{C}}$ is obtained by *opening* T if

$$\underbrace{\int_{\mathcal{R}} \cdots \int_{\mathcal{R}}}_{k} T' = T.$$

We want to construct a family of functors $F_\lambda : [n]\mathcal{R}_\lambda \rightarrow \mathcal{C}$ with the desired properties. Let us define it as follows: if $[n](\underline{\varepsilon}, \underline{V})$ is an object of $[n]\mathcal{R}_\lambda$ then we set $F_\lambda([n](\underline{\varepsilon}, \underline{V})) := F_{\mathcal{C}}([n](\underline{\varepsilon}, \underline{V}))$. If T is a morphism of $[n]\mathcal{R}_\lambda$ then we set

$$F_\lambda(T) := \underbrace{\int_{\mathcal{C}} \cdots \int_{\mathcal{C}}}_{k} F_{\mathcal{C}}(T')$$

where T' is a morphism of $[n+k]\mathcal{R}_{\mathcal{C}}$ obtained by opening T for some $k \geq 0$.

The proof that F_λ is well-defined requires a little preparation, as we need to introduce some terminology. First of all, we need to consider a stabilization functor

$$[1] : [n]\mathcal{R}_\lambda \rightarrow [n+1]\mathcal{R}_\lambda$$

mapping every object $[n](\underline{\varepsilon}, \underline{V})$ of $[n]\mathcal{R}_\lambda$ to the object $[n+1](\underline{\varepsilon}, \underline{V})$ of $[n+1]\mathcal{R}_\lambda$ and mapping every morphism T of $\text{Hom}_{[n]\mathcal{R}_\lambda}([n](\underline{\varepsilon}, \underline{V}), [n](\underline{\varepsilon}', \underline{V}'))$ to the morphism of $\text{Hom}_{[n+1]\mathcal{R}_\lambda}([n+1](\underline{\varepsilon}, \underline{V}), [n+1](\underline{\varepsilon}', \underline{V}'))$ represented in Figure 6. We denote with $[k]$ the k -fold composition of the functor $[1]$.

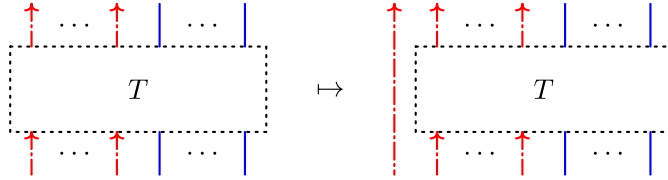
FIGURE 6. Graphical definition of the functor $[1]$.

We say a set C of red edges of a morphism T of $[n]\mathcal{R}_\lambda$ is a *chain* if all of its elements are contained in one and the same component of the smoothing of T . A maximal chain in T is called a *cycle* if its corresponding component in the smoothing of T is closed, and it is called a *relative cycle* otherwise.

We want to show that if T is a morphism of $[n]\mathcal{R}_\lambda$ featuring exactly k cycles C_1, \dots, C_k then there exists a morphism of $[n+k]\mathcal{R}_{\mathcal{C}}$ which is obtained by opening

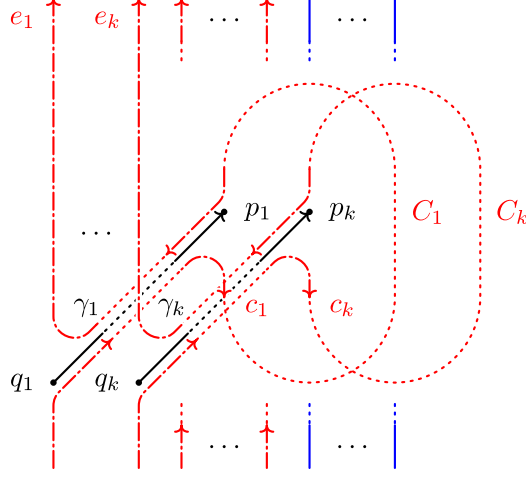
FIGURE 7. Diagram representing $([k]T)_\gamma$.

T . To define it we choose a point p_i along some red edge $c_i \in C_i$ and a point q_i along the red edge e_i connecting the i -th incoming boundary vertex to the i -th outgoing boundary vertex of $[k]T$ for all $i \in \{1, \dots, k\}$. Then we consider pairwise disjoint embeddings ι_1, \dots, ι_k of $D^1 \times D^1$ into $\mathbb{R}^2 \times I$ with $\iota_i((D^1 \setminus \partial D^1) \times D^1)$ contained in the complement of $[k]T$, with $(\iota_i(\{-1\} \times D^1), \iota_i(-1, 0)) \subset (c_i, p_i)$ and with $(\iota_i(\{1\} \times \overline{D^1}), \iota_i(1, 0)) \subset (e_i, q_i)$ for all $i \in \{1, \dots, k\}$ (see the beginning of this section for our notations and conventions about orientations). We denote with γ_i the path $\iota_i(D^1 \times \{0\})$ from q_i to p_i and we let $([k]T)_\gamma$ be the morphism of $[n+k]\mathcal{R}_\lambda$ obtained from $[k]T$ by index 1 surgery along ι_1, \dots, ι_k . Up to isotopy, this morphism can be represented by a diagram like the one depicted in Figure 7. Then by construction

$$\underbrace{\int_{\mathcal{R}} \dots \int_{\mathcal{R}}}_{k} ([k]T)_\gamma = T.$$

We first have to prove that $F_\lambda(T)$ does not depend on the choice of the embeddings ι_1, \dots, ι_k . Up to isotopy we can suppose regions of the diagram around γ_i locally look like Figure 8, possibly up to replacing blue strands with red strands. Just like in the proof of Proposition 2.4 we can compute $F_{\mathcal{G}}(([k]T)_\gamma)$ by passing through $\mathcal{B}_{\text{Vect}_k}$. Let us follow the i -th relative cycle $(C_i \cup e_i)_{\gamma_i}$ of $([k]T)_\gamma$ obtained from C_i and e_i by surgery along ι_i . We first collect beads along a parallel copy of γ_i which compose to give an element $x_{\gamma_i(2)}$. Then we meet a bead labeled with the pivotal element g and, moving on along the cycle C_i , we collect an element x_{C_i} . Finally the travel along a parallel copy of $\overline{\gamma_i}$ contributes with an element $S(x_{\gamma_i(1)})$. All of this follows from the analysis of the beads associated with local models coming from Figure 8, as summarized in Figure 9.

Let us denote with $([k]T)_\gamma \setminus (\underline{C} \cup \underline{e})_\gamma$ the morphism of $\mathcal{B}_{\text{Vect}_k}$ obtained from $B_{\mathcal{G}}(([k]T)_\gamma)$ by removing all edges corresponding to relative cycles $(C_i \cup e_i)_{\gamma_i}$ for all $i \in \{1, \dots, k\}$. Analogously, let us denote with $T \setminus \underline{C}$ the morphism of $\mathcal{B}_{\text{Vect}_k}$ obtained from $B_{\mathcal{G}}(T)$ by removing all edges corresponding to cycles C_i for all

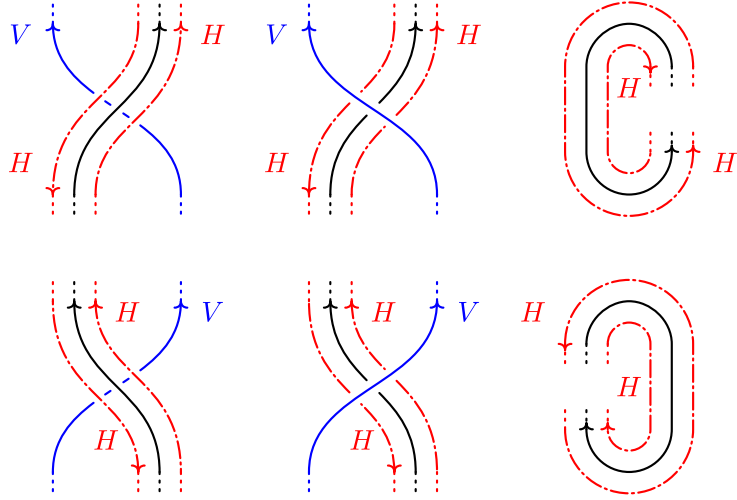

FIGURE 8. Local appearance of the surgered morphism $([k]T)_{\underline{\gamma}}$ around γ_i .

$i \in \{1, \dots, k\}$. Then

$$\begin{aligned}
 \underbrace{\int_{\mathcal{C}} \cdots \int_{\mathcal{C}}}_k F_{\mathcal{C}}([k]T)_{\underline{\gamma}} &= \left(\prod_{i=1}^k \lambda(S(x_{\gamma_i(1)})x_{C_i}g x_{\gamma_i(2)}) \right) \cdot F_{\text{Vect}_k}([k]T)_{\underline{\gamma}} \setminus (\underline{C} \cup \underline{e})_{\underline{\gamma}} \\
 &= \left(\prod_{i=1}^k \varepsilon(x_{\gamma_i}) \lambda(x_{C_i}g) \right) \cdot F_{\text{Vect}_k}([k]T)_{\underline{\gamma}} \setminus (\underline{C} \cup \underline{e})_{\underline{\gamma}} \\
 &= \left(\prod_{i=1}^k \lambda(x_{C_i}g) \right) \cdot F_{\text{Vect}_k}(T \setminus \underline{C}).
 \end{aligned}$$

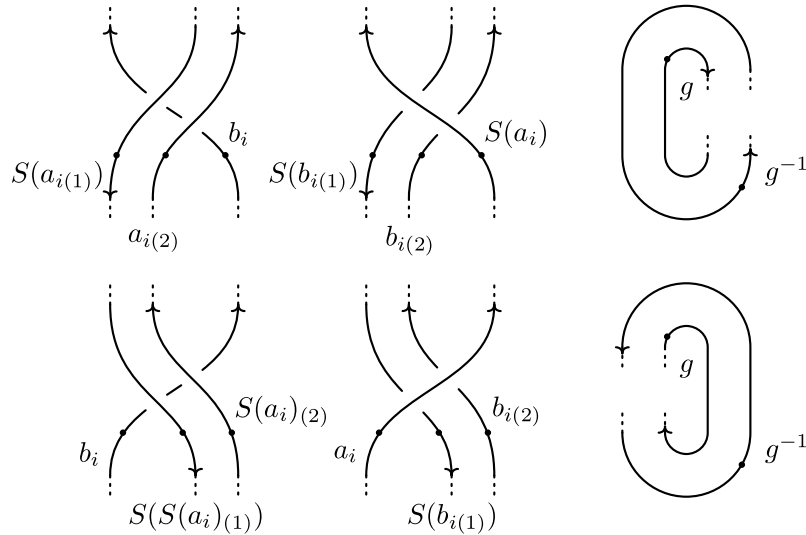

FIGURE 9. Beads around γ_i .

The second equality follows from λ being a quantum character, and the last equality follows from the fact that the pivotal element and the R-matrix of a quasitriangular Hopf algebra satisfy

$$\varepsilon(g) = \varepsilon(g^{-1}) = 1,$$

$$(\varepsilon \otimes \text{id}_H)(R) = (\text{id}_H \otimes \varepsilon)(R) = (\varepsilon \otimes \text{id}_H)(R^{-1}) = (\text{id}_H \otimes \varepsilon)(R^{-1}) = 1_H.$$

This proves that the definition of $F_\lambda(T)$ is actually independent of the choice of the embeddings ι_1, \dots, ι_k . The fact that it does not depend on the choice of the points p_i either follows from the fact that $\lambda \circ R_g^*$ is a character of H .

To prove the equality in the statement let us consider a morphism T in $[n]\mathcal{R}_\lambda$, and let us denote by $\sum_{i=1}^m L_{x_i} \otimes L_{\underline{x}_i} \otimes f_i$ its image under F_λ , with $x_i \in H$ and $\underline{x}_i \in H^{\otimes n-1}$ for every $i = 1, \dots, m$. Then

$$\int_{\mathcal{C}} F_\lambda(T) = \int_{\mathcal{C}} \left(\sum_{i=1}^m L_{x_i} \otimes L_{\underline{x}_i} \otimes f_i \right) = \sum_{i=1}^m \lambda(x_i) \cdot (L_{\underline{x}_i} \otimes f_i).$$

On the other hand

$$F_\lambda \left(\int_{\mathcal{R}} T \right) = \sum_{i=1}^m \lambda(x_i g^{-1} g) \cdot (L_{\underline{x}_i} \otimes f_i).$$

The unicity of the family of functors $F_\lambda : [n]\mathcal{R}_\lambda \rightarrow \mathcal{C}$ follows from the fact that every morphism T of $[n]\mathcal{R}_\lambda$ admits a morphism T' of $[n+k]\mathcal{R}_\lambda$ obtained by opening T . Then every family of functors F_λ satisfying

$$\int_{\mathcal{C}} \circ F_\lambda = F_\lambda \circ \int_{\mathcal{R}}$$

also satisfies

$$F_\lambda(T) = F_\lambda \left(\underbrace{\int_{\mathcal{R}} \dots \int_{\mathcal{R}} T'}_k \right) = \underbrace{\int_{\mathcal{C}} \dots \int_{\mathcal{C}} F_{\mathcal{C}}(T')}_k. \quad \square$$

For every $n \geq 0$ the functor $F_\lambda : [n]\mathcal{R}_\lambda \rightarrow \mathcal{C}$ is called the *Hennings-Reshetikhin-Turaev functor* associated with λ .

Remark 2.6. The definition we gave for $F_\lambda : [n]\mathcal{R}_\lambda \rightarrow \mathcal{C}$ in terms of $F_{\mathcal{C}}$ and $\int_{\mathcal{C}}$ makes it clear that this functor too factors through $[n]\mathcal{C}$.

2.3. Renormalized Hennings invariant of closed 3-manifolds. This subsection is devoted to the construction of a closed 3-manifold invariant relying on two main ingredients: the modified trace, whose existence is ensured by Theorem 2.1, and the Hennings-Reshetikhin-Turaev functor, which was introduced in Subsection 2.2. These tools allow for the definition of an invariant of closed \mathcal{C} -colored bichrome graphs satisfying a certain admissibility condition. Indeed, in order to be able to compute the modified trace, we need a blue edge whose color is a projective object of \mathcal{C} . With this in place, we can define a renormalized Hennings invariant of closed 3-manifolds equipped with admissible closed \mathcal{C} -colored bichrome graphs. Theorems 2.7 and 2.9 prove the existence of such invariants.

A bichrome graph featuring no boundary vertex is called a *closed bichrome graph*. When T is a closed \mathcal{C} -colored bichrome graph and V is a projective object

we say an endomorphism T_V of $(+, V)$ in \mathcal{R}_λ is a *cutting presentation* of T if

$$\overrightarrow{\text{ev}}_{(+, V)} \circ (T_V \otimes \text{id}_{(-, V)}) \circ \overleftarrow{\text{coev}}_{(+, V)} = T.$$

We say a \mathcal{C} -colored bichrome graph is *admissible* if it features a blue edge whose color is a projective H -module.

Theorem 2.7. *If T is an admissible closed \mathcal{C} -colored bichrome graph and T_V is a cutting presentation of T then*

$$F'_\lambda(T) := \text{tr}_V(F_\lambda(T_V))$$

is an invariant of the isotopy class of T .

Proof. The proof is similar to the one provided by [30]: indeed, the category \mathcal{R}_λ is a ribbon category with respect to the monoidal structure induced by concatenation of objects and disjoint union of morphisms. If T_V and $T_{V'}$ are two different cutting presentations of T , and $c_{V, V'}$ is the braiding morphism associated with objects $(+, V)$ and $(+, V')$, we can find an endomorphism $T_{V, V'}$ of $((+, V), (+, V'))$ such that $\text{ptr}(T_{V, V'}) = T_V$ and $\text{ptr}(c_{V, V'} \circ T_{V, V'} \circ c_{V, V'}^{-1}) = T_{V'}$. Then the properties of the modified trace imply

$$\begin{aligned} \text{tr}_V(F_\lambda(T_V)) &= \text{tr}_{V \otimes V'}(F_\lambda(T_{V, V'})) = \text{tr}_{V' \otimes V}(F_\lambda(c_{V, V'} \circ T_{V, V'} \circ c_{V, V'}^{-1})) \\ &= \text{tr}_{V'}(F_\lambda(T_{V'})). \end{aligned} \quad \square$$

We call F'_λ the *renormalized invariant of admissible closed \mathcal{C} -colored bichrome graphs*.

Proposition 2.8. *Let T, T' be two closed \mathcal{C} -colored bichrome graphs. If T' is admissible then*

$$F'_\lambda(T \otimes T') = F_\lambda(T)F'_\lambda(T').$$

Proof. If T'_V is a cutting presentation of T' then $T \otimes T'_V$ is a cutting presentation of $T \otimes T'$ and the proposition follows from the fact that $F_\lambda(T \otimes T'_V) = F_\lambda(T)F_\lambda(T'_V)$. \square

Recall the definition of the coefficients $\Delta_+ = \lambda(v^{-1})$ and $\Delta_- = \lambda(v)$ given at the beginning of Subsection 2.1. We fix now a choice of a square root \mathcal{D} of $\Delta_- \Delta_+$ and we define $\delta := \frac{\mathcal{D}}{\Delta_-} = \frac{\Delta_+}{\mathcal{D}}$. Remark that this is the first place we use the non-degeneracy of H .

Theorem 2.9. *If M is a closed connected 3-manifold and T is an admissible closed \mathcal{C} -colored bichrome graph inside M then*

$$\mathbb{H}'_{\mathcal{C}}(M, T) := \mathcal{D}^{-1-\ell} \delta^{-\sigma(L)} F'_\lambda(L \cup T)$$

only depends on the diffeomorphism class of the pair (M, T) , with L being a surgery presentation for M given by a red H -colored ℓ -component link inside S^3 and $\sigma(L)$ being the signature of the linking matrix of L .

Proof. The proof follows the argument of Reshetikhin and Turaev by showing that the quantity $\mathcal{D}^{-1-\ell} \delta^{-\sigma(L)} F'_\lambda(L \cup T)$ remains unchanged under orientation reversal of components of L and under Kirby moves. These properties are proved in Subsection 2.4: first of all, Proposition 2.12 implies that $F'_\lambda(L \cup T)$ is independent of the choice of the orientation of the surgery link L . Then, thanks to Proposition 2.13, $F'_\lambda(L \cup T)$ is also invariant under handle slides, known as the Kirby II move.

Finally, the invariance of $H'_{\mathcal{C}}(M, T)$ under stabilizations, known as the Kirby I move, follows from the choice of the normalization factor $\mathcal{D}^{-1-\ell}\delta^{-\sigma(L)}$, which is made possible by the non-degeneracy of H . \square

We call $H'_{\mathcal{C}}$ the *renormalized Hennings invariant of admissible decorated closed 3-manifolds*.

Remark 2.10. When we write $F'_{\lambda}(L \cup T)$ we are using a slightly abusive notation because T is actually contained in M . What we mean is that we have a diffeomorphism between $S^3(L)$ and M , and that T can be isotoped to be inside the image of the exterior of L in S^3 under this diffeomorphism. We can therefore pull back T to an admissible closed bichrome graph inside S^3 which is disjoint from L and which we still denote with T .

The renormalized Hennings invariant is related to the standard Hennings invariant H_H as follows.

Proposition 2.11. *If M and M' are closed connected 3-manifolds and T' is an admissible \mathcal{C} -colored bichrome graph inside M' then*

$$H'_{\mathcal{C}}(M \# M', T') = H_H(M) H'_{\mathcal{C}}(M', T').$$

Proof. It is enough to apply Proposition 2.8 to a surgery presentation for $M \# M'$ which is a disjoint union of two surgery presentations for M and M' . \square

2.4. Proof of the invariance. We conclude Section 2 with two results which were announced in the proof of Theorem 2.9.

Proposition 2.12. *Let T be a morphism of $[n]\mathcal{R}_{\lambda}$, let K be a closed red component of T disjoint from coupons and let T' be the morphism of $[n]\mathcal{R}_{\lambda}$ obtained by reversing the orientation of K . Then*

$$F_{\lambda}(T) = F_{\lambda}(T').$$

Similarly, if T is closed and admissible then $F'_{\lambda}(T) = F'_{\lambda}(T')$.

Proof. The proof follows from the analogous result for the Hennings invariant, and is very similar to the proof of Propositions 2.5. Indeed, we can first choose a diagram for T presenting K as the closure of a braid. Then we can compute $F_{\lambda}(T)$ and $F_{\lambda}(T')$ by passing through the bead functor $B_{\mathcal{C}}$. The contribution of K to $F_{\lambda}(T)$ is computed by picking a base point on K , by collecting all the beads we meet whilst travelling along K according to its orientation in order to obtain an element x_K of H and by evaluating the integral λ against $x_K g$. Therefore if $T \setminus (K \cup \underline{C})$ denotes the morphism of $\mathcal{B}_{\text{Vect}_k}$ obtained from $B_{\mathcal{C}}(T)$ by removing all components corresponding to cycles K, C_1, \dots, C_k we get

$$F_{\lambda}(T) = \lambda(x_K g) \left(\prod_{i=1}^k \lambda(x_{C_i} g) \right) \cdot F_{\text{Vect}_k}(T \setminus (K \cup \underline{C})).$$

Now $F_{\lambda}(T')$ is obtained from $F_{\lambda}(T)$ by applying S to all the beads we meet along K and by reversing the order of the multiplications. Then, since the morphism $T' \setminus (\overline{K} \cup \underline{C})$ of $\mathcal{B}_{\text{Vect}_k}$ obtained from $B_{\mathcal{C}}(T')$ by removing all components

corresponding to cycles $\overline{K}, C_1, \dots, C_k$ coincides with $T \setminus (K \cup \underline{C})$, we get

$$\begin{aligned} F_\lambda(T') &= \lambda(S(x_K)g) \left(\prod_{i=1}^k \lambda(x_{C_i}g) \right) \cdot F_{\text{Vect}_k}(T' \setminus (\overline{K} \cup \underline{C})) \\ &= \lambda(x_K g) \left(\prod_{i=1}^k \lambda(x_{C_i}g) \right) \cdot F_{\text{Vect}_k}(T \setminus (K \cup \underline{C})) \end{aligned}$$

where the last equality follows from Proposition 4.2 of [32]. The property for F'_λ follows now from the property for F_λ applied to cutting presentations. \square

Proposition 2.13. *Let T be a morphism of $[n]\mathcal{R}_\lambda$, let K be a closed red component of T disjoint from coupons and let e be an edge of T . Let T' be the morphism of $[n]\mathcal{R}_\lambda$ obtained by sliding e over K . Then*

$$F_\lambda(T) = F_\lambda(T').$$

Similarly, if T is closed and admissible then $F'_\lambda(T) = F'_\lambda(T')$.

Proof. Up to isotopy the slide of e over K is the operation which transforms the diagram represented in the left-hand side of Figure 10 into the right-hand one.

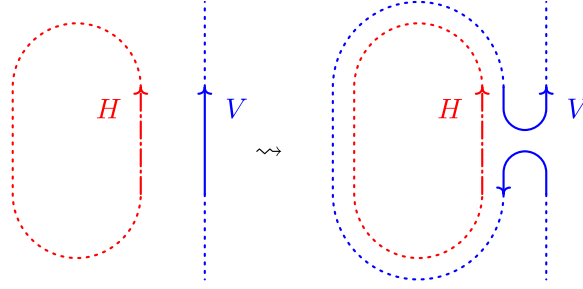

FIGURE 10. Slide of a V -colored blue edge e over an H -colored red component K . The edge e is also allowed to be red, in which case $V = H$.

If we choose a diagram for T' presenting K as the closure of a braid, regions around the edge e' resulting from the slide of e over K will locally look like Figure 11, possibly up to replacing V' -colored blue strands with H -colored red strands.

Just like in the proof of Proposition 2.5, we can compute $F_\lambda(T)$ and $F_\lambda(T')$ by passing through $\mathcal{B}_{\text{Vect}_k}$. As we showed in the proof of Proposition 2.5, we can compute the contribution of K to $F_\lambda(T)$ by picking a base point on K , by collecting all the beads we meet whilst travelling along K according to its orientation in order to obtain an element x_K of H , and by evaluating the integral λ against $x_K g$. Therefore if $T \setminus (K \cup \underline{C})$ denotes the morphism of $\mathcal{B}_{\text{Vect}_k}$ obtained from $B_{\mathcal{E}}(T)$ by removing all components corresponding to cycles K, C_1, \dots, C_k then we get

$$F_\lambda(T) = \lambda(x_K g) \left(\prod_{i=1}^k \lambda(x_{C_i}g) \right) \cdot F_{\text{Vect}_k}(T \setminus (K \cup \underline{C})).$$

Let us see how the slide of e over K affects this computation. If we follow e' we collect an element $S(x_{K(2)})$ and then we meet a bead labeled with $g^{-1} = S(g)$. At the same time the contribution of K to $F_\lambda(T')$ has changed to $\lambda(x_{K(1)}g)$. All

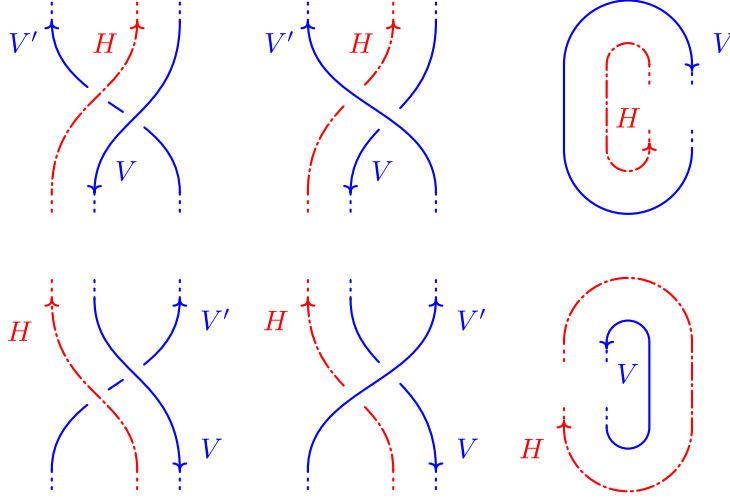
FIGURE 11. Local appearance of T' around the edge e' .

of this follows again from the analysis of the beads associated with local models coming from Figure 11, as summarized in Figure 12.

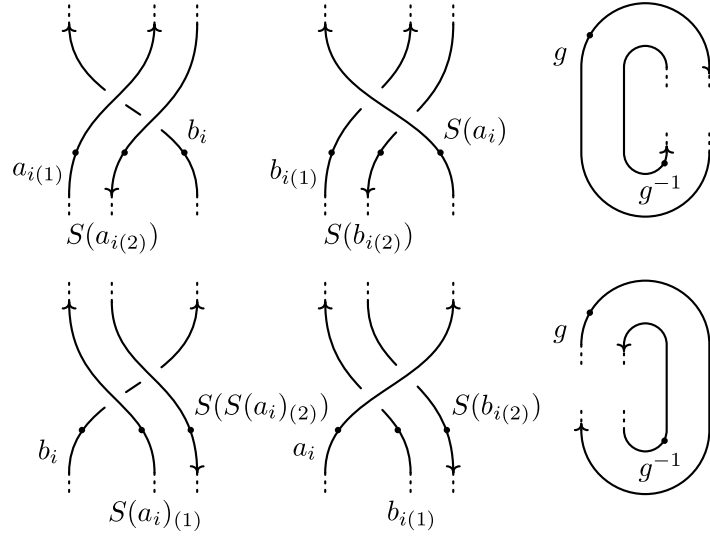
FIGURE 12. Beads around e' .

Therefore if $T' \setminus (K \cup \underline{C})$ denotes the morphism of $\mathcal{B}_{\text{Vect}_k}$ obtained from $B_{\mathcal{G}}(T')$ by removing all components corresponding to cycles K, C_1, \dots, C_k we get

$$\begin{aligned} F_{\lambda}(T') &= \lambda(x_{K(1)}g) \left(\prod_{i=1}^k \lambda(x_{C_i}g) \right) \cdot F_{\text{Vect}_k}(T' \setminus (K \cup \underline{C})) \\ &= \lambda(x_{Kg}) \left(\prod_{i=1}^k \lambda(x_{C_i}g) \right) \cdot F_{\text{Vect}_k}(T \setminus (K \cup \underline{C})), \end{aligned}$$

where the last equality follows from the fact that

$$\lambda(x_{K(1)}g) \cdot S(x_{K(2)}g) = \lambda(x_{Kg}) \cdot S(1_H) = \lambda(x_{Kg}) \cdot 1_H$$

because $F_{\text{Vect}_{\mathbb{k}}}(T' \setminus (K \cup \underline{C}))$ carries an $S(x_{K(2)}g)$ -labeled bead. The property for F'_λ follows now from the property for F_λ applied to cutting presentations. \square

3. 2+1-TQFTS FROM FACTORIZABLE HOPF ALGEBRAS

In this section we extend the renormalized Hennings invariants of Section 2 to 2+1-TQFTs in the case of finite-dimensional factorizable ribbon Hopf algebras. We also give an explicit characterization of the resulting TQFT vector spaces.

3.1. Algebraic TQFT spaces. We start with the definition of a family of vector spaces which will be later identified with the family of TQFT vector spaces coming from the functorial extension of the invariant $H'_{\mathcal{C}}$. In order to do this, we first need some preliminary work. Let us fix for this whole section a finite-dimensional factorizable ribbon Hopf algebra H . We recall that H being *factorizable* means that the Drinfeld map

$$\begin{aligned} \psi : H^* &\rightarrow H \\ f &\mapsto \sum_{i,j=1}^r f(b_j a_i) \cdot a_j b_i \end{aligned}$$

is an isomorphism. Then H is automatically unimodular, see for example [54]. Moreover H is also non-degenerate, as proven in Proposition 7.1 of [32]. In particular, we have a renormalized Hennings invariant $H'_{\mathcal{C}}$ associated with the category $\mathcal{C} = H\text{-mod}$. We will denote with X the *dual coadjoint representation of H* , which is the left H -module structure on H itself determined by the action $\rho_X : H \rightarrow \text{End}_{\mathbb{k}}(H)$ given by

$$\rho_X(h)(x) = h_{(2)}xS^{-1}(h_{(1)})$$

for all $h, x \in H$. The dual of X is the coend for the functor mapping every pair (V, V') of objects of \mathcal{C} to $V^* \otimes V'$, see [36, 45, 64].

Lemma 3.1. *The Radford map φ and the Drinfeld map ψ induce isomorphisms*

$$\varphi_X := \varphi \circ S \in \text{Hom}_{\mathcal{C}}(X, X^*), \quad \psi_X := S^{-1} \circ \psi \in \text{Hom}_{\mathcal{C}}(X^*, X)$$

satisfying $(\psi_X \circ \varphi_X)^* = \varphi_X \circ \psi_X$.

Proof. The fact that φ_X and ψ_X are invertible follows from the invertibility of φ , ψ and S . The H -equivariance of φ_X follows from the computation

$$\begin{aligned} \varphi_X(\rho_X(h)(x)) &= \lambda \circ L_{S^2(h_{(2)}xS^{-1}(h_{(1)}))} = \lambda \circ L_{S^2(h_{(2)})S^2(x)S(h_{(1)})} \\ &= \lambda \circ L_{S^2(x)} \circ \rho_X(S(h)) = \rho_{X^*}(h)(\varphi_X(x)) \end{aligned}$$

for every $x \in X$ and every $h \in H$, where the third equality follows from λ being a quantum character. The H -equivariance of ψ_X follows from the computation

$$\begin{aligned} \psi_X(\rho_{X^*}(h)(f)) &= \sum_{i,j=1}^r f(S(h_{(1)})b_j a_i h_{(2)}) \cdot S^{-1}(a_j b_i) \\ &= \sum_{i,j=1}^r f(b_j a_i) \cdot S^{-1}(h_{(1)}a_j b_i S(h_{(2)})) \\ &= \sum_{i,j=1}^r f(b_j a_i) \cdot h_{(2)}S^{-1}(a_j b_i)S^{-1}(h_{(1)}) = \rho_X(h)(\psi_X(f)) \end{aligned}$$

for every $f \in X^*$ and every $h \in H$, where the second equality follows from the properties of the R-matrix using the pivotal structure of \mathcal{E} . Finally, for every $f \in X^*$ and every $x \in X$, we have

$$\begin{aligned} (\varphi_X \circ \psi_X)(f)(x) &= \sum_{i,j=1}^r f(b_j a_i) \lambda(S(a_j b_i)x) = \sum_{i,j=1}^r f(S^{-1}(a_i b_j)) \lambda(b_i a_j x) \\ &= \sum_{i,j=1}^r f(S^{-1}(a_i b_j)) \lambda(S^2(x) b_i a_j) = f((\psi_X \circ \varphi_X)(x)) \\ &= (\psi_X \circ \varphi_X)^*(f)(x), \end{aligned}$$

where the second equality follows from the identity $(S \otimes S)(R) = R$. \square

Proposition 3.2. *For every $n \in \mathbb{N}$ and for all objects V, V' of \mathcal{E} there exist explicit isomorphisms*

$$\begin{aligned} \Theta &: \text{Hom}_{\mathcal{E}}(V, X^{\otimes n} \otimes V') \rightarrow \text{Hom}_{[n]\mathcal{E}}([n]V, [n]V'), \\ \Theta' &: \text{Hom}_{\mathcal{E}}((X^*)^{\otimes n} \otimes V, V') \rightarrow \text{Hom}_{[n]\mathcal{E}}([n]V, [n]V'). \end{aligned}$$

Before proving Proposition 3.2, we point out that the explicit isomorphisms we will choose will not be the simplest possible, but will instead be precisely the ones we will need in the following for an efficient description of TQFT vector spaces. In particular, we will use the morphisms introduced in the following lemma.

Lemma 3.3. *The linear maps*

$$\begin{aligned} \alpha : H \otimes X &\rightarrow H & \beta : H &\rightarrow H \otimes X \\ h \otimes x &\mapsto xh, & h &\mapsto \Lambda_{(1)} h \otimes S^{-1}(\Lambda_{(2)}) \end{aligned}$$

define morphisms in $\text{Hom}_{[1]\mathcal{E}}([1]X, [1]\mathbb{1})$ and in $\text{Hom}_{[1]\mathcal{E}}([1]\mathbb{1}, [1]X)$ satisfying

$$\int_{\mathcal{E}} (\beta \circ \alpha) = \int_{\mathcal{E}} (\ell_{\beta} \circ \ell_{\alpha}) = \text{id}_X,$$

$$\alpha \circ (\text{id}_H \otimes ((\lambda \otimes \text{id}_X) \circ \beta \circ L_h \circ \eta)) = \ell_{\alpha} \circ (\text{id}_H \otimes ((\lambda \otimes \text{id}_X) \circ \ell_{\beta} \circ L_h \circ \eta)) = L_h$$

for every $h \in H$, where ℓ_{α} and ℓ_{β} are the morphisms

$$\begin{aligned} \ell_{\alpha} &:= \alpha \circ (\text{id}_H \otimes (\psi_X \circ \varphi_X)) \in \text{Hom}_{[1]\mathcal{E}}([1]X, [1]\mathbb{1}), \\ \ell_{\beta} &:= (\text{id}_H \otimes (\psi_X \circ \varphi_X)^{-1}) \circ \beta \in \text{Hom}_{[1]\mathcal{E}}([1]\mathbb{1}, [1]X). \end{aligned}$$

Moreover, the morphisms

$$\begin{aligned} \alpha' &:= (\alpha \otimes \text{id}_{X^*}) \circ (\text{id}_H \otimes \overleftarrow{\text{coev}}_X) \in \text{Hom}_{[1]\mathcal{E}}([1]\mathbb{1}, [1]X^*), \\ \beta' &:= (\text{id}_H \otimes \overrightarrow{\text{ev}}_X) \circ (\beta \otimes \text{id}_{X^*}) \in \text{Hom}_{[1]\mathcal{E}}([1]X^*, [1]\mathbb{1}), \\ \ell_{\alpha'} &:= (\text{id}_H \otimes (\varphi_X \circ \psi_X)) \circ \alpha' \in \text{Hom}_{[1]\mathcal{E}}([1]\mathbb{1}, [1]X^*), \\ \ell_{\beta'} &:= \beta' \circ (\text{id}_H \otimes (\varphi_X \circ \psi_X)^{-1}) \in \text{Hom}_{[1]\mathcal{E}}([1]X^*, [1]\mathbb{1}) \end{aligned}$$

satisfy

$$\int_{\mathcal{E}} (\alpha' \circ \beta') = \int_{\mathcal{E}} (\ell_{\alpha'} \circ \ell_{\beta'}) = \text{id}_{X^*},$$

$$(\text{id}_H \otimes (\lambda \circ L_h \circ \beta' \circ (\eta \otimes \text{id}_{X^*}))) \circ \alpha' = (\text{id}_H \otimes (\lambda \circ L_h \circ \ell_{\beta'} \circ (\eta \otimes \text{id}_{X^*}))) \circ \ell_{\alpha'} = L_h$$

for every $h \in H$. Finally, the isomorphism $h_X := \varphi_X \circ \psi_X \circ \varphi_X \in \text{Hom}_{\mathcal{E}}(X, X^*)$ satisfies

$$h_X = \int_{\mathcal{E}} (\ell_{\alpha'} \circ \alpha) = \int_{\mathcal{E}} (\alpha' \circ \ell_{\alpha}).$$

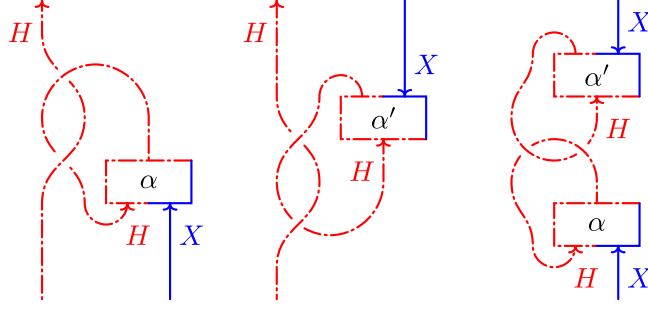

FIGURE 13. \mathcal{E} -Colored bichrome graphs representing the morphisms ℓ_α , $\ell_{\alpha'}$ and h_X respectively.

Proof. First, let us prove $\alpha \in \text{Hom}_{[1]\mathcal{E}}([1]X, [1]\mathbb{1})$. For every $h \in H$ we have

$$\begin{aligned}
\alpha \circ (L_{h_{(1)}} \otimes \rho_X(h_{(2)})) &= m \circ \tau \circ (L_{h_{(1)}} \otimes \rho_X(h_{(2)})) \\
&= m \circ (L_{h_{(3)}} \otimes L_{S^{-1}(h_{(2)})h_{(1)}}) \circ \tau \\
&= m \circ (L_{h_{(3)}} \otimes L_{S^{-1}(S(h_{(1)})h_{(2)})}) \circ \tau \\
&= \varepsilon(h_{(1)}) \cdot (m \circ (L_{h_{(2)}} \otimes \text{id}_H) \circ \tau) \\
&= m \circ (L_h \otimes \text{id}_H) \circ \tau = L_h \circ m \circ \tau = L_h \circ \alpha,
\end{aligned}$$

where $\tau(h \otimes x) := x \otimes h$ for every $h \otimes x \in H \otimes X$ and where m is the multiplication map. Furthermore, α can be written as $\sum_{i=1}^k L_{x_i} \otimes f_i$ where $\{x_1, \dots, x_k\}$ is a basis of X and $\{f_1, \dots, f_k\}$ is the corresponding dual basis of X^* . Next, in order to prove $\beta \in \text{Hom}_{[1]\mathcal{E}}([1]\mathbb{1}, [1]X)$, we will show that for every $h \in H$ we have the equality $(L_{h_{(1)}} \otimes \rho_X(h_{(2)})) \circ \beta \circ L_{S(h_{(3)})} = \varepsilon(h) \cdot \beta$, which is equivalent to the H -equivariance of β through the pivotal structure of \mathcal{E} . Indeed, for every $h \in H$ the left-hand side of the equality is given by

$$\begin{aligned}
L_{h_{(1)}\Lambda_{(1)}S(h_{(4)})} \otimes (h_{(3)}S^{-1}(\Lambda_{(2)})S^{-1}(h_{(2)})) \\
&= L_{h_{(1)}\Lambda_{(1)}S(h_{(4)})} \otimes S^{-1}(h_{(2)}\Lambda_{(2)}S(h_{(3)})) \\
&= L_{(\text{id}_H \otimes S^{-1}(\Delta(h_{(1)}\Lambda S(h_{(2)})))} \circ (\text{id}_H \otimes \eta) \\
&= \varepsilon(h) \cdot L_{\Lambda_{(1)}} \otimes S^{-1}(\Lambda_{(2)})
\end{aligned}$$

where the last equality follows from the fact that $h_{(1)}\Lambda S(h_{(2)}) = \varepsilon(h) \cdot \Lambda$. Now recall that the inverse φ^{-1} of the Radford map φ is given by $\varphi^{-1}(f) = f(\Lambda_{(1)}) \cdot \Lambda_{(2)}$ for every $f \in H^*$. Then for every $x \in X$ we have

$$\begin{aligned}
\int_{\mathcal{E}} (\beta \circ \alpha)(x) &= \lambda(\Lambda_{(1)}x) \cdot S^{-1}(\Lambda_{(2)}) = \lambda(S^2(x)\Lambda_{(1)}) \cdot S^{-1}(\Lambda_{(2)}) \\
&= S^{-1}(\varphi(S(x))(\Lambda_{(1)}) \cdot \Lambda_{(2)}) = S^{-1}(\varphi^{-1}(\varphi(S(x)))) = x.
\end{aligned}$$

This means $\int_{\mathcal{E}} (\beta \circ \alpha) = \text{id}_X$. Analogously, for all $h, h' \in H$ we have

$$\begin{aligned}
\alpha(h' \otimes (\lambda \otimes \text{id}_X)(\beta(h))) &= \lambda(\Lambda_{(1)}h) \cdot \alpha(h' \otimes S^{-1}(\Lambda_{(2)})) \\
&= \lambda(S^2(h)\Lambda_{(1)}) \cdot \alpha(h' \otimes S^{-1}(\Lambda_{(2)})) \\
&= \alpha(h' \otimes S^{-1}(\varphi(S(h))(\Lambda_{(1)}) \cdot \Lambda_{(2)})) \\
&= \alpha(h' \otimes S^{-1}(\varphi^{-1}(\varphi(S(h)))) = hh'.
\end{aligned}$$

Thus $\alpha \circ (\text{id}_H \otimes ((\lambda \otimes \text{id}_X) \circ \beta \circ L_h \circ \eta)) = L_h$. But now $\int_{\mathcal{E}}(\ell_\beta \circ \ell_\alpha)$ is given by

$$(\psi_X \circ \varphi_X)^{-1} \circ \left(\int_{\mathcal{E}} (\beta \circ \alpha) \right) \circ (\psi_X \circ \varphi_X) = \text{id}_X,$$

and analogously $\ell_\alpha \circ (\text{id}_H \otimes ((\lambda \otimes \text{id}_X) \circ \ell_\beta \circ L_h \circ \eta))$ is given by

$$\alpha \circ (\text{id}_H \otimes ((\psi_X \circ \varphi_X) \circ (\psi_X \circ \varphi_X)^{-1} \circ (\lambda \otimes \text{id}_X) \circ \beta \circ L_h \circ \eta)) = L_h.$$

The proof of the corresponding equalities for α' , β' , $\ell_{\alpha'}$, and $\ell_{\beta'}$ is similar. Now the equalities involving h_X follow from the fact that $\int_{\mathcal{E}}(\alpha' \circ \alpha) = \varphi_X$, which in turn follows from the computation

$$\int_{\mathcal{E}} (\alpha' \circ \alpha)(x)(x') = \lambda(x'x) = \lambda(S^2(x)x') = \varphi_X(x)(x')$$

for all $x, x' \in X$. Indeed, this means that

$$\begin{aligned} \int_{\mathcal{E}} (\alpha' \circ \ell_\alpha) &= \int_{\mathcal{E}} (\alpha' \circ \alpha) \circ (\psi_X \circ \varphi_X) = \varphi_X \circ \psi_X \circ \varphi_X = (\varphi_X \circ \psi_X) \circ \int_{\mathcal{E}} (\alpha' \circ \alpha) \\ &= \int_{\mathcal{E}} (\ell_{\alpha'} \circ \alpha). \end{aligned}$$

Finally, to see that ℓ_α is the image under the Hennings-Reshetikhin-Turaev functor F_λ of the first \mathcal{E} -colored bichrome graph represented in Figure 13, remark that for every $h \otimes x \in [1]X$ we have

$$\ell_\alpha(h \otimes x) = \sum_{i,j=1}^r \lambda(S^2(x)b_j a_i) \cdot S^{-1}(a_j b_i) h = \sum_{i,j=1}^r \lambda(S(a_j b_i)x) \cdot b_j a_i h.$$

An analogous computation shows that $\ell_{\alpha'}$ is the image under F_λ of the second \mathcal{E} -colored bichrome graph represented in Figure 13. \square

Proof of Proposition 3.2. We can define Θ as the map that sends every morphism f of $\text{Hom}_{\mathcal{E}}(V, X^{\otimes n} \otimes V')$ to the morphism $\Theta(f)$ of $\text{Hom}_{[n]\mathcal{E}}([n]V, [n]V')$ given by the image under F_λ of the \mathcal{E} -colored bichrome graph represented in Figure 14.

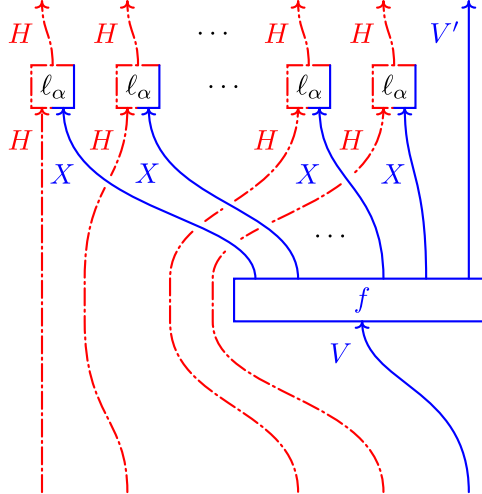

FIGURE 14. \mathcal{E} -Colored n -string link graph representing the morphism $\Theta(f)$ of $\text{Hom}_{[n]\mathcal{E}}([n]V, [n]V')$.

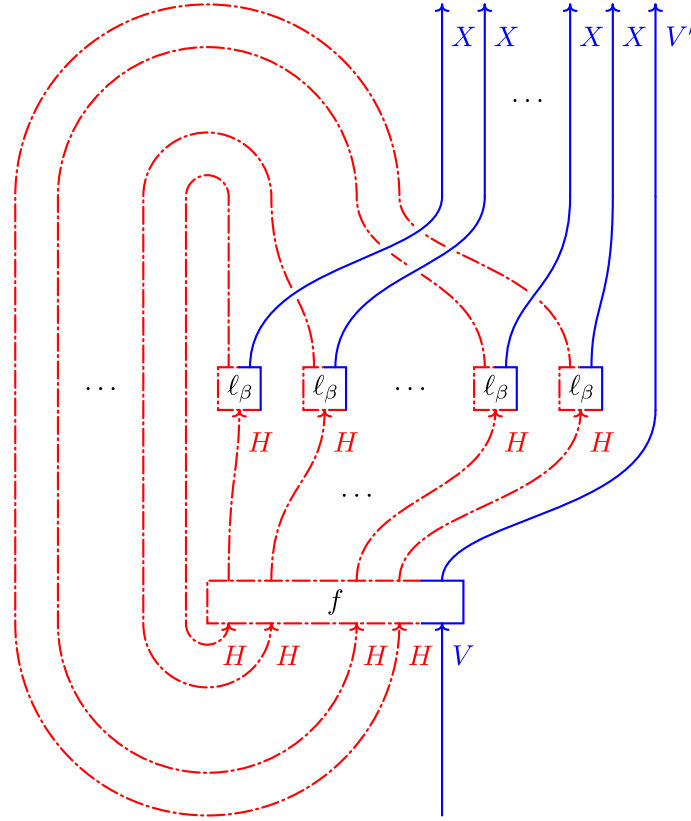

FIGURE 15. \mathcal{E} -Colored bichrome graph representing the morphism $\Theta^{-1}(f)$ of $\text{Hom}_{\mathcal{E}}(V, X^{\otimes n} \otimes V')$.

It is now relatively easy to see that Θ^{-1} is the map that sends every morphism f of $\text{Hom}_{[n]\mathcal{E}}([n]V, [n]V')$ to the morphism $\Theta^{-1}(f)$ of $\text{Hom}_{\mathcal{E}}(V, X^{\otimes n} \otimes V')$ given by the image under F_λ of the \mathcal{E} -colored bichrome graph represented in Figure 15.

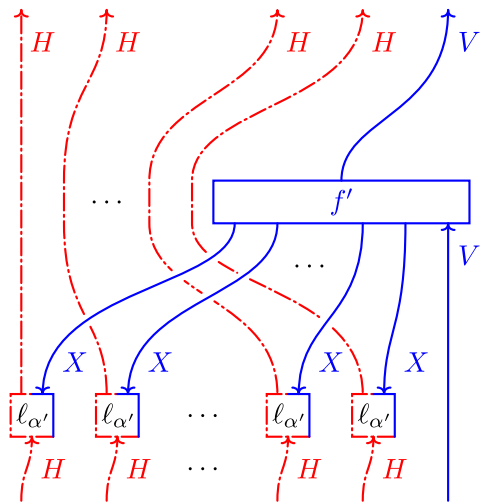

FIGURE 16. \mathcal{E} -Colored n -string link graph representing the morphism $\Theta'(f')$ of $\text{Hom}_{[n]\mathcal{E}}([n]V, [n]V')$.

Analogously, we can define Θ' as the map that sends every morphism f' of $\text{Hom}_{\mathcal{E}}((X^*)^{\otimes n} \otimes V, V')$ to the morphism $\Theta'(f')$ of $\text{Hom}_{[n]\mathcal{E}}([n]V, [n]V')$ given by the image under F_λ of the \mathcal{E} -colored bichrome graph represented in Figure 16.

It is now relatively easy to see that Θ'^{-1} is the map that sends every morphism f' of $\text{Hom}_{[n]\mathcal{E}}([n]V, [n]V')$ to the morphism $\Theta'^{-1}(f')$ of $\text{Hom}_{\mathcal{E}}(V, X^{\otimes n} \otimes V')$ given by the image under F_λ of the \mathcal{E} -colored bichrome graph represented in Figure 17.

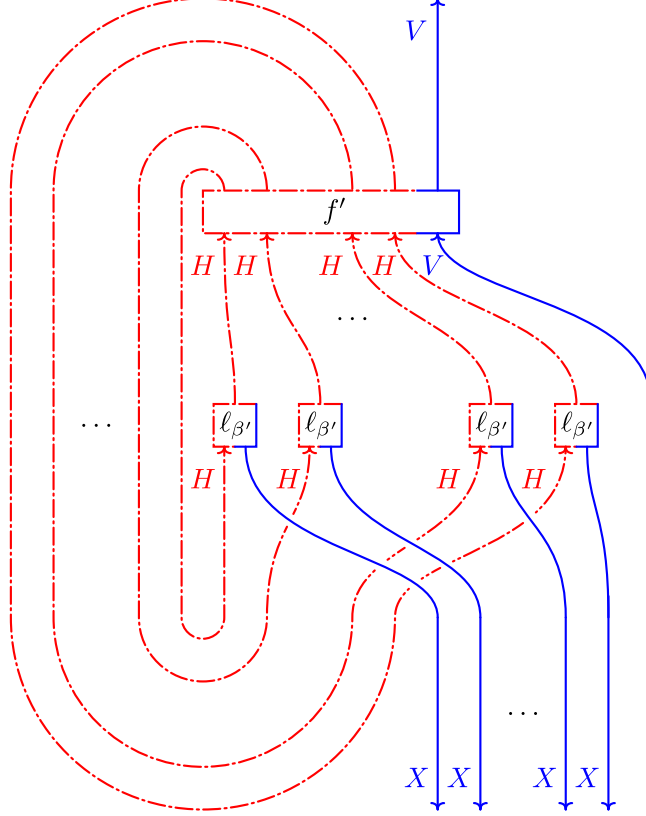

FIGURE 17. \mathcal{E} -Colored bichrome graph representing the morphism $\Theta'^{-1}(f')$ of $\text{Hom}_{\mathcal{E}}((X^*)^{\otimes n} \otimes V, V')$.

□

We are now ready to define our algebraic TQFT spaces. They will be constructed as (quotients of) certain morphism spaces of the type we studied before. For every $g \in \mathbb{N}$ and for every object V of \mathcal{E} we consider the vector spaces

$$\tilde{\mathcal{X}}_{g,V} := \text{Hom}_{\mathcal{E}}(H, X^{\otimes g} \otimes V), \quad \mathcal{X}'_{g,V} := \text{Hom}_{\mathcal{E}}((X^*)^{\otimes g} \otimes V, \mathbb{1}).$$

Remark that the space $\tilde{\mathcal{X}}_{g,V}$ is isomorphic to $X^{\otimes g} \otimes V$ via the isomorphism mapping every $\tilde{f} \in \tilde{\mathcal{X}}_{g,V}$ to $\tilde{f}(1_H)$.

We define now a bilinear pairing $\langle \cdot, \cdot \rangle_{\mathcal{X}} : \mathcal{X}'_{g,V} \times \tilde{\mathcal{X}}_{g,V} \rightarrow \mathbb{k}$ as follows: for every $f' \in \mathcal{X}'_{g,V}$ and every $f \in \tilde{\mathcal{X}}_{g,V}$ we set

$$\langle f', f \rangle_{\mathcal{X}} := \text{t}_H(F_\lambda(T_{\mathcal{X},f',f}))$$

where $T_{\mathcal{X},f',f}$ is the \mathcal{E} -colored bichrome graph represented in Figure 18.

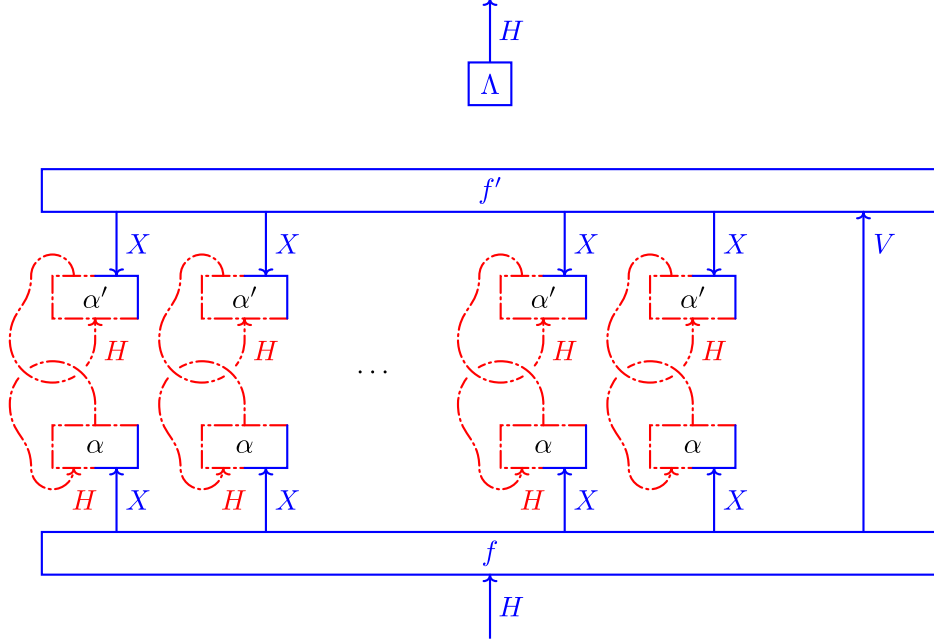

FIGURE 18. \mathcal{C} -Colored bichrome graph $T_{X,f',f}$ defining the pairing $\langle f', f \rangle_X$.

We define $\mathcal{X}_{g,V}$ to be the quotient of $\tilde{\mathcal{X}}_{g,V}$ with respect to the right radical of this pairing. Then we can induce a bilinear pairing between $\mathcal{X}'_{g,V}$ and $\mathcal{X}_{g,V}$ which we still denote by $\langle \cdot, \cdot \rangle_X$.

Proposition 3.4. *The pairing $\langle \cdot, \cdot \rangle_X : \mathcal{X}'_{g,V} \times \mathcal{X}_{g,V} \rightarrow \mathbb{k}$ is non-degenerate.*

Proof. If $f' \in \mathcal{X}'_{g,V}$ is non-zero then there exists some $\underline{x} \otimes v \in X^{\otimes g} \otimes V$ such that $f'(h_X^{\otimes g}(\underline{x}) \otimes v) \neq 0$. Let $f_{\underline{x} \otimes v} \in \tilde{\mathcal{X}}_{g,V}$ be the unique H -module morphism mapping 1_H to $\underline{x} \otimes v$. Then $f' \circ (h_X^{\otimes g} \otimes \text{id}_V) \circ f_{\underline{x} \otimes v}$ is a non-zero H -module morphism from H to \mathbb{k} . This means it is a non-zero multiple of ε , which gives

$$\text{t}_H(\Lambda \circ f' \circ (h_X^{\otimes g} \otimes \text{id}_V) \circ f_{\underline{x} \otimes v}) \neq 0.$$

Thus the left radical of $\langle \cdot, \cdot \rangle_X : \mathcal{X}'_{g,V} \times \mathcal{X}_{g,V} \rightarrow \mathbb{k}$ is trivial. Since the right radical is trivial by definition, we can conclude. \square

It will be useful for the following to have another model of these algebraic TQFT spaces, corresponding to the isomorphism provided by Proposition 3.2. For every $g \in \mathbb{N}$ and for every object V of \mathcal{C} we consider vector spaces

$$\tilde{\mathcal{S}}'_{g,V} := \text{Hom}_{[g]\mathcal{C}}([g]H, [g]V), \quad \mathcal{S}'_{g,V} := \text{Hom}_{[g]\mathcal{C}}([g]V, [g]\mathbb{1}).$$

Remark that, thanks to Proposition 3.2, we have explicit isomorphisms between $\tilde{\mathcal{X}}_{g,V}$ and $\tilde{\mathcal{S}}'_{g,V}$ and between $\mathcal{X}'_{g,V}$ and $\mathcal{S}'_{g,V}$.

We define now a bilinear pairing $\langle \cdot, \cdot \rangle_{\mathcal{S}} : \mathcal{S}'_{g,V} \times \tilde{\mathcal{S}}'_{g,V} \rightarrow \mathbb{k}$ as follows: for every $f' \in \mathcal{S}'_{g,V}$ and every $f \in \tilde{\mathcal{S}}'_{g,V}$ we set

$$\langle f', f \rangle_{\mathcal{S}} := \text{t}_H(F_{\lambda}(T_{\mathcal{S},f,f'}))$$

where $T_{\mathcal{S},f,f'}$ is the \mathcal{C} -colored bichrome graph represented in Figure 19.

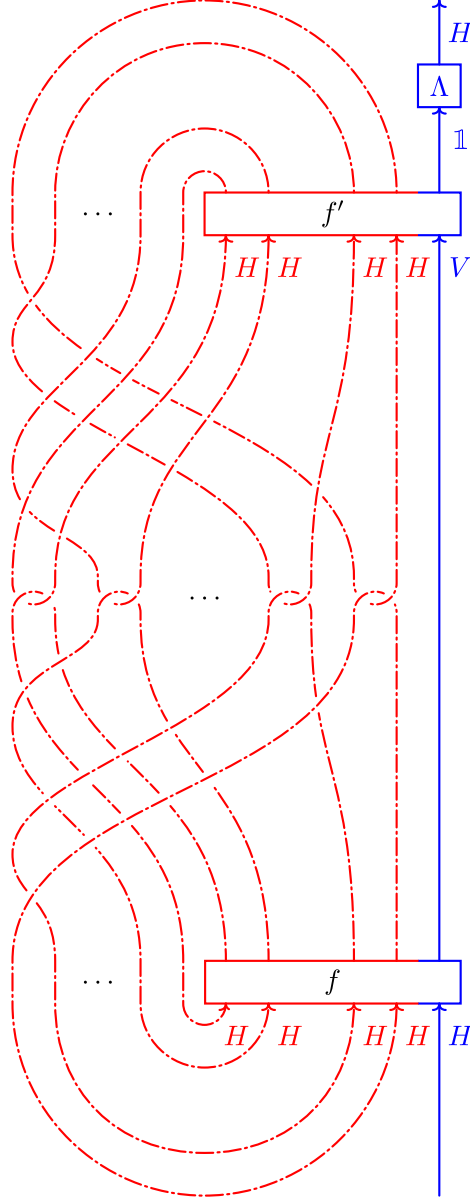

FIGURE 19. \mathcal{C} -Colored bichrome graph $T_{\mathcal{S}, f, f'}$ defining the pairing $\langle f', f \rangle_{\mathcal{S}}$.

We define $\mathcal{S}_{g, V}$ to be the quotient of $\tilde{\mathcal{S}}_{g, V}$ with respect to the right radical of this pairing. Then we can induce a bilinear pairing between $\mathcal{S}'_{g, V}$ and $\mathcal{S}_{g, V}$ which we still denote by $\langle \cdot, \cdot \rangle_{\mathcal{S}}$.

Proposition 3.5. *Every morphism $f' \in \mathcal{X}'_{g, V}$ and every morphism $f \in \tilde{\mathcal{X}}_{g, V}$ satisfy*

$$\langle f', f \rangle_{\mathcal{X}} = \langle \Theta'(f'), \Theta(f) \rangle_{\mathcal{S}}$$

where Θ and Θ' are the explicit isomorphisms given by Proposition 3.2.

Proof. The pairing $\langle \Theta'(f'), \Theta(f) \rangle_{\mathcal{S}}$ is given by the modified trace of the endomorphism of H defined as the evaluation of the functor F_{λ} against the \mathcal{C} -colored

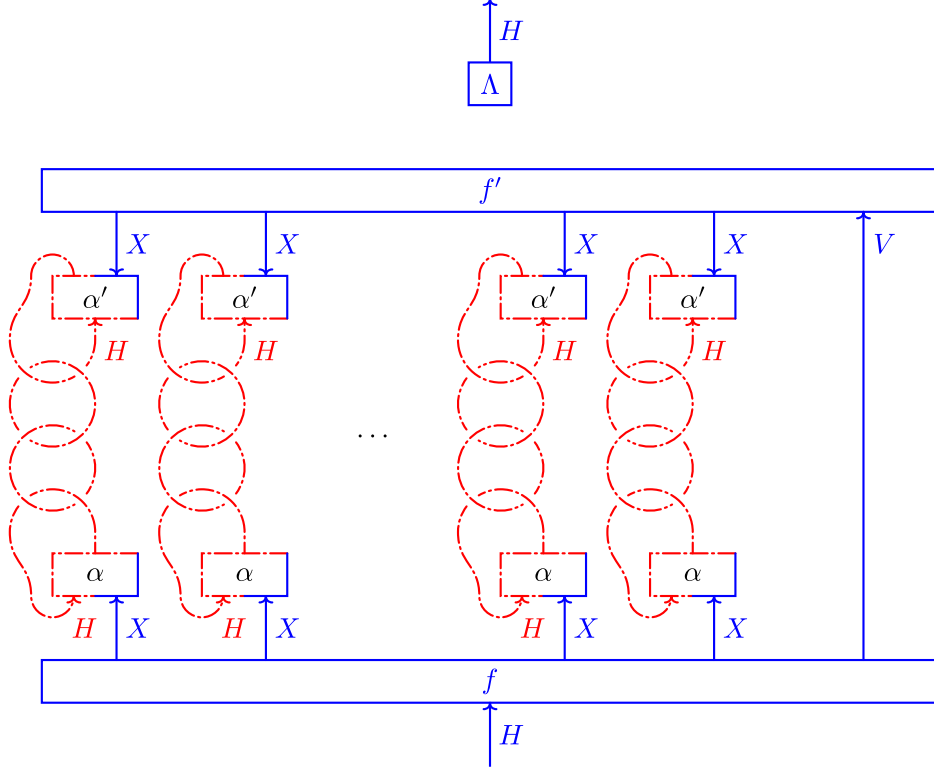
FIGURE 20. \mathcal{C} -Colored bichrome graph computing the pairing $\langle \Theta'(f'), \Theta(f) \rangle_{\mathcal{S}}$.

bichrome graph represented in Figure 20. But remark now that every red strand meeting an α -colored coupon can be slid upwards using the topmost component of the Hopf link that is tangled to it, and analogously every red strand meeting an α' -colored coupon can be slid downwards using the bottommost component of the Hopf link that is tangled to it. This way, we can disentangle all Hopf links from the rest of the bichrome graph. Then, since red Hopf links provide trivial contribution to the image under the functor F_{λ} , we can just remove them, and we are left with a \mathcal{C} -colored ribbon graph representing a morphism whose modified trace gives precisely $\langle f', f \rangle_{\mathcal{X}}$.

□

3.2. Skein equivalence. In this subsection we introduce the concept of skein equivalence for morphisms of $[n]\mathcal{C}$ and we establish some related properties of \mathcal{C} -colored bichrome graphs. If $[n](\underline{\varepsilon}, \underline{V})$ and $[n](\underline{\varepsilon}', \underline{V}')$ are objects of $[n]\mathcal{R}_{\lambda}$ then we say two formal linear combinations $\sum_{i=1}^m \alpha_i \cdot T_i$ and $\sum_{i'=1}^{m'} \alpha'_{i'} \cdot T'_{i'}$ of morphisms of $\text{Hom}_{[n]\mathcal{R}_{\lambda}}([n](\underline{\varepsilon}, \underline{V}), [n](\underline{\varepsilon}', \underline{V}'))$ are *skein equivalent* if

$$\sum_{i=1}^m \alpha_i \cdot F_{\lambda}(T_i) = \sum_{i'=1}^{m'} \alpha'_{i'} \cdot F_{\lambda}(T'_{i'}).$$

Such a skein equivalence will be denoted

$$\sum_{i=1}^m \alpha_i \cdot T_i \doteq \sum_{i'=1}^{m'} \alpha'_{i'} \cdot T'_{i'}.$$

Lemma 3.6. *There exists a modularity parameter $\zeta \in \mathbb{k}^*$ realizing the skein equivalence of Figure 21.*

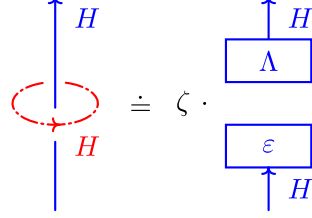

FIGURE 21. Cutting property for red meridians.

Proof. The morphism of \mathcal{C} obtained by applying the functor F_λ to the \mathcal{C} -colored bichrome graph represented in the left hand part of Figure 21 is equal to L_z for the non-trivial central element $z = \psi(\lambda) \in Z(H)$. We claim that $z = \zeta \cdot \Lambda$ for some $\zeta \in \mathbb{k}^*$. Indeed, Proposition 2.13 implies that the two \mathcal{C} -colored bichrome graphs represented in Figure 22 are skein equivalent.

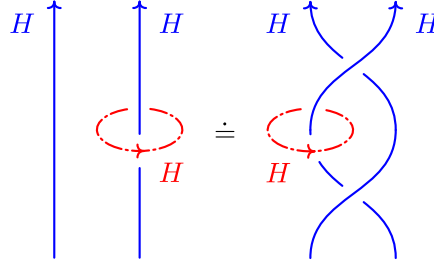

FIGURE 22. Transparency of L_z .

The morphism of \mathcal{C} determined by the left-hand part of Figure 22 maps $1_H \otimes 1_H$ to $1_H \otimes z$, while the one determined by the right-hand part of Figure 22 maps $1_H \otimes 1_H$ to $\sum_{i,j=1}^r b_j a_i \otimes a_j b_i z$. Now, since the Drinfeld map ψ is an isomorphism, every element $x \in H$ can be written as $\sum_{i,j=1}^r \psi^{-1}(x)(b_j a_i) \cdot a_j b_i$. Then

$$xz = \sum_{i,j=1}^r \psi^{-1}(x)(b_j a_i) \cdot a_j b_i z = \psi^{-1}(x)(1_H) \cdot z.$$

This means z spans a 1-dimensional H -submodule in H , which has to coincide with the ideal of two-sided cointegrals. \square

If V is a projective object of H then let us choose a section $s_V : V \rightarrow H \otimes V$ of the epimorphism $\varepsilon \otimes \text{id}_V : H \otimes V \rightarrow V$, i.e. an H -module morphism satisfying $(\varepsilon \otimes \text{id}_V) \circ s_V = \text{id}_V$. We define now an operation on admissible n -string link graphs which we call *turning a red cycle blue*. Let T be an n -string link graph containing an H -colored red cycle C and a V -colored blue edge e for some projective object V of \mathcal{C} . Then Figure 23 explains how to replace C and e with a set of blue edges and coupons to obtain a new n -string link graph T' .

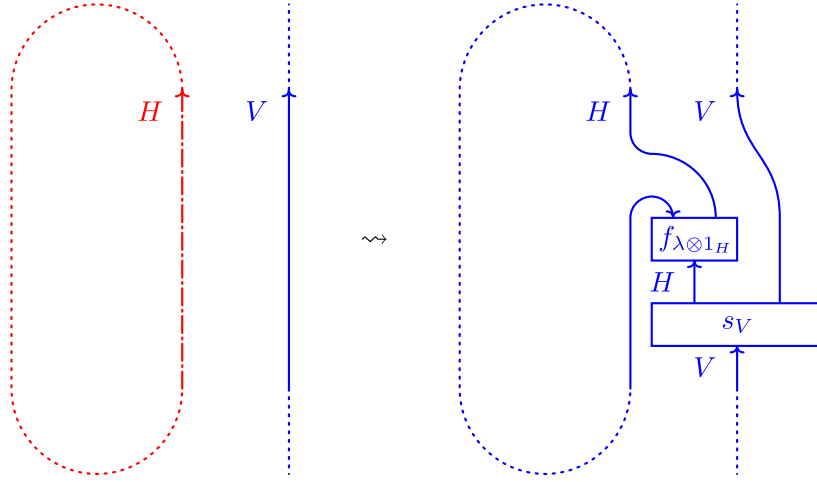

FIGURE 23. Turning a red cycle blue. The map $f_{\lambda \otimes 1_H}$ is the unique morphism of H -modules sending the generator 1_H of H to the vector $\lambda \otimes 1_H$ of $H^* \otimes H$.

Remark 3.7. When performing the operation we just described to a red cycle in a bichrome graph we have to be extremely careful with coupons. Indeed a direct switch of the color of some edges may not result in a bichrome graph. To be precise we have to replace coupons as shown in Figure 24.

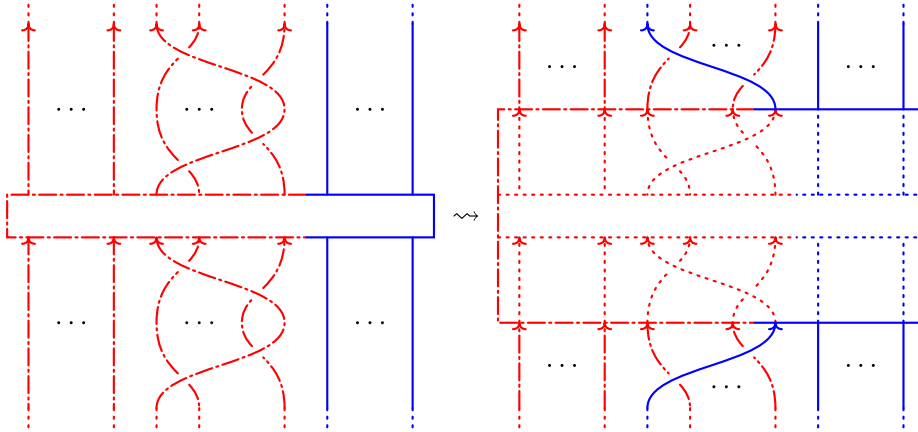

FIGURE 24. Recipe for replacing a coupon when turning a red cycle blue. The new coupon is to be colored with the image under F_λ of the dashed graph it contains.

Lemma 3.8. *If T is an admissible n -string link graph and T' is obtained from T by turning a red cycle blue then*

$$F_\lambda(T) = F_\lambda(T').$$

Proof. The proof follows from the equality

$$\overleftarrow{\text{ev}}_H \circ (\text{id}_{H^*} \otimes L_x) \circ f_{\lambda \otimes 1_H} = \lambda(x) \cdot \varepsilon,$$

which holds for every $x \in H$. To establish the identity let us consider $y \in H$. Then

$$\begin{aligned} \overleftarrow{\text{ev}}_H ((\text{id}_{H^*} \otimes L_x)(f\lambda_{\otimes 1_H}(y))) &= \overleftarrow{\text{ev}}_H ((\text{id}_{H^*} \otimes L_x)((y_{(1)} \cdot \lambda) \otimes y_{(2)})) \\ &= \overleftarrow{\text{ev}}_H ((y_{(1)} \cdot \lambda) \otimes xy_{(2)}) \\ &= \lambda(S(y_{(1)})xy_{(2)}) \\ &= \lambda(x)\varepsilon(y). \end{aligned} \quad \square$$

We can now give a new easy proof of the non-degeneracy of H using skein methods.

Corollary 3.9. *If H is a finite-dimensional factorizable ribbon Hopf algebra then H -mod satisfies the non-degeneracy condition $\Delta_- \Delta_+ = \zeta \neq 0$.*

Proof. Thanks to Lemma 3.8 we have the skein equivalence of Figure 25. Now the functor F_λ maps the left-hand side of Figure 25 to $\Delta_- \Delta_+ \cdot \text{id}_V$ because the red link is obtained by sliding a $+1$ -framed unknot over a -1 -framed unknot, while it maps the right-hand side of Figure 25 to $\zeta \cdot \text{id}_V$. \square

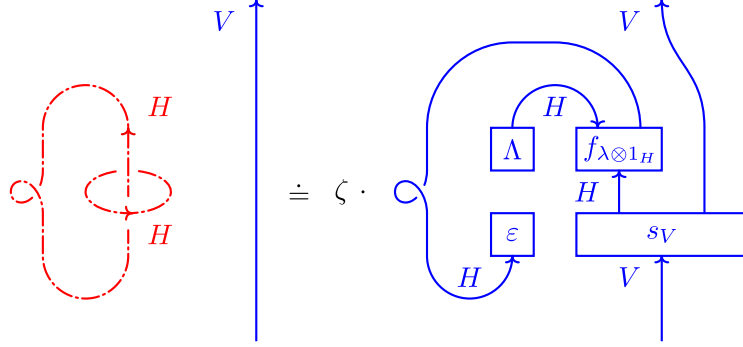

FIGURE 25. Skein equivalence witnessing $\Delta_- \Delta_+ = \zeta$.

3.3. Cobordism category and universal construction. In this subsection we introduce the cobordism category we will work with and we apply the universal construction of [6] to obtain a functorial extension of the invariant $H'_{\mathcal{C}}$. To do this, we first fix some terminology. At the beginning of Subsection 2.2 we introduced *bichrome graphs*, which are ribbon graphs with edges divided into two groups, red and blue, and with special coupons satisfying a certain condition concerning the partition of edges. Now we need to extend the definition to a more general setting. A \mathcal{C} -colored blue set P inside a surface Σ is a discrete set of blue points of Σ endowed with orientations, framings and colors given by objects of \mathcal{C} . A \mathcal{C} -colored bichrome graph T inside a 3-dimensional cobordism M is a \mathcal{C} -colored bichrome graph embedded inside M whose boundary vertices are given by \mathcal{C} -colored blue sets inside the boundary of the cobordism. We can now define the symmetric monoidal category $\text{Cob}_{\mathcal{C}}$.

An object Σ of $\text{Cob}_{\mathcal{C}}$ is a triple (Σ, P, \mathcal{L}) where:

- (i) Σ is a closed surface;
- (ii) $P \subset \Sigma$ is a \mathcal{C} -colored blue set;
- (iii) $\mathcal{L} \subset H_1(\Sigma; \mathbb{R})$ is a Lagrangian subspace.

A *morphism* $\mathbb{M} : \Sigma \rightarrow \Sigma'$ of $\text{Cob}_{\mathcal{C}}$ is an equivalence class of triples (M, T, n) where:

- (i) M is a 3-dimensional cobordism from Σ to Σ' ;
- (ii) $T \subset M$ is a \mathcal{C} -colored bichrome graph from P to P' ;
- (iii) $n \in \mathbb{Z}$ is a signature defect.

Two triples (M, T, n) and (M', T', n') are equivalent if $n = n'$ and if there exists an isomorphism of cobordisms $f : M \rightarrow M'$ satisfying $f(T) = T'$.

The *identity morphism* $\text{id}_{\Sigma} : \Sigma \rightarrow \Sigma$ associated with an object $\Sigma = (\Sigma, P, \mathcal{L})$ of $\text{Cob}_{\mathcal{C}}$ is the equivalence class of the triple

$$(\Sigma \times I, P \times I, 0).$$

The *composition* $\mathbb{M}' \circ \mathbb{M} : \Sigma \rightarrow \Sigma''$ of morphisms $\mathbb{M}' : \Sigma' \rightarrow \Sigma''$, $\mathbb{M} : \Sigma \rightarrow \Sigma'$ of $\text{Cob}_{\mathcal{C}}$ is the equivalence class of the triple

$$(M \cup_{\Sigma'} M', T \cup_{P'} T', n + n' - \mu(M_* \mathcal{L}, \mathcal{L}', M'^* \mathcal{L}''))$$

for the Lagrangian subspaces

$$\begin{aligned} M_* \mathcal{L} &:= \{x' \in H_1(\Sigma'; \mathbb{R}) \mid i_{M_+} x' \in i_{M_-}(\mathcal{L})\} \subset H_1(\Sigma'; \mathbb{R}) \\ M'^* \mathcal{L}'' &:= \{x' \in H_1(\Sigma'; \mathbb{R}) \mid i_{M'_+} x' \in i_{M'_-}(\mathcal{L}'')\} \subset H_1(\Sigma'; \mathbb{R}). \end{aligned}$$

where

$$i_{M_-} : \Sigma \hookrightarrow M, \quad i_{M_+} : \Sigma' \hookrightarrow M, \quad i_{M'_-} : \Sigma' \hookrightarrow M', \quad i_{M'_+} : \Sigma'' \hookrightarrow M'$$

are the embeddings induced by the structure of the cobordisms M and M' . Here μ denotes the Maslov index, see [63] for a detailed account of its properties.

The *unit* of $\text{Cob}_{\mathcal{C}}$ is the unique object whose surface is empty, and it will be denoted \emptyset . The *tensor product* $\Sigma \otimes \Sigma'$ of objects Σ, Σ' of $\text{Cob}_{\mathcal{C}}$ is the triple

$$(\Sigma \sqcup \Sigma', P \sqcup P', \mathcal{L} + \mathcal{L}').$$

The *tensor product* $\mathbb{M} \otimes \mathbb{M}' : \Sigma \otimes \Sigma' \rightarrow \Sigma'' \otimes \Sigma'''$ of morphisms $\mathbb{M} : \Sigma \rightarrow \Sigma''$, $\mathbb{M}' : \Sigma' \rightarrow \Sigma'''$ of $\text{Cob}_{\mathcal{C}}$ is the equivalence class of the triple

$$(M \sqcup M', T \sqcup T', n + n').$$

We will now construct a TQFT extending the renormalized Hennings invariant $H'_{\mathcal{C}}$. Its domain however will not be the whole symmetric monoidal category $\text{Cob}_{\mathcal{C}}$, as there is no way of defining $H'_{\mathcal{C}}$ for every closed morphism of $\text{Cob}_{\mathcal{C}}$. Indeed, we will have to consider a strictly smaller subcategory. We define $\check{\text{Cob}}_{\mathcal{C}}$ to be the symmetric monoidal subcategory of $\text{Cob}_{\mathcal{C}}$ having the same objects but featuring only morphisms $\mathbb{M} = (M, T, n)$ which satisfy the following condition: every connected component of M disjoint from the incoming boundary contains an admissible \mathcal{C} -colored bichrome subgraph of T .

We can now extend the renormalized Hennings invariant to closed morphisms of $\check{\text{Cob}}_{\mathcal{C}}$ by setting

$$H'_{\mathcal{C}}(\mathbb{M}) := \delta^n H'_{\mathcal{C}}(M, T)$$

for every closed connected morphism $\mathbb{M} = (M, T, n)$ and then by setting

$$H'_{\mathcal{C}}(\mathbb{M}_1 \otimes \dots \otimes \mathbb{M}_k) := \prod_{i=1}^k H'_{\mathcal{C}}(\mathbb{M}_i)$$

for every tensor product of closed connected morphisms $\mathbb{M}_1, \dots, \mathbb{M}_k$.

Remark 3.10. It is clear that this definition only works for closed morphisms of $\check{\text{Cob}}_{\mathcal{G}}$, as in general closed morphisms of $\text{Cob}_{\mathcal{G}}$ do not feature admissible \mathcal{G} -colored bichrome graphs.

We apply now the universal construction of [6], which allows a functorial extension of $H'_{\mathcal{G}}$. If Σ is an object of $\check{\text{Cob}}_{\mathcal{G}}$ then let $\mathcal{V}(\Sigma)$ be the free vector space generated by the set of morphisms $M_{\Sigma} : \emptyset \rightarrow \Sigma$ of $\check{\text{Cob}}_{\mathcal{G}}$, and let $\mathcal{V}'(\Sigma)$ be the free vector space generated by the set of morphisms $M'_{\Sigma} : \Sigma \rightarrow \emptyset$ of $\check{\text{Cob}}_{\mathcal{G}}$. Consider the bilinear form

$$\begin{aligned} \langle \cdot, \cdot \rangle_{\Sigma} : \mathcal{V}'(\Sigma) \times \mathcal{V}(\Sigma) &\rightarrow \mathbb{k} \\ (M'_{\Sigma}, M_{\Sigma}) &\mapsto H'_{\mathcal{G}}(M'_{\Sigma} \circ M_{\Sigma}). \end{aligned}$$

Let $V_{\mathcal{G}}(\Sigma)$ be the quotient of the vector space $\mathcal{V}(\Sigma)$ with respect to the right radical of the bilinear form $\langle \cdot, \cdot \rangle_{\Sigma}$, and similarly let $V'_{\mathcal{G}}(\Sigma)$ be the quotient of the vector space $\mathcal{V}'(\Sigma)$ with respect to the left radical of the bilinear form $\langle \cdot, \cdot \rangle_{\Sigma}$. Then the pairing $\langle \cdot, \cdot \rangle_{\Sigma}$ induces a non-degenerate pairing

$$\langle \cdot, \cdot \rangle_{\Sigma} : V'_{\mathcal{G}}(\Sigma) \otimes V_{\mathcal{G}}(\Sigma) \rightarrow \mathbb{k}.$$

Now if $M : \Sigma \rightarrow \Sigma'$ is a morphism of $\check{\text{Cob}}_{\mathcal{G}}$, then let $V_{\mathcal{G}}(M)$ be the linear map defined by

$$\begin{aligned} V_{\mathcal{G}}(M) : V_{\mathcal{G}}(\Sigma) &\rightarrow V_{\mathcal{G}}(\Sigma') \\ [M_{\Sigma}] &\mapsto [M \circ M_{\Sigma}], \end{aligned}$$

and similarly let $V'_{\mathcal{G}}(M)$ be the linear map defined by

$$\begin{aligned} V'_{\mathcal{G}}(M) : V'_{\mathcal{G}}(\Sigma') &\rightarrow V'_{\mathcal{G}}(\Sigma) \\ [M'_{\Sigma'}] &\mapsto [M'_{\Sigma'} \circ M]. \end{aligned}$$

The construction we just provided clearly defines functors

$$V_{\mathcal{G}} : \check{\text{Cob}}_{\mathcal{G}} \rightarrow \text{Vect}_{\mathbb{k}}, \quad V'_{\mathcal{G}} : \check{\text{Cob}}_{\mathcal{G}}^{\text{op}} \rightarrow \text{Vect}_{\mathbb{k}}.$$

Proposition 3.11. *The natural transformation $\mu : \otimes \circ V_{\mathcal{G}} \Rightarrow V_{\mathcal{G}} \circ \otimes$ associating with every pair of objects Σ, Σ' of $\check{\text{Cob}}_{\mathcal{G}}$ the linear map*

$$\begin{aligned} \mu_{\Sigma, \Sigma'} : V_{\mathcal{G}}(\Sigma) \otimes V_{\mathcal{G}}(\Sigma') &\rightarrow V_{\mathcal{G}}(\Sigma \otimes \Sigma') \\ [M_{\Sigma}] \otimes [M_{\Sigma'}] &\mapsto [M_{\Sigma} \otimes M_{\Sigma'}] \end{aligned}$$

is monic.

Proof. A trivial vector in $V_{\mathcal{G}}(\Sigma \otimes \Sigma')$ of the form $\sum_{i=1}^m \alpha_i \cdot [M_{\Sigma} \otimes M_{\Sigma'}]$ satisfies

$$\sum_{i=1}^m \alpha_i H'_{\mathcal{G}}(M'_{\Sigma \otimes \Sigma'} \circ (M_{\Sigma} \otimes M_{\Sigma'})) = 0$$

for every vector $[M'_{\Sigma \otimes \Sigma'}]$ of $V'_{\mathcal{G}}(\Sigma \otimes \Sigma')$. In particular its pairing with every vector of the form $[M'_{\Sigma} \otimes M'_{\Sigma'}]$ of $V'_{\mathcal{G}}(\Sigma \otimes \Sigma')$ for some $[M'_{\Sigma}]$ in $V'_{\mathcal{G}}(\Sigma)$ and for some $[M'_{\Sigma'}]$ in $V'_{\mathcal{G}}(\Sigma')$ must be zero too. This means $\sum_{i=1}^m \alpha_i \cdot [M_{\Sigma}] \otimes [M_{\Sigma'}]$ is a trivial vector in $V_{\mathcal{G}}(\Sigma) \otimes V_{\mathcal{G}}(\Sigma')$. \square

3.4. Surgery axioms. In this subsection we study the behaviour of $H'_{\mathcal{E}}$ under decorated index k surgery for $k = 0, 1, 2$. In order to do this, we first introduce this topological operation. For every $k = 0, 1, 2$ the *index k surgery surface* is the object Σ_k of $\text{Cob}_{\mathcal{E}}$ given by

$$\begin{aligned}\Sigma_0 &:= (S^{-1} \times S^3, \emptyset, \{0\}) = \emptyset, \\ \Sigma_1 &:= (S^0 \times S^2, P_{\Sigma_1}, \{0\}), \\ \Sigma_2 &:= (S^1 \times S^1, \emptyset, \mathcal{L}_{\Sigma_2})\end{aligned}$$

with the convention $S^{-1} := \emptyset$, where the H -colored blue ribbon set P_{Σ_1} is given by $S^0 \times \{(0, 0, 1)\}$ with orientation induced by S^0 and with framing obtained by pulling back a non-trivial tangent vector to $(0, 0, 1)$ along the projection onto the second factor of $S^0 \times S^2$, and where the Lagrangian subspace \mathcal{L}_{Σ_2} is generated by the homology class of the curve $\{(1, 0)\} \times S^1$.

For every $k = 0, 1, 2$ the *index k attaching tube* is the morphism $\mathbb{A}_k : \emptyset \rightarrow \Sigma_k$ of $\text{Cob}_{\mathcal{E}}$ given by

$$\begin{aligned}\mathbb{A}_0 &:= (S^{-1} \times \overline{D^4}, \emptyset, 0) = \text{id}_{\emptyset}, \\ \mathbb{A}_1 &:= (S^0 \times D^3, T_{A_1}, 0), \\ \mathbb{A}_2 &:= (S^1 \times \overline{D^2}, K_{A_2}, 0)\end{aligned}$$

where the \mathcal{E} -colored blue ribbon graph T_{A_1} is represented in Figure 26 and where the H -colored red knot K_{A_2} is given by $S^1 \times \{(0, 0)\}$ with orientation induced by S^1 and with framing obtained by pulling back a non-trivial tangent vector to $(0, 0)$ along the projection onto the second factor of $S^1 \times \overline{D^2}$.

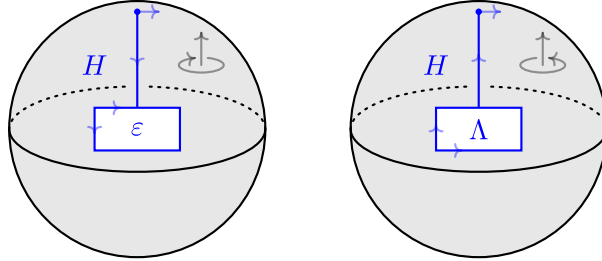

FIGURE 26. The morphism \mathbb{A}_1 . Arrows on horizontal boundaries of coupons are directed according to the orientations of bases, while arrows on vertical boundaries are directed from bottom bases to top bases.

For every $k = 0, 1, 2$ the *index k belt tube* is the morphism $\mathbb{B}_k : \emptyset \rightarrow \Sigma_k$ of $\text{Cob}_{\mathcal{E}}$ given by

$$\begin{aligned}\mathbb{B}_0 &:= (D^0 \times S^3, T_{B_0}, 0), \\ \mathbb{B}_1 &:= (D^1 \times S^2, T_{B_1}, 0), \\ \mathbb{B}_2 &:= (D^2 \times S^1, \emptyset, 0)\end{aligned}$$

with the convention $D^0 := \{0\}$, where the \mathcal{E} -colored blue ribbon graph T_{B_0} is represented in Figure 27, where the H -colored blue tangle T_{B_1} is given by $D^1 \times \{(0, 0, 1)\}$ with orientation induced by D^1 and with framing obtained by

pulling back a non-trivial tangent vector to $(0, 0, 1)$ along the projection onto the second factor of $D^1 \times S^2$.

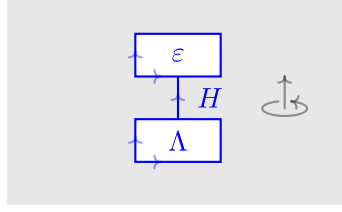

FIGURE 27. The morphism \mathbb{B}_0 .

For $k \in \{0, 1, 2\}$ and for a morphism $\mathbb{M}_k : \Sigma_k \rightarrow \emptyset$ of $\check{\text{Cob}}_{\mathcal{G}}$ the morphism $\mathbb{M}_k \circ \mathbb{B}_k$ is said to be obtained from $\mathbb{M}_k \circ \mathbb{A}_k$ by an *index k surgery*.

Proposition 3.12. *For $k \in \{0, 1, 2\}$ let $\mathbb{M}_k : \Sigma_k \rightarrow \emptyset$ be a morphism of $\check{\text{Cob}}_{\mathcal{G}}$. If $\mathbb{M}_k \circ \mathbb{A}_k$ is in $\check{\text{Cob}}_{\mathcal{G}}$ then*

$$\mathbb{H}'_{\mathcal{G}}(\mathbb{M}_k \circ \mathbb{B}_k) = \lambda_k \mathbb{H}'_{\mathcal{G}}(\mathbb{M}_k \circ \mathbb{A}_k)$$

with $\lambda_0 = \lambda_1^{-1} = \lambda_2 = \mathcal{D}^{-1}$.

Proof. If $k = 0$ then the property reduces to the computation

$$\mathbb{H}'_{\mathcal{G}}(\mathbb{B}_0) = \mathcal{D}^{-1-0} \delta^{0-0} F'_{\lambda}(T_{B_0}) = \mathcal{D}^{-1} \mathfrak{t}_H(\Lambda \circ \varepsilon) = \mathcal{D}^{-1}.$$

If $k = 1$ then we have two cases, according to whether or not the surgery involves two different connected components of the closed morphism. Let us start from the first case, and let us begin by decomposing Σ_1 as a tensor product $\overline{\mathbb{S}}^2_{(-,H)} \otimes \mathbb{S}^2_{(+,H)}$ and by decomposing \mathbb{A}_1 as a tensor product $\overline{\mathbb{D}}^3_{\varepsilon} \otimes \mathbb{D}^3_{\Lambda}$ with respect to the morphisms $\overline{\mathbb{D}}^3_{\varepsilon} : \emptyset \rightarrow \overline{\mathbb{S}}^2_{(-,H)}$ and $\mathbb{D}^3_{\Lambda} : \emptyset \rightarrow \mathbb{S}^2_{(+,H)}$ represented in the left-hand part and in the right-hand part of Figure 26 respectively. Let us consider connected morphisms $\mathbb{M}_1 : \overline{\mathbb{S}}^2_{(-,H)} \rightarrow \emptyset$ and $\mathbb{M}'_1 : \mathbb{S}^2_{(+,H)} \rightarrow \emptyset$ of $\check{\text{Cob}}_{\mathcal{G}}$. If $L = L_1 \cup \dots \cup L_{\ell}$ is a surgery link for $M_1 \cup_{S^2} \overline{D}^3$ and if $L' = L'_1 \cup \dots \cup L'_{\ell'}$ is a surgery link for $M'_1 \cup_{S^2} D^3$ then

$$\mathbb{H}'_{\mathcal{G}}(\mathbb{M}_1 \circ \overline{\mathbb{D}}^3_{\varepsilon}) = \mathcal{D}^{-1-\ell} \delta^{n-\sigma(L)} F'_{\lambda}(L \cup T),$$

$$\mathbb{H}'_{\mathcal{G}}(\mathbb{M}'_1 \circ \mathbb{D}^3_{\Lambda}) = \mathcal{D}^{-1-\ell'} \delta^{n'-\sigma(L')} F'_{\lambda}(L' \cup T').$$

If $(L \cup T)_H : \emptyset \rightarrow (+, H)$ and $(L' \cup T')_H : (+, H) \rightarrow \emptyset$ are morphisms of \mathcal{R}_{λ} satisfying

$$L \cup T = T_{\varepsilon} \circ (L \cup T)_H,$$

$$L' \cup T' = (L' \cup T')_H \circ T_{\Lambda},$$

for the elementary morphisms $T_{\varepsilon} : (+, H) \rightarrow \emptyset$ and $T_{\Lambda} : \emptyset \rightarrow (+, H)$ of \mathcal{R}_{λ} featuring a single blue strand and a single blue coupon with colors specified by the subscripts, then $(L \cup T)_H \circ T_{\varepsilon}$ is a cutting presentation for $L \cup T$, and $T_{\Lambda} \circ (L' \cup T')_H$ is a cutting presentation for $L' \cup T'$. This means

$$F'_{\lambda}(L \cup T) = \mathfrak{t}_H(F_{\lambda}((L \cup T)_H \circ T_{\varepsilon})),$$

$$F'_{\lambda}(L' \cup T') = \mathfrak{t}_H(F_{\lambda}(T_{\Lambda} \circ (L' \cup T')_H)).$$

Now we remark that

$$\mathbb{H}'_{\mathcal{C}}((\mathbb{M}_1 \otimes \mathbb{M}'_1) \circ \mathbb{B}_1) = \mathcal{D}^{-1-\ell-\ell'} \delta^{n+n'-\sigma(L)-\sigma(L')} F'_\lambda((L' \cup T')_H \circ (L \cup T)_H),$$

and that

$$\begin{aligned} F_\lambda((L \cup T)_H) &= \mathfrak{t}_H(F_\lambda((L \cup T)_H \circ T_\varepsilon)) \cdot \Lambda, \\ F_\lambda((L' \cup T')_H) &= \mathfrak{t}_H(F_\lambda(T_\Lambda \circ (L' \cup T')_H)) \cdot \varepsilon, \end{aligned}$$

because $\text{Hom}_{\mathcal{C}}(\mathbb{1}, H)$ and $\text{Hom}_{\mathcal{C}}(H, \mathbb{1})$ are 1-dimensional. This means

$$\begin{aligned} F'_\lambda((L' \cup T')_H \circ (L \cup T)_H) &= \mathfrak{t}_H(F_\lambda((L \cup T)_H \circ (L' \cup T')_H)) \\ &= \mathfrak{t}_H(F_\lambda((L \cup T)_H \circ T_\varepsilon)) \mathfrak{t}_H(F_\lambda(T_\Lambda \circ (L' \cup T')_H)) \mathfrak{t}_H(\Lambda \circ \varepsilon) \\ &= F'_\lambda(L \cup T) F'_\lambda(L' \cup T'). \end{aligned}$$

But now

$$\begin{aligned} \mathbb{H}'_{\mathcal{C}}((\mathbb{M}_1 \otimes \mathbb{M}'_1) \circ \mathbb{B}_1) &= \mathcal{D}^{-1-\ell-\ell'} \delta^{n+n'-\sigma(L)-\sigma(L')} F'_\lambda((L \cup T)_H \circ (L' \cup T')_H) \\ &= \mathcal{D}^{-1-\ell-\ell'} \delta^{n+n'-\sigma(L)-\sigma(L')} F'_\lambda(L \cup T) F'_\lambda(L' \cup T') \\ &= \mathcal{D} \mathbb{H}'_{\mathcal{C}}(\mathbb{M}_1 \circ \overline{\mathbb{D}}_\varepsilon^3) \mathbb{H}'_{\mathcal{C}}(\mathbb{M}'_1 \circ \mathbb{D}_\Lambda^3) \\ &= \mathcal{D} \mathbb{H}'_{\mathcal{C}}((\mathbb{M}_1 \otimes \mathbb{M}'_1) \circ \mathbb{A}_1). \end{aligned}$$

Now let us move on to the second case, and let us consider a connected morphism $\mathbb{M}_1 : \Sigma_1 \rightarrow \emptyset$ of $\check{\text{Cob}}_{\mathcal{C}}$. If $L = L_1 \cup \dots \cup L_\ell$ is a surgery link for $M_1 \cup_{(S^0 \times S^2)} (S^0 \times D^3)$ then

$$\mathbb{H}'_{\mathcal{C}}(\mathbb{M}_1 \circ \Sigma_1) = \mathcal{D}^{-1-\ell} \delta^{n-\sigma(L)} F'_\lambda(L \cup T).$$

If $(L \cup T)_H : (+, H) \rightarrow (+, H)$ is a morphism of \mathcal{R}_λ satisfying

$$L \cup T = T_\varepsilon \circ (L \cup T)_H \circ T_\Lambda,$$

then $T_\Lambda \circ T_\varepsilon \circ (L \cup T)_H$ is a cutting presentation for $L \cup T$. This means

$$F'_\lambda(L \cup T) = \mathfrak{t}_H(F_\lambda(T_\Lambda \circ T_\varepsilon \circ (L \cup T)_H)).$$

Now remark that

$$\mathbb{H}'_{\mathcal{C}}(\mathbb{M}_1 \circ \mathbb{B}_1) = \mathcal{D}^{-1-(\ell+1)} \delta^{n-\sigma(L)} F'_\lambda(K \cup L \cup \hat{T})$$

where the admissible \mathcal{C} -colored bichrome graph $K \cup L \cup \hat{T}$ is represented in Figure 28.

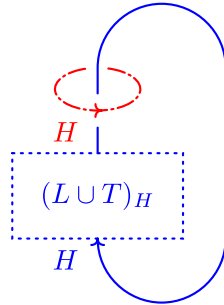

FIGURE 28. The admissible \mathcal{C} -colored bichrome graph $K \cup L \cup \hat{T}$.

But now, thanks to Lemma 3.6, we have

$$F'_\lambda(K \cup L \cup \hat{T}) = \zeta F'_\lambda(L \cup T).$$

This means

$$\begin{aligned} H'_\mathcal{E}(\mathbb{M}_1 \circ \mathbb{B}_1) &= \mathcal{D}^{-2-\ell} \delta^{n-\sigma(L)} F'_\lambda(K \cup L \cup \hat{T}) \\ &= \zeta \mathcal{D}^{-2-\ell} \delta^{n-\sigma(L)} F'_\lambda(L \cup T) \\ &= \mathcal{D}^{-\ell} \delta^{n-\sigma(L)} F'_\lambda(L \cup T) \\ &= \mathcal{D} H'_\mathcal{E}(\mathbb{M}_1 \circ \mathbb{A}_1). \end{aligned}$$

If $k = 2$ let us consider a connected morphism $\mathbb{M}_2 : \Sigma_2 \rightarrow \emptyset$ of $\check{\text{Cob}}_\mathcal{E}$. If $L = L_1 \cup \dots \cup L_\ell$ is a surgery link for $M_2 \cup_{(S^1 \times S^1)} (S^1 \times \overline{D^2})$ then $L \cup K_2$ is a surgery link for $M_2 \cup_{(S^1 \times S^1)} (D^2 \times S^1)$, where K_2 denotes the pull back of the H -colored red knot coming from \mathbb{A}_2 to S^3 . Now if the signature defect of $\mathbb{M}_2 \circ \mathbb{A}_2$ is n , then the signature defect of $\mathbb{M}_2 \circ \mathbb{A}_2$ is $n + \sigma(L \cup K_2) - \sigma(L)$. Therefore

$$\begin{aligned} H'_\mathcal{E}(\mathbb{M}_2 \circ \mathbb{A}_2) &= \mathcal{D}^{-1-\ell} \delta^{n-\sigma(L)} F'_\lambda(L \cup K_2), \\ H'_\mathcal{E}(\mathbb{M}_2 \circ \mathbb{B}_2) &= \mathcal{D}^{-1-(\ell+1)} \delta^{(n+\sigma(L \cup K_2) - \sigma(L)) - \sigma(L \cup K_2)} F'_\lambda(L \cup K_2). \end{aligned}$$

□

3.5. Consequences of skein equivalence and surgery axioms. In this subsection we establish some useful properties of the functor $V_\mathcal{E}$ which will be used for the proof of its monoidality and for the computation of its image. Loosely speaking, they can be summarized as follows:

- (i) If Σ is an object of $\check{\text{Cob}}_\mathcal{E}$ then $V_\mathcal{E}(\Sigma)$ is generated by graphs inside a fixed connected cobordism;
- (ii) To test if a vector $[\mathbb{M}]$ in $V_\mathcal{E}(\Sigma)$ is trivial it is enough to pair it with all covectors in $V'_\mathcal{E}(\Sigma)$ whose support is given by a fixed connected cobordism.

For every $k \geq 0$ let us consider a standard embedding $f_k : D^3 \hookrightarrow \mathbb{R}^2 \times I$ mapping the point $(\cos(\frac{t}{k+1}\pi), 0, \sin(\frac{t}{k+1}\pi)) \in D^3$ to the point $((t, 0), 1) \in \mathbb{R}^2 \times I$ for every $t \in [0, k+1]$. Then if $(\underline{\varepsilon}, \underline{V}) = ((\varepsilon_1, V_1), \dots, (\varepsilon_k, V_k))$ is an object of $\mathcal{R}_\mathcal{E}$ we can use the embedding f_k to define by pull back a standard \mathcal{E} -colored blue set $P_{(\underline{\varepsilon}, \underline{V})}$ inside S^2 . Let $S^2_{(\underline{\varepsilon}, \underline{V})}$ denote the object of $\check{\text{Cob}}_\mathcal{E}$ given by

$$(S^2, P_{(\underline{\varepsilon}, \underline{V})}, \{0\}).$$

We can now generalize the notion of skein equivalence we gave in Subsection 3.1 for morphisms of $[n]\mathcal{R}_\lambda$. Indeed, we say two formal linear combinations $\sum_{i=1}^m \alpha_i \cdot T_i$ and $\sum_{i'=1}^{m'} \alpha'_{i'} \cdot T'_{i'}$ of \mathcal{E} -colored bichrome graphs inside D^3 from \emptyset to $P_{(\underline{\varepsilon}, \underline{V})}$ are *skein equivalent* if

$$\sum_{i=1}^m \alpha_i \cdot f_k(T_i) \doteq \sum_{i'=1}^{m'} \alpha'_{i'} \cdot f_k(T'_{i'})$$

in $\text{Hom}_{\mathcal{R}_\lambda}([0]\emptyset, [0](\underline{\varepsilon}, \underline{V}))$. Now let $\Sigma = (\Sigma, P, \mathcal{L})$ be an object of $\check{\text{Cob}}_\mathcal{E}$, let M be a connected 3-dimensional cobordism from \emptyset to Σ and let us fix an isomorphism of cobordisms $f_M : M \rightarrow D^3 \cup_{S^2} \hat{M}$ for some cobordism \hat{M} from S^2 to Σ . In general, we say two linear combinations of \mathcal{E} -colored bichrome graphs inside M from \emptyset to P are *skein equivalent* if, up to isotopy, their images under f_M are of the form $\sum_{i=1}^m \alpha_i \cdot (T_i \cup \hat{T})$ and $\sum_{i'=1}^{m'} \alpha'_{i'} \cdot (T'_{i'} \cup \hat{T})$ for some object $(\underline{\varepsilon}, \underline{V})$ of $\mathcal{R}_\mathcal{E}$,

for some \mathcal{C} -colored bichrome graph \hat{T} inside \hat{M} from $P_{(\underline{\varepsilon}, \underline{V})}$ to P , and for some skein equivalent linear combinations

$$\sum_{i=1}^m \alpha_i \cdot T_i \doteq \sum_{i'=1}^{m'} \alpha_{i'} \cdot T_{i'}$$

of \mathcal{C} -colored bichrome graphs inside D^3 from \emptyset to $P_{(\underline{\varepsilon}, \underline{V})}$.

If $\mathbb{S} = (\Sigma, P, \mathcal{L})$ is an object of $\check{\text{Cob}}_{\mathcal{C}}$ and M is a connected 3-dimensional cobordism from \emptyset to Σ , we denote with $\mathcal{V}(M; \mathbb{S})$ the vector space generated by isotopy classes of admissible \mathcal{C} -colored bichrome graphs inside M from \emptyset to P .

Proposition 3.13. *If $\mathbb{S} = (\Sigma, P, \mathcal{L})$ is an object of $\check{\text{Cob}}_{\mathcal{C}}$ and if M is a connected 3-dimensional cobordism from \emptyset to Σ then the linear map*

$$\begin{aligned} \pi_{\mathbb{S}} : \mathcal{V}(M; \mathbb{S}) &\rightarrow \text{V}_{\mathcal{C}}(\mathbb{S}) \\ T &\mapsto [M, T, 0] \end{aligned}$$

is surjective, and skein equivalent vectors of $\mathcal{V}(M; \mathbb{S})$ have the same image in $\text{V}_{\mathcal{C}}(\mathbb{S})$.

Proof. First of all we remark that if we have a skein equivalence

$$\sum_{i=1}^m \alpha_i \cdot T_i \doteq \sum_{i'=1}^{m'} \alpha_{i'} \cdot T_{i'}$$

between vectors of $\mathcal{V}(M; \mathbb{S})$, then

$$\sum_{i=1}^m \alpha_i \text{H}'_{\mathcal{C}}(\mathbb{M}'_{\mathbb{S}} \circ (M, T_i, 0)) = \sum_{i'=1}^{m'} \alpha_{i'} \text{H}'_{\mathcal{C}}(\mathbb{M}'_{\mathbb{S}} \circ (M, T_{i'}, 0))$$

for every morphism $\mathbb{M}'_{\mathbb{S}} : \mathbb{S} \rightarrow \emptyset$ of $\check{\text{Cob}}_{\mathcal{C}}$. This follows directly from the very definition of $\text{H}'_{\mathcal{C}}$ in terms of the Hennings-Reshetikhin-Turaev functor F_{λ} . Therefore skein equivalent vectors of $\mathcal{V}(M; \mathbb{S})$ have the same image in $\text{V}_{\mathcal{C}}(\mathbb{S})$.

What we just proved implies in particular, up to skein equivalence, we can assume every connected component of every vector in $\mathcal{V}(\mathbb{S})$ features an ε -colored coupon, or a Λ -colored coupon, or both. In order to show this, the idea is to use the properties of projective objects of \mathcal{C} . Indeed, if V is a projective H -module, then we can always find a section $s_V : V \rightarrow H \otimes V$ for the epimorphism $\varepsilon \otimes \text{id}_V : H \otimes V \rightarrow V$, i.e. an H -module morphism satisfying $(\varepsilon \otimes \text{id}_V) \circ s_V = \text{id}_V$, just like we did for turning red components blue in Section 3.2. Remark that, thanks to the pivotal structure of \mathcal{C} , projective H -modules are also injective, and we can always find a retraction $r_V : H \otimes V \rightarrow V$ for the monomorphism $\Lambda \otimes \text{id}_V : V \rightarrow H \otimes V$, i.e. an H -module morphism satisfying $r_V \circ (\Lambda \otimes \text{id}_V) = \text{id}_V$. This means that every time a vector of $\mathcal{V}(\mathbb{S})$ features a blue edge colored with some projective object V , we can replace a small portion of it with one of the \mathcal{C} -colored bichrome graphs represented in Figure 29 without altering the vector in the quotient $\text{V}_{\mathcal{C}}(\mathbb{S})$. We call this operation *projective trick*, and we will use it in the following argument.

Now, in order to prove that $\pi_{\mathbb{S}}$ is surjective, we have to show that for every vector $[M_{\Sigma}, T, n] \in \text{V}_{\mathcal{C}}(\mathbb{S})$ there exist admissible \mathcal{C} -colored bichrome graphs $T_1, \dots, T_m \subset M$ and coefficients $\alpha_1, \dots, \alpha_m \in \mathbb{k}$ such that

$$\sum_{i=1}^m \alpha_i \cdot [M, T_i, 0] = [M_{\Sigma}, T, n].$$

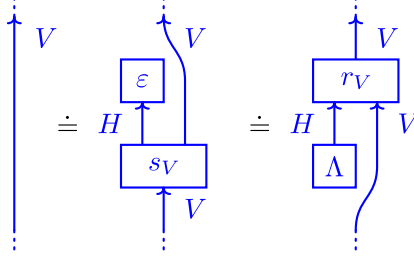
FIGURE 29. Projective trick along a V -colored blue edge.

We do this in two steps. First, we can assume that M_Σ is connected: indeed every time we have distinct connected components we can suppose, up to skein equivalence, one of them contains an ε -colored coupon while the other one contains a Λ -colored coupon. Then, thanks to Proposition 3.12, the 1-surgery connecting them will determine a vector of $V_{\mathcal{C}}(\Sigma)$ which is a non-zero scalar multiple of $[M_\Sigma, T, n]$. Second, assuming now M_Σ is connected, we know there exists a surgery link $L = L_1 \cup \dots \cup L_\ell$ for M_Σ inside M . Then, thanks to Proposition 3.12 with $k = 2$, there exists some signature defect $n' \in \mathbb{Z}$ such that

$$[M_\Sigma, T, n] = \lambda_2^\ell \cdot [M, L \cup T, n'] = \lambda_2^\ell \delta^{n'} \cdot [M, L \cup T, 0]$$

where, once again, we adopt a slightly abusive notation for the pull back of the \mathcal{C} -colored bichrome graph T along the embedding of the exterior of L into M_Σ . \square

If $\Sigma = (\Sigma, P, \mathcal{L})$ is an object of $\check{\text{Cob}}_{\mathcal{C}}$ and M' is a connected 3-dimensional cobordism from Σ to \emptyset then we denote with $\mathcal{V}'(M'; \Sigma)$ the vector space generated by isotopy classes of \mathcal{C} -colored bichrome graphs inside M' from P to \emptyset .

Proposition 3.14. *If $\Sigma = (\Sigma, P, \mathcal{L})$ is a connected object of $\check{\text{Cob}}_{\mathcal{C}}$ and if M' is a connected 3-dimensional cobordism from Σ to \emptyset then a vector $\sum_{i=1}^m \alpha_i \cdot [\mathbb{M}_{i, \Sigma}]$ in $V_{\mathcal{C}}(\Sigma)$ is trivial if and only if*

$$\sum_{i=1}^m \alpha_i H'_{\mathcal{C}}((M', T', 0) \circ \mathbb{M}_{i, \Sigma}) = 0$$

for every T' in $\mathcal{V}'(M'; \Sigma)$.

Proof. Connected morphisms of $\check{\text{Cob}}_{\mathcal{C}}$ from Σ to \emptyset are sufficient in order to detect non-triviality of vectors of $V_{\mathcal{C}}(\Sigma)$ because $H'_{\mathcal{C}}$ is multiplicative with respect to disjoint union. Then, just like in the proof of Proposition 3.13, we can trade index 2 surgery for red links inside M' . \square

3.6. Monoidality. We use the results of the previous two subsections in order to prove that the functor $V_{\mathcal{C}} : \check{\text{Cob}}_{\mathcal{C}} \rightarrow \text{Vect}_{\mathbb{k}}$ is a TQFT.

Theorem 3.15. *The natural transformation $\mu : \otimes \circ V_{\mathcal{C}} \Rightarrow V_{\mathcal{C}} \circ \otimes$ associating with every pair of objects Σ, Σ' of $\check{\text{Cob}}_{\mathcal{C}}$ the linear map*

$$\begin{aligned} \mu_{\Sigma, \Sigma'} : V_{\mathcal{C}}(\Sigma) \otimes V_{\mathcal{C}}(\Sigma') &\rightarrow V_{\mathcal{C}}(\Sigma \otimes \Sigma') \\ [\mathbb{M}_{\Sigma}] \otimes [\mathbb{M}_{\Sigma'}] &\mapsto [\mathbb{M}_{\Sigma} \otimes \mathbb{M}_{\Sigma'}] \end{aligned}$$

is an isomorphism.

Proof. Thanks to Proposition 3.11 we just need to prove that $\mu_{\Sigma, \Sigma'}$ is surjective for every pair of objects Σ, Σ' of $\check{\text{Cob}}_{\mathcal{C}}$. Let M_{Σ} be a connected cobordism from $\overline{S^2}$ to Σ and let $M_{\Sigma'}$ be a connected cobordism from S^2 to Σ' . Thanks to Proposition 3.13 we know $V_{\mathcal{C}}(\Sigma \otimes \Sigma')$ is generated by vectors of the form

$$[(D^1 \times S^2) \cup_{S^0 \times S^2} (M_{\Sigma} \sqcup M_{\Sigma'}), T, 0]$$

with T a \mathcal{C} -colored bichrome graph inside $(D^1 \times S^2) \cup_{S^0 \times S^2} (M_{\Sigma} \sqcup M_{\Sigma'})$ from \emptyset to $P \sqcup P'$. Let us choose such a T and let us show that the corresponding vector of $V_{\mathcal{C}}(\Sigma \otimes \Sigma')$ lies in the image of $\mu_{\Sigma, \Sigma'}$. Thanks to Lemma 3.8 we can suppose $D^1 \times S^2$ intersects only blue edges of T . Up to isotopy we can furthermore suppose $D^1 \times S^2$ intersects a projective edge of T . Then, up to skein equivalence, $D^1 \times S^2$ intersects a single edge whose color V is a projective object of \mathcal{C} . Therefore, there exist morphisms f_1, \dots, f_m in $\text{Hom}_{\mathcal{C}}(V, H)$ and f'_1, \dots, f'_m in $\text{Hom}_{\mathcal{C}}(H, V)$ satisfying

$$\text{id}_V = \sum_{i=1}^m f'_i \circ f_i.$$

Indeed, H splits as a direct sum with multiplicity of all the indecomposable projective modules of \mathcal{C} . This means that, up to skein equivalence,

$$[(D^1 \times S^2) \cup_{(S^0 \times S^2)} (M_{\Sigma} \sqcup M_{\Sigma'}), T, 0] = \sum_{i=1}^m [((M_{\Sigma}, T_i, 0) \otimes (M_{\Sigma'}, T'_i, 0)) \circ \mathbb{B}_1]$$

for the index 1 belt tube $\mathbb{B}_1 : \emptyset \rightarrow \Sigma_1$ introduced in Subsection 3.4. But Proposition 3.12 with $k = 1$ yields the equality $[\mathbb{B}_1] = \mathcal{D} \cdot [\mathbb{A}_1]$ between vectors of $V_{\mathcal{C}}(\Sigma_1)$, where $\mathbb{A}_1 : \emptyset \rightarrow \Sigma_1$ is the the index 1 attaching tube introduced in Subsection 3.4. Then we have the chain of equalities

$$\begin{aligned} & \sum_{i=1}^m [((M_{\Sigma}, T_i, 0) \otimes (M_{\Sigma'}, T'_i, 0)) \circ \mathbb{B}_1] \\ &= \sum_{i=1}^m \alpha_i \mathcal{D} \cdot [((M_{\Sigma}, T_i, 0) \otimes (M_{\Sigma'}, T'_i, 0)) \circ \mathbb{A}_1] \\ &= \sum_{i=1}^m \alpha_i \mathcal{D} \cdot \left[\left((M_{\Sigma}, T_i, 0) \circ \overline{\mathbb{D}}_{\varepsilon}^3 \right) \otimes \left((M_{\Sigma'}, T'_i, 0) \circ \mathbb{D}_{\Lambda}^3 \right) \right] \\ &= \sum_{i=1}^m \alpha_i \mathcal{D} \cdot \mu_{\Sigma, \Sigma'} \left(\left[(M_{\Sigma}, T_i, 0) \circ \overline{\mathbb{D}}_{\varepsilon}^3 \right] \otimes \left[(M_{\Sigma'}, T'_i, 0) \circ \mathbb{D}_{\Lambda}^3 \right] \right) \end{aligned}$$

for the morphisms $\overline{\mathbb{D}}_{\varepsilon}^3 : \emptyset \rightarrow \overline{\mathbb{S}}_{(-, H)}^2$ and $\mathbb{D}_{\Lambda}^3 : \emptyset \rightarrow \mathbb{S}_{(+, H)}^2$ of $\check{\text{Cob}}_{\mathcal{C}}$ represented in the left-hand part and in the right-hand part of Figure 26 respectively. \square

Remark 3.16. As a consequence of monoidality we get a kind of Verlinde formula for dualizable surfaces: if $\Sigma = (\Sigma, P, \mathcal{L})$ is an object of $\check{\text{Cob}}_{\mathcal{C}}$ then we denote with $\overline{\Sigma} = (\overline{\Sigma}, \overline{P}, \mathcal{L})$ the object obtained from Σ by reversing the orientation of both Σ and P . If P contains a point with projective color in every connected component of Σ then $\Sigma^* = \overline{\Sigma}$. Duality morphisms are given by cylinders, with $\overleftarrow{\text{ev}}_{\Sigma} : \Sigma^* \otimes \Sigma \rightarrow \emptyset$ and $\overleftarrow{\text{coev}}_{\Sigma} : \emptyset \rightarrow \Sigma \otimes \Sigma^*$ both realized by the same decorated 3-manifold realizing the identity $\text{id}_{\overline{\Sigma}} : \overline{\Sigma} \rightarrow \overline{\Sigma}$, although seen as different cobordisms. Furthermore, the braiding morphism $c_{\Sigma, \Sigma^*} : \Sigma \otimes \Sigma^* \rightarrow \Sigma^* \otimes \Sigma$ is realized by the same decorated 3-manifold realizing the identity $\text{id}_{\Sigma \otimes \overline{\Sigma}} : \Sigma \otimes \overline{\Sigma} \rightarrow \Sigma \otimes \overline{\Sigma}$

seen as a different cobordism. Therefore, if we set $\mathbb{S}^1 \times \Sigma := \overleftarrow{\text{ev}}_\Sigma \circ c_{\Sigma, \Sigma^*} \circ \overleftarrow{\text{coev}}_\Sigma$, we get

$$\begin{aligned} H'_\mathcal{C}(\mathbb{S}^1 \times \Sigma) &= V_\mathcal{C} \left(\overleftarrow{\text{ev}}_\Sigma \circ c_{\Sigma, \Sigma^*} \circ \overleftarrow{\text{coev}}_\Sigma \right) = \overrightarrow{\text{ev}}_{V_\mathcal{C}(\Sigma)} \circ \tau \circ \overleftarrow{\text{coev}}_{V_\mathcal{C}(\Sigma)} \\ &= \dim_{\mathbb{k}}(V_\mathcal{C}(\Sigma)), \end{aligned}$$

where $\tau([M_\Sigma] \otimes [M_{\Sigma^*}]) := [M_{\Sigma^*}] \otimes [M_\Sigma]$ for every $[M_\Sigma] \otimes [M_{\Sigma^*}] \in V_\mathcal{C}(\Sigma) \otimes V_\mathcal{C}(\Sigma^*)$.

3.7. Identification of TQFT spaces. In this subsection we show that TQFT vector spaces can be identified with the algebraic vector spaces defined in Subsection 3.1. Indeed, recall that we introduced for every $g \in \mathbb{N}$ and for every object V of \mathcal{C} the spaces

$$\begin{aligned} \tilde{\mathcal{X}}_{g,V} &= \text{Hom}_\mathcal{C}(H, X^{\otimes g} \otimes V), & \mathcal{X}'_{g,V} &= \text{Hom}_\mathcal{C}((X^*)^{\otimes g} \otimes V, \mathbb{1}), \\ \tilde{\mathcal{S}}_{g,V} &= \text{Hom}_{[g]\mathcal{C}}([g]H, [g]V), & \mathcal{S}'_{g,V} &= \text{Hom}_{[g]\mathcal{C}}([g]V, [g]\mathbb{1}), \end{aligned}$$

as well as the quotient $\mathcal{X}_{g,V}$ of $\tilde{\mathcal{X}}_{g,V}$ given by the right radical of the bilinear pairing $\langle \cdot, \cdot \rangle_{\mathcal{X}}$, and the quotient $\mathcal{S}_{g,V}$ of $\tilde{\mathcal{S}}_{g,V}$ given by the right radical of the bilinear pairing $\langle \cdot, \cdot \rangle_{\mathcal{S}}$. In Proposition 3.2 we gave explicit isomorphisms

$$\tilde{\mathcal{X}}_{g,V} \cong \tilde{\mathcal{S}}_{g,V}, \quad \mathcal{X}'_{g,V} \cong \mathcal{S}'_{g,V},$$

which, thanks to Proposition 3.5, also induce explicit isomorphisms

$$\mathcal{X}_{g,V} \cong \mathcal{S}_{g,V}.$$

Let us consider a genus g Heegaard splitting $M_g \cup_{\Sigma_g} M'_g$ of S^3 . Let P_V denote a \mathcal{C} -colored blue set inside Σ_g composed of a single point with positive orientation and color V and let \overline{P}_H denote another \mathcal{C} -colored blue set inside Σ_g composed of a single point with negative orientation and color H . Let \mathcal{L}_g denote the Lagrangian subspace of $H_1(\Sigma_g; \mathbb{R})$ given by the kernel of the inclusion of Σ_g into M_g . We denote with $\Sigma_{g,V}$ the object $(\Sigma_g, P_V, \mathcal{L}_g)$ of $\check{\text{Cob}}_\mathcal{C}$ and with $\Sigma_{g,V,H}$ the object $(\Sigma_g, P_V \cup \overline{P}_H, \mathcal{L}_g)$ of $\check{\text{Cob}}_\mathcal{C}$. Then the quotient of $\mathcal{V}(M_g; \Sigma_{g,V})$ with respect to the right radical of the bilinear form

$$\begin{aligned} \langle \cdot, \cdot \rangle_{S^3} : \mathcal{V}'(M'_g; \Sigma_{g,V}) \times \mathcal{V}(M_g; \Sigma_{g,V}) &\rightarrow \mathbb{k} \\ (T', T) &\mapsto F'_\lambda(T \cup_{P_V} T') \end{aligned}$$

is isomorphic to $V_\mathcal{C}(\Sigma_{g,V})$.

Let us consider the linear map

$$\begin{aligned} \mathcal{E} : \mathcal{V}(M_g; \Sigma_{g,V,H}) &\rightarrow V_\mathcal{C}(\Sigma_{g,V}) \\ T &\mapsto [M_g \cup_{\Sigma_g} (I \times \Sigma_g), T \cup_{(P_V \cup \overline{P}_H)} T_\Lambda, 0] \end{aligned}$$

where $T_\Lambda \subset I \times \Sigma_g$ is the \mathcal{C} -colored bichrome graph from $P_V \cup \overline{P}_H$ to P_V represented in Figure 30 inside $I \times N(P_V \cup \overline{P}_H) \subset I \times \Sigma_g$ for a tubular neighborhood $N(P_V \cup \overline{P}_H)$ of $P_V \cup \overline{P}_H$ inside Σ_g .

Proposition 3.17. *The linear map $\mathcal{E} : \mathcal{V}(M_g; \Sigma_{g,V,H}) \rightarrow V_\mathcal{C}(\Sigma_{g,V})$ is surjective.*

Proof. Every vector of $V_\mathcal{C}(\Sigma_{g,V})$ is of the form $[M_g \cup_{\Sigma_g} (I \times \Sigma_g), T, 0]$ for some admissible \mathcal{C} -colored bichrome graph $T \in M_g \cup (I \times \Sigma_g)$ from \emptyset to P_V thanks to Proposition 3.13. Up to skein equivalence we can suppose T features a Λ -colored coupon, and up to isotopy we can conclude. \square

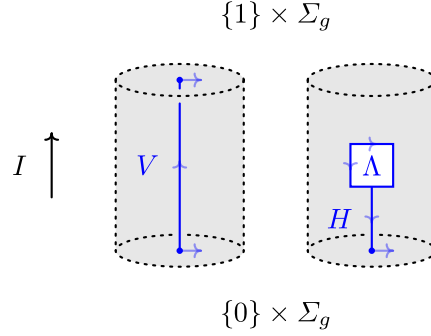
 FIGURE 30. The \mathcal{C} -colored bichrome graph T_Λ .

Let us fix now a standard embedding ι_g of M_g into $\mathbb{R}^2 \times I$ and let us consider the linear map

$$\Phi : \mathcal{V}(M_g; \Sigma_{g,V,H}) \rightarrow \tilde{\mathcal{S}}_{g,V}$$

sending an admissible \mathcal{C} -colored bichrome graph $T \subset M_g$ from \emptyset to $P_V \cup \bar{P}_H$ to the morphism of \mathcal{C} obtained by evaluating the Hennings-Reshetikhin-Turaev functor F_λ against the \mathcal{C} -colored g -string link graph obtained as described by Figure 31.

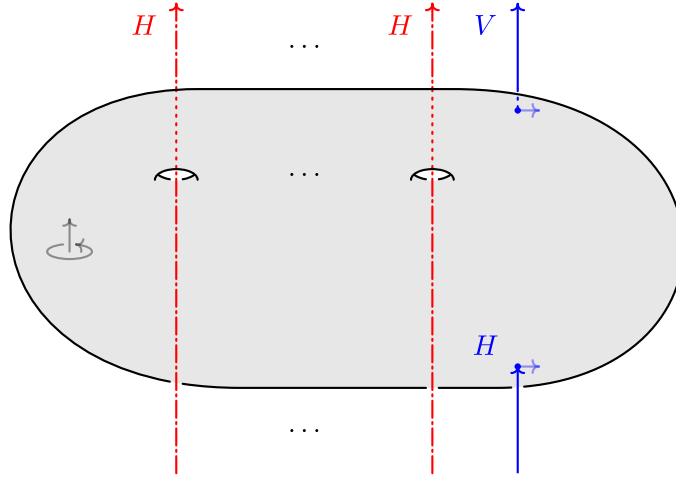

FIGURE 31. How to obtain a g -string link graph from a \mathcal{C} -colored bichrome graph $T \subset M_g$ from \emptyset to $P_V \sqcup \bar{P}_H$ using the standard embedding ι_g .

Proposition 3.18. *The linear map $\Phi : \mathcal{V}(M_g; \Sigma_{g,V,H}) \rightarrow \tilde{\mathcal{S}}_{g,V}$ is surjective.*

Proof. Let us consider the linear map $\Psi : \tilde{\mathcal{X}}_{g,V} \rightarrow \mathcal{V}(M_g; \Sigma_{g,V,H})$ sending every f in $\tilde{\mathcal{X}}_{g,V}$ to the admissible \mathcal{C} -colored bichrome graph T_f represented in Figure 32. Now, using the notation of Proposition 3.2, we have

$$\Phi \circ \Psi = \Theta.$$

Then Φ is surjective because Θ is an isomorphism. \square

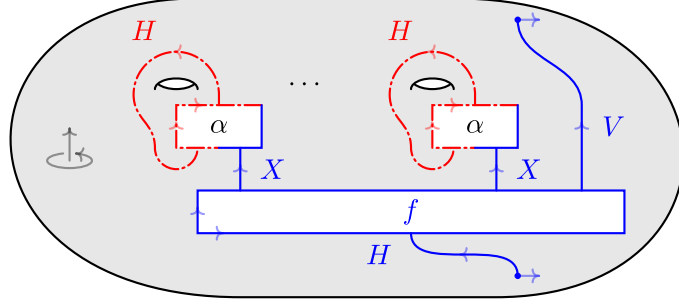
FIGURE 32. The admissible \mathcal{C} -colored bichrome graph T_f .

Let us fix now a standard embedding ι'_g of M'_g into $\mathbb{R}^2 \times I$ and let us consider the linear map

$$\Phi' : \mathcal{V}'(M'_g; \Sigma_{g,V}) \rightarrow \mathcal{S}'_{g,V}$$

sending every \mathcal{C} -colored bichrome graph $T' \subset M'_g$ from P_V to \emptyset to the morphism of \mathcal{C} obtained by evaluating the Hennings-Reshetikhin-Turaev functor F_λ against the \mathcal{C} -colored g -string link graph obtained as described by Figure 33.

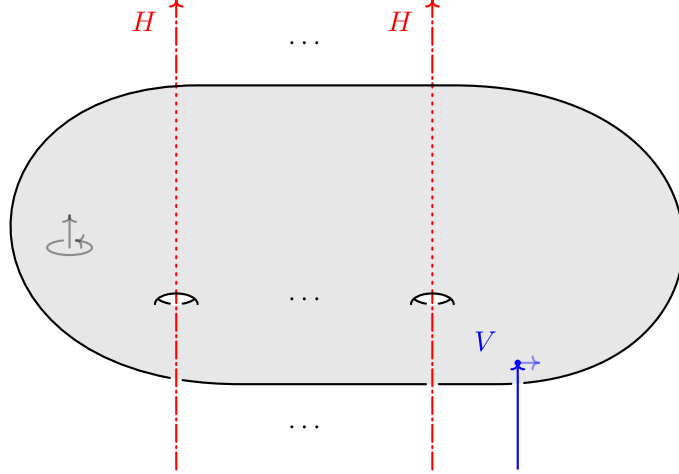
FIGURE 33. How to obtain a g -string link graph from a \mathcal{C} -colored bichrome graph $T' \subset M'_g$ from P_V to \emptyset using the standard embedding ι'_g .

Proposition 3.19. *The linear map $\Phi' : \mathcal{V}'(M'_g; \Sigma_{g,V}) \rightarrow \mathcal{S}'_{g,V}$ is surjective.*

Proof. Let us consider the linear map $\Psi' : \mathcal{X}'_{g,V} \rightarrow \mathcal{V}'(M'_g; \Sigma_{g,V})$ sending every f' in $\mathcal{X}'_{g,V}$ to the admissible \mathcal{C} -colored bichrome graph $T_{f'}$ represented in Figure 34. Now, using the notation of Proposition 3.2, we have

$$\Phi' \circ \Psi' = \Theta'.$$

Then Φ' is surjective because Θ' is an isomorphism. \square

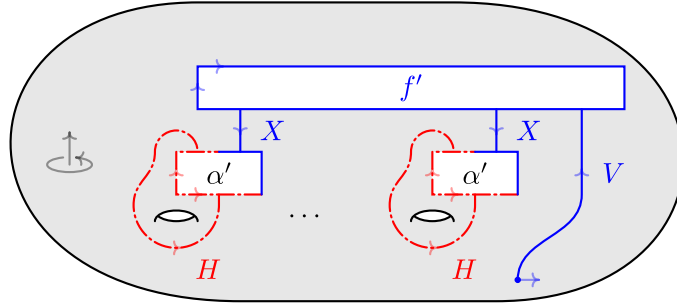
 FIGURE 34. The admissible \mathcal{E} -colored bichrome graph $T_{f'}$.

Proposition 3.20. *Every \mathcal{E} -colored bichrome graph T' in $\mathcal{V}'(M'_g; \Sigma_{g,V})$ and every admissible \mathcal{E} -colored bichrome graph T in $\mathcal{V}(M_g; \Sigma_{g,V,H})$ satisfy*

$$\langle T', \mathcal{E}(T) \rangle_{S^3} = \langle \Phi'(T'), \Phi(T) \rangle_{\mathcal{E}} = \langle \Theta'^{-1}(\Phi'(T')), \Theta^{-1}(\Phi(T)) \rangle_{\mathcal{E}}.$$

Proof. We can compute $\langle T', \mathcal{E}(T) \rangle_{S^3}$ using the surgery presentation of Figure 35 for the morphism

$$(M_g \cup_{\Sigma_g} (I \times \Sigma_g) \cup_{\Sigma_g} M'_g, \mathcal{E}(T) \cup_{P_V} T', 0)$$

of $\check{\text{Cob}}_{\mathcal{E}}$.

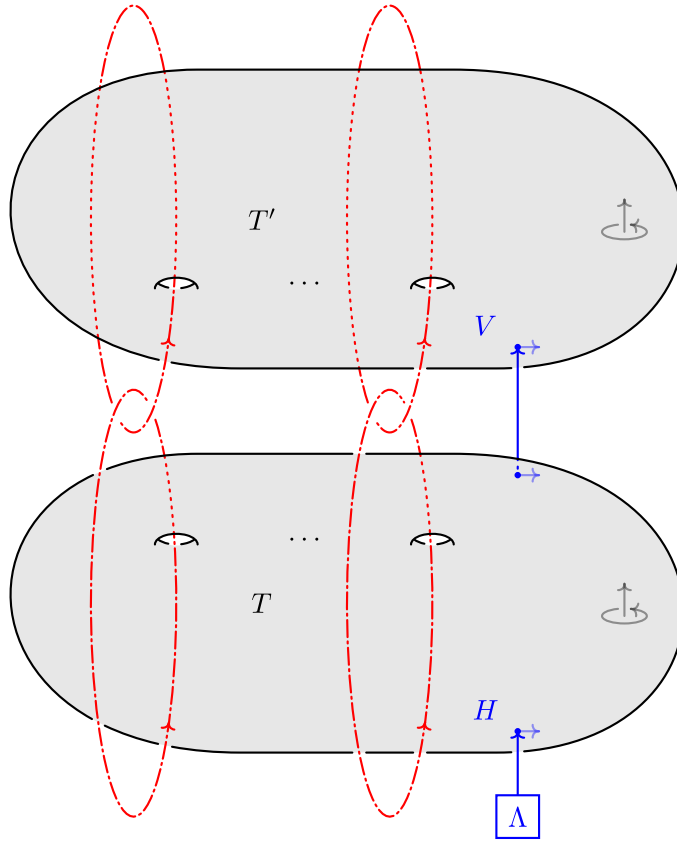
 FIGURE 35. Surgery presentation computing $\langle T', \mathcal{E}(T) \rangle_{S^3}$.

To see this is a surgery presentation of S^3 we can start with the Heegaard splitting $M_g \cup_{\Sigma_g} M'_g$ and remark that surgery on the red Hopf links allows us to disentangle the two handlebodies, see Figure 36.

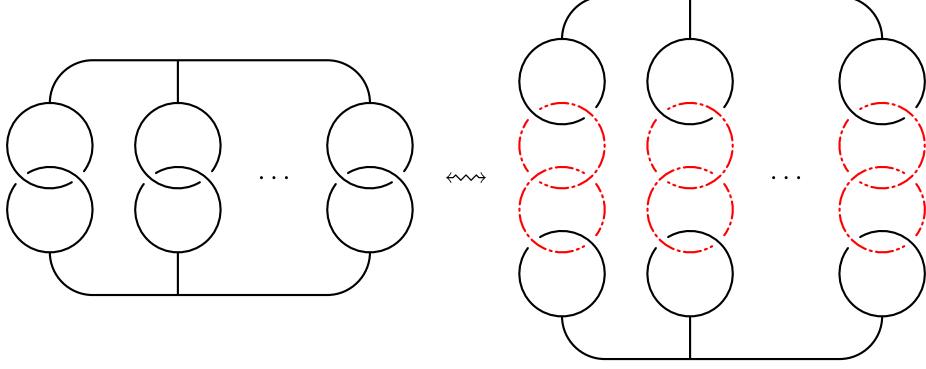

FIGURE 36. The complementary handlebodies M_g and M'_g can be realized as tubular neighborhoods of the two trivalent graphs in S^3 represented on the left. Surgery on the red Hopf links allows us to disentangle them.

Then, in order to compute

$$H'_{\mathcal{C}}(M_g \cup_{\Sigma_g} (I \times \Sigma_g) \cup_{\Sigma_g} M'_g, \mathcal{C}(T) \cup_{P_V} T', 0),$$

we can consider $\mathcal{C}(T) \cup_{P_V} T'$ and cut open the bottom H -colored blue edge in Figure 35. This will result in a \mathcal{C} -colored bichrome graph from $(H, +)$ to itself which, in the notation of Figure 19, is precisely $T_{\mathcal{S}, \Phi(T), \Phi'(T')}$. Now the definition of the pairing $\langle \cdot, \cdot \rangle_{\mathcal{S}}$, together with Proposition 3.5, gives the result. \square

If Σ is a connected surface then let $g(\Sigma)$ denote its genus. If $P = P_1 \cup \dots \cup P_k$ is a \mathcal{C} -colored blue set inside a Σ with P_i given by a single point having orientation ε_i and color V_i for every $i \in \{1, \dots, k\}$, then let $F_{\mathcal{C}}(P)$ denote the object $V_1^{\varepsilon_1} \otimes \dots \otimes V_k^{\varepsilon_k}$ of \mathcal{C} where $V_i^+ := V_i$ and $V_i^- := V_i^*$. Remark that the isomorphism class of $F_{\mathcal{C}}(P)$ is independent of the ordering of P .

Corollary 3.21. *If $\mathbb{X} = (\Sigma, P, \mathcal{L})$ is a connected object of $\check{\text{Cob}}_{\mathcal{C}}$ then there exist isomorphisms $V_{\mathcal{C}}(\mathbb{X}) \cong \mathcal{X}_{g(\Sigma), F_{\mathcal{C}}(P)}$ and $V'_{\mathcal{C}}(\mathbb{X}) \cong \mathcal{X}'_{g(\Sigma), F_{\mathcal{C}}(P)}$ which are compatible with the pairings $\langle \cdot, \cdot \rangle_{\mathbb{X}}$ and $\langle \cdot, \cdot \rangle_{\mathcal{X}}$.*

Proof. Let $\gamma \subset \Sigma$ be a separating curve which cuts a disc D containing P from Σ . Let \tilde{P} denote a \mathcal{C} -colored blue set inside D given by a single point with positive orientation and color $F_{\mathcal{C}}(P)$. Let $\tilde{\mathbb{X}}$ denote the object $(\Sigma, \tilde{P}, \mathcal{L})$ and let us consider the morphism $\mathbb{I} \times \mathbb{X} : \mathbb{X} \rightarrow \tilde{\mathbb{X}}$ given by $(I \times \Sigma, T_{\text{id}}, 0)$ where $T_{\text{id}} \subset I \times \Sigma$ is the \mathcal{C} -colored bichrome graph from P to \tilde{P} represented in Figure 37 inside $I \times D$. Then $V_{\mathcal{C}}(\mathbb{I} \times \mathbb{X}) : V_{\mathcal{C}}(\mathbb{X}) \rightarrow V_{\mathcal{C}}(\tilde{\mathbb{X}})$ is an isomorphism. But now if $M \cup_{\Sigma} M'$ is a Heegaard splitting of S^3 and if

$$\langle \cdot, \cdot \rangle_{S^3} : \mathcal{V}'(M'; \tilde{\mathbb{X}}) \times \mathcal{V}(M; \tilde{\mathbb{X}}) \rightarrow \mathbb{k}$$

is the associated bilinear form then both $V_{\mathcal{C}}(\tilde{\mathbb{X}})$ and $\mathcal{X}_{g(\Sigma), F_{\mathcal{C}}(P)}$ are isomorphic to the quotient of $\mathcal{V}(M; \tilde{\mathbb{X}})$ with respect to the right radical of $\langle \cdot, \cdot \rangle_{S^3}$ and both

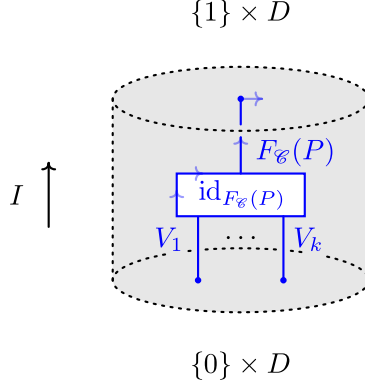
FIGURE 37. The \mathcal{E} -colored bichrome graph T_{id} .

$V'_{\mathcal{E}}(\tilde{\Sigma})$ and $\mathcal{X}'_{g(\Sigma), F_{\mathcal{E}}(P)}$ are isomorphic to the quotient of $\mathcal{V}'(M'; \tilde{\Sigma})$ with respect to the left radical of $\langle \cdot, \cdot \rangle_{S^3}$. \square

Remark 3.22. Dehn twists act on TQFT spaces like curve operators. Indeed, let $\Sigma = (\Sigma, P, \mathcal{L})$ be an object of $\check{\text{Cob}}_{\mathcal{E}}$ and let $\gamma \subset \Sigma$ be an oriented simple closed curve. If $I \times \Sigma$ denotes the cylinder cobordism from Σ to itself, let $K_{\gamma} \subset I \times \Sigma$ denote the red knot $\{\frac{1}{2}\} \times \gamma$ with framing determined by the homology class $[\ell + m] \in H_1(\partial N)$, where then N is a tubular neighborhood of $\{\frac{1}{2}\} \times \gamma$, where m is a positive meridian of ∂N in N , and where ℓ is a positive longitude of ∂N contained in $\partial N \cap (I \times \gamma)$. Then the action of a Dehn twist along γ on a vector $[\mathbb{M}'_{\Sigma}]$ in $V'_{\mathcal{E}}(\Sigma)$ is given by

$$[\mathbb{M}'_{\Sigma} \circ (I \times \Sigma, K_{\gamma}, 0)].$$

4. EXAMPLES AND RELATED CONSTRUCTIONS

In Section 2 we constructed a 3-manifold invariant from a finite-dimensional non-degenerate unimodular ribbon Hopf algebra. If this Hopf algebra is factorizable then in Section 3 we showed the 3-manifold invariant extends to a 2 + 1-TQFT. As discussed in the introduction, such Hopf algebras have been studied at length. In this section we highlight a few examples. We also relate our 3-manifold invariant to the logarithmic Hennings invariant of [3] and to the Generalized Kashaev invariant of [49].

4.1. Drinfeld doubles. An important family of examples is provided by Drinfeld doubles of finite-dimensional Hopf algebras. If H is a finite-dimensional Hopf algebra, then it is well known that its Drinfeld double $D(H)$ is always factorizable, and in particular non-degenerate unimodular. See [14, 16, 32, 54] for references. Furthermore, by Kauffman and Radford [33], it is also known precisely when a Drinfeld double is a ribbon Hopf algebra. Indeed, a right integral $\lambda \in H^*$ and a two-sided cointegral $\Lambda \in H$ satisfying $\lambda(\Lambda) = 1$ uniquely determine elements $a \in H$ and $\alpha \in H^*$ satisfying

$$\begin{aligned} f\lambda &= f(a) \cdot \lambda, & \Lambda x &= \alpha(x) \cdot \Lambda, & \varepsilon(a) &= \alpha(1_H) = 1, \\ S^4(x) &= \alpha^{-1}(x_{(1)})\alpha(x_{(3)}) \cdot ax_{(2)}a^{-1} \end{aligned}$$

for all $f \in H^*$ and $x \in H$. Then $D(H)$ is ribbon if and only if there exist elements $g \in H$ and $\gamma \in H^*$ satisfying

$$g^2 = a, \quad \gamma^2 = \alpha, \quad \varepsilon(g) = \gamma(1_H) = 1, \\ S^2(x) = \gamma^{-1}(x_{(1)})\gamma(x_{(3)}) \cdot gx_{(2)}g^{-1}$$

for every $x \in H$.

4.2. Quantum groups. Many examples of the type of Hopf algebras we are considering come from quantum groups. In particular, to each simple Lie algebra one can associate several finite-dimensional quantum groups depending on many ingredients, including the choice of a root of unity. These factors determine whether the quantum group is ribbon and/or factorizable, for details see [45, 41, 42, 40]. In this subsection, we will discuss finite-dimensional quantum groups associated to \mathfrak{sl}_2 , which have different properties depending on the order of the root of unity.

Let us fix $r \geq 3$ and let us choose the primitive r -th root of unity $q = e^{\frac{2\pi i}{r}}$. Let us set $\bar{r} := r$ if r is odd and $\bar{r} := \frac{r}{2}$ if r is even. We also introduce for all $k \geq \ell \in \mathbb{N}$ the standard notation

$$\{k\} := q^k - q^{-k}, \quad [k] := \frac{\{k\}}{\{1\}}, \quad [k]! := [k][k-1] \cdots [1].$$

We denote with $\bar{U}_q\mathfrak{sl}_2$ the \mathbb{C} -algebra with generators $\{E, F, K, K^{-1}\}$ and relations

$$KK^{-1} = K^{-1}K = 1, \quad KEK^{-1} = q^2E, \quad KFK^{-1} = q^{-2}F, \\ [E, F] = \frac{K - K^{-1}}{q - q^{-1}}, \quad E^{\bar{r}} = F^{\bar{r}} = 0, \quad K^r = 1.$$

We can make $\bar{U}_q\mathfrak{sl}_2$ into a Hopf algebra by setting

$$\Delta(E) = E \otimes K + 1 \otimes E, \quad \varepsilon(E) = 0, \quad S(E) = -EK^{-1}, \\ \Delta(F) = F \otimes 1 + K^{-1} \otimes F, \quad \varepsilon(F) = 0, \quad S(F) = -KF, \\ \Delta(K) = K \otimes K, \quad \varepsilon(K) = 1, \quad S(K) = K^{-1}.$$

A Poincaré-Birkhoff-Witt basis for $\bar{U}_q\mathfrak{sl}_2$ is given by

$$\{E^b F^c K^m \mid 0 \leq b, c \leq \bar{r} - 1, 0 \leq m \leq r - 1\}.$$

A right integral λ of $\bar{U}_q\mathfrak{sl}_2$ is determined by

$$\lambda(E^b F^c K^m) = \xi \delta_{b, \bar{r}-1} \delta_{c, \bar{r}-1} \delta_{m, r-\bar{r}+1}$$

where ξ is any non-zero constant. A two-sided cointegral Λ of $\bar{U}_q\mathfrak{sl}_2$ is given by

$$\frac{1}{\xi} \cdot \sum_{m=0}^{r-1} E^{\bar{r}-1} F^{\bar{r}-1} K^m = \frac{1}{\xi} \cdot \sum_{m=0}^{r-1} F^{\bar{r}-1} E^{\bar{r}-1} K^m.$$

In particular, $\bar{U}_q\mathfrak{sl}_2$ is always unimodular. A pivotal element $g \in \bar{U}_q\mathfrak{sl}_2$ is given by $K^{\bar{r}+1}$. Furthermore, as shown in [50], when r is odd $\bar{U}_q\mathfrak{sl}_2$ is also ribbon and factorizable. Indeed, an R-matrix $R \in \bar{U}_q\mathfrak{sl}_2 \otimes \bar{U}_q\mathfrak{sl}_2$ is given by

$$\frac{1}{r} \cdot \sum_{b, \ell, m=0}^{r-1} \frac{\{1\}^b}{[b]!} q^{\frac{b(b-1)}{2} + 2(b(\ell-m) - \ell m)} \cdot E^b K^\ell \otimes F^b K^m,$$

and a ribbon element $v \in \bar{U}_q \mathfrak{sl}_2$ is given by

$$\frac{1}{r} \cdot \sum_{b,\ell,m=0}^{r-1} \frac{\{1\}^b}{[b]!} q^{\frac{b(b-1)}{2} - \frac{(r+1)(b-m-1)^2}{2} + 2(\ell^2 - bm)} \cdot E^b F^b K^m.$$

Thus, when r is odd, $\bar{U}_q \mathfrak{sl}_2$ gives rise to a TQFT as in Section 3.

For odd values of r we call $\bar{U}_q \mathfrak{sl}_2$ the *small quantum group of \mathfrak{sl}_2* , while for even values of r we call it the *restricted quantum group of \mathfrak{sl}_2* .

4.3. Logarithmic Hennings invariants. The logarithmic Hennings invariant constructed in [3] is based on the restricted version of the quantum group of \mathfrak{sl}_2 , that is $\bar{U}_q \mathfrak{sl}_2$ when r is even. This Hopf algebra is not quasi-triangular and so the construction of this paper does not immediately apply. However, the restricted quantum group of \mathfrak{sl}_2 admits a ribbon extension D which is unimodular and non-degenerate, and which therefore allows for the construction of our 3-manifold invariant. As we will explain next, this 3-manifold invariant recovers the logarithmic Hennings invariant. Note that, since D is not factorizable, our 2 + 1-TQFT construction does not directly apply to the restricted case.

Let us recall the definition of the ribbon extension D of $\bar{U}_q \mathfrak{sl}_2$ when $r = 2p$ for the choice of the primitive $2p$ -th root of unity $q = e^{\frac{\pi i}{p}}$: let D be the \mathbb{C} -algebra with generators $\{e, f, k, k^{-1}\}$ and relations

$$\begin{aligned} k k^{-1} &= k^{-1} k = 1, & k e k^{-1} &= q e, & k f k^{-1} &= q^{-1} f, \\ [e, f] &= \frac{k^2 - k^{-2}}{q - q^{-1}}, & e^p &= f^p = 0, & k^{4p} &= 1. \end{aligned}$$

It can be made into a Hopf algebra by setting

$$\begin{aligned} \Delta(e) &= e \otimes k^2 + 1 \otimes e, & \varepsilon(e) &= 0, & S(e) &= -e k^{-2}, \\ \Delta(f) &= f \otimes 1 + k^{-2} \otimes f, & \varepsilon(f) &= 0, & S(f) &= -k^2 f, \\ \Delta(k) &= k \otimes k, & \varepsilon(k) &= 1, & S(k) &= k^{-1}. \end{aligned}$$

The restricted quantum group $\bar{U}_q \mathfrak{sl}_2$ embeds into D by sending E to e , F to f and K to k^2 . We denote U as the image of $\bar{U}_q \mathfrak{sl}_2$ in D . A Poincaré-Birkhoff-Witt basis for D is given by

$$\{e^b f^c k^m \mid 0 \leq b, c \leq p-1, 0 \leq m \leq 4p-1\}.$$

A right integral λ of D is determined by

$$\lambda(e^b f^c k^m) = \xi \delta_{b,p-1} \delta_{c,p-1} \delta_{m,2p+2}.$$

Following [49, 3], we choose the normalization

$$\xi = \sqrt{\frac{2}{p}} ([p-1]!)^2.$$

A two-sided cointegral Λ of D is given by

$$\frac{1}{\xi} \cdot \sum_{m=0}^{4p-1} e^{p-1} f^{p-1} k^m.$$

In particular, D is unimodular. A pivotal element $g \in D$ is given by k^{2p+2} . An R-matrix $R \in D \otimes D$ is given by

$$\frac{1}{4p} \cdot \sum_{b=0}^{p-1} \sum_{\ell, m=0}^{4p-1} \frac{\{1\}^b}{[b]!} q^{\frac{b(b-1)}{2} + b(\ell-m) - \frac{\ell m}{2}} \cdot e^b k^\ell \otimes f^b k^m,$$

where $q^{\frac{1}{2}} := e^{\frac{\pi i}{2p}}$. A ribbon element $v \in D$ is given by

$$\frac{1-i}{2\sqrt{p}} \cdot \sum_{b=0}^{p-1} \sum_{m=0}^{2p-1} \frac{\{1\}^b}{[b]!} q^{-\frac{b(2m+1)}{2} + \frac{(m-p-1)^2}{2}} \cdot e^b f^b k^{2m}.$$

An easy computation shows that

$$\Delta_- = \lambda(v) = \frac{1-i}{\sqrt{2p}} \{1\}^{p-1} [p-1]! q^{-\frac{(p-1)(2p+3)}{2}} \neq 0.$$

An analogous computation shows that $\Delta_+ = \lambda(v^{-1}) \neq 0$. Therefore, D is non-degenerate.

Summarizing the above we have that D is a finite-dimensional non-degenerate unimodular ribbon Hopf algebra. Thus, Theorem 2.9 implies there exists a renormalized Hennings invariant $H'_{\mathcal{C}}$ associated with $\mathcal{C} = D\text{-mod}$. By restricting the integral of D to the subalgebra U we recover the formulas given in the previous subsection and in [3].

Next, we will explain how $H'_{\mathcal{C}}$ is related to the logarithmic Hennings invariant H^{\log} of [3]. The latter is an invariant of closed 3-manifolds endowed with links which are labeled with elements of the Hopf algebra U as follows. Let $L = L_+ \cup L_-$ be a link inside a closed 3-manifold M . Each component of L_- is labeled with an element of the 0th-Hochschild homology $\text{HH}_0(U) = U/[U, U]$ of U , where $[U, U] = \text{Span}\{xy - yx | x, y \in U\}$. Each component of L_+ is labeled with an element of the center $Z(U)$ of U . The invariant $H^{\log}(M, L_+ \cup L_-)$ is defined using the underlying ribbon structure of D , but the result only depends on U since the M-matrix $R_{21}R_{12}$ is in $U \otimes U$ and the ribbon element v is in U . We will now associate with $L_+ \cup L_-$ a \mathcal{C} -colored n -string link $L'_+ \cup L'_-$. Remark that every $z \in Z(U)$ is also central in D under inclusion, so that $L_z : D \rightarrow D$ is a morphism in the category $\mathcal{C} = D\text{-mod}$. Let L'_+ be the \mathcal{C} -colored red graph obtained from $L_+ \subset L_+ \cup L_-$ by adding to every z -colored component a $(1, 1)$ -coupon colored with L_z . On the other hand, for any $x \in D$ the right multiplication $R_x : D \rightarrow D$ is a morphism in \mathcal{C} . Let L'_- be the \mathcal{C} -colored blue graph obtained from $L_- \subset L_+ \cup L_-$ by adding to every $[x]$ -colored component a $(1, 1)$ -coupon colored with R_x where $x \in U$ is any representative of $[x] \in \text{HH}_0(U) = U/[U, U]$. All edges of $L'_+ \cup L'_-$ are colored with the regular representation D . Properties of the modified trace imply that $H'_{\mathcal{C}}(M, L'_+ \cup L'_-)$ does not depend on the choice of the representative x of $[x] \in \text{HH}_0(U)$. From the definition of the invariants we have the equality

$$H'_{\mathcal{C}}(M, L'_+ \cup L'_-) = H^{\log}(M, L_+ \cup L_-).$$

4.4. Generalized Kashaev invariants. In [49], Jun Murakami defines a generalized Kashaev invariant of a link K in a 3-manifold M by combining the Hennings invariant associated with the restricted version $\bar{U}_q \mathfrak{sl}_2$ of quantum \mathfrak{sl}_2 and the ADO invariant associated with the medium version $\bar{U}_q \mathfrak{sl}_2$ of quantum \mathfrak{sl}_2 , see [1, 49]. These two theories overlap with the use of the Steinberg-Kashaev module V_0 . At

a primitive $2p$ -th root of unity, this is a p -dimensional simple projective module of both $\bar{U}_q \mathfrak{sl}_2$ and $\tilde{U}_q \mathfrak{sl}_2$.

Our functors F_λ are a generalization of Murakami's invariant $\tilde{\text{GK}}_p$: first, let M be represented by surgery along a framed link L and let \hat{K} be the pre-image of K in S^3 . Let T be the $(1, 1)$ -tangle obtained from $L \cup \hat{K}$ by cutting open one of the components of \hat{K} . Let T' be the \mathcal{C} -colored n -string tangle determined by T by declaring every component of L to be red and every component of \hat{K} to be blue and colored with V_0 . Then by construction

$$\tilde{\text{GK}}_p(T) = F_\lambda(T'),$$

and $\tilde{\text{GK}}_p(T)$ does not depend on the component of K which is cut, see Theorem 5 of [49]. Our Theorem 2.7 gives a new proof of this fact. Note that in this case the renormalization given by the modified trace only changes F_λ by a global constant because each component of \hat{K} is colored with the same module V_0 .

As in Subsection 2.3, Murakami uses standard techniques to scale $\tilde{\text{GK}}_p(T)$ and construct an invariant GK_p of the pair (M, K) . Thus, after a global normalization, we have that $\text{GK}_p(M, K)$ is equal to $\text{H}'_{\mathcal{C}}(M, T')$.

REFERENCES

- [1] Y. Akutsu, T. Deguchi, T. Ohtsuki – *Invariants of Colored Links* – Journal of Knot Theory and Its Ramifications, Volume 1, Issue 2, June 1992, Pages 161-184
- [2] M. Atiyah – *Topological Quantum Field Theory* – Publications Mathématiques de l'IHÉS, Volume 68, 1988, Pages 175-186
- [3] A. Beliakova, C. Blanchet, N. Geer – *Logarithmic Hennings Invariants for Restricted Quantum $\mathfrak{sl}(2)$* – [arXiv:1705.03083](https://arxiv.org/abs/1705.03083) [math.GT]
- [4] A. Beliakova, C. Blanchet, A. Gainutdinov – *Modified Trace is a Symmetrised Integral* – [arXiv:1801.00321](https://arxiv.org/abs/1801.00321) [math.QA]
- [5] C. Blanchet, F. Costantino, N. Geer, B. Patureau-Mirand – *Non-Semisimple TQFTs, Reidemeister Torsion and Kashaev's Invariants* – Advances in Mathematics, Volume 301, 1 October 2016, Pages 1-78
- [6] C. Blanchet, N. Habegger, G. Masbaum, P. Vogel – *Topological Quantum Field Theories Derived from the Kauffman Bracket* – Topology, Volume 34, Issue 4, 1995, Pages 883-927
- [7] P. Bushlanov, A. Gainutdinov, I. Tipunin – *Kazhdan-Lusztig Equivalence and Fusion of Kac Modules in Virasoro Logarithmic Models* – Nuclear Physics B, Volume 862, Issue 1, 1 September 2012, Pages 232-269
- [8] P. Bushlanov, B. Feigin, A. Gainutdinov, I. Tipunin – *Lusztig Limit of Quantum $\mathfrak{sl}(2)$ at Root of Unity and Fusion of $(1, p)$ Virasoro Logarithmic Minimal Models* – Nuclear Physics B, Volume 818, Issue 3, 11 September 2009, Pages 179-195
- [9] V. Chari, A. Pressley – *A Guide to Quantum Groups* – Cambridge University Press, July 1995
- [10] M. Cohen, S. Westreich – *Characters and a Verlinde-Type Formula for Symmetric Hopf Algebras* – Journal of Algebra, Volume 320, 2008, Pages 4300-4316.
- [11] F. Costantino, N. Geer, B. Patureau-Mirand – *Quantum Invariants of 3-Manifolds via Link Surgery Presentations and Non-Semi-Simple Categories* – Journal of Topology, Volume 7, Number 4, 2014, Pages 1005-1053
- [12] T. Creutzig, D. Ridout, S. Wood – *Coset Constructions of Logarithmic $(1, p)$ Models* – Letters in Mathematical Physics, Volume 104, Issue 5, May 2014, Pages 553-583
- [13] M. De Renzi – *Non-Semisimple Extended Topological Quantum Field Theories* – [arXiv:1703.07573](https://arxiv.org/abs/1703.07573) [math.GT]
- [14] V. Drinfeld – *Quantum Groups* – Journal of Soviet Mathematics, Volume 41, Issue 2, April 1988, Pages 898-915
- [15] V. Drinfeld – *Almost Cocommutative Hopf Algebras* – Algebra i Analiz, Volume 1, Issue 2, 1989, Pages 30-46 – English Translation in Leningrad Mathematical Journal, Volume 1, Issue 2, 1990, Pages 321-342

- [16] P. Etingof, S. Gelaki, D. Nikshych, V. Ostrik – *Tensor Categories* – Mathematical Surveys and Monographs, Volume 205, American Mathematical Society, 2015
- [17] B. Feigin, A. Gainutdinov, A. Semikhatov, I. Tipunin – *Modular Group Representations and Fusion in Logarithmic Conformal Field Theories and in the Quantum Group Center* – Communications in Mathematical Physics, July 2006, Volume 265, Issue 1, Pages 47-93
- [18] C. Frohman, A. Nicas – *The Alexander Polynomial via Topological Quantum Field Theory* – Differential Geometry, Global Analysis, and Topology, Canadian Mathematical Society Conference Proceedings, Volume 12, American Mathematical Society, Providence, Rhode Island, 1992, Pages 27-40.
- [19] J. Fuchs, S. Hwang, A. Semikhatov, I. Tipunin – *Nonsemisimple Fusion Algebras and the Verlinde Formula* – Communications in Mathematical Physics, Volume 247, Issue 3, June 2004, Pages 713-742
- [20] J. Fuchs, I. Runkel, C. Schweigert – *Twenty Five Years of Two-Dimensional Rational Conformal Field Theory* – Journal of Mathematical Physics, Volume 51, Issue 1, 015210, 2010
- [21] J. Fuchs, C. Schweigert – *Hopf Algebras and Finite Tensor Categories in Conformal Field Theory* – Revista de la Unión Matemática Argentina, Volume 51, Number 2, 2010, Pages 43-90
- [22] J. Fuchs, C. Schweigert – *Consistent Systems of Correlators in Non-Semisimple Conformal Field Theory* – Advances in Mathematics, Volume 307, 5 February 2017, Pages 598-639
- [23] J. Fuchs, C. Schweigert, C. Stigner – *From Non-Semisimple Hopf Algebras to Correlation Functions for Logarithmic CFT* – Journal of Physics A: Mathematical and Theoretical, Volume 46, Number 49, 2013, Pages 494008
- [24] J. Fuchs, C. Schweigert, C. Stigner – *Higher Genus Mapping Class Group Invariants from Factorizable Hopf Algebras* – Advances in Mathematics, Volume 250, 15 January 2014, Pages 285-319
- [25] A. Gainutdinov, I. Runkel – *The Non-Semisimple Verlinde Formula and Pseudo-Trace Functions* – [arXiv:1605.04448](https://arxiv.org/abs/1605.04448) [math.QA]
- [26] A. Gainutdinov, I. Runkel – *Projective Objects and the Modified Trace in Factorisable Finite Tensor Categories* – [arXiv:1703.00150](https://arxiv.org/abs/1703.00150) [math.QT]
- [27] A. Gainutdinov, A. Semikhatov, I. Tipunin, B. Feigin – *The Kazhdan-Lusztig Correspondence for the Representation Category of the Triplet W -Algebra in Logarithmic Conformal Field Theories* – Teoreticheskaya i Matematicheskaya Fizika, Volume 148, Number 3, September 2006, Pages 398-427 (Russian) – Theoretical and Mathematical Physics, Volume 148, Issue 3, September 2006, Pages 1210-1235 (English Translation)
- [28] N. Geer, J. Kujawa, B. Patureau-Mirand – *Generalized Trace and Modified Dimension Functions on Ribbon Categories* – Selecta Mathematica, Volume 17, Number 2, 2011, Pages 435-504
- [29] N. Geer, J. Kujawa, B. Patureau-Mirand – *Ambidextrous Objects and Trace Functions for Nonsemisimple Categories* – Proceedings of the American Mathematical Society, Volume 141, 2013, 2963-2978
- [30] N. Geer, B. Patureau-Mirand, V. Turaev – *Modified Quantum Dimensions and Renormalized Link Invariants* – Compositio Mathematica, Volume 145, Issue 1, January 2009, Pages 196-212
- [31] N. Geer, B. Patureau-Mirand, A. Virelizier – *Traces on Ideals in Pivotal Categories* – Quantum Topology, Volume 4, Issue 1, 2013, Pages 91-124
- [32] M. Hennings – *Invariants of Links and 3-Manifolds Obtained from Hopf Algebras* – Journal of the London Mathematical Society, Volume 54, Issue 3, 1996, Pages 594-624.
- [33] L. Kauffman, D. Radford – *A Necessary and Sufficient Condition for a Finite-Dimensional Drinfel'd Double to Be a Ribbon Hopf Algebra* – Journal of Algebra, Volume 159, Issue 1, 1 August 1993, Pages 98-114
- [34] L. Kauffman, D. Radford – *Invariants of 3-Manifolds Derived from Finite-Dimensional Hopf Algebras* – Journal of Knot Theory and Its Ramifications, Volume 4, Issue 1, March 1995, Pages 131-162
- [35] T. Kerler – *Mapping Class Group Actions on Quantum Doubles* – Communications in Mathematical Physics, March 1995, Volume 168, Issue 2, Pages 353-388

- [36] T. Kerler – *Genealogy of Nonperturbative Quantum-Invariants of 3-Manifolds: The Surgical Family* – Geometry and Physics, Lecture Notes in Pure and Applied Mathematics, Volume 184, Marcel Dekker, 1996, Pages 503-547
- [37] T. Kerler – *On The Connectivity of Cobordisms and Half-Projective TQFT's* – Communications in Mathematical Physics, Volume 198, Issue 3, November 1998, Pages 535-590
- [38] T. Kerler – *Homology TQFT's and the Alexander-Reidemeister Invariant of 3-Manifolds via Hopf Algebras and Skein Theory* – Canadian Journal of Mathematics, Volume 55, Issue 4, 2003, Pages 766-821
- [39] T. Kerler, V. Lyubashenko – *Non-Semisimple Topological Quantum Field Theories for 3-Manifolds with Corners* – Berlin, Heidelberg: Springer-Verlag, Lecture Notes in Mathematics, Volume 1765, 2001
- [40] A. Klimyk, K. Schmüdgen – *Quantum Groups and Their Representations* – Springer-Verlag Berlin Heidelberg, 1997
- [41] S. Lentner, D. Nett – *New R-Matrices for Small Quantum Groups* – Algebras and Representation Theory, Volume 18, Issue 6, December 2015, Pages 1649-1673
- [42] S. Lentner, T. Ohrmann – *Factorizable R-Matrices for Small Quantum Groups* – SIGMA, Volume 13, Number 076, 2017, Pages 1-25
- [43] G. Lusztig – *Quantum Groups at Roots of 1* – Geometriae Dedicata, Volume 35, Issue 1-3, September 1990, Pages 89-113
- [44] V. Lyubashenko – *Modular Transformations for Tensor Categories* – Journal of Pure and Applied Algebra, Volume 98, Issue 3, 10 February 1995, Pages 279-327
- [45] V. Lyubashenko – *Invariants of 3-Manifolds and Projective Representations of Mapping Class Groups via Quantum Groups at Roots of Unity* – Communications in Mathematical Physics, Volume 172, Issue 3, September 1995, Pages 467-516
- [46] V. Lyubashenko, S. Majid – *Braided Groups and Quantum Fourier Transform* – Journal of Algebra, Volume 166, Issue 3, 15 June 1994, Pages 506-528
- [47] S. Montgomery – *Hopf Algebras and Their Actions on Rings* – CBMS Regional Conference Series in Mathematics, Volume 82, 1993
- [48] J. Murakami – *From Colored Jones Invariants to Logarithmic Invariants* – [arXiv:1406.1287](https://arxiv.org/abs/1406.1287) [math.GT]
- [49] J. Murakami – *Generalized Kashaev Invariants for Knots in Three Manifolds* – Quantum Topology, Volume 8, Issue 1, 2017, Pages 35-73
- [50] S. Majid – *Foundations of Quantum Group Theory* – Cambridge University Press, 1995
- [51] S. Majid – *Quasitriangular Hopf Algebras and Yang-Baxter Equations* – International Journal of Modern Physics A, Particles and Fields, Gravitation, Cosmology, Volume 5, Issue 1, 10 January 1990, Pages 1-91
- [52] C. Negron – *Small Quantum Groups Associated to Belavin-Drinfeld Triples* – [arXiv:1701.00283](https://arxiv.org/abs/1701.00283) [math.RT]
- [53] T. Ohtsuki – *Invariants of 3-Manifolds Derived from Universal Invariants of Framed Links* – Mathematical Proceedings of the Cambridge Philosophical Society, Volume 117, Issue 2, March 1995, Pages 259-273
- [54] D. Radford – *Hopf Algebras* – Series on Knots and Everything, Volume 49, World Scientific, December 2011
- [55] D. Radford – *The Antipode of a Finite-Dimensional Hopf Algebra over a Field Has Finite Order* – Bulletin of the American Mathematical Society, Volume 81, Number 6, 1975, Pages 1103-1105
- [56] D. Radford – *Minimal Quasitriangular Hopf Algebras* – Journal of Algebra, Volume 157, Issue 2, 1 June 1993, Pages 285-315
- [57] N. Reshetikhin, M. Semenov-Tian-Shansky – *Quantum R-Matrices and Factorization Problems* – Journal of Geometry and Physics, Volume 5, Issue 4, p. 533-550
- [58] N. Reshetikhin, V. Turaev – *Invariants of 3-Manifolds via Link Polynomials and Quantum Groups* – Inventiones Mathematicae, Volume 103, Issue 1, 1991, Pages 547-597
- [59] M. Rosso – *Finite Dimensional Representations of the Quantum Analog of the Enveloping Algebra of a Complex Simple Lie Algebra* – Communications in Mathematical Physics, Volume 117, Issue 4, December 1988, Pages 581-593
- [60] M. Rosso – *Quantum Groups and Quantum Shuffles* – Inventiones Mathematicae, Volume 133, Issue 2, July 1998, Pages 399-416

- [61] M. Sweedler – *Hopf Algebras* – Benjamin, New York, 1969
- [62] M. Sweedler – *Integrals for Hopf Algebras* – Annals of Mathematics, Second Series, Volume 89, Number 2, March 1969, Pages 323-335
- [63] V. Turaev – *Quantum Invariants of Knots and 3-Manifolds* – Berlin, Boston: De Gruyter, 1994
- [64] A. Virelizier – *Kirby Elements and Quantum Invariants* – Proceedings of the London Mathematical Society, Volume 93, Issue 2, September 2006, Pages 474-514

UNIVERSITÉ PARIS DIDEROT – PARIS 7, SORBONNE PARIS CITÉ, IMJ-PRG, UMR 7586
CNRS, F-75013 PARIS, FRANCE

E-mail address: `marco.de-renzi@imj-prg.fr`

MATHEMATICS & STATISTICS, UTAH STATE UNIVERSITY, LOGAN, UTAH 84322, USA

E-mail address: `nathan.geer@gmail.com`

UNIV. BRETAGNE - SUD, UMR 6205, LMBA, F-56000 VANNES, FRANCE

E-mail address: `bertrand.patureau@univ-ubs.fr`