

A very Practical Guide to Light Front Holographic QCD

Liping Zou and H.G. Dosch ¹

Institute of Modern Physics, Chinese Academy of Sciences
Lanzhou

The aim of these lectures is to convey a working knowledge of Light Front Holographic QCD and Supersymmetric Light Front Holographic QCD. We first give an overview of holographic QCD in general and then concentrate on the application of the holographic methods on QCD quantized in the light front form. We show how the implementation of the supersymmetric algebra fixes the interaction and how one can obtain hadron mass spectra with the minimal number of parameters. We also treat propagators and compare the holographic approach with other non-perturbative methods. In the last chapter we describe the application of Light Front Holographic QCD to electromagnetic form factors.

arXiv:1801.00607v1 [hep-ph] 2 Jan 2018

¹permanent address: Institut f. Theoretische Physik der Universität Heidelberg, Germany.

Contents

1	Introduction	4
1.1	Preliminary Remarks	4
1.2	Old string theory in strong interactions	6
1.3	AdS/CFT	9
2	Some mathematical preparations	12
2.1	The general claim	12
2.2	Metric in 5-dimensional Anti-de-Sitter space.	13
2.2.1	Euclidean Metric	13
2.2.2	Non-Euclidean metric: Anti-de-Sitter space	13
2.3	Relation between AdS and CFT parameters	15
2.4	Gauge Theory in the limit $N_c \rightarrow \infty$	16
3	The AdS action and wave equations for a (pseudo-)scalar and a vector field	18
3.1	The (pseudo-)scalar field	18
3.1.1	Euclidean metric	18
3.1.2	AdS ₅ metric	19
3.1.3	Solution and transformation of the equation of motion	21
3.2	Modifications of the action: The hard- and soft-wall model	21
3.2.1	The hard wall model [16, 17]	21
3.2.2	The soft wall model [18]	23
3.3	Vector Field	24
4	Light front holographic QCD	27

4.1	Wave functions in light front (LF) quantization	27
4.2	Bound state equations for mesons with arbitrary spin	30
4.3	Light Front Holographic QCD (LFHQCD)	31
4.4	Bound state equations for baryons with arbitrary spin	33
4.5	Inclusion of small quark masses	36
4.6	Summary	39
5	Supersymmetric light front holographic QCD	40
5.1	Constraints from conformal algebra	41
5.2	Constraints from superconformal (graded) algebra	43
5.2.1	Supersymmetric QM	43
5.2.2	Superconformal quantum mechanics	44
5.2.3	Consequences of the superconformal algebra for dynamics	45
5.2.4	Spin terms and small quark masses	47
5.2.5	Comparison with experiment	47
5.2.6	Completing the supersymmetric multiplet - Tetraquarks	50
5.3	Implications of supersymmetry on Hadrons containing heavy quarks	52
5.3.1	The experimental situation	52
5.3.2	Linear trajectories	55
5.3.3	Consequences of heavy quark symmetry (HQS)	60
5.4	Extension to two heavy quarks	60
5.4.1	Completing the supermultiplet in the heavy hadron sector	61
5.5	Summary	63
6	The propagator from AdS	64
6.1	The two point function in Holographic QCD	64
6.1.1	The generating functional	64
6.1.2	The classical action	65
6.2	Soft wall model	67
6.2.1	Solutions for soft wall model	67
6.2.2	The propagator for the conserved current in the holographic soft wall model	69

6.2.3	Physical relevance of conserved current	70
6.2.4	Propagators for other currents in LFHQCD	71
6.2.5	Asymptotic expansion of the two-point function. Comparison with QCD sum rules.	72
6.2.6	The propagator in the hard wall model	74
6.3	Summary	75
7	Form factors in AdS	76
7.1	Form factors	76
7.2	Form factor in HQCD and LFHQCD for a (pseudo-)scalar particle	77
7.2.1	The “dressed” electromagnetic field in AdS/CFT	77
7.2.2	The scaling twist	79
7.2.3	General results	80
7.2.4	Final assumptions and results for the form factor	80
7.2.5	Comparison of π form factor with experiment	81
7.2.6	The form factor in the parton model, effective wave functions	83
7.3	Nucleon Form Factors	84
7.3.1	Form factors for spin $\frac{1}{2}$ fields in AdS/CFT	84
7.3.2	A Simple Light-Front Holographic Model for Nucleon Form Factors	85
7.4	Summary	89
A	Collection of wave functions	91
A.1	Mesons	91
A.2	Baryons	92
A.3	Currents	92

Chapter 1

Introduction

1.1 Preliminary Remarks

Light Front Holograph QCD [1, 2] is a model theory, which tries to explain non-perturbative features of the quantum field theory for strong interactions, QCD. Like in all realistic quantum field theories, also in QCD perturbation theory is the only analytical method to obtain rigorous numerical results. Unfortunately the most interesting questions in particle physics, like the calculation of hadron masses, cannot be solved by perturbation theory. The only rigorous method to do that are very elaborate numerical calculations with supercomputers. These calculations are performed in Euclidean space-time and the continuum is approximated by a lattice, a set of discrete points and links between.

In order to get some insight into the structure of the most interesting phenomena, one has to make specific models and approximations. An especially important approach is the semiclassical approximation of a quantum field theory. Here the complicated structure of the interaction, which notably involves virtual particle creation and annihilation (loops), is approximated by a potential in a Schrödinger-like quantum mechanical equation. All the results on the structure of atoms and molecules, which follow in principle from quantum electrodynamics (QED), are not obtained by calculating complicated Feynman diagrams, but by solving the Schrödinger or Dirac equation with the electromagnetic potentials. This does not mean that quantum field theory is obsolete, since firstly it is used to derive the potentials in the Schrödinger equation (in the simplest case by one photon exchange), secondly important constraints on the solutions, like those of the Pauli principle, can only be derived from quantum field theory and finally, quantum field theory is used to improve the semiclassical results, as is done for instance by the calculation of the Lamb shift in QED.

Light front holographic QCD allows to obtain a semiclassical approximation to QCD. Since the quarks which constitute ordinary matter are very light, their mass is only a few MeV, the kinematics is ultra-relativistic. In that case the so called Light Front Quantization is the easiest way to obtain a semiclassical approximation. In it this form of quantization the

commutators of the quantum fields are not defined at equal (ordinary) time, but at equal “light front time”, which is the sum of the ordinary time and one of the space coordinates.

The basis of light front holographic QCD is the “holographic principle”. It states that certain aspects of a quantum field theory in four space-time dimensions can be obtained as limiting values of a five dimensional theory¹. In our case the basis is the Maldacena conjecture [3], which states the equivalence of a **five dimensional classical** theory with a **four dimensional quantum field** theory. The five dimensional classical theory has a non-Euclidean geometry (the so called Anti-de-Sitter metric), the four dimensional quantum field theory is a quantum gauge theory, like QCD, but it has not $N_c = 3$ colours, but $N_c \rightarrow \infty$, it has conformal symmetry (that is it has no scale) and furthermore it is supersymmetric, that is to each fermion field there exist also bosonic fields with properties governed by a “supersymmetry”. Unfortunately this “superconformal” quantum gauge theory² with infinitely many colours is rather remote from QCD. Therefore in Light Front Holographic QCD (LFHQCD) one chooses a “bottom-up” approach, that is one modifies the five dimensional classical theory in such a way as to obtain from this modified theory and the holographic principle realistic features of hadron physics. This reduces the power to explain structural features of hadron physics, since just this observed structures are used as input to determine the modifications of the classical 5-dimensional theory. This shortcoming is removed in supersymmetric light front holographic QCD (SuSyLFHQCD), which forms the the main subject of these lectures. Here the implementation [4] of superconformal symmetry on the semiclassical theory fixes the necessary modifications completely. In this SuSyLFHQCD the number of parameters is just the one dictated by QCD itself (like in lattice QCD). In the limit of massless quarks one has the universal scale (fixed for instance by one hadron mass), and for massive quarks one has also the quark masses as parameters. It should be noted that the underlying supersymmetry is a symmetry between wave functions of observed mesons and observed baryons and not a supersymmetry of fields. Therefore no new particles like “squarks” or “gluinos” have to be introduced.

The derivation of semiclassical equations for hadron physics is certainly a big achievement of the holographic principle, but not the only one. The correspondence allows in principle to determine all matrix elements of the quantum field theory by the classical solution of the five-dimensional theory. Therefore one can also calculate form factors in LFHQCD [5, 6].

A limitation on the accuracy of the numerical results is the limit of infinitely many colours. This limit is well studied in the framework of conventional QCD [7] and leads typically to errors of the order of 10% of the hadronic scale or around 100 MeV.

Since the aim of this notes is to convey a practical working knowledge as fast as possible, this necessitates many omissions of more subtle points. Also the quoted literature is mostly confined to subjects directly related to the material, which is explicitly treated in these notes,

¹The name is derived from “hologram” which is a two dimensional picture which contains the information of a three dimensional object

²The name AdS/CFT correspondence, frequently used for this holographic approach, comes from the **Anti-de-Sitter** metric and the **Conformal Field Theory**.

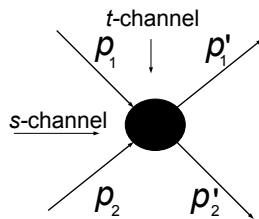

Figure 1.1: Elastic scattering amplitude.

but the quoted literature allows easily to find more sources and to expand the knowledge.

1.2 Old string theory in strong interactions

Before QCD emerged as a consistent theory based on quark and gluon fields in the early 1970ies, there was another approach to strong interaction physics, which did not search for elementary particles at all. The basis of this approach was **duality**. For an elastic scattering amplitude $T(s, t)$, Fig. 1.1, which depends on the total energy $s = (p_1 + p_2)^2 = (p'_1 + p'_2)^2$ and the momentum transfer $t = (p'_1 - p_1)^2 = (p'_2 - p_2)^2$, we have two salient features:

1) For low values of s we observe resonances, for instance in $N - \pi$ scattering the Δ and higher resonances. This means that there are poles in the variable s at the resonance masses. The amplitude $T(s, t)$ behaves near the resonance as

$$T(s, t) \sim \frac{A}{s - m_R^2}$$

For unstable resonances m_R has an imaginary part.

2) For high values of s we have Regge behaviour, that is in that limit the amplitude behaves like

$$T(s, t) \sim s^{\alpha(t)},$$

the function $\alpha(t)$ is called a Regge trajectory.

This gives a good description of high energy scattering, that is for large values of s and for negative values of t . For positive values of t , which can occur in annihilation, a resonance pole with total angular momentum J occurs at those values of t , where $\alpha(t)$ is a nonnegative integer J . It turned out that linear trajectories, that is

$$\alpha(t) = \alpha_0 + \alpha' \cdot t \tag{1.1}$$

give a good description of the data. α_0 is called the intercept and α' the slope of the trajectory. The concept of duality was developed as an attempt to unify these two seemingly very different features.

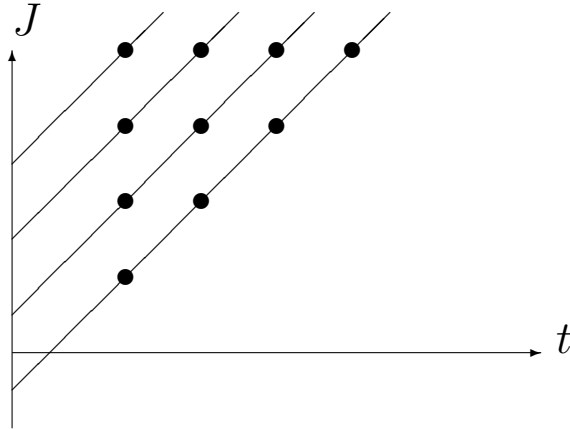

Figure 1.2: Trajectories in the Veneziano model.

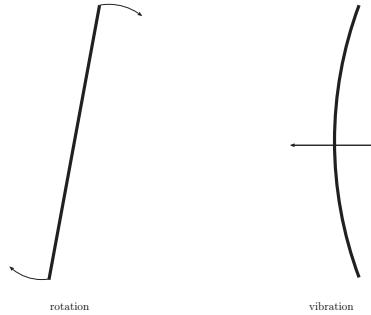

Figure 1.3: Rotational and vibrational modes of a string.

An important model for scattering amplitudes which shows this dual behaviour is the **Veneziano model** $V(s, t)$ [8]. It consists of a sum of expressions like

$$T(s, t) = \frac{\Gamma(1 - \alpha(s))\Gamma(1 - \alpha(t))}{\Gamma(2 - \alpha(s) - \alpha(t))} = \frac{\Gamma(1 - \alpha_0 - \alpha's)\Gamma(1 - \alpha_0 - \alpha't)}{\Gamma(2 - \alpha_0 - \alpha's - \alpha_0 - \alpha't)} \quad (1.2)$$

with the linear trajectory $\alpha(x) = \alpha_0 + \alpha'x$. $\Gamma(z)$ is the Euler Gamma function which for integer values is the factorial, $\Gamma(z + 1) = z!$. From the properties of the Γ function follows: for large values of s and negative values of t the amplitude $T(s, t)$ shows Regge behaviour, and it has resonance poles for integer values of $\alpha(s)$ or $\alpha(t)$. These poles lie on straight lines, the lowest one is called the Regge trajectory, the ones above it are called daughter trajectories, see Fig. 1.2.

It was soon realized, that the Veneziano model corresponds to a string theory, where the rotation of the string gives the resonances along the Regge trajectories and the vibrational modes yield the daughter trajectories, see figure 1.3.

In this approach the hadrons are not point-like objects nor composed of point-like objects (elementary quantum fields), but they are inherently extended objects: strings.

One important result of the classical relativistic string is that the angular momentum is proportional to the squared mass of the string, $J \sim m^2$; this is just the Regge behaviour. The Veneziano model corresponds to a classical string theory, quantum corrections to it are shown in figure 1.4.

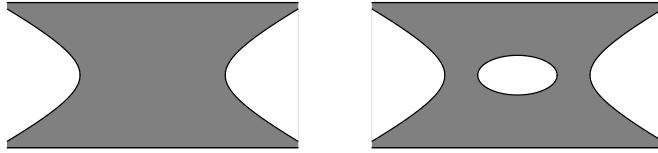

Figure 1.4: Veneziano model(left) and quantum corrections(right) in string theory.

Big hopes were put in the Veneziano model and its development, but soon it turned out that it was not the most adequate theory for strong interactions. Beyond internal difficulties one reason was that Quantum Chromodynamics (QCD) came out as a strong competitor and now this field theory is generally considered as the correct theory of strong interactions. String theory however developed in a completely different direction and it is nowadays considered as the best candidate for a quantum theory of everything (TOE), that is of all interactions, including gravity. But string theory in strong interaction physics was never completely dead. The reason is that many aspects of non-perturbative QCD seem to indicate that hadrons have indeed stringlike features. The most popular model for confinement, the t’Hooft-Mandelstam model (see figure 1.5) is based on the assumption that the colour-electric force lines are compressed (by monopole condensation) into a flux tube which behaves in some respect indeed like a string.

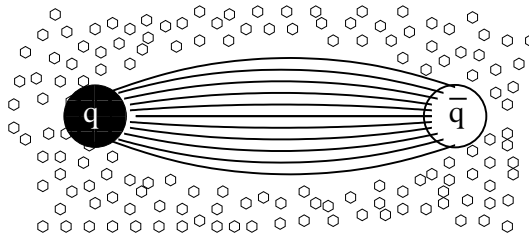

Figure 1.5: Formation of a colour electric flux tube .

Also the particular role of quarks as confined particles shows some analogy with a string picture. If you split a hadron, you do not obtain quarks, but again hadrons. In a similar way, if you cut a string you do not obtain two ends, but two strings again. We shall see in the next subsection, that string theory plays, at least indirectly again a role in strong interaction physics through the holographic approach.

1.3 AdS/CFT

String theory became very esoteric. Firstly for consistency reasons the basic theory had to be supersymmetric, and secondly the theory had to be formulated in a space-time with much more dimensions than 4. The only reason that it was pursued further, apart from the purely mathematical interest, was that restricted to 4 dimensions it yielded a gauge quantum field theory, that is a quantum field theory like QCD.

Supersymmetry is a symmetry which relates particles with different spin. There exists a theorem of Coleman and Mandula which says that such a symmetry is impossible. The only way out is to extend the concept of symmetry, which is generated by an algebra of commuting generators, to a supersymmetry which is generated by commuting and anticommuting operators. To each particle with integer spin there must be also particles with half integer spin. Unfortunately the fields of the observed particles with different spin cannot be related by supersymmetry (susy). A big hope of LHC was to find supersymmetric partners of existing particles, but it was not realized up to now. In our approach supersymmetry plays an important role, but not as a symmetry of quantum fields, but of wave functions.

In the case of **higher dimensions** all the dimensions except those of space-time are supposed to be “rolled up” that they cannot be observed with present day technology, and most probably with the technology of the next centuries. Some years ago there was hope that some of the dimensions, only to be perceived by gravity, might be macroscopic (for instance 10^{-6} m). But this hope did not realize.

The present renewed interest of phenomenologically oriented physicists in this seemingly esoteric field came through another esoteric principle, the holographic principle: One can sometimes obtain results of a theory in a space of d dimensions easier, if one considers it as a limit of a problem in a space of higher dimension. This principle was first applied to the thermodynamics of black holes. The application to strong interactions goes back to a conjecture made by Maldacena, later elaborated by Gubser Klebanov and Polyakov, and Witten 1998[3, 9, 10]^{3 4}. It states that a certain string theory is equivalent to a certain Yang-Mills theory. Many people tried to bring this mathematically high-brow theory down to earth and try to learn from string theory some aspects of nonperturbative QCD.

The basis for the application of the holographic principle to solve quantum field theories is the following. There are good reasons to believe, that a certain superstring (Type II B) theory in ten dimensions is dual to a highly supersymmetric (N=4) gauge theory (Maldacena conjecture). Duality here means, that the classical solutions of the 5-dimensional gravitational theory⁵ determine the properties of the confined objects in the 4-dimensional

³A more recent short review is [11], a very complete description can be found in the book of Ammon and Erdmenger [12], for non-specialists see e.g. [13] and the very short article [14].

⁴The seminal paper by Maldacena received 13233 citations until end of 2017, that is the record for a theoretical paper.

⁵ A gravitational theory is a theory where the interaction is due to the (non-Euclidean) metric, like the

field theory. This sounds very promising. The five dimensional gravitational theory is rather simple, it is based on the metric of a 5-dimensional space, the so called Anti-de-Sitter space, AdS_5 . The dual quantum field theory is very far from QCD. It is a gauge quantum field theory, but it is a conformal theory that contains no mass scale and therefore cannot give rise to hadrons with finite masses. Furthermore it is supersymmetric and has an infinite number of colours.

The relation between the two very different theories comes over the so called D-branes. A D-brane is a hyper-surface on which open strings end. Since energy and momentum flows from the string to the D-branes they are also dynamical objects. The D stands by the way for Dirichlet, since the Dirichlet boundary conditions on the D-brane are essential for string dynamics. In the mentioned case the D3-branes have 3 space and one time direction and they are boundaries of a 5 dimensional space with maximal symmetry (we shall come to this back in detail). In figure 1.6 a D1-branes (1 space, 1 time dimension) are shown, at which an open string ends (picture at a fixed time).

There are two very different approaches to apply the holographic principle to a more realistic situation:

- The top-down approach: One looks for a superstring theory which has as limit on a D3 brane realistic QCD or at least a similar theory. This approach is very difficult and has to our knowledge not yet led to phenomenologically very useful results.
- The bottom-up approach: One starts with QCD, or at least a theory near QCD, and tries to construct at least an approximate string theory which one can solve and obtain nonperturbative results for QCD.

Needless to say that we follow here the bottom-up approach.

The procedure we adopt will be the following: We construct operators in AdS_5 which correspond to **local** QCD operators, e.g. a vector field $\bar{\psi}(x)\gamma_M\psi(x)$, and study the behaviour of this operator in the 5 dimensional space (the so called bulk), and hope to get information on the properties of confined objects.

gravitation in our 4-dimensional world can be derived from the metric.

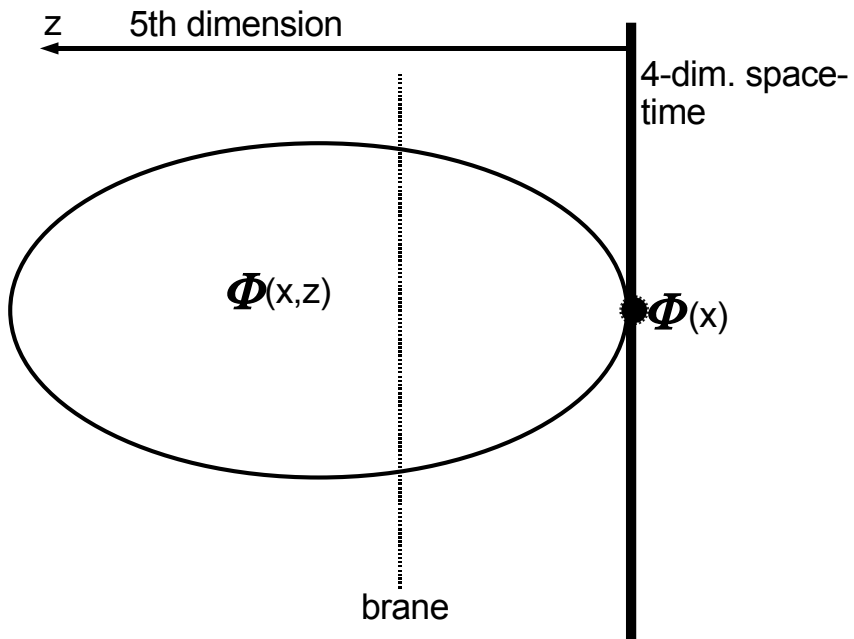

Figure 1.6: A local QCD operator extended in the AdS_5 (bulk).

Chapter 2

Some mathematical preparations

2.1 The general claim

The AdS-CFT correspondence claims, that in a certain limit the essential results of a quantum field theory, like propagators, bound state poles etc, can be obtained from the classical solutions of the higher dimensional gravitational theory. This can be very concisely formulated in terms of the generating functionals. We shall come back to that in more detail in Chapt. 6 and give here only a short overview.

A generating functional $Z[j]$ contains all information on the observables of quantum field theory. For a free theory we have $Z[j] = e^{\int dx dy j(y)D(x-y)j(x)}$, where $D(x - y)$ is the free propagator.

The correspondence statement claims:

$$Z_{FT}[j] = iS_{AdS}[\Phi_{cl}] \Big|_{\Phi_{cl} \xrightarrow{z \rightarrow 0} j} \quad (2.1)$$

where Φ_{cl} is the solution of the classical equations of motion derived from the action in the AdS_5 .

We shall exploit that relation in chapter 6 in order to calculate propagators. But here we take a very practical attitude. We construct in AdS_5 the action for a field with the same quantum numbers as the one we want to investigate in the 4-dimensional quantum field theory. The classical equations of motion, the solutions of which minimize the action, are the bound state wave equations for the hadrons. But before we come to that, we have to make some preparatory steps.

2.2 Metric in 5-dimensional Anti-de-Sitter space.

2.2.1 Euclidean Metric

The line element in Minkowski metric, that is our usual relativistic space time continuum, is given by:

$$ds^2 = -(dx^1)^2 - (dx^2)^2 - (dx^3)^2 + (dx^4)^2 = \sum_{\mu\nu=1}^4 \eta_{\mu\nu} dx^\mu dx^\nu \quad (2.2)$$

$g_{\mu\nu}$ is called the metric tensor. In Minkowski space the metric tensor in Cartesian coordinates is particularly simple and given by:

$$\{\eta_{\mu\nu}\} = \begin{pmatrix} -1 & 0 & 0 & 0 \\ 0 & -1 & 0 & 0 \\ 0 & 0 & -1 & 0 \\ 0 & 0 & 0 & 1 \end{pmatrix} \quad (2.3)$$

Since $\{\eta^{\mu\nu}\}$ is not positive definite, it is called a pseudo-Euclidean metric tensor and geometry in Minkowski space is called pseudo-Euclidean.

The metric tensor in a Minkowski space with 3 space, 1 time variable and an additional spacelike 5th coordinate is

$$\{\eta_{MN}\} = \begin{pmatrix} -1 & 0 & 0 & 0 & 0 \\ 0 & -1 & 0 & 0 & 0 \\ 0 & 0 & -1 & 0 & 0 \\ 0 & 0 & 0 & 1 & 0 \\ 0 & 0 & 0 & 0 & -1 \end{pmatrix} \quad (2.4)$$

2.2.2 Non-Euclidean metric: Anti-de-Sitter space

In non-Euclidean geometry, the elements of the metric are no longer constants, but may differ from point to point. The line element of (2.2) therefore becomes:

$$(ds)^2 = \sum_{MN} g_{MN}(x) dx^M dx^N \quad (2.5)$$

where g_{MN} is a symmetric matrix function, $g_{MN}(x) = g_{NM}(x)$.

The metric tensor in AdS₅ is ¹ :

$$g_{MN} = \frac{R^2}{z^2} \begin{pmatrix} -1 & 0 & 0 & 0 & 0 \\ 0 & -1 & 0 & 0 & 0 \\ 0 & 0 & -1 & 0 & 0 \\ 0 & 0 & 0 & 1 & 0 \\ 0 & 0 & 0 & 0 & -1 \end{pmatrix} = \frac{R^2}{z^2} \eta_{MN} \quad (2.6)$$

¹The specific form of the metric depends naturally on the choice of coordinates. In AdS₅ we always choose the so called Poincaré coordinates

Here $z = x_5$ is the fifth variable, normally called the holographic variable, R is a measure for the curvature of the space.

The modulus of the determinant of the metric tensor is accordingly:

$$|g| = \left(\frac{R^2}{z^2}\right)^5 \quad (2.7)$$

The inverse metric tensor is given by upper indices:

$$\{g_{MN}\}^{-1} \equiv g^{MN} \quad (2.8)$$

that is $\sum_{N=1}^5 g_{MN} g^{NA} = \delta_M^A$, in Euclidean metric one has $\eta_{MN} = \eta^{MN}$.

In the future we will use the Einstein convention: over upper and lower indices with equal name will be summed, that is e.g.

$$g_{MN} g^{NA} \equiv \sum_{N=1}^5 g_{MN} g^{NA}. \quad (2.9)$$

One calls lower indices covariant indices and upper indices contravariant indices. With the metric tensor and its inverse one can transform a covariant into a contravariant index and vice versa: $a^M = g^{MN} a_N$, $a_M = g_{MN} a^N$.

With the help of the metric tensor we can construct easily invariants from covariant and contravariant quantities. If a_M and b_M are covariant vectors in AdS, then the product $g^{MN} a_M b_N$ is an invariant, like the 4-product of two Lorentz vectors in Minkowski space, $\eta^{\mu\nu} a_\mu b_\nu$, is an invariant.

The invariant volume element in AdS₅ is the Euclidean volume element $d^4x dz$ multiplied by the square root of the modulus of the determinant of g_{MN} . For the metric tensor (2.6) the determinant is the product of the diagonal elements and hence we obtain as invariant volume element of AdS₅:

$$dV = d^4x dz \sqrt{|g|} = d^4x dz \left(\frac{R}{z}\right)^5 \quad (2.10)$$

where we have inserted the modulus of the determinant of g^{MN} with the relation (2.7).

Since in the following we shall always jump between the 4-dimensional Minkowski space and the 5-dimensional space AdS₅ we will introduce the following conventions:

The Greek indices, $\mu, \nu, \alpha \dots$ run from 1 to 4, where $x^4 = ct$ is the timelike variable. In the 5-dimensional space, we shall use capital Latin letter, $M, N, A \dots$ which run from 1 to 5, and $x^5 = z$.

2.3 Relation between AdS and CFT parameters

Before coming to the relation, we have to introduce the Planck units. They are named, since Plank was the first to look for natural units, which are independent of human standards (like meter, second etc) and he realized that with his constant \hbar he could achieve it.

In conventional units we have three dimensionful quantities: mass $[m]$, time $[t]$, and length $[l]$. We have as fundamental constants the velocity of light c , Planck's constant \hbar , and Newton's constant of gravity G_N . The natural unit for the velocity is certainly the velocity of light c , the natural unit of Energy is $[m]c^2$, for the action $[E][t]$ the natural unit is \hbar . Therefore we can reduce the three dimensions to only one, e.g. the length. We have $[t] = [l]/c$; $[m] = \frac{\hbar}{c[l]}$. The gravitational constant is defined in Newton's law: $F = \frac{m_1 m_2}{r^2} G_N$. With that we can obtain as natural unit for the remaining dimension, the length, the Planck length:

$$l_P = \sqrt{\frac{\hbar}{c^3} G_n} \approx 1.6 \times 10^{-33} \text{cm} \quad (2.11)$$

The natural unit for the mass and the time are the Planck mass m_P and the Planck time t_P :

$$m_P = \sqrt{\frac{\hbar c}{G_N}} \approx 1.2 \times 10^{14} \text{GeV}/c^2 \approx 2.2 \times 10^{-5} \text{g} \quad (2.12)$$

$$t_P = \frac{l_P}{c} \approx 5.4 \times 10^{-44} \text{s} \quad (2.13)$$

From string theory one deduces the following relation between the AdS₅ and CFT quantities:

$$\left\{ \frac{l_P}{R} \right\}_{AdS} = \left\{ \frac{\sqrt{\pi}}{2^{1/8} N_c^{1/4}} \approx \frac{1.6}{N_c^{1/4}} \right\}_{CFT} \quad (2.14)$$

In a gravitational theory quantum effects can be neglected if $l_P \ll R$. In our universe, where the curvature radius is infinity or very large and the Planck length is tiny, quantum effects are completely negligible. But in the very early universe, say one Planck time t_P after the big bang, quantum gravity must have played a crucial role, therefore we cannot say anything about the big bang properly.

But back to AdS, in order to treat gravity in AdS as a classical theory, the number of colours must be huge ($> 10^4$), so the application in our world, where the gauge theory QCD has three colours, $N_C = 3$, seems to be hopeless. But fortunately gauge theories with $N_C \rightarrow \infty$ are well studied and might give results not so far from $N = 3$, typical deviations may be $1/N_c^2 \approx 0.11$. We come to this important point in the next subsection.

2.4 Gauge Theory in the limit $N_c \rightarrow \infty$

We consider the t' Hooft limit [7] of a gauge theory with N_c colours, for a review see [15]:

$$\lim_{N_c \rightarrow \infty} g_s^2 N_c = \text{constant}. \quad (2.15)$$

In Fig 2.4 we consider a two gluon contribution to a hadron propagator. The thick line stands for a hadron, the thin line for a (anti-)quark and the wavy line for a gluon. The summation over all colours amounts to the following. Since in a gauge theory with N_c colours a colour-neutral meson consists of N_c quark-antiquark pairs, insert for each hadron-quark vertex the normalization factor $\frac{1}{N_c}$. For colour summation, each gluon line can in the large N_c limit be replaced by a quark-antiquark double line. Colour summation gives for each loop a factor N_c . This yields for the graph a) the representation b) and the colour summation factor:

$$\frac{1}{N_c} N_c^3 g_s^4 = (N_c g_s^2)^2 \quad (2.16)$$

which survives in the large N_c limit. In graph c) the gluon lines cross (aplanar diagram) and the representation is d). Here we have only 2 loops, and therefore this diagram contributes like

$$\frac{1}{N_c} N_c^2 g_s^4 = \frac{(N_c g_s^2)^2}{N_c} \rightarrow 0 \quad (2.17)$$

and does not contribute in the large N_c limit. Generally one can show that all planar diagrams survive in the large N_c limit, all aplanar ones do not. In Fig. 2.4 e) we give the first order contribution to a decay of a hadron into two hadrons. The two-line representation is given in f) and yields the colour factor:

$$\frac{1}{N_c^{3/2}} N_c^2 g_s^2 = \frac{N_c g_s^2}{\sqrt{N_c}} \rightarrow 0 \quad (2.18)$$

and hence does not contribute in the large N_c limit. This is true for any order and hence we obtain the important result that in the $N_c \rightarrow \infty$ limit all hadrons are stable.

One can also show easily that all interactions between hadrons (colourless objects) vanish in the limit $N_c \rightarrow \infty$, that is in this limit only the confining forces survive. Therefore we can hope to get realistic results for spectra and form factors, but cannot try to calculate scattering cross sections.

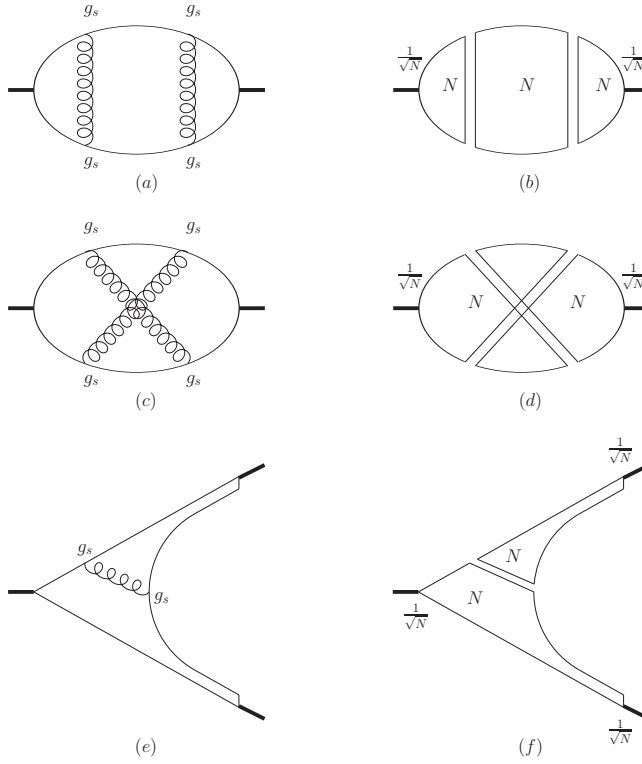

Figure 2.1: Evaluation of the colour factor for several diagrams. In the diagrams (a) and (c) we have a factor g_s^4 from gluon exchange. According to (b), where gluon lines have been replaced by double lines of quarks, we have 3 loops and hence a factor N_c^3 . Together with the normalization factors this yields the overall colour expression $\frac{1}{N_c} N_c^3 g_s^4$ which is finite in the t'Hooft limit (2.15). For the aplanar diagram (c) we have only two loops, see (d) and therefore the contribution vanishes in the $N_c \rightarrow \infty$ limit. In the decay diagram (e) we have g_s^2 , two loops and three vertices. This yields the overall factor $\frac{1}{N_c^{3/2}} N_c^2 g_s^2$ which vanishes in the t'Hooft limit.

Chapter 3

The AdS action and wave equations for a (pseudo-)scalar and a vector field

3.1 The (pseudo-)scalar field

3.1.1 Euclidean metric

As mentioned, we can derive all the properties of the 4-dimensional quantum field theory from the solutions of the classical action of the higher dimensional theory with a non-Euclidean metric. Therefore we construct now the AdS action for a (pseudo-)scalar field $\Phi(x) = \Phi(\vec{x}, ct, z)$.

We start with a more familiar case, the action of a free scalar field in Minkowski space. It is given by the integral over the Lagrangian \mathcal{L} :

$$A = \int d^4x \underbrace{\frac{1}{2}(\eta^{\nu\rho} \partial_\nu \Phi \partial_\rho \Phi - \mu^2 \Phi^2)}_{\mathcal{L}} \quad (3.1)$$

The solutions of the classical equations of motion are the functions $\Phi(x)$ for which the action is minimal. From this follows that the equations of motion for classical fields are the Euler-Lagrange equations:

$$\partial_\nu \frac{\partial \mathcal{L}}{\partial(\partial_\nu \Phi)} - \frac{\partial \mathcal{L}}{\partial \Phi} = 0. \quad (3.2)$$

This leads to the wave equation for a free (pseudo-)scalar field, called the Klein-Gordon equation:

$$\eta^{\nu\rho} \partial_\nu \partial_\rho \Phi + \mu^2 \Phi = 0. \quad (3.3)$$

3.1.2 AdS₅ metric

If we go from Euclidean metric to the non-Euclidean AdS₅ metric we have in the action (3.1) to replace:

- $\eta^{\mu\nu} \rightarrow g^{MN}$
- $d^4x \rightarrow d^4x \sqrt{|g|} dz$, see (2.10)
- In principle we have also to replace the normal (Euclidean) derivative ∂_μ by the so called covariant derivative D_μ in AdS₅, but for a scalar field the covariant derivative is equal to the the normal one ¹

Instead of the action Euclidean (3.1) we obtain in AdS₅ geometry:

$$A = \int d^4x dz \underbrace{\sqrt{|g|} \frac{1}{2} (g^{MN} \partial_M \Phi \partial_N \Phi - \mu^2 \Phi^2)}_{\mathcal{L}} \quad (3.4)$$

and from (3.2) we obtain instead of the Euclidean equations of motion (3.3) the equations in non-Euclidean metric:

$$\partial_R \left(\sqrt{|g|} g^{RN} \partial_N \Phi \right) + \sqrt{|g|} \mu^2 \Phi = 0. \quad (3.5)$$

or

$$g^{RN} (\partial_R \partial_N \Phi) + \mu^2 \Phi = \frac{-1}{\sqrt{|g|}} \partial_R (\sqrt{|g|} g^{RN}) \partial_N \Phi \quad (3.6)$$

We see that the interaction in the non-Euclidean metric leads to an interaction term namely the r.h.s. of (3.6), this is due to the term $\partial_R (\sqrt{|g|} g^{RN}) \partial_N \Phi$. If the metric is Euclidean, the elements of the metric tensor are independent of the coordinates and the r.h.s of (3.6) vanishes in that case.

In AdS₅ we have, see sect. 2.2.2

$$\{g_{AB}\} = \frac{R^2}{z^2} \{\eta_{AB}\} \quad \{g_{AB}\}^{-1} = \{g^{AB}\} = \frac{z^2}{R^2} \{\eta^{AB}\} \quad |g| = \left(\frac{R^2}{z^2} \right)^5 \quad (3.7)$$

therefore the l.h.s. of (3.6) depends only on the holographic variable $x^5 = z$.

It is convenient for further calculations to write

$$\frac{R^2}{z^2} \equiv e^{2A(z)} \quad \text{with } A(z) = -\log z + \log R \quad (3.8)$$

¹ Since the displacement of a vector or a tensor in non-Euclidean geometry depends on the metric, this has also to be considered in the derivative. The covariant derivative D_M of a vector field $V_N(x)$ contains the so called Christoffel symbol Γ_{MN}^K : $D_M V_N(x) = \partial_M V_N - \Gamma_{MN}^K V_K$, the Christoffel symbol can be calculated from the metric tensor $g_{MN}(x)$, see e.g. [2], App. A.

Then we have

$$g_{MN} = e^{2A(z)}\eta_{MN}; \quad g^{MN} = e^{-2A(z)}\eta^{MN} \quad \sqrt{|g|} = e^{5A(z)} \quad (3.9)$$

and obtain

$$\mathcal{L} = \frac{1}{2}e^{5A(z)} \left(e^{-2A(z)}\eta^{MN} \partial_M \Phi \partial_N \Phi - \mu^2 \Phi^2 \right) \quad (3.10)$$

$$= \frac{1}{2}e^{\kappa A(z)} \left(\eta^{MN} \partial_M \Phi \partial_N \Phi - e^{2A(z)} \mu^2 \Phi^2 \right) \quad (3.11)$$

with $\kappa = 3$.

The ingredients of the Euler-Lagrange equations

$$\partial_A \frac{\partial \mathcal{L}}{\partial (\partial_A \Phi)} - \frac{\partial \mathcal{L}}{\partial \Phi} = 0 \quad (3.12)$$

are

$$\partial_A \frac{\partial \mathcal{L}}{\partial (\partial_A \Phi)} = \partial_A \left(e^{\kappa A(z)} \eta^{AB} \partial_B \Phi \right); \quad \frac{\partial \mathcal{L}}{\partial \Phi} = -\mu^2 \Phi e^{(\kappa+2)A(z)}; \quad \kappa = 3 \quad (3.13)$$

From that we obtain the wave equation for the (pseudo)scalar field in AdS₅:

$$e^{\kappa A(z)} \left(\eta^{\alpha\beta} \partial_\alpha \partial_\beta \Phi - \partial_z^2 \Phi - \kappa \partial_z A(z) \partial_z \Phi + \mu^2 e^{2A(z)} \Phi \right) = 0. \quad (3.14)$$

where according to the convention of sect. 2.2.2 the indices α, β run from 1 to 4 (Minkowski space).

For most cases it is convenient to work with the transformed field $\tilde{\Phi}(q, z)$ where the Minkowski coordinates of the field $\Phi(x, z)$ are Fourier transformed.

$$\Phi(x, z) = \int \frac{d^4 q}{(2\pi)^4} e^{iqx} \tilde{\Phi}(q, z) \quad (3.15)$$

Then we can replace

$$\eta^{\alpha\beta} \partial_\alpha \partial_\beta \Phi(x, z) \rightarrow -q^2 \tilde{\Phi}(q, z)$$

and obtain for $\tilde{\Phi}(q, z)$ the equation

$$\left(-\partial_z^2 - (\kappa \partial_z A(z)) \partial_z - q^2 + \frac{(\mu R)^2}{z^2} \right) \tilde{\Phi}(q, z) = 0 \quad (3.16)$$

inserting (3.8) we arrive finally at the wave equation

$$\left(-\partial_z^2 + \frac{\kappa}{z} \partial_z + \frac{(\mu R)^2}{z^2} - q^2 \right) \tilde{\Phi}(q, z) = 0 \quad (3.17)$$

with $\kappa = 3$.

3.1.3 Solution and transformation of the equation of motion

The general solution of the differential equation (3.17) can be obtained with the mathematica program:

$$\tilde{\Phi}(q, z) = (qz)^{(1+\kappa)/2} (A J_\nu(qz) + B Y_\nu(qz)) \text{ with } \nu = \sqrt{(\mu R)^2 + (\kappa + 1)^2/4} \quad (3.18)$$

Mathematica: "BesselJ[n, z] gives the Bessel function of the first kind $J(n, z)$.",
"BesselY[n, z] gives the Bessel function of the second kind $Y(n, z)$."

The general solution $\tilde{\Phi}(q, z)$ of (3.17) is therefore:

$$\tilde{\Phi}(q, z) = A z^2 J_\nu(qz) + B z^2 Y_\nu(qz) \text{ with } \nu^2 = (\mu R)^2 + 4 \quad (3.19)$$

In the next few chapters we shall only consider the solution which is regular at $z = 0$, that is we put $B = 0$. We can transform (3.17) also into a Schrödinger-like equation by rescaling, we introduce $\tilde{\Phi}_S(q, z)$:

$$\tilde{\Phi}(q, z) = z^{3/2} \tilde{\Phi}_S(q, z) \quad (3.20)$$

then the linear derivative in (3.17) vanishes and we obtain:

$$\left(-\partial_z^2 + \frac{(4\mu R)^2 + 15}{4z^2} \right) \tilde{\Phi}_S(q, z) = q^2 \tilde{\Phi}_S(q, z) \quad (3.21)$$

This looks like a Schrödinger equation with a potential; but this potential does not lead to the formation of bound states.

We note the disappointing fact, that there are indeed nontrivial solutions to the equation of motion (3.17) or (3.21), but there is no sign of confinement, since for any value of q^2 we find a solution. This is, however, not astonishing. The AdS₅ has what is called maximal symmetry and this results in conformal symmetry in the corresponding quantum field theory in the 4-dimensional Minkowski space. We shall come to conformal symmetry later, here it is sufficient to say that conformal symmetry demands, that there is no mass scale in the theory. This applies also for classical QCD in the limit of massless quarks, but not to the quantized QCD. Here we have indeed scales (e.g. the nucleon mass).

3.2 Modifications of the action: The hard- and soft-wall model

3.2.1 The hard wall model [16, 17]

A way to impose the existence of discrete solutions is the hard wall model. Here it is assumed, that the Lagrangian \mathcal{L} in 3.4 is only valid for values of $z \leq z_0$ (so to speak inside a hard

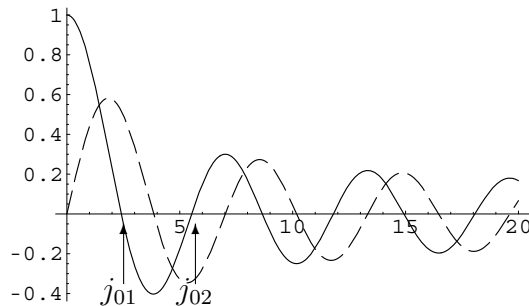

Figure 3.1: The Bessel functions $J_0(z)$ (solid) and $J_1(z)$ (dashed). The first and second zero of the Bessel function J_0 , which determine the mass of the ground state and the first excitation, are indicated.

Experiment	π 140MeV	π 1300 \pm 100MeV	π 1812 \pm 14MeV
$\nu = 0; z_0^{-1} = 207$ MeV	501	1140	1797

Table 3.1: Experimental and hard-wall masses of the pion resonances based on equation 3.17.

wall at position z_0), and one imposes that the solutions of (3.17) or (3.21) vanish at that boundary z_0 .

In the case of $\Phi(q, z) = z^2 J_\nu(qz)$ this means that the q must satisfy $qJ_\nu(qz_0) = 0$, i.e. the values of the hadron masses $M^2 = q^2$ are determined by the zeros $j_{\nu s}$ of the Bessel functions, see Fig. 3.1

$$\sqrt{q^2} z_0 = j_{\nu s} \quad (3.22)$$

The zeros of the Bessel functions can for not so high ν quite well be approximated by

$$j_{\nu, s} \approx \left(s + \frac{\nu}{2} - \frac{1}{4}\right)\pi - \frac{4\nu^2 - 1}{8\pi\left(s + \frac{\nu}{2} - \frac{1}{4}\right)} - \dots \quad (3.23)$$

Exact values are $j_{01} = 2.405$, $j_{02} = 5.520$, $j_{03} = 8.653$.

Comparison of the very simple model based on the wave equation (3.17) with the data is given in Tab. 3.1. Much better agreement with the data can be obtained if one takes into account additional symmetry breaking fields [16], see also [2], chapter 7 and literature quoted there.

3.2.2 The soft wall model [18]

In this model a scale is introduced by multiplying the Lagrangian (3.11) with a Dilaton term $e^{\varphi(z)}$. This yields the new Lagrangian ($\kappa = 3$)

$$\mathcal{L} = \frac{1}{2} e^{\kappa A(z) + \varphi(z)} (\eta^{MN} \partial_M \Phi \partial_N \Phi - e^{2A(z)} \mu^2 \Phi^2) \quad (3.24)$$

and the Euler Lagrange equation becomes, see (3.14)

$$e^{\kappa A(z) + \varphi(z)} \left(\eta^{\alpha\beta} \partial_\alpha \partial_\beta \Phi - \partial_z^2 \Phi - (\kappa \partial_z A(z) + \partial_z \varphi(z)) \partial_z \Phi + \frac{(\mu R)^2}{z^2} \Phi \right) = 0. \quad (3.25)$$

The most popular choice for the dilaton term is:

$$\varphi(z) = \lambda z^2 \quad (3.26)$$

After Fourier transformation, see (3.15) we obtain

$$\left(-q^2 - \partial_z^2 + \left(\frac{\kappa}{z} - 2\lambda z \right) \partial_z + \frac{(\mu R)^2}{z^2} \right) \tilde{\Phi}(q, z) = 0. \quad (3.27)$$

Here the program `mathematica` gives no useful solution and we better transform the equation into a more useful form. With the rescaling

$$\tilde{\Phi}(q, z) = z^{(\kappa+1)/2} e^{-\lambda z^2/2} \tilde{\Phi}_N(q, z) \quad (3.28)$$

we obtain

$$\left(-\partial_z^2 - \frac{1}{z} \partial_z + \frac{L_{AdS}^2}{z^2} + \lambda^2 z^2 - (\kappa - 1)\lambda \right) \tilde{\Phi}_N(q, z) = q^2 \tilde{\Phi}_N(q, z) \quad (3.29)$$

with

$$L_{AdS}^2 = (\kappa + 1)^2/4 + (\mu R)^2. \quad (3.30)$$

As is shown below this differential equation is closely related to the harmonic oscillator wave equation and has normalized eigenstates with eigenvalues

$$q^2 = M_{nL}^2 = (4n + 2L_{AdS} + 2)|\lambda| - (\kappa - 1)\lambda \quad (3.31)$$

and the eigenfunction for the eigenvalue specified by L_{AdS} and n is

$$\tilde{\Phi}_{N,nL_{AdS}}(z) = z^{L_{AdS}} e^{-|\lambda|z^2/2} L_n^{L_{AdS}}(|\lambda|z^2) \quad (3.32)$$

where $L_n^L(x)$ are the associated Laguerre polynomials. In `mathematica`: `LaguerreL[n, x]`; examples are : $L_0^L(x) = 1$, $L_1^L(x) = 1 + Lx$.

For the solution of (3.27) we obtain, according to (3.28)

$$\tilde{\Phi}_{nL_{AdS}}(z) = z^{(\kappa+1)/2} e^{-\lambda z^2} \tilde{\Phi}_{N,nL_{AdS}}(z) = z^{L_{AdS} + (\kappa+1)/2} e^{-(|\lambda| + \lambda)z^2/2} L_n^{L_{AdS}}(|\lambda|z^2) \quad (3.33)$$

Derivation of (3.32)-(3.33): The differential operator

$$\left(-\partial_z^2 - \frac{1}{z}\partial_z + \frac{L^2}{z^2} + \lambda^2 z^2\right) = 2H_{ho} \quad (3.34)$$

is twice the radial differential operator for a two dimensional harmonic oscillator with angular momentum L .

The the eigenvalues are

$$H_{ho}\Phi_{nL}(q, z) = E_{nL}\Phi_{nL} \quad (3.35)$$

with

$$E_{nL} = (2n + L + 1)|\lambda| \quad (3.36)$$

where L is the angular momentum and n is the radial excitation number. Hence we obtain for the spectrum of the eigenvalues of (3.29) as $q^2 = 2E_{nL} - (\kappa - 1)\lambda$ and the eigenfunctions are directly those of the 2 dimensional harmonic oscillator.

For the scalar field we have $\kappa = 3$ and with $L = 0$ we thus obtain :

$$M_n^2 = (4n + 2)|\lambda| - 2\lambda \quad (3.37)$$

With $\lambda > 0$ the lowest (pseudo)scalar particle has mass 0, which is indeed the expected value in the limit of massless quarks (chiral limit).

By rescaling

$$\tilde{\Phi}(q, z) = z^{\kappa/2} e^{-\varphi(z)/2} \tilde{\phi}(q, z) \quad (3.38)$$

we obtain the Schrödinger-like form

$$\left(-\partial_z^2 + \frac{4L_{AdS}^2 - 1}{4z^2} + \lambda^2 z^2 - (\kappa - 1)\lambda\right) \tilde{\phi}(q, z) = q^2 \tilde{\phi}(q, z) \quad (3.39)$$

where $L_{AdS}^2 = (\kappa + 1)^2/4 + (\mu R)^2$.

3.3 Vector Field

Here we proceed similarly as in electrodynamics in 4 space-time dimensions. We start from a vector field A_M , corresponding to the electromagnetic potential and construct the tensor field

$$F_{MN} = \partial_M A_N - \partial_N A_M \quad (3.40)$$

which corresponds to the electromagnetic field tensor.

We can use the normal derivatives, since the additional contributions due to the non-Euclidean metric vanish due to the antisymmetric construction. We start from the Lagrangian

$$\mathcal{L} = \sqrt{|g|} \left(\frac{1}{4} g^{MM'} g^{NN'} F_{MN} F_{M'N'} - \frac{1}{2} \mu^2 g^{MM'} A_M A_{M'} \right) \quad (3.41)$$

$$= \frac{R}{z} \left(\frac{1}{4} \eta^{MM'} \eta^{NN'} F_{MN} F_{M'N'} - \left(\frac{R}{z} \right)^2 \frac{\mu^2}{2} \eta^{MM'} A_M A_{M'} \right) \quad (3.42)$$

In contrast to electrodynamics we have added a mass term which breaks gauge invariance in the AdS₅. (This is a so called Proca-Lagrangian). For the soft wall model this Lagrangian is multiplied by a factor $e^{\varphi(z)}$ and thus our starting point is the Lagrangian:

$$\mathcal{L} = e^{A(z)+\varphi(z)} \left(\frac{1}{4} \eta^{MM'} \eta^{NN'} F_{MN} F_{M'N'} - \frac{\mu^2 R^2}{2z^2} \eta^{MM'} A_M A_{M'} \right) \quad (3.43)$$

where, as in (3.8)

$$\begin{aligned} A(z) &= -\log z + \log R \quad \text{and} \\ \varphi(x) &= \begin{cases} 0 & \text{for the hard wall model} \\ \lambda^2 z^2 & \text{for the soft wall model} \end{cases} \end{aligned} \quad (3.44)$$

In a gauge theory the 5-mass $\mu = 0$.

The 5 equations of motion are:

$$\partial_K \frac{\partial}{\partial(\partial_K A_L)} \mathcal{L} = \frac{\delta \mathcal{L}}{\delta A_L}, \quad L = 1, \dots, 5 \quad (3.45)$$

From the expression

$$\frac{\partial}{\partial(\partial_K A_L)} \mathcal{L} = e^{A(z)+\varphi(z)} \eta^{MK} \eta^{NL} (\partial_M A_N - \partial_N A_M) \quad (3.46)$$

we obtain the Euler-Lagrange equations:

$$\begin{aligned} \partial_K \frac{\partial}{\partial(\partial_K A_L)} \mathcal{L} - \frac{\delta \mathcal{L}}{\delta A_L} &= e^{A(z)+\varphi(z)} \left(\delta_K^5 (\partial_z A + \partial_z \varphi) \eta^{MK} \eta^{NL} (\partial_M A_N - \partial_N A_M) \right. \\ &\quad \left. + \eta^{MK} \eta^{NL} (\partial_K \partial_M A_N - \partial_K \partial_N A_M) + \frac{(\mu R)^2}{z^2} \eta^{LL'} A_{L'} \right) \\ &= e^{A(z)+\varphi(z)} \left((\partial_z A + \partial_z \varphi) \eta^{M5} \eta^{NL} (\partial_M A_N - \partial_N A_M) \right. \\ &\quad \left. + \eta^{MK} \eta^{NL} (\partial_K \partial_M A_N - \partial_K \partial_N A_M) + \frac{(\mu R)^2}{z^2} \eta^{LL'} A_{L'} \right) \end{aligned} \quad (3.47)$$

Since we have in Minkowski space three vector particles (spin components) and 5 components of the potential A_K , we can eliminate two components. We choose

$$A_5 = 0 \quad \text{and} \quad \eta^{MK} \partial_K A_M = 0 \quad (\text{Lorenz gauge}) \quad (3.49)$$

This simplifies (3.48) to:

$$\partial_K \frac{\partial}{\partial(\partial_K A_L)} \mathcal{L} = e^{A(z)-\varphi(z)} \left((\partial_z A + \partial_z \varphi) \eta^{M5} \eta^{NL} \partial_5 A_N + \eta^{MK} \eta^{NL} \partial_K \partial_M A_N \right) \quad (3.50)$$

from which we obtain in our notation, where Greek indices run from 1 to 4 and $\partial_5 \equiv \partial_z$:

$$\eta^{\nu\lambda} \left(\eta^{\mu\kappa} \partial_\mu \partial_\kappa A_\nu - \partial_z^2 A_\nu - (\partial_z A + \partial_z \varphi) \partial_z A_\nu + \frac{(\mu R)^2}{z^2} A_\nu \right) = 0 \quad (3.51)$$

We make the ansatz for the Fourier transform

$$A_\lambda(q, z) = \epsilon_\lambda(q) \tilde{\Phi}(q, z) \quad (3.52)$$

where $\epsilon(q)$ is the polarization vector of a transverse vector field, i.e. $\epsilon \cdot q = 0$, and we obtain for $\tilde{\Phi}(z)$ the wave equation:

$$\left(-\partial_z^2 - (\kappa \partial_z A + \partial_z \varphi) \partial_z + \frac{(\mu R)^2}{z^2} \right) \tilde{\Phi}(q, z) = q^2 \tilde{\Phi}(q, z) \quad (3.53)$$

For the hard wall model we have $\varphi = 0$, that is (3.53) is like (3.17) with $\kappa = 1$. For the soft wall model we have $\varphi(z) = \lambda z^2$, that is (3.53) is like (3.27) with $\kappa = 1$.

We can use equations (3.1) and (3.29) – (3.39) also for the vector field, just using for κ the value $\kappa = 1$, notably we have for the vector particle

$$L_{AdS}^2 = (\mu R)^2 + 1. \quad (3.54)$$

Chapter 4

Light front holographic QCD

Before we proceed further in the holographic approach, we shortly present the kinematical scheme, which is most adequate for a relativistic semiclassical treatment of a quantum field theory, the Light Front Quantization.

4.1 Wave functions in light front (LF) quantization

There are several schemes on which one can formulate the quantization rules. The most usual is the instantaneous one, which is based on correlators at the same time x^4 . The light front (LF) quantization [19] is based on quantization rules at equal light front time $x^+ = x^4 + x^3$. For a review of applications in QCD see e.g. [20]. In the limit of the 3-component of the hadron going to infinity the usual frame based on equal time quantization approaches the light front quantization frame.

In light front quantization we have the variables $x_+ = x^4 + x^3$, $x_- = x^4 - x^3$ and $\vec{x}_\perp = (x^1, x^2)$. A wave function in transverse position space with two constituents depends on the the following three variables, see also Fig. 4.1:

- The longitudinal momentum fractions of the constituents ¹, x_i , with $\sum_i x_i = 1$. If the longitudinal momentum of the hadron is P , the longitudinal momentum of the constituent i is $x_i P$.
- The two dimensional vector of transverse separation of the two constituents, $\vec{b}_\perp = x_\perp^{(1)} - x_\perp^{(2)}$ or, in polar coordinates, on $b_\perp = |\vec{b}_\perp|$ and the polar angle θ . The LF angular momentum L is given by $L = i \frac{\partial}{\partial \theta}$

¹The notation x_i for the longitudinal momentum fraction is commonly used, it is not to be confused with the space-time coordinates.

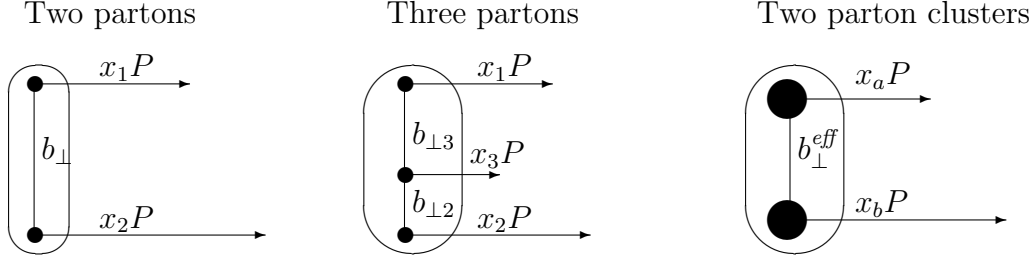

Figure 4.1: The LF variables for states with two or more constituents.

The mass for a Hadron with two constituents is in the LF form in momentum space given

$$M^2 = \int_0^1 dx \int d^2 k_\perp \tilde{\phi}^{LF*}(x, \vec{k}_\perp) \left(\frac{1}{x(1-x)} \vec{k}_\perp^2 + \frac{m_1^2}{x} + \frac{m_2^2}{1-x} \right) \tilde{\phi}^{LF}(x, \vec{k}_\perp) + \text{interaction} \quad (4.1)$$

where $\phi^{LF}(x, \vec{k}_\perp)$ is the LF wave function of two constituents with relative momentum \vec{k} and longitudinal momentum fractions $x_1 = x$, $x_2 = (1-x)$. By Fourier transformation we obtain:

$$M^2 = \int_0^1 dx \int d^2 b_\perp \phi^{LF*}(x, \vec{b}_\perp) \left(-\frac{1}{x(1-x)} \vec{\partial}_{b_\perp}^2 + \frac{m_1^2}{x} + \frac{m_2^2}{1-x} \right) \phi^{LF}(x, \vec{b}_\perp) + \text{interaction} \quad (4.2)$$

For vanishing constituent masses, $m_i = 0$, the x and \vec{b}_\perp dependence can be expressed by the LF variable

$$\vec{\zeta} = \sqrt{x(1-x)} \vec{b}_{\perp i}, \quad \zeta = |\vec{\zeta}| \quad (4.3)$$

and we construct the LF Hamiltonian

$$H = \left(-\vec{\partial}_\zeta^2 + U(\zeta) \right) = \left(-\partial_\zeta^2 - \frac{1}{\zeta} \partial_\zeta - \frac{1}{\zeta^2} \partial_\varphi^2 + U(\zeta) \right), \quad (4.4)$$

with $H\phi^{LF} = M^2 \phi^{LF}$.

The complicated interaction is here approximated by the LF potential $U(\zeta)$. By separating the variables $\phi^{LF}(\vec{\zeta}) = e^{iL\varphi} \phi^{LF}(\zeta)$ and by rescaling

$$\phi^{LF}(\zeta) = \chi(x) (2\pi\zeta)^{-1/2} \phi(\zeta) \quad (4.5)$$

we obtain for $\phi(\zeta)$ the Schrödinger-like equation:

$$H\phi(\zeta) = \left(-\partial_\zeta^2 + \frac{4L^2 - 1}{4\zeta^2} + U(\zeta) \right) \phi(\zeta) = M^2 \phi(\zeta) \quad (4.6)$$

L is the LF angular momentum. The LF potential $U(\zeta)$ is in principle determined by QCD it (hopefully) contains also some part of the influence of higher Fock states, that is states with more than two constituents.

In the following we shall mainly work with this form (4.24) , but we should keep in mind that the LF wave function is obtained from the solution $\phi(\zeta)$ of the Schrödinger like equation (4.6) by dividing through $\sqrt{\zeta}$.

We obtain an expression for the up to now arbitrary function $\chi(x)$ by the normalization conditions of the two wave functions. If we normalize $\phi(\zeta)$, the solution of (4.6) by

$$\int dz |\phi(z)|^2 = 1 \quad (4.7)$$

and the LF wave function ϕ^{LF} by

$$\int_0^\infty dx \int d^2b_\perp |\phi^{LF}[x, b_\perp]|^2 = 1 \quad (4.8)$$

Then we get the relation

$$\phi^{LF}(x, b_\perp) = \sqrt{\frac{x(1-x)}{2\pi\zeta}} \phi(\zeta). \quad (4.9)$$

More than two constituents Since in the holographic correspondence there is only one variable to describe the internal structure of hadrons, namely the coordinate of the 5th dimension, hadrons with more than two constituents have to be treated as consisting of clusters. In that case one introduces the effective longitudinal momentum fraction of a cluster a :

$$x_a^{eff} = \sum_{i=1}^{N_a} x_i, \quad (4.10)$$

where N_a is the number of constituents in the cluster a , and correspondingly one introduces effective transverse and longitudinal coordinates:

$$\vec{b}_{\perp,a}^{eff} = \left(\sum_{i=1}^{N_a} x_i \vec{b}_{\perp,i} \right) / x_a^{eff}, \quad \zeta = \sqrt{x_a^{eff} x_b^{eff}} |\vec{b}_{\perp,b}^{eff} - \vec{b}_{\perp,a}^{eff}|. \quad (4.11)$$

There is no theoretical limit for N_a . For the nucleon with three constituents we have: $\vec{b}_{\perp,d}^{eff} = (x_2 \vec{b}_{\perp,2} + x_3 \vec{b}_{\perp,3}) / (x_2 + x_3)$, $\zeta_{eff} = \sqrt{(x_2 + x_3)x_1}$ $\vec{b}_{\perp,d}^{eff} = \sqrt{\frac{x_1}{x_2+x_3}} (x_2 \vec{b}_{\perp,2} + x_3 \vec{b}_{\perp,3})$.

The introduction of a cluster is purely kinematical and necessary in order to apply the the holographic approach to hadrons with more than two constituents, since there is only one variable – the holographic variable of the fifth dimension – which describes the internal structure. This identification does not imply that the cluster is a tightly bound system; it only requires that essential dynamical features can be described in terms of the holographic variable. This assumption is supported by the observed similarity between the baryon and meson spectra.

The cluster occurring in this approach cannot be considered as a dynamical diquark and our approach is essentially different from a dynamical diquark picture. In the chiral limit the cluster does not acquire a finite mass, since the nucleon and delta masses are described well by the model without any additional mass terms in the supersymmetric LF Hamiltonian.

In Light Front Holographic QCD (LFHQCD) one identifies the holographic variable z with the LF variable ζ introduced above. The equal form of the LF Hamiltonian and the bound state operators (4.1) and (4.6) with the LF Hamiltonian of a two particle (two cluster) state with LF angular momentum L makes it suggestive, to identify the holographic variable $x_5 = z$ with the LF variable ζ . The purely formal quantity $L_{AdS} = \sqrt{(\kappa + 1)^2/4 + (\mu R)^2}$ of AdS/CFT becomes then a physical quantity related to the AdS-mass μ , we shall discuss this in detail in sect. 4.3.

4.2 Bound state equations for mesons with arbitrary spin

For spin higher than 1 the situation becomes very involved, since now we have to use covariant derivatives. A field with spin $J > 1$ is a symmetric tensor of rank J , $\Phi_{N_1 \dots N_J}$. An invariant action, modified by a dilaton term $e^{\varphi(z)}$ is

$$S_{eff} = \int d^d x dz \sqrt{g} e^{\varphi(z)} g^{N_1 N'_1} \dots g^{N_J N'_J} \left(g^{MM'} D_M \Phi_{N_1 \dots N_J}^* D_{M'} \Phi_{N'_1 \dots N'_J} - \mu_{eff}^2(z) \Phi_{N_1 \dots N_J}^* \Phi_{N'_1 \dots N'_J} \right). \quad (4.12)$$

Here one has to take into account that in non-Euclidean geometry the shift of a tensor is not only a shift in the variables but generally also mixes the components of the tensor see sect. 3.1.2, footnote 1. Therefore one has to use covariant derivatives and due to these the Lagrangian is very complicated and we refer to [21] for details. Here we only quote the resulting bound state equations for mesons with angular momentum L and total spin J .

We Fourier transform the field and extract a z -independent polarization vector $\epsilon_{\nu_1 \dots \nu_J}$:

$$\tilde{\Phi}_{\nu_1 \dots \nu_J}(q, z) = \epsilon_{\nu_1 \dots \nu_J} \tilde{\Phi}_{L,J}(q, z) \quad (4.13)$$

This leads to the equation of motion:

$$\left(-q^2 - \partial_z^2 + \left(\frac{3-2J}{z} - \partial_z \varphi \right) \partial_z + \frac{(\mu R)^2}{z^2} \right) \tilde{\Phi}_{L,J}(q, z) = 0 \quad (4.14)$$

Comparing this equation with (3.27) we see that we can use the solutions obtained in sect. 3.2.2 by inserting $\kappa = 3 - 2J$. This leads to:

$$L_{AdS}^2 = (J - 2)^2 + (\mu R)^2 \quad (4.15)$$

We bring (4.14) into a Schrödinger like form by rescaling

$$\phi(q^2, z) = z^{(2J-3)/2} e^{\varphi(z)/2} \tilde{\Phi}_{L,J}(q, z) \quad (4.16)$$

and obtain:

$$\left(-q^2 - \partial_z^2 + \frac{4L_{AdS}^2 - 1}{4z^2} + U_{AdS}(z) \right) \phi(q, z) = 0 \quad (4.17)$$

with

$$U_{AdS}(z) = \frac{1}{4}(\partial_z \varphi)^2 + \frac{1}{2}\partial_z^2 \varphi + \frac{2J-3}{2z}\partial_z \varphi \quad (4.18)$$

For the choice $\varphi(z) = \lambda z^2$ this simplifies to

$$U_{AdS}(z) = \lambda^2 z^2 + 2(J-1)\lambda \quad (4.19)$$

Equation (4.17) has normalizable eigenfunctions $\phi_{nL_{AdS}}(z)$ for the discrete values

$$q^2 = M_{nL_{AdS}J}^2 = (4n + 2L_{AdS} + 2)|\lambda| + 2(J-1)\lambda \quad (4.20)$$

with eigenfunctions

$$\phi_{nL_{AdS}}(z) = 1/N z^{L_{AdS}+1/2} L_n^{L_{AdS}}(|\lambda|z^2) e^{-|\lambda|z^2/2} \quad \text{with } N = \sqrt{\frac{(n+L)!}{2n!}} |\lambda|^{-(L+1)/2} \quad (4.21)$$

They are normalized to $\int_0^\infty dz (\phi_{nL_{AdS}}(z))^2 = 1$

The solution for the equation (4.14) of the unmodified field Φ is, see (4.16),

$$\Phi_{nL_{AdS}}(z) = \frac{1}{N} z^{2+L_{AdS}-J} L_n^{(L_{AdS})}(|\lambda|z^2) e^{-(|\lambda|+\lambda)z^2/2} \quad (4.22)$$

it is normalized as:

$$\int_0^\infty dz e^{\lambda z^2} z^{2J-3} \Phi_{nL_{AdS}}(z)^2 = 1 \quad (4.23)$$

4.3 Light Front Holographic QCD (LFHQCD)

We compare the soft wall result (4.17) with the general LF Hamiltonian:

$$H\phi(z) = \left(-\partial_\zeta^2 + \frac{4L^2 - 1}{4\zeta^2} + U(\zeta) \right) \phi(z) = M^2 \phi(z) \quad (4.24)$$

where the LF potential $U(\zeta)$ is not determined, and we see the structural identity, if we identify the holographic variable $x_5 = z$ with the LF variable ζ and the AdS quantity $L_{AdS} = \sqrt{(J-2)^2 + (\mu R)^2}$ with the the LF angular momentum L . The light front potential

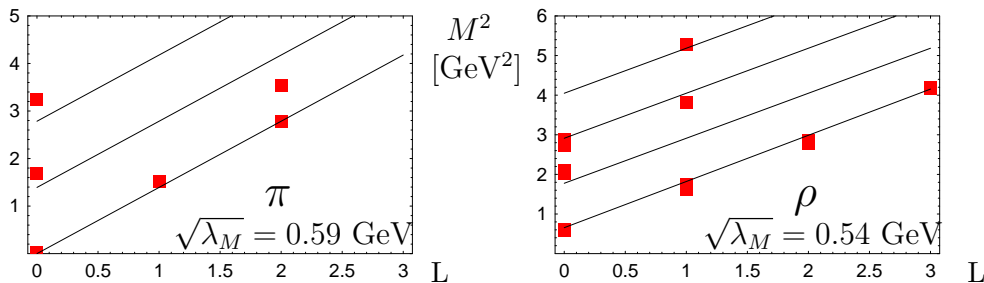

Figure 4.2: The theoretical spectra from (4.29) together with the data for the π and ρ trajectories and their daughters, from [2].

is then the potential U_{AdS} derived from the (modified) AdS action. Altogether we obtain the following dictionary between the AdS result and the LF Hamiltonian:

$$x_5 = z \Leftrightarrow \zeta \quad (4.25)$$

$$L_{AdS} = \sqrt{(J-2)^2 + (\mu R)^2} \Leftrightarrow L \quad (4.26)$$

$$U_{AdS}(z) \Leftrightarrow U(\zeta) \quad (4.27)$$

The quantity L_{AdS} in the formula for the spectrum (4.20) and the wave functions (4.21) are identified with the LF angular momentum. The potential is related to the dilaton modification of the AdS₅ action. The final bound state equation for a meson with LF orbital angular momentum L and total angular momentum J is for a dilaton $\varphi(z) = \lambda_M z^2$:

$$\left(-\partial_\zeta^2 + \frac{4L^2 - 1}{4\zeta^2} + \lambda_M^2 \zeta^2 + 2(J-1)\lambda_M \right) \phi(\zeta) = M^2 \phi(\zeta), \quad (4.28)$$

with the spectrum of LFHQCD

$$q^2 = M_{nLJ}^2 = (4n + 2L + 2) |\lambda_M| + 2(J-1)\lambda_M \quad (4.29)$$

and the solution (4.21). In the limit of massless quarks there is only one parameter λ_M in the theory, which sets the scale, which can be fixed e.g. by the ρ mass $2\lambda_M = m_\rho^2$. In this respect LFHQCD is like lattice gauge theory. It should be noted that in LFHQCD the parameter λ is always positive, whereas in the original paper of [18] its value has to be negative, see [2], sect. 5.1.2. for a discussion of that point.

If λ_M is fitted independently for the π and ρ trajectories, as done for the Fig. 4.2, the values agree within the expected variation of $\approx \pm 10\%$. From the π one obtains $\sqrt{\lambda_M} = 0.59 \text{ GeV}$, from the ρ one obtains $\sqrt{\lambda_M} = 0.54 \text{ GeV}$. The theoretical predictions given by (4.29) (black lines) together with the observed resonances are displayed in Fig. 4.2.

4.4 Bound state equations for baryons with arbitrary spin

We present only the starting point and the final result and refer to [21] for a detailed presentation. Particles with half integer spin are generally described [22] by a spinor with additional tensor indices, $\Psi_{N_1 \dots N_T}$. In 4 and 5 dimensions such a relativistic spinor has 4 components. The starting point is the invariant Lagrangian for a spinor field. It turns out that a dilaton term, that is a factor $e^{\lambda z^2}$ in the the Lagrangian does not lead to an interaction [23], since it can be absorbed by the fermion field, we therefore do not include it in the action. In order to get bound states one has to add a Yukawa like term $\bar{\Psi}_{N_1 \dots N_T} \lambda_B z^2 \Psi_{N'_1 \dots N'_T}$ to the Lagrangian [23].

Our starting point is the action:

$$S_{F\text{eff}} = \frac{1}{2} \int d^d x dz \sqrt{g} g^{N_1 N'_1} \dots g^{N_T N'_T} \left[\bar{\Psi}_{N_1 \dots N_T} \left(i \Gamma^A e_A^M D_M - \mu - \lambda_B z^2 \right) \Psi_{N'_1 \dots N'_T} + h.c. \right] \quad (4.30)$$

Here $\Psi_{N_1 \dots N_T}$ is a spinor field in AdS₅ with $T = J - \frac{1}{2}$ covariant indices, that is $T = 0$ for the nucleon. The spinor is symmetric in the tensor indices. $\Gamma^A e_A^M$ are the Dirac matrices in AdS₅ metric, e_A^M is the so called 4-bein of AdS, $e_A^M = \frac{z}{R} \delta_A^M$. The matrices Γ^A are the Dirac matrices of flat 5-dimensional space, $\Gamma^A = \gamma^A$, $\Gamma^5 = i\gamma_5$. $D_M \Psi_{N_1 \dots N_T}$ is the covariant derivative of a spinor (it is even more complicated than the covariant derivative of a tensor, since it contains also the so called spin connection.). A symmetry breaking term has been inserted: the Yukawa term $\bar{\Psi}_{N_1 \dots N_T} \lambda_B z^2 \Psi_{N'_1 \dots N'_T}$. As mentioned above, a term $e^{\varphi(z)}$ like in (4.12) could also be inserted, but it has no influence on the equations of motion.

The procedure to obtain the equations of motion is the following

1) We evaluate the Euler Lagrange equations:

$$\partial_K \frac{\partial}{\partial (\partial_K \Psi_{N_1 \dots N_T})} \mathcal{L} = \frac{\delta \mathcal{L}}{\delta \Psi_{N_1 \dots N_T}}; \quad \partial_K \frac{\partial}{\partial (\partial_K \bar{\Psi}_{N_1 \dots N_T})} \mathcal{L} = \frac{\delta \mathcal{L}}{\delta \bar{\Psi}_{N_1 \dots N_T}} \quad (4.31)$$

and obtain equations, which can be brought into the form:

$$\left[i \left(z \eta^{MN} \Gamma_M \partial_N + \frac{4 - 2T}{2} \Gamma_z \right) - \mu R - R \lambda z^2 \right] \Psi_{\nu_1 \dots \nu_T} = 0. \quad (4.32)$$

2) We set all spinor tensors, which have at least one index 5 to zero, that is all tensor-spinor fields have only Minkowski indices $\Psi_{\nu_1 \dots \nu_T}$. Then we go to the momentum space

$$\tilde{\Psi}_{\nu_1 \dots \nu_T}(q, z) = \int d^4 x e^{iqx} \Psi_{\nu_1 \dots \nu_T}(x, z) \quad (4.33)$$

and extract the spin content by spinors which satisfy the Dirac equation:

$$(\gamma q - M) u_{\nu_1 \dots \nu_T}(q) = 0, \quad \text{where } M^2 = q^2. \quad (4.34)$$

Then we define chiral spinors by $u_{\nu_1 \dots \nu_T}^\pm(q)$ with

$$u_{\nu_1 \dots \nu_T}^\pm(q) = \frac{1}{2}(1 \pm \gamma_5)u_{\nu_1 \dots \nu_T}(q) \quad (4.35)$$

The original spinor field can be decomposed into the chiral components:

$$\tilde{\Psi}_{\nu_1 \dots \nu_T}(q, z) = z^{2-T} (u_{\nu_1 \dots \nu_T}^+(q)\psi^+(q, z) + u_{\nu_1 \dots \nu_T}^-(q)\psi^-(q, z)) \quad (4.36)$$

From (4.32) one obtains coupled first order differential equations for $\tilde{\psi}^\pm(q, z)$, by reciprocal insertions they can be made to decouple and we finally obtain

$$\left(-\partial_z^2 + \frac{4L_{AdS}^2 - 1}{4z^2} + \lambda_B^2 z^2 + 2(L_{AdS} + 1)\lambda_B \right) \psi^+(q, z) = M^2 \psi^+(q, z) \quad (4.37)$$

$$\left(-\partial_z^2 + \frac{4(L_{AdS} + 1)^2 - 1}{4z^2} + \lambda_B^2 z^2 + 2L_{AdS} \lambda_B \right) \psi^-(q, z) = M^2 \psi^-(q, z) \quad (4.38)$$

with

$$L_{AdS} = |\mu R| - \frac{1}{2}. \quad (4.39)$$

We identify, as for the mesons, this quantity L_{AdS} with the LF angular momentum L of the hadron, strictly speaking the LF angular momentum between a quark and the cluster.

These equations have the same structure as the one for bosons (4.14). The LF potential for the two chirality components is:

$$U^\pm(z) = \lambda_B^2 z^2 + 2(L + \frac{1}{2} \pm \frac{1}{2})\lambda_B \quad (4.40)$$

that is it contains a quadratic confining term $\lambda_B^2 z^2$, as the meson potential (4.18), but different constant terms.

By comparing with the results obtained in sect. 4.2 we obtain the spectrum:

$$M_{nL}^2 = \lambda_B (4n + 2(L + \frac{1}{2} \mp \frac{1}{2}) + 2 + 2(L + \frac{1}{2} \pm \frac{1}{2})) = 4\lambda_B(n + L + 1) \quad (4.41)$$

and the same wave functions as the ones obtained for the mesons, see (4.21):

$$\psi_{nL}^+(q, z) = \phi_{nL}(z), \quad \psi_{nL}^-(q, z) = \phi_{nL+1}(z) \quad (4.42)$$

with

$$\phi_{nL}(z) = 1/N z^{L+1/2} L_n^{(L)}(|\lambda|z^2) e^{-|\lambda|z^2/2}. \quad (4.43)$$

Note that the two components of the baryon have different angular momentum. In the LF form the chirality + component has the spin aligned in $+x_3$ direction, the - component in $-x_3$ direction. If we speak of a baryon with spin L , we always refer to the L of the positive chirality component.

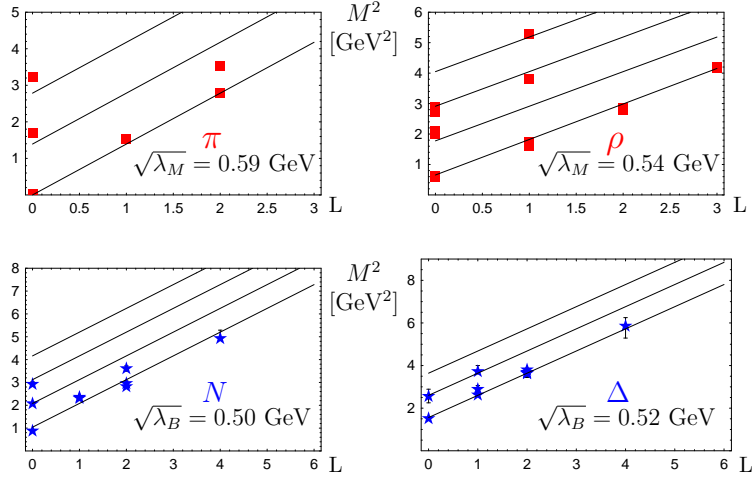

Figure 4.3: The light hadron trajectories.

The positive and negative chirality components of the original field, which satisfies (4.32) are (see (4.42) and (4.36))

$$\begin{aligned}
\tilde{\Psi}^+(z) &= z^{2+L+1/2-T} L_n^{(L)}(|\lambda|z^2) e^{-|\lambda|z^2/2} \\
\tilde{\Psi}^-(z) &= z^{3+L+1/2-T} L_n^{(L+1)}(|\lambda|z^2) e^{-|\lambda|z^2/2}
\end{aligned}
\tag{4.44}$$

where $T = J - \frac{1}{2}$. Note that for baryons the variable ζ corresponds to the separation between one of the quarks and a two quark cluster.

The spectrum is independent of J , it only depends on L . In some way this is good, since many states with the same orbital angular momentum L but different total angular momentum J have the same mass. But the mass of the Delta with $L = 0$, $J = \frac{3}{2}$ is different from that of the nucleon, which has $L = 0$, $J = \frac{1}{2}$. Therefore we have to insert in (4.41) an additional term $+2\lambda_B \mathcal{S}$, where \mathcal{S} is defined as the minimal spin of any 2-quark cluster, which can be formed in the baryon. For the Δ the spin $\mathcal{S} = 1$, since only in that way we can obtain the total spin $\frac{3}{2}$, but in the nucleon the spin $\frac{1}{2}$ can be formed from a two quark system with spin 0.

$$M_{nL}^2 = 4(n + L + 1) \lambda_B + 2\mathcal{S} \lambda_B \tag{4.45}$$

This is in contrast to the mesons, where the mass difference of the π and the ρ was a consequence of the AdS action. As can be seen from Fig. 4.3, the quality of the results for baryons is comparable to that of mesons. It is remarkable, that the value of the scale λ is very similar both for mesons and baryons.

We shall come to a theoretical framework in which this must be the case in the next chapter, but before we expand the applicability of the model to a larger data basis by including the effects of small quark masses.

4.5 Inclusion of small quark masses

For small quark masses one expects that the mass effects can be treated in a perturbative way. Therefore one first tries perturbation theory. In the basic formula (4.1) for the construction of the Hamiltonian,

$$M^2 = \int_0^1 dx \int d^2 k_\perp \tilde{\phi}^{LF*}(x, \vec{k}_\perp) \left(-\frac{1}{x(1-x)} \vec{k}_\perp^2 + \frac{m_1^2}{x} + \frac{m_2^2}{1-x} \right) \tilde{\phi}^{LF}(x, \vec{k}_\perp) + \text{interaction} \quad (4.46)$$

the mass terms occur as $\sum \frac{m_i}{x_i}$. Therefore a first guess for mass shift due to the quark masses is:

$$\Delta M^2 = \int_0^1 \left(\frac{m_1^2}{x} + \frac{m_2^2}{1-x} \right) \phi^{LF}(\vec{b}_\perp, x)^2 b_\perp db_\perp d\phi dx \quad (4.47)$$

where ϕ^{LF} is the normalized LF wave function, see sect. 4.1. Inserting the relation (4.9) and using $x(1-x)b_\perp db_\perp = \zeta d\zeta$ one obtains

$$\Delta M^2 = \int dx \left(\frac{m_1^2}{x} + \frac{m_2^2}{1-x} \right) \int d\zeta \phi(\zeta)^2 \quad (4.48)$$

where $\phi(\zeta)$ is the normalized wave function (4.21). This expression for ΔM^2 diverges!

Therefore we have to look for more realistic wave functions: The LF wave function (4.22) has the exponential behavior $\sim e^{-\lambda x(1-x)b_\perp^2/2}$. Its Fourier transform is

$$\int d^2 b e^{i\vec{b}_\perp \vec{k}_\perp} e^{-\lambda x(1-x)b_\perp^2/2} = \frac{2\pi}{x(1-x)} e^{-k_\perp^2/(2\lambda x(1-x))} \quad (4.49)$$

The expression $\frac{k_\perp^2}{x(1-x)}$ in the wave function describes the off-energy shell behaviour in LF form for massless quarks. Including quark masses, makes this quantity, see (4.1) :

$$\frac{k_\perp^2}{x(1-x)} + \left(\frac{m_1^2}{x} + \frac{m_2^2}{1-x} \right) \quad (4.50)$$

So it is plausible to include this factor also in the wave function, that is replace:

$$e^{-\frac{1}{2\lambda} \frac{k_\perp^2}{x(1-x)}} \rightarrow e^{-\frac{1}{2\lambda} \left(\frac{k_\perp^2}{x(1-x)} + \frac{m_1^2}{x} + \frac{m_2^2}{1-x} \right)} \quad (4.51)$$

This amounts to a multiplication of the wave functions with the factor

$$e^{\frac{-1}{2\lambda} \left(\frac{m_1^2}{x} + \frac{m_2^2}{1-x} \right)} \quad (4.52)$$

The modified normalized wave function is then:

$$\phi_m = \frac{1}{N} e^{\frac{-1}{2\lambda} \left(\frac{m_1^2}{x} + \frac{m_2^2}{1-x} \right)} \phi \quad (4.53)$$

	LFHQCD	Experiment
	GeV	GeV
Λ	1.15	1.116
Σ^*	1.35	1.385
Ξ	1.32	1.314
Ξ^*	1.50	1.530
Ω	1.68	1.672
K^*	0.90	0.892
Φ	1.08	1.020

Table 4.1: Masses of ground states with $m_q = 0.046$, $m_s = 0.35$ GeV. The values for λ are the same as for the non-strange hadrons.

with $N^2 = \int_0^1 dx e^{-\frac{1}{\lambda}(\frac{m_1^2}{x} + \frac{m_2^2}{1-x})}$.

The expression for the mass correction becomes:

$$\Delta M^2 = \frac{1}{N^2} \left[\int_0^1 dx \left(\frac{m_1^2}{x} + \frac{m_2^2}{1-x} \right) e^{-\frac{1}{\lambda}(\frac{m_1^2}{x} + \frac{m_2^2}{1-x})} \right] \quad (4.54)$$

This expression can be extended to many quarks [27]:

$$\Delta M_n^2(m_1, \dots, m_n) = (-2\lambda^2) \frac{\partial}{\partial \lambda} \log \left[\int_0^1 dx_1 \dots dx_n \delta(x_1 + \dots + x_n - 1) e^{-\frac{1}{\lambda}(\frac{m_1^2}{x_1} + \dots + \frac{m_n^2}{x_n})} \right] \quad (4.55)$$

As can be seen from Tab. 4.1 and Figs. 4.4 and 4.5 one can get reasonable fits to all hadron trajectories containing strange quarks. From π and K one deduces the effective quark masses: $m_q = 0.046 \text{ GeV}$, $m_s = 0.35 \text{ GeV}$. For the ground states of the other hadrons, the resulting masses agree very well with experiment, see Tab. 4.1.

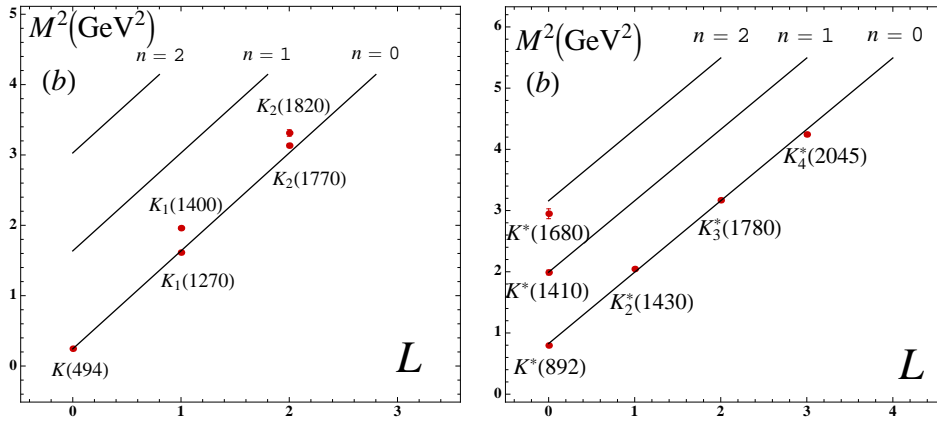

Figure 4.4: Spectra of strange mesons with $m_q = 0.046\text{GeV}$, $m_s = 0.35\text{ GeV}$. The values for λ are the same as for the non-strange hadrons.

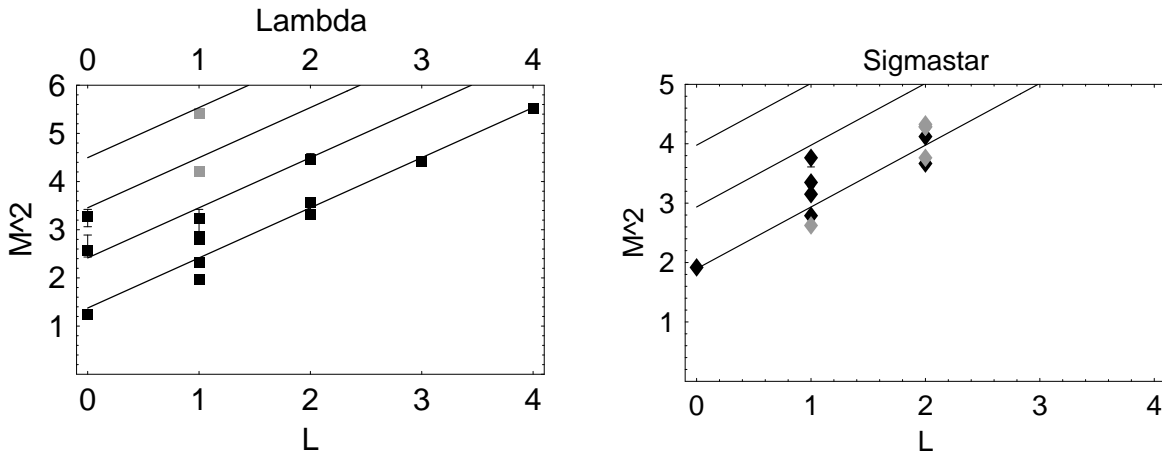

Figure 4.5: Spectra of strange baryons with $m_q = 0.046\text{GeV}$, $m_s = 0.35\text{ GeV}$. The values for λ are the same as for the non-strange hadrons.

4.6 Summary

From the holographic principle one can derive wave functions for hadrons. By modifying the action by suitable terms one can reproduce the spectrum of all hadrons containing only light quarks within the expected accuracy. The form of the wave functions allows an interpretation of the quantities occurring in AdS₅. The holographic variable can be identified with the LF variable ζ , (4.3), and the product of the AdS mass μ and the curvature R is related to the LF angular momentum, see (4.15). By a well justified modification of the wave function due to finite but small quark masses, one can describe all light hadrons in a satisfactory way, see Figs. 4.3 – 4.5 .

There remain, however, two major unsatisfactory points: 1) The modification of the invariant AdS₅ action was not determined by some theoretical principles but completely arbitrary and only chosen to satisfy the data. 2) The observed similarity between meson and baryon spectra seems fortuitous, since the modification of the meson and baryon action has nothing in common, for mesons one multiplies the Lagrangian by a function, for baryons one has to add a Yukawa-like term; the observed equality (within the expected accuracy) of the values of the fundamental parameters λ_M and λ_B seems also accidental. A third and minor point is: that there was also no theoretical justification for adding the spin term $2\mathcal{S}\lambda$ to the baryon spectrum in (4.45).

In the next section we shall see that there is indeed a theoretical remedy for all these unsatisfactory aspects.

Chapter 5

Supersymmetric light front holographic QCD

The content of this chapter is based on the publications [24, 25, 27, 26].

The classical QCD Lagrangian contains in the limit of massless quarks no scale and is therefore invariant under the conformal group in 4 dimensions ¹. In the AdS/CFT scheme, the action of the quantum gauge theory shows an even larger symmetry, it is also invariant under supersymmetry. Light Front Holographic QCD has approximated the quantum field theory by a semiclassical theory (Quantum mechanics) by reducing the dynamics to a Light Front Hamiltonian with two constituents (or clusters of constituents) and a potential. This is feasible, since in the limit of many colours in the gauge field theory all its features can be obtained by the classical solutions of an action in a 5 dimensional space. Quantum mechanics, and hence the semiclassical approximation, can be viewed as a quantum field theory in one dimension. It is therefore tempting to apply the symmetry constraints of the 4 dimensional quantum field theory of the AdS/CFT correspondence also to the semiclassical theory, which is a one-dimensional quantum field theory. In short we will discuss the consequences of an implementation of the superconformal (graded) algebra on our approach of light front holographic QCD. Fortunately superconformal quantum mechanics is much simpler than general superconformal field theory and notably it is a symmetry of wave functions and therefore it does not lead to the existence of new (stable) particles which are the superpartners of the existing particles. For pedagogical reasons we start with conformal symmetry, leaving the superconformal symmetry for the following section.

¹Information on many concepts in this section, as conformal group, Noether theorem etc. can be found conveniently in Wikipedia or Wikischolars.

5.1 Constraints from conformal algebra

Our aim is to incorporate into a semiclassical effective theory conformal symmetry. We will require that the corresponding one-dimensional effective action which encodes the conformal symmetry of QCD remains conformally invariant. De Alfaro, Fubini and Furlan [28] investigated in detail the simplest scale-invariant one-dimensional field theory, given by the action

$$A[Q] = \frac{1}{2} \int dt \left(\dot{Q}^2 - \frac{g}{Q^2} \right) = \int dt \mathcal{L}, \quad (5.1)$$

where $\dot{Q} \equiv dQ/dt$. Since the action is dimensionless (in natural units), the dimension of the field Q must be half the dimension of the “time” variable t , $\dim[Q] = \frac{1}{2}\dim[t]$, and the constant g is dimensionless. The translation operator in t , the Hamiltonian, is

$$H = \frac{1}{2} \left(\dot{Q}^2 + \frac{g}{Q^2} \right), \quad (5.2)$$

where the field momentum operator is $P = \frac{\partial \mathcal{L}}{\partial \dot{Q}} = \dot{Q}$, and the quantum equal time commutation relation is

$$[Q(t), \dot{Q}(t)] = [Q(t), P(t)] = i. \quad (5.3)$$

The equation of motion for the field operator $Q(t)$ is given by the usual quantum mechanical evolution

$$i [H, Q(t)] = \frac{dQ(t)}{dt}. \quad (5.4)$$

Up to now we have worked in the Heisenberg picture: states are time independent, but operators depend on time. Since we want to obtain a Schrödinger-like equation we go to the Schrödinger picture with time dependent states $|\psi(t)\rangle$ and time independent operators. The time dependence of the states is determined by the Hamiltonian:

$$H|\psi(t)\rangle = i \frac{d}{dt} |\psi(t)\rangle. \quad (5.5)$$

We realize the states as elements of a Hilbert space of functions with one variable and therefore the fields Q and $P = \dot{Q}$ are operators in that space. They are given by the substitution

$$Q(0) \rightarrow x, \quad \dot{Q}(0) \rightarrow -i \frac{d}{dx}. \quad (5.6)$$

Then we obtain the usual quantum mechanical evolution

$$i \frac{\partial}{\partial t} \psi(x, t) = H \left(x, -i \frac{d}{dx} \right) \psi(x, t), \quad (5.7)$$

Using (5.2) and (5.6) we obtain the familiar form

$$H = \frac{1}{2} \left(-\frac{d^2}{dx^2} + \frac{g}{x^2} \right). \quad (5.8)$$

It has the same structure as the LF Hamiltonian (4.24) with a vanishing light-front potential, as expected for a conformal theory. The dimensionless constant g in action (5.1) is now related to the angular momentum in the light front wave equation (4.22).

As emphasized in [28], the absence of dimensional constants in (5.1) implies that the action $A[Q]$ is invariant under the full conformal group in one dimension, that is, under translations, dilatations, and special conformal transformations. These can be easily expressed by the infinitesimal transformations of the variable t and the field Q :

$$\text{Translation } t \rightarrow t' = t + \epsilon, \quad Q \rightarrow Q' = Q \quad (5.9)$$

$$\text{Dilatation } t \rightarrow t' = t(1 + \epsilon), \quad Q \rightarrow Q' = Q \sqrt{1 + \epsilon} \quad (5.10)$$

$$\text{spec. conf. transf. } t \rightarrow t' = \frac{t}{1 - \epsilon t}, \quad Q \rightarrow Q' = \frac{Q}{1 - \epsilon t} \quad (5.11)$$

One can convince oneself, that (5.1) is indeed invariant under these transformations. In checking this, be aware that ϵ is assumed to be infinitesimal, that is terms of $O(\epsilon^2)$ must be neglected.

The constants of motion of the action are obtained by applying the Noether theorem. These constants of motion are the generators of the conformal group. They are

Translations :

$$H(0) = \frac{1}{2} \left(\dot{Q}^2 + \frac{g}{Q^2} \right), \quad (5.12)$$

Dilatations:

$$D(0) = -\frac{1}{4} \left(\dot{Q}Q + Q\dot{Q} \right) \quad (5.13)$$

Special conformal transformations:

$$K(0) = \frac{1}{2}Q^2. \quad (5.14)$$

Using the commutation relations (5.3) one can check that the operators H, D and K do indeed fulfill the algebra of the generators of the one-dimensional conformal group $Conf(R^1)$

$$[H, D] = iH, \quad [H, K] = 2iD, \quad [K, D] = -iK. \quad (5.15)$$

The conventional Hamiltonian H is one of the generators of the conformal group. One can extend the concept of a Hamiltonian by forming a linear superposition of all three generators

$$G = uH + vD + wK. \quad (5.16)$$

The new Hamiltonian G acts on the state vector and its evolution involves a new time variable τ , which is related to t by

$$d\tau = \frac{dt}{u + vt + wt^2}. \quad (5.17)$$

We now insert into (5.16) the expressions (5.12 – 5.14) and the Schrödinger picture substitutions (5.6) and obtain:

$$G = \frac{1}{2}u \left(-\frac{d^2}{dx^2} + \frac{g}{x^2} \right) + \frac{i}{4}v \left(x \frac{d}{dx} + \frac{d}{dx} x \right) + \frac{1}{2}wx^2. \quad (5.18)$$

Comparing with the LF Hamiltonian:

$$H = -\partial_\zeta^2 + \frac{4L^2 - 1}{4\zeta^2} + U(\zeta); \quad (5.19)$$

we see that the constraint to construct the Hamiltonian inside the conformal algebra restricts the possible forms of the potential considerably.

Comparing with the AdS-Hamiltonian for mesons

$$\left(-\partial_z^2 + \frac{4L^2 - 1}{4\zeta^2} + \lambda^2\zeta^2 + 2(J - 1)\lambda \right) \quad (5.20)$$

shows that with $u = 2$, $w = \lambda^2$, $v = 0$, $g = L^2 - \frac{1}{4}$ the "conformal Hamiltonian" G , (5.18), reproduces the ζ dependent terms of the AdS Hamiltonian for mesons.

This is very good, but not enough. We have also constant terms, which are essential for the spectra, and, above all we have baryons, therefore we also implement supersymmetry, which relates meson wave functions with baryon wave functions, that is we extend the conformal algebra to the superconformal algebra.

5.2 Constraints from superconformal (graded) algebra

5.2.1 Supersymmetric QM

As mentioned in the Introduction, Supersymmetry (SUSY) relates particles of different spin. From a theorem of Coleman and Mandula follows, that this is impossible for symmetry groups based on algebras, like the rotational group, the gauge group $SU(3)$ etc. It has been shown that only symmetries based on generators which obey commutation and anti-commutation rules can do that. Such an extension of an algebra is called a graded algebra.

For a certain time, SUSY was very popular. Especially string theory is only fully consistent in a supersymmetric world. Supersymmetric QFT is very complicated. Moreover there is no sign in nature that it is realized, although the hopes were very high that one would detect new particles which are supersymmetric partners of known ones. One had even speculated that supersymmetric partners of neutrinos might be good candidates for dark matter in cosmology. But since – at least up to now – no new particles, which could be supersymmetric partners, were found at LHCb, SUSY came in disrepute with phenomenologically interested physicists.

In contrast to SUSY Quantum Field theory, SUSY Quantum Mechanics is very simple [29]. It is based on a graded algebra consisting of two “supercharges” (fermionic operators), Q and Q^\dagger , and a bosonic operator (the Hamiltonian) H . The two supercharges obey anticommutation relations,

$$\{Q, Q^\dagger\} = 2H, \quad \{Q, Q\} = 0, \quad \{Q^\dagger, Q^\dagger\} = 0$$

a supercharge and a bosonic operator obey commutation relations.

$$[Q, H] = 0, \quad [Q^\dagger, H] = 0. \quad ^2$$

It is easy to realize this graded algebra as matrices in a Hilbert space with two components:

$$Q = \begin{pmatrix} 0 & -\partial_x + \frac{f}{x} + V(x) \\ 0 & 0 \end{pmatrix}, \quad Q^\dagger = \begin{pmatrix} 0 & 0 \\ \partial_x + \frac{f}{x} + V(x) & 0 \end{pmatrix} \quad (5.21)$$

$$2H = \begin{pmatrix} -\partial_x^2 + \frac{f^2+f}{x^2} + V^2(x) - \partial_x V(x) + \frac{2fV(x)}{x} & 0 \\ 0 & -\partial_x^2 + \frac{f^2-f}{x^2} + V^2(x) + \partial_x V(x) + \frac{2fV(x)}{x} \end{pmatrix} \quad (5.22)$$

where f is a dimensionless constant and V has $\lim_{x \rightarrow 0} xV(x) = 0$, otherwise arbitrary.

5.2.2 Superconformal quantum mechanics

If the superpotential V vanishes, there is no dimensionful quantity in the game and we can extend the SUSY algebra to a superconformal algebra [30, 31]. For $V(x) = 0$ the operators (5.21) become

$$Q = Q_0 = \begin{pmatrix} 0 & -\partial_x + \frac{f}{x} \\ 0 & 0 \end{pmatrix}, \quad Q_0^\dagger = \begin{pmatrix} 0 & 0 \\ \partial_x + \frac{f}{x} & 0 \end{pmatrix} \quad (5.23)$$

The absence of a dimensionful constant allows to extend the supersymmetric algebra to a superconformal one. This is done by introducing a new supercharge S and its Hermitian adjoint S^\dagger with the following anticommutation relations

$$\{S, S^\dagger\} = 2K, \quad \{Q_0, S^\dagger\} - \{Q_0^\dagger, S\} = 4iD, \quad \{Q_0, S^\dagger\} + \{Q_0^\dagger, S\} = 2fI + \sigma^3 \quad (5.24)$$

all other anticommutators vanish

$$\{Q_0, Q_0\} = \{Q_0, S\} = \{S, S\} = \{Q_0^\dagger, Q_0^\dagger\} = \{Q_0^\dagger, S^\dagger\} = \{S^\dagger, S^\dagger\} = 0 \quad (5.25)$$

Here K and D are the conformal operators introduced above. We see that the new supercharges S, S^\dagger extend the supersymmetric graded algebra to a superconformal one, which contains also the generators of the conformal algebra, introduced in the previous section. In matrix notation we have:

$$S = \begin{pmatrix} 0 & x \\ 0 & 0 \end{pmatrix}, \quad S^\dagger = \begin{pmatrix} 0 & 0 \\ x & 0 \end{pmatrix}, \quad I = \begin{pmatrix} 1 & 0 \\ 0 & 1 \end{pmatrix}, \quad \sigma_3 = \begin{pmatrix} 1 & 0 \\ 0 & -1 \end{pmatrix}. \quad (5.26)$$

²Note that the operator $2H$ corresponds to the Meson Hamiltonian to be compared with the LF Hamiltonian

5.2.3 Consequences of the superconformal algebra for dynamics

In subsection 5.1 a new Hamiltonian G was constructed inside the conformal algebra. Here we construct a new Hamiltonian inside the superconformal (graded) algebra. We now follow [24, 4] in applying the procedure of [28], which was extended to the superconformal algebra by Fubini and Rabinovici [31] and construct a generalized Hamiltonian. For that we introduce the supercharge R_λ as linear combination of Q and S :

$$R_\lambda = Q_0 + \lambda S \quad (5.27)$$

that is

$$R_\lambda = \begin{pmatrix} 0 & r_\lambda \\ 0 & 0 \end{pmatrix}, \quad R^\dagger = \begin{pmatrix} 0 & 0 \\ r_\lambda^\dagger & 0 \end{pmatrix} \quad (5.28)$$

with: $r_\lambda = -\partial_x + \frac{f}{x} + \lambda x$, $r_\lambda^\dagger = \partial_x + \frac{f}{x} + \lambda x$

The new generalized Hamiltonian is constructed analogously to the original one, but now not as an anticommutator of the supercharges Q and Q^\dagger , but as an anticommutator of the supercharges R_λ and R_λ^\dagger :

$$G = \{R_\lambda, R_\lambda^\dagger\} = \{Q_0, Q_0^\dagger\} + \lambda^2 \{S, S^\dagger\} + \lambda \left(\{Q_0, S^\dagger\} + \{S, Q_0^\dagger\} \right) \quad (5.29)$$

In this generalization of the Hamiltonian the dimensionful quantity λ appears naturally, since S and Q have different physical dimension, Q has dimension $[1/l]$ (1 over length), S has dimension $[l]$, hence λ must have $[l^{-2}]$.

The new Hamiltonian G is diagonal:

$$G = \begin{pmatrix} r_\lambda r_\lambda^\dagger & 0 \\ 0 & r_\lambda^\dagger r_\lambda \end{pmatrix} = \begin{pmatrix} G_{11} & 0 \\ 0 & G_{22} \end{pmatrix} \quad (5.30)$$

Supersymmetry implies that the two eigenvalues of G_{11} and G_{22} are identical. This can easily be checked:

Be $\phi = \begin{pmatrix} \phi_M \\ \phi_B \end{pmatrix}$ an eigenvector of G , then we have

$$R_\lambda^\dagger G \phi = E R_\lambda^\dagger \phi \quad (5.31)$$

$$= R_\lambda^\dagger (R_\lambda R_\lambda^\dagger + R_\lambda^\dagger R) \phi \quad (5.32)$$

$$= R^\dagger R R_\lambda^\dagger \phi \quad \text{since } R_\lambda^\dagger R_\lambda^\dagger = 0 \quad (5.33)$$

$$= (R_\lambda R_\lambda^\dagger + R_\lambda^\dagger R) R_\lambda^\dagger \phi \quad (5.34)$$

$$= G R_\lambda^\dagger \phi \quad (5.35)$$

That is if ϕ is eigenstate of G , then $R_\lambda^\dagger \phi$ is also eigenstate with the same eigenvalue. Let ϕ^1 be the state $\phi^1 = \begin{pmatrix} \phi_M \\ 0 \end{pmatrix}$ and $\phi^2 = \begin{pmatrix} 0 \\ \phi_B \end{pmatrix}$, then

$$R_\lambda^\dagger \phi^1 = \begin{pmatrix} 0 \\ r_\lambda^\dagger \phi_M \end{pmatrix} \quad (5.36)$$

has a lower component. Since it has the same eigenvalue as ϕ^1 , the two components have the same eigenvalues.

We now construct the new Hamiltonian explicitly. Inserting (5.28) we obtain the explicit expressions

$$G_{11} = -\partial_x^2 + \frac{4(f + \frac{1}{2})^2 - 1}{4x^2} + \underbrace{\lambda^2 x^2 + 2\lambda(f - \frac{1}{2})}_{U_-}, \quad (5.37)$$

$$G_{22} = -\partial_x^2 + \frac{4(f - \frac{1}{2})^2 - 1}{4x^2} + \underbrace{\lambda^2 x^2 + 2\lambda(f + \frac{1}{2})}_{U_+}. \quad (5.38)$$

and compare this result with the Hamiltonians obtained from LFHQCD.

For the baryons we had obtained, see (4.37):

$$\left(-\partial_z^2 + \frac{4L^2 - 1}{4z^2} + \lambda_F^2 z^2 + 2(L + 1)\lambda_F\right) \Psi^+(q, z) = M^2 \Psi^+(q, z) \quad (5.39)$$

$$\left(-\partial_z^2 + \frac{4(L + 1)^2 - 1}{4z^2} + \lambda_F^2 z^2 + 2L\lambda_F\right) \Psi^-(q, z) = M^2 \Psi^-(q, z) \quad (5.40)$$

and for mesons with $J = L + S$, see (4.28)

$$\left(-\partial_z^2 + \frac{4L^2 - 1}{4\zeta^2} + \lambda^2 \zeta^2 + 2(J - 1)\lambda\right) \tilde{\Phi}_{L,J}(q, z) = q^2 \tilde{\Phi}_{L,J}(q, z) \quad (5.41)$$

we identify $f = L + \frac{1}{2}$ and $x = \zeta$ and we notice two very nice features:

1) We recover the baryon equations (4.37)f. The potentials were in LFHQCD constructed with a modification of the AdS Lagrangian [24], which was there chosen *ad hoc* for purely phenomenological reasons. In superconformal LFHQCD the potentials are a consequence of the algebra. The chirality transformation, that is multiplication by γ_5 acts like a supercharge.

2) G_{11} is the Hamiltonian of a meson with $L_M = J = f + \frac{1}{2}$ and G_{22} is the Hamiltonian of the baryon component ψ_B^+ with $L_B = f - \frac{1}{2}$. So we can put the meson wave function ϕ_{L_M} with LF angular momentum L_M and the positive chirality baryon wave function ψ_B^+ with angular momentum $L_B = L_M - 1$ in a supersymmetric doublet:

$$\Phi = \begin{pmatrix} \phi_{L_M} \\ \psi_{L_M-1}^+ \end{pmatrix} \quad (5.42)$$

The supercharge R_λ^\dagger transforms the wave function of a boson into that of a fermion [4]. That is Fermion and Boson wave functions are transformed into each other by a supercharge, namely R_λ^\dagger , as it should be in supersymmetry !

The meson with angular momentum $L_M = f + \frac{1}{2}$ is superpartner of Baryon with $L_B = f - \frac{1}{2}$, therefore mesons with $L_M = 0$ (*e.g.*) can have no superpartner since $L_B = -1$ is excluded. One can easily check that the lowest eigenstate ϕ_0 of the Hamiltonian G has the eigenvalue 0 and the form

$$\Phi_0 = \begin{pmatrix} \phi_{00} \\ 0 \end{pmatrix}, \quad (5.43)$$

where ϕ_{00} is given by (4.21). This implies that there exists no nontrivial eigenstate of the baryon with eigenvalue 0 which could be a partner of the lowest mesonic state. This is due to the fact that $r_\lambda^\dagger \phi_{00} = 0$.

Up to now we have only treated hadrons where the quark spin does not enter explicitly, like in the pion and in the nucleon. In the next subsection the treatment will be extended to other cases, notably the rho-meson and the Delta resonance.

5.2.4 Spin terms and small quark masses

For mesons the action AdS distinguishes between the ρ trajectory, where the total quark spin $\mathcal{S} = 1$, and the π trajectory, where the quark spin $\mathcal{S} = 0$. Therefore the Hamiltonian (4.28) depends both on the orbital angular L and on the total angular momentum. For mesons with $J = L + \mathcal{S}$, where \mathcal{S} is the total quark spin, we can separate the Hamiltonian (4.28) into a part containing only the angular momentum plus the spin term.

$$H_M = H_{J=L} + 2\mathcal{S} \lambda = G_{11} + 2\mathcal{S} \lambda \quad (5.44)$$

The Hamiltonian for a meson with $J = L$ is identical with G_{11} . Therefore we obtain as final Hamiltonian

$$G_{SUSY} = \{R_\lambda, R_\lambda^\dagger\} + \mathbf{S} \mathbf{I}, \quad (5.45)$$

where \mathbf{I} is the unit operator; \mathcal{S} is for mesons the total quark spin, and for baryons the minimal possible quark spin of two-quark clusters inside baryon.

The supercharges $R_\lambda, R_\lambda^\dagger$ are given by (5.28) with $f = L_B + \frac{1}{2}$, they connect a baryon wave functions with angular momentum L_B and positive chirality and diquark spin \mathcal{S} with a meson wave function with angular momentum $L_M = L_B + 1$ and total quark spin \mathcal{S} .

In LFHQCD, sect. 4.4, the additional spin term in (4.45) had to be added for baryons by hand in order to obtain agreement with experiment. In (5.45) it is a consequence of supersymmetry.

The corrections through finite quark masses will be the same as discussed in sect. 4.5 and will break the supersymmetry. The final formulae for spectra from AdS with superconformal constraints are:

$$\begin{aligned} \text{Mesons} \quad & M_M^2 = 4\lambda(n + L_M) + 2\lambda \mathcal{S} + \Delta M_2^2(m_1, m_2), \\ \text{Baryons} \quad & M_B^2 = 4\lambda(n + L_B + 1) + 2\lambda \mathcal{S} + \Delta M_3^2(m_1, m_2, m_3). \end{aligned} \quad (5.46)$$

Note that in applications of LFHQCD before 2016, e.g. in [2], for baryons with $\mathcal{S} = 1$ the spin effect was taken into account by formally using half integer LF angular momentum; this leads to the same mass formulæ.

5.2.5 Comparison with experiment

In Fig. 5.1 we display the theoretical curves obtained from (5.46) and the experimental results for the non-strange hadrons, in Fig. 5.2 for hadrons containing 1 or 2 strange quarks. The result for the Ω^- mass comes out to 1760 MeV, within the expected accuracy compatible with the experimental mass of 1672 MeV. In Fig. 5.3 we display the values of $\sqrt{\lambda}$ obtained by independent fits to the different channels. Indicated at the abscissa are the lowest ($L = 0$) state of the trajectory. Theory and experiment agree with the same accuracy of $\approx \pm 100$ MeV, as expected from the model and also observed in the previous chapter.

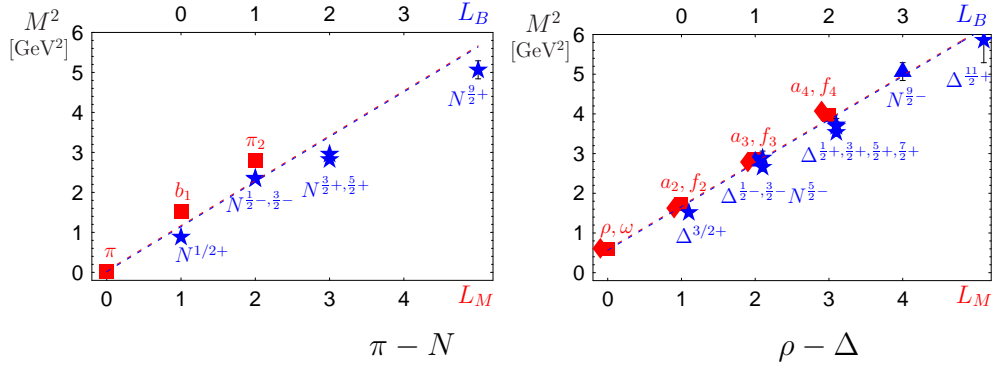
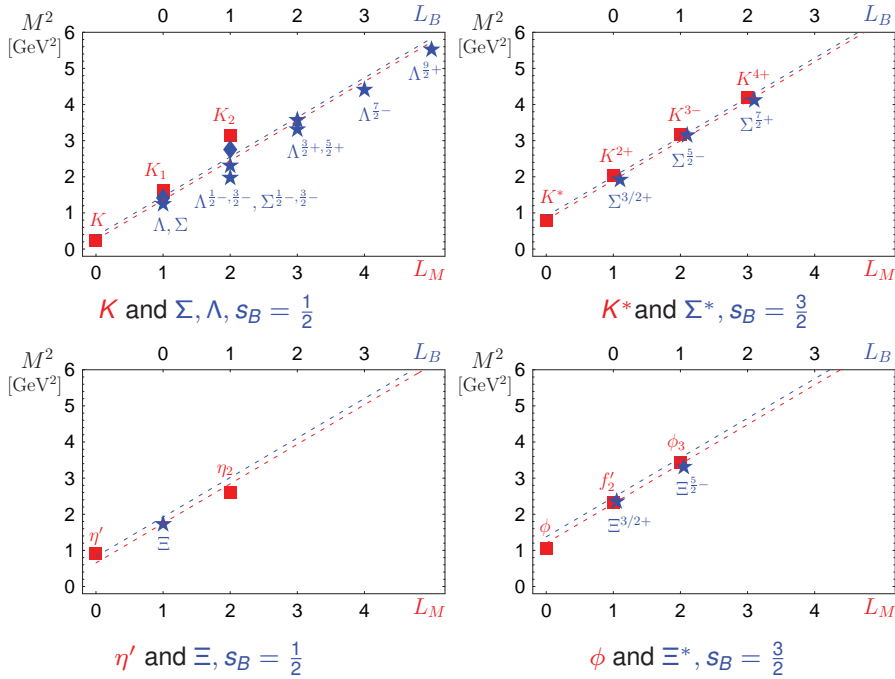

Figure 5.1: Theoretical and experimental results for light hadrons. The dashed line is the result of supersymmetric LFHQCD, (5.46), (without mass corrections), the red boxes denote the mesons, the blue stars the baryons, adapted from [25].



$\Omega^-(1672)$ theo: 1760 MeV (+5%)

Figure 5.2: Theoretical and experimental results for hadrons containing one or two strange quarks. The dashed lines are the result of supersymmetric LFHQCD, (5.46), (including mass corrections), the red boxes denote the mesons, the blue stars and diamonds the baryons, adapted from [25].

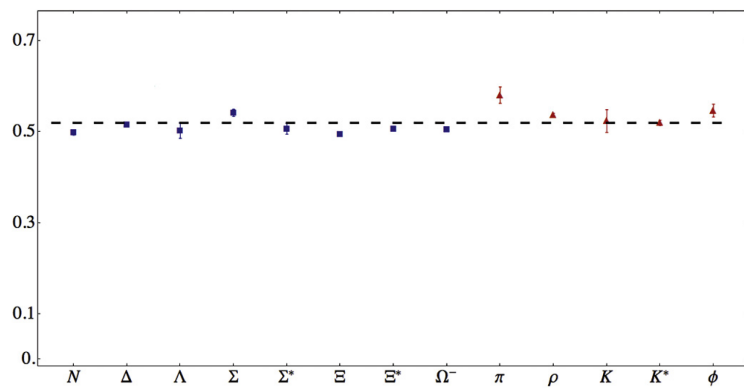

Figure 5.3: The scale parameter λ determined for the different trajectories separately. Indicated at the abscissa are the lowest ($L = 0$) states of the trajectory.

5.2.6 Completing the supersymmetric multiplet - Tetraquarks

Up to now we have only considered the supermultiplet of a meson and the positive chirality component of the baryon, Ψ^+ . The negative chirality component must also have a superpartner in order to complete the supersymmetric multiplet. The supercharge R_λ^\dagger transforms a meson wave function with LF angular momentum $L_B + 1$ into a baryon wave function with angular momentum L_B , it decreases the angular momentum by one unit and changes the fermion number by 1, since it is a fermionic operator.

$$R^\dagger \begin{pmatrix} \phi_{L_B+1} \\ 0 \end{pmatrix} = \begin{pmatrix} 0 \\ \psi_{L_B}^+ \end{pmatrix} \quad (5.47)$$

We can form a doublet containing the negative chirality component of the baryon $\Psi_{L_B+1}^-$ (remember that the negative chirality component has an angular momentum one unit higher than the positive one, see (4.42)):

$$\begin{pmatrix} \tilde{\psi}_{L_B+1}^- \\ \phi_{L_B}^T \end{pmatrix} \quad (5.48)$$

where $\phi_{L_B}^T$ is a bosonic wave function with angular momentum L_B , and it must be in the same radial excitation state as the meson and the baryon. This is the only information we can draw from supersymmetric quantum mechanics, since it does not contain any information on the quark structure. One can only draw analog conclusions from the action of the operator R_λ^\dagger inside the first multiplet, where the quark interpretation is fixed in LFHQCD.

In the original multiplet $\begin{pmatrix} \phi_{L_B+1} \\ \psi_{L_B}^+ \end{pmatrix}$ the operator R_λ^\dagger has transformed a two-quark state into a three-quark state, that it is has increased the number of constituents by 1. The two-quark state could have colour 3 or 6, but it must be in a $\bar{3}$ colour state, since the baryon is a colour singlet. Therefore it is plausible to attribute to R_λ^\dagger in the quark configuration the property of transforming an antiquark state into a two-quark state in the same colour representation $\bar{3}$, or correspondingly the transformation of a quark into an two-antiquark state in the same colour 3 representation. From that we infer that R_λ^\dagger transforms a quark of the nucleon into an antiquark pair in colour 3 representation. Therefore we infer further that the superpartner of the negative chirality component of the baryon is a tetraquark state consisting of a two quark state in colour $\bar{3}$ representation and a two quark state in colour 3 representation. The previous considerations are graphically represented in Fig. 5.4.

The complete supersymmetric quadruplet can be arranged into a 2×2 matrix,

$$\begin{pmatrix} \phi_{L_B+1} & \psi_{L_B+1}^- \\ \psi_{L_B}^+ & \phi_{L_B}^T \end{pmatrix} \quad (5.49)$$

with

$$G \begin{pmatrix} \phi_{L_B+1} & \psi_{L_B+1}^- \\ \psi_{L_B}^+ & \phi_{L_B}^T \end{pmatrix} = M^2 \begin{pmatrix} \phi_{L_B+1} & \psi_{L_B+1}^- \\ \psi_{L_B}^+ & \phi_{L_B}^T \end{pmatrix} \quad (5.50)$$

It is important to note that the two-constituent clustering has only to be considered as a kinematical, but not as a dynamical grouping. We shall see later in treating the form factors that there is indeed no indication for a tightly bound diquark state. Therefore we must assume that there is no excitation of the two constituent cluster. The Pauli principle implies then that the two-constituent

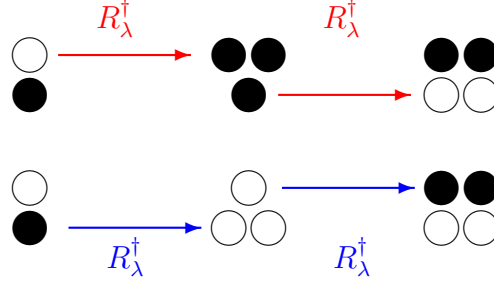

Figure 5.4: Since particles and antiparticles are in this semiclassical theory treated at the same footing, the fermionic operator R_λ^\dagger can be interpreted either as transforming a quark into an antiquark pair (red arrows) or an antiquark into a quark pair (blue arrows). In the transition from the meson to the nucleon the two-quark state has to be in the antisymmetric colour representation. It is natural to require this also in the transition from the nucleon to the tetraquark.

Table 5.1: Two candidates in the lowest possible angular momentum state.

Meson $I(J^P)$	Baryon $I(J^P)$	Tetraquark $I(J^P)$
$b_1(1235) 1(1^+)$	$N_{+,-}(940) \frac{1}{2}(\frac{1}{2}^+)$	$f_0(980) 0(0^+)$
$a_2(1320) 1(2^+)$	$\Delta_{+,-}(1230) \frac{3}{2}(\frac{3}{2}^+)$	$a_1(1260) 1(1^+)$

cluster must be in an Isospin $I = 1$ and total angular $J = 1$ state or an $I = 0, J = 0$ state, since it is antisymmetric in colour and must also be totally antisymmetric. If the clusters are in a relative S state, colour can rearrange and the $3\bar{3}$ state can change into a 00 state since

$$\sum_{i=1}^3 \epsilon_{ijk} \epsilon^{ilm} = \delta_j^\ell \delta_k^m - \delta_k^\ell \delta_j^m \quad (5.51)$$

This is a meson-molecule and can decay easily without further involvement of strong interactions. The status of tetraquarks is therefore rather uncertain, unless for some reason it is stable under strong interactions, when the decay threshold of the decay into to mesons is higher than he mass of the tetraquark. Also higher orbital expiations make the colour rearrangement more difficult, because of the spatial separations of the two clusters by the centrifugal barrier. We consider nevertheless in Table 5.1 two candidates for complete super-quadruplets in the lowest possible angular momentum state: Though the agreement - always in the limits of the expected accuracy - is very satisfactory, one should take into account that there are also conventional interpretations for the states listed in the table under tetraquarks. We therefore do not pretend that these states are pure tetraquark states, but that the tetraquark states should be taken into account if a detailed analysis of states with similar masses and the same quantum numbers is performed.

5.3 Implications of supersymmetry on Hadrons containing heavy quarks

This section is based on [25, 26].

We have seen in Fig. 5.2 that breaking of the conformal symmetry by small quark masses does not invalidate the principal results of superconformal LFHQCD, if the effect of the quark masses is taken into account perturbatively, see sects 4.5 and 5.2.4. In this section we investigate the inclusion of one heavy quark (c or b quark). The question is: Does the supersymmetric part of the superconformal algebra survive? The fact that supersymmetry played an essential role to fix the exact form of the potentials gives us some hope that it plays generally a fundamental role in the AdS/CFT correspondence and might even be present, if conformal symmetry is broken strongly by heavy quark masses.

5.3.1 The experimental situation

We have a look at the corresponding meson and baryon spectra where we plot both spectra in the same graph and use the relation that the meson LF angular momentum is by one unit larger than that of its baryonic partner, $L_M = L_B + 1$. The results, displayed in Fig. 5.5 and Fig. 5.6 show that supersymmetry is realized to a similar degree as for light quarks, and as far as one can see, there is even an indication for linear trajectories.

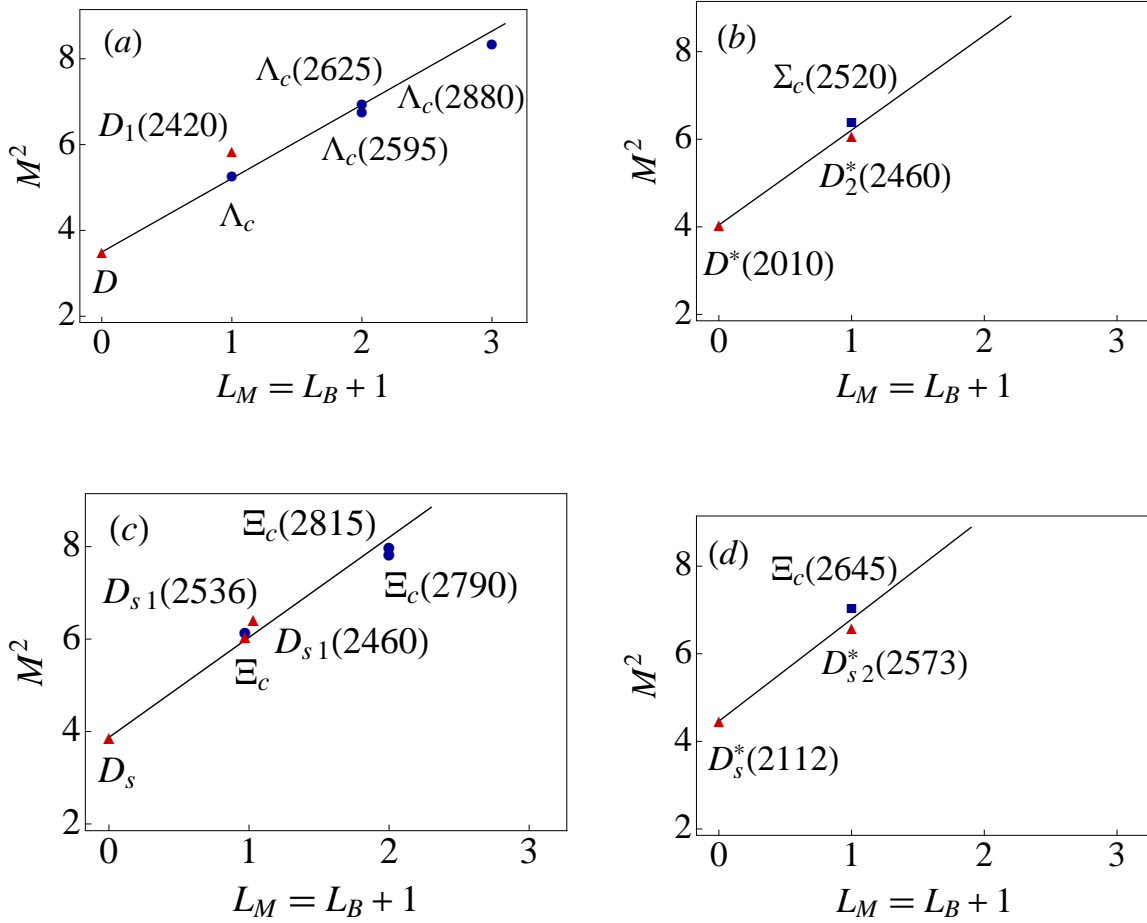

Figure 5.5: Supersymmetry for charmed hadrons.

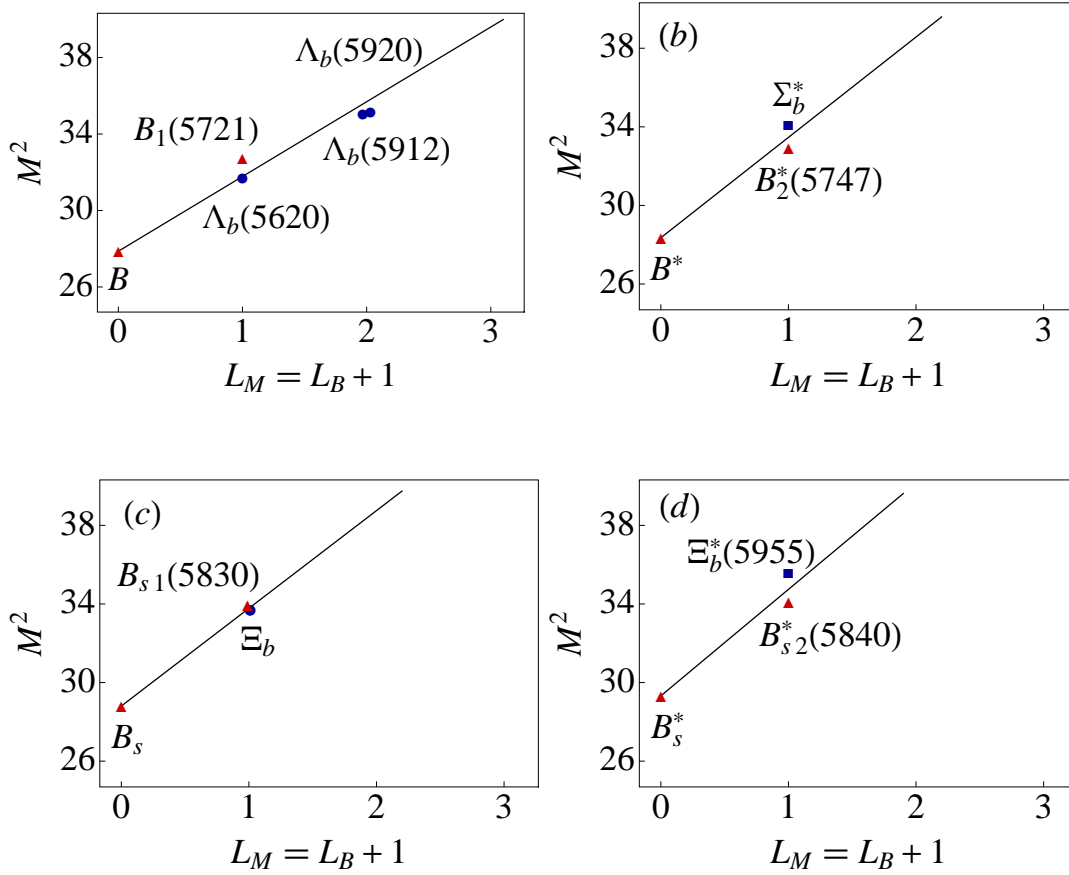

Figure 5.6: Supersymmetry for bottom hadrons.

5.3.2 Linear trajectories

In this subsection we show that linear trajectories are a consequence of supersymmetry, if one demands that in the AdS/CFT correspondence the modification of the action is realized by a dilaton term $e^{\varphi(z)}$, even if the functional form of $\varphi(z)$ is not fixed. We go back to supersymmetric quantum mechanics [29]. There the supercharge Q is

$$Q = \begin{pmatrix} 0 & q \\ 0 & 0 \end{pmatrix}, \quad Q^\dagger = \begin{pmatrix} 0 & 0 \\ q^\dagger & 0 \end{pmatrix}, \quad (5.52)$$

and

$$H_M = \begin{pmatrix} q q^\dagger & 0 \\ 0 & q^\dagger q \end{pmatrix}, \quad (5.53)$$

with

$$q = -\frac{d}{dz} + \frac{f}{z} + V(z), \quad (5.54)$$

$$q^\dagger = \frac{d}{dz} + \frac{f}{z} + V(z), \quad (5.55)$$

where f is a dimensionless constant. Without breaking supersymmetry one can add to the Hamiltonian (5.53) a constant term proportional to a multiple of the unit matrix, $\mu^2 I$

$$H_\mu = \{Q, Q^\dagger\} + \mu^2 I \quad (5.56)$$

where the constant μ has the dimension of a mass; thus we obtain the general supersymmetric light-front Hamiltonian

$$H_\mu = \begin{pmatrix} -\frac{d^2}{dz^2} + \frac{4L_M^2 - 1}{4z^2} + U_M(z) & 0 \\ 0 & -\frac{d^2}{dz^2} + \frac{4L_B^2 - 1}{4z^2} + U_B(z) \end{pmatrix} + \mu^2 \mathbf{I} \quad (5.57)$$

where $L_B + \frac{1}{2} = L_M - \frac{1}{2} = f$ and U_M is the meson potential for a meson with $J = L_M$ and U_B a baryon potential. They can be obtained from the Hamiltonian (5.53) in terms of the superpotential V .

$$U_M(z) = V^2(z) - V'(z) + \frac{2L_M - 1}{z} V(z), \quad (5.58)$$

$$U_B(z) = V^2(z) + V'(z) + \frac{2L_B + 1}{z} V(z). \quad (5.59)$$

The superpotential V is only constrained by the requirement that it is regular at the origin.

In LF holographic QCD the confinement potential for mesons U_M (5.58) is due to the dilaton term $e^{\varphi(x)}$ in the AdS₅ action, see (3.26). It leads to, see (4.18)

$$U_{\text{dil}}(z) = \frac{1}{4}(\varphi'(z))^2 + \frac{1}{2}\varphi''(z) + \frac{2L_M - 3}{2z}\varphi'(z) \quad (5.60)$$

for $J_M = L_M$. In the conformal limit the potential is harmonic and this is only compatible with a quadratic dilaton profile, $\varphi = \lambda z^2$.

But since heavy quark masses break superconformal symmetry strongly, the quadratic form $\varphi = \lambda z^2$ cannot longer be derived from symmetry arguments as in section 5.2.3. Additional constraints do appear, however, by the holographic embedding of supersymmetry. To see that, we equate the potential (5.60), given in terms of the dilaton profile φ , with the meson potential (5.58) written in terms of the superpotential V :

$$\frac{1}{4}(\varphi')^2 + \frac{1}{2}\varphi'' + \frac{2L-1}{2z}\varphi' = V^2 - V' + \frac{2L+1}{z}V, \quad (5.61)$$

where $L = L_M - 1$.

A simple calculation shows that for the ansatz $\varphi(z) = \lambda z^n$ only the power $n = 2$ is compatible with (5.61). Therefore we make the ansatz:

$$\varphi'(z) = 2\lambda z \alpha(z), \quad (5.62)$$

$$V(z) = \lambda z \beta(z). \quad (5.63)$$

Then we obtain from (5.61)

$$\lambda^2 z^2 (\alpha^2 - \beta^2) + 2L\lambda(\alpha - \beta) + \lambda z(\alpha' + \beta') = 0. \quad (5.64)$$

Introducing the linear combination

$$\begin{aligned} \sigma(z) &= \alpha(z) + \beta(z), \\ \delta(z) &= \alpha(z) - \beta(z), \end{aligned} \quad (5.65)$$

(5.64) yields

$$\delta(z) = -\frac{\lambda z \sigma'(z)}{\lambda^2 z^2 \sigma(z) + 2L\lambda}, \quad (5.66)$$

and therefore:

$$\alpha(z) = \frac{1}{2} \left(\sigma(z) - \frac{\lambda z \sigma'(z)}{\lambda^2 z^2 \sigma(z) + 2L\lambda} \right), \quad (5.67)$$

$$\beta(z) = \frac{1}{2} \left(\sigma(z) + \frac{\lambda z \sigma'(z)}{\lambda^2 z^2 \sigma(z) + 2L\lambda} \right). \quad (5.68)$$

Using (5.62) and (5.67) we obtain after an integration the condition for a dilaton profile for a meson with angular momentum $L_M = L + 1$

$$\varphi(z) = \int^z dz' \left(\lambda z' \sigma(z') - \frac{\lambda^2 z'^2 \sigma'(z')}{\lambda^2 z'^2 \sigma(z') + 2(L_M - 1)\lambda} \right). \quad (5.69)$$

The modification of the general AdS action should be independent of the angular momentum of a peculiar state, that is we must have $\sigma'(z) = 0$ thus

$$\sigma(z) = A \quad \text{with } A \text{ an arbitrary constant.} \quad (5.70)$$

From (5.69) and (5.62) it follows that

$$\varphi(z) = \frac{1}{2}\lambda A z^2 + B, \quad (5.71)$$

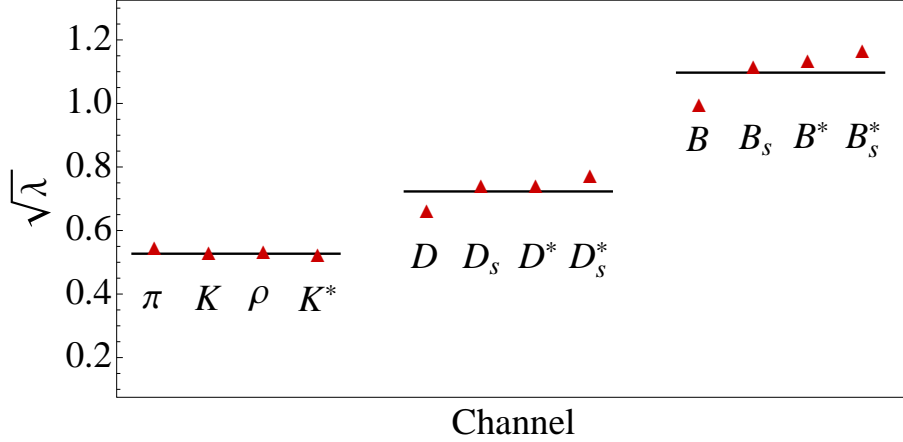

Figure 5.7: The fitted value of $\sqrt{\lambda_Q}$ for different meson-baryon trajectories, indicated by the lowest meson state on that trajectory.

and

$$\alpha = \beta = \frac{1}{2}\sigma = \frac{1}{2}A \quad (5.72)$$

from which follows:

$$V(z) = \frac{1}{2}\lambda A z \quad (5.73)$$

This result implies that the LF potential even for strongly broken conformal invariance has the same quadratic form as the one dictated by the conformal algebra. The constant A , however, is arbitrary, so the strength of the potential is not determined. Notice that the interaction potential (5.60) is unchanged by adding a constant to the dilaton profile, thus we can set $B = 0$ in (5.71) without modifying the equations of motion.

The LF eigenvalue equation $H|\phi\rangle = M^2|\phi\rangle$ from the supersymmetric Hamiltonian (5.57) leads to the hadronic spectrum

$$\begin{aligned} \text{Mesons:} & \quad M^2 = 4\lambda_Q (n + L_M) + \mu^2, \\ \text{Baryons:} & \quad M^2 = 4\lambda_Q (n + L_B + 1) + \mu^2, \end{aligned} \quad (5.74)$$

here L_M and L_B are the LF angular momenta of the meson and baryon respectively, the slope constant $\lambda_Q = \frac{1}{2}\lambda A$ can depend on the mass of the heavy quark. The constant term μ contains the effects of spin coupling and quark masses.

The fitted values of the slopes λ for the different channels are shown in Fig. 5.7. There is no perfect agreement between different channels, but distinctly 3 groups are observed for the conformal case, for the c -channel, and for the b -channel. In tables 5.2 and 5.3 results and predictions of the model are shown together with the deviation ΔM between theory and experiment, which is typically $\Delta M < \sim 100 \text{MeV}$.

Table 5.2: Charmed Hadrons. The quark spin s is the total quark spin of the meson or the diquark cluster, λ_Q is the fitted value for the trajectory and ΔM is the difference between the observed and the theoretical value according to (5.74). The lowest lowest lying meson mass determines the value of μ^2 in (5.74) for each trajectory. We have added predictions, if only one superpartner has been observed and for $L_M \leq 2$, $L_B \leq 1$.

status	particle	$I(J^P)$	quark content	s	n, L	$\sqrt{\lambda_Q}$ [GeV]	ΔM [MeV]
obs	$D(1869)$	$\frac{1}{2}(0^-)$	$c\bar{q}$	0	0, 0	0.655	0
obs	$D_1(2400)$	$\frac{1}{2}(1^+)$	$c\bar{q}$	0	0, 1	0.655	139
obs	$\Lambda_c(2286)$	$0(\frac{1}{2}^+)$	cqq	0	0, 0	0.655	4
obs	$\Lambda_c(2595)$	$0(\frac{1}{2}^-)$	cqq	0	0, 1	0.655	-36
obs	$\Lambda_c(2625)$	$0(\frac{3}{2}^-)$	cqq	0	0, 1	0.655	-6
obs	$\Lambda_c(2880)$	$0(\frac{5}{2}^+)$	cqq	0	0, 2	0.655	-59
pred	$D_2(2630)$	$\frac{1}{2}(2^-)$	$c\bar{q}$	0	0, 2	0.655	?
pred	$D_2(2940)$	$\frac{1}{2}(3^+)$	$c\bar{q}$	0	0, 3	0.655	?
obs	$D^*(2007)$	$\frac{1}{2}(1^-)$	$c\bar{q}$	1	0, 0	0.736	0
obs	$D_2^*(2460)$	$\frac{1}{2}(2^+)$	$c\bar{q}$	1	0, 1	0.736	-29
obs	$\Sigma_c(2520)$	$1(\frac{3}{2}^+)$	cqq	1	0, 0	0.736	28
pred	$D_3^*(2890)$	$\frac{1}{2}(3^-)$	$c\bar{q}$	1	0, 2	0.736	?
pred	$\Sigma_c(2890)$	$1(\frac{5}{2}^-)$	cqq	1	0, 1	0.736	?
pred	$\Sigma_c(2890)$	$1(\frac{3}{2}^-)$	cqq	1	0, 1	0.736	?
pred	$\Sigma_c(2890)$	$1(\frac{1}{2}^-)$	cqq	1	0, 1	0.736	?
obs	$D_s(1958)$	$0(0^-)$	$c\bar{s}$	0	0, 0	0.735	0
obs	$D_{s1}(2460)$	$0(1^+)$	$c\bar{s}$	0	0, 1	0.735	23
obs	$D_{s1}(2536)$	$0(1^+)$	$c\bar{s}$	0	0, 1	0.735	73
obs	$\Xi_c(2467)$	$\frac{1}{2}(\frac{1}{2}^+)$	csq	0	0, 0	0.735	31
obs	$\Xi_c(2575)$	$\frac{1}{2}(\frac{1}{2}^+)$	csq	0	0, 0	0.735	113
obs	$\Xi_c(2790)$	$\frac{1}{2}(\frac{1}{2}^-)$	csq	0	0, 1	0.735	-67
obs	$\Xi_c(2815)$	$\frac{1}{2}(\frac{3}{2}^-)$	csq	0	0, 1	0.735	-41
pred	$D_{s2}(2856)$	$0(2^-)$	$c\bar{s}$	0	0, 2	0.735	?
obs	$D_s^*(2112)$	$0(1^-)?$	$c\bar{s}$	1	0, 0	0.766	0
obs	$D_{s2}^*(2573)$	$0(2^+)?$	$c\bar{s}$	1	0, 1	0.766	-29
obs	$\Xi_c(2646)$	$\frac{1}{2}(\frac{3}{2}^+)$	csq	1	0, 0	0.766	28
obs	$D_{s3}^*(3030)$	$0(3^-)?$	$c\bar{s}$	1	0, 2	0.766	0
pred	$\Xi_c(3030)$	$\frac{1}{2}(\frac{5}{2}^-)$	csq	1	0, 1	0.766	?
pred	$\Xi_c(3030)$	$\frac{1}{2}(\frac{3}{2}^-)$	csq	1	0, 1	0.766	?
pred	$\Xi_c(3030)$	$\frac{1}{2}(\frac{1}{2}^-)$	csq	1	0, 1	0.766	?

Table 5.3: Bottom Hadrons. The notation is the same as for Table. 5.2.

status	particle	$I(J^P)$	quark content	spin	n, L	$\sqrt{\lambda_Q}$ [GeV]	ΔM [MeV]
obs	$B(5279)$	$\frac{1}{2}(0^-)$	$b\bar{q}$	0	0, 0	0.963	0
obs	$B_1(5721)$	$\frac{1}{2}(1^+)$	$b\bar{q}$	0	0, 1	0.963	101
obs	$\Lambda_b(5620)$	$0(\frac{1}{2}^+)$	bqq	0	0, 0	0.963	1
obs	$\Lambda_b(5912)$	$0(\frac{1}{2}^-)$	bqq	0	0, 1	0.963	-28
obs	$\Lambda_c(5920)$	$0(\frac{3}{2}^-)$	bqq	0	0, 1	0.963	-20
pred	$B_2(5940)$	$\frac{1}{2}(2^-)$	$c\bar{q}$	0	0, 2	0.963	?
obs	$B^*(5325)$	$\frac{1}{2}(1^-)$	$b\bar{q}$	1	0, 0	1.13	0
obs	$B_2^*(5747)$	$\frac{1}{2}(2^+)$	$b\bar{q}$	1	0, 1	1.13	-45
obs	$\Sigma_b^*(5833)$	$1(\frac{3}{2}^+)$	bqq	1	0, 0	1.13	44
pred	$B_3^*(6216)$	$\frac{1}{2}(3^-)$	$c\bar{q}$	1	0, 2	1.13	?
pred	$\Sigma_b(6216)$	$1(\frac{5}{2}^-)$	cqq	1	0, 1	1.13	?
pred	$\Sigma_b(6216)$	$1(\frac{3}{2}^-)$	cqq	1	0, 1	1.13	?
pred	$\Sigma_b(6216)$	$1(\frac{1}{2}^-)$	cqq	1	0, 1	1.13	?
obs	$B_s(5367)$	$0(0^-)$	$b\bar{s}$	0	0, 0	1.11	0
obs	$B_{s1}(5830)$	$0(1^+)$	$b\bar{s}$	0	0, 1	1.11	16
obs	$\Xi_b(5795)$	$\frac{1}{2}(\frac{1}{2}^+)$	bsq	0	0, 0	1.11	-16
pred	$B_{s2}(6224)$	$0(2^-)$	$b\bar{s}$	0	0, 2	1.11	?
pred	$\Xi_b(6224)$	$\frac{1}{2}(\frac{1}{2}^-)$	bsq	0	0, 1	1.11	?
pred	$\Xi_b(6224)$	$\frac{1}{2}(\frac{3}{2}^-)$	bsq	0	0, 1	1.11	?
obs	$B_s^*(5415)$	$0(1^-)?$	$b\bar{s}$	1	0, 0	1.16	0
obs	$B_{s2}^*(5840)$	$0(2^+)?$	$b\bar{s}$	1	0, 1	1.16	-55
obs	$\Xi_b(5945)$	$\frac{1}{2}(\frac{3}{2}^+)$	bsq	1	0, 0	1.16	55
pred	$B_{s3}^*(6337)$	$0(3^-)?$	$b\bar{s}$	1	0, 2	1.16	?
pred	$\Xi_b(6337)$	$\frac{1}{2}(\frac{5}{2}^-)$	bsq	1	0, 1	1.16	?
pred	$\Xi_b(6337)$	$\frac{1}{2}(\frac{3}{2}^-)$	bsq	1	0, 1	1.16	?
pred	$\Xi_b(6337)$	$\frac{1}{2}(\frac{1}{2}^-)$	bsq	1	0, 1	1.16	?

5.3.3 Consequences of heavy quark symmetry (HQS)

The decay constant f_M of a meson is the coupling of the hadron to its current. For the pion the decay constant f_π is defined as:

$$\langle 0 | A_\mu | \pi(p) \rangle = i p_\mu f_\pi, \quad (5.75)$$

where A_μ is the axial vector current. In a bound state model for mesons it is related to the value of the LF wave function at the origin [5].

$$f_M = \sqrt{\frac{2N_C}{\pi}} \int_0^1 dx \phi^{LF}(x, \mathbf{b}_\perp = 0). \quad (5.76)$$

which is identical with the result first obtained by van Royen and Weisskopf [32].

It has been known for a long time [33], and has been formally proved in HQET [34], that for the masses of heavy mesons with mass M_M and a decay constant f_M the product $\sqrt{M_M} f_M$ approaches, up to logarithmic terms, a finite value

$$\sqrt{M_M} f_M \rightarrow C. \quad (5.77)$$

The wave function and hence f_M depends on the scale λ_Q and so we can, by (5.77) relate the scale with the heavy quark mass (in the limit of large masses the hadron mass equals the quark mass). We shall here not go into details of the calculation but just quote the result of the analysis in [26] The dependence of f_M on the scale λ_Q and the quark mass m_Q comes out to be

$$f_M \sim \frac{\lambda_Q^{3/2}}{m_Q^2} \quad (5.78)$$

From that and (5.77) we obtain:

$$\sqrt{\lambda_Q} \sim \sqrt{m_Q}. \quad (5.79)$$

In the limit of heavy quarks the meson mass M_M equals the quark mass m_Q : $M_M = m_Q$ and therefore

$$\sqrt{\lambda_Q} \sim \sqrt{M_M} \quad (5.80)$$

This corroborates our statement that the increase of λ_Q with increasing quark mass is dynamically necessary. In Fig. 5.8 we show the value of λ_Q for the π , K , D , and B meson as function of the meson mass M_M . For the light quarks we are of course far away from the heavy quark limit result (5.80), but it is remarkable that the simple functional dependence (5.80) derived in the heavy quark limit predicts for the c quark a value $\sqrt{\lambda_c} = 0.653$ – after fixing the proportionality constant in (5.80) at the B meson mass – which is indeed at the lower edge of the values obtained from the fit to the trajectories (0.655 to 0.766).

5.4 Extension to two heavy quarks

The extension of the meson baryon supersymmetry to hadrons containing two heavy quarks is very speculative and can by no means be inferred from the results of the previous investigations. A system

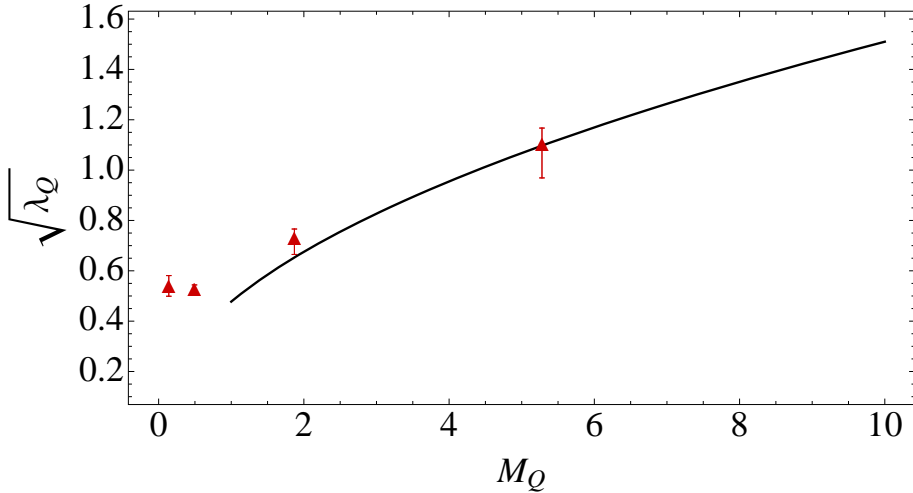

Figure 5.8: The fitted value of λ_Q vs. the meson mass M_M . The solid line is the square root dependence (5.80) predicted by HQET.

consisting of two light quarks and one consisting of a light and a heavy quark are both ultra-relativistic, whereas a system consisting of two heavy quarks is closer to nonrelativistic dynamics. Therefore the statements made in this subsection are taken only as propositions worth testing, but not as predictions of the model.

The most obvious consequence of supersymmetry in this double-heavy sector is the existence of double charmed baryon states Ξ_{cc} with a mass of approximately 3550 GeV, that is approximately the same mass [27] as the mesons $h_c(1P)(3525)$ and the $\chi_{c2}(1P)(3556)$. Indeed a weakly decaying doubly charmed baryon has been found at LHCb [35] with a mass of 3614 GeV, within the expected accuracy very well compatible with the that of the expected superpartner $h_c(1P)(3525)$ or $\chi_{c2}(1P)(3556)$. This gives some weight to the prediction of a double-bottom baryon Ξ_{bb} with a mass of ca 9900 MeV, that of the mesonic superpartners $h_b(1P)(9899)$ or $\chi_{c2}(1P)(9912)$. Since one expects P-wave excitations of the $B_c(6276)$ at ≈ 6300 MeV, supersymmetry applied to this sector does predict Ξ_{bc} states at ≈ 6300 MeV.

5.4.1 Completing the supermultiplet in the heavy hadron sector

In sect. 5.2.6 we have seen that the supersymmetric partner of the negative chirality component of the baryon is naturally interpreted as a tetraquark. We shall not repeat all the arguments brought there in favour of that interpretation. We shall only focus on the new situation which occurs if one or two quarks are heavy and therefore the constituents cannot be treated on equal footing. The situation is graphically represented in Fig. 5.9. In A) we show the situation discussed in sect. 5.2.6, in B) the situation where one quark is heavy, it is not essentially different from A). A new element comes in for the case of two heavy quarks, displayed under C). Here we can construct a tetraquark with hidden charm or beauty, or one with double open charm or beauty. The latter case is very interesting, since the predicted double charmed or double-bottom tetraquarks could be stable against strong interactions. Their expected mass, which is equal to that of the $L = 1$

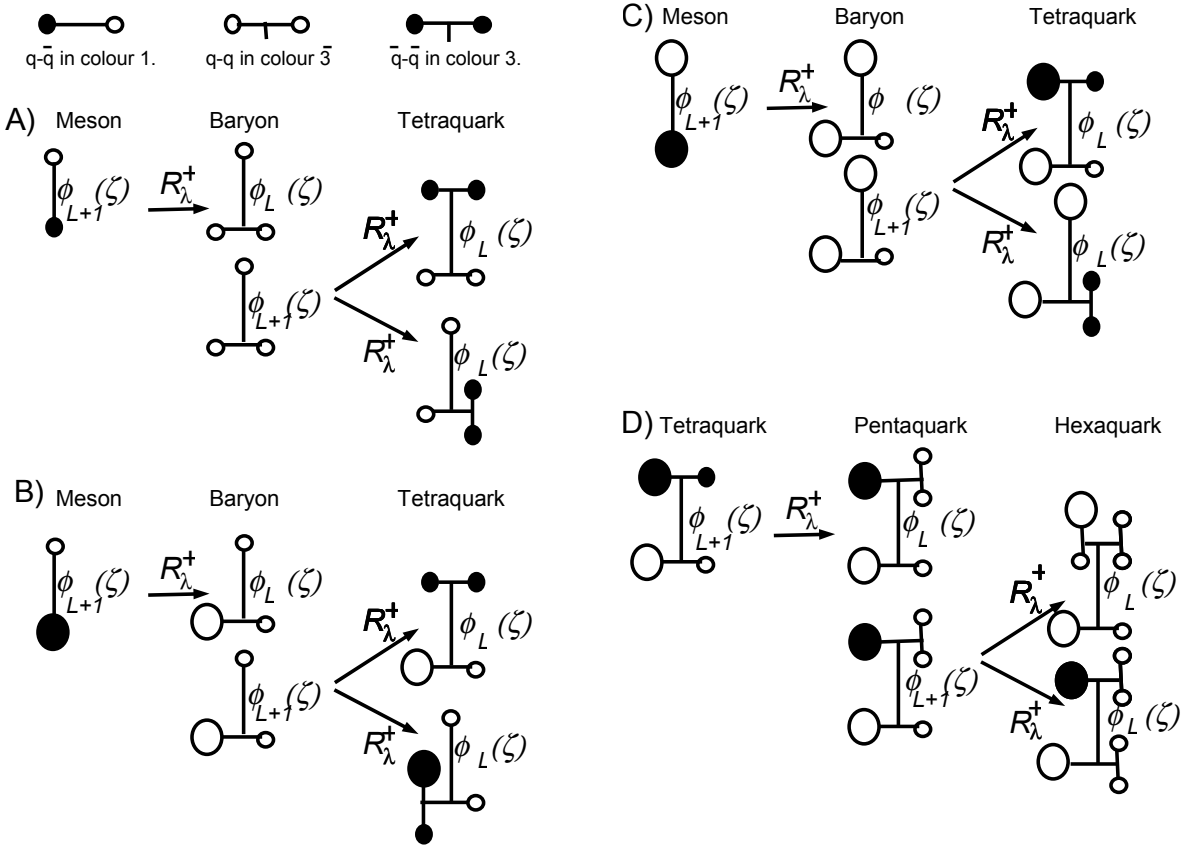

Figure 5.9: The supersymmetric multiplets in SUSY LFHQCD. Open circles denote quarks, filled circles antiquarks, small circles light quarks, large circles heavy quarks. The supercharge R_λ^\dagger , (5.28), changes the fermion number by ± 1 and lowers the angular momentum of the wave function by one unit. A) and B) depict the case with none or one heavy quark, C) the case with two heavy quarks; in that case either a light quark is transformed into a light antiquark pair, or a heavy quark into a heavy antiquark pair. In D) a possible scenario is indicated, where the lowest member of a multiplet is a tetraquark, from which a penta- and hexa-quark can be constructed. A quark and an antiquark connected by a straight line are in a colour singlet state; two quarks or two antiquarks connected by a line with intersection are in a colour $\bar{3}$ or 3 representation, respectively.

mesons, would be below the threshold of a decay into two mesons with open charm or beauty. The main argument against the observation of tetraquarks, namely the easy hadronization, is in these cases not applicable. Such a situation has also been predicted for a double-bottom tetraquark by Karliner and Rosner [36].

5.5 Summary

If one imposes superconformal symmetry, more precisely expressed: if one demands that the generalized LF Hamiltonian is constructed from the generators of the (graded) superconformal algebra, all the problems mentioned in the summary of the last chapter are resolved. The LF potentials for mesons and baryons are unequivocally determined and we predict supermultiplets consisting of a meson with angular momentum L_M , a baryon with angular momentum $L_B = L_M - 1$, and a bosonic state, which is plausibly interpreted as tetraquark, with angular momentum L_B ; the scale parameter λ is the same for mesons and baryons. The relations in the meson-baryon sector, encoded in the mass formulae (5.46) are satisfied by the data within the expected accuracy of ≈ 100 MeV, see Figs. 5.1 and 5.2. Supersymmetry is also satisfied for hadrons containing one heavy quark and perhaps even for hadrons with two heavy quarks, see sect. 5.3. Combining the conditions of supersymmetry with those of AdS one concludes that also hadrons containing a heavy quark lie on linear trajectories, see sect. 5.3.2, Fig. 5.5 and 5.6. Heavy quark symmetry allows to estimate the relation between the λ -value for a system containing a c -quark and that for a system containing a b -quark, see Fig. 5.8. We again emphasize that the supersymmetry relates wave functions of observed mesons and observed baryons. There is no need nor motivation to introduce new particles like squarks or gluinos.

Chapter 6

The propagator from AdS

6.1 The two point function in Holographic QCD

6.1.1 The generating functional

As shortly mentioned in the introduction, the generating functional (partition function in statistical mechanics) allows to calculate all possible matrix elements and therefore all possible observables.

The generating functional for a quantum field ϕ is defined as

$$Z[j] = \int \mathcal{D}\phi e^{i \int dx j(x) \phi(x)} e^{iS[\phi]} \quad (6.1)$$

Here $S[\phi]$ is the AdS action and $\mathcal{D}\phi$ denotes the functional integration over all fields ϕ .

Unfortunately the functional integration can be performed analytically only for a Gaussian integrand. This is the basis for perturbation theory, but for more general cases ones has to use numerical methods (lattice calculations).

From the generating functional one can obtain all n-point functions by functional derivation. The latter – in contrast to functional integration – is elementary and can in general be performed analytically. Functional derivatives occur also in classical field theory, for instance for the derivation of the classical equations of motion, see Chapt. 3.1. Indeed one can often ignore that a derivative is a functional derivative. One considers the function, after which is derived, as a variable and use the rules of ordinary differentiation.

The expression for the n-point function is:

$$\langle \mathcal{T} \phi(x) \phi(y) \phi(z) \dots \rangle = (-i)^n \left[\left(\frac{\delta}{\delta j(x)} \frac{\delta}{\delta j(y)} \frac{\delta}{\delta j(z)} \dots \right) Z[j] \right]_{/j=0} \quad (6.2)$$

Normally we are interested only in the connected n-point functions, corresponding to connected Feynman diagrams. These are obtained from functional differentiation of the connected generating

functional $W[j]$ which is the logarithm of $Z[j]$:

$$W[j] = \log Z[j]. \quad (6.3)$$

Ads/CFT allows to calculate the generating functional of the full quantum field theory (in the $N_c \rightarrow \infty$ limit) by solving the classical equations of motion of the 5-dimensional gravitational theory [9, 10]. One has to insert the classical solution, $\phi(x, z = \epsilon)$ into the action and perform the limit $\epsilon \rightarrow 0$.

$$W[j] = i \lim_{\epsilon \rightarrow 0} S[\phi_{cl}] / \lim_{\epsilon \rightarrow 0} \phi_{cl}(\epsilon) = j \quad (6.4)$$

This essentially states that in the functional integral (6.1) only the fields which minimize the action, that is the classical solutions, contribute. We cannot insert directly the classical solution at $z = 0$ into (6.4) since it contains infinities, as it is to be expected in a quantum field theory. We have to insert the classical solution evaluated a finite value $z = \epsilon$ and the limit $\epsilon \rightarrow 0$ corresponds to the renormalization procedure. Generally it can be performed analytically as we shall see later.

6.1.2 The classical action

The classical action for mesons with arbitrary spin is (see sect. 4.2, (4.12))

$$S_{eff} = \int d^d x dz \sqrt{g} e^{\varphi(z)} g^{N_1 N'_1} \dots g^{N_J N'_J} \left(g^{MM'} D_M \Phi_{N_1 \dots N_J}^* D_{M'} \Phi_{N'_1 \dots N'_J} - \mu_{eff}^2(z) \Phi_{N_1 \dots N_J}^* \Phi_{N'_1 \dots N'_J} \right). \quad (6.5)$$

The covariant derivatives D_M of higher rank tensors are very complicated (see sect. 3.1.2, footnote 1) but, as has been shown in [21], it turns out, that in the end one can largely ignore the complications and work as if the covariant derivatives were usual partial derivatives.

We proceed in the usual way,

1) we Fourier transform the solution of the Euler-Lagrange equations over the 4 Minkowski variables:

$$\tilde{\Phi}_{N_1 \dots N_J}(q, z) = \int d^4 x e^{-iqx} \Phi_{N'_1 \dots N'_J}(x, z)$$

2) we extract the spin content into a spin tensor:

$\tilde{\Phi}(q, z) = \varepsilon_{N_1 \dots N_J} \tilde{\Phi}(q, z)$ where the spin tensor is totally symmetric in all indices and fulfills the conditions:

$$q^{N_1} \varepsilon_{N_1 \dots N_J}(q) = 0, \quad \eta^{N_1 N_2} \varepsilon_{N_1 N_2 \dots N_J}(q) = 0 \quad (6.6)$$

For the classical solutions in the 4 dimensional space (i.e. $z = 0$) we have $\varepsilon_{5, N_2, \dots, N_J} = 0$, that is the polarization tensor vanishes if at least one of the indices $N_i = 5$. The factors in the integrand of (6.5) are $\sqrt{g} = \left(\frac{R}{z}\right)^5$, $g^{N_1 N'_1} = \left(\frac{z}{R}\right)^2 \eta^{N_1 N'_1}$ and we obtain from (6.5):

$$S = \int \frac{d^4 q}{(2\pi)^4} S(q) \quad (6.7)$$

with

$$S(q) = X_{spin} \int_{\epsilon}^{\infty} dz \left(\frac{R}{z}\right)^{3-2J} e^{\varphi(z)} \left[-\partial_z \tilde{\Phi}^* \partial_z \tilde{\Phi} - \left(-q^2 + \frac{(\mu R)^2}{z^2} \right) \tilde{\Phi}^* \tilde{\Phi} \right] \quad (6.8)$$

With the spin term

$$X_{spin} = \sigma^{\nu_1 \dots \nu_J, \nu'_1 \dots \nu'_J} \epsilon_{\nu_1 \dots \nu_J} \epsilon_{\nu'_1 \dots \nu'_J} \quad (6.9)$$

The term $\sigma^{\nu_1 \dots \nu_J, \nu'_1 \dots \nu'_J}$ is due to the conditions (6.6). For $J = 1$ it is

$$\sigma^{\nu\nu'} = \eta^{\nu\nu'} - \frac{q^\nu q^{\nu'}}{q^2} \quad (6.10)$$

We abbreviate:

$$A(z) = \left(\frac{R}{z}\right)^{3-2J} e^{\varphi(z)}; \quad B(z) = \left(-q^2 + \frac{(\mu R)^2}{z^2}\right) \quad (6.11)$$

then the the action reads:

$$S(q) = X_{spin} \int_{\epsilon}^{\infty} dz \left(-A(z) \partial_z \tilde{\Phi}^* \partial_z \tilde{\Phi} - B(z) A(z) \tilde{\Phi}^* \tilde{\Phi} \right) \quad (6.12)$$

The Euler Lagrange equations, of which the classical field $\tilde{\Phi}_{cl}$ is a solution, are

$$\partial_z \frac{\partial \mathcal{L}}{\partial (\partial_z \tilde{\Phi}^*)} = \frac{\partial \mathcal{L}}{\partial \tilde{\Phi}^*} \quad (6.13)$$

For solutions of the Euler Lagrange equations, that is the classical solutions $\tilde{\Phi}_{cl}(q, z)$ we have therefore

$$-\partial_z \left(A \partial_z \tilde{\Phi}_{cl} \right) = -AB \tilde{\Phi}_{cl} \quad (6.14)$$

We perform a partial integration for the first term of (6.12):

$$-\int_{\epsilon}^{\infty} dz A(z) \partial_z \tilde{\Phi}^* \partial_z \tilde{\Phi} = \int_{\epsilon}^{\infty} dz \tilde{\Phi}^* \partial_z (A \partial_z \tilde{\Phi}) - \left[\tilde{\Phi}^* A \partial_z \tilde{\Phi} \right]_{\epsilon}^{\infty} \quad (6.15)$$

Inserting (6.14) into (6.12) we obtain:

$$S(q) = \int_{\epsilon}^{\infty} dz \tilde{\Phi}_{cl}^* (AB - AB) \tilde{\Phi}_{cl} - \left[\tilde{\Phi}_{cl}^* A \partial_z \tilde{\Phi}_{cl} \right]_{\epsilon}^{\infty} \quad (6.16)$$

The classical action is therefore reduced to a surface term.

Collecting everything we we obtain for the full action with the classical solution inserted:

$$S[\tilde{\Phi}_{cl}] = -X_{spin} \int \frac{d^4 q}{(2\pi)^4} \left[\left(\frac{R}{z}\right)^{3-2J} e^{\varphi(z)} \tilde{\Phi}_{cl}^*(q, z) \partial_z \tilde{\Phi}_{cl}(q, z) \right]_{\epsilon}^{\infty} \quad (6.17)$$

We consider, as usual in field theory, only solutions which vanish at $z \rightarrow \infty$ and therefore only the lower surface term contributes and we end up with

$$S[\tilde{\Phi}_{cl}] = X_{spin} \int \frac{d^4 q}{(2\pi)^4} \left[\left(\frac{R}{z}\right)^{3-2J} e^{\varphi(z)} \tilde{\Phi}_{cl}^*(q, z) \partial_z \tilde{\Phi}_{cl}(q, z) \right]_{z=\epsilon} \quad (6.18)$$

In order to fulfill the condition $\lim_{\epsilon \rightarrow 0} \phi_{cl}(q, \epsilon) = j(q)$ in (6.4) we choose the normalization

$$\tilde{\Phi}_{cl, \nu_1 \dots \nu_J}(q, z) = \frac{\tilde{\Phi}_{cl}(q, z)}{\tilde{\Phi}_{cl}(q, \epsilon)} j_{\nu_1 \dots \nu_J}(q) \quad (6.19)$$

So our final result is:

$$\begin{aligned}
W[j] &= i \lim_{\epsilon \rightarrow 0} S[\phi_{cl}] / \lim_{\epsilon \rightarrow 0} \phi_{cl}(\epsilon) = j \tag{6.20} \\
&= i \lim_{z \rightarrow \epsilon \rightarrow 0} \left[\sigma^{\nu_1 \dots \nu_J, \nu'_1 \dots \nu'_J} \times \right. \\
&\quad \left. \int \frac{d^4 q}{(2\pi)^4} \left(\frac{R}{z} \right)^{3-2J} e^{\varphi(z)} j^*(q)_{\nu_1 \dots \nu_J} \frac{\tilde{\Phi}_{cl}^*(q, z)}{\tilde{\Phi}_{cl}^*(q, \epsilon)} j(q)_{\nu'_1 \dots \nu'_J} \frac{\partial_z \tilde{\Phi}(q, z)}{\tilde{\Phi}(q, \epsilon)} \right] \\
&= i \sigma^{\nu_1 \dots \nu_J, \nu'_1 \dots \nu'_J} \int \frac{d^4 q}{(2\pi)^4} e^{\varphi(z)} j^*(q)_{\nu_1 \dots \nu_J} j(q)_{\nu'_1 \dots \nu'_J} \lim_{z \rightarrow \epsilon \rightarrow 0} \left(\frac{R}{z} \right)^{3-2J} \frac{\partial_z \tilde{\Phi}(q, z)}{\tilde{\Phi}(q, \epsilon)}
\end{aligned}$$

The connected two point function is given by

$$\begin{aligned}
\Sigma_{\nu_1 \dots \nu_J, \nu'_1 \dots \nu'_J}(q) &= (-i)^2 \frac{\delta}{\delta j_{\nu_1 \dots \nu_J}^*(q)} \frac{\delta}{\delta j_{\nu'_1 \dots \nu'_J}(q)} W[j] \\
&= \frac{-i}{(2\pi)^4} \sigma^{\nu_1 \nu'_1 \dots \nu_J \nu'_J} \left(\frac{R}{z} \right)^{3-2J} e^{\varphi(z)} \left(\frac{\partial_z \tilde{\Phi}(q, z)}{\tilde{\Phi}(q, \epsilon)} \right) \\
&= \frac{-i}{(2\pi)^4} \sigma^{\nu_1 \nu'_1 \dots \nu_J \nu'_J} \Sigma(q^2) \tag{6.21}
\end{aligned}$$

with

$$\Sigma(q^2) = \left(\frac{R}{\epsilon} \right)^{3-2J} e^{\varphi(\epsilon)} \left(\frac{\partial_z \tilde{\Phi}(q, \epsilon)}{\tilde{\Phi}(q, \epsilon)} \right) \tag{6.22}$$

It is always understood that $\epsilon \rightarrow 0$.

As to be expected in QFT there will be infinities occurring in the limit $\epsilon \rightarrow 0$. These have to be treated by some renormalization (this is not special to perturbation theory, but also has to be done in lattice regularization, e.g.). If the infinities are independent of q , they are not dynamically relevant and can be discarded. This will be done in the following.

6.2 Soft wall model

6.2.1 Solutions for soft wall model

Here we take $\varphi(z) = \lambda z^2$, that is the starting point is the same as in sect. 4.2. The Euler Lagrange equation for the Lagrangian (6.5) is:

$$\left[\partial_z^2 + \frac{1}{z} (2J - 3 + 2\lambda z^2) \partial_z + q^2 - \frac{(\mu R)^2}{z^2} \right] \tilde{\Phi}(q, z) = 0 \tag{6.23}$$

where in LFHQCD the AdS mass μ is related to the LF angular momentum L by (see (4.15))

$$L^2 = (\mu R)^2 + (J - 2)^2. \tag{6.24}$$

In sect. 4.2 we were interested in bound state solutions, which must be normalizable. This is only possible for discrete values of q^2 which led us to the hadronic spectra. If we give up the normalizability condition, we shall find a larger set of solutions for every value of q^2 .

Mathematica finds a rather complicated solution for (6.23). So it is better to rescale $\tilde{\Phi}$ and bring (6.5) into a form which has relatively simple and mathematically well investigated solutions.

A rather general and well investigated form for a differential equation with first and second order derivatives is Kummer's equation [38], 13.1.1:

$$y w''(y) + (b - y)w'(y) - a w = 0 \quad (6.25)$$

with well studied solutions. This form can be obtained from (6.23) by rescaling.

We rescale

$$\tilde{\Phi}(q, z) = z^\beta \tilde{\Phi}_n(q, z) \quad (6.26)$$

and obtain

$$\left[\partial_z^2 + \frac{1}{z}(2J - 3 + 2\beta + 2\lambda z^2)\partial_z + q^2 + C \right] \tilde{\Phi}_n(q, z) = 0 \quad (6.27)$$

where

$$C = \frac{\beta^2 + 2\beta(J - 2) - (\mu R)^2}{z^2} + 2\beta\lambda + q^2 \quad (6.28)$$

We can make the term $\sim 1/z^2$ vanish by choosing:

$$\beta = 2 + L - J, \quad L = \sqrt{(J - 2)^2 + (\mu R)^2} \quad (6.29)$$

We introduce the dimensionless variable

$$y = |\lambda|z^2 \quad (6.30)$$

and use: $\partial_z f(y) = \partial_y f(y)2|\lambda|z$, $\partial_z^2 f(y) = \partial_y^2 f(y)4\lambda^2 z^2 + \partial_y f(y)2|\lambda|$

Then we obtain with choice $\beta = 2 + L - J$ from (6.27) the differential equation:

$$y \partial_y^2 \tilde{\Phi}_n(q, y) + \left((L + 1) + \frac{\lambda}{|\lambda|} y \right) \partial_y \tilde{\Phi}_n(q, y) + \frac{1}{4|\lambda|} \left((4 - 2J + 2L)\lambda + q^2 \right) \tilde{\Phi}_n(q, y) = 0 \quad (6.31)$$

which has indeed the form of Kummer's equation (6.25)

The solutions of (6.25) which vanish for $z \rightarrow \infty$ are:

$$w(y) = U(a, b, y). \quad (6.32)$$

$U(a, b, y)$ is the hypergeometric function (HypergeometriU[a,b,y] in Mathematica).

For the case of a positive sign in front the the term $y w'(y)$ that is for the equation

$$y w''(y) + (b + y)w'(y) - a w = 0 \quad (6.33)$$

the solution is

$$w(y) = e^{-y} U(a + b, b, y) \quad (6.34)$$

The solution $\tilde{\Phi}(q, y)$ of (6.23) has thus the form:

$$\tilde{\Phi}(q, z) = \rho(z)U(a_\lambda, L + 1, |\lambda|z^2) \quad (6.35)$$

with $\rho(z) = z^{L-J+2}e^{-(|\lambda|+\lambda)z^2/2}$.

The constant a_λ depends on the sign of λ :

for $\lambda < 0$ we have (6.32) and from (6.31)

$$\begin{aligned} \lambda < 0 \quad a_\lambda &= -\frac{q^2}{4|\lambda|} - \frac{\lambda}{4|\lambda|}(4 - 2J + 2L) \\ &= -\frac{q^2}{4|\lambda|} + \frac{1}{4}(4 - 2J + 2L) \end{aligned} \quad (6.36)$$

for $\lambda > 0$ we have (6.34) and from (6.31)

$$\begin{aligned} \lambda > 0 \quad a_\lambda &= -\frac{q^2}{4|\lambda|} - \frac{\lambda}{4|\lambda|}(4 - 2J + 2L) + (L + 1) \\ &= -\frac{q^2}{4|\lambda|} + \frac{1}{4}(2J + 2L) \end{aligned} \quad (6.37)$$

6.2.2 The propagator for the conserved current in the holographic soft wall model

We use the general result (6.22) and insert (6.35) (omitting terms, which are 1 in the limit $\epsilon \rightarrow 0$).

$$\Sigma[q^2] = \left(\frac{R}{z}\right)^{3-2J} \partial_z[\log[\rho[z]U(a_\lambda, L + 1, \lambda z^2)]]_{/z \rightarrow \epsilon} \quad (6.38)$$

$$= \left(\frac{R}{z}\right)^{3-2J} \partial_z[\log[U(a_\lambda, L + 1, \lambda z^2)]]_{/z \rightarrow \epsilon} + \partial_z[\log[\rho[z]]]_{/z = \epsilon \rightarrow 0} \quad (6.39)$$

$$= \left(\frac{R}{z}\right)^{3-2J} \frac{U'(a_\lambda, L + 1, |\lambda|z^2) 2|\lambda|z}{U(a_\lambda, L + 1, |\lambda|z^2)}_{/z = \epsilon \rightarrow 0} + \text{non-dynamical terms} \quad (6.40)$$

where non-dynamical terms are (possibly infinite) terms which are independent of q .

We see that multiplying the solution (6.35) with a function $f(z)$ which is regular at $z = 0$ has no influence on the two point function.

In order to perform the limit $\epsilon \rightarrow 0$ we have to expand the ratio U'/U around $z = 0$. It is most transparent to use the identity ([38], 13.4.21)

$$U'(a, b, y) = -aU(a + 1, b + 1, y) \quad (6.41)$$

from which we get the final result[39, 2]:

$$\Sigma[q] = \left(\frac{R}{z}\right)^{3-2J} \frac{-a_\lambda U(a_\lambda + 1, L + 2, |\lambda|z^2) 2|\lambda|z}{U(a_\lambda, L + 1, |\lambda|z^2)}_{/z = \epsilon \rightarrow 0} \quad (6.42)$$

First we consider the AdS conserved vector current, i.e $J = 1$, $\mu = 0$; from $L^2 = (J - 2)^2 + (\mu R)^2$, see (6.29), follows that $L = 1$: Both for $\lambda > 0$ and $\lambda < 0$ we obtain:

$$a_\lambda = -\frac{q^2}{4|\lambda|} + 1 \tag{6.43}$$

We insert into mathematica, with $y = |\lambda|z^2$:

```
Simplify[ Series[a HypergeometricU[a + 1, 3, y]/HypergeometricU[a, 2,
y], {y, 0, 0}]]
```

The result is

$$\frac{1}{y} - (a - 1)(\psi^{(0)}(a) + \log(y) + 2\gamma) + O(y^1) \tag{6.44}$$

The function $\psi^{(0)}(x) = \partial_x \log(\Gamma[x])$ is a meromorphic function with poles at $x = 0, -1, -2 \dots$. It is called psi-function, Digamma function or Polygamma function with first argument 0, (Polygamma[0,x] in mathematica), we come later to it.

The first term is diverging, but independent of q^2 and therefore not dynamical, and we discard it. Putting pieces together we obtain:

$$\begin{aligned} \Sigma(q^2) &= -\frac{R}{z} (2|\lambda|z) \frac{q^2}{4|\lambda|} \left(\psi^{(0)}\left(-\frac{q^2}{4|\lambda|} + 1\right) + \log(|\lambda|z^2) \right) \Big|_{z=\epsilon} + \text{nondynamical terms} \\ &= -q^2 R \left(\frac{1}{2} \psi^{(0)}\left(-\frac{q^2}{4\lambda} + 1\right) + \log \epsilon \right) + \text{nondynamical terms} \end{aligned} \tag{6.45}$$

$q^2 \log \epsilon$ is an infinite subtraction term

Normally the factor q^2 is absorbed in the spin factor (6.10) of the propagator which then becomes $q^2 \eta^{\mu\nu} - q^\mu q^\nu$, we therefore obtain for the full vector current propagator, see (6.21), discarding all nondynamical terms:

$$\frac{2}{R} \Sigma_{\mu\nu}(q^2) = \frac{i}{(2\pi)^4} (q^2 \eta^{\mu\nu} - q^\mu q^\nu) \psi\left(-\frac{q^2}{4\lambda} + 1\right) \tag{6.46}$$

As mentioned above, the Digamma function has no cuts, but only poles, which correspond to the intermediate states of the two-point function.

6.2.3 Physical relevance of conserved current

The conserved current is a vector current ($J = 1$) and therefore it is natural to associate the poles in the Digamma function with the vector particles ($\rho(770), \rho(1450)$ etc.). This has indeed been assumed in the seminal paper of Karch, Katz, Son and Stephanov [18]. The scale λ is then related to M_ρ , the mass of the $\rho(770)$ by $M_\rho^2 = 4\lambda$. On the other hand the value of the slope $\frac{dM_\rho^2}{dJ}$ comes also out to be [18] 4λ . From Fig. 6.1 one sees that both assignments are not compatible with each

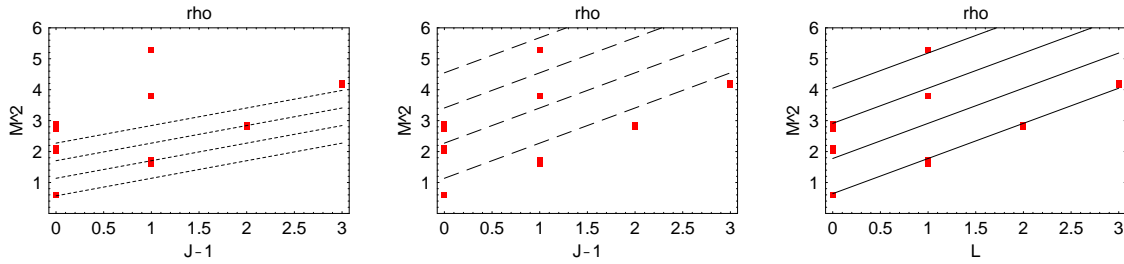

Figure 6.1: a) and b) The rho-trajectory from the conserved vector current ($J = L = 1$) with correct rho mass a) and with with correct slope c) , Fig. c the trajectories from LFHQCD, with $J = 1, L = 0$.

other. Either the mass of the rho comes out correctly and the slope is wrong, (6.1.a) or the slope is correct, and the mass comes out to large, (6.1.b). So this interpretation is not well compatible with the data.

In LFHQCD the ρ -field must have $J = 1, L = 0$, since it has parity 1^- . In that case the squared mass of the ρ is 2λ and the slope 4λ , see (4.29) or (5.46). As can be seen from Fig. 4.2, repeated as (6.1.c) the agreement with the data is in that case much better.

6.2.4 Propagators for other currents in LFHQCD

For the rho current with $J = 1, L = 0$ we have from 6.37:

$$a_\lambda = \frac{Q^2}{4|\lambda|} + \frac{1}{4}(2J + 2L) = \frac{Q^2}{4|\lambda|} + \frac{1}{2} \quad (6.47)$$

and we obtain for the propagator function (6.42)

$$\Sigma[q] = \left(\frac{R}{z}\right) \frac{a_\lambda U(a_\lambda + 1, 2, |\lambda|z^2) 2|\lambda|z}{U(a_\lambda, 1, |\lambda|z^2)} / z = \epsilon \rightarrow 0 \quad (6.48)$$

We again expand around $z = 0$ ($y = |\lambda|z^2$) with Mathematica

```
Simplify[ Series[a HypergeometricU[a + 1, 2, y]/HypergeometricU[a, 1, y], y, 0, 0]];
```

The result:

$$-\frac{1}{y(\psi^{(0)}(a) + \log(y) + 2\gamma)} + O[1] \quad (6.49)$$

Now the leading dynamical term is proportional to $1/y = 1/(|\lambda|z^2)$:

Putting pieces together we obtain:

$$\Sigma(q^2) = \left(\frac{R}{z}\right) \left(\frac{2|\lambda|z}{|\lambda|z^2(\psi(a) + \log(|\lambda|z^2) + 2\gamma^E)} + O(z) \right) \quad (6.50)$$

For $z \rightarrow 0$ the log diverges, therefore we expand the denominator

$$\frac{1}{|\lambda|z^2(\psi(a) + \log(\lambda z^2) + 2\gamma^E)} = \frac{1}{|\lambda|z^2 \log(|\lambda|z^2)} - \frac{\psi(a) + 2\gamma^E}{|\lambda|z^2 \log^2(|\lambda|z^2)} + O\left[\frac{1}{|\lambda|z^2 \log^3(|\lambda|z^2)}\right] \quad (6.51)$$

Taking into account only the leading dynamical term we arrive at [2]:

$$\frac{1}{R}\Sigma[Q^2] = \frac{2}{z^2 \log^2(|\lambda|z^2)}\psi\left(\frac{Q^2}{4|\lambda|} + \frac{1}{2}\right) \quad (6.52)$$

”Renormalizing” $\Sigma(Q^2)$ by the factor $\frac{1}{|\lambda|z^2 \log^2(z^2)}$ we obtain for the vector propagator the result:

$$\frac{1}{R}\Sigma_{\mu\nu}^{ren}[Q^2] = (\eta_{\mu\nu} - \frac{q_\mu q_\nu}{q^2})\psi\left(\frac{Q^2}{4|\lambda|} + \frac{1}{2}\right) \quad (6.53)$$

The pseudoscalar current can be obtained in the same way, it has also $L = 0$, but $J = 0$ therefore only a_λ and the prefactor $(\frac{R}{z})^{3-2J}$ change. The result for the renormalized propagator of the pseudoscalar current is:

$$\frac{1}{R^3}\Sigma^{ren}[Q^2] = \psi\left(\frac{Q^2}{4|\lambda|}\right) \quad (6.54)$$

6.2.5 Asymptotic expansion of the two-point function. Comparison with QCD sum rules.

We have now an explicit expression for the propagator. For comparison with other methods, most notably the QCD sum rule method [37], it is useful to consider an asymptotic expression for the exact result.

An **asymptotic expansion** (\sim) is defined as follows:

$$f(x) \sim \sum_{n=0}^N a_n x^n \quad \text{means} \quad f(x) - \sum_{n=0}^N a_n x^n = O(x^N)$$

The asymptotic series is generally diverging. Many series in physics are only asymptotic, most notably the perturbation series in QED and also, most probably in QCD. Sometimes asymptotic series can by resummation be converted into converging series. Generally one can say, the higher the order N , the better the approximation but also the smaller the range, in which the series gives good results. We shall see this in the following example.

The asymptotic expansion of the Digamma function is

$$\psi^{(0)}(x) \sim \left(\log x - \frac{1}{2x}\right) - \sum_{n=1} \frac{B_n}{2nx^{2n}} = \left(\log x - \frac{1}{2x}\right) - \frac{1}{12x^2} + \frac{1}{120x^4} + \dots \quad (6.55)$$

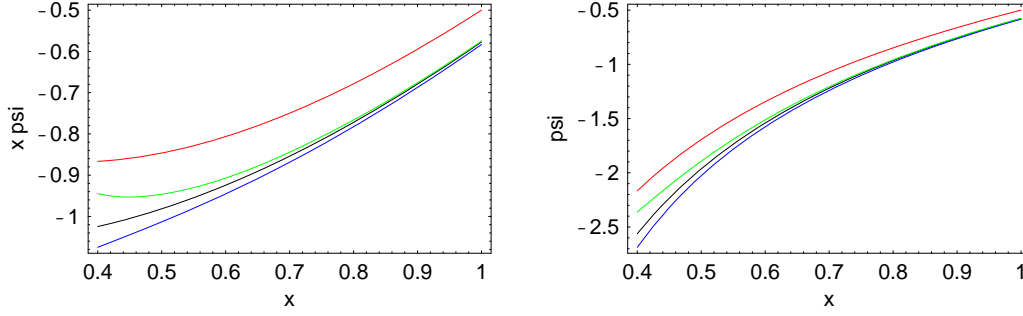

Figure 6.2: Asymptotic expansion of $x\psi^{(0)}(x)$ (left) and $\psi^{(0)}(x)$ (right) . Black: exact expression , red: zero order $\psi^{(0)} \approx \log x - \frac{1}{2x}$, blue: first term of AE included, green: first two terms included.

In Fig. 6.2 we display the exact result for $\psi^{(0)}(x)$ and the series with various truncations. We see that for $x > 0.6$ the inclusion of the second order term $1/(120x^4)$ (green) improves the first order result, but that for $x < 0.6$ the first order result (blue) is better than the second order result.

We now consider the scalar part of the asymptotic expansion of several current propagators, introducing the abbreviation:

$$Y = \frac{Q^2}{4|\lambda|} = -\frac{q^2}{4|\lambda|} \quad (6.56)$$

a) Conserved vector current ($L = J = 1, \mu = 0$):

$$\psi(Y+1) = \log(Y) + \frac{1}{2Y} - \frac{1}{12Y^2} + \frac{1}{120Y^4} - \frac{1}{252Y^6} + \frac{1}{240Y^8} \quad (6.57)$$

$$- \frac{1}{132Y^{10}} + \frac{691}{32760Y^{12}} + O\left(\left(\frac{1}{Y}\right)^{13}\right) \quad (6.58)$$

b) ρ current in LFHQCD ($L = 0, J = 1$)

$$\psi\left(Y + \frac{1}{2}\right) = \log(Y) + \frac{1}{24Y^2} - \frac{7}{960Y^4} + \frac{31}{8064Y^6} + O\left(\left(\frac{1}{Y}\right)^8\right) \quad (6.59)$$

c) (Pseudo) scalar current in LFHQCD ($J = L = 0$)

$$\psi(Y) = \log(Y) - \frac{1}{2Y} - \frac{1}{12Y^2} + \frac{1}{120Y^4} - \frac{1}{252Y^6} + O\left(\left(\frac{1}{Y}\right)^8\right) \quad (6.60)$$

d) general asymptotic with open L and J :

$$\begin{aligned} \psi\left(Y + \frac{1}{2}(J+L)\right) = & \quad (6.61) \\ \log(Y) + \frac{J+L-1}{2Y} + \frac{-3J^2-6JL+6J-3L^2+6L-2}{24Y^2} \\ + \frac{J^3+3J^2L-3J^2+3JL^2-6JL+2J+L^3-3L^2+2L}{24Y^3} + O\left(\left(\frac{1}{Y}\right)^4\right) \end{aligned}$$

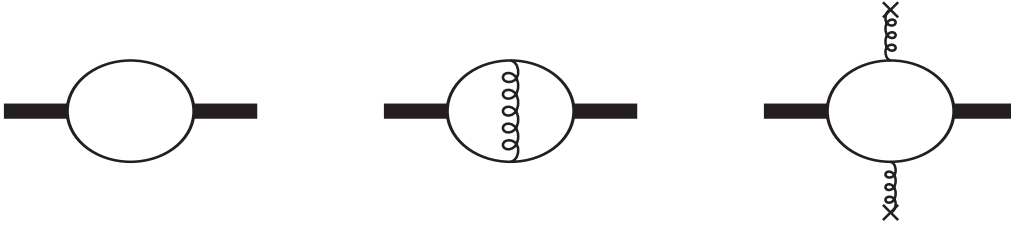

Figure 6.3: Perturbative and non-perturbative terms in a propagator. The thick lines represent a hadronic current, the thin lines quarks, and the curled lines gluons. The first two terms are from perturbation theory, the last term, where the gluon lines end in the vacuum is an example of a non-perturbative contribution

The QCD sum rule method

The sum rule method [37] is based on the operator product expansion as an asymptotic expansion in the not so deep Euclidean region, that is at $Q^2 \approx 1\text{GeV}$. For very large values of Q^2 perturbation theory (PT) is supposed to be reliable because of asymptotic freedom. But for smaller values of Q^2 nonperturbative terms are supposed to become relevant. Therefore SVZ made for the propagator $\Sigma(Q^2)$ the following theoretical ansatz:

$$\Sigma_{SVZ}(Q^2) = \text{PT} + \sum_{n=1} \frac{1}{Q^{2n}} F_n C_{2n} \quad (6.62)$$

Here PT is the perturbative expression, C_{2n+2} are universal non-perturbative QCD constants (condensates) and F_n calculable expressions depending on the quantum numbers of the propagating field. Normally the series starts with the 4-dimensional gluon condensate $C_4 = \langle G_{\mu\nu}^A G^{A\mu\nu} \rangle$, but there are also approaches which start with a two dimensional condensate, C_2 [39]. The lowest order contribution to the expression from perturbation theory yields $PT \sim \log Q^2$. Comparing (6.61) and (6.62) we see the complete formal correspondence between the asymptotic expansion of the holographic result and the sum rule ansatz. This has been noticed and partially exploited in HQCD in [40, 39]. It should be noted, that the analogy is formal. In the AdS/CFT case we have an exact expression for which we construct an asymptotic expansion. In the case of QCD sum rules one tries to approach the exact expression (that is the observed two point function) by perturbation theory plus a series of power corrections proportional to condensates. These condensates are the difference of expectation values obtained in the perturbative and the physical vacuum.

6.2.6 The propagator in the hard wall model

The propagator in the hard wall model can be calculated along the same lines as that of the soft wall model, see sect. 6.2.2. The result for the conserved current is [41]:

$$\frac{1}{R} \Sigma(q^2) \sim q^2 \left(\log(q) - \frac{\pi Y_0(qz_0)}{2 J_0(qz_0)} \right) + \text{divergent non-dynamical terms} \quad (6.63)$$

It is a meromorphic function with poles at the zeros of the Bessel function J_0 . The logarithmic cut of the Bessel function Y_0 cancels the explicitly occurring logarithm. In this case the propagator has no asymptotic expansion with a logarithm and additional power corrections as in the soft wall model (6.55) and there is no formal similarity with the expression used in QCD sum rules. Indeed, as has been shown in [41], the hard wall model is rather the equivalent of a model developed by Migdal [42]. In this model the perturbative expression (the logarithm) is approximated by a (finite) sum of pole terms.

6.3 Summary

The propagator of a mesons in the soft wall model is a digamma function, which is meromorphic. The asymptotic expansion of the digamma function for negative arguments shows a remarkable structural similarity with the expansion of the propagator used for QCD sum rules.

Chapter 7

Form factors in AdS

This chapter is mainly based on [43, 6] and chapt. 6 in [2], We refer to these sources for additional literature.

7.1 Form factors

The product of the electric charge e and the form factor $F(q^2)$ measures the strength of the coupling of a virtual photon with momentum $Q^2 = -q^2$ to a hadron, the form factor is normalized $F(0) = 1$. By scattering of leptons on hadrons one probes the values for $q^2 < 0$ Fig. 7.1, a) and by annihilation the region $q^2 > 0$, Fig. 7.1 b). The form factor (FF) gives information on the charge distribution of the hadron, thus it is an important tool to investigate the structure of hadrons. Indeed, three Nobel prizes have been awarded for form-factor related investigations, namely 1961 to Hofstadter for his investigations of the neutron and proton form factor, and 1990 to Friedman, Kendall and Taylor for investigations of the inelastic form factor, and 1976 to Richter and Ting for investigations of the hadronic form factors in the time-like region.

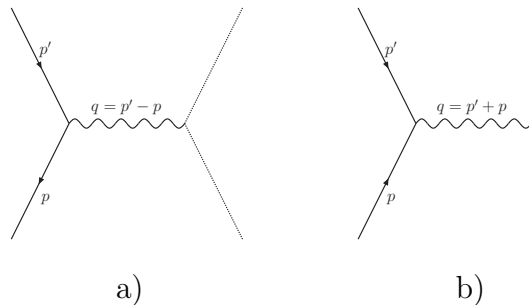

Figure 7.1: Measurement of the form factor: a) in the space-like region (scattering); b) in the time-like region (annihilation or production).

Since the form factor is classically the Fourier transform of the charge distribution, it shows for a homogeneous Gaussian charge distribution of the form $e^{-\lambda z^2}$ also a Gaussian form. For a distribution of point-like charges, however, a power behaviour $\sim 1/(q^2)^n$ results. The results of Friedman, Kendall and Taylor showed a power behaviour and were thus an important corroboration of the parton model of hadrons.

7.2 Form factor in HQCD and LFHQCD for a (pseudo-)scalar particle

7.2.1 The “dressed” electromagnetic field in AdS/CFT

In order to calculate the form factor in field theory one has to start from the interaction term of the electromagnetic with the hadron field in the action. The interaction term in the modified AdS action is given by

$$S_{int} = \int d^{d+1}x \mathbf{e}_5(z) e^{\lambda z^2} \sqrt{|g|} g^{NN'} i ((\partial_N \Phi(x))^* \Phi(x) - \Phi^*(x) \partial_N \Phi(x)) A_{N'}(x), \quad (7.1)$$

$\mathbf{e}(z)$ is the electric charge in AdS₅ and A_N the electromagnetic current in AdS [44]. We could in principle try to evaluate the generating functional for that three point function of two hadron fields and the electromagnetic one. But we make a shortcut: We are interested in the form factors of on-shell particles, i.e. $p^2 = p'^2 = M^2$, and only the momentum q of the virtual photon is variable. Therefore we evaluate directly an expression corresponding to (7.1) where $\Phi(x)$ is not a general hadron field, but the wave function of a specific hadron.

As before we Fourier transform the Minkowski variables, that is we go from $\Phi(x, z)$ to $\tilde{\Phi}(p, z)$ and obtain

$$S_{int} = \int \frac{d^4p}{(2\pi)^4} \frac{d^4p'}{(2\pi)^4} dz \mathbf{e}_5(z) \left(\frac{R}{z}\right)^3 \varepsilon \cdot (p - p') \tilde{\Phi}_\tau^*(p', z) \tilde{\Phi}_\tau(p, z) \tilde{A}(p - p', z), \quad (7.2)$$

here ε is the polarization vector of the Fourier transformed field

$$\varepsilon_\mu \tilde{A}(q, z) = \int d^4x e^{-iqx} A_\mu(x, z) \quad (7.3)$$

and we have introduced a modified wave function

$$\tilde{\Phi}_\tau(q, z) = e^{\lambda z^2/2} \tilde{\Phi}(q, z) \quad (7.4)$$

in order to compensate the dilaton factor $e^{\lambda z^2}$ in (7.1) and we have also introduced a possibly z dependent electric charge $\mathbf{e}_5(z)$ in the bulk. We have used that in AdS₅ one has $\sqrt{|g|} = \left(\frac{R}{z}\right)^5$, $g^{LL'} = \left(\frac{z}{R}\right)^2 \eta^{LL'}$.

The expression for the form factor of hadrons can be read off from(7.2):

$$\mathbf{e} F(Q^2) = \int dz \mathbf{e}_5(z) \left(\frac{R}{z}\right)^3 \tilde{\Phi}_\tau^*(p', z) \tilde{\Phi}_\tau(p, z) \tilde{A}(p - p', z) \quad (7.5)$$

where $Q^2 = -q^2 = -(p' - p)^2$ and \mathbf{e} is the total charge of the hadron.

In chapt. 4.2, (4.22) we have determined the bound state wave functions $\tilde{\Phi}(p, z)$ for $p^2 = M_{hadron}^2$. These wave function for the hadrons are

$$\tilde{\Phi}_\tau(p, z) = \frac{1}{N} \lambda^{(\tau-1)/2} z^\tau L_n^{(L)}(\lambda z^2) e^{-\lambda z^2/2} \quad \text{with } \tau = 2 + L - J \quad (7.6)$$

The solution $\tilde{A}(q, z)$ for a conserved vector current, that is with quantum numbers $J = 1$ and $L = 1$, corresponding to $\mu = 0$ is, see (6.35):

$$\tilde{A}(q, z) = z^2 e^{-(|\lambda|+\lambda)z^2/2} U\left(\frac{-q^2}{4|\lambda|} + 1, 2, |\lambda|z^2\right) \quad (7.7)$$

We use the relation [38], 13.1.17, with $b = 2$: $U(a, 2, x) = x^{-1}U(a-1, 0, x)$ and obtain

$$\tilde{A}(Q^2, z) = \frac{1}{|\lambda|} e^{-(\lambda+|\lambda|)z^2/2} U\left(\frac{Q^2}{4|\lambda|}, 0, |\lambda|z^2\right) \quad (7.8)$$

As normalization conditions we impose [2]:

$$\frac{1}{\mathbf{e}} \lim_{q^2 \rightarrow 0} \mathbf{e}_5(z) \tilde{A}(Q^2, z) = \frac{1}{\mathbf{e}} \lim_{z \rightarrow 0} \mathbf{e}_5(z) \tilde{A}(Q^2, z) = 1 \quad (7.9)$$

Some useful relations for the function U are, see e.g. [38], 13:

$$U\left(\frac{Q^2}{4|\lambda|}, 0, 0\right) = \frac{1}{\Gamma(1 + \frac{Q^2}{4|\lambda|})} \quad (7.10)$$

$$U(0, 0, z) = 1 \quad (7.11)$$

$$\lim_{Q^2 \rightarrow \infty} \Gamma\left(\frac{Q^2}{4|\lambda|}\right) U\left(\frac{Q^2}{4|\lambda|}, 0, |\lambda|z^2\right) = Qz K_1(Qz) \quad (7.12)$$

If we chose $\mathbf{e}_5(z) = e^{(|\lambda|+\lambda)z^2/2} \mathbf{e}$ the conditions (7.9) are fulfilled for the solution $J(Q^2, z)$ with

$$\tilde{J}(Q^2, z) = \Gamma\left(1 + \frac{Q^2}{4|\lambda|}\right) U\left(\frac{Q^2}{4|\lambda|}, 0, |\lambda|z^2\right). \quad (7.13)$$

This function $\tilde{J}(Q^2, z)$ (7.13) is a Tricomi Hypergeometric function and has an integral representation see [38], (13.2), which is very useful to perform the z integration in (7.5)

$$\tilde{J}(Q^2, z) = |\lambda|z^2 \int_0^1 \frac{dx}{(1-x)^2} x^{Q^2/(4|\lambda|)} e^{-|\lambda|z^2 x/(1-x)}. \quad (7.14)$$

We confine ourself to orbital and radial ground states ($L = 0, n = 0$) and have for the hadron wave functions:

$$\Phi_\tau(z) = \sqrt{\frac{2}{\Gamma(\tau-1)\lambda}} (\lambda z^2)^{\tau/2} e^{-\lambda z^2/2} \quad \text{with} \quad \int_0^\infty \frac{dz}{z^3} \Phi_\tau(z)^2 = 1 \quad (7.15)$$

We omit in the following the curvature radius in AdS₅, it can be absorbed in the normalization of the wave functions.

The form factor (7.5) is then

$$F^\tau(Q^2) = \int \frac{dz}{z^3} \Phi_\tau(z)^2 J(Q^2, z) dz \quad (7.16)$$

$$= \int \frac{dz}{z^3} \frac{2z^2}{\Gamma(\tau-1)} (\lambda z^2)^\tau e^{-\lambda z^2} \int dx \frac{e^{-|\lambda|z^2x/(1-x)}}{(1-x)^2} x^{Q^2/(4|\lambda|)} \quad (7.17)$$

The z -integration over the Gaussians can be performed analytically and one obtains:

$$F^\tau(Q^2) = (\tau-1) \int_0^1 dx (1-x)^{\tau-2} x^{Q^2/(4\lambda)} \quad (7.18)$$

The integral on the right hand side of this equation has the form of an integral representation of the Euler B function: ([38], 6.2)

$$B[u, v] = \frac{\Gamma[u] \Gamma[v]}{\Gamma[u+v]} \quad B[u, v] = \int_0^1 dx x^{u-1} (1-x)^{v-1} \quad (7.19)$$

We thus can express the form factor analytically in terms of the Beta function or in terms of Gamma functions.

$$F^\tau[Q^2] = (\tau-1) B[\tau-1, 1+Q^2/(4\lambda)] \quad (7.20)$$

$$= (\tau-1) \frac{\Gamma[\tau-1] \Gamma[1+Q^2/(4\lambda)]}{\Gamma[\tau+Q^2/(4\lambda)]} \quad (7.21)$$

Since τ is an integer, the expression can be transformed using the recursion relation $u\Gamma(u) = \Gamma(u+1)$.

Consider e.g. particle a (pseudo)scalar particle (pion): here we have $\tau = 2 + L - J = 2$. By making use of the recursion relation for the denominator we obtain

$$F_\pi^\tau(Q^2) = 1 \frac{\Gamma[1+Q^2/(4\lambda)]}{\Gamma[2+Q^2/(4\lambda)]} = 1 \frac{\Gamma[1+Q^2/(4\lambda)]}{(1+Q^2/(4\lambda))\Gamma[1+Q^2/(4\lambda)]} = \frac{1}{1+Q^2/(4\lambda)} \quad (7.22)$$

7.2.2 The scaling twist

There is a lot of discussion about the twist. The canonical twist of a field is defined as the dimension of the field minus spin plus angular momentum. The dimension of a field can be determined by the requirement that the action has the dimension of \hbar , that is 0 in natural units. From that follows that a scalar field has mass dimension 1 and a fermion field has mass dimension 3/2. The dimension of a quark (or antiquark) is $\frac{3}{2}$, therefore the twist of a quark is one.

According to this counting the twist of a hadron is the number N of the quarks it contains plus the angular momentum. We shall call this quantity, $N + L$ the scaling twist, in following we shall always use the scaling twist $\tau = N + L$.

For a scalar field with two particles in the ground state we have $\tau = 2$.

For the Nucleon or Delta the positive chirality component ($L = 0$) has twist $\tau = 3$, the negative chirality component with $L = 1$ has $\tau = 4$. We come back to this point later in the discussion of the nucleon form factor.

7.2.3 General results

The procedure which led to (7.22) can be extended to any twist by repeated application of the recursion formula and one obtains

$$F^\tau(Q^2) = \frac{(4|\lambda|)^{\tau-1}(\tau-1)!}{(Q^2 + 4|\lambda|) \cdots (Q^2 + (\tau-1)(4|\lambda|))}. \quad (7.23)$$

For very high Q^2 one obtains:

$$\lim_{Q^2 \rightarrow \infty} F^\tau(Q^2) \sim \left(\frac{4\lambda}{Q^2}\right)^{\tau-1} \quad (7.24)$$

Holographic QCD therefore implies [45] that the form factor decreases with $(1/Q^2)^{N-1}$ where N is the number of constituents. This is in accordance with the famous quark counting rule of Brodsky and Farrar [46, 47]. This rule can be easily understood qualitatively. In a hard elastic lepton hadron scattering the large transferred momentum q has to be distributed over all constituents. The photon interacts directly with only one constituent. If the hadron stays intact, as is the case for the elastic form factor, the momentum has to be transferred to the other constituents by gluons of momentum $\sim q$. This process creates a gluon propagator $\sim 1/Q^2$. For N constituents the momentum has to be transferred from the active quark to the remaining $N-1$ passive constituents, that is we have a factor $1/(Q^2)^{N-1}$.

It is very remarkable that this lowest order result from perturbative QCD is also incorporated in the inherently non-perturbative HQCD and LFHQCD [1]! Higher correction in perturbation theory lead to logarithmic corrections, which, however, are not included in LFHQCD.

7.2.4 Final assumptions and results for the form factor

The most delicate point is the following: The poles in the time-like region of the form factor are associated with hadrons with the same quantum numbers as the photon $J^P = 1^-$, that is with vector mesons: the ρ and its radial excitations. On the other hand we have seen in the last chapter, sect. 6.2.3, especially Fig. 6.1, that the conserved current does not give an adequate description of the ρ and its trajectory, whereas the current with $J = 1, L = 0$ in LFHQCD does so. The easiest solution of the problem is to replace the argument $Q^2 + 1$ in the Beta function (7.20) by $Q^2 + \frac{1}{2}$ [2]; this preserves all the positive results but shifts the ρ poles to the right position.

In this way we obtain as final general expression for the form factor of a hadron with twist τ the very simple result:

$$F^\tau[Q^2] = \frac{\tau-1}{\mathcal{N}} B[\tau-1, \frac{1}{2} + Q^2/(4\lambda)] \quad (7.25)$$

where the normalization constant \mathcal{N} is the rational number:

$$\mathcal{N} = \frac{\Gamma(\tau) \Gamma(\frac{1}{2})}{\Gamma(\tau + \frac{1}{2})} \quad (7.26)$$

This shift of the pole positions amounts to a purely numerical modification of (7.23) and (7.24) to

$$F^\tau(Q^2) = \frac{1}{(1 + Q^2/M_0^2) \cdots (1 + Q^2/M_{\tau-2}^2)} \quad (7.27)$$

where M_n^2 are the theoretical values for the squared masses of the rho and its radial excitations, $M_n^2 = (4n + 2)|\lambda|$.

Equation (7.24) reads now:

$$\lim_{Q^2 \rightarrow \infty} F^\tau(Q^2) = M_0^2 \cdots M_{\tau-2}^2 \left(\frac{1}{Q^2} \right)^{\tau-1} \quad (7.28)$$

Another step to a realistic theory is to replace the theoretical masses M_i by the observed ones. For the vector current:

$$M_0 = \sqrt{2\lambda} \approx 0.76 \quad \Rightarrow \quad M_\rho = 0.77 \text{ GeV}^2 \quad (7.29)$$

$$M_1 = \sqrt{6\lambda} \approx 1.32 \quad \Rightarrow \quad M_\rho = 1.45 \text{ GeV}^2 \quad (7.30)$$

$$M_2 = \sqrt{10\lambda} \approx 1.70 \quad \Rightarrow \quad M_\rho = 1.70 \text{ GeV}^2 \quad (7.31)$$

$$M_3 = \sqrt{14\lambda} \approx 2.02 \quad \Rightarrow \quad M_\rho = 2.15 \text{ GeV}^2 \quad (7.32)$$

This shift to the observed masses has little influence on the form factors in the space-like region, but it is important in the timelike region. There the inclusion of the observed widths is ven more important. LFHQCD as a zero width ($N_c \rightarrow \infty$) theory predicts form factors with poles on the real axis, but the physical form factor has cuts and poles in the complex plane. This again has no great influence on the space-like behaviour but is crucial for the time-like region. Therefore for a realistic treatment of the time-like region one must take into account the experimentally observed finite widths of the rho and its radial excitations. This will be illustrated in the next subsection.

The valence quark (leading twist) approximation might be not so appropriate for the treatment of form factors, especially again in the time-like region. If one takes an additional meson cloud into account, each additional meson in the Fock state increases the number of constituents and hence also the twist by two. Taking into account only one additional meson in the cloud, one obtains:

$$F(Q^2) = (1 - P)F^\tau(Q^2) + P F^{\tau+2}(Q^2) \quad (7.33)$$

where P is the probability of the higher twist contribution and τ the leading twist. Since the higher twist does not contribute asymptotically compared to the leading twist, the asymptotic formula (7.28) is reduced by the factor $(1 - P)$.

7.2.5 Comparison of π form factor with experiment

The results obtained by (modified) LFHQCD for the pion form factor in the space and time-like region is displayed in Fig. 7.2. The occurrence of a (weak) contribution of the $\rho(1450)$ in the pion pair production makes a small higher twist contribution necessary, with $P = 0.12$, see (7.33), For further details we refer to [5, 2]. The importance of inclusion of the finite observed width becomes evident by comparing Fig. 7.2b) and d).

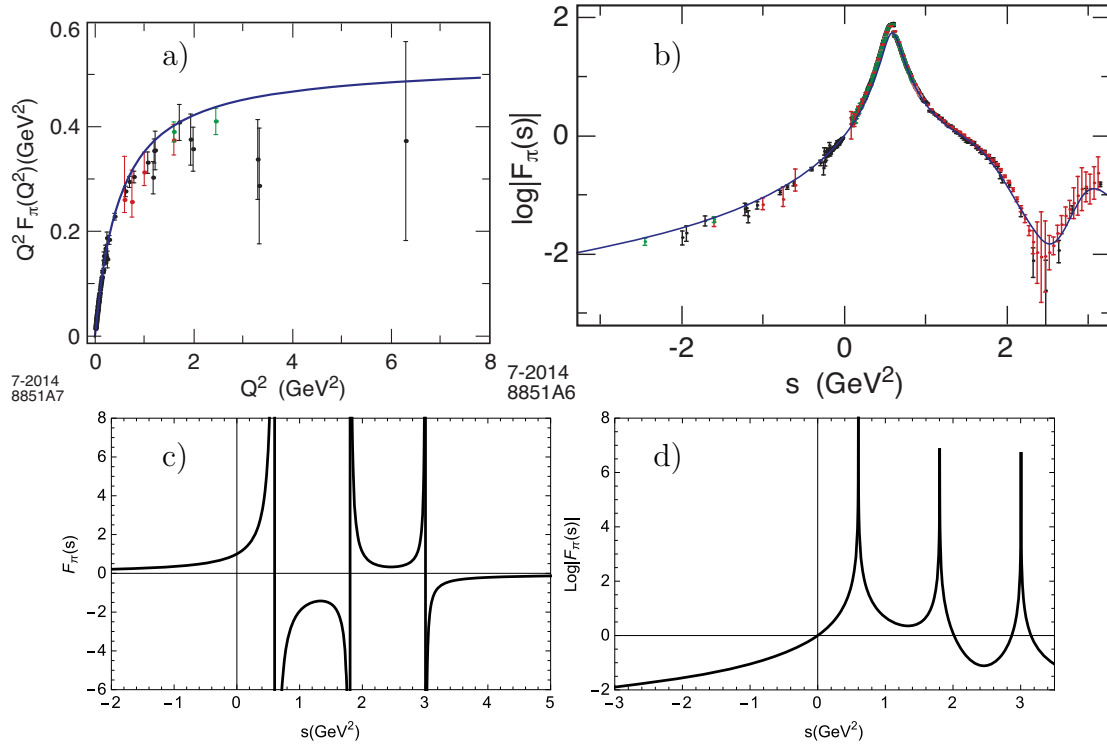

Figure 7.2: The form factor of the pion in the spacelike region (a) and in the timelike region (b), where information about width from experiment and some threshold effects are incorporated. c) and d) The formfactor from LFHQCD without any corrections in the timelike region. a) and b) come from [2].

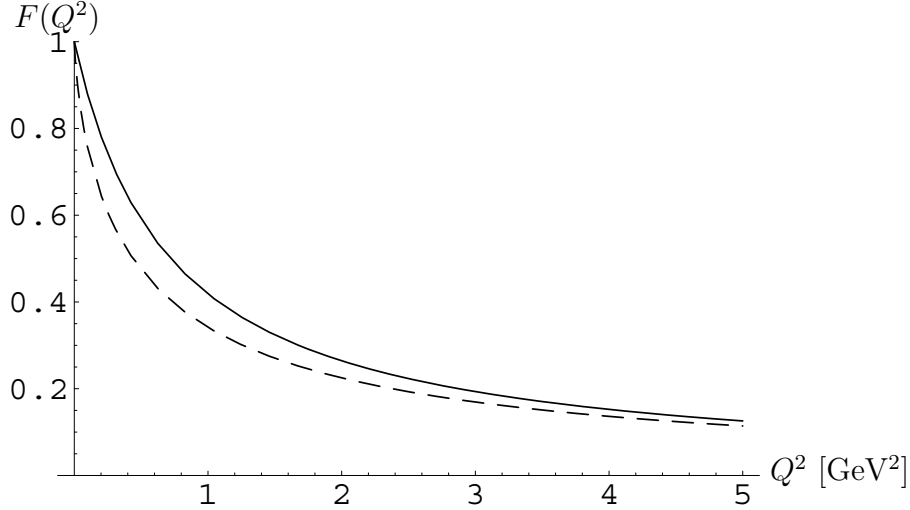

Figure 7.3: Solid line: The form factor in the soft wall model for the ground state, obtained directly from AdS/CFT. Dashed line: the form factor obtained from the soft-wall LF function with the Drell-Yan West expression (7.34).

7.2.6 The form factor in the parton model, effective wave functions

The form factor in the parton model has been studied by Drell and Yan [48] and West [49]. The Drell-Yan West (DYW) expression for the form factor calculated from light front wave functions is:

$$F(Q^2) = \int dx b db d\theta e^{ix|\vec{q}_\perp|b \cos \theta} |\phi^{LF}(x, b)|^2 = 2\pi \int \int dx b db J_0(xQb) |\phi^{LF}(x, b)|^2. \quad (7.34)$$

In Fig. 7.3 we show the result for the form factor of the pion in the space-like region as obtained by LFHQCD (solid line) and the result of the DYW expression (7.34) where the LF wave functions obtained from AdS wave functions, see (4.9), have been used.

The DYW expression evaluated with wave functions as obtained in AdS fall off too fast at small values of Q^2 , the resulting charge radius is infinite. For large Q^2 , however, the two expressions agree asymptotically. The failure of the wave functions obtained from the bound state wave equations of AdS shows that they may describe very well global features, as the masses of the hadrons, but are not adequate to describe reliably the inner structure precisely. Therefore it is useful to introduce effective wave functions $\phi^{\text{eff}}(\zeta)$, which inserted into the DYW expression (7.34) reproduce the result obtained above, (7.25), with the dressed electromagnetic current [2]. They are defined by the condition:

$$F_{AdS}(Q^2) = \frac{(\tau - 1)}{\mathcal{N}} B \left[\tau - 1, \frac{Q^2}{4\lambda} + \frac{1}{2} \right] = 2\pi \int \int dx b db J_0(xQb) |\phi_\tau^{\text{eff}}(x, b)|^2. \quad (7.35)$$

7.3 Nucleon Form Factors

7.3.1 Form factors for spin $\frac{1}{2}$ fields in AdS/CFT

The coupling of the electromagnetic field to fermions is in AdS given analogously to (7.1) by:

$$\int d^4x dz \sqrt{g} \bar{\Psi}_{P'}(x, z) e_A^M \Gamma^A A_M(x, z) \Psi_P(x, z) \quad (7.36)$$

The notation is the same as in sect. 4.4, below (4.30). It leads in the 4-dim space to the Dirac form factor F_1 .

$$(2\pi)^4 \delta^4(P' - P - q) \epsilon_\mu \bar{u}(P') \gamma^\mu F_1(q^2) u(P), \quad (7.37)$$

In the parton model it is the spin-conserving matrix element of the quark current $J^\mu = \sum_q e_q \bar{q} \gamma^\mu q$.

In AdS₅ nucleons have positive and negative chirality components, Ψ^+ and Ψ^- , as described in sect. 4.4. The spin non-flip nucleon elastic form factor F_1 (Dirac form factor) is diagonal in chirality and follows from (7.36):

$$F_1^N(Q^2) = \sum_{\pm} g_{\pm}^N \int \frac{dz}{z^4} J(Q^2, z) \Psi_{\pm}^2(z). \quad (7.38)$$

The current is given by (7.13), but the same pole shift as in (7.25) will be performed. Notice that there is an additional scaling power in (7.38), as compared with (7.16)).

The effective charges g_{\pm}^N have to be determined by the specific spin-flavor structure which is not contained in the holographic principle. For example, in the SU(6) symmetry approximation the effective charges are computed by the sum of the charges of the struck quark convoluted by the corresponding probability for the $L = 0$ and $L = 1$ components Ψ_+ and Ψ_- respectively. The result is [2]

$$g_+^p = 1, \quad g_-^p = 0, \quad g_+^n = -\frac{1}{3}, \quad g_-^n = \frac{1}{3}. \quad (7.39)$$

Since the structure of (7.36) can only account for F_1 , one should include an effective gauge-invariant interaction in the five-dimensional gravity action to describe the spin-flip amplitude [50].

$$\int d^4x dz \sqrt{g} \bar{\Psi}_{P'}(x, z) e_A^M e_B^N [\Gamma^A, \Gamma^B] F_{MN}(x, z) \Psi_P(x, z) \quad (7.40)$$

where the resulting expression in 4 dimensions is the Pauli form factor F_2 .

$$(2\pi)^4 \delta^4(P' - P - q) \epsilon_\mu \bar{u}(P') \frac{\sigma^{\mu\nu} q_\nu}{2M_N} F_2(q^2) u(P) \quad (7.41)$$

It corresponds to the spin-flip matrix element. Since (7.40) represents an effective interaction, its overall strength has to be fitted to the observed static values of the anomalous magnetic moments χ_p and χ_n [2, 50].

Extracting the factor $(2\pi)^4 \delta^4(P' - P - q)$ from momentum conservation in (7.41) we find [50]

$$F_2^N(Q^2) = \chi_N \int \frac{dz}{z^3} \Psi_+(z) J(Q^2, z) \Psi_-(z), \quad (7.42)$$

where $N = p, n$.

Since $\Psi_+(z) \sim z^{\tau+\frac{1}{2}}$ and $\Psi_-(z) \sim z^{\tau+1+\frac{1}{2}}$ the total power of z in the Pauli form factor (7.42) is $z^{2(\tau+1)-3}$, that is F_2 is a form factor with twist $\tau + 1$.

7.3.2 A Simple Light-Front Holographic Model for Nucleon Form Factors

From (4.44) follows for the behaviour of the positive and negative component of the nucleon field in the ground state, note that $T = J - \frac{1}{2} = 0$ for the nucleon:

$$\tilde{\Psi}^+(P, z) \sim z^{2+\frac{1}{2}}; \quad \tilde{\Psi}^-(P, z) \sim z^{3+\frac{1}{2}} \quad (7.43)$$

The additional factor $z^{\frac{1}{2}}$ compensates the additional power of z in (7.38) and we obtain the same expression as for a meson. But we expect for the leading twist, $L = 0$, the value $\tau = 3$ since the baryon has 3 constituents. The discrepancy has the following reason: The wave functions derived in sect. 4.4 are wave function of a two body system consisting of a quark and a two-quark cluster. Since the electromagnetic field interacts with both components of the cluster separately, the latter has for the form factor to be resolved and this gives the additional factor z in the wave function. This fact corroborates our statement made in sect 7.2.6 that the bound state wave functions of AdS describe only the collective properties. We use the realistic twist for the nucleon wave functions and therefore put:

$$\tilde{\Psi}^+ = z^{\frac{1}{2}} \Phi_3(z) = z^{\frac{1}{2}} \sqrt{\frac{2}{\lambda}} (\lambda z^2)^{3/2} \quad (7.44)$$

$$\tilde{\Psi}^- = z^{\frac{1}{2}} \Phi_4(z) = z^{\frac{1}{2}} \sqrt{\frac{2}{2\lambda}} (\lambda z^2)^2 \quad (7.45)$$

Analogous to the pion we will consider the case where we only include the valence contribution (with probability $1 - P$) and possibly a contribution with two more constituents (pion cloud), probability P , that is in leading twist $\tau = 3, 5$ for Ψ^+ . For Ψ^- no higher twist is asked for by the data.

We obtain for the proton

$$F_1^p(Q^2) = (1 - P_p^1) F^{(\tau=3)}(Q^2) + P_p^1 F^{(\tau=5)}(Q^2) \quad (7.46)$$

$$F_2^p(Q^2) = \chi_p [(1 - P_p^2) F^{(\tau=4)}(Q^2) + P_p^2 F^{(\tau=6)}(Q^2)] \quad (7.47)$$

where $\chi_p = \mu_p - 1 = 1.793$ is the proton anomalous moment.

The valence contribution alone gives a good description of the proton Dirac form factor, see Fig. 7.4, blue line, that is $P_p^1 \approx 0$, but the fit for the Pauli form factor can be improved by choosing a rather large higher-Fock-state probability, $P_p^2 \approx 0.27$, see Fig. 7.5, blue line. It is of course not satisfactory to have different cloud contributions for the same particle, but it necessary to have good agreement with the data.

It turns out that for the neutron higher twist contributions cannot ameliorate the agreement with the experiment and we use

$$F_1^n(Q^2) = -\frac{1}{3}(1 - P_n^1) \left[F^{(\tau=3)}(Q^2) - F^{(\tau=4)}(Q^2) \right] \quad (7.48)$$

$$-\frac{1}{3} P_n^1 \left[F^{(\tau=5)}(Q^2) - F^{(\tau=6)}(Q^2) \right] \quad (7.49)$$

$$F_2^n(Q^2) = \chi_n \left[(1 - \gamma_n) F^{(\tau=4)}(Q^2) + \gamma_n F^{(\tau=6)}(Q^2) \right] \quad (7.50)$$

with the experimental value $\chi_n = \mu_n = -1.913$.

The result for the neutron Dirac form factor comes out by a constant factor 2.1 too small, see Fig. 7.4, yellow line. One expects indeed that the theory is less reliable for the neutron than for the proton, since the result for the neutron form factor is the difference of two theoretical curves which compensate exactly at $Q^2 = 0$. Therefore the neutron is much more sensitive to uncertainties of the theory, notably to the determination of the effective charges from $SU(6)$ symmetry.

The result for the neutron Pauli form factor is not a difference of two theoretical curves and indeed quite satisfactory, see Fig. 7.5, green line, though also here a rather large higher Fock-state probability has to be assumed, $P_n^2 = 0.38$.

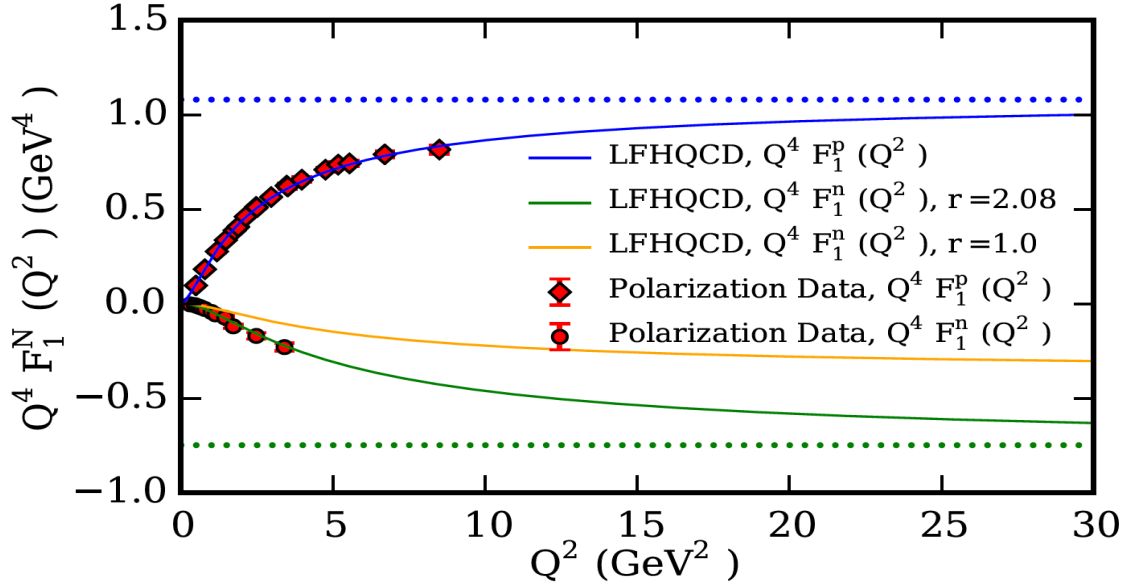

Figure 7.4: Polarization measurements and predictions for the proton and neutron Dirac form factors. The blue line is the prediction of the proton Dirac form factor from LFHQCD, (7.46) with $P_p^1 = 0$, multiplied by Q^4 . The orange line is the predictions for the neutron Dirac form factor, $Q^4 F_1^n(Q^2)$ with $P_n^1 = 0$, from (7.48). The green line is the prediction multiplied by a factor 2.1. The dotted lines are the asymptotic values, from [6].

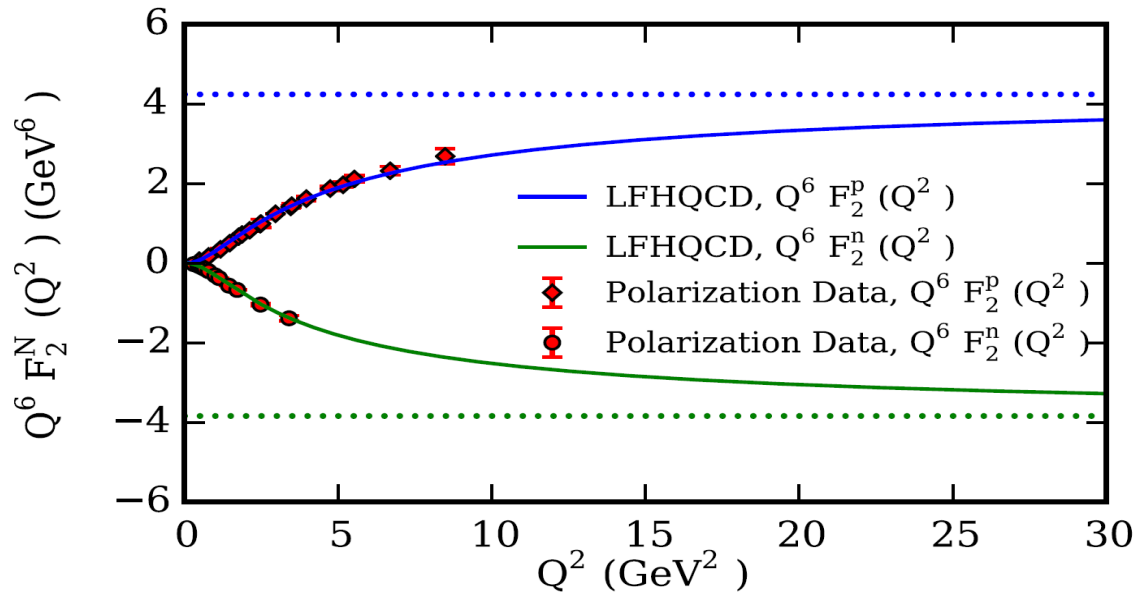

Figure 7.5: Polarization measurements and predictions for the proton and neutron Pauli form factors. The blue line is the proton Pauli form factor, $Q^6 F_2^p(Q^2)$ prediction, with $\gamma_p = 0.27$ in Eq. (7.47). The green line is the prediction for the neutron Pauli form factor, $Q^6 F_2^n(Q^2)$, in Eq. (7.50) from LFHQCD with a higher Fock-state probability $P_n^2 \approx 0.38$. The dotted lines are the asymptotic predictions, from [6].

7.4 Summary

LFHQCD yields a very simple and elegant analytical formula for form-factors of light hadrons in the space-like region as well as in the time-like region. The Form factor is a Euler function which is determined by the twist, see (7.25). To arrive at this formula from the originally derived one, (7.20) a shift from the argument $Q^2 + 1$ in (7.20) to $Q^2 + \frac{1}{2}$ in (7.25) has to be performed.

The structure of hadron form factors is very well described by this analytical formula. In order to have quantitative agreement with experiments additional parameters have to be introduced, as the probability of a higher Fock state, containing an additional meson. For the neutron Dirac form factor a strong deviation from $SU(6)$ wave functions has to be parameterized by a multiplicative factor, since LFHQCD cannot make predictions for the spin-isospin structure of the the nucleon.

Acknowledgement

One of the authors (HGD) wants to thank the Institute of Modern Physics and the Lanzhou University for the warm hospitality and support, he also is greatly indebted to Guy de Teramond and Stan Brodsky for countless instructive discussions. Our special thanks are also due to Prof. Zhang Pengming, who initiated this lecture, for many fruitful discussions and suggestions.

Appendix A

Collection of wave functions

We use different forms of wave functions, depending on the treated problem.

A.1 Mesons

For hadron wave functions we regard only such solutions which are normalizable and regular at $z = 0$. This implies that the spectrum has discrete values given by (4.20). The solutions $\tilde{\Phi}$ of the Euler-Lagrange equation (4.14) derived directly from the action (4.12) are

$$\tilde{\Phi}_{nL_{AdS}}(z) = z^{2+L_{AdS}-J} L_n^{(L_{AdS})}(|\lambda|z^2) e^{-(|\lambda|+\lambda)z^2/2} \quad (\text{A.1})$$

they are normalized as:

$$\int_0^\infty dz e^{\lambda z^2} z^{2J-3} \tilde{\Phi}_{nL_{AdS}}(z)^2 = 1 \quad (\text{A.2})$$

$L_n^\ell(x)$ are the associated Laguerre polynomials.

By the rescaling (4.16) we obtain solutions ϕ of a Schrödinger-like equation (4.17) which are:

$$\phi_{nL_{AdS}}(z) = 1/N z^{L_{AdS}+1/2} L_n^{L_{AdS}}(|\lambda|z^2) e^{-|\lambda|z^2/2} \text{ with } N = \sqrt{\frac{(n+L)!}{2n!}} |\lambda|^{-(L+1)/2} \quad (\text{A.3})$$

They are normalized to $\int_0^\infty dz (\phi_{nL_{AdS}}(z))^2 = 1$

The light front wave functions ϕ^{LF} are solutions of the two dimensional LF Hamiltonian (5.19) for massless constituents. They are related to the Schrödinger like wave functions by (4.9):

$$\phi^{LF}(x, b_\perp) = \sqrt{\frac{x(1-x)}{2\pi\zeta}} \phi(\zeta). \quad (\text{A.4})$$

and are normalized to

$$\int_0^\infty dx \int d^2b_\perp |\phi^{LF}[x, b_\perp]|^2 = 1 \quad (\text{A.5})$$

where $\zeta = \sqrt{x(1-x)} b_\perp$.

For the form factor it is convenient to introduce the twist wave functions Φ_τ by

$$\Phi_\tau(z) = e^{-\lambda z^2/2} \tilde{\Phi}(z) \quad (\text{A.6})$$

in order to compensate the factor $e^{\lambda z^2}$ in the interaction action (7.1).

A.2 Baryons

For baryons the Euler Lagrange equation (4.32) can be brought into the form (4.21) with the positive and negative chirality solutions, which are regular and normalizable:

$$\psi_{nL}^+(q, z) = \phi_{nL}(z), \quad \psi_{nL}^-(q, z) = \phi_{nL+1}(z) \quad (\text{A.7})$$

The solutions of (4.32) are (4.36))

$$\begin{aligned} \Psi^+(z) &= z^{2+L+1/2-T} L_n^{(L)}(|\lambda|z^2) e^{-|\lambda|z^2/2} \\ \Psi^-(z) &= z^{3+L+1/2-T} L_n^{(L+1)}(|\lambda|z^2) e^{-|\lambda|z^2/2} \end{aligned} \quad (\text{A.8})$$

where $T = J - \frac{1}{2}$.

A.3 Currents

Here we look for solutions of the Euler Lagrange equations (6.23) which are defined for any value of q^2 but vanish for $z \rightarrow \infty$. Such a solution is:

$$\tilde{\Phi}(q, z) = \rho(z) U(a_\lambda, L+1, |\lambda|z^2) \quad (\text{A.9})$$

with $\rho(z) = z^{L-J+2} e^{-(|\lambda|+\lambda)z^2/2}$.

The constant a_λ depends on the sign of λ :

$$\begin{aligned} \lambda < 0 \quad a_\lambda &= -\frac{q^2}{4|\lambda|} - \frac{\lambda}{4|\lambda|} (4 - 2J + 2L) \\ &= -\frac{q^2}{4|\lambda|} + \frac{1}{4} (4 - 2J + 2L) \end{aligned} \quad (\text{A.10})$$

$$\begin{aligned} \lambda > 0 \quad a_\lambda &= -\frac{q^2}{4|\lambda|} - \frac{\lambda}{4|\lambda|} (4 - 2J + 2L) + (L+1) \\ &= -\frac{q^2}{4|\lambda|} + \frac{1}{4} (2J + 2L) \end{aligned} \quad (\text{A.11})$$

$U(a, b, x)$ is Kummer's hypergeometric function.

Bibliography

- [1] S. J. Brodsky and G. F. de Teramond, Light-front hadron dynamics and AdS/CFT correspondence, *Phys. Lett. B* 582, 211 (2004) [arXiv:hep-th/0310227].
- [2] S. J. Brodsky, G. F. de Teramond, H. G. Dosch and J. Erlich, Light-front holographic QCD and emerging confinement, *Phys. Rept.* 584, 1 (2015) [arXiv:1407.8131[hep-ph]].
- [3] J. M. Maldacena, The large N limit of superconformal field theories and supergravity, *Int. J. Theor. Phys.* 38, 1113 (1999) [arXiv:hep-th/9711200].
- [4] H. G. Dosch, G. F. deTeramond and S. J. Brodsky, Superconformal baryonmeson symmetry and light-front holographic QCD, *Phys. Rev. D* 91, 085016 (2015) [arXiv:1501.00959 [hep-th]].
- [5] S. J. Brodsky and G. F. de Teramond, “Light-Front Dynamics and AdS/QCD Correspondence: The Pion Form Factor in the Space- and Time-Like Regions,” *Phys. Rev. D* **77** (2008) 056007, doi:10.1103/PhysRevD.77.056007 [arXiv:0707.3859 [hep-ph]].
- [6] R. S. Sufian, G. F. de Téramond, S. J. Brodsky, A. Deur and H. G. Dosch, “Analysis of nucleon electromagnetic form factors from light-front holographic QCD : The spacelike region,” *Phys. Rev. D* 95.014011(2017) [arXiv:1609.06688 [hep-ph]].
- [7] G. 't Hooft, “A Planar Diagram Theory for Strong Interactions,” *Nucl. Phys. B* **72** (1974) 461, doi:10.1016/0550-3213(74)90154-0.
- [8] G. Veneziano, *Nuovo Cim. A* 57 (1968) 190, doi:10.1007/BF02824451.
- [9] S. S. Gubser, I. R. Klebanov and A. M. Polyakov, Gauge theory correlators from non-critical string theory, *Phys. Lett. B* 428, 105 (1998) [arXiv:hep-th/9802109].
- [10] E. Witten, Anti-de Sitter space and holography, *Adv. Theor. Math. Phys.* 2, 253 (1998) [arXiv:hep-th/9802150].
- [11] A.V. Ramallo, Introduction to the AdS/CFT correspondence, *Springer Proc. Phys.* 161 (2015) 411 [arXiv:1310.4319 [hep-th]].
- [12] M. Ammon and J. Erdmenger, *Gauge/Gravity Duality: Foundations and Applications*, Cambridge University Press, (2015).
- [13] S. S. Gubser and A. Karch, “From gauge-string duality to strong interactions: A Pedestrian’s Guide,” *Ann. Rev. Nucl. Part. Sci.* **59** (2009) 145, doi:10.1146/annurev.nucl.010909.083602 [arXiv:0901.0935 [hep-th]].

- [14] I. R. Klebanov and J. M. Maldacena, *Phys. Today* **62** (2009) 28, doi:10.1063/1.3074260.
- [15] A. V. Manohar, “Large N QCD,” hep-ph/9802419.
- [16] J. Erlich, E. Katz, D. T. Son and M. A. Stephanov, QCD and a holographic model of hadrons, *Phys. Rev. Lett.* 95, 261602 (2005) [arXiv:hep-ph/0501128].
- [17] S. J. Brodsky and G. F. de Teramond, Hadronic spectra and lightfront wavefunctions in holographic QCD, *Phys. Rev. Lett.* 96 (2006) 201601, doi:10.1103/PhysRevLett.96.201601 [arXiv:hep-ph/0602252].
- [18] A. Karch, E. Katz, D. T. Son and M. A. Stephanov, Linear confinement and AdS/QCD, *Phys. Rev. D* 74, 015005 (2006) [arXiv:hep-ph/0602229].
- [19] P. A. M. Dirac, Forms of relativistic dynamics, *Rev. Mod. Phys.* 21, 392 (1949).
- [20] S. J. Brodsky, H. C. Pauli and S. S. Pinsky, Quantum chromodynamics and other field theories on the light cone, *Phys. Rept.* 301, 299 (1998) [arXiv:hep-ph/9705477].
- [21] G. F. de Teramond, H. G. Dosch and S. J. Brodsky, Kinematical and dynamical aspects of higher-spin bound-state equations in holographic QCD, *Phys. Rev. D* 87, 075005 (2013) [arXiv:1301.1651 [hep-ph]].
- [22] W. Rarita and J. Schwinger, On a theory of particles with half integral spin, *Phys. Rev.* 60, 61 (1941).
- [23] I. Kirsch, Spectroscopy of fermionic operators in AdS/CFT, *JHEP* 0609, 052 (2006) [arXiv:hep-th/0607205].
- [24] G. F. de Teramond, H. G. Dosch and S. J. Brodsky, Baryon spectrum from superconformal quantum mechanics and its light-front holographic embedding, *Phys. Rev. D* 91, 045040 (2015) [arXiv:1411.5243 [hep-ph]].
- [25] H. G. Dosch, G. F. de Teramond and S. J. Brodsky, Supersymmetry across the light and heavy-light hadronic spectrum, *Phys. Rev. D* 92, 074010 (2015) [arXiv:1504.05112 [hep-ph]].
- [26] H. G. Dosch, G. F. de Teramond and S. J. Brodsky, Supersymmetry Across the Light and Heavy-Light Hadronic Spectrum II, *Phys. Rev. D* 95, 034016 (2017) [arXiv:1612.02370 [hep-ph]].
- [27] S. J. Brodsky, G. F. de Teramond, H. G. Dosch and C. Lorc e, Universal effective hadron dynamics from superconformal algebra, *Phys. Lett. B* 759, 171 (2016) [arXiv:1604.06746 [hep-ph]].
- [28] V. de Alfaro, S. Fubini and G. Furlan, Conformal invariance in quantum mechanics, *Nuovo Cim. A* 34, 569 (1976).
- [29] E. Witten, Dynamical breaking of supersymmetry, *Nucl. Phys. B* 188, 513 (1981).
- [30] V. P. Akulov and A. I. Pashnev, Quantum superconformal model in (1,2) space, *Theor. Math. Phys.* 56, 862 (1983) [*Teor. Mat. Fiz.* 56, 344 (1983)].
- [31] S. Fubini and E. Rabinovici, Superconformal quantum mechanics, *Nucl. Phys. B* 245, 17 (1984).

- [32] R. Van Royen and V. F. Weisskopf, Hadron decay processes and the quark model, *Nuovo Cim. A* **50** 617 (1967).
- [33] E. V. Shuryak, Hadrons containing a heavy quark and QCD sum rules, *Nucl. Phys. B* **198**, 83 (1982).
- [34] N. Isgur and M. B. Wise, Spectroscopy with heavy quark symmetry, *Phys. Rev. Lett.* **66** (1991) 1130.
- [35] R. Aaij *et al.* [LHCb Collaboration], “Observation of the doubly charmed baryon Ξ_{cc}^{++} ,” [arXiv:1707.01621 [hep-ex]].
- [36] M. Karliner and J. L. Rosner, “Discovery of doubly-charmed Xi_{cc} s baryon implies a stable (b b ubar dbar) tetraquark,” [arXiv:1707.07666 [hep-ph]].
- [37] M. A. Shifman, A. I. Vainshtein and V. I. Zakharov, *Nucl. Phys. B* **147** (1979) 385, doi:10.1016/0550-3213(79)90022-1.
- [38] M. Abramowitz and I. A. Stegun, “Pocketbook of Mathematical Functions”, NBS, 1964, abridged version, 1984.
- [39] F. Jugeau, S. Narison and H. Ratsimbarison, *Phys. Lett. B* **722** (2013) 111, doi:10.1016/j.physletb.2013.04.008 [arXiv:1302.6909 [hep-ph]].
- [40] P. Colangelo, F. De Fazio, F. Giannuzzi, F. Jugeau and S. Nicotri, *Phys. Rev. D* **78** (2008) 055009 doi:10.1103/PhysRevD.78.055009, [arXiv:0807.1054 [hep-ph]].
- [41] J. Erlich, G. D. Kribs and I. Low, *Phys. Rev. D* **73** (2006) 096001, doi:10.1103/PhysRevD.73.096001 [arXiv:hep-th/0602110].
- [42] A. A. Migdal, “Multicolor QCD as dual resonance theory,” *Annals Phys.* **109**, 365 (1977).
- [43] G. F. de Teramond and S. J. Brodsky, “Hadronic form factor models and spectroscopy within the gauge/gravity correspondence” [arXiv:1203.4025 [hep-ph]].
- [44] J. Polchinski and M. J. Strassler, “Deep inelastic scattering and gauge/string duality,” *JHEP* **0305**, 012 (2003) [arXiv:hep-th/0209211].
- [45] J. Polchinski and M. J. Strassler, *Phys. Rev. Lett.* **88** (2002) 031601, doi:10.1103/PhysRevLett.88.031601, [hep-th/0109174].
- [46] S. J. Brodsky and G. R. Farrar, *Phys. Rev. Lett.* **31** (1973) 1153.
- [47] S. J. Brodsky and G. R. Farrar, “Scaling Laws for Large Momentum Transfer Processes,” *Phys. Rev. D* **11** (1975) 1309.
- [48] S. D. Drell and T. M. Yan, “Connection of elastic electromagnetic nucleon form-factors at large Q^2 and deep inelastic structure functions near threshold,” *Phys. Rev. Lett.* **24**, 181 (1970).
- [49] G. B. West, “Phenomenological model for the electromagnetic structure of the proton,” *Phys. Rev. Lett.* **24**, 1206 (1970).

- [50] Z. Abidin and C. E. Carlson, “Nucleon electromagnetic and gravitational form factors from holography,” *Phys. Rev. D* **79** (2009) 115003, doi:10.1103/PhysRevD.79.115003 [arXiv:0903.4818 [hep-ph]].