

UNWEIGHTED DONALDSON-THOMAS THEORY OF THE BANANA 3-FOLD WITH SECTION CLASSES

OLIVER LEIGH

ABSTRACT. We further the study of the Donaldson-Thomas theory of the banana threefolds which were recently discovered and studied by Bryan in [Br]. These are smooth proper Calabi-Yau threefolds which are fibred by Abelian surfaces such that the singular locus of a singular fibre is a non-normal toric curve known as a “banana configuration”. In [Br] the Donaldson-Thomas partition function for the rank 3 sub-lattice generated by the banana configurations is calculated. In this article we provide calculations with a view towards the rank 4 sub-lattice generated by a section and the banana configurations. We relate the findings to the Pandharipande-Thomas theory for a rational elliptic surface and present new Gopakumar-Vafa invariants for the banana threefold.

CONTENTS

1. Introduction	2
1.1. Donaldson-Thomas Partition Functions	2
1.2. Donaldson-Thomas Theory of Banana Threefolds	3
1.3. Notation	8
1.4. Future	8
1.5. Acknowledgements	8
2. Overview of the Computation	8
2.1. Overview of the Method of Calculation	8
2.2. Review of Euler characteristic	12
2.3. Pushing Forward to the Chow Variety	13
3. Parametrising Underlying 1-cycles	14
3.1. Related Linear Systems in Rational Elliptic Surfaces	14
3.2. Curve Classes and 1-cycles in the Threefold	15
3.3. Analysis of 1-cycles in Smooth Fibres of pr	16
3.4. Analysis of 1-cycles in Singular Fibres of pr	17
3.5. Parametrising 1-cycles	19
4. Techniques for Calculating Euler Characteristic	22
4.1. Quot Schemes and their Decomposition	22
4.2. An Action on the Formal Neighbourhoods	22
4.3. Partitions and the topological vertex	25
4.4. Partition Thickened Section, Fibre and Banana Curves	26
4.5. Relation between Quot Schemes on \mathbb{C}^3 and the Topological Vertex	30
5. Calculating the Euler Characteristic from the Fibres of the Chow Map	32
5.1. Calculation for the class $\sigma + (0, \bullet, \bullet)$	32
5.2. Preliminaries for classes of the form $\bullet\sigma + (i, j, \bullet)$	37
5.3. Calculation for the class $\bullet\sigma + (0, 0, \bullet)$	41
5.4. Calculation for the class $\bullet\sigma + (0, 1, \bullet)$	41
5.5. Calculation for the class $\bullet\sigma + (1, 1, \bullet)$	44

6. Appendix	57
6.1. Connected Invariants and their Partition Functions	57
6.2. Linear System in $\mathbb{P}^1 \times \mathbb{P}^1$	59
6.3. Topological Vertex Formulas	61
References	64

1. INTRODUCTION

1.1. Donaldson-Thomas Partition Functions. Donaldson-Thomas theory provides a virtual count of curves on a threefold. It gives us valuable information about the structure of the threefold and has strong links to high-energy physics.

For a non-singular Calabi-Yau threefold Y over \mathbb{C} we let

$$\mathrm{Hilb}^{\beta,n}(Y) = \left\{ Z \subset Y \mid [Z] = \beta \in H_2(Y), n = \chi(\mathcal{O}_Z) \right\}$$

be the Hilbert scheme of one dimensional proper subschemes with fixed homology class and holomorphic Euler characteristic. We can define the (β, n) *Donaldson-Thomas invariant* of Y by:

$$\mathrm{DT}_{\beta,n}(Y) = 1 \cap [\mathrm{Hilb}^{\beta,n}(Y)]^{\mathrm{vir}}.$$

Behrend proved the surprising result in [Be] that the Donaldson-Thomas invariants are actually weighted Euler characteristics of the Hilbert scheme:

$$\mathrm{DT}_{\beta,n}(Y) = e(\mathrm{Hilb}^{\beta,n}(Y), \nu) := \sum_{k \in \mathbb{Z}} k \cdot e(\nu^{-1}(k)).$$

Here $\nu : \mathrm{Hilb}^{\beta,n}(Y) \rightarrow \mathbb{Z}$ is a constructible function called the *Behrend function* and its values depend formally locally on the scheme structure of $\mathrm{Hilb}^{\beta,n}(Y)$ [J]. We also define the *unweighted Donaldson-Thomas invariants* to be:

$$\widehat{\mathrm{DT}}_{\beta,n}(Y) = e(\mathrm{Hilb}^{\beta,n}(Y)).$$

These are often closely related to Donaldson-Thomas invariants and their calculation provides insight to the structure of the threefold. Moreover, many important properties of Donaldson-Thomas invariants such as the PT/DT correspondence and the flop formula also hold for the unweighted case [T1, T2].

The depth of Donaldson-Thomas theory is often not clear until one assembles the invariants into a partition function. Let $\{C_1, \dots, C_N\}$ be a basis for $H_2(Y, \mathbb{Z})$, chosen so that if $\beta \in H_2(Y, \mathbb{Z})$ is effective then $\beta = d_1 C_1 + \dots + d_N C_N$ with each $d_i \geq 0$. The Donaldson-Thomas partition function of Y is:

$$\begin{aligned} Z(Y) &:= \sum_{\beta \in H_2(Y, \mathbb{Z})} \sum_{n \in \mathbb{Z}} \mathrm{DT}_{\beta,n}(Y) Q^\beta p^n \\ &:= \sum_{d_1, \dots, d_N \geq 0} \sum_{n \in \mathbb{Z}} \mathrm{DT}_{(\sum_i d_i C_i), n}(Y) Q_1^{d_1} \dots Q_N^{d_N} p^n. \end{aligned}$$

We also define the analogous partition function \widehat{Z} for the unweighted Donaldson-Thomas invariants.

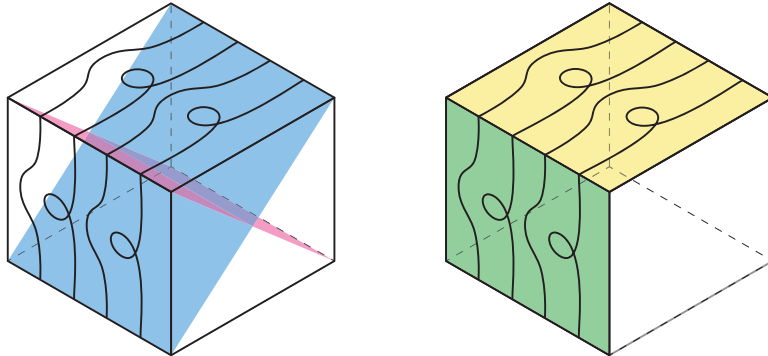

Figure 1. A visual representation of the banana threefold. On the left the diagonal S_Δ and the anti-diagonal S_{op} are highlighted. On the right the two rational elliptic surfaces S_1 and S_2 are highlighted.

Remark 1.1.1. This choice of variable is not necessarily the most canonical as shown in [Br] where the variable p is substituted for $-p$. However, in this article we will be focusing on the unweighted Donaldson-Thomas invariants where this choice makes the most sense.

The Donaldson-Thomas partition function is *very* hard to compute. Indeed, for proper Calabi-Yau threefolds, the only known examples of a complete calculation are in computationally trivial cases. However, when we restrict our attention to subsets of $H_2(Y, \mathbb{Z})$ there are many remarkable results. Two interesting cases which are related to the computations in this article are the Schoen (Calabi-Yau) threefold of [S] and the banana (Calabi-Yau) threefold of [Br].

We will employ computational techniques developed in [BK] for studying Donaldson-Thomas theory of local elliptic surfaces.

1.2. Donaldson-Thomas Theory of Banana Threefolds. The banana threefold is of primary interest to us and is defined as follows. Let $\pi : S \rightarrow \mathbb{P}^1$ be a generic rational elliptic surface with a section $\zeta : \mathbb{P}^1 \rightarrow S$. We will take S to be \mathbb{P}^2 blown-up at 9 points and π given by a generic pencil of cubics. This gives rise to 9 natural choices for ζ and we choose one. The associated *banana threefold* is the blow-up

$$(1) \quad X := \text{Bl}_\Delta(S \times_{\mathbb{P}^1} S)$$

where Δ is the diagonal divisor in $S \times_{\mathbb{P}^1} S$. The surface S is smooth but the morphism $\pi : S \rightarrow \mathbb{P}^1$ is not. It is singular at 12 points of S which are the nodes of the nodal fibres of π . This gives rise to 12 conifold singularities of $S \times_{\mathbb{P}^1} S$ that all lie on the divisor Δ . It also, makes X a conifold resolution of $S \times_{\mathbb{P}^1} S$. X is a non-singular simply connected proper Calabi-Yau threefold [Br, Prop. 28].

There is a natural projection $\text{pr} : X \rightarrow \mathbb{P}^1$ and a unique section $\sigma : \mathbb{P}^1 \rightarrow X$ arising canonically from ζ . The generic fibres of the map $\text{pr} : X \rightarrow \mathbb{P}^1$ are Abelian surfaces of the form $E \times E$ where $E = \pi^{-1}(x)$ is the elliptic curve given by the fibre of a point $x \in \mathbb{P}^1$. The projection map pr also has 12 singular fibres which are non-normal toric surfaces. They are each a compactification of $\mathbb{C}^* \times \mathbb{C}^*$ by a reducible

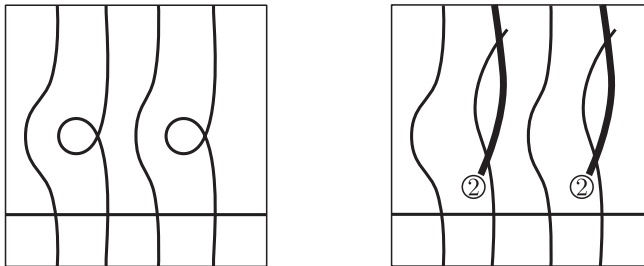

Figure 2. On the left is a visual representation of the rational elliptic surfaces S_1 , S_2 and S_{op} . On the right is the diagonal surface S_{Δ} . Note that the exceptional curves in the fibres of the pencil have order 2.

singular curve called a *banana configuration* (c.f. Definition 1.2.1). Furthermore, the normalisation of a singular $\text{pr}^{-1}(x)$ is isomorphic to $\mathbb{P}^1 \times \mathbb{P}^1$ blown up at 2 points [Br, Prop. 24].

The rational elliptic surface $\pi : S \rightarrow \mathbb{P}^1$, together with the section $\zeta : \mathbb{P}^1 \rightarrow S$, is a Weierstrass fibration. This means that there is a consistent way of choosing Weierstrass coordinates for each fibre (see [Mi, III.1.4]). Thus we have an involution $\iota : S \rightarrow S$ which gives rise to a canonical group law on each fibre where the identity is defined by ζ and the inverse defined by ι .

We will fix four natural divisors of X for the remainder of this article. The first two arise from considering the natural projections $\text{pr}_i : X \rightarrow S$ and the sections $S_i : S \rightarrow X$ arising from ζ . We denote the corresponding divisors by S_1 and S_2 .

The third and fourth natural divisors of X arise by considering the diagonal Δ and anti-diagonal Δ^{op} (the graph of ι) of $S \times_{\mathbb{P}^1} S$. The anti-diagonal intersects the diagonal in a curve on Δ^{op} , so it is unaffected by the blow-up. We denote the anti-diagonal divisor in X by S_{op} and the proper transform of the diagonal by S_{Δ} . The latter is a rational elliptic surface blown-up at the 12 nodal points of the fibres.

Definition 1.2.1. A *banana configuration* is a union of three curves $C_1 \cup C_2 \cup C_3$ where $C_i \cong \mathbb{P}^1$ with $N_{C_i/X} \cong \mathcal{O}(-1) \oplus \mathcal{O}(-1)$ and $C_1 \cap C_2 = C_1 \cap C_3 = C_2 \cap C_3 = \{z_1, z_2\}$ where $z_1, z_2 \in X$ are distinct points. Also, there exist formal neighbourhoods of z_1 and z_2 such that the curves C_i become the coordinate axes in those coordinates. We label these curves by their intersection with the natural surfaces in X . That is C_1 is the unique banana curve that intersects S_1 at one point. Similarly, C_2 intersects S_2 and C_3 intersects S_{op} .

The banana threefold contains 12 copies of the banana configuration. We label the individual banana curves by $C_i^{(j)}$ (and simply C_i when there is no confusion or distinction to be made). We have that $C_i^{(j_1)} \sim C_i^{(j_2)}$ in $H_2(X, \mathbb{Z})$ for each choice of i, j_1 and j_2 . The banana curves C_1, C_2, C_3 generate a sub-lattice $\Gamma_0 \subset H_2(X, \mathbb{Z})$ and we can consider the partition function restricted to these classes:

$$Z_{\Gamma_0} := \sum_{\beta \in \Gamma_0} \sum_{n \in \mathbb{Z}} \text{DT}_{\beta, n}(X) Q^{\beta} p^n.$$

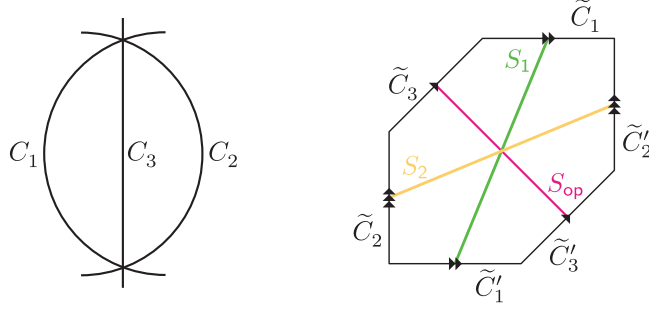

Figure 3. On the left is a depiction of the banana configuration. On the right is the normalisation of the singular fibre $F_{\text{ban}} = \text{pr}^{-1}(x)$ with the restrictions of the surfaces S_1, S_2, S_{op} .

In [Br, Thm. 4], this rank three partition function is computed to be:

$$(2) \quad Z_{\Gamma_0} = \prod_{d_1, d_2, d_3 \geq 0} \prod_k (1 - Q_1^{d_1} Q_2^{d_2} Q_3^{d_3} (-p)^k)^{-12c(\|\mathbf{d}\|, k)}$$

where $\mathbf{d} = (d_1, d_2, d_3)$ and the second product is over $k \in \mathbb{Z}$ unless $\mathbf{d} = (0, 0, 0)$ in which case $k > 0$. (Note the change in variables from [Br].) The powers $c(\|\mathbf{d}\|, k)$ are defined by

$$\sum_{a=-1}^{\infty} \sum_{k \in \mathbb{Z}} c(a, k) Q^a y^k := \frac{\sum_{k \in \mathbb{Z}} Q^{k^2} (-y)^k}{\left(\sum_{k \in \mathbb{Z} + \frac{1}{2}} Q^{2k^2} (-y)^k \right)^2} = \frac{\vartheta_4(2\tau, z)}{\vartheta_1(4\tau, z)^2}$$

such that $\|\mathbf{d}\| := 2d_1d_2 + 2d_2d_3 + 2d_3d_1 - d_1^2 - d_2^2 - d_3^2$, while ϑ_1 and ϑ_4 are Jacobi theta functions with change of variables $Q = e^{2\pi i\tau}$ and $y = e^{2\pi iz}$.

Remark 1.2.2. The calculation of (2) uses a motivic method where the values of the Behrend function are explicitly calculated at the contributing points [Br, Prop. 23]. By removing these weights we can calculate the unweighted partition function \widehat{Z}_{Γ_0} directly. In this case, removing the weights corresponds to the change of variables $Q_i \mapsto -Q_i$ and $p \mapsto -p$ in the Donaldson-Thomas partition function.

We can include the class of the section σ to generate a larger sub-lattice $\Gamma \subset H_2(X, \mathbb{Z})$. The partition function of this sub-lattice is currently unknown. The purpose of this article is to make progress towards understanding this partition function. We will be calculating the unweighted Donaldson-Thomas theory in the classes:

$$\beta = \sigma + (0, d_2, d_3) := \sigma + 0C_1 + d_2C_2 + d_3C_3,$$

by computing the following partition function

$$\widehat{Z}_{\sigma+(0, \bullet, \bullet)} := \sum_{d_2, d_3 \geq 0} \sum_{n \in \mathbb{Z}} \widehat{\text{DT}}_{\beta, n}(Y) Q_2^{d_2} Q_3^{d_3} p^n,$$

which we give in terms of the MacMahon functions $M(p, Q) = \prod_{m>0} (1 - p^m Q)^{-m}$ and their simpler version $M(p) = M(p, 1)$.

Theorem A *The above unweighted Donaldson-Thomas functions are:*

$\widehat{Z}_{\sigma+(0,\bullet,\bullet)}$ is:

$$\widehat{Z}_{(0,\bullet,\bullet)} \frac{p}{(1-p)^2} \prod_{m>0} \frac{1}{(1-Q_2^m Q_3^m)^8 (1-pQ_2^m Q_3^m)^2 (1-p^{-1}Q_2^m Q_3^m)^2}$$

where $\widehat{Z}_{(0,\bullet,\bullet)}$ is the Q_1^0 part of the unweighted version of the Γ_0 partition function (2) and is given by:

$$M(p)^{24} \prod_{d>0} \frac{M(p, Q_2^d Q_3^d)^{24}}{(1-Q_2^d Q_3^d)^{12} M(p, -Q_2^{d-1} Q_3^d)^{12} M(p, -Q_2^d Q_3^{d-1})^{12}}.$$

In the following corollary, the connected unweighted *Pandharipande-Thomas* version of the above formula is identified as the connected version of the Pandharipande-Thomas theory for a rational elliptic surface [BK, Cor. 2].

Corollary B *The connected unweighted Pandharipande-Thomas partition function is:*

$$\begin{aligned} \widehat{Z}_{\sigma+(0,\bullet,\bullet)}^{\text{PT,Con}} &:= \log \left(\frac{\widehat{Z}_{\sigma+(0,\bullet,\bullet)}}{\widehat{Z}_{(0,\bullet,\bullet)}|_{Q_i=0}} \right) \\ &= \frac{-p}{(1-p)^2} \prod_{m>0} \frac{1}{(1-Q_2^m Q_3^m)^8 (1-pQ_2^m Q_3^m)^2 (1-p^{-1}Q_2^m Q_3^m)^2}. \end{aligned}$$

We will also be computing the unweighted Donaldson-Thomas theory in the classes:

$$\beta = b\sigma + (0, 0, d_3), \quad \beta = b\sigma + (0, 1, d_3) \quad \text{and} \quad \beta = b\sigma + (1, 1, d_3)$$

and the permutations involving C_1, C_2 . So for $i, j \in \{0, 1\}$ we define

$$\widehat{Z}_{\bullet\sigma+(i,j,\bullet)} := \sum_{b, d_3 \geq 0} \sum_{n \in \mathbb{Z}} \widehat{\text{DT}}_{\beta, n}(Y) Q_\sigma^b Q_3^{d_3} p^n.$$

The formulas will be given in terms of the functions which are defined for $g \in \mathbb{Z}$:

$$\psi_g = \psi_g(p) := \left(p^{\frac{1}{2}} - p^{-\frac{1}{2}} \right)^{2g-2} = \left(\frac{p}{(1-p)^2} \right)^{1-g}.$$

Theorem C *The above unweighted Donaldson Thomas functions are:*

(1) $\widehat{Z}_{\bullet\sigma+(0,0,\bullet)}$ is:

$$M(p)^{24} \prod_{m>0} (1+p^m Q_\sigma)^m (1+p^m Q_3)^{12m}.$$

(2) $\widehat{Z}_{\bullet\sigma+(0,1,\bullet)} = \widehat{Z}_{\bullet\sigma+(1,0,\bullet)}$ is:

$$\widehat{Z}_{\bullet\sigma+(0,0,\bullet)} \cdot \left((12\psi_0 + Q_3(24\psi_0 + 12\psi_1) + Q_3^2(12\psi_0)) + Q_\sigma Q_3(12\psi_0 + 2\psi_1) \right)$$

(3) $\widehat{Z}_{\bullet\sigma+(1,1,\bullet)}$ is:

$$\begin{aligned} & \widehat{Z}_{\bullet\sigma+(0,0,\bullet)} \\ & \cdot \left(\left((144\psi_{-1} + 24\psi_0 + 12\psi_1) + Q_3(576\psi_{-1} + 384\psi_0 + 72\psi_1 + 12\psi_2) \right. \right. \\ & \quad + Q_3^2(864\psi_{-1} + 720\psi_0 + 264\psi_1 + 24\psi_2) \\ & \quad \left. \left. + Q_3^3(576\psi_{-1} + 384\psi_0 + 72\psi_1 + 12\psi_2) + Q_3^4(144\psi_{-1} + 24\psi_0 + 12\psi_1) \right) \right) \\ & + Q_\sigma \left((12\psi_0 + 2\psi_1) + Q_3(288\psi_{-1} + 96\psi_0 + 44\psi_1) \right. \\ & \quad + Q_3^2(576\psi_{-1} + 600\psi_0 + 156\psi_1 + 24\psi_2) \\ & \quad \left. + Q_3^3(288\psi_{-1} + 96\psi_0 + 44\psi_1) + Q_3^4(12\psi_0 + 2\psi_1) \right) \\ & + Q_\sigma^2 Q_3^2 (144\psi_{-1} + 48\psi_0 + 4). \end{aligned}$$

The connected unweighted *Pandharipande-Thomas* versions of the formulae in theorem C contain the same information but are given in a much more compact form. In fact we can present the same information in an even more compact form using the unweighted *Gopakumar-Vafa* invariants \widehat{n}_β^g via the expansion

$$\begin{aligned} & \widehat{Z}_\Gamma^{\text{PT,Con}}(X) \\ & := \sum_{\beta \in \Gamma \setminus \{0\}} \sum_{g \geq 0} \sum_{m > 0} \widehat{n}_\beta^g \psi_g(p^m) (-Q)^{m\beta} \\ & := \sum_{\substack{b, d_1, d_2, d_3 \geq 0 \\ (b, d_1, d_2, d_3) \neq 0}} \sum_{g \geq 0} \sum_{m > 0} \widehat{n}_{(b, d_1, d_2, d_3)}^g \psi_g(p^m) (-Q_\sigma)^{mb} (-Q_1)^{md_1} (-Q_2)^{md_2} (-Q_3)^{md_3}. \end{aligned}$$

As noted before, these express the same information as the previous generating functions. For $\beta = (d_1, d_2, d_3)$, these invariants are given in [Br, §A.5]. We present the new invariants for $\beta = b\sigma + (i, j, d_3)$ where $b > 0$.

Corollary D *Let $i, j \in \{0, 1\}$, $b > 0$ and $\beta = b\sigma + (i, j, d_3)$. The unweighted Gopakumar-Vafa invariants \widehat{n}_β^g are given by:*

- 1) If $b > 1$ we have $\widehat{n}_\beta^g = 0$.
- 2) If $b = 1$ then the non-zero invariants are given in the following table:

(d_1, d_2, d_3)	(0, 0, 0)	(0, 1, 1)	(1, 0, 1)	(1, 1, 0)	(1, 1, 1)	(1, 1, 2)	(1, 1, 3)	(1, 1, 4)
$g = 0$	1	12	12	12	48	216	48	12
$g = 1$	0	2	2	2	44	108	44	2
$g = 2$	0	0	0	0	0	24	0	0

Remark 1.2.3. We note that the values given only depend on the quadratic form $\|\mathbf{d}\| := 2d_1d_2 + 2d_1d_3 + 2d_2d_3 - d_1^2 - d_2^2 - d_3^2$ appearing in the rank 3 Donaldson-Thomas partition function of [Br, Thm. 4]. However, there is no immediate geometric explanation for this fact.

Corollaries B and D will be proved in section 6.1.

1.3. **Notation.** The main notations for this article have been defined above in section 1.2. In particular X will always denote the banana threefold as defined in equation (1).

1.4. **Future.** The calculation here is for the unweighted Donaldson-Thomas partition function. However, the method of [BK] also provides a route (up to a conjecture [BK, Conj. 21]) of computing the Donaldson-Thomas partition function. The following are needed in order to convert the given calculation:

- 1) A proof showing the invariance of the Behrend function under the $(\mathbb{C}^*)^2$ -action used on the strata.
- 2) A computation of the dimensions of the Zariski tangent spaces for the various strata.

A comparison of the unweighted and weighted partition functions of the rank 3 lattice of [Br] reveals the likely differences:

In the variables chosen in this article one can pass from the unweighted to the weighted partition functions by the change of variables $Q_i \mapsto -Q_i$ and $p \mapsto -p$.

Moreover, the conifold transition formula reveals further insight by a comparison with the Donaldson-Thomas partition function of the Schoen threefold with a single section and all fibre classes. The Donaldson-Thomas theory of the Schoen threefold with a section class was shown in [OP] (via the reduced theory of the product of a $K3$ surface with an elliptic curve) to be given by the weight 10 Igusa cusp form.

As we mentioned previously the Donaldson-Thomas partition function is very hard to compute. So much so that for proper Calabi-Yau threefolds, the only known complete examples are in computationally trivial cases. This is even true conjecturally and even a conjecture for the rank 4 partition function is highly desirable. The work here shows underlying structures that a conjectured partition function must have.

1.5. **Acknowledgements.** I would like to thank both Jim Bryan and Stephen Pietromonaco for very useful discussions. I would also like to thank the anonymous referee for their extremely valuable comments and suggestions.

2. OVERVIEW OF THE COMPUTATION

2.1. **Overview of the Method of Calculation.** We will closely follow the method of [BK] developed for studying the Donaldson-Thomas theory of local elliptic surfaces. However, due to some differences in geometry a more subtle approach is required in some areas. In particular, the local elliptic surfaces have a global action which reduces the calculation to considering only the so-called *partition thickened curves*.

Our method is based around the following *continuous map*:

$$\text{Cyc} : \text{Hilb}^{\beta,n}(X) \rightarrow \text{Chow}^{\beta}(X).$$

which takes a one dimensional subscheme to its 1-cycle. Here $\text{Chow}^{\beta}(X)$ is the Chow *variety* parametrising 1-cycles in the class $\beta \in H_2(X, \mathbb{Z})$ (as defined in [K, Thm. I 3.20]). The fibres of this map are of particular importance and we denote them by $\text{Hilb}_{\text{Cyc}}^n(X, \mathfrak{q})$ where $\mathfrak{q} \in \text{Chow}_1(X)$. Each $\text{Hilb}_{\text{Cyc}}^n(X, \mathfrak{q})$ is a closed subset of $\text{Hilb}^{n,\beta}(X)$ and hence has the natural structure of a reduced subscheme of $\text{Hilb}^{n,\beta}(X)$ (see [St, Tag 01J3] for more details).

Remark 2.1.1. No such morphism exists in the algebraic category. In fact we note from [K, Thm. I 6.3] that there is only a morphism from the semi-normalisation $\text{Hilb}^{\beta,n}(X)^{SN} \rightarrow \text{Chow}^n(X)$. However, the semi-normalisation $\text{Hilb}^{\beta,n}(X)^{SN}$ is homeomorphic to $\text{Hilb}^{\beta,n}(X)$, which gives rise to the above continuous map.

Remark 2.1.2. While no Hilbert-Chow morphism exists for the Chow *variety*, there is a promising theory of relative cycles developed in [Ry, Paper IV] which allows for the construction of a morphism of functors. These results were used in [R2] to study the Donaldson-Thomas theory of smooth curves.

Broadly, we will be calculating the Euler characteristics $e(\text{Hilb}^{\beta,n}(X))$ using the following method:

- 1) Push forward the calculation to an Euler characteristic on $\text{Chow}^{\beta}(X)$, weighted by the constructible function $(\text{Cyc}_*1)(\mathfrak{q}) := e(\text{Hilb}_{\text{Cyc}}^n(X, \mathfrak{q}))$. This is further described in sections 2.2 and 2.3.
- 2) Analyse the image of Cyc and decompose it into combinations of symmetric products where the strata are based on the types of subscheme in the fibres $\text{Hilb}_{\text{Cyc}}^n(X, \mathfrak{q})$. This is done in section 3.
- 3) Compute the Euler characteristic of the fibres $e(\text{Hilb}_{\text{Cyc}}^n(X, \mathfrak{q}))$ and show that they form a constructible function on the combinations of symmetric products. This is done in section 5.
- 4) Use the following lemma to give the Euler characteristic partition function.

Lemma 2.1.3. [BK, Lemma 32] *Let Y be finite type over \mathbb{C} and let $g : \mathbb{Z}_{\geq 0} \rightarrow \mathbb{Z}((p))$ be any function with $g(0) = 1$. Let $G : \text{Sym}^d(Y) \rightarrow \mathbb{Z}((p))$ be the constructible function defined by*

$$G(\mathbf{a}\mathbf{x}) = \prod_i g(a_i)$$

where $\mathbf{a}\mathbf{x} = \sum_i a_i x_i \in \text{Sym}^d(Y)$ and $x_i \in Y$ are distinct points. Then

$$\sum_{d=0}^{\infty} e(\text{Sym}^d(Y), G) q^d = \left(\sum_{a=0}^{\infty} g(a) q^a \right)^{e(Y)}$$

where the G -weighted Euler characteristic $e(-, G)$ is defined in equation (3).

To compute the Euler characteristics of the fibres $(\text{Cyc}_*1)(\mathfrak{q}) := e(\text{Hilb}_{\text{Cyc}}^n(X, \mathfrak{q}))$ we use the following method made rigorous in section 4:

- 1) Denote the open subset consisting entirely of Cohen-Macaulay subschemes by $\text{Hilb}_{\text{CM}}^n(X, \mathfrak{q}) \subset \text{Hilb}_{\text{Cyc}}^n(X, \mathfrak{q})$, and define the notation $\text{Hilb}_{\text{CM}}^{\diamond}(X, \mathfrak{q}) := \coprod_{m \in \mathbb{Z}} \text{Hilb}_{\text{CM}}^m(X, \mathfrak{q})$.

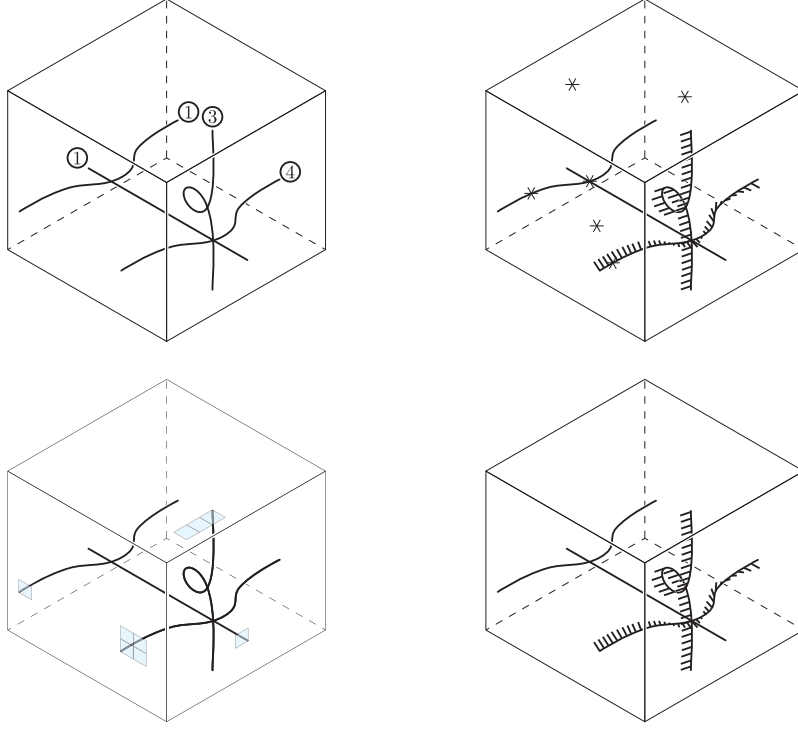

Figure 4. A depiction of the process for reducing to partition thickened curves. Clockwise from the top-left we have: a) Consider a 1-cycle in the Chow scheme; b) Consider the fibre of the given 1-cycle; c) Reduce to a computation on the open subset of Cohen-Macaulay subschemes; d) Reduce to a computation on partition thickened schemes.

- 2) Consider the constructible map which takes a subscheme Z to the maximal Cohen-Macaulay subscheme $Z_{\text{CM}} \subset Z$ and denote the constructible map by $\kappa_n : \text{Hilb}_{\text{Cyc}}^n(X, \mathfrak{q}) \rightarrow \text{Hilb}_{\text{CM}}^\diamond(X, \mathfrak{q})$.
- 3) Note the equality of the Euler characteristic $e(\text{Hilb}_{\text{Cyc}}^n(X, \mathfrak{q}))$ and that of the weighted Euler characteristic $e(\text{Hilb}_{\text{CM}}^\diamond(X, \mathfrak{q}), (\kappa_n)_* 1)$ where $(\kappa_n)_* 1$ is the constructible function $((\kappa_n)_* 1)(\mathfrak{p}) := e(\kappa_n^{-1}(\mathfrak{p}))$.
- 4) Define a $(\mathbb{C}^*)^2$ -action on $\text{Hilb}_{\text{CM}}^\diamond(X, \mathfrak{q})$ and show that $\kappa_* 1(\mathfrak{p}) = \kappa_* 1(\alpha \cdot \mathfrak{p})$ meaning $e(\text{Hilb}_{\text{Cyc}}^n(X, \mathfrak{q})) = e(\text{Hilb}_{\text{CM}}^\diamond(X, \mathfrak{q})^{(\mathbb{C}^*)^2}, \kappa_* 1)$. This technique is discussed in section 4.2.
- 5) Identify the $(\mathbb{C}^*)^2$ -fixed points $\text{Hilb}_{\text{CM}}^\diamond(X, \mathfrak{q})^{(\mathbb{C}^*)^2}$ as a discrete subset containing partition thickened curves. These neighbourhoods and this action are given explicitly in section 4.4.
- 6) Calculate the Euler characteristics $e(\text{Hilb}_{\text{CM}}^\diamond(X, \mathfrak{q})^{(\mathbb{C}^*)^2}, \kappa_* 1)$ using the Quot scheme decomposition and topological vertex method of [BK]. The concept of this is depicted in figure 5 and described below. Further technical details are given in section 4.5.

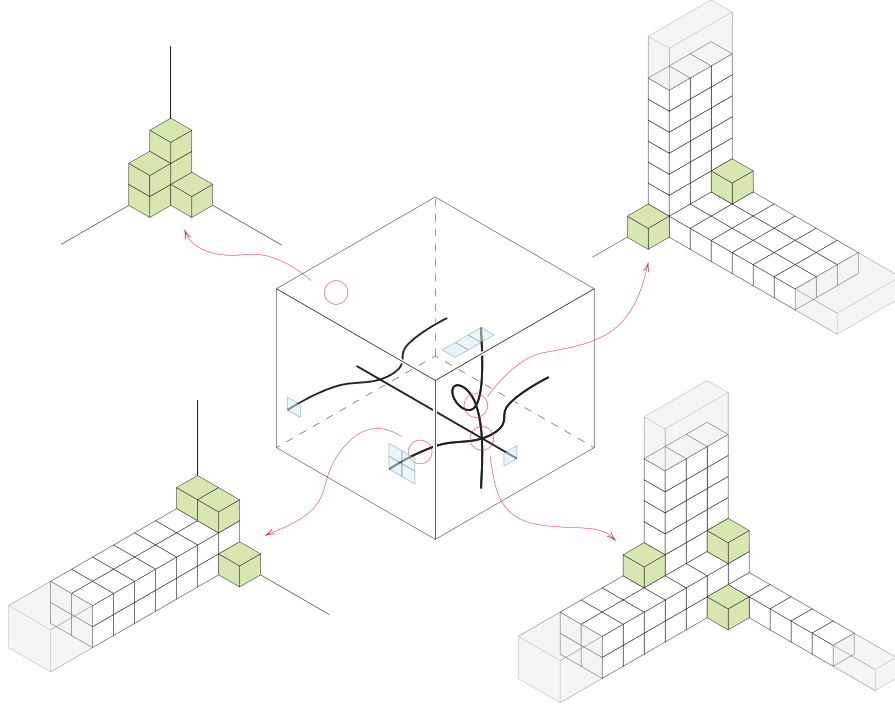

Figure 5. A depiction of how the topological vertex is applied to calculate Euler characteristic of a given stratum.

The Euler characteristic calculation of $e(\text{Hilb}_{\text{CM}}^{\diamond}(X, \mathfrak{q})^{(\mathbb{C}^*)^2}, \kappa_*1)$ for theorems **A** and **C** follow similar methods but have different decompositions. The calculations are completed by considering the different types of topological vertex that occur for each fixed point in $\text{Hilb}_{\text{CM}}^m(X, \mathfrak{q})^{(\mathbb{C}^*)^2}$ for $m \in \mathbb{Z}$.

Since the fixed locus $\text{Hilb}_{\text{CM}}^m(X, \mathfrak{q})^{(\mathbb{C}^*)^2}$ will be a discrete set, we can consider the individual subschemes $C \in \text{Hilb}_{\text{CM}}^m(X, \mathfrak{q})^{(\mathbb{C}^*)^2}$ and their contribution to the Euler characteristic $e(\text{Hilb}_{\text{CM}}^{\diamond}(X, \mathfrak{q})^{(\mathbb{C}^*)^2}, \kappa_*1)$. To compute the contribution from C we must decompose X as follows:

- 1) Take the complement $W = X \setminus C$.
- 2) Consider, C° , the set of singularities of the underlying reduced curve.
- 3) Define $C^{\circ} = C^{\text{red}} \setminus C^{\circ}$ to be its complement.

The curve C will be partition thickened. So each formal neighbourhood of a point $x \in C^{\circ}$ will give rise to a 3D partition asymptotic to a collection of three partitions (depicted on the righthand side of figure 5). Similarly, points on C° and W will give rise to 3D partitions asymptotic to collections of three partitions. However, for C° only one of the three partitions will be non-empty and for W all three partitions will be empty (depicted respectively on the bottom-left and top-left parts of figure 5). Using techniques from section 4.5 the Euler characteristics can then be determined.

This calculation for theorem A is finalised in section 5.1. Generalities for the proof of theorem C are given in section 5.2 and the individual calculations are given in sections 5.3, 5.4 and 5.5.

2.2. Review of Euler characteristic. We begin by recalling some facts about the (topological) Euler characteristic. For a scheme Y over \mathbb{C} we denote by $e(Y)$ the topological Euler characteristic in the complex analytic topology on Y . This is independent of any non-reduced structure of Y , is additive under decompositions of Y into open sets and their complements, and is multiplicative on Cartesian products. In this way we see that the Euler characteristic defines a ring homomorphism from the Grothendieck ring of varieties to the integers:

$$e : K_0(\text{Var}_{\mathbb{C}}) \longrightarrow \mathbb{Z}.$$

If Y has a \mathbb{C}^* -action with fixed locus $Y^{\mathbb{C}^*} \subset Y$ the Euler characteristic also has the property $e(Y^{\mathbb{C}^*}) = e(Y)$ [Bi, Cor. 2].

The interaction of Euler characteristic with constructible functions plays a key role in this article. Recall that a function $\mu : Y \rightarrow \mathbb{Z}((p))$ is constructible if $\mu(Y)$ is finite and $\mu^{-1}(c)$ is the union of finitely many locally closed sets for all non-zero $c \in \mu(Y)$. The μ -weight Euler characteristic is a ring homomorphism

$$(3) \quad e(-, \mu) : K_0(\text{Var}_{\mathbb{C}}) \longrightarrow \mathbb{Z}((p))$$

defined by $e(Y, \mu) = \sum_{k \in \mathbb{Z}((p))} k \cdot e(\mu^{-1}(k))$. The constant function 1 and the Behrend function ν are two canonical examples of constructible functions with images in $\mathbb{Z} \subset \mathbb{Z}((p))$. Moreover, the usual Euler characteristic is $e(Y) = e(Y, 1)$ where 1 is the constant function.

For a scheme Z over \mathbb{C} , a constructible map $f : Y \rightarrow Z$ is a finite collection of continuous functions $f_i : Y_i \rightarrow Z_i$ where $Y = \coprod_i Y_i$ is a decomposition into locally closed subsets and $Z_i \subseteq Z$. A constructible homeomorphism is a constructible map such that each f_i is a homeomorphism and $Z = \coprod_i Z_i$ is a decomposition into locally closed subsets. When $f : Y \rightarrow Z$ is a constructible map we define the constructible function $f_*\mu : Z \rightarrow \mathbb{Z}((p))$ by

$$(f_*\mu)(x) := e(f^{-1}(x), \mu).$$

This has the important property $e(Z, f_*\mu) = e(Y, \mu)$. If $\omega : Z \rightarrow \mathbb{Z}((p))$ is another constructible function, then $\mu \cdot \omega$ is a constructible function on $Y \times Z$ and $e(Y \times Z, \mu \cdot \omega) = e(Y, \mu) \cdot e(Z, \omega)$.

It will be useful to consider the rings of formal power series in Q_i and formal Laurent series in p with coefficients in $K_0(\text{Var}_{\mathbb{C}})$. An element $P \in K_0(\text{Var}_{\mathbb{C}})[[Q_i]]((p))$ is an *indexed* disjoint union of varieties where the indexing is given by monomials. A constructible function $\mu : (\sum_{d_i} \sum_n Q_i^{d_i} p^n Y_{d_i, n}) \rightarrow \mathbb{Z}((p))$ is an indexed collection of constructible functions $\mu_{d_i, n} : Y_{d_i, n} \rightarrow \mathbb{Z}((p))$. Moreover, we extend Euler characteristic to a ring homomorphism

$$e(-, \mu) : K_0(\text{Var}_{\mathbb{C}})[[Q_i]]((p)) \longrightarrow \mathbb{Z}[[Q_i]]((p))$$

preserving the indexing $e(\sum_{d_i} \sum_n Q_i^{d_i} p^n Y_{d_i, n}, \mu) := \sum_{d_i} \sum_n Q_i^{d_i} p^n e(Y_{d_i, n}, \mu_{d_i, n})$.

Lastly, we extend the definition of constructible map to formal series of varieties in two different ways. Firstly, a constructible map $f : \sum_n p^n Y_n \rightarrow Z$ is an indexed collection of constructible maps $f_n : Y_n \rightarrow Z$, and secondly, a constructible map $g : \sum_{d_i} \sum_n p^n Y_{d_i, n} \rightarrow \sum_{d_i} Z_{d_i}$ is an indexed collection of constructible maps $g_{d_i} : \sum_n Y_{d_i, n} \rightarrow Z_{d_i}$. We can now also define the push-forwards of constructible functions as before.

2.3. Pushing Forward to the Chow Variety. Recall that the Chow variety $\text{Chow}^\beta(X)$ is a space parametrising the one dimensional cycles of X in the class $\beta \in H_2(X, \mathbb{Z})$. We then have a constructible map

$$\rho_\beta : \sum_n p^n \text{Hilb}^{\beta, n}(X) \rightarrow \text{Chow}^\beta(X).$$

The strategy for calculating the partition functions is to analyse $\text{Chow}^\beta(X)$ and the fibres of the map ρ_β . These will often involve the symmetric product, and where possible we will apply lemma 2.1.3.

It will be convenient to employ the following \bullet -notations for the Hilbert schemes

$$\begin{aligned} \text{Hilb}^{\sigma+(0, \bullet, \bullet), \bullet}(X) &:= \sum_{d_2, d_3 \geq 0} \sum_{n \in \mathbb{Z}} Q_\sigma Q_2^{d_2} Q_3^{d_3} p^n \text{Hilb}^{\sigma+(0, d_2, d_3), n}(X) \\ \text{Hilb}^{\bullet\sigma+(i, j, \bullet), \bullet}(X) &:= \sum_{b, d_3 \geq 0} \sum_{n \in \mathbb{Z}} Q_\sigma^b Q_1^i Q_2^j Q_3^{d_3} p^n \text{Hilb}^{b\sigma+(i, j, d_3), n}(X) \end{aligned}$$

and for the Chow varieties

$$\begin{aligned} \text{Chow}^{\sigma+(0, \bullet, \bullet)}(X) &:= \sum_{d_2, d_3 \geq 0} Q_\sigma Q_2^{d_2} Q_3^{d_3} \text{Chow}^{\sigma+(0, d_2, d_3)}(X) \\ \text{Chow}^{\bullet\sigma+(i, j, \bullet)}(X) &:= \sum_{b, d_3 \geq 0} Q_\sigma^b Q_1^i Q_2^j Q_3^{d_3} \text{Chow}^{b\sigma+(i, j, d_3)}(X) \end{aligned}$$

where we have viewed the Hilbert scheme and Chow variety as elements in the Grothendieck ring of varieties, and $i, j \in \{0, 1\}$. The notation $\mathfrak{q} \in \text{Chow}^{\sigma+(0, \bullet, \bullet)}(X)$ and $\mathfrak{q} \in \text{Chow}^{\bullet\sigma+(i, j, \bullet)}(X)$ will denote $\mathfrak{q} \in \text{Chow}^\beta(X)$ for some $\beta \in H_2(X, \mathbb{Z})$. This is what we will mean by the ‘‘points’’ of $\text{Chow}^{\sigma+(0, \bullet, \bullet)}(X)$ and $\text{Chow}^{\bullet\sigma+(i, j, \bullet)}(X)$. \mathfrak{q} will often be given without any associated monomial since that is usually implicitly understood. The \bullet -notation is extended to symmetric products by

$$\text{Sym}_Q^\bullet(Y) := \sum_{n \in \mathbb{Z}_{\geq 0}} Q^n \text{Sym}^n(Y),$$

and we use the following notation for elements of the symmetric product

$$\mathbf{a}\mathbf{y} := \sum_i a_i y_i \in \text{Sym}^n(Y)$$

where y_i are distinct points on Y and $a_i \in \mathbb{Z}_{\geq 0}$. We also denote a tuple of partitions $\boldsymbol{\alpha}$ of a tuple of non-negative integers \mathbf{a} by $\boldsymbol{\alpha} \vdash \mathbf{a}$. As was the case with the Chow variety, we think of $\mathbf{a}\mathbf{y}$ as being a point in $\text{Sym}_Q^\bullet(Y)$.

Using the \bullet -notation for the maps ρ_β we create the following constructible maps:

$$\begin{aligned} \rho_\bullet &: \text{Hilb}^{\sigma+(0, \bullet, \bullet), \bullet}(X) \rightarrow \text{Chow}^{\sigma+(0, \bullet, \bullet)}(X) \\ \eta_\bullet^{ij} &: \text{Hilb}^{\bullet\sigma+(i, j, \bullet), \bullet}(X) \rightarrow \text{Chow}^{\bullet\sigma+(i, j, \bullet)}(X) \end{aligned}$$

and we also use the notation $\eta_\bullet = \eta_\bullet^{00} + \eta_\bullet^{01} + \eta_\bullet^{11}$. The fibres of these maps will be formal sums of subsets of the Hilbert schemes parametrising one dimensional subschemes with a fixed 1-cycle. Specifically, let $C \subset X$ be a one dimensional subscheme in the class $\beta \in H_2(X)$ with 1-cycle $\text{Cyc}(C)$. Define $\text{Hilb}^n(X, \text{Cyc}(C)) \subset \text{Hilb}^{\beta, n}(X)$ to be the closed subset

$$\text{Hilb}^n(X, \text{Cyc}(C)) = \{Z \in \text{Hilb}^{\beta, n}(X) \mid \text{Cyc}(Z) = \text{Cyc}(C)\}.$$

The maps ρ_\bullet and η_\bullet are explicitly described in lemmas 3.5.1 and 3.5.3 respectively.

3. PARAMETRISING UNDERLYING 1-CYCLES

3.1. Related Linear Systems in Rational Elliptic Surfaces. In this section we consider some basic results about linear systems on a rational elliptic surface. Some of these result can be found in [BK, §A.1].

Recall our notation that $\pi : S \rightarrow \mathbb{P}^1$ is a generic rational elliptic surface with a canonical section $\zeta : \mathbb{P}^1 \rightarrow S$. Consider the following classical results for rational elliptic surfaces from [Mi, II.3]:

$$\pi_* \mathcal{O}_S \cong \pi_* \mathcal{O}_S(\zeta) \cong \mathcal{O}_{\mathbb{P}^1}, \quad R^1 \pi_* \mathcal{O}_S \cong \mathcal{O}_{\mathbb{P}^1}(-1) \quad \text{and} \quad R^1 \pi_* \mathcal{O}_S(\zeta) \cong 0.$$

After applying the projection formula we have the following:

$$(4) \quad \pi_* \mathcal{O}_S(dF) \cong \pi_* \mathcal{O}_S(\zeta + dF) \cong \mathcal{O}_{\mathbb{P}^1}(d)$$

as well as

$$(5) \quad R^1 \pi_* \mathcal{O}_S(dF) \cong \mathcal{O}_{\mathbb{P}^1}(d-1) \quad \text{and} \quad R^1 \pi_* \mathcal{O}_S(\zeta + dF) \cong 0.$$

Lemma 3.1.1. *We have the following isomorphisms:*

$$H^1(S, \mathcal{O}_S(dF)) \cong H^0(\mathbb{P}^1, \mathcal{O}_{\mathbb{P}^1}(d-1)) \quad \text{and} \quad H^1(S, \mathcal{O}_S(\zeta + dF)) \cong 0.$$

Proof. The second isomorphism is immediate from the vanishing of $R^i \pi_* \mathcal{O}_S(\zeta + dF)$ for $i > 0$ (see for example [H, III Ex. 8.1]) and $H^0(\mathbb{P}^1, \mathcal{O}_{\mathbb{P}^1}(d)) \cong 0$.

To show the first isomorphism we consider the following exact sequence arising from the Leray spectral sequence:

$$H^1(\mathbb{P}^1, \pi_* \mathcal{O}_S(dF)) \rightarrow H^1(S, \mathcal{O}_S(dF)) \rightarrow H^0(\mathbb{P}^1, R^1 \pi_* \mathcal{O}_S(dF)) \rightarrow 0$$

We have from (4) that $H^1(\mathbb{P}^1, \pi_* \mathcal{O}_S(dF)) \cong 0$ and we have the desired isomorphism after considering (5). \square

Lemma 3.1.2. *Consider a fibre F of a point $z \in \mathbb{P}^1$ by the map $S \rightarrow \mathbb{P}^1$ and the image of a section $\zeta : \mathbb{P}^1 \rightarrow S$. Then there are isomorphisms of the linear systems*

$$|dF|_S \cong |\zeta + dF|_S \cong |dz|_{\mathbb{P}^1} \quad \text{and} \quad |b\zeta + F|_S \cong |z|_{\mathbb{P}^1}.$$

Proof. The isomorphism $|\zeta + dF|_S \cong |dz|_{\mathbb{P}^1}$ is immediate from the vanishing of $R^i \pi_* \mathcal{O}_S(\zeta + dF)$ for $i > 0$ and (4) (see for example [H, III Ex. 8.1]).

We continue by showing $|dF|_S \cong |\zeta + dF|_S$. Consider the long exact sequence arising from the divisor sequence for ζ twisted by $\mathcal{O}_S(\zeta + dF)$:

$$\begin{aligned} 0 \rightarrow H^0(S, \mathcal{O}_S(dF)) \xrightarrow{f} H^0(S, \mathcal{O}_S(\zeta + dF)) \rightarrow H^0(S, \zeta_* \mathcal{O}_{\mathbb{P}^1}(\zeta + dF)) \\ \xrightarrow{g} H^0(\mathbb{P}^1, \mathcal{O}_{\mathbb{P}^1}(d-1)) \rightarrow 0 \end{aligned}$$

where we have applied the results from lemma 3.1.1. From intersection theory we have that $\zeta_* \mathcal{O}_{\mathbb{P}^1}(\zeta + dF) \cong \zeta_* \mathcal{O}_{\mathbb{P}^1}(d-1)$. So g and hence f are isomorphisms.

The isomorphism $|b\zeta + F|_S \cong |z|_{\mathbb{P}^1}$ will follow inductively from the divisor sequence for ζ on S :

$$0 \longrightarrow \mathcal{O}_S(k\zeta + F) \longrightarrow \mathcal{O}_S((k+1)\zeta + F) \longrightarrow \mathcal{O}_\zeta((k+1)\zeta + F) \longrightarrow 0.$$

Intersection theory shows us that $\mathcal{O}_\zeta((k+1)\zeta + F)$ is a degree $-k$ line bundle on \mathbb{P}^1 which shows that its 0th cohomology vanishes. Hence, we have isomorphisms:

$$H^0(S, \mathcal{O}_S(F)) \cong \dots \cong H^0(S, \mathcal{O}_S(b\zeta + F)).$$

□

3.2. Curve Classes and 1-cycles in the Threefold. Recall from definition 1.2.1 that the banana curves C_i are labelled by their unique intersections with the rational elliptic surfaces

$$S_1, \quad S_2 \quad \text{and} \quad S_{\text{op}}.$$

These are smooth effective divisors on X . Hence a curve C in the class (d_1, d_2, d_3) will have the following intersections with these divisors:

$$C \cdot S_1 = d_1, \quad C \cdot S_2 = d_2 \quad \text{and} \quad C \cdot S_{\text{op}} = d_3.$$

The full lattice $H_2(X, \mathbb{Z})$ is generated by

$$C_1, C_2, C_3, \sigma_{11}, \sigma_{12}, \dots, \sigma_{19}, \sigma_{21}, \dots, \sigma_{99}$$

where the σ_{ij} are the 81 canonical sections of $\text{pr} : X \rightarrow \mathbb{P}^1$ arising from the 9 canonical sections of $\pi : S \rightarrow \mathbb{P}^1$. However, there are 64 relations between the σ_{ij} 's giving the lattice rank of 20 (see [Br, Prop. 28 and Prop. 29]).

Lemma 3.2.1. *There are no relations in $H_2(X, \mathbb{Z})$ of the form:*

$$n \cdot \sigma_{i,j} + d_1 C_1 + d_2 C_2 + d_3 C_3 = \sum_{(k,l) \neq (i,j)} a_{k,l} \cdot \sigma_{k,l} + d'_1 C_1 + d'_2 C_2 + d'_3 C_3$$

where $n, a_{k,l}, d_t, d'_t \in \mathbb{Z}_{\geq 0}$ for all $k, l \in \{1, \dots, 9\}$ and $t \in \{1, 2, 3\}$.

Proof. Any such relation must push forward to relations on S via the projections $\text{pr}_i : X \rightarrow S_i$. However, S is isomorphic to \mathbb{P}^2 blown up at 9 points. The exceptional divisors of these blow-ups correspond to the sections $\zeta_i : \mathbb{P}^1 \rightarrow S$. Hence

$$\text{Pic } S \cong \text{Pic } \mathbb{P}^2 \times \zeta_1 \times \dots \times \zeta_9 \cong \mathbb{Z}^{10}$$

and there are no relations of this form. □

The next lemma allows us to consider the curves in our desired classes by decomposing them.

Lemma 3.2.2. *Let $d_1, d_2, d_3, b \in \mathbb{Z}_{\geq 0}$ and $i, j \in \{0, 1\}$.*

- 1) *Let C be a Cohen-Macaulay curve in the class (d_1, d_2, d_3) . Then the support of C is contained in fibres of the projection map $\text{pr} : X \rightarrow \mathbb{P}^1$.*
- 2) *A curve C in the class $\sigma + (d_1, d_2, d_3)$ is of the form*

$$C = \sigma \cup C_0$$

where C_0 is a curve in the class (d_1, d_2, d_3) .

3) A curve in the class $b\sigma + (i, j, d_3)$ is of the form

$$C = C_\sigma \cup C_0$$

where C_σ is a curve in the class $b\sigma$ and C_0 is a curve in the class (i, j, d_3) .
The same result holds for permutations of $b\sigma + (i, j, d_3)$.

Proof. Consider a curve in one of the given classes and its image under the two projections $\text{pr}_i : X \rightarrow S_i$. For (1) these must be in the classes $|d_1 f_1|$ and $|d_1 f_1|$, for (2) the classes $|\zeta + d_1 F_1|$ and $|\zeta + d_2 F_2|$, and for (3) the classes $|i f_1|$ and $|j f_1|$. Lemma 3.1.2 now shows that the curve must have the given form. \square

3.3. Analysis of 1-cycles in Smooth Fibres of pr . Consider a fibre $F_x = \text{pr}^{-1}(x)$ which is smooth. Then there is an elliptic curve E such that $F_x \cong E \times E$. Consider a curve C with underlying 1-cycle contained in $E \times E$, then this gives rise to a divisor D in $E \times E$. Hence we must analyse divisors in $E \times E$ and their classes in X . The class of such a curve is determined uniquely by its intersection with the surfaces S_1, S_2 and S_{op} .

Lemma 3.3.1. *Let $C \subset X$ correspond to a divisor D in $E \times E$.*

- 1) *If C is in the class $(0, d_2, d_3)$ then $d_2 = d_3$ and D is the pullback of a degree d_2 divisor on E via the projection to the second factor.*
- 2) *The result in 1) is true for $(d_1, 0, d_3)$ and projection to the first factor.*

Proof. If C is in the class $(0, d_2, d_3)$ then it doesn't intersect with the surface S_1 . When we restrict to $E \times E$ this is the same condition as not intersecting with a fibre of the projection to the second factor. The only divisors that this is true for are those pulled back from E via the projection to the second factor. A divisor of this form will have intersection with S_2 of d_2 and intersection with S_{op} of d_2 . Hence we have that $d_2 = d_3$. The proof for part 2) is completely analogous. \square

Lemma 3.3.2. *Let $C \subset X$ be in the class $(1, 1, d)$ and correspond to a divisor D in $E \times E$. Then $d \in \{0, \dots, 4\}$ and occurs in the following situations:*

- 1) *If E has $j(E) \neq 0, 1728$ then:*
 - a) $d = 0$ occurs when D is a translation of the graph $\{(x, -x)\}$.
 - b) $d = 4$ occurs when D is a translation of the graph $\{(x, x)\}$.
 - c) $d = 2$ occurs when D is the union of a fibre from the projection to the first factor and a fibre from the projection to the second factor.
- 2) *If $j(E) = 1728$ and $E \cong \mathbb{C}/i$ we have the cases a) to c) as well as:*
 - d) $d = 2$ occurs when D is a translation of the graph $\{(x, \pm ix)\}$.
- 3) *If $j(E) = 0$ and $E \cong \mathbb{C}/\tau$ with $\tau = \frac{1}{2}(1 + i\sqrt{3})$ we have the cases a) to c) as well as:*
 - e) $d = 1$ occurs when D is a translation of the graph $\{(x, -\tau x)\}$ or the graph $\{(x, (\tau - 1)x)\}$.
 - f) $d = 3$ occurs when D is a translation of the graph $\{(x, \tau x)\}$ or the graph $\{(x, (-\tau + 1)x)\}$.

Proof. Denote the projection maps by $\text{p}_i : E \times E \rightarrow E$ and let $C \subset X$ be in the class $(1, 1, d)$ and correspond to a divisor D in $E \times E$. Suppose D is reducible. Then from lemma 3.3.1 we see that D must be the union $\text{p}_1^{-1}(x_1) \cup \text{p}_2^{-1}(x_2)$ where $x_1, x_2 \in E$ are generic points. We also have that D is in the class $(1, 1, 2)$.

Suppose D is irreducible. The surfaces S_1 and S_2 intersect D exactly once. So the restrictions $\mathbf{p}_i|_D : D \rightarrow E$ are degree 1 and hence isomorphisms. Thus D is the translation of the graph of an automorphism of E .

All elliptic curves have the automorphisms $x \mapsto \pm x$. Also we have:

- if $E \cong \mathbb{C}/i$ (j -invariant $j(E) = 1728$) the E also has the automorphisms $x \mapsto \pm ix$, and
- if $E = \mathbb{C}/\tau$ with $\tau = \frac{1}{2}(1 + i\sqrt{3})$ (j -invariant $j(E) = 0$) then E also has the automorphisms $x \mapsto \pm\tau x$ and $x \mapsto \pm(\tau - 1)x$.

So to complete the proof we have to calculate the intersections $\#(\Gamma_\xi \cap S_{\text{op}})$ where Γ_ξ is the graph of an automorphism ξ . Also, $S_{\text{op}}|_{F_x} \cong \Gamma_{-1}$ hence we calculate $\#(\Gamma_\xi \cap \Gamma_{-1}) = \#\{(x, \xi(x)) = (x, -x)\}$ in the surface F_x . For all the elliptic curves we have:

- (a) $\#(\Gamma_1 \cap \Gamma_{-1})$ is given by the four 2-torsion points $\{0, \frac{1}{2}, \frac{1}{2}\tau, \frac{1}{2}(1 + \tau)\}$.
- (b) $\#(\Gamma_{-1} \cap \Gamma_{-1}) = 0$ since one copy can be translated away from the other.

For $E \cong \mathbb{C}/i$ (j -invariant $j(E) = 1728$) we have:

- (d) $\#(\Gamma_{\pm i} \cap \Gamma_{-1})$ is given by the two points $\{0, \frac{1}{2}(1 + \tau)\}$.

For $E = \mathbb{C}/\tau$ with $\tau = \frac{1}{2}(1 + i\sqrt{3})$ (j -invariant $j(E) = 0$) we have:

- (e) $\#(\Gamma_\tau \cap \Gamma_{-1})$ and $\#(\Gamma_{(1-\tau)i} \cap \Gamma_{-1})$ are both determined by the three points $\{0, \frac{1}{3}(1 + \tau), \frac{2}{3}(1 + \tau)\}$.
- (f) $\#(\Gamma_{-\tau} \cap \Gamma_{-1})$ and $\#(\Gamma_{(\tau-1)i} \cap \Gamma_{-1})$ are both given by the single point $\{0\}$.

□

3.4. Analysis of 1-cycles in Singular Fibres of pr. We denote the fibres of the projection pr by $F_x := \text{pr}^{-1}(x)$. The singular fibres are all isomorphic so we denote a singular fibre by F_{ban} and its normalisation by $\nu : \tilde{F}_{\text{ban}} \rightarrow F_{\text{ban}}$. From [Br, Prop. 24] we have that $\tilde{F}_{\text{ban}} \cong \text{Bl}_{2 \text{ pt}}(\mathbb{P}^1 \times \mathbb{P}^1)$ and if we choose the coordinates on each \mathbb{P}^1 so that the 0 and ∞ map to a nodal singularity, then the two points blown-up are $z_1 = (0, \infty)$ and $z_2 = (\infty, 0)$.

$$\begin{array}{ccc} \text{Bl}_{z_1, z_2}(\mathbb{P}^1 \times \mathbb{P}^1) & \xrightarrow{\nu} & F_{\text{ban}} \\ \text{bl} \downarrow & & \\ \mathbb{P}^1 \times \mathbb{P}^1 & & \end{array}$$

We also let $N := \pi^{-1}(x)$ be a nodal elliptic fibre in S , and denote the natural projections by $\mathbf{q}_i : F_{\text{ban}} \rightarrow N$ (these are the morphisms $\text{pr}_i : X \rightarrow S$ with restricted domain and codomain).

3.4.1. Denote the divisors in \tilde{F}_{ban} corresponding to the banana curve C_i by \tilde{C}_i and \tilde{C}'_i . They are identified in F_{ban} by

$$\nu(\tilde{C}_i) = \nu(\tilde{C}'_i) = C_i.$$

For $i = 1, 2$ we also denote $\hat{C}_i = \text{bl}(\tilde{C}_i)$ and $\hat{C}'_i = \text{bl}(\tilde{C}'_i)$ inside $\mathbb{P}^1 \times \mathbb{P}^1$. The curve classes in \tilde{F}_{ban} are generated by the collection of \tilde{C}_i and \tilde{C}'_i 's with the relations:

$$\tilde{C}_1 + \tilde{C}_3 \sim \tilde{C}'_1 + \tilde{C}'_3 \quad \text{and} \quad \tilde{C}_2 + \tilde{C}_3 \sim \tilde{C}'_2 + \tilde{C}'_3.$$

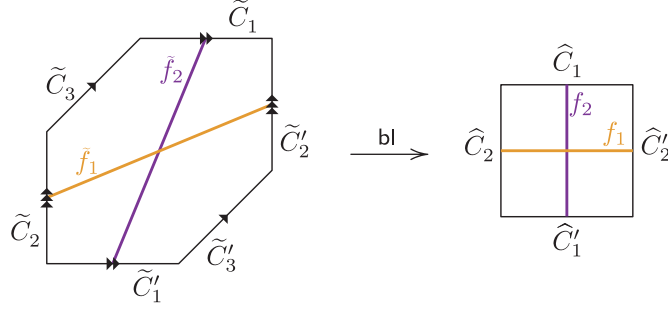

Figure 6. On the left is a depiction of the normalisation \tilde{F}_{ban} and on the right is a depiction of $\mathbb{P}^1 \times \mathbb{P}^1$. Here bl is the map blowing up $(0, \infty)$ and $(\infty, 0)$. On the right f_1 and f_2 are generic fibres of the projection maps $\mathbb{P}^1 \times \mathbb{P}^1 \rightarrow \mathbb{P}^1$ and on the left \tilde{f}_1 and \tilde{f}_2 are their proper transforms.

3.4.2. Let f_1 and f_2 be fibres of the projections $\mathbb{P}^1 \times \mathbb{P}^1 \rightarrow \mathbb{P}^1$ not equal to any \hat{C}_i or \hat{C}'_i and let \tilde{f}_1 and \tilde{f}_2 be their proper transforms. Then we also have the relations:

$$\tilde{f}_1 \sim \tilde{C}_1 + \tilde{C}_3 \quad \text{and} \quad \tilde{f}_2 \sim \tilde{C}_2 + \tilde{C}_3.$$

Moreover, if \tilde{D} is a divisor in \tilde{F}_{ban} such that $\nu(\tilde{D})$ is in the class (d_1, d_2, d_3) then, for $a_i + a'_i = d_i$, we have D is in a class:

$$a_1 \tilde{C}_1 + a'_1 \tilde{C}'_1 + a_2 \tilde{C}_2 + a'_2 \tilde{C}'_2 + a_3 \tilde{C}_3 + a'_3 \tilde{C}'_3.$$

Lemma 3.4.3. *Let $C \subset X$ correspond to a divisor D in F_{ban} .*

- 1) C is in the class $(0, 0, d_3)$ if and only if D has 1-cycle $d_3 C_3$.
- 2) C is in the class $(0, d_2, d_3)$ if and only if D has 1-cycle $\tilde{D} + a_2 C_2^{(j)} + a_3 C_3^{(j)}$ where \tilde{D} is the pullback of a degree a_f divisor from the smooth part of N via the projection $\mathbf{q}_i : F_{\text{ban}} \rightarrow N$ such that $a_f + a_2 = D_2$ and $a_f + a_3 = D_3$. Moreover, \tilde{D} is in the class $(0, a_f, a_f)$.

Proof. Let $C \subset X$ be a curve in the class $(0, d_2, d_3)$ and correspond to a divisor D in F_{ban} . There exists a divisor \tilde{D} in $\tilde{F}_{\text{ban}} \cong \text{Bl}_{z_1, z_2}(\mathbb{P}^1 \times \mathbb{P}^1)$ with $\nu(\tilde{D}) = D$.

From the discussion in 3.4.2 we have that $\text{bl}(\tilde{D})$ is in the class of $d_2 f_2$ and is hence in its corresponding linear system. So, \tilde{D} is the union of the the proper transform of $\text{bl}(\tilde{D})$ and curves supported at \tilde{C}_3 and \tilde{C}'_3 . The result now follows. \square

Lemma 3.4.4. *Let $C \subset X$ be an irreducible curve in the class $(1, 1, d)$ and correspond to a divisor D in F_{ban} . Then D is the image under ν of the proper transform under bl of a smooth divisor in $|f_1 + f_2|$ on $\mathbb{P}^1 \times \mathbb{P}^1$. Moreover, the value of d is determined the intersection of D with points in $\mathbf{P} = \{(0, 0), (0, \infty), (\infty, 0), (\infty, \infty)\}$. That is, if D intersects*

- 1) $(0, 0)$ and (∞, ∞) only, then $d = 2$.
- 2) $(0, \infty)$ and $(\infty, 0)$ only, then $d = 0$.
- 3) $(0, 0)$ only or (∞, ∞) only, then $d = 2$.
- 4) $(0, \infty)$ only or $(\infty, 0)$ only, then $d = 1$.
- 5) no points of \mathbf{P} , then $d = 2$.

Moreover, there are no smooth divisors in $|f_1 + f_2|$ on $\mathbb{P}^1 \times \mathbb{P}^1$ that intersect other combinations of these points.

Proof. Let $C \subset X$ be an irreducible curve in the class $(1, 1, d)$ and correspond to a divisor D in F_{ban} . There exists an irreducible divisor \tilde{D} in $\tilde{F}_{\text{ban}} \cong \text{Bl}_{z_1, z_2}(\mathbb{P}^1 \times \mathbb{P}^1)$ with $\nu(\tilde{D}) = D$. \tilde{D} does not contain either of the exceptional divisor \tilde{C}_3 and \tilde{C}'_3 . Hence, it must be the proper transform of a curve in $\mathbb{P}^1 \times \mathbb{P}^1$.

From the discussion in 3.4.2 we have that $\text{bl}(\tilde{D})$ is in the class of $f_1 + f_2$ and is hence in its corresponding linear system. The only irreducible divisors in $|f_1 + f_2|$ are smooth and can only pass through the combinations of points in \mathbf{P} that are given. We refer to the appendix 6.2.3 for the proof of this. The total transform in any divisor in $|f_1 + f_2|$ will correspond to a curve in the class $C_1 + C_2 + 2C_3$. Hence the classes of the proper transforms depend on the number of intersections with the set $\{(0, \infty), (\infty, 0)\}$. The values are immediately calculated to be those given. \square

3.5. Parametrising 1-cycles. For $i \in \{1, 2, \text{op}\}$ we use the notation:

- 1) $B_i = \{b_i^1, \dots, b_i^{12}\}$ is the set of the 12 points in S_i that correspond to nodes in the fibres of the projection $\pi_i := \text{pr}|_{S_i} : S_i \rightarrow \mathbb{P}^1$.
- 2) $S_i^\circ = S_i \setminus B_i$ is the complement of B_i in S_i

Lemma 3.5.1. *In the case $\beta = \sigma + (0, d_2, d_3) \in H_2(X, \mathbb{Z})$ there is the following constructible homeomorphism in $K_0(\text{Var}_{\mathbb{C}})[[Q_2, Q_3]]$:*

$$\text{Chow}^{\sigma+(0, \bullet, \bullet)}(X) \cong Q_\sigma \text{Sym}_{Q_2 Q_3}^\bullet(S_2^\circ) \times \text{Sym}_{Q_2}^\bullet(B_2) \times \text{Sym}_{Q_3}^\bullet(B_{\text{op}}).$$

Moreover, if the points of $\text{Chow}^{\sigma+(0, \bullet, \bullet)}(X)$ are identified using this constructible homeomorphism, then for $x = (\mathbf{a}_y, \mathbf{m}\mathbf{b}_2, \mathbf{n}\mathbf{b}_{\text{op}}) \in \text{Chow}^{\sigma+(0, \bullet, \bullet)}(X)$ the fibre of the cycle map is $\rho_\bullet^{-1}(x) = \text{Hilb}_{\text{Cyc}}^\bullet(X, \mathfrak{q})$ where

$$\mathfrak{q} = \sigma + \sum_i a_i \text{pr}_2^{-1}(y_i) + \sum_i m_i C_2^{(i)} + \sum_i n_i C_3^{(i)}.$$

Proof. From lemma 3.2.2 part 2) it is enough to consider curves in the class $(0, d_2, d_3)$. Also from 3.2.2 part 1) we know that the curves are supported on fibres of the map $\text{pr} : X \rightarrow \mathbb{P}^1$. From lemma 3.3.1 part 1) we know that the curves supported on smooth fibres of pr must be thicken fibres of the projection $\text{pr}_2 : X \rightarrow S$. Similarly we know from lemma 3.4.3 part 2) that the curves supported on singular fibres of pr must be the union of thicken fibres of pr_2 and curves supported on the C_2 and C_3 banana curves. The result now follows. \square

We also use the notation:

- 1) $N_i \subset S_i$ are the 12 nodal fibres of $\pi_i : S_i \rightarrow \mathbb{P}^1$ with the nodes removed and:
 $N_i = N_i^\sigma \amalg N_i^\emptyset$ where $N_i^\sigma := N_i \cap \sigma$ and $N_i^\emptyset := N_i \setminus \sigma$.
- 2) $\text{Sm}_i = S_i^\circ \setminus N_i$ is the complement of N_i in S_i° and:
 $\text{Sm}_i = \text{Sm}_i^\sigma \amalg \text{Sm}_i^\emptyset$ where $\text{Sm}_i^\sigma := \text{Sm}_i \cap \sigma$ and $\text{Sm}_i^\emptyset := \text{Sm}_i \setminus \sigma$.
- 3) J^0 and J^{1728} to be the subsets of points $x \in \mathbb{P}^1$ such that $\pi^{-1}(x)$ has j -invariant 0 or 1728 respectively and $J = J^0 \amalg J^{1728}$.
- 4) L to be the linear system $|f_1 + f_2|$ on $\mathbb{P}^1 \times \mathbb{P}^1$ with the singular divisors removed where f_1 and f_2 are fibres of the two projection maps.
- 5) $\widetilde{\text{Aut}}(E) := \text{Aut}(E) \setminus \{\pm 1\}$.

Remark 3.5.2. The following lemma should be parsed in the following way. For $i, j \in \{0, 1\}$ and $b, d_3 \in \mathbb{Z}_{\geq 0}$, a subscheme in the class $\beta = b\sigma + (i, j, d_3) \in H_2(X, \mathbb{Z})$ will have 1-cycle of the following form:

$$\mathbf{q} = b\sigma + D + \sum_i n_i C_3^{(i)}$$

where D is reduced and does not contain σ or $C_3^{(i)}$. Then D is in the class $(i, j, n) \in H_2(X, \mathbb{Z})$ for some $n \in \mathbb{Z}_{\geq 0}$.

The Chow groups parameterise the different possible 1-cycles that D can have. Moreover, these possibilities depend on i and j :

- If $i = j = 0$ then D is the empty curve. If
- If $i = 0$ and $j = 1$ then D can be either a fibre of the projection pr_2 or $C_2^{(i)}$.
- If $i = j = 1$ then D can be reducible or irreducible. If D is reducible then it is some combination of fibres and banana curves. We call the collection where D is irreducible the *diagonals*.

Lemma 3.5.3. *In the cases $\beta = d\sigma + (i, j, d_3) \in H_2(X, \mathbb{Z})$ there is the following constructible homeomorphism in $K_0(\text{Var}_{\mathbb{C}})[[Q_\sigma, Q_3]]$:*

$$\text{Chow}^{\bullet\sigma+(i,j,\bullet)}(X) \cong \sum_{b \in \mathbb{Z}_{\geq 0}} Q_\sigma^b \text{Chow}^{(i,j,\bullet)}(X).$$

Moreover, using the identification $Q_\sigma^b \text{Chow}^{(i,j,\bullet)}(X) = \{b\} \times \text{Chow}^{(i,j,\bullet)}(X)$ the points of $(b, x) \in \text{Chow}^{\bullet\sigma+(i,j,\bullet)}(X)$ give the fibres $(\eta_{\bullet}^{ij})^{-1}(b, x) = \text{Hilb}_{\text{Cyc}}^{\bullet}(X, \mathbf{q})$ with $\mathbf{q} = b\sigma + \mathbf{q}'$ where $\mathbf{q}' \in \text{Chow}^{(i,j,\bullet)}(X)$.

We also have the following decompositions of $\text{Chow}^{(i,j,\bullet)}(X)$, by constructible homeomorphisms in $K_0(\text{Var}_{\mathbb{C}})[[Q_\sigma, Q_3]]$:

- 1) For $i = j = 0$ we have the decomposition of $\text{Chow}^{(0,0,\bullet)}(X)$ with parts:
 - a) $\text{Sym}_{Q_3}^{\bullet}(B_{\text{op}})$.

The corresponding fibres are then $(\eta_{\bullet}^{00})^{-1}(x) = \text{Hilb}_{\text{Cyc}}^{\bullet}(X, \mathbf{q})$ where:

 - a) If $x = \mathbf{n}b_{\text{op}}$ then $\mathbf{q} = \sum_i n_i C_3^{(i)}$.
- 2) For $i = 0$ and $j = 1$ we have a decomposition of $\text{Chow}^{(0,1,\bullet)}(X)$ with parts:
 - a) $Q_2 S_2^{\circ} \times \text{Sym}_{Q_3}^{\bullet}(B_{\text{op}})$
 - b) $Q_2 \prod_{k=1}^{12} \text{Sym}_{Q_3}^{\bullet}(\{b_{\text{op}}^k\}) \times \text{Sym}_{Q_3}^{\bullet}(B_{\text{op}} \setminus \{b_{\text{op}}^k\})$.

The corresponding fibres are then $(\eta_{\bullet}^{01})^{-1}(x) = \text{Hilb}_{\text{Cyc}}^{\bullet}(X, \mathbf{q})$ where:

 - a) If $x = (y, \mathbf{n}b_{\text{op}})$ then $\mathbf{q} = \text{pr}_2^{-1}(y) + \sum_i n_i C_3^{(i)}$.
 - b) If $x = (a_k b_{\text{op}}^k, \mathbf{n}b_{\text{op}})$ then $\mathbf{q} = C_2^{(k)} + a_k C_3^{(k)} + \sum_i n_i C_3^{(i)}$.
- 3) For $i = j = 1$ we have a decomposition of $\text{Chow}^{(1,1,\bullet)}(X)$ with parts:
 - a) $Q_2 Q_3 S_1^{\circ} \times S_2^{\circ} \times \text{Sym}_{Q_3}^{\bullet}(B_{\text{op}})$
 - b) $Q_2 Q_3 \prod_{k=1}^{12} S_1^{\circ} \times \text{Sym}_{Q_3}^{\bullet}(\{b_{\text{op}}^k\}) \times \text{Sym}_{Q_3}^{\bullet}(B_{\text{op}} \setminus \{b_{\text{op}}^k\})$
 - c) $Q_2 Q_3 \prod_{k=1}^{12} S_2^{\circ} \times \text{Sym}_{Q_3}^{\bullet}(\{b_{\text{op}}^k\}) \times \text{Sym}_{Q_3}^{\bullet}(B_{\text{op}} \setminus \{b_{\text{op}}^k\})$

- d) $Q_2 Q_3 \prod_{\substack{k,l=1 \\ k \neq l}}^{12} \text{Sym}_{Q_3}^\bullet(\{b_{\text{op}}^k\}) \times \text{Sym}_{Q_3}^\bullet(\{b_{\text{op}}^l\}) \times \text{Sym}_{Q_3}^\bullet(B_{\text{op}} \setminus \{b_{\text{op}}^k, b_{\text{op}}^l\})$
- e) $Q_2 Q_3 \prod_{k=1}^{12} \text{Sym}_{Q_3}^\bullet(\{b_{\text{op}}^k\}) \times \text{Sym}_{Q_3}^\bullet(B_{\text{op}} \setminus \{b_{\text{op}}^k\})$
- f) $Q_2 Q_3 \text{Diag}^\bullet$

where Diag^\bullet will be defined by a further decomposition. The corresponding fibres of a) - e) are $(\eta_{\bullet}^{11})^{-1}(x) = \text{Hilb}_{\text{Cyc}}^\bullet(X, \mathfrak{q})$ where:

- a) If $x = (y_1, y_2, \mathbf{nb}_{\text{op}})$ then $\mathfrak{q} = \text{pr}_1^{-1}(y_1) + \text{pr}_2^{-1}(y_2) + \sum_i n_i C_3^{(i)}$.
- b) If $x = (y_1, a_k b_{\text{op}}^k, \mathbf{nb}_{\text{op}})$ then $\mathfrak{q} = \text{pr}_1^{-1}(y_1) + C_2^{(k)} + a_k C_3^{(k)} + \sum_i n_i C_3^{(i)}$.
- c) If $x = (y_2, a_k b_{\text{op}}^k, \mathbf{nb}_{\text{op}})$ then $\mathfrak{q} = \text{pr}_2^{-1}(y_2) + C_1^{(k)} + a_k C_3^{(k)} + \sum_i n_i C_3^{(i)}$.
- d) If $x = (a_k b_{\text{op}}^k, a_l b_{\text{op}}^l, \mathbf{nb}_{\text{op}})$ then $\mathfrak{q} = C_1^{(k)} + C_2^{(l)} + a_k C_3^{(k)} + a_l C_3^{(l)} + \sum_i n_i C_3^{(i)}$.
- e) If $x = (a_k b_{\text{op}}^k, \mathbf{nb}_{\text{op}})$ then $\mathfrak{q} = C_1^{(k)} + C_2^{(k)} + a_k C_3^{(k)} + \sum_i n_i C_3^{(i)}$.

For part f), Diag^\bullet is defined by the further decomposition:

- g) $\text{Sm}_1 \times \text{Sym}_{Q_3}^\bullet(B_{\text{op}})$
- h) $\text{Sm}_2 \times \text{Sym}_{Q_3}^\bullet(B_{\text{op}})$
- i) $\prod_{y \in J} E_{\pi(y)} \times \widetilde{\text{Aut}}(E_{\pi(y)}) \times \text{Sym}_{Q_3}^\bullet(B_{\text{op}})$
- j) $\prod_{k=1}^{12} L \times \text{Sym}_{Q_3}^\bullet(\{b_{\text{op}}^k\}) \times \text{Sym}_{Q_3}^\bullet(B_{\text{op}} \setminus \{b_{\text{op}}^k\})$.

The corresponding fibres of g) - j) are $(\eta_{\bullet}^{11})^{-1}(x) = \text{Hilb}^n(X, \mathfrak{q})$ where:

- g) If $x = (y, \mathbf{nb}_{\text{op}})$ then $\mathfrak{q} = D_y + \sum_i n_i C_3^{(i)}$ where D_y is the graph of the map $f(z) = z + y|_{E_{\pi(y)}}$ in the fibre $F_{\pi(y)} = E_{\pi(y)} \times E_{\pi(y)}$.
- h) If $x = (y, \mathbf{nb}_{\text{op}})$ then $\mathfrak{q} = D_y + \sum_i n_i C_3^{(i)}$ where D_y is the graph of the map $f(z) = -z + y|_{E_{\pi(y)}}$ in the fibre $F_{\pi(y)} = E_{\pi(y)} \times E_{\pi(y)}$.
- i) If $x = (y, \mathbf{nb}_{\text{op}})$ then $\mathfrak{q} = D_y + \sum_i n_i C_3^{(i)}$ where D_y is the graph of the map $f(z) = A(z) + y|_{E_{\pi(y)}}$ for some $A \in \text{Aut}(E_{\pi(y)}) \setminus \{\pm 1\}$.
- j) If $x = (z, a_k b_{\text{op}}^k, \mathbf{nb}_{\text{op}})$ then $\mathfrak{q} = \nu(\tilde{L}_z) + a_k C_3^{(k)} + \sum_i n_i C_3^{(i)}$ where \tilde{L}_z is the proper transform of the divisor L_z in $\mathbb{P}^1 \times \mathbb{P}^1$ and ν is the normalisation of the k th singular fibre.

Proof. The decomposition $\text{Chow}^{\bullet\sigma+(i,j,\bullet)}(X) \cong \sum_{b \in \mathbb{Z}_{\geq 0}} Q_\sigma^b \text{Chow}^{(i,j,\bullet)}(X)$ is immediate from lemma 3.2.2 part 3). Hence it is enough to parametrise the curves in the class $\beta = (i, j, \bullet)$. Also from 3.2.2 part 1) we know that the curves are supported on fibres of the map $\text{pr} : X \rightarrow \mathbb{P}^1$. We must have that

$$\text{Cyc}(C) = a\sigma + D + \sum_{i=1}^{12} m_i C_3^{(i)}$$

for some minimal reduces curve D in the class $(1, 1, n)$ for $n \geq 0$ minimal. The possible D curves are described in lemmas 3.3.1, 3.3.2, 3.4.3 and 3.4.4. The result now follows. \square

Remark 3.5.4. Using lemma 3.5.3 and the identification $Q_\sigma^b \text{Chow}^{(i,j,\bullet)}(X) = \{b\} \times \text{Chow}^{(i,j,\bullet)}(X)$ we make the following identification for notational convenience in discussing the points in section 5.1:

$$\text{Chow}^{\bullet\sigma+(i,j,\bullet)}(X) \cong \mathbb{Z}_{\geq 0} \times \text{Chow}^{(i,j,\bullet)}(X).$$

4. TECHNIQUES FOR CALCULATING EULER CHARACTERISTIC

4.1. Quot Schemes and their Decomposition. This section is a summary of required results from [BK]. First we consider the following subset of the Hilbert scheme.

Definition 4.1.1. Let $C \subset X$ be a Cohen-Macaulay subscheme of dimension 1. Consider the Hilbert scheme parameterising one dimensional subschemes $Z \subset X$ with class $[Z] = [C] \in H_2(X, \mathbb{Z})$ and $\chi(\mathcal{O}_Z) = \chi(\mathcal{O}_C) + n$ for some $n \in \mathbb{Z}_{\geq 0}$. This contains the following closed subset:

$$\text{Hilb}^n(X, C) := \{Z \subset X \text{ such that } C \subset Z \text{ and } I_C/I_Z \text{ has finite length } n\}.$$

It is convenient to replace the Hilbert scheme here with a Quot scheme. Recall the Quot scheme $\text{Quot}_X^n(\mathcal{F})$ parametrising quotients $\mathcal{F} \rightarrow \mathcal{G}$ on X , where \mathcal{G} is zero-dimensional of length n . It is related to the above Hilbert scheme in the following way.

Lemma 4.1.2. [BK, Lemma 5], [R1, Lemma 5.1]. *The following equality holds in $K_0(\text{Var}_{\mathbb{C}})(p)$:*

$$\text{Hilb}^\bullet(X, C) := \sum_{n \in \mathbb{Z}_{\geq 0}} \text{Hilb}^n(X, C) = \text{Quot}^\bullet_X(I_C) := \sum_{n \in \mathbb{Z}_{\geq 0}} \text{Quot}_X^n(I_C).$$

We also consider the following subscheme of these Quot schemes.

Definition 4.1.3. [BK, Def. 12] Let \mathcal{F} be a coherent sheaf on X , and $S \subset X$ a locally closed subset. We define the locally closed subset of $\text{Quot}_X^n(\mathcal{F})$

$$\text{Quot}_X^n(\mathcal{F}, S) := \{[\mathcal{F} \rightarrow \mathcal{G}] \in \text{Quot}_X^n(\mathcal{F}) \mid \text{Supp}_{\text{red}}(\mathcal{G}) \subset S\}.$$

This allows us to decompose the Quot schemes in the following way.

Lemma 4.1.4. [BK, Prop. 13] *Let \mathcal{F} be a coherent sheaf on X , $S \subset X$ a locally closed subset and $Z \subset X$ a closed subset. Then if $Z \subset S$ and $n \in \mathbb{Z}_{\geq 0}$ there is a geometrically bijective constructible map:*

$$\text{Quot}_X^n(\mathcal{F}, S) \longrightarrow \coprod_{n_1+n_2=n} \text{Quot}_X^{n_1}(\mathcal{F}, S \setminus Z) \times \text{Quot}_X^{n_2}(\mathcal{F}, Z).$$

4.2. An Action on the Formal Neighbourhoods. Let $C \subset X$ be a one dimensional subscheme in the class $\beta \in H_2(X)$ with 1-cycle $\mathfrak{q} = \text{Cyc}(C)$. We recall the notation defining $\text{Hilb}_{\text{Cyc}}^n(X, \mathfrak{q}) \subset \text{Hilb}^{\beta, n}(X)$ to be the following reduced subscheme

$$\text{Hilb}_{\text{Cyc}}^n(X, \mathfrak{q}) := \left\{ [Z] \in \text{Hilb}^{\beta, n}(X) \mid \text{Cyc}(Z) = \mathfrak{q} \right\}.$$

Furthermore, we define

$$\text{Hilb}_{\text{CM}}^n(X, \mathfrak{q}) \subset \text{Hilb}_{\text{Cyc}}^n(X, \mathfrak{q})$$

to be the open subset containing Cohen-Macaulay subschemes of Z .

Lemma 4.2.1. *Suppose $Z \subset X$ is a one dimensional Cohen-Macaulay subscheme such that:*

- 1) Z has the decomposition $Z = C \cup \bigcup_i Z_i$ where C is reduced, $Z_i \cap Z_j = \emptyset$ for $i \neq j$ and for each i we have $C \cap Z_i$ is finite.
- 2) There are formal neighbourhoods V_i of Z_i in X such that $(\mathbb{C}^*)^2$ acts on each and fixes Z_i^{red} .

3) $C \cap (\bigcup_i V_i)$ is invariant under the $(\mathbb{C}^*)^2$ -action on V_i .

Then there is a $(\mathbb{C}^*)^2$ -action on $\text{Hilb}_{\text{CM}}^n(X, \text{Cyc}(Z))$ such that if $\alpha \in (\mathbb{C}^*)^2$ and $Y \in \text{Hilb}_{\text{CM}}^n(X, \text{Cyc}(Z))$ then:

$$\alpha \cdot Y = \tilde{C} \cup \alpha \cdot (Y|_{\bigcup_i V_i}).$$

Proof. Let $\beta = [Z] \in H_2(X, \mathbb{Z})$ and use the simplifying notation $\mathcal{H} = \text{Hilb}^{\beta, n}(X)$ and $H := \text{Hilb}_{\text{CM}}^n(X, \text{Cyc}(Z))$. The composition $H \hookrightarrow \text{Hilb}_{\text{Cyc}}^n(X, \text{Cyc}(Z)) \hookrightarrow \mathcal{H}$ defines an immersion $H \hookrightarrow \mathcal{H}$ expressing H as a locally closed (reduced) subscheme of \mathcal{H} . Moreover, the immersion also defines the following flat family over H :

$$\begin{array}{ccc} \mathcal{Z}^{\mathcal{C}} & \xrightarrow{\iota} & X \times H \\ & \searrow h & \swarrow p_2 \\ & & H \end{array}$$

We consider $\mathcal{Z} \cap (\bigcup_i Z_i^{\text{red}} \times H)$ and define $\mathcal{C} := \overline{\mathcal{Z} \setminus (\mathcal{Z} \cap (\bigcup_i Z_i^{\text{red}} \times H))}$, the scheme-theoretic closure of the scheme-theoretic complement. Also, we denote by $\mathcal{Z}^\dagger := \widehat{\mathcal{Z}}_{\overline{\mathcal{Z} \setminus \mathcal{C}}}$ the formal completion of $\mathcal{Z} \setminus \mathcal{C}$ in \mathcal{Z} . This gives a decomposition of \mathcal{Z} by

$$\mathcal{Z} = \mathcal{C} \cup \mathcal{Z}^\dagger.$$

For all closed points $x \in H$, the fibres of the composition $\mathcal{C} \hookrightarrow \mathcal{Z} \rightarrow H$ have property $(\mathcal{C})_x = C$ as subschemes of X . Hence, $\mathcal{C} \cap (C \times H)$ contains all of the closed points of $C \times H$. Thus, $C \times H = \mathcal{C} \cap (C \times H)$ and we have the following immersion over H

$$\begin{array}{ccc} C \times H^{\mathcal{C}} & \xrightarrow{\alpha} & \mathcal{C} \\ & \searrow f_1 & \swarrow f_2 \\ & & H \end{array}$$

where both of f_1 and f_2 are proper with f_1 being flat. Also, since H is Noetherian, [St, Tag 01TX, Tag 05XD] shows that there is an open set $U \subset H$ containing all the closed points such that α_U is an isomorphism. Hence, $C \times H = \mathcal{C}$ as subschemes of $X \times H$.

Now, using a similar argument to the previous paragraph, we have that the underlying reduced schemes of \mathcal{Z}^\dagger and $\bigcup_i Z_i^{\text{red}} \times H$ are equal as subschemes in $X \times H$. This means that they both have the same formal completion in $X \times H$.

The formal completion of $\bigcup_i Z_i^{\text{red}} \times H$ in $X \times H$ is given by $\bigcup_i V_i \times H$, so we have inclusion $\mathcal{Z}^\dagger \hookrightarrow \bigcup_i V_i \times H$. Furthermore, we have an inclusion

$$\mathcal{Z} \hookrightarrow \mathcal{C} \cup \bigcup_i (V_i \times H) = (C \cup \bigcup_i V_i) \times H.$$

Now, by letting $G := (\mathbb{C}^*)^2$ and $W := C \cup \bigcup_i V_i$ we have the following diagram

$$\begin{array}{ccccc} G \times \mathcal{Z}^{\mathcal{C}} & \xrightarrow{\text{id} \oplus \iota} & G \times (W \times H) & \xrightarrow{\beta} & G \times (W \times H) & \xrightarrow{\text{id} \oplus (j \oplus \text{id})} & G \times (X \times H) \\ & \searrow \text{id} \oplus h & \downarrow \text{id} \oplus q_2 & & \downarrow \text{id} \oplus q_2 & & \downarrow \text{id} \oplus p_2 \\ & & G \times H & \xlongequal{\quad} & G \times H & \xlongequal{\quad} & G \times H \end{array}$$

where β is defined by $(g, (x, y)) \mapsto (g, (g \cdot x, y))$, $j : W \hookrightarrow X$ is the natural inclusion and $q_2 : W \times H \rightarrow H$ is the projection onto the second factor. Taking the

composition of the top row defines the following flat family in \mathcal{H} over $G \times H$:

$$\zeta := \left(\begin{array}{ccc} G \times Z & \xrightarrow{\quad} & X \times (G \times H) \\ & \searrow & \swarrow \\ & G \times H & \end{array} \right)$$

The flat family ζ defines a morphism $\Phi : G \times H \rightarrow \mathcal{H}$.

We have that $G \times H$ is reduced, so the scheme theoretic image $\text{Sch.Im.}(\Phi)$ is also reduced. Moreover, every closed point of the $\text{Sch.Im.}(\Phi)$ is contained in H . Hence, we have $\text{Sch.Im.}(\Phi) \subseteq H$. Thus, Φ defines a morphism $G \times H \rightarrow H$. It is now straightforward to show that this morphism satisfies the identity and compatibility axioms of a group action. \square

Remark 4.2.2. In the case where Z is smooth, an analysis similar to that in the proof of lemma 4.2.1 was carried out in [R2]. However, the analysis there is scheme-theoretic. Moreover the equality $\kappa^{-1}(z) = \text{Quot}_X^\bullet(I_Z)$, which will appear in the proof of the next lemma (lemma 4.2.3), was proven scheme theoretically in the case of Z being smooth.

Define $\text{Hilb}_{\text{CM}}^\diamond(X, \mathfrak{q}) := \coprod_{m \in \mathbb{Z}} \text{Hilb}_{\text{CM}}^m(X, \mathfrak{q})$ and consider the constructible map

$$\kappa : \text{Hilb}_{\text{Cyc}}^\bullet(X, \mathfrak{q}) \longrightarrow \text{Hilb}_{\text{CM}}^\diamond(X, \mathfrak{q})$$

where $Z \subset X$ is mapped to the maximal Cohen-Macaulay subscheme $Z_{\text{CM}} \subset Z$ (also forgetting the indexing variable p). Then for $z \in \text{Hilb}_{\text{CM}}^\diamond(X, \mathfrak{q})$ corresponding to $Z \subset X$ we have

$$\kappa^{-1}(z) = \sum_{m \in \mathbb{Z}} p^m \text{Hilb}^{m-\chi(\mathcal{O}_Z)}(X, Z) = p^{\chi(\mathcal{O}_Z)} \text{Hilb}^\bullet(X, Z).$$

Moreover, we have

$$\begin{aligned} e\left(\text{Hilb}_{\text{Cyc}}^\bullet(X, \mathfrak{q})\right) &= e\left(\text{Hilb}_{\text{CM}}^\diamond(X, \mathfrak{q}), \kappa_* 1\right) \\ (6) \qquad \qquad \qquad &= e\left(\text{Hilb}_{\text{CM}}^\diamond(X, \mathfrak{q})^{(\mathbb{C}^*)^2}, \kappa_* 1\right) \end{aligned}$$

where $(\kappa_* 1)(z) := e(\kappa^{-1}(z))$ and the last line comes from the following lemma.

Lemma 4.2.3. *The constructible function $\kappa_* 1$ is invariant under the $(\mathbb{C}^*)^2$ -action. That is if $\alpha \in (\mathbb{C}^*)^2$ and $z \in \text{Hilb}_{\text{CM}}^\diamond(X, \mathfrak{q})$ then $(\kappa_* 1)(z) = (\kappa_* 1)(\alpha \cdot z)$.*

Proof. Let $\alpha \in (\mathbb{C}^*)^2$ and $z \in \text{Hilb}_{\text{CM}}^\diamond(X, \mathfrak{q})$ correspond to $Z \subset X$. Also let Z_i and V_i be as in lemma 4.2.1 with $\tilde{Z} := \bigcup_i Z_i$ and $\tilde{V} := \bigcup_i V_i$. Then the fibre $\kappa^{-1}(z)$ is

$$\kappa^{-1}(z) = p^{\chi(\mathcal{O}_Z)} \text{Hilb}^\bullet(X, Z) = p^{\chi(\mathcal{O}_Z)} \text{Quot}_X^\bullet(I_Z)$$

where the last equality is in $K_0(\text{Var}_{\mathbb{C}})(p)$ from lemma 4.1.2. Also from lemma 4.1.4 we have a geometrically bijective constructible map:

$$\text{Quot}_X^n(I_Z) \longrightarrow \coprod_{n_1+n_2=n} \text{Quot}_X^{n_1}(I_Z, X \setminus \tilde{V}) \times \text{Quot}_X^{n_2}(I_Z, \tilde{V}).$$

We have $I_{\alpha \cdot Z}|_{X \setminus \tilde{V}} = I_Z|_{X \setminus \tilde{V}}$ so $\text{Quot}_X^{n_1}(I_Z, X \setminus \tilde{V}) \cong \text{Quot}_X^{n_1}(I_{\alpha \cdot Z}, X \setminus \tilde{V})$. Moreover, we have isomorphisms

$$\text{Quot}_X^{n_2}(I_Z, \tilde{V}) \cong \text{Quot}_{\tilde{V}}^{n_2}(I_Z|_{\tilde{V}})$$

and $Z_{\tilde{\nu}} \cong \alpha \cdot Z_{\tilde{\nu}}$ so we have an isomorphism

$$\mathrm{Quot}_X^{n_2}(I_Z, \tilde{V}) \cong \mathrm{Quot}_X^{n_2}(I_{\alpha \cdot Z}, \tilde{V})$$

Taking Euler characteristic now shows that $e(\kappa^{-1}(z)) = e(\kappa^{-1}(\alpha \cdot z))$. \square

4.2.4. We will now consider a useful tool in calculating Euler characteristics of the form given in (6). First let $z \in \mathrm{Hilb}_{\mathbb{C}\mathbb{M}}^n(X, \mathfrak{q})$ correspond to $Z \subset X$ such that Z is locally monomial. In other words, for every geometric point $z \in Z$ the restriction of Z to the formal neighbourhood of z in X is of the form $\mathrm{Spec} \mathbb{C}[[x, y, z]]/I_z$ where I_z is an ideal generated by monomials in $\mathbb{C}[[x, y, z]]$. Then the fibre $\kappa^{-1}(x)$ is

$$\kappa^{-1}(x) = p^{\chi(\mathcal{O}_Z)} \mathrm{Hilb}^\bullet(X, Z) = p^{\chi(\mathcal{O}_Z)} \mathrm{Quot}_X^\bullet(I_Z)$$

where the last equality is in $K_0(\mathrm{Var}_{\mathbb{C}})((p))$ from lemma 4.1.2. To compute this fibre we employ the following method:

- 1) Decompose X by $X = Z \amalg W$ where $W := X \setminus Z$
- 2) Let Z° be set of singularities of Z^{red} .
- 3) Let $\coprod_i Z_i = Z \setminus Z^\circ$ be a decomposition into irreducible components.

Then applying Euler characteristic to lemma 4.1.4 we have:

$$e(\mathrm{Quot}_X^\bullet(I_Z)) = e(\mathrm{Quot}_X^\bullet(I_Z, W)) \prod_{z \in Z^\circ} e(\mathrm{Quot}_X^\bullet(I_Z, \{z\})) \prod_i e(\mathrm{Quot}_X^\bullet(I_Z, Z_i)).$$

4.3. Partitions and the topological vertex. We recall the terminology of 2D partitions, 3D partitions and the topological vertex from [ORV, BCY]. A *2D partition* λ is an infinite sequence of weakly decreasing integers that are zero except for a finite number of terms. The size of a 2D partition $|\lambda|$ is the sum of the elements in the sequence and the length $l(\lambda)$ is the number of non-zero elements. We will also think of a 2D partition as a subset of $(\mathbb{Z}_{\geq 0})^2$ in the following way:

$$\lambda \rightsquigarrow \{(i, j) \in (\mathbb{Z}_{\geq 0})^2 \mid \lambda_i \geq j \geq 0 \text{ or } i = 0\}$$

A *3D partition* is a subset $\boldsymbol{\eta} \subset (\mathbb{Z}_{\geq 0})^3$ satisfying the following condition:

- 1) $(i, j, k) \in \boldsymbol{\eta}$ if and only if one of i, j or k is zero or one of $(i-1, j, k), (i, j-1, k)$ or $(i, j, k-1)$ is also in $\boldsymbol{\eta}$.

Given a triple of 2D partitions (λ, μ, ν) we also define a *3D partition asymptotic to* (λ, μ, ν) is a 3D partition $\boldsymbol{\eta}$ that also satisfies the conditions:

- 1) $(j, k) \in \lambda$ if and only if $(i, j, k) \in \boldsymbol{\eta}$ for all $i \gg 0$.
- 2) $(k, i) \in \mu$ if and only if $(i, j, k) \in \boldsymbol{\eta}$ for all $j \gg 0$.
- 3) $(i, j) \in \nu$ if and only if $(i, j, k) \in \boldsymbol{\eta}$ for all $k \gg 0$.

The *leg of $\boldsymbol{\eta}$ in the i th direction* is the subset $\{(i, j, k) \in \boldsymbol{\eta} \mid (j, k) \in \lambda\}$. We analogously define the legs of $\boldsymbol{\eta}$ in the j and k directions. The *weight* of a point in $\boldsymbol{\eta}$ is defined to be

$$\xi_{\boldsymbol{\eta}}(i, j, k) := 1 - \#\{\text{legs of } \boldsymbol{\eta} \text{ containing } (i, j, k)\}.$$

Using this we define the *renormalised volume* of $\boldsymbol{\eta}$ by:

$$(7) \quad |\boldsymbol{\eta}| := \sum_{(i, j, k) \in \boldsymbol{\eta}} \xi_{\boldsymbol{\eta}}(i, j, k).$$

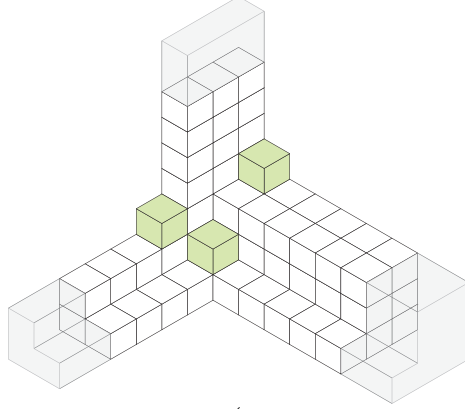

Figure 7. A 3D partition asymptotic to $((2, 1), (3, 2, 2), (1, 1, 1))$. The partition containing only the white boxes has renormalised volume -16 . The partition including the green boxes has renormalised volume -13 .

The *topological vertex* is the formal Laurent series:

$$V_{\lambda\mu\nu} := \sum_{\eta} p^{|\eta|}$$

where the sum is over all 3D partitions asymptotic to (λ, μ, ν) . An explicit formula for $V_{\lambda\mu\nu}$ is derived in [ORV, Eq. 3.18] to be:

$$V_{\lambda\mu\nu} = M(p)p^{-\frac{1}{2}(\|\lambda\|^2 + \|\mu\|^2 + \|\nu\|^2)} S_{\nu^t}(p^{-\rho}) \sum_{\eta} S_{\lambda^t/\eta}(p^{-\nu-\rho}) S_{\mu/\eta}(p^{-\nu^t-\rho})$$

4.4. Partition Thickened Section, Fibre and Banana Curves. In this subsection we consider the non-reduced structure of curves in our desired classes. The partition thickened structure will be the fixed points of a $(\mathbb{C}^*)^2$ -action.

4.4.1. Recall that the section $\zeta \in S$ is the blow-up of a point in $z \in \mathbb{P}^2$. Choose once and for all a formal neighbourhood $\text{Spec } \mathbb{C}[[s, t]]$ of $z \in \mathbb{P}^2$. The blow-up gives the formal neighbourhood of $\zeta \in S$ with 2 coordinate charts:

$$\mathbb{C}[[s, t]][u]/(t - su) \cong \mathbb{C}[[s]][u] \quad \text{and} \quad \mathbb{C}[[s, t]][v]/(s - tv) \cong \mathbb{C}[[t]][v]$$

with change of coordinates $s \mapsto tv$ and $u \mapsto v^{-1}$. This gives the formal neighbourhood of $\sigma \in X$ with 2 coordinate charts:

$$\mathbb{C}[[s_1, s_2]][u] \quad \text{and} \quad \mathbb{C}[[t_1, t_2]][v]$$

with change of coordinates $s_i \mapsto t_i v$ and $u \mapsto v^{-1}$. We call these coordinates the **canonical formal coordinates** around $\sigma \in X$.

4.4.2. Now consider a reduced curve D in X that intersects σ transversely with length 1. When D is restricted to the formal neighbourhood of σ , it is given by

$$\mathbb{C}[[s_1, s_2]][u]/(a_0 u - a_1, b_0 s_1 - b_1 s_2) \quad \text{and} \quad \mathbb{C}[[t_1, t_2]][v]/(a_0 - a_1 v, b_0 t_1 - b_1 t_2)$$

for some $[a_0 : a_1], [b_0 : b_1] \in \mathbb{P}^1$. We use this to define the change of coordinates:

$$\begin{aligned} \tilde{s}_1 &\mapsto b_0 s_1 - b_1 s_2 & \text{and} & & \tilde{s}_2 &\mapsto b_1 s_1 + b_0 s_2 \\ \tilde{t}_1 &\mapsto b_0 t_1 - b_1 t_2 & \text{and} & & \tilde{t}_2 &\mapsto b_1 t_1 + b_0 t_2 \end{aligned}$$

We call these coordinates the **canonical formal coordinates relative to D** .

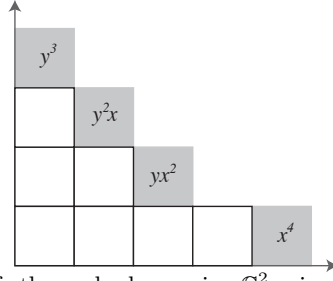

Figure 8. Depiction of the subscheme in \mathbb{C}^2 given by the monomial ideal $(y^3, y^2x, y^1x^2, y^1x^3, x^4)$ associated to the partition $(3, 2, 1, 1, 0, \dots)$.

Definition 4.4.3. Let $\mathbb{C}[[s_1, s_2]][u]$ and $\mathbb{C}[[t_1, t_2]][v]$ be either the formal canonical coordinates of 4.4.1 or those of 4.4.2. Then we define

- 1) The **canonical $(\mathbb{C}^*)^2$ -action** on these coordinates by $(s_1, s_2) \mapsto (g_1s_1, g_2s_2)$ and $(t_1, t_2) \mapsto (g_1t_1, g_2t_2)$.
- 2) Let $\lambda = (\lambda_1, \dots, \lambda_l, 0, \dots)$ be a 2D partition. The **λ -thickened section** denoted by $\lambda\sigma$ is the subscheme of X defined by the ideal given in the coordinates by

$$(s_2^{\lambda_1}, \dots, s_1^{l-1}s_2^{\lambda_l}, s^l) \quad \text{and} \quad (t_2^{\lambda_1}, \dots, t_1^{l-1}t_2^{\lambda_l}, t^l).$$

4.4.4. We now consider a canonical formal neighbourhood of the banana curve C_3 . We follow much of the reasoning from [Br, §5.2]. Let $x \in S$ correspond to a point where $\pi : S \rightarrow \mathbb{P}^1$ is singular. Let formal neighbourhoods in the two isomorphic copies of S be given by

$$\text{Spec } \mathbb{C}[[s_1, t_1]] \quad \text{and} \quad \text{Spec } \mathbb{C}[[s_2, t_2]]$$

and the map $S \rightarrow \mathbb{P}^1$ be given by $r \mapsto s_i t_i$. Then the formal neighbourhood of a conifold singularity in X is given by

$$\text{Spec } \mathbb{C}[[s_1, t_1, s_2, t_2]] / (s_1 t_1 - s_2 t_2),$$

and the restriction to a fibre of the projection $S \times_{\mathbb{P}^1} S \rightarrow \mathbb{P}^1$ is

$$\text{Spec } \mathbb{C}[[s_1, t_1, s_2, t_2]] / (s_1 t_1, s_2 t_2).$$

Now, blowing up along $\{s_1 = t_2 = 0\}$ (which is canonically equivalent to blowing up along $\{s_1 - t_1 = s_2 - t_2 = 0\}$), we have the two coordinate charts:

$$\begin{aligned} \mathbb{C}[[s_1, t_2, s_2, t_2]][u] / (s_1 - ut_2, s_2 - ut_1) &\cong \mathbb{C}[[t_1, t_2]][u], \quad \text{and} \\ \mathbb{C}[[s_1, t_2, s_2, t_2]][v] / (t_1 - vs_2, t_2 - vs_1) &\cong \mathbb{C}[[s_1, s_2]][v], \end{aligned}$$

where the change of coordinates is given by $t_1 \mapsto vs_2$, $t_2 \mapsto vs_1$ and $u \mapsto v^{-1}$. We call these coordinates the **canonical formal coordinates** around the banana curve C_3 .

4.4.5. With these coordinates we have:

- 1) The restriction to the fibre of $\text{pr} : X \rightarrow \mathbb{P}^1$ is

$$\mathbb{C}[[t_1, t_2]][u] / (t_1 t_2 u) \quad \text{and} \quad \mathbb{C}[[s_1, s_2]][v] / (s_1 s_2 v).$$

- 2) The banana curve C_3 is given by

$$\mathbb{C}[[t_1, t_2]][u] / (t_1, t_2) \quad \text{and} \quad \mathbb{C}[[s_1, s_2]][v] / (s_1, s_2).$$

4.4.6. Similar to 4.4.2 we also consider canonical relative coordinates for a C_3 banana curve. Recall 3.4.4 and let D be the image under $\nu : \widetilde{F}_{\text{ban}} \rightarrow F_{\text{ban}}$ of the proper transform under $\text{bl} : \text{Bl}_{(0,\infty),(\infty,0)}(\mathbb{P}^1 \times \mathbb{P}^1) \rightarrow \mathbb{P}^1 \times \mathbb{P}^1$ of a smooth divisor in $|f_1 + f_2|$ on $\mathbb{P}^1 \times \mathbb{P}^1$.

If D intersects $(0,0)$ then the restriction of D to the formal neighbourhood of C_3 is given by:

$$\mathbb{C}[[s_1, s_2]][v]/(s_1 - as_2, v)$$

for some $a \in \mathbb{C}^*$. In this case we define **canonical formal coordinates relative to D** around a C_3 banana by the following change of coordinates.

$$\begin{aligned} \tilde{s}_1 &\mapsto s_1 - as_2 & \text{and} & & \tilde{s}_2 &\mapsto s_1 + as_2 \\ \tilde{t}_1 &\mapsto at_1 + t_2 & \text{and} & & \tilde{t}_2 &\mapsto -at_1 + t_2 \end{aligned}$$

We similarly define the same relative coordinates if for D intersects (∞, ∞) in the ideal $(-at_1 + t_2, u)$. Note that these coordinates are compatible if D intersects both $(0,0)$ and (∞, ∞) .

Definition 4.4.7. Let $\mathbb{C}[[s_1, s_2]][u]$ and $\mathbb{C}[[t_1, t_2]][v]$ be either the canonical coordinates or relative coordinates.

- 1) The **canonical $(\mathbb{C}^*)^2$ -action** on these coordinates is defined by

$$(s_1, s_2, v) \mapsto (g_1 s_1, g_2 s_2, v) \quad \text{and} \quad (t_1, t_2, u) \mapsto (g_2 t_1, g_1 t_2, u).$$

- 2) Let $\lambda = (\lambda_1, \dots, \lambda_l, 0, \dots)$ be a 2D partition. The **λ -thickened banana curve C_3** denoted by λC_3 is the subscheme of X defined by the ideal given in the coordinates by

$$(s_2^{\lambda_1}, \dots, s_1^{l-1} s_2^{\lambda_l}, s_1^l) \quad \text{and} \quad (t_1^{\lambda_1}, \dots, t_2^{l-1} t_1^{\lambda_l}, t_2^l).$$

(Note the change in coordinates compared to definition 4.4.3.)

Remark 4.4.8. If D intersects both $(0,0)$ and (∞, ∞) and λC_3 is partition thickened in the coordinates relative to D . Then ideals for $D \cup \lambda C_3$ at the points $(0,0)$ and (∞, ∞) are

$$(s_2^{\lambda_1}, \dots, s_1^{l-1} s_2^{\lambda_l}, s_1^l) \cap (s_1, v) \quad \text{and} \quad (t_1^{\lambda_1}, \dots, t_2^{l-1} t_1^{\lambda_l}, t_2^l) \cap (t_2, u)$$

respectively. These both give 3D partitions asymptotic to $(\lambda, \emptyset, \square)$.

Lemma 4.4.9. *Let D be as described in the first paragraph of 4.4.6. If let V be the formal neighbourhood of C_3 in X . If D intersects $(0,0)$ and/or (∞, ∞) then use the relative coordinates of 4.4.6, otherwise use the canonical coordinates of 4.4.4. Then $D \cap V$ is invariant under the $(\mathbb{C}^*)^2$ -action.*

Proof. We have $D \cap V \neq 0$ if and only if it intersects at least one of $(0,0)$, $(0,\infty)$, $(\infty,0)$, (∞,∞) . The possible combinations are:

- 1) $(0,0)$ and/or (∞, ∞) : This is by construction of the relative coordinates.
- 2) *Exactly one of $(0, \infty)$ or $(\infty, 0)$* : Then D is given by the ideal $(v - a, s_1)$ or $(v - a, s_2)$ for some $a \in \mathbb{C}^*$, which are $(\mathbb{C}^*)^2$ -invariant.
- 3) $(0, \infty)$ and $(\infty, 0)$: Then D is given by the ideal $(v - a, s_1 s_2)$ for some $a \in \mathbb{C}^*$ which is $(\mathbb{C}^*)^2$ -invariant.

□

4.4.10. It is also shown in [Br, §5.2] that there are the following formal coordinates on C_2 compatible with the canonical formal coordinates around C_3 :

$$\mathbb{C}[[s_1, v]][s_2] \quad \text{and} \quad \mathbb{C}[[t_1, u]][t_2]$$

where the change on coordinates is given by $s_2 \mapsto t_2$, $s_1 \mapsto t_1 t_2$ and $v \mapsto t_2 u$. We can define partition thickenings and a compatible $(\mathbb{C}^*)^2$ -action in these coordinates.

Definition 4.4.11. Let $\mathbb{C}[[s_1, v]][s_2]$ and $\mathbb{C}[[t_1, u]][t_2]$ be the above canonical coordinates.

- 1) The **canonical** $(\mathbb{C}^*)^2$ -**action** on these coordinates is defined by:

$$(s_1, v, s_2) \mapsto (g_1 s_1, v, g_2 s_2) \quad \text{and} \quad (t_1, u, t_2) \mapsto (g_2 t_1, u, g_1 t_2).$$

- 2) Let $\mu = (\mu_1, \dots, \mu_k, 0, \dots)$ be a 2D partition. The μ -**thickened banana curve** C_2 denoted by μC_2 is the subscheme of X defined by the ideal given in the coordinates by

$$(s_1^{\mu_1}, \dots, v^{k-1} s_1^{\mu_k}, v^k) \quad \text{and} \quad (t_1^{\mu_1}, \dots, u^{k-1} t_1^{\mu_k}, u^k).$$

(Note the change in coordinates compared to definition 4.4.7.)

- 3) Let $\lambda = (\lambda_1, \dots, \lambda_l, 0, \dots)$ be another 2D partition. The (μ, λ) -**thickened banana curve** denoted is the union $\mu C_2 + \lambda C_3$.

Remark 4.4.12. The C_2 and C_3 banana curves meet in exactly 2 points. At these two points a (μ, λ) -thickened banana curve will define two 3D partitions. One will be asymptotic to $(\mu, \lambda, \emptyset)$ the other will be asymptotic to $(\mu^t, \lambda^t, \emptyset)$ (or equivalently $(\lambda, \mu, \emptyset)$).

We will now consider fibres of the projection map $\text{pr}_2 : X \rightarrow S$.

Definition 4.4.13. Recall the definition of $\text{pr}_2 : X \rightarrow S$ from section 1.2. Let $x \in S$ be such that $f_x := \text{pr}_2^{-1}(x)$ is smooth. Then we define

- 1) **Canonical coordinates** on a formal neighbourhood V_x of f_x are formal coordinates $\mathbb{C}[[s, t]]$ of S at x such that $V_x := f_x \times \text{Spec } \mathbb{C}[[s, t]]$ and for $\{x\} \cap \sigma \neq \emptyset$ we have that σ restricted to $\mathbb{C}[[s, t]]$ is given by the ideal (s) .
- 2) The **canonical** $(\mathbb{C}^*)^2$ -**action** on these coordinates by $(s, t) \mapsto (g_1 s, g_2 t)$.
- 3) Let $\lambda = (\lambda_1, \dots, \lambda_l, 0, \dots)$ be a 2D partition. The λ -**thickened smooth fibre** at x denoted by λf_x is the subscheme of X given by the ideal:

$$(t^{\lambda_1}, \dots, s^{l-1} t^{\lambda_l}, s^l)$$

4.4.14. Let N be a nodal fibre of $\pi : S \rightarrow \mathbb{P}^1$, $x \in N \setminus \{\text{node}\}$ and $C = \text{pr}_2^{-1}(x)$. Let $F_{\text{ban}} = \text{pr}_2^{-1}(N)$ and \widehat{F}_{ban} be its formal completion in X . The formal completion of C in X is the same as the formal completion of C in \widehat{F}_{ban} . Let $\widehat{\mathbb{P}^1 \times \mathbb{P}^1}$ be the formal neighbourhood of $\mathbb{P}^1 \times \mathbb{P}^1$ in the total space of its canonical bundle. It is shown in [Br, Prop. 25] that there is a natural étale map $\widehat{\tau} : \text{Bl}(\widehat{\mathbb{P}^1 \times \mathbb{P}^1}) \rightarrow \widehat{F}_{\text{ban}}$ whose restriction to the underlying reduced subschemes is the normalisation map for F_{ban} .

Using this and the results of [Br, §5.2] we have charts for the formal completion of the normalisation of C in $\text{Bl}(\widehat{\mathbb{P}^1 \times \mathbb{P}^1})$ given by

$$\mathbb{C}[[y_0, z_0]][x_0] \quad \text{and} \quad \mathbb{C}[[y_1, z_1]][x_1]$$

with an isomorphism on the complements of (x_0) and (x_1) given by

$$x_0 \mapsto \frac{1}{x_1}, \quad \text{and} \quad y_0 \mapsto y_1 x_2^2 \quad \text{and} \quad z_0 \mapsto z_1$$

The identification at the node of C is given by the restriction of the morphism $\widehat{\tau} : \text{Bl}(\widehat{\mathbb{P}^1 \times \mathbb{P}^1}) \rightarrow \widehat{F}_{\text{ban}}$ is

$$z_0 = z_1, \quad \text{and} \quad x_0 = y_1 \quad \text{and} \quad y_0 = x_1.$$

Moreover, these coordinates can be chosen such that σ restricted to $\mathbb{C}[[y_0, z_0]][x_0]$ is given by the ideal $(x_0 - 1, z_0)$.

Definition 4.4.15. Using 4.4.14 we define

- 1) **Canonical coordinates** on a formal neighbourhood V_C of C are formal coordinates given in 4.4.14.
- 2) The **canonical $(\mathbb{C}^*)^2$ -action** on given respectively on $\mathbb{C}[[y_0, z_0]][x_0]$ and $\mathbb{C}[[y_1, z_1]][x_1]$ by

$$(x_0, y_0, z_0) \mapsto (g_1 x_0, \frac{1}{g_1} y_0, g_2 z_0), \quad \text{and} \quad (x_1, y_1, z_1) \mapsto (\frac{1}{g_1} x_1, g_1 y_1, g_2 z_1).$$
- 3) Let $\lambda = (\lambda_1, \dots, \lambda_l, 0, \dots)$ be a 2D partition. The **λ -thickened fibre with one node** at x denoted by λC is the subscheme of X given by the ideal which restricted to $\mathbb{C}[[y_0, z_0]][x_0]$ is

$$(z_0^{\lambda_1}, \dots, x_0^{l-1} z_0^{\lambda_l}, x_0^l) \cap (z_0^{\lambda_1}, \dots, y_0^{l-1} z_0^{\lambda_l}, y_0^l)$$

and when restricted to $\mathbb{C}[[y_1, z_1]][x_1]$ is

$$(z_1^{\lambda_1}, \dots, y_1^{l-1} z_1^{\lambda_l}, y_1^l) \cap (z_1^{\lambda_1}, \dots, x_1^{l-1} z_1^{\lambda_l}, x_1^l).$$

Remark 4.4.16. The partition thickened curves described in this section are easily shown to be the only Cohen-Macaulay subschemes supported in these neighbourhoods that are invariant under the $(\mathbb{C}^*)^2$ -action. This is because the invariant Cohen-Macaulay subschemes must be generated by monomial ideals.

Lemma 4.4.17. *Let $\lambda = (\lambda_1, \dots, \lambda_l, 0, \dots)$ and $\mu = (\mu_1, \dots, \mu_k, 0, \dots)$ be 2D partitions, and let $x \in S$ such that $f_x := \text{pr}_2^{-1}(x)$ contains no banana curves. Then we have the holomorphic Euler characteristics :*

- 1) $\chi(\mathcal{O}_{\lambda\sigma}) = \frac{1}{2}(\|\lambda\|^2 + \|\lambda^t\|^2),$
- 2) $\chi(\mathcal{O}_{\lambda f_x}) = 0,$
- 3) $\chi(\mathcal{O}_{\sigma \cap \lambda f_x}) = \lambda_1,$
- 4) $\chi(\mathcal{O}_{\mu C_2 \cup \lambda C_3}) = |\boldsymbol{\eta}_1| + |\boldsymbol{\eta}_2| + \frac{1}{2}(\|\mu\|^2 + \|\mu^t\|^2 + \|\lambda\|^2 + \|\lambda^t\|^2)$ where $|\boldsymbol{\eta}_i|$ are the renormalised volumes of the minimal 3D partitions associated to $(\mu, \lambda, \emptyset)$ and $(\mu^t, \lambda^t, \emptyset)$.

Proof. 2) and 3) are proved in [BK, Lemma 11], the rest are from [Br, Prop. 23]. \square

4.5. Relation between Quot Schemes on \mathbb{C}^3 and the Topological Vertex.

This section is predominately a summary of required results from [BK]. For 2D partitions λ, μ and ν we define the following subscheme of \mathbb{C}^3 :

$$\mathcal{C}_{\lambda, \mu, \nu} = \mathcal{C}_{\lambda, \emptyset, \emptyset} \cup \mathcal{C}_{\emptyset, \mu, \emptyset} \cup \mathcal{C}_{\emptyset, \emptyset, \nu} \subset \text{Spec} \mathbb{C}[r, s, t]$$

where $\mathcal{C}_{\lambda, \emptyset, \emptyset}$ is defined by the ideal $I_{\lambda, \emptyset, \emptyset} := (t^{\lambda_1}, \dots, t^{l-1} s^{\lambda_l}, s^l)$, with $\mathcal{C}_{\emptyset, \mu, \emptyset}$ and $\mathcal{C}_{\emptyset, \emptyset, \nu}$ being cyclic permutations of this. In general, we define the ideal $I_{\lambda\mu\nu} = I_{\lambda\emptyset\emptyset} \cap I_{\emptyset\mu\emptyset} \cap I_{\emptyset\emptyset\nu}$.

Now we consider the Quot scheme of length n quotients of $I_{\lambda\mu\nu}$ that are set-theoretically supported at the origin and we employ the following simplifying notation:

$$\text{Quot}^n(\lambda, \mu, \nu) := \text{Quot}_{\mathbb{C}^3}^n(I_{\lambda\mu\nu}, \{0\})$$

A quotient parametrised here will have kernel that is the ideal sheaf of a one-dimensional scheme Z with underlying Cohen-Macaulay (formal) curve $\mathbb{C}_{\lambda, \mu, \nu}$. The embedded points of this scheme are all supported at the origin, but Z doesn't have to be locally monomial. We use the following variation of the notation for the topological vertex:

$$\tilde{V}_{\lambda\mu\nu} := e(\text{Quot}^\bullet(\lambda, \mu, \nu)) \in \mathbb{Z}[[p]].$$

Lemma 4.5.1. *Let C be a partition thickened section, fibre or C_3 -banana curve thickened by λ . Then*

- 1) *If $x \in C$ is a smooth point then $e(\text{Quot}_X^n(I_C, \{x\})) = \tilde{V}_{\lambda\emptyset\emptyset}$.*
- 2) *If C is a thickened nodal fibre then $e(\text{Quot}_X^n(I_C, \{x\})) = \tilde{V}_{\lambda\lambda^t\emptyset}$.*

Let C' be a reduced curve intersecting C at $y \in C$ such that $I_{C'} \cap I_C$ is locally monomial and there are formal local coordinates $\mathbb{C}[[r, s, t]]$ at y such that:

- 1) *$I_{C'} \cap I_C = (t^{\lambda^1}, \dots, s^{l-1}t^{\lambda^l}, s^l) \cap (r, s)$ then $e(\text{Quot}_X^n(I_C, \{x\})) = \tilde{V}_{\lambda\emptyset\Box}$.*
- 2) *$I_{C'} \cap I_C = (t^{\lambda^1}, \dots, s^{l-1}t^{\lambda^l}, s^l) \cap (r, s) \cap (r, t)$ then $e(\text{Quot}_X^n(I_C, \{x\})) = \tilde{V}_{\lambda\Box\Box}$.*

Proof. The proof is the same as [BK] Lemma 15. \square

Lemma 4.5.2. *Let D be a one dimensional Cohen-Macaulay subscheme of X .*

- 1) *We have:*

$$e(\text{Quot}_X^n(I_D, X \setminus D)) = \left(\tilde{V}_{\emptyset\emptyset\emptyset}\right)^{e(X) - e(C)}.$$

- 2) *Let λ be a 2D partition and $\lambda C \subset D$ be either a partition thickened section, fibre or C_3 banana and let T be finite set of points on C such that $C \setminus T$ is smooth. Then*

$$e(\text{Quot}_X^n(I_D, C \setminus T)) = \left(\tilde{V}_{\lambda\emptyset\emptyset}\right)^{e(C) - e(T)}.$$

Proof. The argument is the same as that given for equation (9) in [BK]. \square

The standard $(\mathbb{C}^*)^3$ -action on \mathbb{C}^3 induces an action on the Quot schemes. The invariant ideals $I \subset \mathbb{C}[[r, s, t]]$ are precisely those generated by monomials. Also, since there is a bijection between locally monomial ideals and 3D partitions we see that

$$\begin{aligned} \tilde{V}_{\lambda\mu\nu} &= e(\text{Quot}^\bullet(\lambda, \mu, \nu)^{(\mathbb{C}^*)^3}) \\ &= \sum_{\boldsymbol{\eta}} p^{n(\boldsymbol{\eta})} \end{aligned}$$

where we are summing over 3D partitions asymptotic to (λ, μ, ν) and $n(\boldsymbol{\eta})$ is the number of boxes not contained in any legs. Note that that the lowest order term in $\tilde{V}_{\lambda\mu\nu}$ is one, which is not true about $V_{\lambda\mu\nu}$ in general. In fact we have the relationship:

$$V_{\lambda\mu\nu} = p^{|\boldsymbol{\eta}_{min}|} \tilde{V}_{\lambda\mu\nu}$$

where $\boldsymbol{\eta}_{min}$ is the 3D partition associated to $\mathbb{C}_{\lambda\mu\nu}$, and $|\cdot|$ is the renormalised volume defined in eqn (7).

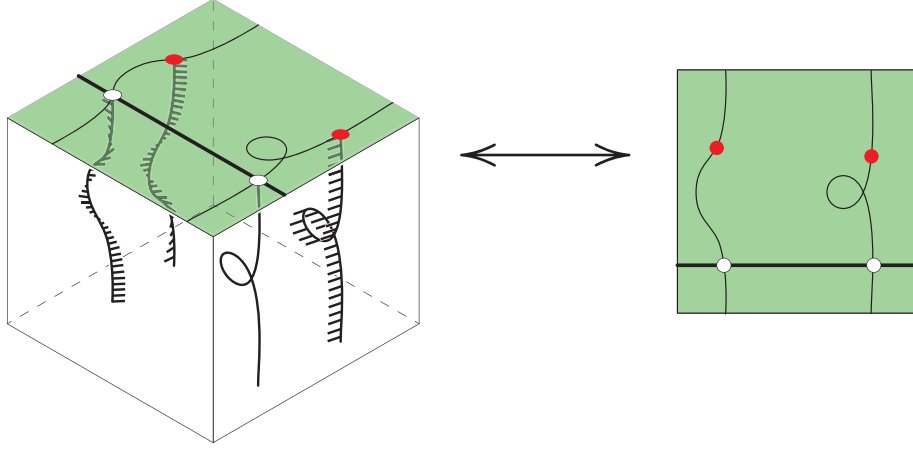

Figure 9. Depiction of the decomposition of the Chow sub-scheme that parametrises the vertical fibres of pr_2 . The red dots indicate when the fibres don't intersect the section i.e. Sm_2^\emptyset and N_2^\emptyset . The white dots indicate when the fibres do intersect the section i.e. Sm_2^σ and N_2^σ .

Lemma 4.5.3. *If λ is a 2D partition then we have the following equalities:*

- 1) $V_{\lambda\emptyset\emptyset} = \tilde{V}_{\lambda\emptyset\emptyset}$
- 2) $V_{\lambda\square\emptyset} = p^{-\lambda_1} \tilde{V}_{\lambda\square\emptyset}$
- 3) $V_{\lambda\square\square} = p^{-\lambda_1 - \lambda_1^t} \tilde{V}_{\lambda\square\square}$
- 4) $V_{\lambda\lambda^t\emptyset} = p^{-\|\lambda\|^2} \tilde{V}_{\lambda\lambda^t\emptyset}$

Proof. Parts 1), 2) and 4) are directly from [BK] lemma 17. For part 3), there are λ_1 boxes that are in the λ -leg and one of the \square -legs. There are λ_1^t boxes that are in the λ -leg and the other \square -leg. There is one box that is contained in all three so the renormalised volume is calculated to be

$$(\lambda_i - 1)(1 - 2) + (\lambda_i^t - 1)(1 - 2) + (1)(1 - 3) = -\lambda_i - \lambda_i^t$$

□

5. CALCULATING THE EULER CHARACTERISTIC FROM THE FIBRES OF THE CHOW MAP

5.1. Calculation for the class $\sigma + (0, \bullet, \bullet)$. We now recall some previously introduced notation:

- 1) $B_i = \{b_i^1, \dots, b_i^{12}\}$ is the set of the 12 points in S_i that correspond to nodes in the fibres of the projection $\pi_i := \text{pr}|_{S_i} : S_i \rightarrow \mathbb{P}^1$.
- 2) $S_i^\circ = S_i \setminus B_i$ is the complement of B_i in S_i
- 3) $N_i \subset S_i$ are the 12 nodal fibres of $\pi_i : S_i \rightarrow \mathbb{P}^1$ with the nodes removed and:
 $N_i = N_i^\sigma \amalg N_i^\emptyset$ where $N_i^\sigma := N_i \cap \sigma$ and $N_i^\emptyset := N_i \setminus \sigma$.
- 4) $\text{Sm}_i = S_i^\circ \setminus N_i$ is the complement of N_i in S_i° and:
 $\text{Sm}_i = \text{Sm}_i^\sigma \amalg \text{Sm}_i^\emptyset$ where $\text{Sm}_i^\sigma := \text{Sm}_i \cap \sigma$ and $\text{Sm}_i^\emptyset := \text{Sm}_i \setminus \sigma$.

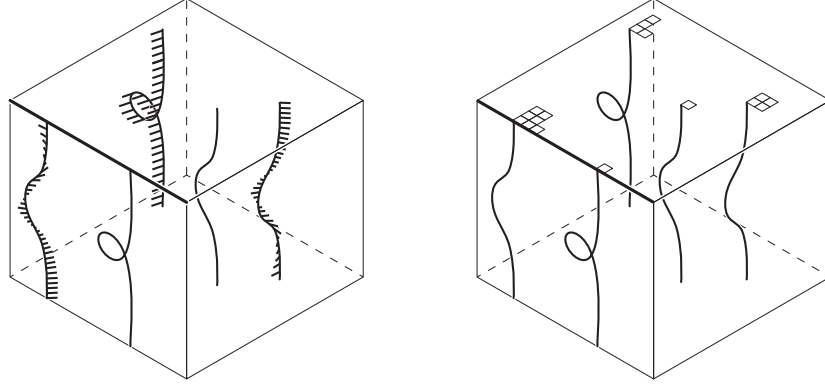

Figure 10. Visual depictions of Cohen-Macaulay subschemes in the fibres of ρ_\bullet that are supported away from the banana configurations. On the left is a general subscheme and on the right is a partition thickened curve which is a fixed point of the $(\mathbb{C}^*)^2$ -action.

Now from lemma 3.5.1 we can further decompose $\text{Chow}^{\sigma+(0,\bullet,\bullet)}(X)$ as:

$$\begin{aligned} & \text{Sym}_{Q_2 Q_3}^\bullet(\mathbf{Sm}_2^\sigma) \times \text{Sym}_{Q_2 Q_3}^\bullet(\mathbf{N}_2^\sigma) \times \text{Sym}_{Q_2 Q_3}^\bullet(\mathbf{Sm}_2^\emptyset) \times \text{Sym}_{Q_2 Q_3}^\bullet(\mathbf{N}_2^\emptyset) \\ & \times \text{Sym}_{Q_2}^\bullet(B_2) \times \text{Sym}_{Q_3}^\bullet(B_{\text{op}}). \end{aligned}$$

Moreover, if $\mathfrak{q} = (\mathbf{ax}, \mathbf{cy}, \mathbf{dz}, \mathbf{lw}, \mathbf{mb}_2, \mathbf{nb}_{\text{op}}) \in \text{Chow}^{\sigma+(0,\bullet,\bullet)}(X)$ then the fibre is given by $\rho_\bullet^{-1}(\mathfrak{q}) \cong \text{Hilb}_{\mathcal{C}_{\text{yc}}}^\bullet(X, \mathfrak{q})$ where

$$\begin{aligned} \mathfrak{q} = & \sigma + \sum_i a_i \text{pr}_2^{-1}(x_i) + \sum_i c_i \text{pr}_2^{-1}(y_i) \\ & + \sum_i d_i \text{pr}_2^{-1}(z_i) + \sum_i l_i \text{pr}_2^{-1}(w_i) + \sum_i m_i C_2^{(i)} + \sum_i n_i C_3^{(i)}. \end{aligned}$$

5.1.1. Suppose C is Cohen-Macaulay with the cycle given above. Note that C can be decomposed into a part supported on $C_2 \cup C_3$ and a part supported away from the banana configuration. This gives the following formal neighbourhoods and $(\mathbb{C}^*)^2$ -actions:

- 1) Let U_i be the formal neighbourhood of $C_2^{(i)} \cup C_3^{(i)}$ in X . These have a canonical $(\mathbb{C}^*)^2$ -action described in 4.4.7 and 4.4.11.
- 2) Let V_i be the formal neighbourhood of $\text{pr}_2^{-1}(y_i)$ in X . These have a canonical $(\mathbb{C}^*)^2$ -action described in definition 4.4.13 and $\sigma \cap V_i$ is either empty or invariant under this action.

Hence the conditions of lemma 4.2.1 are satisfied and there is a $(\mathbb{C}^*)^2$ -action defined on $\text{Hilb}_{\mathcal{C}_{\text{M}}}^\bullet(X, \mathfrak{q})$. Using the partition thickened notation introduced in section 4.4 we introduce the subschemes:

$$\begin{aligned} C_{\alpha, \gamma, \delta, \lambda, \mu, \nu} := & \sigma \cup \bigcup_i (\alpha^{(i)} f_{x_i}) \cup \bigcup_i (\gamma^{(i)} f_{y_i}) \cup \bigcup_i (\delta^{(i)} f_{z_i}) \\ & \cup \bigcup_i (\lambda^{(i)} f_{w_i}) \cup \bigcup_i (\mu^{(i)} C_2^{(i)}) \cup \bigcup_i (\nu^{(i)} C_3^{(i)}) \end{aligned}$$

and their ideals $I_{\alpha, \gamma, \delta, \lambda, \mu, \nu}$ in X where $\alpha, \gamma, \delta, \lambda, \mu$ and ν are tuples of partitions of $\mathbf{a}, \mathbf{c}, \mathbf{d}, \mathbf{l}, \mathbf{m}$ and \mathbf{n} respectively. Then using this notation we can identify the

fixed points of the action as the following formal sum of discrete sets:

$$\text{Hilb}_{\text{CM}}^{\diamond}(X, \mathfrak{q})^{(\mathbb{C}^*)^2} = \coprod_{\substack{\alpha \vdash a, \gamma \vdash c, \delta \vdash d, \\ \lambda \vdash l, \mu \vdash m, \nu \vdash n}} \{C_{\alpha, \gamma, \delta, \lambda, \mu, \nu}\}$$

Using the result of 4.2.3 we have

$$\begin{aligned} e\left(\text{Hilb}_{\text{Cyc}}^{\bullet}(X, \mathfrak{q})\right) &= e\left(\text{Hilb}_{\text{CM}}^{\diamond}(X, \mathfrak{q})^{(\mathbb{C}^*)^2}, \kappa_* 1\right) \\ &= \sum_{\substack{\alpha \vdash a, \gamma \vdash c, \delta \vdash d, \\ \lambda \vdash l, \mu \vdash m, \nu \vdash n}} e\left(\text{Hilb}^{\bullet}(X, C_{\alpha, \gamma, \delta, \lambda, \mu, \nu})\right) p^{\chi(\mathcal{O}_{C_{\alpha, \gamma, \delta, \lambda, \mu, \nu}})} \\ &= \sum_{\substack{\alpha \vdash a, \gamma \vdash c, \delta \vdash d, \\ \lambda \vdash l, \mu \vdash m, \nu \vdash n}} e\left(\text{Quot}_X^{\bullet}(I_{\alpha, \gamma, \delta, \lambda, \mu, \nu})\right) p^{\chi(\mathcal{O}_{C_{\alpha, \gamma, \delta, \lambda, \mu, \nu}})}. \end{aligned}$$

5.1.2. Using the decomposition method of 4.2.4 following method:

- 1) Decompose X by $X = W \amalg C_{\alpha, \gamma, \delta, \lambda, \mu, \nu}$ where $W := X \setminus C_{\alpha, \gamma, \delta, \lambda, \mu, \nu}$.
- 2) Let $C_{\alpha, \gamma, \delta, \lambda, \mu, \nu}^{\diamond}$ be set points given by the following disjoint sets:
 - a) $\sigma_{\alpha}^{\diamond} := \sigma \cap C_{\alpha}^{\text{red}}$
 - b) $\sigma_{\gamma}^{\diamond} := \sigma \cap C_{\gamma}^{\text{red}}$
 - c) C_{γ}^{\diamond} the set of nodes of C_{γ}
 - d) C_{λ}^{\diamond} the set of nodes of C_{λ}
 - e) $B^{\diamond} = \bigcup_i (C_2^{(i)} \cap C_3^{(i)})$.
- 3) Denote the components supported on smooth reduced sub-curves by:
 - a) $\sigma^{\diamond} := \sigma \setminus \sigma^{\diamond}$
 - b) $C_{\alpha}^{\diamond} := C_{\alpha} \setminus \sigma_{\alpha}^{\diamond}$
 - c) $C_{\gamma}^{\diamond} := C_{\gamma} \setminus (\sigma_{\gamma}^{\diamond} \cup C_{\lambda}^{\diamond})$
 - d) $C_{\lambda}^{\diamond} := C_{\lambda} \setminus C_{\lambda}^{\diamond}$
 - e) $C_{\mu}^{\diamond} := C_{\mu} \setminus B^{\diamond}$
 - f) $C_{\nu}^{\diamond} := C_{\nu} \setminus B^{\diamond}$

5.1.3. Then applying Euler characteristic to lemma 4.1.4 we have:

$$\begin{aligned} &e\left(\text{Quot}_X^{\bullet}(I_{\alpha, \gamma, \delta, \lambda, \mu, \nu})\right) \\ &= e\left(\text{Quot}_X^{\bullet}(I_{\alpha, \gamma, \delta, \lambda, \mu, \nu}, W)\right) e\left(\text{Quot}_X^{\bullet}(I_{\alpha, \gamma, \delta, \lambda, \mu, \nu}, \sigma^{\diamond})\right) \\ &\quad e\left(\text{Quot}_X^{\bullet}(I_{\alpha, \gamma, \delta, \lambda, \mu, \nu}, \sigma_{\alpha}^{\diamond})\right) e\left(\text{Quot}_X^{\bullet}(I_{\alpha, \gamma, \delta, \lambda, \mu, \nu}, C_{\alpha}^{\diamond})\right) \\ &\quad e\left(\text{Quot}_X^{\bullet}(I_{\alpha, \gamma, \delta, \lambda, \mu, \nu}, \sigma_{\gamma}^{\diamond})\right) e\left(\text{Quot}_X^{\bullet}(I_{\alpha, \gamma, \delta, \lambda, \mu, \nu}, C_{\gamma}^{\diamond})\right) e\left(\text{Quot}_X^{\bullet}(I_{\alpha, \gamma, \delta, \lambda, \mu, \nu}, C_{\gamma}^{\diamond})\right) \\ &\quad e\left(\text{Quot}_X^{\bullet}(I_{\alpha, \gamma, \delta, \lambda, \mu, \nu}, C_{\delta})\right) \\ &\quad e\left(\text{Quot}_X^{\bullet}(I_{\alpha, \gamma, \delta, \lambda, \mu, \nu}, C_{\lambda}^{\diamond})\right) e\left(\text{Quot}_X^{\bullet}(I_{\alpha, \gamma, \delta, \lambda, \mu, \nu}, C_{\lambda}^{\diamond})\right) \\ &\quad e\left(\text{Quot}_X^{\bullet}(I_{\alpha, \gamma, \delta, \lambda, \mu, \nu}, B^{\diamond})\right) e\left(\text{Quot}_X^{\bullet}(I_{\alpha, \gamma, \delta, \lambda, \mu, \nu}, C_{\mu}^{\diamond})\right) e\left(\text{Quot}_X^{\bullet}(I_{\alpha, \gamma, \delta, \lambda, \mu, \nu}, C_{\nu}^{\diamond})\right) \end{aligned}$$

Lemma 5.1.4. *The holomorphic Euler characteristic of $C_{\alpha, \gamma, \delta, \lambda, \mu, \nu}$ is:*

$$\chi(\mathcal{O}_{C_{\alpha, \gamma, \delta, \lambda, \mu, \nu}}) = 1 + \sum_i \chi(\mathcal{O}_{\mu^{(i)} C_2^{(i)} \cup \nu^{(i)} C_3^{(i)}}) - \sum_i \alpha^{(i)} - \sum_i \gamma^{(i)}$$

and we have

$$\begin{aligned} & p^{\chi(\mathcal{O}_{\mu^{(i)}C_2^{(i)} \cup \nu^{(i)}C_3^{(i)}})} \widetilde{V}_{\mu^{(i)}\nu^{(i)}\emptyset} \widetilde{V}_{(\mu^{(i)})^t(\nu^{(i)})^t\emptyset} \\ &= p^{\frac{1}{2}(\|\mu^{(i)}\|^2 + \|(\mu^{(i)})^t\|^2 + \|\nu^{(i)}\|^2 + \|(\nu^{(i)})^t\|^2)} V_{\mu^{(i)}\nu^{(i)}\emptyset} V_{(\mu^{(i)})^t(\nu^{(i)})^t\emptyset}. \end{aligned}$$

Proof. Define the sheaves:

$$\begin{aligned} \mathcal{F}^\sigma &:= \mathcal{O}_\sigma \oplus \left(\bigoplus_i \mathcal{O}_{\alpha^{(i)}f_{x_i}} \right) \oplus \left(\bigoplus_i \mathcal{O}_{\beta^{(i)}f_{y_i}} \right) \\ \mathcal{F}^\emptyset &:= \left(\bigoplus_i \mathcal{O}_{\delta^{(i)}f_{z_i}} \right) \oplus \left(\bigoplus_i \mathcal{O}_{\lambda^{(i)}f_{w_i}} \right) \\ \mathcal{F}^\square &:= \left(\bigoplus_i \mathcal{O}_{\sigma \cap \alpha^{(i)}f_{x_i}} \right) \oplus \left(\bigoplus_i \mathcal{O}_{\sigma \cap \beta^{(i)}f_{y_i}} \right) \\ \mathcal{B} &:= \bigoplus_i \mathcal{O}_{\mu^{(i)}C_2^{(i)} \cup \nu^{(i)}C_3^{(i)}} \end{aligned}$$

The exact sequence decomposing $C_{\alpha,\gamma,\delta,\lambda,\mu,\nu}$ is then

$$0 \longrightarrow \mathcal{O}_{C_{\alpha,\gamma,\delta,\lambda,\mu,\nu}} \longrightarrow \mathcal{F}^\sigma \oplus \mathcal{F}^\emptyset \oplus \mathcal{B} \longrightarrow \mathcal{F}^\square \longrightarrow 0$$

The result now follows from 4.4.17 and the fact that $\chi(\mathcal{O}_\sigma) = 1$. \square

5.1.5. Applying lemmas 5.1.4, 4.5.1 and 4.5.2 we have:

$$\begin{aligned} & e(\text{Quot}_X^\bullet(I_{\alpha,\gamma,\delta,\lambda,\mu,\nu})) p^{\chi(\mathcal{O}_{C_{\alpha,\gamma,\delta,\lambda,\mu,\nu}})} \\ &= p \cdot \left(\widetilde{V}_{\emptyset\emptyset\emptyset} \right)^{e(W)} \left(\widetilde{V}_{\square\emptyset\emptyset} \right)^{e(\sigma^\circ)} \\ & \quad \cdot \prod_i \left(p^{-\alpha_i} \widetilde{V}_{\alpha^{(i)}\square\emptyset} \right) \prod_i \left(\widetilde{V}_{\alpha^{(i)}\emptyset\emptyset} \right)^{-1} \\ & \quad \cdot \prod_i \left(p^{-\gamma_i} \widetilde{V}_{\gamma^{(i)}\square\emptyset} \right) \prod_i \left(\widetilde{V}_{\gamma^{(i)}(\gamma^{(i)})^t\emptyset} \right) \prod_i \left(\widetilde{V}_{\gamma^{(i)}\emptyset\emptyset} \right)^{-1} \\ & \quad \cdot \prod_i \left(\widetilde{V}_{\delta^{(i)}\emptyset\emptyset} \right)^0 \\ & \quad \cdot \prod_i \left(\widetilde{V}_{\lambda^{(i)}(\lambda^{(i)})^t\emptyset} \right) \prod_i \left(\widetilde{V}_{\lambda^{(i)}\emptyset\emptyset} \right)^0 \\ & \quad \cdot \prod_i \left(p^{\chi(\mathcal{O}_{\mu^{(i)}C_2^{(i)} \cup \nu^{(i)}C_3^{(i)}})} \widetilde{V}_{\mu^{(i)}\nu^{(i)}\emptyset} \widetilde{V}_{(\mu^{(i)})^t(\nu^{(i)})^t\emptyset} \right) \prod_i \left(\widetilde{V}_{\mu^{(i)}\emptyset\emptyset} \right)^0 \prod_i \left(\widetilde{V}_{\nu^{(i)}\emptyset\emptyset} \right)^0. \end{aligned}$$

We note that $e(X) = 24$ and $e(\sigma) = 2$, so from lemma 4.5.3 we now have we have

$$\begin{aligned} & e(\text{Quot}_X^\bullet(I_{\alpha,\gamma,\delta,\lambda,\mu,\nu})) p^{\chi(\mathcal{O}_{C_{\alpha,\gamma,\delta,\lambda,\mu,\nu}})} \\ &= p \cdot \left(V_{\emptyset\emptyset\emptyset} \right)^{24} \left(\frac{V_{\square\emptyset\emptyset}}{V_{\emptyset\emptyset\emptyset}} \right)^2 \prod_i \left(\frac{V_{\emptyset\emptyset\emptyset} V_{\alpha^{(i)}\square\emptyset}}{V_{\square\emptyset\emptyset} V_{\alpha^{(i)}\emptyset\emptyset}} \right) \\ & \quad \cdot \prod_i \left(\frac{V_{\emptyset\emptyset\emptyset} p^{\|\gamma^{(i)}\|^2} V_{\gamma^{(i)}\square\emptyset} V_{\gamma^{(i)}(\gamma^{(i)})^t\emptyset}}{V_{\emptyset\emptyset\emptyset} V_{\gamma^{(i)}\emptyset\emptyset}} \right) \prod_i \left(p^{\|\lambda^{(i)}\|^2} \frac{V_{\lambda^{(i)}(\lambda^{(i)})^t\emptyset}}{V_{\emptyset\emptyset\emptyset}} \right) \\ & \quad \cdot \prod_i \left(p^{\frac{1}{2}(\|\mu^{(i)}\|^2 + \|(\mu^{(i)})^t\|^2 + \|\nu^{(i)}\|^2 + \|(\nu^{(i)})^t\|^2)} \frac{V_{\mu^{(i)}\nu^{(i)}\emptyset} V_{(\mu^{(i)})^t(\nu^{(i)})^t\emptyset}}{V_{\emptyset\emptyset\emptyset} V_{\emptyset\emptyset\emptyset}} \right) \end{aligned}$$

We now define the functions:

- 1) $g_{\text{Sm}^\sigma} : \mathbb{Z}_{\geq 0} \rightarrow Z((p))$ is defined by $g_{\text{Sm}^\sigma}(a) = \frac{V_{\emptyset\emptyset\emptyset}}{V_{\square\emptyset\emptyset}} \sum_{\alpha \vdash a} \frac{V_{\alpha\square\emptyset}}{V_{\alpha^{(i)}\emptyset\emptyset}}$,
- 2) $g_{\text{N}^\sigma} : \mathbb{Z}_{\geq 0} \rightarrow Z((p))$ is defined by $g_{\text{N}^\sigma}(c) = \frac{V_{\emptyset\emptyset\emptyset}}{V_{\square\emptyset\emptyset}} \sum_{\gamma \vdash c} p^{\|\gamma^{(i)}\|^2} \frac{V_{\gamma\square\emptyset} V_{\gamma\gamma^t\emptyset}}{V_{\emptyset\emptyset\emptyset} V_{\gamma\emptyset\emptyset}}$,
- 3) $g_{\text{Sm}^0} : \mathbb{Z}_{\geq 0} \rightarrow Z((p))$ is defined by $g_{\text{Sm}^0}(d) = \sum_{\delta \vdash d} 1$,
- 4) $g_{\text{N}^0} : \mathbb{Z}_{\geq 0} \rightarrow Z((p))$ is defined by $g_{\text{N}^0}(l) = \sum_{\lambda \vdash l} p^{\|\lambda^{(i)}\|^2} \frac{V_{\lambda\lambda^t\emptyset}}{V_{\emptyset\emptyset\emptyset}}$,
- 5) $g_B : \mathbb{Z}_{\geq 0} \times \mathbb{Z}_{\geq 0} \rightarrow Z((p))$ is defined by the equation

$$g_B(m, n) = \sum_{\substack{\mu \vdash m \\ \nu \vdash n}} p^{\frac{1}{2}(\|\mu^{(i)}\|^2 + \|\mu^t\|^2 + \|\nu\|^2 + \|\nu^t\|^2)} \frac{V_{\mu\nu\emptyset} V_{\mu^t\nu^t\emptyset}}{V_{\emptyset\emptyset\emptyset} V_{\emptyset\emptyset\emptyset}}.$$

So the constructible function $(\rho_\bullet)_* 1 : \text{Chow}^{\sigma+(0, \bullet, \bullet)}(X) \rightarrow Z((p))$ is calculated for $\mathfrak{q} = (\mathbf{ax}, \mathbf{cy}, \mathbf{dz}, \mathbf{lw}, \mathbf{mb}_2, \mathbf{nb}_{\text{op}})$ by:

$$\begin{aligned} & ((\rho_\bullet)_* 1)(\mathfrak{q}) \\ &= e\left(\rho_\bullet^{-1}(\mathfrak{q})\right) \\ &= \sum_{\substack{\alpha \vdash a, \gamma \vdash c, \delta \vdash d, \\ \lambda \vdash l, \mu \vdash m, \nu \vdash n}} e\left(\text{Quot}_X^\bullet(I_{\alpha, \gamma, \delta, \lambda, \mu, \nu})\right) p^{\chi(\mathcal{O}_{C_{\alpha, \gamma, \delta, \lambda, \mu, \nu}})} \\ &= p \cdot \left(V_{\emptyset\emptyset\emptyset}\right)^{24} \left(\frac{V_{\square\emptyset\emptyset}}{V_{\emptyset\emptyset\emptyset}}\right)^2 \prod_i g_{\text{Sm}^\sigma}(a_i) \prod_i g_{\text{N}^\sigma}(c_i) \prod_i g_{\text{Sm}^0}(d_i) \prod_i g_{\text{N}^0}(l_i) \prod_i g_B(m_i, n_i). \end{aligned}$$

So we can now apply lemma 2.1.3 and reintroduce the formal variables Q_2 and Q_3 to obtain:

$$\begin{aligned} & e\left(\text{Chow}^{\sigma+(0, \bullet, \bullet)}(X), (\rho_\bullet)_* 1\right) \\ &= p \cdot \left(V_{\emptyset\emptyset\emptyset}\right)^{24} \left(\frac{V_{\square\emptyset\emptyset}}{V_{\emptyset\emptyset\emptyset}}\right)^2 \left(\frac{V_{\emptyset\emptyset\emptyset}}{V_{\square\emptyset\emptyset}} \sum_{\alpha} (Q_2 Q_3)^{|\alpha|} \frac{V_{\alpha\square\emptyset}}{V_{\alpha\emptyset\emptyset}}\right)^{e(\text{Sm}^\sigma)} \\ & \quad \cdot \left(\frac{V_{\emptyset\emptyset\emptyset}}{V_{\square\emptyset\emptyset}} \sum_{\gamma} (Q_2 Q_3)^{|\gamma|} p^{\|\gamma\|^2} \frac{V_{\gamma\square\emptyset} V_{\gamma\gamma^t\emptyset}}{V_{\emptyset\emptyset\emptyset} V_{\gamma\emptyset\emptyset}}\right)^{e(\text{N}^\sigma)} \\ & \quad \cdot \left(\sum_{\delta} (Q_2 Q_3)^{|\delta|}\right)^{e(\text{Sm}^0)} \left(\sum_{\lambda} (Q_2 Q_3)^{|\lambda|} p^{\|\lambda\|^2} \frac{V_{\lambda\lambda^t\emptyset}}{V_{\emptyset\emptyset\emptyset}}\right)^{e(\text{N}^0)} \\ & \quad \cdot e\left(\text{Sym}_{Q_2}^\bullet(B_2) \times \text{Sym}_{Q_3}^\bullet(B_{\text{op}}), G_B\right) \end{aligned}$$

where G_B is the constructible function

$$G_B : \text{Sym}_{Q_2}^\bullet(B_2) \times \text{Sym}_{Q_3}^\bullet(B_{\text{op}}) \rightarrow Z((p))$$

defined by $G_B(\mathbf{mb}_2, \mathbf{nb}_{\text{op}}) := \prod_{i=1}^{12} g_B(m_i, n_i)$. However, since $B_2 = \{b_2^1, \dots, b_2^{12}\}$ and $B_{\text{op}} = \{b_{\text{op}}^1, \dots, b_{\text{op}}^{12}\}$ we have:

$$\text{Sym}_{Q_2}^\bullet(B_2) \times \text{Sym}_{Q_3}^\bullet(B_{\text{op}}) \cong \prod_{i=1}^{12} \text{Sym}_{Q_2}^\bullet(\{b_2^{(i)}\}) \times \text{Sym}_{Q_3}^\bullet(\{b_{\text{op}}^{(i)}\}).$$

Defining $G_B^{(i)} := G_B|_{\text{Sym}_{Q_2}^\bullet(\{b_2^{(i)}\}) \times \text{Sym}_{Q_3}^\bullet(\{b_{\text{op}}^{(i)}\})}$ gives us:

$$\begin{aligned} & e\left(\text{Sym}_{Q_2}^\bullet(B_2) \times \text{Sym}_{Q_3}^\bullet(B_{\text{op}}), G_B\right) \\ &= \prod_{i=1}^{12} e\left(\text{Sym}_{Q_2}^\bullet(\{b_2^{(i)}\}) \times \text{Sym}_{Q_3}^\bullet(\{b_{\text{op}}^{(i)}\}), G_B^{(i)}\right) \\ &= \left(\sum_{\mu, \nu} Q_2^{|\mu|} Q_3^{|\nu|} p^{\frac{1}{2}(\|\mu\|^2 + \|\mu^t\|^2 + \|\nu\|^2 + \|\nu^t\|^2)} \frac{V_{\mu\nu\emptyset} V_{\mu^t\nu^t\emptyset}}{V_{\emptyset\emptyset\emptyset} V_{\emptyset\emptyset\emptyset}}\right)^{12} \end{aligned}$$

5.1.6. Applying the vertex formulas of lemmas 6.3.6, 6.3.2 and 6.3.4 we have

$$\begin{aligned} & e\left(\text{Chow}^{\sigma+(0, \bullet, \bullet)}(X), (\rho_\bullet)_* 1\right) \\ &= M(p)^{24} \frac{p}{(1-p)^2} \left(\prod_{d>0} \frac{(1-Q_2^d Q_3^d)}{(1-pQ_2^d Q_3^d)(1-p^{-1}Q_2^d Q_3^d)}\right)^{-10} \\ & \quad \cdot \left(\prod_{d>0} \frac{M(p, Q_2^d Q_3^d)}{(1-pQ_2^d Q_3^d)(1-p^{-1}Q_2^d Q_3^d)}\right)^{12} \\ & \quad \cdot \left(\prod_{d>0} \frac{1}{(1-Q_2^d Q_3^d)}\right)^{10} \left(\prod_{d>0} \frac{M(p, Q_2^d Q_3^d)}{(1-Q_2^d Q_3^d)}\right)^{-12} \\ & \quad \cdot \left(\prod_{d>0} \frac{M(p, Q_2^d Q_3^d)^2}{(1-Q_2^d Q_3^d)M(p, -Q_2^{d-1} Q_3^d)M(p, -Q_2^d Q_3^{d-1})}\right)^{12} \\ &= \frac{M(p)^{24}}{(1-p)^2} \prod_{d>0} \frac{1}{(1-Q_2^d Q_3^d)^8 (1-pQ_2^d Q_3^d)^2 (1-p^{-1}Q_2^d Q_3^d)^2} \\ & \quad \cdot \left(\prod_{d>0} \frac{M(p, Q_2^d Q_3^d)^2}{(1-Q_2^d Q_3^d)M(p, -Q_2^{d-1} Q_3^d)M(p, -Q_2^d Q_3^{d-1})}\right)^{12} \end{aligned}$$

Which completes the proof of theorem A.

5.2. Preliminaries for classes of the form $\bullet\sigma + (i, j, \bullet)$. We recall from lemma 3.5.3 that there is a decomposition of $\text{Chow}^{\bullet\sigma+(i, j, \bullet)}(X)$ such that for any point $\mathfrak{q} \in \text{Chow}^{\bullet\sigma+(i, j, \bullet)}(X)$ the fibre is

$$(\eta_\bullet)^{-1}(\mathfrak{q}) \cong \text{Hilb}_{\text{Cyc}}^\bullet(X, \text{Cyc}(C))$$

for some one dimensional subscheme C of X with

$$(8) \quad \text{Cyc}(C) = \mathfrak{q} = a\sigma + D + \sum_{i=1}^{12} m_i C_3^{(i)}$$

where D is a one dimensional *reduced* subscheme of X . We see from lemma 3.5.3 that the intersection of D with σ has length 0, 1 or 2. We consider the following formal neighbourhoods around components of C :

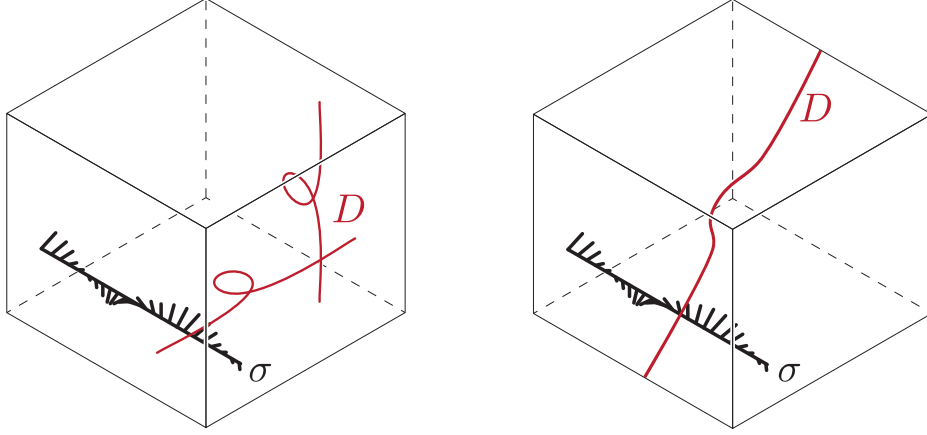

Figure 11. Depiction of two typical curves (away from C_3) in the class $b\sigma + (1, 1, d)$.

- 1) Let U_i be the formal neighbourhood of $C_3^{(i)}$ in X . These have a canonical $(\mathbb{C}^*)^2$ -action described in 4.4.7 and the $(\mathbb{C}^*)^2$ -invariance of $D \cap U_i$ is shown in lemma 4.4.9.
- 2) Let V be the formal neighbourhood of σ in X with the coordinates:
 - a) If $\#(D \cap \sigma) = 0, 2$ the let V have the canonical coordinates of 4.4.1 of and $(\mathbb{C}^*)^2$ -action described in 4.4.3.
 - b) If $\#(D \cap \sigma) = 1$ the let V have the canonical coordinates of 4.4.2 of and $(\mathbb{C}^*)^2$ -action described in 4.4.3.

By construction the restrictions of D to these neighbourhoods are invariant under these actions. Hence the conditions of lemma 4.2.1 are satisfied and there is a $(\mathbb{C}^*)^2$ -action defined on $\text{Hilb}_{\text{CM}}^n(X, \text{Cyc}(C))$. We introduce the notation for subschemes of X :

$$C_{\alpha, \mu} = C_{\alpha, \mu^{(1)}, \dots, \mu^{(12)}} = \alpha\sigma \cup D \cup \bigcup_{i=1}^{12} \mu_i C_3^{(i)}$$

and their ideals $I_{\alpha, \mu}$. Then using this notation we can identify the fixed points of the action as the following discrete set:

$$\text{Hilb}_{\text{CM}}^{\diamond}(X, \mathfrak{q})^{(\mathbb{C}^*)^2} = \prod_{\alpha \vdash a, \mu \vdash \mathfrak{m}} \{ C_{\alpha, \mu} \}.$$

Using the result of 4.2.3 we have

$$\begin{aligned} e\left(\text{Hilb}_{\text{Cyc}}^{\bullet}(X, \mathfrak{q})\right) &= e\left(\text{Hilb}_{\text{CM}}^{\diamond}(X, \mathfrak{q})^{(\mathbb{C}^*)^2}, \kappa_* 1\right) \\ &= \sum_{\alpha \vdash a, \mu \vdash \mathfrak{m}} e\left(\text{Hilb}^{\bullet}(X, C_{\alpha, \mu}) p^{\chi(\mathcal{O}_{C_{\alpha, \mu}})}\right) \\ &= \sum_{\alpha \vdash a, \mu \vdash \mathfrak{m}} e\left(\text{Quot}_X^{\bullet}(I_{\alpha, \mu}) p^{\chi(\mathcal{O}_{C_{\alpha, \mu}})}\right). \end{aligned}$$

Where the holomorphic Euler characteristic $\chi(\mathcal{O}_{C_{\alpha, \mu}})$ is given by the following lemma.

Lemma 5.2.1. *The holomorphic Euler characteristic of $C_{\alpha,\mu}$ is:*

$$\begin{aligned} \chi(\mathcal{O}_{C_{\alpha,\mu}}) &= \chi(\mathcal{O}_D) + \left(\chi(\mathcal{O}_{\alpha\sigma}) - |D \cap \alpha\sigma| \right) \\ &\quad + \left(\sum_{i=1}^{12} \chi(\mathcal{O}_{\mu^{(i)}C_3^{(i)}}) - \sum_{i=1}^{12} |D \cap \mu^{(i)}C_3^{(i)}| \right). \end{aligned}$$

Proof. This is immediate from the exact sequence decomposing $C_{\alpha,\mu}$ into irreducible components:

$$0 \rightarrow \mathcal{O}_{C_{\alpha,\mu}} \rightarrow \mathcal{O}_D \oplus \mathcal{O}_{\alpha\sigma} \oplus \bigoplus_i \mathcal{O}_{\mu^{(i)}C_3^{(i)}} \rightarrow \mathcal{O}_{D \cap \alpha\sigma} \oplus \bigoplus_i \mathcal{O}_{D \cap \mu^{(i)}C_3^{(i)}} \rightarrow 0$$

□

5.2.2. Using the decomposition method of 4.2.4 we take the following steps:

- 1) Decompose X by $X = W \amalg C_{\alpha,\mu}$ where $W := X \setminus C_{\alpha,\mu}$.
- 2) Let $C_{\alpha,\mu}^\circ$ be set points given by the following disjoint sets:
 - a) D° is the set of nodes of $D \setminus (\sigma \cup_i C_3^{(i)})$.
 - b) D^* is the set singularities of $D \setminus (\sigma \cup_i C_3^{(i)})$ that are locally isomorphic to the coordinate axes in \mathbb{C}^3 .
 - c) $\sigma^\circ := \sigma \cap D$,
 - d) $B_i^\circ = (C_3^{(i)} \cap D)$ for $i \in \{1, \dots, 12\}$,
 Note that $D^\circ \cup D^*$ is the set of singularities of $D \setminus (\sigma \cup_i C_3^{(i)})$.
- 3) Denote the components supported on smooth reduced sub-curves by:
 - a) $D^\circ = D \setminus (D^\circ \cup D^*)$,
 - b) $\sigma^\circ := \sigma \setminus \sigma^\circ$,
 - c) $B_i^\circ = C_3^{(i)} \setminus B_i^\circ$ for $i \in \{1, \dots, 12\}$.

5.2.3. Then applying Euler characteristic to lemma 4.1.4 we have:

$$\begin{aligned} &e\left(\mathrm{Quot}_X^\bullet(I_{\alpha,\mu})\right) p^{\chi(\mathcal{O}_{C_{\alpha,\mu}})} \\ (9) \quad &= e\left(\mathrm{Quot}_X^\bullet(I_{\alpha,\mu}, W)\right) \\ (10) \quad &p^{\chi(\mathcal{O}_D)} e\left(\mathrm{Quot}_X^\bullet(I_{\alpha,\mu}, D^\circ)\right) e\left(\mathrm{Quot}_X^\bullet(I_{\alpha,\mu}, D^\circ)\right) e\left(\mathrm{Quot}_X^\bullet(I_{\alpha,\mu}, D^*)\right) \\ (11) \quad &p^{\chi(\mathcal{O}_{\alpha\sigma}) - |D \cap \alpha\sigma|} e\left(\mathrm{Quot}_X^\bullet(I_{\alpha,\mu}, \sigma^\circ)\right) e\left(\mathrm{Quot}_X^\bullet(I_{\alpha,\mu}, \sigma^\circ)\right) \\ (12) \quad &\prod_{i=1}^{12} p^{\chi(\mathcal{O}_{\mu^{(i)}C_3^{(i)}}) - |D \cap \mu^{(i)}C_3^{(i)}|} e\left(\mathrm{Quot}_X^\bullet(I_{\alpha,\mu}, B_i^\circ)\right) e\left(\mathrm{Quot}_X^\bullet(I_{\alpha,\mu}, B_i^\circ)\right) \end{aligned}$$

5.2.4. We have that $e(X) = 24$ and $e(\sigma) = e(C_3^{(i)}) = 2$. So the Euler characteristic of W is:

$$\begin{aligned} e(W) &= e(X) - e(\sigma) - \sum_{i=1}^{12} e(C_3^{(i)}) - e(D^\circ) - e(D^\circ) - e(D^*) \\ &= -2 - e(D^\circ) - e(D^\circ) - e(D^*) \end{aligned}$$

Hence now have from lemma 4.5.2 that lines (9)-(10) from above will be:

$$\begin{aligned}\Psi(D) &:= p^{\chi(\mathcal{O}_D)} \left(\tilde{V}_{\emptyset\emptyset\emptyset} \right)^{e(W)} \left(\tilde{V}_{\square\emptyset\emptyset} \right)^{e(D^\circ)} \left(\tilde{V}_{\square\square\emptyset} \right)^{e(D^\circ)} \left(\tilde{V}_{\square\square\square} \right)^{e(D^*)} \\ &= p^{\chi(\mathcal{O}_D)} \left(V_{\emptyset\emptyset\emptyset} \right)^{-2} \left(\frac{V_{\square\emptyset\emptyset}}{V_{\emptyset\emptyset\emptyset}} \right)^{e(D^\circ)} \left(p \frac{V_{\square\square\emptyset}}{V_{\emptyset\emptyset\emptyset}} \right)^{e(D^\circ)} \left(p^2 \frac{V_{\square\square\square}}{V_{\emptyset\emptyset\emptyset}} \right)^{e(D^*)}\end{aligned}$$

The intersection of D and $\alpha\sigma$ will determine line (11) from above. From lemma 4.5.2 and lemma 4.5.3 it will be one of:

- 1) $p^{\frac{1}{2}(\|\alpha\|^2 + \|\alpha^t\|^2)} \left(\tilde{V}_{\emptyset\emptyset\alpha} \tilde{V}_{\emptyset\emptyset\alpha} \right) = p^{\frac{1}{2}(\|\alpha\|^2 + \|\alpha^t\|^2)} \left(V_{\emptyset\emptyset\alpha} V_{\emptyset\emptyset\alpha^t} \right)$
- 2) $p^{\frac{1}{2}(\|\alpha\|^2 + \|\alpha^t\|^2) - l(\alpha^t)} \left(\tilde{V}_{\square\emptyset\alpha} \tilde{V}_{\emptyset\emptyset\alpha} \right) = p^{\frac{1}{2}(\|\alpha\|^2 + \|\alpha^t\|^2)} \left(V_{\square\emptyset\alpha} V_{\emptyset\emptyset\alpha^t} \right)$
- 3) $p^{\frac{1}{2}(\|\alpha\|^2 + \|\alpha^t\|^2) - l(\alpha^t) - l(\alpha)} \left(\tilde{V}_{\square\emptyset\alpha} \tilde{V}_{\emptyset\square\alpha} \right) = p^{\frac{1}{2}(\|\alpha\|^2 + \|\alpha^t\|^2)} \left(V_{\square\emptyset\alpha} V_{\emptyset\square\alpha^t} \right)$
- 4) $p^{\frac{1}{2}(\|\alpha\|^2 + \|\alpha^t\|^2) - (l(\alpha) + l(\alpha^t) - 1)} \left(\tilde{V}_{\square\square\alpha} \tilde{V}_{\emptyset\emptyset\alpha} \right) = p^{\frac{1}{2}(\|\alpha\|^2 + \|\alpha^t\|^2) + 1} \left(V_{\square\square\alpha} V_{\emptyset\emptyset\alpha^t} \right)$

Similarly the factors of line (12) from above are determined by the intersections $D \cap C_3^{(i)}$ to be (the fourth comes from 4.4.8):

- 1) $p^{\frac{1}{2}(\|\alpha\|^2 + \|\alpha^t\|^2)} \left(\tilde{V}_{\emptyset\emptyset\alpha} \tilde{V}_{\emptyset\emptyset\alpha^t} \right) = p^{\frac{1}{2}(\|\alpha\|^2 + \|\alpha^t\|^2)} \left(V_{\emptyset\emptyset\alpha} V_{\emptyset\emptyset\alpha^t} \right)$
- 2) $p^{\frac{1}{2}(\|\alpha\|^2 + \|\alpha^t\|^2) - (l(\alpha^t) + l(\alpha))} \left(\tilde{V}_{\square\emptyset\alpha} \tilde{V}_{\emptyset\square\alpha^t} \right) = p^{\frac{1}{2}(\|\alpha\|^2 + \|\alpha^t\|^2)} \left(V_{\square\emptyset\alpha} V_{\emptyset\square\alpha^t} \right)$
- 3) $p^{\frac{1}{2}(\|\alpha\|^2 + \|\alpha^t\|^2) - (l(\alpha) + l(\alpha^t))} \left(\tilde{V}_{\emptyset\square\alpha} \tilde{V}_{\emptyset\square\alpha^t} \right) = p^{\frac{1}{2}(\|\alpha\|^2 + \|\alpha^t\|^2)} \left(V_{\emptyset\square\alpha} V_{\emptyset\square\alpha^t} \right)$
- 4) $p^{\frac{1}{2}(\|\alpha\|^2 + \|\alpha^t\|^2) - 2l(\alpha^t)} \left(\tilde{V}_{\emptyset\square\alpha} \right)^2 = p^{\frac{1}{2}(\|\alpha\|^2 + \|\alpha^t\|^2)} \left(V_{\emptyset\square\alpha} \right)^2$
- 5) $p^{\frac{1}{2}(\|\alpha\|^2 + \|\alpha^t\|^2) - 2(l(\alpha) + l(\alpha^t) - 1)} \left(\tilde{V}_{\square\square\alpha} \tilde{V}_{\emptyset\square\alpha^t} \right) = p^{\frac{1}{2}(\|\alpha\|^2 + \|\alpha^t\|^2) + 2} \left(V_{\square\square\alpha} V_{\emptyset\square\alpha^t} \right)$

5.2.5. We can calculate $e(\text{Hilb}_{\text{Cyc}}^\bullet(X, \mathfrak{q}))$ using the above results and notation from 5.2.4:

$$\begin{aligned}e(\text{Hilb}_{\text{Cyc}}^\bullet(X, \mathfrak{q})) &= \sum_{\alpha \vdash a, \mu \vdash m} p^{\chi(\mathcal{O}_{C_{\alpha, \mu}})} e(\text{Quot}_X^\bullet(I_{\alpha, \mu})) \\ &= \Psi(D) \Phi_\sigma(a) \prod_{i=1}^{12} \Phi_i(m_i).\end{aligned}$$

where Φ_σ and Φ_i are determined by the intersections of σ and $C_3^{(i)}$ respectively to be one of the following functions:

- 1) $\Phi^{\emptyset, \emptyset}(a) := \sum_{\alpha \vdash a} p^{\frac{1}{2}(\|\alpha\|^2 + \|\alpha^t\|^2)} (V_{\emptyset\emptyset\alpha} V_{\emptyset\emptyset\alpha^t})$
- 2) $\Phi^{-, \emptyset}(a) := \sum_{\alpha \vdash a} p^{\frac{1}{2}(\|\alpha\|^2 + \|\alpha^t\|^2)} (V_{\square\emptyset\alpha} V_{\emptyset\emptyset\alpha^t})$
- 3) $\Phi^{-, -}(a) := \sum_{\alpha \vdash a} p^{\frac{1}{2}(\|\alpha\|^2 + \|\alpha^t\|^2)} (V_{\square\emptyset\alpha} V_{\emptyset\square\alpha^t})$
- 4) $\Phi^{-, |}(a) := \sum_{\alpha \vdash a} p^{\frac{1}{2}(\|\alpha\|^2 + \|\alpha^t\|^2)} (V_{\emptyset\square\alpha})^2$
- 5) $\Phi^{+, \emptyset}(a) := \sum_{\alpha \vdash a} p^{\frac{1}{2}(\|\alpha\|^2 + \|\alpha^t\|^2) + 1} (V_{\square\square\alpha} V_{\emptyset\emptyset\alpha^t})$
- 6) $\Phi^{+, +}(a) := \sum_{\alpha \vdash a} p^{\frac{1}{2}(\|\alpha\|^2 + \|\alpha^t\|^2) + 2} (V_{\square\square\alpha} V_{\emptyset\square\alpha^t})$

5.3. **Calculation for the class $\bullet\sigma + (0, 0, \bullet)$.** From lemma 3.5.3 have the decomposition of $\text{Chow}^{\bullet\sigma+(0,0,\bullet)}(X)$ into:

$$\mathbb{Z}_{\geq 0} \times \text{Sym}_{Q_3}^{\bullet}(B_{\text{op}})$$

Recall equation (8) from section 5.2 and the notation:

$$\text{Cyc}(C) = a\sigma + D + \sum_{i=1}^{12} m_i C_3^{(i)}.$$

In this class we have $D = \emptyset$. Hence we have the following summary of results from 5.2.4 and 5.2.5.

$\chi(\mathcal{O}_D) = 0$	
$e(\eta_{\bullet}^{-1}(a, \mathbf{m})) = \frac{1}{(\mathcal{V}_{\emptyset\emptyset\emptyset})^2} \cdot Q_{\sigma}^a \Phi^{\emptyset, \emptyset}(a) \cdot \prod_{i=1}^{12} Q_3^{m_i} \Phi^{\emptyset, \emptyset}(m_i)$	

Now we have:

$$\begin{aligned} e\left(\mathbb{Z}_{\geq 0} \times \text{Sym}_{Q_3}^{\bullet}(B_{\text{op}}), (\eta_{\bullet})_* 1\right) &= \frac{1}{(\mathcal{V}_{\emptyset\emptyset\emptyset})^2} \left(\sum_a Q_{\sigma}^a \Phi^{\emptyset, \emptyset}(a)\right) \left(\sum_m Q_3^m \Phi^{\emptyset, \emptyset}(m)\right)^{12} \\ &= M(p)^{24} \prod_{m>0} (1 + p^m Q_{\sigma})^m (1 + p^m Q_3)^{12m}. \end{aligned}$$

Where the last equality is from lemma 6.3.4 part 2) and lemma 6.3.2 part 1).

5.4. **Calculation for the class $\bullet\sigma + (0, 1, \bullet)$.** Recall the previously introduced notation:

- 1) $B_i = \{b_i^1, \dots, b_i^{12}\}$ is the set of the 12 points in S_i that correspond to nodes in the fibres of the projection $\pi : S_i \rightarrow \mathbb{P}^1$.
- 2) $S_i^{\circ} = S_i \setminus B_i$ is the complement of B_i in S_i
- 3) $N_i \subset S_i$ are the 12 nodal fibres of $\pi : S_i \rightarrow \mathbb{P}^1$ with the nodes removed and:
 $N_i = N_i^{\sigma} \amalg N_i^{\emptyset}$ where $N_i^{\sigma} := N_i \cap \sigma$ and $N_i^{\emptyset} := N_i \setminus \sigma$.
- 4) $\text{Sm}_i = S_i^{\circ} \setminus N_i$ is the complement of N_i in S_i° and:
 $\text{Sm}_i = \text{Sm}_i^{\sigma} \amalg \text{Sm}_i^{\emptyset}$ where $\text{Sm}_i^{\sigma} := \text{Sm}_i \cap \sigma$ and $\text{Sm}_i^{\emptyset} := \text{Sm}_i \setminus \sigma$.

Now from lemma 3.5.3 we can further decompose $\text{Chow}^{\bullet\sigma+(0,1,\bullet)}(X)$ into the four parts:

- 1) $\mathbb{Z}_{\geq 0} \times \text{Sm}_2^{\sigma} \times \text{Sym}_{Q_3}^{\bullet}(B_{\text{op}})$
- 2) $\mathbb{Z}_{\geq 0} \times \text{Sm}_2^{\emptyset} \times \text{Sym}_{Q_3}^{\bullet}(B_{\text{op}})$
- 3) $\mathbb{Z}_{\geq 0} \times N_2^{\sigma} \times \text{Sym}_{Q_3}^{\bullet}(B_{\text{op}})$
- 4) $\mathbb{Z}_{\geq 0} \times N_2^{\emptyset} \times \text{Sym}_{Q_3}^{\bullet}(B_{\text{op}})$
- 5) $\prod_{k=1}^{12} \mathbb{Z}_{\geq 0} \times \text{Sym}_{Q_3}^{\bullet}(\{b_{\text{op}}^k\}) \times \text{Sym}_{Q_3}^{\bullet}(B_{\text{op}} \setminus \{b_{\text{op}}^k\})$



Recall equation (8) from section 5.2 and the notation:

$$\text{Cyc}(C) = a\sigma + D + \sum_{i=1}^{12} m_i C_3^{(i)}.$$

Each part will be characterised by the type of D . We consider parts 1-4 separately to part 5.

5.4.1. Parts 1-4: In parts 1-4 the curve D is a fibre of the projection $\text{pr}_2 : X \rightarrow S$. The following table is the summary of results from 5.2.4 and 5.2.5 when applied to the particular D 's arising in each strata:

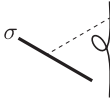
$$\mathbb{Z}_{\geq 0} \times U \times \text{Sym}_{Q_3}^{\bullet}(B_{\text{op}}).$$

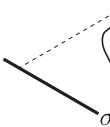
$U = \mathbb{N}_1^{\sigma}$	$e(U) = 12$	$\chi(\mathcal{O}_D) = 0$
$e(\eta_{\bullet}^{-1}(a, x, \mathbf{m})) = Q_2 Q_3 p \frac{(\mathbb{V}_{\square\square\emptyset})}{(\mathbb{V}_{\square\emptyset\emptyset})(\mathbb{V}_{\emptyset\emptyset\emptyset})^2} \cdot Q_{\sigma}^a \Phi^{-, \emptyset}(a) \cdot \prod_{i=1}^{12} Q_3^{m_i} \Phi^{\emptyset, \emptyset}(m_i)$		
$U = \mathbb{N}_1^{\emptyset}$	$e(U) = -12$	$\chi(\mathcal{O}_D) = 0$
$e(\eta_{\bullet}^{-1}(a, x, \mathbf{m})) = Q_2 Q_3 p \frac{(\mathbb{V}_{\square\square\emptyset})}{(\mathbb{V}_{\emptyset\emptyset\emptyset})^3} \cdot Q_{\sigma}^a \Phi^{\emptyset, \emptyset}(a) \cdot \prod_{i=1}^{12} Q_3^{m_i} \Phi^{\emptyset, \emptyset}(m_i)$		
$U = \text{Sm}_1^{\sigma}$	$e(U) = -10$	$\chi(\mathcal{O}_D) = 0$
$e(\eta_{\bullet}^{-1}(a, x, \mathbf{m})) = Q_2 Q_3 \frac{1}{(\mathbb{V}_{\square\emptyset\emptyset})(\mathbb{V}_{\emptyset\emptyset\emptyset})} \cdot Q_{\sigma}^a \Phi^{-, \emptyset}(a) \cdot \prod_{i=1}^{12} Q_3^{m_i} \Phi^{\emptyset, \emptyset}(m_i)$		
$U = \text{Sm}_1^{\emptyset}$	$e(U) = 10$	$\chi(\mathcal{O}_D) = 0$
$e(\eta_{\bullet}^{-1}(a, x, \mathbf{m})) = Q_2 Q_3 \frac{1}{(\mathbb{V}_{\emptyset\emptyset\emptyset})^2} \cdot Q_{\sigma}^a \Phi^{\emptyset, \emptyset}(a) \cdot \prod_{i=1}^{12} Q_3^{m_i} \Phi^{\emptyset, \emptyset}(m_i)$		

The union of parts 1-4 is $\mathbb{Z}_{\geq 0} \times S_2^{\circ} \times \text{Sym}_{Q_3}^{\bullet}(B_{\text{op}})$ so we have:

$$\begin{aligned} & e\left(\mathbb{Z}_{\geq 0} \times S_2^{\circ} \times \text{Sym}_{Q_3}^{\bullet}(B_{\text{op}}), (\eta_{\bullet})_* 1\right) \\ &= e\left(\mathbb{Z}_{\geq 0} \times \text{Sm}_2^{\sigma} \times \text{Sym}_{Q_3}^{\bullet}(B_{\text{op}}), (\eta_{\bullet})_* 1\right) \\ &+ e\left(\mathbb{Z}_{\geq 0} \times \text{Sm}_2^{\emptyset} \times \text{Sym}_{Q_3}^{\bullet}(B_{\text{op}}), (\eta_{\bullet})_* 1\right) \\ &+ e\left(\mathbb{Z}_{\geq 0} \times \mathbb{N}_2^{\sigma} \times \text{Sym}_{Q_3}^{\bullet}(B_{\text{op}}), (\eta_{\bullet})_* 1\right) \\ &+ e\left(\mathbb{Z}_{\geq 0} \times \mathbb{N}_2^{\emptyset} \times \text{Sym}_{Q_3}^{\bullet}(B_{\text{op}}), (\eta_{\bullet})_* 1\right) \end{aligned}$$

Which becomes:

$$\begin{aligned}
 & e\left(\mathbb{Z}_{\geq 0} \times S_2^\circ \times \text{Sym}_{Q_3}^\bullet(B_{\text{op}}), (\eta_\bullet)_* 1\right) \\
 &= e(\text{Sm}_2^\sigma) Q_2 Q_3 p \frac{(\mathbb{V}_{\square\square\emptyset})}{(\mathbb{V}_{\square\emptyset\emptyset})(\mathbb{V}_{\emptyset\emptyset\emptyset})^2} \left(\sum_a Q_\sigma^a \Phi^{-,\emptyset}(a)\right) \left(\sum_m Q_3^m \Phi^{\emptyset,\emptyset}(m)\right)^{12} \\
 &+ e(\text{Sm}_2^\emptyset) Q_2 Q_3 p \frac{(\mathbb{V}_{\square\square\emptyset})}{(\mathbb{V}_{\emptyset\emptyset\emptyset})^3} \left(\sum_{a \geq 0} Q_\sigma^a \Phi^{\emptyset,\emptyset}(a)\right) \left(\sum_{m \geq 0} Q_3^m \Phi^{\emptyset,\emptyset}(m)\right)^{12} \\
 &+ e(\mathbb{N}_2^\sigma) Q_2 Q_3 \frac{1}{(\mathbb{V}_{\square\emptyset\emptyset})(\mathbb{V}_{\emptyset\emptyset\emptyset})} \left(\sum_{a \geq 0} Q_\sigma^a \Phi^{-,\emptyset}(a)\right) \left(\sum_{m \geq 0} Q_3^m \Phi^{\emptyset,\emptyset}(m)\right)^{12} \\
 &+ e(\mathbb{N}_2^\emptyset) Q_2 Q_3 \frac{1}{(\mathbb{V}_{\emptyset\emptyset\emptyset})^2} \left(\sum_{a \geq 0} Q_\sigma^a \Phi^{\emptyset,\emptyset}(a)\right) \left(\sum_{m \geq 0} Q_3^m \Phi^{\emptyset,\emptyset}(m)\right)^{12}
 \end{aligned}$$

From lemmas 6.3.2, 6.3.4 and 6.3.5 we have:

- 1) $\mathbb{V}_{\emptyset\emptyset\emptyset} = M(p)$
- 2) $\mathbb{V}_{\square\emptyset\emptyset} = M(p) \frac{1}{1-p}$
- 3) $\mathbb{V}_{\square\square\emptyset} = M(p) \frac{p^2-p+1}{p(1-p)^2}$
- 4) $\sum_{m \geq 0} Q^m \Phi^{\emptyset,\emptyset}(m) = M(p)^2 \prod_{m > 0} (1 + p^m Q)^m$
- 5) $\sum_{m \geq 0} Q^m \Phi^{-,\emptyset}(m) = M(p)^2 \frac{1+Q}{1-p} \prod_{m > 0} (1 + p^m Q)^m$

So we have:

$$\begin{aligned}
 & e\left(\mathbb{Z}_{\geq 0} \times S_2^\circ \times \text{Sym}_{Q_3}^\bullet(B_{\text{op}}), (\eta_\bullet)_* 1\right) \\
 &= Q_\sigma Q_2 Q_3 M(p)^{24} \left(\prod_{m > 0} (1 + p^m Q_\sigma)^m (1 + p^m Q_3)^{12m}\right) \left(2 + 12 \frac{p}{(1-p)^2}\right) \\
 &= Q_\sigma Q_2 Q_3 M(p)^{24} \left(\prod_{m > 0} (1 + p^m Q_\sigma)^m (1 + p^m Q_3)^{12m}\right) (2\psi_1 + 12\psi_0)
 \end{aligned}$$

5.4.2. Part 5: We have 12 separate isomorphic strata:

$$\mathbb{Z}_{\geq 0} \times \text{Sym}_{Q_3}^\bullet(\{b_{\text{op}}^k\}) \times \text{Sym}_{Q_3}^\bullet(B_{\text{op}} \setminus \{b_{\text{op}}^k\}).$$

These parameterise when $D = C_2^{(k)}$. The following is the summary of results from 5.2.4 and 5.2.5.

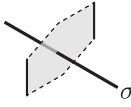
$U = \{k\}$	$e(U) = 1$	$\chi(\mathcal{O}_D) = 1$
$e(\eta_\bullet^{-1}(a, m_k, \mathbf{m})) = Q_2 p \frac{1}{(\mathbb{V}_{\emptyset\emptyset\emptyset})^2} \cdot Q_\sigma^a \Phi^{\emptyset,\emptyset}(a) \cdot Q_3^{m_k} \Phi^{-,-}(m_k) \prod_{\substack{i=1 \\ i \neq k}}^{12} Q_3^{m_i} \Phi^{\emptyset,\emptyset}(m_i)$		

From lemmas 6.3.2 and 6.3.4 we have:

- (1) $V_{\emptyset\emptyset\emptyset} = M(p)$
- (2) $\sum_{m \geq 0} Q^m \Phi^{\emptyset, \emptyset}(m) = M(p)^2 \prod_{m > 0} (1 + p^m Q)^m$
- (3) $\sum_{m \geq 0} Q^m \Phi^{-, -}(m) = M(p)^2 (\psi_0 + (\psi_1 + 2\psi_0)Q + \psi_0 Q^2) \prod_{m > 0} (1 + p^m Q)^m$

Since the strata are isomorphic we have:

$$\begin{aligned}
& e\left(\prod_{k=1}^{12} \mathbb{Z}_{\geq 0} \times \text{Sym}_{Q_3}^{\bullet}(\{b_{\text{op}}^k\}) \times \text{Sym}_{Q_3}^{\bullet}(B_{\text{op}} \setminus \{b_{\text{op}}^k\}), (\eta_{\bullet})_* 1\right) \\
&= 12 e\left(\mathbb{Z}_{\geq 0} \times \text{Sym}_{Q_3}^{\bullet}(\{b_{\text{op}}^k\}) \times \text{Sym}_{Q_3}^{\bullet}(B_{\text{op}} \setminus \{b_{\text{op}}^k\}), (\eta_{\bullet})_* 1\right) \\
&= 12 Q_2 \frac{1}{(V_{\emptyset\emptyset\emptyset})^2} \left(\sum_{a \geq 0} Q_{\sigma}^a \Phi^{\emptyset, \emptyset}(a)\right) \left(\sum_{m \geq 0} Q_3^m \Phi^{-, -}(m)\right) \left(\sum_{m \geq 0} Q_3^m \Phi^{\emptyset, \emptyset}(m)\right)^{11} \\
&= 12 Q_2 M(p)^{24} \left(\prod_{m > 0} (1 + p^m Q_{\sigma})^m (1 + p^m Q_3)^{12m}\right) (\psi_0 + (\psi_1 + 2\psi_0)Q_3 + \psi_0 Q_3^2)
\end{aligned}$$

5.4.3. Thus combining parts 1-5 we have that the overall formula is:

$$\begin{aligned}
& e\left(\text{Chow}^{\bullet\sigma + (0,1,\bullet)}(X), (\eta_{\bullet})_* 1\right) \\
&= Q_2 M(p)^{24} \left(\prod_{m > 0} (1 + p^m Q_{\sigma})^m (1 + p^m Q_3)^{12m}\right) \\
&\quad \cdot \left(12(\psi_0 + (2\psi_0 + \psi_1)Q_3 + \psi_0 Q_3^2) + Q_{\sigma} Q_3 (12\psi_0 + 2\psi_1)\right)
\end{aligned}$$

5.5. Calculation for the class $\bullet\sigma + (1,1,\bullet)$. We have a decomposition from lemma 3.5.3 of $\text{Chow}^{(1,1,\bullet)}(X)$ into the parts:

- a) $S_1^{\circ} \times S_2^{\circ} \times \text{Sym}_{Q_3}^{\bullet}(B_{\text{op}})$
- b) $\prod_{k=1}^{12} S_1^{\circ} \times \text{Sym}_{Q_3}^{\bullet}(\{b_{\text{op}}^k\}) \times \text{Sym}_{Q_3}^{\bullet}(B_{\text{op}} \setminus \{b_{\text{op}}^k\})$
- c) $\prod_{k=1}^{12} S_2^{\circ} \times \text{Sym}_{Q_3}^{\bullet}(\{b_{\text{op}}^k\}) \times \text{Sym}_{Q_3}^{\bullet}(B_{\text{op}} \setminus \{b_{\text{op}}^k\})$
- d) $\prod_{\substack{k,l=1 \\ k \neq l}}^{12} \text{Sym}_{Q_3}^{\bullet}(\{b_{\text{op}}^k\}) \times \text{Sym}_{Q_3}^{\bullet}(\{b_{\text{op}}^l\}) \times \text{Sym}_{Q_3}^{\bullet}(B_{\text{op}} \setminus \{b_{\text{op}}^k, b_{\text{op}}^l\})$
- e) $\prod_{k=1}^{12} \text{Sym}_{Q_3}^{\bullet}(\{b_{\text{op}}^k\}) \times \text{Sym}_{Q_3}^{\bullet}(B_{\text{op}} \setminus \{b_{\text{op}}^k\})$
- f) $\amalg \text{Diag}^{\bullet}$

We also recall the notation from equation (8) from section 5.2 and the notation:

$$\text{Cyc}(C) = a\sigma + D + \sum_{i=1}^{12} m_i C_3^{(i)}.$$

Each part will be characterised by the type of D . We will consider each case a-f separately and will use the following the previously introduced notation throughout:

- 1) $B_i = \{b_i^1, \dots, b_i^{12}\}$ is the set of the 12 points in S_i that correspond to nodes in the fibres of the projection $\pi : S_i \rightarrow \mathbb{P}^1$.
- 2) $S_i^{\circ} = S_i \setminus B_i$ is the complement of B_i in S_i

- 3) $N_i \subset S_i$ are the 12 nodal fibres of $\pi : S_i \rightarrow \mathbb{P}^1$ with the nodes removed and:
 $N_i = N_i^\sigma \amalg N_i^\emptyset$ where $N_i^\sigma := N_i \cap \sigma$ and $N_i^\emptyset := N_i \setminus \sigma$.
- 4) $\text{Sm}_i = S_i^\circ \setminus N_i$ is the complement of N_i in S_i° and:
 $\text{Sm}_i = \text{Sm}_i^\sigma \amalg \text{Sm}_i^\emptyset$ where $\text{Sm}_i^\sigma := \text{Sm}_i \cap \sigma$ and $\text{Sm}_i^\emptyset := \text{Sm}_i \setminus \sigma$.

We will also use the new notation:

$$D := \{(x, x) \in S_1^\circ \times S_1^\circ\}.$$

5.5.1. Part a: We have the following stratification of $S_1^\circ \times S_1^\circ$:

- 1) $((N_1^\sigma \times N_2^\sigma) \cap D \amalg (\text{Sm}_1^\sigma \times \text{Sm}_2^\sigma) \cap D)$
- 2) $\amalg ((N_1^\sigma \times N_2^\sigma \setminus D) \amalg (N_1^\sigma \times \text{Sm}_2^\sigma) \amalg (\text{Sm}_1^\sigma \times N_2^\sigma) \amalg (\text{Sm}_1^\sigma \times \text{Sm}_2^\sigma \setminus D))$
- 3) $\amalg ((N_1^\sigma \times N_2^\emptyset \setminus D) \amalg ((N_1^\sigma \times N_2^\emptyset) \cap D) \amalg (N_1^\sigma \times \text{Sm}_2^\emptyset) \amalg (\text{Sm}_1^\sigma \times N_2^\emptyset) \amalg (\text{Sm}_1^\sigma \times \text{Sm}_2^\emptyset \setminus D) \amalg ((\text{Sm}_1^\emptyset \times \text{Sm}_2^\sigma) \cap D))$
- 4) $\amalg ((N_1^\emptyset \times N_2^\sigma \setminus D) \amalg ((N_1^\emptyset \times N_2^\sigma) \cap D) \amalg (N_1^\emptyset \times \text{Sm}_2^\sigma) \amalg (\text{Sm}_1^\emptyset \times N_2^\sigma) \amalg (\text{Sm}_1^\emptyset \times \text{Sm}_2^\sigma \setminus D) \amalg ((\text{Sm}_1^\sigma \times \text{Sm}_2^\emptyset) \cap D))$
- 5) $\amalg ((N_1^\emptyset \times N_2^\emptyset \setminus D) \amalg ((N_1^\emptyset \times N_2^\emptyset) \cap D) \amalg (\text{Sm}_1^\emptyset \times N_2^\emptyset) \amalg (N_1^\emptyset \times \text{Sm}_2^\emptyset) \amalg (\text{Sm}_1^\emptyset \times \text{Sm}_2^\emptyset \setminus D) \amalg ((\text{Sm}_1^\emptyset \times \text{Sm}_2^\emptyset) \cap D))$

Here we have grouped by the number and type of intersection with σ .

Grouping 1: The following table is the summary of results from 5.2.4 and 5.2.5 for the strata in grouping 1:

$$\mathbb{Z}_{\geq 0} \times U \times \text{Sym}_{Q_3}^\bullet(B_{\text{op}}).$$

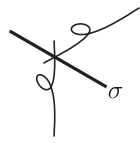
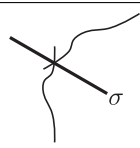
$U = (N_1^\sigma \times N_2^\sigma) \cap D$	$e(U) = 12$	$\chi(\mathcal{O}_D) = -1$
$e(\eta_{\bullet}^{-1}(a, x, \mathbf{m})) = Q_1 Q_2 Q_3^2 p \frac{(\mathbb{V}_{\square\square\emptyset})^2}{(\mathbb{V}_{\square\emptyset\emptyset})^2 (\mathbb{V}_{\emptyset\emptyset\emptyset})^2} \cdot Q_\sigma^a \Phi^{+, \emptyset}(a) \cdot \prod_{i=1}^{12} Q_3^{m_i} \Phi^{\emptyset, \emptyset}(m_i)$		
$U = (\text{Sm}_1^\sigma \times \text{Sm}_2^\sigma) \cap D$	$e(U) = -10$	$\chi(\mathcal{O}_D) = -1$
$e(\eta_{\bullet}^{-1}(a, x, \mathbf{m})) = Q_1 Q_2 Q_3^2 p^{-1} \frac{1}{(\mathbb{V}_{\square\emptyset\emptyset})^2} \cdot Q_\sigma^a \Phi^{+, \emptyset}(a) \cdot \prod_{i=1}^{12} Q_3^{m_i} \Phi^{\emptyset, \emptyset}(m_i)$		

From lemmas 6.3.2 and 6.3.4 we have:

- 1) $\mathbb{V}_{\emptyset\emptyset\emptyset} = M(p)$
- 2) $\mathbb{V}_{\square\emptyset\emptyset} = M(p) \frac{1}{1-p}$
- 3) $\mathbb{V}_{\square\square\emptyset} = M(p) \frac{p^2 - p + 1}{p(1-p)^2}$
- 4) $\sum_{m \geq 0} Q^m \Phi^{\emptyset, \emptyset}(m) = M(p)^2 \prod_{m > 0} (1 + p^m Q)^m$
- 5) $\sum_{m \geq 0} Q^m \Phi^{+, \emptyset}(m) = M(p)^2 (1 + \psi_0 + (\psi_1 + 2\psi_0)Q + \psi_0 Q^2) \prod_{m > 0} (1 + p^m Q)^m$.

So the contribution is:

$$Q_1 Q_2 Q_3^2 M(p)^{24} \left(\prod_{m>0} (1 + p^m Q_\sigma)^m (1 + p^m Q_3)^{12m} \right) (\psi_0 + (\psi_1 + 2\psi_0)Q_\sigma + \psi_0 Q_\sigma^2) \cdot \left(\frac{2(p^4 + 8p^3 - 12p^2 + 8p + 1)}{(p-1)^2 p} \right)$$

Grouping 2: The following table is the summary of results from 5.2.4 and 5.2.5 for the strata in grouping 2:

$$\mathbb{Z}_{\geq 0} \times U \times \text{Sym}_{Q_3}^\bullet(B_{\text{op}}).$$

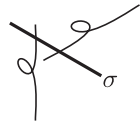
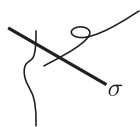
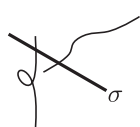
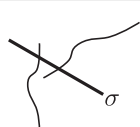
$U = \mathbb{N}_1^\sigma \times \mathbb{N}_2^\sigma \setminus \mathbb{D}$	$e(U) = 132$	$\chi(\mathcal{O}_D) = 0$
$e(\eta_\bullet^{-1}(a, x, \mathbf{m})) = Q_1 Q_2 Q_3^2 p^2 \frac{(\mathbb{V}_{\square\square\emptyset})^2}{(\mathbb{V}_{\square\emptyset\emptyset})^2 (\mathbb{V}_{\emptyset\emptyset\emptyset})^2} \cdot Q_\sigma^a \Phi^{-,-}(a) \cdot \prod_{i=1}^{12} Q_3^{m_i} \Phi^{\emptyset,\emptyset}(m_i)$		
$U = \mathbb{N}_1^\sigma \times \text{Sm}_2^\sigma$	$e(U) = -120$	$\chi(\mathcal{O}_D) = 0$
$e(\eta_\bullet^{-1}(a, x, \mathbf{m})) = Q_1 Q_2 Q_3^2 p \frac{(\mathbb{V}_{\square\square\emptyset})}{(\mathbb{V}_{\square\emptyset\emptyset})^2 (\mathbb{V}_{\emptyset\emptyset\emptyset})} \cdot Q_\sigma^a \Phi^{-,-}(a) \cdot \prod_{i=1}^{12} Q_3^{m_i} \Phi^{\emptyset,\emptyset}(m_i)$		
$U = \text{Sm}_1^\sigma \times \mathbb{N}_2^\sigma$	$e(U) = -120$	$\chi(\mathcal{O}_D) = 0$
$e(\eta_\bullet^{-1}(a, x, \mathbf{m})) = Q_1 Q_2 Q_3^2 p \frac{(\mathbb{V}_{\square\square\emptyset})}{(\mathbb{V}_{\square\emptyset\emptyset})^2 (\mathbb{V}_{\emptyset\emptyset\emptyset})} \cdot Q_\sigma^a \Phi^{-,-}(a) \cdot \prod_{i=1}^{12} Q_3^{m_i} \Phi^{\emptyset,\emptyset}(m_i)$		
$U = \text{Sm}_1^\sigma \times \text{Sm}_2^\sigma \setminus \mathbb{D}$	$e(U) = 110$	$\chi(\mathcal{O}_D) = 0$
$e(\eta_\bullet^{-1}(a, x, \mathbf{m})) = Q_1 Q_2 Q_3^2 \frac{1}{(\mathbb{V}_{\square\emptyset\emptyset})^2} \cdot Q_\sigma^a \Phi^{-,-}(a) \cdot \prod_{i=1}^{12} Q_3^{m_i} \Phi^{\emptyset,\emptyset}(m_i)$		

From lemmas 6.3.2 and 6.3.4 we have:

- 1) $\mathbb{V}_{\emptyset\emptyset\emptyset} = M(p)$
- 2) $\mathbb{V}_{\square\emptyset\emptyset} = M(p) \frac{1}{1-p}$
- 3) $\mathbb{V}_{\square\square\emptyset} = M(p) \frac{p^2 - p + 1}{p(1-p)^2}$
- 4) $\sum_{m \geq 0} Q^m \Phi^{\emptyset,\emptyset}(m) = M(p)^2 \prod_{m>0} (1 + p^m Q)^m$
- 5) $\sum_{m \geq 0} Q^m \Phi^{-,-}(m) = M(p)^2 \frac{1}{p} (\psi_0 + (\psi_1 + 2\psi_0)Q + \psi_0 Q^2) \prod_{m>0} (1 + p^m Q)^m.$

So the contribution is:

$$Q_1 Q_2 Q_3^2 M(p)^{24} \left(\prod_{m>0} (1 + p^m Q_\sigma)^m (1 + p^m Q_3)^{12m} \right) \frac{1}{p} (\psi_0 + (\psi_1 + 2\psi_0)Q + \psi_0 Q^2) \cdot \left(\frac{2(p^4 + 8p^3 + 48p^2 + 8p + 1)}{(p-1)^2} \right)$$

Grouping 3: The following table is the summary of results from 5.2.4 and 5.2.5 for the strata in grouping 3:

$$\mathbb{Z}_{\geq 0} \times U \times \text{Sym}_{Q_3}^\bullet(B_{\text{op}}).$$

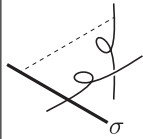
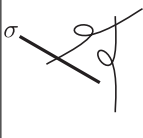
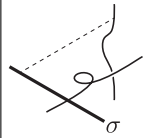
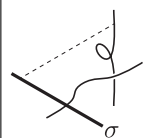
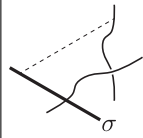
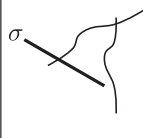
$U = \mathbb{N}_1^\sigma \times \mathbb{N}_2^\emptyset \setminus \mathbb{D}$	$e(U) = -132$	$\chi(\mathcal{O}_D) = 0$
$e(\eta_{\bullet}^{-1}(a, x, \mathbf{m})) = Q_1 Q_2 Q_3^2 p^2 \frac{(\mathbb{V}_{\square\square\emptyset})^2}{(\mathbb{V}_{\square\emptyset\emptyset})(\mathbb{V}_{\emptyset\emptyset\emptyset})^3} \cdot Q_\sigma^a \Phi^{-, \emptyset}(a) \cdot \prod_{i=1}^{12} Q_3^{m_i} \Phi^{\emptyset, \emptyset}(m_i)$		
$U = (\mathbb{N}_1^\sigma \times \mathbb{N}_2^\emptyset) \cap \mathbb{D}$	$e(U) = -12$	$\chi(\mathcal{O}_D) = -1$
$e(\eta_{\bullet}^{-1}(a, x, \mathbf{m})) = Q_1 Q_2 Q_3^2 p^2 \frac{(\mathbb{V}_{\square\square\emptyset})^3}{(\mathbb{V}_{\square\emptyset\emptyset})^3 (\mathbb{V}_{\emptyset\emptyset\emptyset})^2} \cdot Q_\sigma^a \Phi^{-, \emptyset}(a) \cdot \prod_{i=1}^{12} Q_3^{m_i} \Phi^{\emptyset, \emptyset}(m_i)$		
$U = \mathbb{N}_1^\sigma \times \text{Sm}_2^\emptyset$	$e(U) = 120$	$\chi(\mathcal{O}_D) = 0$
$e(\eta_{\bullet}^{-1}(a, x, \mathbf{m})) = Q_1 Q_2 Q_3^2 p \frac{(\mathbb{V}_{\square\square\emptyset})}{(\mathbb{V}_{\square\emptyset\emptyset})(\mathbb{V}_{\emptyset\emptyset\emptyset})^2} \cdot Q_\sigma^a \Phi^{-, \emptyset}(a) \cdot \prod_{i=1}^{12} Q_3^{m_i} \Phi^{\emptyset, \emptyset}(m_i)$		
$U = \text{Sm}_1^\sigma \times \mathbb{N}_2^\emptyset$	$e(U) = 120$	$\chi(\mathcal{O}_D) = 0$
$e(\eta_{\bullet}^{-1}(a, x, \mathbf{m})) = Q_1 Q_2 Q_3^2 p \frac{(\mathbb{V}_{\square\square\emptyset})}{(\mathbb{V}_{\square\emptyset\emptyset})(\mathbb{V}_{\emptyset\emptyset\emptyset})^2} \cdot Q_\sigma^a \Phi^{-, \emptyset}(a) \cdot \prod_{i=1}^{12} Q_3^{m_i} \Phi^{\emptyset, \emptyset}(m_i)$		
$U = \text{Sm}_1^\sigma \times \text{Sm}_2^\emptyset \setminus \mathbb{D}$	$e(U) = -110$	$\chi(\mathcal{O}_D) = 0$
$e(\eta_{\bullet}^{-1}(a, x, \mathbf{m})) = Q_1 Q_2 Q_3^2 \frac{1}{(\mathbb{V}_{\square\emptyset\emptyset})(\mathbb{V}_{\emptyset\emptyset\emptyset})} \cdot Q_\sigma^a \Phi^{-, \emptyset}(a) \cdot \prod_{i=1}^{12} Q_3^{m_i} \Phi^{\emptyset, \emptyset}(m_i)$		
$U = (\text{Sm}_1^\emptyset \times \text{Sm}_2^\sigma) \cap \mathbb{D}$	$e(U) = 10$	$\chi(\mathcal{O}_D) = -1$
$e(\eta_{\bullet}^{-1}(a, x, \mathbf{m})) = Q_1 Q_2 Q_3^2 \frac{(\mathbb{V}_{\square\square\emptyset})}{(\mathbb{V}_{\square\emptyset\emptyset})^3} \cdot Q_\sigma^a \Phi^{-, \emptyset}(a) \cdot \prod_{i=1}^{12} Q_3^{m_i} \Phi^{\emptyset, \emptyset}(m_i)$		

From lemmas 6.3.2, 6.3.4 and 6.3.5 we have:

- 1) $V_{\emptyset\emptyset\emptyset} = M(p)$
- 2) $V_{\square\emptyset\emptyset} = M(p) \frac{1}{1-p}$
- 3) $V_{\square\square\emptyset} = M(p) \frac{p^2-p+1}{p(1-p)^2}$
- 4) $\sum_{m \geq 0} Q^m \Phi^{\theta, \emptyset}(m) = M(p)^2 \prod_{m > 0} (1 + p^m Q)^m$
- 5) $\sum_{m \geq 0} Q^m \Phi^{-, \emptyset}(m) = M(p)^2 \frac{1+Q}{1-p} \prod_{m > 0} (1 + p^m Q)^m$

The contribution from grouping 3 is:

$$Q_1 Q_2 Q_3^2 M(p)^{24} \left(\prod_{m > 0} (1 + p^m Q_\sigma)^m (1 + p^m Q_3)^{12m} \right) \left(\frac{1 + Q_\sigma}{1 - p} \right) \cdot \left(\frac{2(p^2 + 10p + 1)(p^4 - 2p^3 + 8p^2 - 2p + 1)}{(p-1)^3 p} \right)$$

Grouping 4: The results for grouping 4 are identical to those of grouping 3 under the symmetry of the banana threefold.

The contribution from grouping 4 is:

$$Q_1 Q_2 Q_3^2 M(p)^{24} \left(\prod_{m > 0} (1 + p^m Q_\sigma)^m (1 + p^m Q_3)^{12m} \right) \left(\frac{1 + Q_\sigma}{1 - p} \right) \cdot \left(\frac{2(p^2 + 10p + 1)(p^4 - 2p^3 + 8p^2 - 2p + 1)}{(p-1)^3 p} \right)$$

Grouping 5: The following table is the summary of results from 5.2.4 and 5.2.5 for the strata in grouping 5:

$$\mathbb{Z}_{\geq 0} \times U \times \text{Sym}_{Q_3}^\bullet(B_{\text{op}}).$$

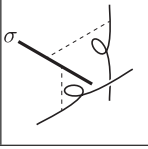
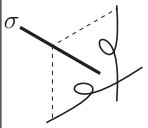
$U = \mathbb{N}_1^\emptyset \times \mathbb{N}_2^\emptyset \setminus \mathcal{D}$	$e(U) = 132$	$\chi(\mathcal{O}_D) = 0$
$e(\eta_\bullet^{-1}(a, x, \mathbf{m})) = Q_1 Q_2 Q_3^2 p^2 \frac{V_{\square\square\emptyset}^2}{(V_{\emptyset\emptyset\emptyset})^4} \cdot Q_\sigma^a \Psi^{\theta, \emptyset}(a) \cdot \prod_{i=1}^{12} Q_3^{m_i} \Phi^{\theta, \emptyset}(m_i)$		
$U = (\mathbb{N}_1^\emptyset \times \mathbb{N}_2^\emptyset) \cap \mathcal{D}$	$e(U) = 12$	$\chi(\mathcal{O}_D) = -1$
$e(\eta_\bullet^{-1}(a, x, \mathbf{m})) = Q_1 Q_2 Q_3^2 p^2 \frac{(V_{\square\square\emptyset})^3}{(V_{\square\emptyset\emptyset})^2 (V_{\emptyset\emptyset\emptyset})^3} \cdot Q_\sigma^a \Psi^{\theta, \emptyset}(a) \cdot \prod_{i=1}^{12} Q_3^{m_i} \Phi^{\theta, \emptyset}(m_i)$		

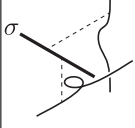
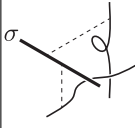
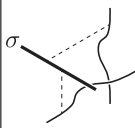
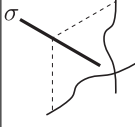
$U = \mathbf{Sm}_1^\emptyset \times \mathbf{N}_2^\emptyset$	$e(U) = -120$	$\chi(\mathcal{O}_D) = 0$	
$e(\eta_{\bullet}^{-1}(a, x, \mathbf{m})) = Q_1 Q_2 Q_3^2 p \frac{(\mathbf{V}_{\square\square\emptyset})}{(\mathbf{V}_{\emptyset\emptyset\emptyset})^3} \cdot Q_\sigma^a \Psi^{\emptyset, \emptyset}(a) \cdot \prod_{i=1}^{12} Q_3^{m_i} \Phi^{\emptyset, \emptyset}(m_i)$			
$U = \mathbf{N}_1^\emptyset \times \mathbf{Sm}_2^\emptyset$	$e(U) = -120$	$\chi(\mathcal{O}_D) = 0$	
$e(\eta_{\bullet}^{-1}(a, x, \mathbf{m})) = Q_1 Q_2 Q_3^2 p \frac{(\mathbf{V}_{\square\square\emptyset})}{(\mathbf{V}_{\emptyset\emptyset\emptyset})^3} \cdot Q_\sigma^a \Psi^{\emptyset, \emptyset}(a) \cdot \prod_{i=1}^{12} Q_3^{m_i} \Phi^{\emptyset, \emptyset}(m_i)$			
$U = \mathbf{Sm}_1^\emptyset \times \mathbf{Sm}_2^\emptyset \setminus \mathbf{D}$	$e(U) = 110$	$\chi(\mathcal{O}_D) = 0$	
$e(\eta_{\bullet}^{-1}(a, x, \mathbf{m})) = Q_1 Q_2 Q_3^2 \frac{1}{(\mathbf{V}_{\emptyset\emptyset\emptyset})^2} \cdot Q_\sigma^a \Psi^{\emptyset, \emptyset}(a) \cdot \prod_{i=1}^{12} Q_3^{m_i} \Phi^{\emptyset, \emptyset}(m_i)$			
$U = (\mathbf{Sm}_1^\emptyset \times \mathbf{Sm}_2^\emptyset) \cap \mathbf{D}$	$e(U) = -10$	$\chi(\mathcal{O}_D) = -1$	
$e(\eta_{\bullet}^{-1}(a, x, \mathbf{m})) = Q_1 Q_2 Q_3^2 \frac{(\mathbf{V}_{\square\square\emptyset})}{(\mathbf{V}_{\square\emptyset\emptyset})^2 (\mathbf{V}_{\emptyset\emptyset\emptyset})} \cdot Q_\sigma^a \Psi^{\emptyset, \emptyset}(a) \cdot \prod_{i=1}^{12} Q_3^{m_i} \Phi^{\emptyset, \emptyset}(m_i)$			

From lemmas 6.3.2 and 6.3.4 we have:

- 1) $\mathbf{V}_{\emptyset\emptyset\emptyset} = M(p)$
- 2) $\mathbf{V}_{\square\emptyset\emptyset} = M(p) \frac{1}{1-p}$
- 3) $\mathbf{V}_{\square\square\emptyset} = M(p) \frac{p^2 - p + 1}{p(1-p)^2}$
- 4) $\sum_{m \geq 0} Q^m \Phi^{\emptyset, \emptyset}(m) = M(p)^2 \prod_{m > 0} (1 + p^m Q)^m$

Summing the contributions from the above groupings we arrive at the overall contribution from part a:

$$\begin{aligned}
 & e\left(\mathbb{Z}_{\geq 0} \times S_1^\circ \times S_2^\circ \times \text{Sym}_{Q_3}^\bullet(B_{\text{op}}), (\eta_\bullet)_* 1\right) \\
 &= Q_1 Q_2 Q_3^2 M(p)^{24} \left(\prod_{m > 0} (1 + p^m Q_\sigma)^m (1 + p^m Q_3)^{12m} \right) \\
 & \quad \cdot \left(\frac{2(p^2 + 10p + 1)(p^4 - 2p^3 + 8p^2 - 2p + 1)}{(p-1)^4 p} \right) \\
 &= Q_1 Q_2 Q_3^2 Q_\sigma M(p)^{24} \left(\prod_{m > 0} (1 + p^m Q_\sigma)^m (1 + p^m Q_3)^{12m} \right) \\
 & \quad \cdot (120\psi_0 + Q_\sigma (144\psi_0^2 + 48\psi_0 + 4))
 \end{aligned}$$

5.5.2. Part b-c: By the symmetry of X we only need to consider part b, with part c being completely analogous. For each $k \in \{1, \dots, 12\}$ we begin by decomposing S_1° into the following six parts:

$$\text{Sm}_1^\sigma \amalg \text{Sm}_1^\emptyset \amalg \text{N}_1^{\sigma, (k)} \amalg \text{N}_1^{\sigma, c} \amalg \text{N}_1^{\emptyset, (k)} \amalg \text{N}_1^{\emptyset, c}$$

where $\text{N}_1^{\sigma, (k)}$ is the connected component of N_1^σ corresponding to the k th banana configuration and $\text{N}_1^{\sigma, c}$ is its complement in N_1^σ . The same definition is true for N_1^\emptyset . We use the above six-part decomposition for

$$\mathbb{Z}_{\geq 0} \times S_1^\circ \times \text{Sym}_{Q_3}^\bullet(\{b_{\text{op}}^k\}) \times \text{Sym}_{Q_3}^\bullet(B_{\text{op}} \setminus \{b_{\text{op}}^k\}).$$

The following is the summary of results from 5.2.4 and 5.2.5 for this stratification.

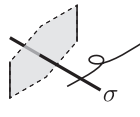
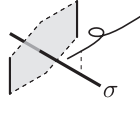
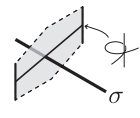
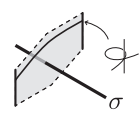
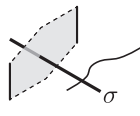
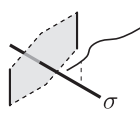
$U = \text{N}_1^{\sigma, c}$	$e(U) = 11$	$\chi(\mathcal{O}_D) = 1$
$e(\eta_\bullet^{-1}(a, x, n, \mathbf{m})) = Q_1 Q_2 Q_3 p^2 \frac{(\mathbb{V}_{\square\square\square})}{(\mathbb{V}_{\square\emptyset\emptyset})(\mathbb{V}_{\emptyset\emptyset\emptyset})^2} \cdot Q_\sigma^a \Phi^{-, \emptyset}(a) \cdot Q_3^n \Phi^{-, -}(n) \prod_{\substack{i=1 \\ i \neq k}}^{12} Q_3^{m_i} \Phi^{\emptyset, \emptyset}(m_i)$		
$U = \text{N}_1^{\emptyset, c}$	$e(U) = -11$	$\chi(\mathcal{O}_D) = 1$
$e(\eta_\bullet^{-1}(a, x, n, \mathbf{m})) = Q_1 Q_2 Q_3 p^2 \frac{(\mathbb{V}_{\square\square\square})}{(\mathbb{V}_{\emptyset\emptyset\emptyset})^3} \cdot Q_\sigma^a \Phi^{\emptyset, \emptyset}(a) \cdot Q_3^n \Phi^{-, -}(n) \prod_{\substack{i=1 \\ i \neq k}}^{12} Q_3^{m_i} \Phi^{\emptyset, \emptyset}(m_i)$		
$U = \text{N}_1^{\sigma, (k)}$	$e(U) = 1$	$\chi(\mathcal{O}_D) = 0$
$e(\eta_\bullet^{-1}(a, x, n, \mathbf{m})) = Q_1 Q_2 Q_3 p^2 \frac{(\mathbb{V}_{\square\square\square})}{(\mathbb{V}_{\square\emptyset\emptyset})^2 (\mathbb{V}_{\emptyset\emptyset\emptyset})} \cdot Q_\sigma^a \Phi^{-, \emptyset}(a) \cdot Q_3^n \Phi^{-, -}(n) \prod_{\substack{i=1 \\ i \neq k}}^{12} Q_3^{m_i} \Phi^{\emptyset, \emptyset}(m_i)$		
$U = \text{N}_1^{\emptyset, (k)}$	$e(U) = -1$	$\chi(\mathcal{O}_D) = 0$
$e(\eta_\bullet^{-1}(a, x, n, \mathbf{m})) = Q_1 Q_2 Q_3 p^2 \frac{(\mathbb{V}_{\square\square\square})}{(\mathbb{V}_{\square\emptyset\emptyset})(\mathbb{V}_{\emptyset\emptyset\emptyset})^2} \cdot Q_\sigma^a \Phi^{\emptyset, \emptyset}(a) \cdot Q_3^n \Phi^{-, -}(n) \prod_{\substack{i=1 \\ i \neq k}}^{12} Q_3^{m_i} \Phi^{\emptyset, \emptyset}(m_i)$		
$U = \text{Sm}_1^\sigma$	$e(U) = -10$	$\chi(\mathcal{O}_D) = 1$
$e(\eta_\bullet^{-1}(a, x, n, \mathbf{m})) = Q_1 Q_2 Q_3 p \frac{1}{(\mathbb{V}_{\square\emptyset\emptyset})(\mathbb{V}_{\emptyset\emptyset\emptyset})} \cdot Q_\sigma^a \Phi^{-, \emptyset}(a) \cdot Q_3^n \Phi^{-, -}(n) \prod_{\substack{i=1 \\ i \neq k}}^{12} Q_3^{m_i} \Phi^{\emptyset, \emptyset}(m_i)$		
$U = \text{Sm}_1^\emptyset$	$e(U) = 10$	$\chi(\mathcal{O}_D) = 1$
$e(\eta_\bullet^{-1}(a, x, n, \mathbf{m})) = Q_1 Q_2 Q_3 p \frac{1}{(\mathbb{V}_{\emptyset\emptyset\emptyset})^2} \cdot Q_\sigma^a \Phi^{\emptyset, \emptyset}(a) \cdot Q_3^n \Phi^{-, -}(n) \prod_{\substack{i=1 \\ i \neq k}}^{12} Q_3^{m_i} \Phi^{\emptyset, \emptyset}(m_i)$		

From lemmas 6.3.2, 6.3.4 and 6.3.5 we have:

- 1) $V_{\emptyset\emptyset\emptyset} = M(p)$
- 2) $V_{\square\emptyset\emptyset} = M(p) \frac{1}{1-p}$
- 3) $V_{\square\square\emptyset} = M(p) \frac{p^2-p+1}{p(1-p)^2}$
- 4) $V_{\square\square\square} = M(p) \frac{p^4-p^3+p^2-p+1}{p^2(1-p)^3}$
- 5) $\sum_{m \geq 0} Q^m \Phi^{\emptyset, \emptyset}(m) = M(p)^2 \prod_{m > 0} (1 + p^m Q)^m$
- 6) $\sum_{m \geq 0} Q^m \Phi^{-, \emptyset}(m) = M(p)^2 \frac{1+Q}{1-p} \prod_{m > 0} (1 + p^m Q)^m$
- 7) $\sum_{m \geq 0} Q^m \Phi^{-, -}(m) = M(p)^2 \frac{1}{p} (\psi_0 + (\psi_1 + 2\psi_0)Q + \psi_0 Q^2) \prod_{m > 0} (1 + p^m Q)^m$.

There are 12 singular fibres of pr. So, we have that the combined contribution from parts c and d is:

$$\begin{aligned}
 & e\left(\prod_{k=1}^{12} S_1^\circ \times \text{Sym}_{Q_3}^\bullet(\{b_{\text{op}}^k\}) \times \text{Sym}_{Q_3}^\bullet(B_{\text{op}} \setminus \{b_{\text{op}}^k\}), (\eta_\bullet)_* 1\right) \\
 & + e\left(\prod_{k=1}^{12} S_2^\circ \times \text{Sym}_{Q_3}^\bullet(\{b_{\text{op}}^k\}) \times \text{Sym}_{Q_3}^\bullet(B_{\text{op}} \setminus \{b_{\text{op}}^k\}), (\eta_\bullet)_* 1\right) \\
 & = 24Q_1Q_2Q_3Q_\sigma M(p)^{24} \left(\prod_{m > 0} (1 + p^m Q_\sigma)^m (1 + p^m Q_3)^{12m} \right) \\
 & \quad \cdot (\psi_0 + (\psi_1 + 2\psi_0)Q_3 + \psi_0 Q_3^2) (12\psi_0 + 4\psi_1 + \psi_2)
 \end{aligned}$$

5.5.3. Part d-e: Parts d and e parametrise the cases when D is the union of $C_2^{(k)}$ and $C_2^{(l)}$. We have the spaces:

- 1) $\prod_{\substack{k, l = 1 \\ k \neq l}}^{12} \text{Sym}_{Q_3}^\bullet(\{b_{\text{op}}^k\}) \times \text{Sym}_{Q_3}^\bullet(\{b_{\text{op}}^l\}) \times \text{Sym}_{Q_3}^\bullet(B_{\text{op}} \setminus \{b_{\text{op}}^k, b_{\text{op}}^l\}),$
- 2) $\prod_{k=1}^{12} \text{Sym}_{Q_3}^\bullet(\{b_{\text{op}}^k\}) \times \text{Sym}_{Q_3}^\bullet(B_{\text{op}} \setminus \{b_{\text{op}}^k\}).$

The following table is the summary of results from 5.2.4 and 5.2.5 for this stratification.

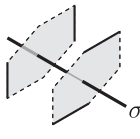
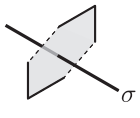
$U = \{(k, l)\}, k \neq l$	$e(U) = 1$	$\chi(\mathcal{O}_D) = 2$
$e(\eta_\bullet^{-1}(a, c, d, \mathbf{m})) =$ $Q_1Q_2p^2 \frac{1}{(v_{\emptyset\emptyset\emptyset})^2} \cdot Q_\sigma^a \Phi^{\emptyset, \emptyset}(a) \cdot Q_3^c \Phi^{-, -}(c) \cdot Q_3^d \Phi^{-, -}(d) \prod_{\substack{i=1 \\ i \neq k, l}}^{12} Q_3^{m_i} \Phi^{\emptyset, \emptyset}(m_i)$		
$U = \{(k, k)\}$	$e(U) = 1$	$\chi(\mathcal{O}_D) = 0$
$e(\eta_\bullet^{-1}(a, m_k, \mathbf{m})) =$ $Q_1Q_2 \frac{1}{(v_{\emptyset\emptyset\emptyset})^2} \cdot Q_\sigma^a \Psi^{\emptyset, \emptyset}(a) \cdot Q_3^{m_k} \Phi^{+, +}(m_k) \prod_{\substack{i=1 \\ i \neq k}}^{12} Q_3^{m_i} \Phi^{\emptyset, \emptyset}(m_i)$		

From lemmas 6.3.2, 6.3.4 and 6.3.5 we have:

$$\begin{aligned}
1) \quad & \mathbb{V}_{\emptyset\emptyset\emptyset} = M(p) \\
2) \quad & \sum_{m \geq 0} Q^m \Phi^{\emptyset, \emptyset}(m) = M(p)^2 \prod_{m > 0} (1 + p^m Q)^m \\
3) \quad & \sum_{m \geq 0} Q^m \Phi^{-, -}(m) = M(p)^2 \frac{1}{p} (\psi_0 + (\psi_1 + 2\psi_0)Q + \psi_0 Q^2) \prod_{m > 0} (1 + p^m Q)^m. \\
4) \quad & \sum_{m \geq 0} Q^m \Phi^{+, +}(m) \\
& = M(p)^2 \prod_{m > 0} (1 + p^m Q)^m \left(Q^4(2\psi_0 + \psi_1) + Q^3(8\psi_0 + 6\psi_1 + \psi_2) + Q^2(12\psi_0 \right. \\
& \quad \left. + 10\psi_1 + 2\psi_2) + Q(8\psi_0 + 6\psi_1 + \psi_2) + (2\psi_0 + \psi_1) \right)
\end{aligned}$$

There are 136 choices for two distinct fibres. Hence the contribution from part d is:

$$\begin{aligned}
& e \left(\prod_{\substack{k, l=1 \\ k \neq l}}^{12} \text{Sym}_{Q_3}^{\bullet}(\{b_{\text{op}}^k\}) \times \text{Sym}_{Q_3}^{\bullet}(\{b_{\text{op}}^l\}) \times \text{Sym}_{Q_3}^{\bullet}(B_{\text{op}} \setminus \{b_{\text{op}}^k, b_{\text{op}}^l\}), (\eta_{\bullet})_* 1 \right) \\
& = 132 Q_1 Q_2 M(p)^{24} \left(\prod_{m > 0} (1 + p^m Q_{\sigma})^m (1 + p^m Q_3)^{12m} \right) (\psi_0 + (\psi_1 + 2\psi_0)Q_3 + \psi_0 Q_3^2)^2.
\end{aligned}$$

The 12 singular fibres give the contribution of part e as:

$$\begin{aligned}
& e \left(\prod_{k=1}^{12} \text{Sym}_{Q_3}^{\bullet}(\{b_{\text{op}}^k\}) \times \text{Sym}_{Q_3}^{\bullet}(B_{\text{op}} \setminus \{b_{\text{op}}^k\}), (\eta_{\bullet})_* 1 \right) \\
& = 12 Q_1 Q_2 M(p)^{24} \left(\prod_{m > 0} (1 + p^m Q_{\sigma})^m (1 + p^m Q_3)^{12m} \right) \\
& \quad \cdot \left((Q_3^2 \psi_0 + Q_3(2\psi_0 + \psi_1) + \psi_0)^2 + (Q_3^4(2\psi_0 + \psi_1) + Q_3^3(8\psi_0 + 6\psi_1 + \psi_2) \right. \\
& \quad \left. + Q_3^2(12\psi_0 + 10\psi_1 + 2\psi_2) \right. \\
& \quad \left. + Q_3(8\psi_0 + 6\psi_1 + \psi_2) + (2\psi_0 + \psi_1) \right).
\end{aligned}$$

Summing the contributions of parts d and e we have:

$$\begin{aligned}
& Q_1 Q_2 M(p)^{24} \left(\prod_{m > 0} (1 + p^m Q_{\sigma})^m (1 + p^m Q_3)^{12m} \right) \\
& \cdot \left(144(Q_3^2 \psi_0 + Q_3(2\psi_0 + \psi_1) + \psi_0)^2 + 12(Q_3^4(2\psi_0 + \psi_1) + Q_3^3(8\psi_0 + 6\psi_1 + \psi_2) \right. \\
& \quad \left. + Q_3^2(12\psi_0 + 10\psi_1 + 2\psi_2) \right. \\
& \quad \left. + Q_3(8\psi_0 + 6\psi_1 + \psi_2) + (2\psi_0 + \psi_1) \right).
\end{aligned}$$

5.5.4. Part f: Recall from lemma 3.5.3 that part f, Diag^{\bullet} has the further decomposition:

$$\begin{aligned}
g) \quad & \mathbb{S}m_1 \times \text{Sym}_{Q_3}^{\bullet}(B_{\text{op}}) \\
h) \quad & \mathbb{I} \mathbb{S}m_2 \times \text{Sym}_{Q_3}^{\bullet}(B_{\text{op}}) \\
i) \quad & \prod_{y \in J} E_{\pi(y)} \times \widehat{\text{Aut}}(E_{\pi(y)}) \times \text{Sym}_{Q_3}^{\bullet}(B_{\text{op}}) \\
j) \quad & \prod_{k=1}^{12} L \times \text{Sym}_{Q_3}^{\bullet}(\{b_{\text{op}}^k\}) \times \text{Sym}_{Q_3}^{\bullet}(B_{\text{op}} \setminus \{b_{\text{op}}^k\}).
\end{aligned}$$

Where we have used the notation:

- 1) J^0 and J^{1728} to be the subsets of points $x \in \mathbb{P}^1$ such that $\pi^{-1}(x)$ has j -invariant 0 or 1728 respectively and $J = J^0 \amalg J^{1728}$.
- 2) L to be the linear system $|f_1 + f_2|$ on $\mathbb{P}^1 \times \mathbb{P}^1$ with the singular divisors removed where f_1 and f_2 are fibres of the two projection maps.
- 3) $\widetilde{\text{Aut}}(E) := \text{Aut}(E) \setminus \{\pm 1\}$.

5.5.5. Parts g-i:

The results for parts g-i will all be very similar. The key differences are:

- 1) The overall factor of Q_3 may be different.
- 2) The Euler characteristics of the space parametrising the D 's may be different.

We define U to be one of

- g) Sm_1 noting that $e(\text{Sm}_1 \cap \{\sigma\}) = -10$ and $e(\text{Sm}_1 \setminus \{\sigma\}) = 10$.
- h) Sm_2 noting that $e(\text{Sm}_2 \cap \{\sigma\}) = -10$ and $e(\text{Sm}_2 \setminus \{\sigma\}) = 10$.
- i) $E_{\pi(y)}$ for $y \in J$ noting that $e(E_{\pi(y)} \cap \{\sigma\}) = 1$ and $e(E_{\pi(y)} \setminus \{\sigma\}) = -1$.

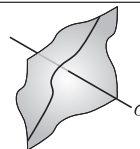
$U \cap \{\sigma\}$	$\chi(\mathcal{O}_D) = 0$	
$e(\eta_{\bullet}^{-1}(a, x, m_k, \mathbf{m})) = Q_1 Q_2 Q_3^n \frac{1}{(\mathcal{V}_{\square\emptyset\emptyset})(\mathcal{V}_{\emptyset\emptyset\emptyset})} \cdot Q_{\sigma}^a \Phi^{-, \emptyset}(a) \cdot \prod_{i=1}^{12} Q_3^{m_i} \Phi^{\emptyset, \emptyset}(m_i)$		
$U \setminus \{\sigma\}$	$\chi(\mathcal{O}_D) = 0$	
$e(\eta_{\bullet}^{-1}(a, x, m_k, \mathbf{m})) = Q_1 Q_2 Q_3^n \frac{1}{(\mathcal{V}_{\emptyset\emptyset\emptyset})^2} \cdot Q_{\sigma}^a \Phi^{\emptyset, \emptyset}(a) \cdot \prod_{i=1}^{12} Q_3^{m_i} \Phi^{\emptyset, \emptyset}(m_i)$		

From lemmas 6.3.2, 6.3.4 and 6.3.5 we have:

- 1) $\mathcal{V}_{\emptyset\emptyset\emptyset} = M(p)$
- 2) $\mathcal{V}_{\square\emptyset\emptyset} = M(p) \frac{1}{1-p}$
- 3) $\sum_{m \geq 0} Q^m \Phi^{\emptyset, \emptyset}(m) = M(p)^2 \prod_{m > 0} (1 + p^m Q)^m$
- 4) $\sum_{m \geq 0} Q^m \Phi^{-, \emptyset}(m) = M(p)^2 \frac{1+Q}{1-p} \prod_{m > 0} (1 + p^m Q)^m$

The overall factors of Q_3^n are calculated in 3.3.2 to be:

- 1) $n = 4$ for (g) and $n = 0$ for (h).
- 2) If $j(E) = 1728$ and $E \cong \mathbb{C}/i$ then
 - $n = 2$ occurs when D is a translation of the graph $\{(x, \pm ix)\}$.
- 3) If $j(E) = 0$ and $E \cong \mathbb{C}/\tau$ with $\tau = \frac{1}{2}(1 + i\sqrt{3})$ then
 - $n = 1$ occurs when D is a translation of the graph $\{(x, -\tau x)\}$ or the graph $\{(x, (\tau - 1)x)\}$.
 - $n = 3$ occurs when D is a translation of the graph $\{(x, \tau x)\}$ or the graph $\{(x, (-\tau + 1)x)\}$.

Lastly, in a generic pencil we have $e(J^0) = 4$ and $e(J^{1728}) = 6$.

Hence the contribution for parts g-i is:

$$Q_1 Q_2 Q_\sigma M(p)^{24} \left(\prod_{m>0} (1 + p^m Q_\sigma)^m (1 + p^m Q_3)^{12m} \right) (-10 + 8Q_3 + 12Q_3^2 + 8Q_3^3 - 10Q_3^4).$$

5.5.6. Part j:

In the appendix 6.2.2 we give the following decomposition for L into groupings:

- 1) $L_{(0,0),(\infty,\infty)}^\sigma \amalg L_{(0,0),(\infty,\infty)}^\emptyset \amalg L_{(0,\infty),(\infty,0)}^\sigma \amalg L_{(0,\infty),(\infty,0)}^\emptyset$
- 2) $\amalg L_{(0,0)}^\sigma \amalg L_{(0,0)}^\emptyset \amalg L_{(\infty,\infty)}^\sigma \amalg L_{(\infty,\infty)}^\emptyset$
- 3) $\amalg L_{(0,\infty)}^\sigma \amalg L_{(0,\infty)}^\emptyset \amalg L_{(\infty,0)}^\sigma \amalg L_{(\infty,0)}^\emptyset$
- 4) $\amalg L_\emptyset^\sigma \amalg L_\emptyset^\emptyset$.

The Euler characteristics of the parts of this decomposition are computed in 6.2.3 and the overall factors of Q_1 , Q_2 and Q_3 are calculated in lemma 3.4.4.

Grouping 1: The following table is the summary of results from 5.2.4 and 5.2.5 for the strata in grouping 1:

$$\mathbb{Z}_{\geq 0} \times U \times \text{Sym}_{Q_3}^\bullet(\{b_{\text{op}}^k\}) \times \text{Sym}_{Q_3}^\bullet(B_{\text{op}} \setminus \{b_{\text{op}}^k\}).$$

Note that the vertex is different for $L_{(0,0),(\infty,\infty)}$ as described in 4.4.8.

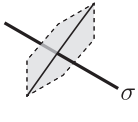
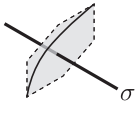
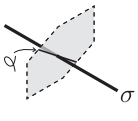
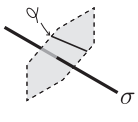
$U = L_{(0,0),(\infty,\infty)}^\sigma$	$e(U) = 1$	$\chi(\mathcal{O}_D) = 1$
$e(\eta_\bullet^{-1}(a, x, m_k, \mathbf{m})) = Q_1 Q_2 Q_3^2 p \frac{1}{(\sqrt{v_{\emptyset\emptyset}})(\sqrt{v_{\emptyset\emptyset}})} Q_\sigma^a \Phi^{-,\emptyset}(a) Q_3^{m_k} \Phi^{-, }(m_k) \prod_{\substack{i=1 \\ i \neq k}}^{12} Q_3^{m_i} \Phi^{\emptyset,\emptyset}(m_i)$		
$U = L_{(0,0),(\infty,\infty)}^\emptyset$	$e(U) = -1$	$\chi(\mathcal{O}_D) = 1$
$e(\eta_\bullet^{-1}(a, x, m_k, \mathbf{m})) = Q_1 Q_2 Q_3^2 p \frac{1}{(\sqrt{v_{\emptyset\emptyset}})^2} Q_\sigma^a \Phi^{\emptyset,\emptyset}(a) Q_3^{m_k} \Phi^{-, }(m_k) \prod_{\substack{i=1 \\ i \neq k}}^{12} Q_3^{m_i} \Phi^{\emptyset,\emptyset}(m_i)$		
$U = L_{(0,\infty),(\infty,0)}^\sigma$	$e(U) = 1$	$\chi(\mathcal{O}_D) = 0$
$e(\eta_\bullet^{-1}(a, x, m_k, \mathbf{m})) = Q_1 Q_2 \frac{1}{(\sqrt{v_{\emptyset\emptyset}})(\sqrt{v_{\emptyset\emptyset}})} \cdot Q_\sigma^a \Phi^{-,\emptyset}(a) \cdot Q_3^{m_k} \Phi^{+,\emptyset}(m_k) \prod_{\substack{i=1 \\ i \neq k}}^{12} Q_3^{m_i} \Phi^{\emptyset,\emptyset}(m_i)$		
$U = L_{(0,\infty),(\infty,0)}^\emptyset$	$e(U) = -1$	$\chi(\mathcal{O}_D) = 0$
$e(\eta_\bullet^{-1}(a, x, m_k, \mathbf{m})) = Q_1 Q_2 \frac{1}{(\sqrt{v_{\emptyset\emptyset}})^2} \cdot Q_\sigma^b \Phi^{\emptyset,\emptyset}(b) \cdot Q_3^{m_k} \Phi^{+,\emptyset}(m_k) \prod_{\substack{i=1 \\ i \neq k}}^{12} Q_3^{d_i} \Phi^{\emptyset,\emptyset}(d_i)$		

From lemmas 6.3.2, 6.3.4 and 6.3.5 we have:



- 1) $V_{\emptyset\emptyset\emptyset} = M(p)$
- 2) $V_{\square\emptyset\emptyset} = M(p) \frac{1}{1-p}$
- 3) $\sum_{m \geq 0} Q^m \Phi^{\emptyset, \emptyset}(m) = M(p)^2 \prod_{m > 0} (1 + p^m Q)^m$
- 4) $\sum_{m \geq 0} Q^m \Phi^{-, \emptyset}(m) = M(p)^2 \frac{1+Q}{1-p} \prod_{m > 0} (1 + p^m Q)^m$
- 5) $\sum_{m \geq 0} Q^m \Phi^{-, -}(m) = M(p)^2 \frac{1}{p} (\psi_0 + (\psi_1 + 2\psi_0)Q + \psi_0 Q^2) \prod_{m > 0} (1 + p^m Q)^m$
- 6) $\sum_{m \geq 0} Q^m \Phi^{-, |}(m) = M(p)^2 (\psi_0 + (2\psi_0 + \psi_1)Q + (\psi_0 + \psi_1)Q^2) \prod_{m > 0} (1 + p^m Q)^m$
- 7) $\sum_{m \geq 0} Q^m \Phi^{+, \emptyset}(m) = M(p)^2 (\psi_1 + \psi_0 + (\psi_1 + 2\psi_0)Q + \psi_0 Q^2) \prod_{m > 0} (1 + p^m Q)^m$.

So the after accounting for the 12 singular fibres we have the contribution from grouping 1 as:

$$Q_1 Q_2 M(p)^{24} \left(\prod_{m > 0} (1 - p^m Q_\sigma)^m (1 - p^m Q_3)^{12m} \right) \\ \cdot 12 Q_\sigma Q_3^2 ((\psi_0 + \psi_1) + Q_3(2\psi_0 + \psi_1) + 2Q_3^2 \psi_0 + Q_3^3(2\psi_0 + \psi_1) + Q_3^4(\psi_0 + \psi_1))$$

Grouping 2: We compute the results for $L_{(0,0)}$ with $L_{(\infty, \infty)}$ being completely analogous. The following table is the summary of results from 5.2.4 and 5.2.5 for the strata in grouping 2:

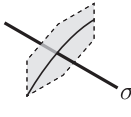
$$\mathbb{Z}_{\geq 0} \times U \times \text{Sym}_{Q_3}^\bullet(\{b_{\text{op}}^k\}) \times \text{Sym}_{Q_3}^\bullet(B_{\text{op}} \setminus \{b_{\text{op}}^k\}).$$

$U = L_{(0,0)}^\sigma$	$e(U) = -1$	$\chi(\mathcal{O}_D) = 1$
$e(\eta_\bullet^{-1}(a, x, m_k, \mathbf{m})) = Q_1 Q_2 Q_3^2 p \frac{1}{(V_{\emptyset\emptyset\emptyset})^2} Q_\sigma^a \Phi^{-, \emptyset}(a) Q_3^{m_k} \Phi^{-, \emptyset}(m_k) \prod_{\substack{i=1 \\ i \neq k}}^{12} Q_3^{m_i} \Phi^{\emptyset, \emptyset}(m_i)$		
$U = L_{(0,0)}^\emptyset$	$e(U) = 1$	$\chi(\mathcal{O}_D) = 1$
$e(\eta_\bullet^{-1}(a, x, m_k, \mathbf{m})) = Q_1 Q_2 Q_3^2 p \frac{(V_{\square\emptyset\emptyset})}{(V_{\emptyset\emptyset\emptyset})^3} Q_\sigma^a \Phi^{\emptyset, \emptyset}(a) Q_3^{m_k} \Phi^{-, \emptyset}(m_k) \prod_{\substack{i=1 \\ i \neq k}}^{12} Q_3^{m_i} \Phi^{\emptyset, \emptyset}(m_i)$		

From lemmas 6.3.2, 6.3.4 and 6.3.5 we have:

- 1) $V_{\emptyset\emptyset\emptyset} = M(p)$
- 2) $V_{\square\emptyset\emptyset} = M(p) \frac{1}{1-p}$
- 3) $\sum_{m \geq 0} Q^m \Phi^{\emptyset, \emptyset}(m) = M(p)^2 \prod_{m > 0} (1 + p^m Q)^m$
- 4) $\sum_{m \geq 0} Q^m \Phi^{-, \emptyset}(m) = M(p)^2 \frac{1+Q}{1-p} \prod_{m > 0} (1 + p^m Q)^m$

Accounting for both $L_{(0,0)}$ and $L_{(\infty,\infty)}$, the contribution for grouping 2 is:

$$Q_1 Q_2 M(p)^{24} \left(\prod_{m>0} (1 + p^m Q_\sigma)^m (1 + p^m Q_3)^{12m} \right) \\ \cdot (-24) Q_\sigma Q_3^2 (\psi_0 + Q_3 \psi_0)$$

Grouping 3: We compute the results for $L_{(0,\infty)}$ with $L_{(\infty,0)}$ being completely analogous. The following table is the summary of results from 5.2.4 and 5.2.5 for the strata in grouping 3:

$$\mathbb{Z}_{\geq 0} \times U \times \text{Sym}_{Q_3}^\bullet(\{b_{\text{op}}^k\}) \times \text{Sym}_{Q_3}^\bullet(B_{\text{op}} \setminus \{b_{\text{op}}^k\}).$$

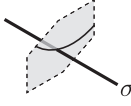
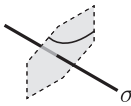
$U = L_{(0,\infty)}^\sigma$	$e(U) = -1$	$\chi(\mathcal{O}_D) = 1$
$e(\eta_\bullet^{-1}(a, x, m_k, \mathbf{m})) = Q_1 Q_2 Q_3 p \frac{1}{(\mathbb{V}_{\emptyset\emptyset\emptyset})^2} Q_\sigma^a \Phi^{-,\emptyset}(a) Q_3^{m_k} \Phi^{-,\emptyset}(m_k) \prod_{\substack{i=1 \\ i \neq k}}^{12} Q_3^{m_i} \Phi^{\emptyset,\emptyset}(m_i)$		
$U = L_{(0,\infty)}^\emptyset$	$e(U) = 1$	$\chi(\mathcal{O}_D) = 1$
$e(\eta_\bullet^{-1}(a, x, m_k, \mathbf{m})) = Q_1 Q_2 Q_3 p \frac{(\mathbb{V}_{\square\emptyset\emptyset})}{(\mathbb{V}_{\emptyset\emptyset\emptyset})^3} Q_\sigma^a \Phi^{\emptyset,\emptyset}(a) Q_3^{m_k} \Phi^{-,\emptyset}(m_k) \prod_{\substack{i=1 \\ i \neq k}}^{12} Q_3^{m_i} \Phi^{\emptyset,\emptyset}(m_i)$		

From lemmas 6.3.2, 6.3.4 and 6.3.5 we have:



- 1) $\mathbb{V}_{\emptyset\emptyset\emptyset} = M(p)$
- 2) $\mathbb{V}_{\square\emptyset\emptyset} = M(p) \frac{1}{1-p}$
- 3) $\sum_{m \geq 0} Q^m \Phi^{\emptyset,\emptyset}(m) = M(p)^2 \prod_{m>0} (1 + p^m Q)^m$
- 4) $\sum_{m \geq 0} Q^m \Phi^{-,\emptyset}(m) = M(p)^2 \frac{1+Q}{1-p} \prod_{m>0} (1 + p^m Q)^m$

Accounting for both $L_{(0,\infty)}$ and $L_{(\infty,0)}$, the contribution for grouping 3 is:

$$Q_1 Q_2 M(p)^{24} \left(\prod_{m>0} (1 + p^m Q_\sigma)^m (1 + p^m Q_3)^{12m} \right) \\ \cdot (-24) Q_\sigma Q_3^2 (\psi_0 + Q_3 \psi_0)$$

Grouping 4: The following table is the summary of results from 5.2.4 and 5.2.5 for the strata in grouping 4:

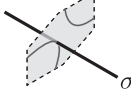
$$\mathbb{Z}_{\geq 0} \times U \times \text{Sym}_{Q_3}^\bullet(\{b_{\text{op}}^k\}) \times \text{Sym}_{Q_3}^\bullet(B_{\text{op}} \setminus \{b_{\text{op}}^k\}).$$

$U = L_{\emptyset}^{\sigma}$	$e(U) = 2$	$\chi(\mathcal{O}_D) = 1$	
$e(\eta_{\bullet}^{-1}(a, x, m_k, \mathbf{m})) = Q_1 Q_2 Q_3^2 p \frac{(\mathbb{V}_{\square\emptyset\emptyset})}{(\mathbb{V}_{\emptyset\emptyset\emptyset})^3} Q_{\sigma}^a \Phi^{-, \emptyset}(a) \prod_{i=1}^{12} Q_3^{m_i} \Phi^{\emptyset, \emptyset}(m_i)$			
$U = L_{\emptyset}^{\emptyset}$	$e(U) = -2$	$\chi(\mathcal{O}_D) = 1$	
$e(\eta_{\bullet}^{-1}(a, x, m_k, \mathbf{m})) = Q_1 Q_2 Q_3^2 p \frac{(\mathbb{V}_{\square\emptyset\emptyset})^2}{(\mathbb{V}_{\emptyset\emptyset\emptyset})^4} Q_{\sigma}^a \Phi^{\emptyset, \emptyset}(a) \prod_{i=1}^{12} Q_3^{m_i} \Phi^{\emptyset, \emptyset}(m_i)$			

From lemmas 6.3.2, 6.3.4 and 6.3.5 we have:

- 1) $\mathbb{V}_{\emptyset\emptyset\emptyset} = M(p)$
- 2) $\mathbb{V}_{\square\emptyset\emptyset} = M(p) \frac{1}{1-p}$
- 3) $\sum_{m \geq 0} Q^m \Phi^{\emptyset, \emptyset}(m) = M(p)^2 \prod_{m > 0} (1 + p^m Q)^m$
- 4) $\sum_{m \geq 0} Q^m \Phi^{-, \emptyset}(m) = M(p)^2 \frac{1+Q}{1-p} \prod_{m > 0} (1 + p^m Q)^m$

So the contribution for grouping 4 is:

$$Q_1 Q_2 M(p)^{24} \left(\prod_{m > 0} (1 + p^m Q_{\sigma})^m (1 + p^m Q_3)^{12m} \right) \cdot 24 Q_{\sigma} Q_3^2 \psi_0$$

Combining groupings 1-4 we have the overall contribution for part j is:

$$Q_1 Q_2 M(p)^{24} \left(\prod_{m > 0} (1 + p^m Q_{\sigma})^m (1 + p^m Q_3)^{12m} \right) \cdot 12 Q_{\sigma} \left((\psi_0 + \psi_1) + Q_3 \psi_1 + Q_3^3 \psi_1 + Q_3^4 (\psi_0 + \psi_1) \right)$$

6. APPENDIX

6.1. Connected Invariants and their Partition Functions. For the rank four sub-lattice $\Gamma \subset H_2(X, \mathbb{Z})$ generated by a section and banana curves, we can consider the *connected* unweighted Pandharipande-Thomas invariants. They are defined formally via the following partition function

$$\widehat{Z}_{\Gamma}^{\text{PT, Con}}(X) := \log \left(\frac{\widehat{Z}_{\Gamma}(X)}{\widehat{Z}_{(0, \bullet, \bullet)}|_{Q_i=0}} \right).$$

For the partition function in theorem A we consider the first terms of the expansion in Q_σ and Q_1 :

$$\begin{aligned} \frac{\widehat{Z}_\Gamma(X)}{\widehat{Z}_{(0,\bullet,\bullet)}|_{Q_i=0}} &= \frac{\widehat{Z}_{(0,\bullet,\bullet)}}{\widehat{Z}_{(0,\bullet,\bullet)}|_{Q_i=0}} + Q_\sigma \frac{\widehat{Z}_{\sigma+(0,\bullet,\bullet)}}{\widehat{Z}_{(0,\bullet,\bullet)}|_{Q_i=0}} + \dots \\ &= \frac{\widehat{Z}_{(0,\bullet,\bullet)}}{\widehat{Z}_{(0,\bullet,\bullet)}|_{Q_i=0}} \left(1 + Q_\sigma \frac{\widehat{Z}_{\sigma+(0,\bullet,\bullet)}}{\widehat{Z}_{(0,\bullet,\bullet)}} + \dots \right). \end{aligned}$$

So the first terms of the expansion in Q_σ and Q_1 of the connected partition function are:

$$\widehat{Z}_\Gamma^{\text{PT,Con}}(X) = \frac{\widehat{Z}_{(0,\bullet,\bullet)}}{\widehat{Z}_{(0,\bullet,\bullet)}|_{Q_i=0}} - Q_\sigma \frac{\widehat{Z}_{\sigma+(0,\bullet,\bullet)}}{\widehat{Z}_{(0,\bullet,\bullet)}} + \dots$$

In particular we have the connected version of $\widehat{Z}_{\sigma+(0,\bullet,\bullet)}$ as:

$$\widehat{Z}_{\sigma+(0,\bullet,\bullet)}^{\text{PT,Con}} = \frac{-p}{(1-p)^2} \prod_{m>0} \frac{1}{(1-Q_2^m Q_3^m)^8 (1-pQ_2^m Q_3^m)^2 (1-p^{-1}Q_2^m Q_3^m)^2},$$

proving corollary B. For the partition function in theorem C we consider the first terms of the expansion in Q_1 and Q_2 :

$$\begin{aligned} \frac{\widehat{Z}_\Gamma(X)}{\widehat{Z}_{(0,\bullet,\bullet)}|_{Q_i=0}} &= \frac{\widehat{Z}_{(0,\bullet,\bullet)}}{\widehat{Z}_{(0,\bullet,\bullet)}|_{Q_i=0}} \left(1 + Q_1 \frac{\widehat{Z}_{\bullet\sigma+(1,0,\bullet)}}{\widehat{Z}_{\bullet\sigma+(0,0,\bullet)}} + Q_2 \frac{\widehat{Z}_{\bullet\sigma+(0,1,\bullet)}}{\widehat{Z}_{\bullet\sigma+(0,0,\bullet)}} + Q_1 Q_2 \frac{\widehat{Z}_{\bullet\sigma+(1,1,\bullet)}}{\widehat{Z}_{\bullet\sigma+(0,0,\bullet)}} + \dots \right). \end{aligned}$$

So the first terms of the expansion in Q_1 and Q_2 of the connected partition function are:

$$\begin{aligned} \widehat{Z}_\Gamma^{\text{PT,Con}}(X) &= \log \left(\frac{\widehat{Z}_{(0,\bullet,\bullet)}}{\widehat{Z}_{(0,\bullet,\bullet)}|_{Q_i=0}} \right) - Q_1 \frac{\widehat{Z}_{\bullet\sigma+(1,0,\bullet)}}{\widehat{Z}_{\bullet\sigma+(0,0,\bullet)}} - Q_2 \frac{\widehat{Z}_{\bullet\sigma+(0,1,\bullet)}}{\widehat{Z}_{\bullet\sigma+(0,0,\bullet)}} \\ &\quad + Q_1 Q_2 \left(\frac{\widehat{Z}_{\bullet\sigma+(1,0,\bullet)} \widehat{Z}_{\bullet\sigma+(0,1,\bullet)}}{(\widehat{Z}_{\bullet\sigma+(0,0,\bullet)})^2} - \frac{\widehat{Z}_{\bullet\sigma+(1,1,\bullet)}}{\widehat{Z}_{\bullet\sigma+(0,0,\bullet)}} \right) + \dots \end{aligned}$$

In particular we have the connected version of $\widehat{Z}_{\bullet\sigma+(0,0,\bullet)}$ as

$$\begin{aligned} \widehat{Z}_{\bullet\sigma+(0,0,\bullet)}^{\text{PT,Con}} &= \log \left(\frac{\widehat{Z}_{\bullet\sigma+(0,0,\bullet)}}{\widehat{Z}_{(0,\bullet,\bullet)}|_{Q_i=0}} \right) \\ &= \log \left(\prod_{m>0} (1+p^m Q_\sigma)^m (1+p^m Q_3)^{12m} \right) \\ &= \sum_{n>0} \frac{p^n}{(1-p^n)^2} \frac{(-Q_\sigma)^n}{n} + \sum_{n>0} 12 \frac{p^n}{(1-p^n)^2} \frac{(-Q_3)^n}{n} \\ &= \sum_{n>0} \psi_0(p^n) \frac{(-Q_\sigma)^n}{n} + \sum_{n>0} 12 \psi_0(p^n) \frac{(-Q_3)^n}{n} \end{aligned}$$

and the connected version of $\widehat{Z}_{\bullet\sigma+(0,1,\bullet)}$ (and also of $\widehat{Z}_{\bullet\sigma+(1,0,\bullet)}$) given by:

$$\widehat{Z}_{\bullet\sigma+(0,1,\bullet)}^{\text{PT,Con}} = - \left((12\psi_0 + Q_3(24\psi_0 + 12\psi_1) + Q_3^2(12\psi_0)) + Q_\sigma Q_3(\psi_0 + 2\psi_1) \right)$$

and the connected version of $\widehat{Z}_{\bullet\sigma+(1,1,\bullet)}$ given by:

$$\begin{aligned} & \widehat{Z}_{\bullet\sigma+(1,1,\bullet)}^{\text{PT, Con}} \\ &= \left(12(Q_3^4(2\psi_0 + \psi_1) + Q_3^3(8\psi_0 + 6\psi_1 + \psi_2) + Q_3^2(12\psi_0 + 10\psi_1 + 2\psi_2) \right. \\ & \quad \left. + Q_3(8\psi_0 + 6\psi_1 + \psi_2) + (2\psi_0 + \psi_1)) \right) \\ & \quad + Q_\sigma \left((12\psi_0 + 2\psi_1) + Q_3(48\psi_0 + 44\psi_1) + Q_3^2(216\psi_0 + 108\psi_1 + 24\psi_2) \right. \\ & \quad \left. + Q_3^3(48\psi_0 + 44\psi_1) + Q_3^4(12\psi_0 + 2\psi_1) \right). \end{aligned}$$

Corollary D now follows immediately.

6.2. Linear System in $\mathbb{P}^1 \times \mathbb{P}^1$. In this section we consider a stratification of the following linear system in $\mathbb{P}^1 \times \mathbb{P}^1$ with strata determined by the intersections of the associated divisors with a collection of points.

Consider the fibres of the projection maps $\text{pr}_i : \mathbb{P}^1 \times \mathbb{P}^1 \rightarrow \mathbb{P}^1$ and a fibre from each f_i . The linear system in $\mathbb{P}^1 \times \mathbb{P}^1$ defined by the sum of a fibre from each map is $|f_1 + f_2| = \mathbb{P}^3$. This is the collection of bi-homogeneous polynomials of degree $(1, 1)$:

$$\left\{ ax_0y_0 + bx_0y_1 + cx_1y_0 + dx_1y_1 = 0 \mid [a : b : c : d] \in \mathbb{P}^3 \right\}$$

6.2.1. There are five points in $\mathbb{P}^1 \times \mathbb{P}^1$ that are of interest to us:

$$\sigma = ([1 : 1], [1 : 1]) \quad \text{and} \quad \mathbf{P} := \{(0, 0), (0, \infty), (\infty, 0), (\infty, \infty)\}.$$

where we have used the standard notation $0 = [0 : 1]$ and $\infty = [1 : 0]$. We will decompose $|f_1 + f_2|$ into strata based on which points the divisor intersects. Consider a divisor $D \in |f_1 + f_2|$. Then D passes through:

- 1) $(0, 0)$ if and only if $d = 0$;
- 2) $(0, \infty)$ if and only if $c = 0$;
- 3) $(\infty, 0)$ if and only if $b = 0$;
- 4) (∞, ∞) if and only if $a = 0$.

6.2.2. Define the following convenient notation for $y, x \in \mathbf{P}$:

- 1) $\text{Sing} \subset |f_1 + f_2|$ is the subset of singular divisors.
- 2) $\mathbf{L}_\emptyset \subset (|f_1 + f_2| \setminus \text{Sing})$ is the subset of smooth curves not passing through any points of \mathbf{P} .
- 3) $\mathbf{L}_x \subset (|f_1 + f_2| \setminus \text{Sing})$ is the subset of smooth curve passing through x but no other points of \mathbf{P} .
- 4) $\mathbf{L}_{x,y} \subset (|f_1 + f_2| \setminus \text{Sing})$ is the subset of smooth curve passing through x and y but no other points of \mathbf{P} .
- 5) Also let $\mathbf{L}_\emptyset^\sigma, \mathbf{L}_x^\sigma$ and $\mathbf{L}_{x,y}^\sigma$ be subsets of $\mathbf{L}_\emptyset, \mathbf{L}_x$ and $\mathbf{L}_{x,y}$ respectively with the further condition that the curves pass through σ .
- 6) Let $\mathbf{L}_\emptyset^\emptyset, \mathbf{L}_x^\emptyset$ and $\mathbf{L}_{x,y}^\emptyset$ be the complements of $\mathbf{L}_\emptyset^\sigma, \mathbf{L}_x^\sigma$ and $\mathbf{L}_{x,y}^\sigma$ in $\mathbf{L}_\emptyset, \mathbf{L}_x$ and $\mathbf{L}_{x,y}$ respectively.

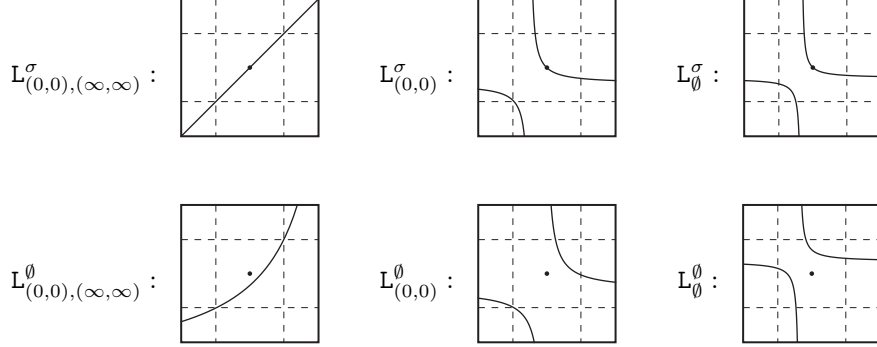

Figure 12. Depictions of the curves in the decomposition of the linear system $|f_1 + f_2|$ on $\mathbb{P}^1 \times \mathbb{P}^1$.

With this notation we have the following decomposition of $|f_1 + f_2|$:

$$\begin{aligned}
 |f_1 + f_2| = \text{Sing} \amalg & \text{L}_{(0,0),(\infty,\infty)} \amalg \text{L}_{(0,\infty),(\infty,0)} \\
 & \amalg \text{L}_{(0,0)} \amalg \text{L}_{(0,\infty)} \amalg \text{L}_{(\infty,0)} \amalg \text{L}_{(\infty,\infty)} \\
 & \amalg \text{L}_{\emptyset}.
 \end{aligned}$$

6.2.3. We now consider the strata of this collection and their Euler characteristics:

ban: A curve in $|f_1 + f_2|$ is singular if and only if the equation for the curve factorises:

$$\alpha x_0 y_0 + b x_0 y_1 + c x_1 y_0 + d x_1 y_1 = (\alpha x_0 + \beta x_1)(\gamma y_0 + \delta y_1) = 0$$

where $[\alpha : \beta], [\gamma : \delta] \in \mathbb{P}^1$. Hence $\text{Sing} \cong \mathbb{P}^1 \times \mathbb{P}^1$ and the Euler characteristic is $e(\text{ban}) = e(|f_1 + f_2|) = 4$.

L_{x,y}: We consider for $x = (0, 0)$ and $y = (\infty, \infty)$ with the case $(0, \infty)$ and $(\infty, 0)$ being completely analogous. The points $[a : b : d : c] \in |f_1 + f_2|$ correspond to a curve passing through x and y if and only if $a = d = 0$. Moreover, this is singular when either $b = 0$ or $c = 0$. Hence $\text{L}_{x,y} \cong \mathbb{P}^1 \setminus \{0, \infty\}$ and $e(\text{L}_{x,y}) = 0$.

The set $\text{L}_{x,y}^\sigma$ is when $b + c = 0$, which is a point in \mathbb{P}^1 . So we have $e(\text{L}_{x,y}^\sigma) = 1$ and $e(\text{L}_{x,y}^\emptyset) = -1$.

L_x: We consider the case $x = (0, 0)$ with the other cases being completely analogous. So the subspace of all divisors passing through x is $[a : b : d : c] \in |f_1 + f_2|$ where $d = 0$. This is a $\mathbb{P}^2 \subset \mathbb{P}^3$. The subspace where the curve doesn't pass through one of the other points is where $a, b, c \neq 0$ which is given by $\mathbb{C}^* \times \mathbb{C}^* \cong \mathbb{P}^2 \setminus (\{a = 0\} \cup \{b = 0\} \cup \{c = 0\})$. None of the equations for these curves factorise since such a factorisation would require either $b = 0$ or $c = 0$. Hence, $\text{L}_x \cong \mathbb{C}^* \times \mathbb{C}^*$ and $e(\text{L}_x) = 0$.

The subset L_x^σ is defined by the further condition $a + b + c = 0$ which gives

$$\text{L}_x^\sigma = \left\{ [a : b : c] \in \mathbb{P}^2 \mid a, b, c \neq 0 \text{ and } a + b = 1 \right\} \cong \mathbb{C}^* \setminus \text{pt}$$

Hence we have the Euler characteristics $e(\text{L}_x^\sigma) = -1$ and $e(\text{L}_x^\emptyset) = 1$.

L_\emptyset : The set of curves not passing through any points of \mathbf{P} is given by

$$\left\{ [a : b : c : d] \in |f_1 + f_2| \mid a, b, c, d \neq 0 \right\} \cong \left\{ b, c, d \in (\mathbb{C}^*)^3 \right\}$$

The singular curves are given by the factorisation condition:

$$x_0y_0 + bx_0y_1 + cx_1y_0 + dx_1y_1 = (x_0 + \beta x_1)(y_0 + \delta y_1)$$

which is the condition that $d = bc$. So the subspace of curves which are singular is $(\mathbb{C}^*)^2 \subset (\mathbb{C}^*)^3$. Hence $L_\emptyset \cong \{(b, c, d) \in (\mathbb{C}^*)^3 \mid b \neq dc\}$ and $e(L_\emptyset) = 0$.

L_\emptyset^σ is given by the further condition that $b + c + d = 0$, so we have:

$$\begin{aligned} L_\emptyset^\sigma &\cong \left\{ (b, c, d) \in (\mathbb{C}^*)^3 \mid d \neq bc \text{ and } 1 + b + c + d = 0 \right\} \\ &\cong \left\{ (b, c) \in (\mathbb{C}^*)^2 \mid (b+1)(c+1) \neq 0 \text{ and } b+c \neq -1 \right\} \\ &\cong \left\{ (b, c) \in (\mathbb{C}^* \setminus \{-1\})^2 \mid b+c \neq -1 \right\} \\ &\cong (\mathbb{C}^* \setminus \{-1\})^2 - (\mathbb{C} \setminus \{2\text{pt}\}). \end{aligned}$$

Hence we have the Euler characteristics $e(L_\emptyset^\sigma) = 2$ and $e(L_\emptyset^\emptyset) = -2$.

6.3. Topological Vertex Formulas. In this section of the appendix we collect some useful formulas for partition functions involving the topological vertex.

Define the ‘‘MacMahon’’ notation:

$$M(p, Q) = \prod_{m>0} (1 - p^m Q)^{-m}$$

and the simpler version $M(p) = M(p, 1)$.

Lemma 6.3.1. *We have the equality:*

$$V_{\lambda \square \square} V_{\lambda \emptyset \emptyset} = \frac{1}{p} V_{\lambda \emptyset \emptyset} V_{\lambda \emptyset \emptyset} + V_{\lambda \emptyset \emptyset} V_{\lambda \emptyset \emptyset}$$

Proof. We prove the equivalent equation:

$$\frac{V_{\square \square \nu}}{V_{\emptyset \emptyset \nu}} = \frac{1}{p} + \frac{V_{\square \emptyset \nu} V_{\emptyset \square \nu}}{(V_{\emptyset \emptyset \nu})^2}$$

From the definition we have:

$$\begin{aligned} \frac{V_{\square \square \nu}}{V_{\emptyset \emptyset \nu}} &= \frac{1}{p} \sum_{\eta \subset \square} S_{\square/\eta}(p^{-\nu-\rho}) S_{\square/\eta}(p^{-\nu^t-\rho}) \\ &= \frac{1}{p} \left(S_{\square/\emptyset}(p^{-\nu-\rho}) S_{\square/\emptyset}(p^{-\nu^t-\rho}) + S_{\square/\square}(p^{-\nu-\rho}) S_{\square/\square}(p^{-\nu^t-\rho}) \right) \\ &= \frac{V_{\square \emptyset \nu} V_{\emptyset \square \nu}}{(V_{\emptyset \emptyset \nu})^2} + \frac{1}{p} \end{aligned}$$

□

Lemma 6.3.2. *We have*

- 1) $V_{\emptyset \emptyset \emptyset} = M(p)$
- 2) $V_{\square \emptyset \emptyset} = M(p) \frac{1}{1-p}$
- 3) $V_{\square \square \emptyset} = M(p) \frac{p^2 - p + 1}{p(1-p)^2}$
- 4) $V_{\square \square \square} = M(p) \frac{p^4 - p^3 + p^2 - p + 1}{p^2(1-p)^3}$

Proof. Part 1) is immediate from the definition. For part 2) we have:

$$\begin{aligned} \mathbf{V}_{\square\emptyset\emptyset} &= M(p)p^{-\frac{1}{2}}S_{\emptyset}(p^{-\rho})\sum_{\eta}S_{\square/\eta}(p^{-\rho})S_{\emptyset/\eta}(p^{-\rho}) \\ &= M(p)\frac{1}{1-p} \end{aligned}$$

For part 3) we have:

$$\begin{aligned} \mathbf{V}_{\square\square\emptyset} &= M(p)p^{-1}S_{\emptyset}(p^{-\rho})\sum_{\eta}S_{\square/\eta}(p^{-\rho})S_{\square/\eta}(p^{-\rho}) \\ &= M(p)p^{-1}\left(S_{\square/\emptyset}(p^{-\rho})S_{\square/\emptyset}(p^{-\rho}) + S_{\square/\square}(p^{-\rho})S_{\square/\square}(p^{-\rho})\right) \\ &= M(p)p^{-1}\left(\frac{p}{(1-p)^2} + 1\right) \\ &= M(p)\frac{p^2 - p + 1}{p(1-p)^2} \end{aligned}$$

Part 4) follows from parts 2) and 3) and lemma 6.3.1:

$$\mathbf{V}_{\square\square\square} = \frac{1}{p}\mathbf{V}_{\square\emptyset\emptyset} + \frac{\mathbf{V}_{\square\square\emptyset}\mathbf{V}_{\emptyset\emptyset\square}}{\mathbf{V}_{\square\emptyset\emptyset}}$$

□

6.3.3. It is shown in [Br, §4.3] that:

$$\begin{aligned} &\sum_{\nu,\alpha,\mu} Q_1^{|\nu|} Q_2^{|\alpha|} Q_3^{|\mu|} p^{\frac{1}{2}(\|\nu\|^2 + \|\nu^t\|^2 + \|\alpha\|^2 + \|\alpha^t\|^2 + \|\mu\|^2 + \|\mu^t\|^2)} (\mathbf{V}_{\nu\mu\alpha} \mathbf{V}_{\nu^t\mu^t\alpha^t}) \\ &= \prod_{d_1, d_2, d_3 \geq 0} \prod_k (1 - (-Q_1)^{d_1} (-Q_2)^{d_2} (-Q_3)^{d_3} p^k)^{-c(\|\mathbf{d}\|, k)} \end{aligned}$$

where $\mathbf{d} = (d_1, d_2, d_3)$ and the second product is over $k \in \mathbb{Z}$ unless $\mathbf{d} = (0, 0, 0)$ in which case $k > 0$. The powers $c(\|\mathbf{d}\|, k)$ are defined by

$$\sum_{a=-1}^{\infty} \sum_{k \in \mathbb{Z}} c(a, k) Q^a y^k := \frac{\sum_{k \in \mathbb{Z}} Q^{k^2} (-y)^k}{\left(\sum_{k \in \mathbb{Z} + \frac{1}{2}} Q^{2k^2} (-y)^k\right)^2} = \frac{\vartheta_4(2\tau, z)}{\vartheta_1(4\tau, z)^2}$$

and $\|\mathbf{d}\| := 2d_1d_2 + 2d_2d_3 + 2d_3d_1 - d_1^2 - d_2^2 - d_3^2$. Also, if we recall the notation that

$$\psi_g := \left(\frac{p}{(1-p)^2}\right)^{1-g}$$

then we have the following corollary.

Lemma 6.3.4. *We have:*

$$\begin{aligned} 1) &\sum_{\alpha,\mu} Q_2^{|\alpha|} Q_3^{|\mu|} p^{\frac{1}{2}(\|\alpha\|^2 + \|\alpha^t\|^2 + \|\mu\|^2 + \|\mu^t\|^2)} (\mathbf{V}_{\emptyset\mu\alpha} \mathbf{V}_{\emptyset\mu^t\alpha^t}) \\ &= M(p)^2 \prod_{m>0} \frac{M(p, Q_2^m Q_3^m)^2}{(1 - Q_2^m Q_3^m) M(p, -Q_2^{m-1} Q_3^m) M(p, -Q_2^m Q_3^{m-1})} \\ 2) &\sum_{\alpha} Q^{|\alpha|} p^{\frac{1}{2}(\|\alpha\|^2 + \|\alpha^t\|^2)} (\mathbf{V}_{\emptyset\emptyset\alpha} \mathbf{V}_{\emptyset\emptyset\alpha^t}) = M(p)^2 \prod_{m>0} (1 + p^m Q)^m \\ 3) &\sum_{\alpha} Q^{|\alpha|} p^{\frac{1}{2}(\|\alpha\|^2 + \|\alpha^t\|^2) + 1} (\mathbf{V}_{\square\emptyset\alpha} \mathbf{V}_{\square\emptyset\alpha^t}) \\ &= M(p)^2 (\psi_0 + (\psi_1 + 2\psi_0)Q + \psi_0 Q^2) \prod_{m>0} (1 + p^m Q)^m \end{aligned}$$

$$\begin{aligned}
 4) \sum_{\alpha} Q^{|\alpha|} p^{\frac{1}{2}(\|\alpha\|^2 + \|\alpha^t\|^2) + 2} (\mathbf{V}_{\square\square\alpha} \mathbf{V}_{\square\square\alpha^t}) \\
 = M(p)^2 \prod_{m>0} (1 + p^m Q)^m \left(Q^4(2\psi_0 + \psi_1) + Q^3(8\psi_0 + 6\psi_1 + \psi_2) + Q^2(12\psi_0 \right. \\
 \left. + 10\psi_1 + 2\psi_2) + Q(8\psi_0 + 6\psi_1 + \psi_2) + (2\psi_0 + \psi_1) \right)
 \end{aligned}$$

Proof. These are all coefficients of the partition function in 6.3.3. For example part 3) is the coefficient of $Q_1^1 Q_2^0$. \square

Lemma 6.3.5. *We have the following equalities:*

$$\begin{aligned}
 1) \sum_{\alpha} Q^{|\alpha|} p^{\frac{1}{2}(\|\alpha\|^2 + \|\alpha^t\|^2)} (\mathbf{V}_{\emptyset\emptyset\alpha} \mathbf{V}_{\emptyset\emptyset\alpha^t}) &= M(p)^2 \frac{1+Q}{1-p} \prod_{m>0} (1 + p^m Q)^m \\
 2) \sum_{\alpha} Q^{|\alpha|} p^{\frac{1}{2}(\|\alpha\|^2 + \|\alpha^t\|^2) + 1} (\mathbf{V}_{\square\square\alpha} \mathbf{V}_{\emptyset\emptyset\alpha^t}) \\
 &= M(p)^2 ((\psi_0 + \psi_1) + (2\psi_0 + \psi_1)Q + \psi_0 Q^2) \prod_{m>0} (1 + p^m Q)^m \\
 3) \sum_{\alpha} Q^{|\alpha|} p^{\frac{1}{2}(\|\alpha\|^2 + \|\alpha^t\|^2) + 1} (\mathbf{V}_{\square\emptyset\alpha})^2 \\
 &= M(p)^2 (\psi_0 + (2\psi_0 + \psi_1)Q + (\psi_0 + \psi_1)Q^2) \prod_{m>0} (1 + p^m Q)^m
 \end{aligned}$$

Proof. Part 1) is given by:

$$\begin{aligned}
 &\sum_{\alpha} Q^{|\alpha|} p^{\frac{1}{2}(\|\alpha\|^2 + \|\alpha^t\|^2)} (\mathbf{V}_{\alpha\square\emptyset} \mathbf{V}_{\alpha^t\emptyset\emptyset}) \\
 &= p^{-\frac{1}{2}} M(p)^2 \sum_{\alpha} Q^{|\alpha|} \sum_{\eta} S_{\alpha^t/\eta}(p^{-\rho}) S_{\square/\eta}(p^{-\rho}) \sum_{\delta} S_{\alpha/\delta}(p^{-\rho}) S_{\emptyset/\delta}(p^{-\rho}) \\
 &= p^{-\frac{1}{2}} M(p)^2 \sum_{\alpha} Q^{|\alpha|} \left(S_{\alpha^t}(p^{-\rho}) S_{\square}(p^{-\rho}) + S_{\alpha^t/\square}(p^{-\rho}) \right) S_{\alpha}(p^{-\rho}) \\
 &= p^{-\frac{1}{2}} M(p)^2 \left(S_{\square}(p^{-\rho}) \sum_{\alpha \supset \emptyset} S_{\alpha^t/\emptyset}(p^{-\rho}) S_{\alpha/\emptyset}(Qp^{-\rho}) + \sum_{\alpha \supset \square} S_{\alpha^t/\square}(p^{-\rho}) S_{\alpha/\emptyset}(Qp^{-\rho}) \right)
 \end{aligned}$$

After applying [Ma, Eqn. 2, pg. 96] the equation becomes

$$\begin{aligned}
 &p^{-\frac{1}{2}} M(p)^2 \prod_{i,j>0} (1 + p^{i+j} Q) \\
 &\left(S_{\square}(p^{-\rho}) \sum_{\tau \subset \emptyset} S_{\emptyset/\tau}(p^{-\rho}) S_{\emptyset/\tau}(Qp^{-\rho}) + \sum_{\tau \subset \emptyset} S_{\emptyset/\tau^t}(p^{-\rho}) S_{\square/\tau}(Qp^{-\rho}) \right) \\
 &= p^{-\frac{1}{2}} M(p)^2 \prod_{m>0} (1 + p^m Q)^m (1 + Q) \frac{p^{\frac{1}{2}}}{1-p}.
 \end{aligned}$$

Part 2) follows from lemmas 6.3.1 and 6.3.4:

$$\begin{aligned}
 &\sum_{\alpha} Q^{|\alpha|} p^{\frac{1}{2}(\|\alpha\|^2 + \|\alpha^t\|^2) + 1} (\mathbf{V}_{\square\square\alpha} \mathbf{V}_{\emptyset\emptyset\alpha^t}) \\
 &= \sum_{\alpha} Q^{|\alpha|} p^{\frac{1}{2}(\|\alpha\|^2 + \|\alpha^t\|^2)} (\mathbf{V}_{\emptyset\emptyset\alpha} \mathbf{V}_{\emptyset\emptyset\alpha^t}) + \sum_{\alpha} Q^{|\alpha|} p^{\frac{1}{2}(\|\alpha\|^2 + \|\alpha^t\|^2) + 1} (\mathbf{V}_{\square\emptyset\alpha} \mathbf{V}_{\square\emptyset\alpha^t}).
 \end{aligned}$$

Part 3) is given by:

$$\begin{aligned}
& \sum_{\alpha} Q^{|\alpha|} p^{\frac{1}{2}(\|\alpha\|^2 + \|\alpha^t\|^2) + 1} (\mathbf{V}_{\square\emptyset\alpha})^2 \\
&= \sum_{\alpha} Q^{|\alpha|} p^{\frac{1}{2}(\|\alpha\|^2 + 1)} (\mathbf{V}_{\alpha\square\emptyset}) p^{\frac{1}{2}(\|\alpha^t\|^2 + 1)} (\mathbf{V}_{\emptyset\alpha\square}) \\
&= M(p)^2 \sum_{\alpha} Q^{|\alpha|} S_{\square}(p^{-\rho}) \sum_{\delta} S_{\alpha/\delta}(p^{-\square-\rho}) S_{\emptyset/\delta}(p^{-\square-\rho}) \\
&\quad S_{\emptyset}(p^{-\rho}) \sum_{\eta} S_{\alpha^t/\eta}(p^{-\rho}) S_{\square/\eta}(p^{-\rho}) \\
&= M(p)^2 S_{\square}(p^{-\rho}) \sum_{\alpha} S_{\alpha}(Qp^{-\square-\rho}) \left(S_{\alpha^t}(p^{-\rho}) S_{\square}(p^{-\rho}) + S_{\alpha^t/\square}(p^{-\rho}) \right)
\end{aligned}$$

After applying [Ma, Eqn. 2, pg. 96] the equation becomes

$$M(p)^2 S_{\square}(p^{-\rho})(1+Q) \prod_{m>0} (1+Qp^m)^m \left(S_{\square}(p^{-\rho}) + S_{\square}(p^{-\square-\rho}) \right).$$

The result follows from a quick computation involving $\mathbf{V}_{\emptyset\square\square} = \mathbf{V}_{\square\emptyset\emptyset}$ showing that

$$S_{\square}(p^{-\rho}) S_{\square}(p^{-\square-\rho}) = S_{\square}(p^{-\rho})^2 + 1.$$

□

Lemma 6.3.6. *The following are true*

$$\begin{aligned}
1) \quad & \sum_{\alpha} Q^{|\alpha|} = \prod_{d>0} \frac{1}{(1-Q^d)} \\
2) \quad & \sum_{\alpha} Q^{|\alpha|} \frac{(\mathbf{V}_{\alpha\square\emptyset})}{(\mathbf{V}_{\alpha\emptyset\emptyset})} = \frac{1}{1-p} \prod_{d>0} \frac{(1-Q^d)}{(1-pQ^d)(1-p^{-1}Q^d)} \\
3) \quad & \sum_{\alpha} p^{|\alpha|^2} Q^{|\alpha|} \frac{(\mathbf{V}_{\alpha\alpha^t\emptyset})}{(\mathbf{V}_{\emptyset\emptyset\emptyset})} = \prod_{d>0} \frac{M(p, Q^d)}{(1-Q^d)} \\
4) \quad & \sum_{\alpha} p^{|\alpha|^2} Q^{|\alpha|} \frac{(\mathbf{V}_{\alpha\alpha^t\emptyset})(\mathbf{V}_{\alpha\square\emptyset})}{(\mathbf{V}_{\alpha\emptyset\emptyset})(\mathbf{V}_{\emptyset\emptyset\emptyset})} = \frac{1}{1-p} \prod_{d>0} \frac{M(p, Q^d)}{(1-pQ^d)(1-p^{-1}Q^d)}
\end{aligned}$$

Proof. The first is a classical result and the other three are the content of [BKY, Thm. 3]. □

REFERENCES

- [Be] K. Behrend, *Donaldson-Thomas type invariants via microlocal geometry*, Ann. of Math. (2) 170 (2009), no. 3, 1307-1338. MR2600874
- [Bi] A. Białynicki-Birula, *On fixed point schemes of actions of multiplicative and additive groups*, Topology 12 (1973), 99-103. MR0313261
- [Br] J. Bryan, *The Donaldson-Thomas partition function of the banana manifold*, [arXiv:1902.08695](https://arxiv.org/abs/1902.08695)
- [BCY] J. Bryan, C. Cadman, B. Young, *The orbifold topological vertex*, Adv. Math. 229 (2012), no. 1, 531-595. MR2854183
- [BK] J. Bryan, M. Kool *Donaldson-Thomas invariants of local elliptic surfaces via the topological vertex*, Forum Math. Sigma 7 (2019), e7, 45 pp. MR3925498
- [BKY] J. Bryan, M. Kool, B. Young, *Trace identities for the topological vertex*, Selecta Math. (N.S.) 24 (2018), no. 2, 1527-1548. MR3782428
- [H] R. Hartshorne *Algebraic Geometry*, Graduate Texts in Mathematics, No. 52. Springer-Verlag, New York-Heidelberg, 1977. xvi+496 pp. ISBN: 0-387-90244-9. MR0463157
- [J] Y. Jiang, *Motivic Milnor fibre of cyclic L_{∞} -algebras*, Acta Math. Sin. (Engl. Ser.) 33 (2017), no. 7, 933-950. MR3665255

- [K] J. Kollár, *Rational curves on algebraic varieties*, Ergebnisse der Mathematik und ihrer Grenzgebiete. 3. Folge. A Series of Modern Surveys in Mathematics [Results in Mathematics and Related Areas. 3rd Series. A Series of Modern Surveys in Mathematics], 32. Springer-Verlag, Berlin, 1996. viii+320 pp. ISBN: 3-540-60168-6. MR1440180
- [Ma] I. G. Macdonald, *Symmetric functions and Hall polynomials*, Second edition. With contributions by A. Zelevinsky. Oxford Mathematical Monographs. Oxford Science Publications. The Clarendon Press, Oxford University Press, New York, 1995. x+475 pp. ISBN: 0-19-853489-2. MR1354144
- [Mi] R. Miranda *Basic Theory of Rational Elliptic Surfaces*, Dottorato di Ricerca in Matematica, Dipartimento di Matematica dell' Università di Pisa, ETS Editrice Pisa, 1989.
- [OP] G. Oberdieck, A. Pixton, *Holomorphic anomaly equations and the Igusa cusp form conjecture*, Invent. Math. 213 (2018), no. 2, 507-587. MR3827207
- [ORV] A. Okounkov, N. Reshetikhin, C. Vafa, *Quantum Calabi-Yau and classical crystals*, The unity of mathematics, 597-618, Progr. Math., 244, Birkhäuser Boston, Boston, MA, 2006. MR2181817
- [R1] A. Ricolfi, *Local contributions to Donaldson-Thomas invariants*, Int. Math. Res. Not. IMRN 2018, no. 19, 5995-6025. MR3867400
- [R2] A. Ricolfi, *The DT/PT correspondence for smooth curves*, Math. Z. 290 (2018), no. 1-2, 699-710. MR3848452
- [Ry] D. Rydh, *Families of cycles and the Chow scheme*, Ph.D. thesis, Kungliga Tekniska högskolan, Stockholm, 2008
- [St] (The) Stacks Project Authors, *The Stacks Project*, <http://stacks.math.columbia.edu/>, 2020
- [S] C. Schoen, *On fiber products of rational elliptic surfaces with section*, Math. Z. 197 (1988), no. 2, 177-199. MR0923487
- [T1] Y. Toda, *Curve counting theories via stable objects I. DT/PT correspondence*, J. Amer. Math. Soc. 23 (2010), no. 4, 1119-1157. MR2669709
- [T2] Y. Toda, *Curve counting theories via stable objects II: DT/ncDT flop formula*, J. Reine Angew. Math. 675 (2013), 1-51. MR3021446

SCHOOL OF MATHEMATICS AND STATISTICS, THE UNIVERSITY OF MELBOURNE, VICTORIA, 3010, AUSTRALIA.

DEPARTMENT OF MATHEMATICS, THE UNIVERSITY OF BRITISH COLUMBIA, VANCOUVER, BC, V6T 1Z2, CANADA.

MATEMATISKA INSTITUTIONEN, STOCKHOLMS UNIVERSITET, 106 91 STOCKHOLM, SWEDEN
Email address: `oliver.leigh@math.su.se`