

Twin-width III: Max Independent Set, Min Dominating Set, and Coloring

Édouard Bonnet ✉ 🏠 

Univ Lyon, CNRS, ENS de Lyon, Université Claude Bernard Lyon 1, LIP UMR5668, France

Colin Geniet ✉

University of Warsaw

Eun Jung Kim ✉ 

Université Paris-Dauphine, PSL University, CNRS UMR7243, LAMSADE, Paris, France

Stéphan Thomassé ✉

Univ Lyon, CNRS, ENS de Lyon, Université Claude Bernard Lyon 1, LIP UMR5668, France

Rémi Watrigant ✉ 

Univ Lyon, CNRS, ENS de Lyon, Université Claude Bernard Lyon 1, LIP UMR5668, France

Abstract

We recently introduced the notion of twin-width, a novel graph invariant, and showed that first-order model checking can be solved in time $f(d, k)n$ for n -vertex graphs given with a witness that the twin-width is at most d , called d -contraction sequence or d -sequence, and formulas of size k [Bonnet et al., FOCS '20]. The inevitable price to pay for such a general result is that f is a tower of exponentials of height roughly k . In this paper, we show that algorithms based on twin-width need not be impractical. We present $2^{O(k)}n$ -time algorithms for k -INDEPENDENT SET, r -SCATTERED SET, k -CLIQUE, and k -DOMINATING SET when an $O(1)$ -sequence of the graph is given in input. We further show how to solve the weighted version of k -INDEPENDENT SET, SUBGRAPH ISOMORPHISM, and INDUCED SUBGRAPH ISOMORPHISM, in the slightly worse running time $2^{O(k \log k)}n$. Up to logarithmic factors in the exponent, all these running times are optimal, unless the Exponential Time Hypothesis fails. Like our FO model checking algorithm, these new algorithms are based on a dynamic programming scheme following the sequence of contractions forward.

We then show a second algorithmic use of the contraction sequence, by starting at its end and rewinding it. As an example of such a reverse scheme, we present a polynomial-time algorithm that properly colors the vertices of a graph with relatively few colors, thereby establishing that bounded twin-width classes are χ -bounded. This significantly extends the χ -boundedness of bounded rank-width classes, and does so with a very concise proof. It readily yields a constant approximation for MAX INDEPENDENT SET on K_t -free graphs of bounded twin-width, and a $2^{O(\text{OPT})}$ -approximation for MIN COLORING on bounded twin-width graphs. We further observe that a constant approximation for MAX INDEPENDENT SET on bounded twin-width graphs (but arbitrarily large clique number) would actually imply a PTAS.

The third algorithmic use of twin-width builds on the second one. Playing the contraction sequence backward, we show that bounded twin-width graphs can be edge-partitioned into a linear number of bicliques, such that both sides of the bicliques are on consecutive vertices, in a fixed vertex ordering. This property is trivially shared with graphs of bounded average degree. Given that biclique edge-partition, we show how to solve the unweighted SINGLE-SOURCE SHORTEST PATHS and hence ALL-PAIRS SHORTEST PATHS in sublinear time $O(n \log n)$ and time $O(n^2 \log n)$, respectively. In sharp contrast, even DIAMETER does not admit a truly subquadratic algorithm on bounded twin-width graphs, unless the Strong Exponential Time Hypothesis fails.

The fourth algorithmic use of twin-width builds on the so-called *versatile tree of contractions* [Bonnet et al., SODA '21], a branching and more robust witness of low twin-width. We present constant-approximation algorithms for MIN DOMINATING SET and related problems, on bounded twin-width graphs, by showing that the integrality gap is constant. This is done by going down the versatile tree and stopping accordingly to a problem-dependent criterion. At the reached node, a greedy approach yields the desired approximation.

2012 ACM Subject Classification Theory of computation → Graph algorithms analysis; Theory of computation → Fixed parameter tractability

Keywords and phrases Twin-width, Max Independent Set, Min Dominating Set, Coloring, Parameterized Algorithms, Approximation Algorithms, Exact Algorithms

1 Introduction

As the title suggests, this is the third paper of a series [5, 4] devoted to a new graph invariant called *twin-width*. All the results presented in this paper are self-contained as the relevant background is given in Section 2. In the same section, the reader can find the definitions of *contraction sequences* and *twin-width*. For now, we are content with some intuition on these notions. This will be enough to sketch the ideas and techniques leading to our results, while sparing this introduction from too much formalism.

The twin-width of a graph is a non-negative integer measuring its distance to being a cograph. Among the several characterizations of cographs, a possible definition goes as follows. A graph is a *cograph* if one can find therein two twins,¹ identify them, and iterate this process until there is only one vertex left. Anticipating over the definitions of Section 2, this actually corresponds to a 0-sequence, witnessing that cographs have twin-width 0. Conversely it is also true that graphs with twin-width 0 are cographs. We generalize this identification process by allowing a controlled error on the contracted pairs of vertices. An error graph or *red graph* keeps the faulty adjacencies appearing between a contracted pair and the vertices that are neighbor of only one vertex of the pair. A *d*-sequence is an identification or contraction sequence such that the maximum degree of the error graph never exceeds *d*. The existence of such a sequence entails that the initial graph has twin-width at most *d*.

As it turns out, many graph classes have bounded twin-width: planar graphs and more generally proper minor-closed classes, bounded rank-width or clique-width graphs, proper hereditary subclasses of permutation graphs, unit interval graphs, and some particular class of cubic expanders, to name only a few.² Considering the wide variety of these classes, it might seem that our cograph generalization has gone too far to allow for a unified algorithmic treatment of bounded twin-width graphs. The first paper of the series [5] and the current one show that this is not the case. Algorithms, whose running times are provably unattainable in general graphs, are actually possible in graphs of bounded twin-width. We will now detail that point.

After defining any graph parameter κ , a natural question is whether some computationally hard problems can be solved more efficiently on graphs where κ is bounded. When this turns out to be the case for several problems, it may sometimes lead to a powerful meta-theorem. A standard way of capturing a large set of problems within the same framework is through the use of logic formulas over graphs, or more generally over relational structures. In the language of parameterized algorithms, one may ask for the existence of a Fixed-Parameter Tractable (FPT) algorithm parameterized by κ and the size of the graph formula φ to be tested: More precisely, an algorithm deciding in time $f(|\varphi|, \kappa(G))n^{O(1)}$, or better $f(|\varphi|, \kappa(G))n$, whether an n -vertex graph G satisfies φ , where f is some computable function. Certainly the most famous result of that kind is the celebrated Courcelle’s theorem, where the parameter κ is tree-width, and the formula φ ranges over Monadic Second Order logic (MSO_2)

¹ i.e., two vertices with the same neighborhood beside them

² A more exhaustive list is given in Theorem 7.

formulas [10]. On a slightly less general logic (namely MSO_1 , where quantification over edge sets is disallowed), the result holds for the smaller parameter clique-width [11]. It implies, for instance, that deciding whether a graph on n vertices contains a subset of k pairwise non-adjacent vertices (i.e., solving k -INDEPENDENT SET) can be done in linear time on graphs of constant clique-width, while in general graphs it cannot be solved in polynomial time unless $\text{P}=\text{NP}$, or in time $f(k)n^{O(1)}$ unless $\text{FPT}=\text{W}[1]$. Such a result is unlikely for twin-width, as k -INDEPENDENT SET remains NP-hard in planar graphs which have constant twin-width. Nevertheless, when parameterized by the solution size k , an FPT algorithm is known in planar graphs, and more generally in any proper minor-closed graph class. Actually, on the latter class, every problem expressible by a first-order (FO) formula φ can be solved in FPT time parameterized by $|\varphi|$ [22]. In the first paper of our series [5], we extended this result and obtained the following meta-theorem for twin-width.

► **Theorem 1.** [5] *Given an n -vertex graph G , a d -sequence of G , and a first-order formula φ , one can decide $G \models \varphi$ in time $f(|\varphi|, d)n$ for some computable function f .*

The main drawback of this kind of algorithms is the obtained running time: The function f is a tower of exponentials whose height depends on the size of the formula. This is an unavoidable price to pay to solve at once all graph problems expressible in first-order logic. Indeed, it is known that testing first-order formulas on trees requires a running time whose dependence in the size of the formula is a non-elementary function, unless $\text{P} = \text{NP}$ [23]. Furthermore the running time of our FO model checking algorithm does not get better on “seemingly simpler” formulas, such as for instance, with few quantifier alternations.

Our results.

We show that twin-width and its associated contraction sequence can also give rise to practical algorithms for some individual classic graph problems. In particular, we consider the following NP-complete problems, given a graph G and an integer k , decide if:

- k -INDEPENDENT SET: there are k pairwise non-adjacent vertices.
- k -CLIQUE: there are k pairwise adjacent vertices.
- r -SCATTERED SET: there are k vertices pairwise at distance at least r .
- k -DOMINATING SET: there is a set S of k vertices such that for every vertex v of G , either $v \in S$ or v has a neighbor in S .
- (k, r) -DOMINATING SET: there is a set S of k vertices such that every vertex of G is at distance at most r of some vertex in S .

These problems, parameterized by k , are $\text{W}[1]$ -hard (the last two are even $\text{W}[2]$ -complete), thus unlikely to admit an FPT algorithm, i.e., one with running time $f(k)n^{O(1)}$, on general graphs. We obtain single-exponential parameterized algorithms for all these problems when a contraction sequence witnessing “twin-width at most d ” is given. When considering the unparameterized optimization variant, we denote these five problems by MAX INDEPENDENT SET (and MIS for short), MAX CLIQUE, DISTANCE- $(r - 1)$ MIS, MIN DOMINATING SET, and MIN r -DOMINATING SET, respectively.

► **Theorem 2.** *Given an n -vertex graph G and a d -sequence $G = G_n, \dots, G_1 = K_1$, the above-mentioned five problems can be solved in time $2^{O_d(k)}n$.*

We then consider some $\text{W}[1]$ -complete generalizations of k -INDEPENDENT SET or of k -CLIQUE. Namely:

- **WEIGHTED MAX INDEPENDENT SET:** given a graph G with a weight function on vertices $w : V(G) \rightarrow \mathbb{R}$ and an integer k , decide whether there exists a set S of size exactly k of pairwise non-adjacent vertices such that $\sum_{v \in S} w(v)$ is maximum.
- **INDUCED SUBGRAPH ISOMORPHISM:** given a graph H on k vertices and a graph G , decide whether there exists a set $S \subseteq V(G)$ such that $G[S]$, the subgraph of G induced by S , is isomorphic to H .
- **SUBGRAPH ISOMORPHISM:** given a graph a graph H on k vertices and a graph G , decide whether there exists a set $S \subseteq V(G)$ such that H is isomorphic to a subgraph of $G[S]$.

Unlike the other two problems, **SUBGRAPH ISOMORPHISM** is *not* a generalization of **k -INDEPENDENT SET**. Though it does generalize **k -CLIQUE**. Once the formal definition of a contraction sequence is given, it will be clear that a d -sequence for G readily yields a d -sequence for its complement, \overline{G} . Thus in the context of bounded twin-width graphs, an algorithm solving **SUBGRAPH ISOMORPHISM** can be used to solve **k -INDEPENDENT SET**. For these three problems, we now get slightly superexponential parameterized algorithms.

► **Theorem 3.** *Given an n -vertex graph G and a d -sequence $G = G_n, \dots, G_1 = K_1$, the above-mentioned three problems can be solved in time $2^{O_d(k \log k)} n$.*

The algorithms behind Theorems 2 and 3 follow the same general plan. Let us consider the n successive red graphs R_n, \dots, R_1 (error graphs) obtained after each vertex contraction.³ R_n is the edgeless n -vertex graph (since there are initially no errors) and R_1 is the 1-vertex graph. We maintain optimum partial solutions populating connected subgraphs of bounded size in each R_i . Initially in R_n , the connected subgraphs are only made of single vertices (there are no edges). So the optimum partial solutions are trivial to compute. The partial solutions for R_i are built from the partial solutions of R_{i+1} in the following way. Every partial solution *not* involving the newly contracted vertex is simply kept. Every partial solution involving the newly contracted vertex is computed by merging a bounded number of previous partial solutions on pairwise disconnected sets. The key is that, by design, there is no error between the latter partial solutions. Thus the presence or absence of edges can be decided regardless of the forgotten choices of precise vertices within the solution. Eventually a (partial) solution is computed in R_1 , which constitutes an actual solution in the entire initial graph G . In a nutshell, the algorithms may be summarized as dynamic programming over connected sets of the red graphs.

For **k -INDEPENDENT SET** there is not much more to it than the previous sketch. For **(INDUCED) SUBGRAPH ISOMORPHISM** the algorithms become more technical. Also conceptually, partial solutions are no longer necessarily feasible. For **k -DOMINATING SET** some new challenges appear. The partial solutions and their actual specification are not straightforward to define, as it is for **k -INDEPENDENT SET**.

One may wonder if subexponential parameterized algorithms are possible for any of the eight problems considered so far. We will observe that even **k -INDEPENDENT SET** cannot be solved in time $2^{o(k/\log k)} n^{O(1)}$ on graphs given with an $O(1)$ -sequence, unless the Exponential Time Hypothesis fails. With a similar argument, the same lower bound applies to **k -DOMINATING SET**. Thus, up to logarithmic factors in the exponent, the running times of Theorems 2 and 3 are optimal. Actually we will see that even algorithms running in time $2^{o(n/\log n)}$ are unlikely.

³ A reader who would want precise definitions at this point is welcome to read first the couple of paragraphs of Section 2.1.

All the previous algorithms exploit the contraction sequence forward. They follow the identification process from the initial graph G to the 1-vertex graph. What if we would start at the end, and maintain solutions as the vertices are iteratively split until the initial graph G is formed? We exemplify the idea of using the contraction sequence backward with an essentially greedy coloring procedure that is not optimal but still uses relatively few colors.

Let us be more specific. A proper k -coloring of a graph G is a mapping $c : V(G) \rightarrow \{1, \dots, k\}$ such that $c(u) \neq c(v)$ whenever $uv \in E(G)$. The chromatic number, denoted by $\chi(G)$, is the smallest integer k such that G admits a proper k -coloring. It can be seen that $\chi(G) \geq \omega(G)$, where $\omega(G)$ denotes the size of a largest clique in G , whereas many constructions of triangle-free (that is, with $\omega(G) \leq 2$) graphs G with arbitrarily large $\chi(G)$ are known. A class of graph \mathcal{C} is said χ -bounded if there is a function f such that for any graph $G \in \mathcal{C}$, we have $\chi(G) \leq f(\omega(G))$. Our coloring algorithm $d+2$ -color any triangle-free graph of twin-width at most d , and more generally $(d+2)^{\omega(G)-1}$ -color any graph G given with a d -sequence. In particular, it shows the following.

► **Theorem 4.** *Every graph class with bounded twin-width is χ -bounded.*

Algorithmically this has some direct consequences for approximating the chromatic number, as well as, in the subcase of K_t -free graphs, the independence number.

The same idea of considering the contraction sequence backward is then used to show that every graph given with an $O(1)$ -sequence admits an edge partition by $O(n)$ bicliques, each side of which is on consecutive vertices, for a fixed vertex ordering. We use this edge partition to tackle the edge-unweighted version of some classic polynomial-time solvable problems:

- SINGLE-SOURCE SHORTEST PATHS: given a graph G and a source s , find a shortest-path tree rooted at s , spanning the connected component of s .
- ALL-PAIRS SHORTEST PATHS: given a graph G , find the distances in G between every pair of vertices.
- DIAMETER: given a graph G , report the largest distance in G between two vertices.

We show how breadth-first search (BFS) can be mimicked, when replacing “traversing an edge” by “traversing a biclique all at once”. A subtlety of the algorithm, beside the necessary data structures to get SINGLE-SOURCE SHORTEST PATHS sublinear in the total number of edges, lies in the fact that bicliques, contrary to single edges, can be traversed twice (once in both directions) before being discarded.

► **Theorem 5.** *If the input graph comes with an $O(1)$ -sequence, SINGLE-SOURCE SHORTEST PATHS can be solved in $O(n \log n)$ time, thus ALL-PAIRS SHORTEST PATHS and DIAMETER can be solved in $O(n^2 \log n)$ time. In contrast, DIAMETER cannot be solved in $O(n^{2-\varepsilon})$ for any $\varepsilon > 0$, even in that scenario, unless the Strong Exponential Time Hypothesis fails.*

Our algorithm inherently relies on unweighted edges. Nonetheless vertex-weights can be supported with the same running time.

MIN DOMINATING SET is known to be as approximable as the SET COVER problem. Thus, by classic papers by Johnson [31] and by Lovász [33], it admits a $\ln n$ -approximation and the integrality gap (i.e., the ratio between the optimum of the original problem and the optimum of the LP relaxation) of its standard LP formulation is also $\ln n$. In sharp contrast, unless $P=NP$, MIN DOMINATING SET cannot be approximated in polynomial-time within factor $(1 - o(1)) \ln n$ on n -vertex general graphs [14].

We show that, on bounded twin-width classes, the integrality gap of MIN DOMINATING SET is constant. This uses the *versatile trees of contractions* developed in the second paper of

the series [4]. These are more robust witnesses of low twin-width which, instead of providing a single contraction in a given trigraph, gives linearly many disjoint ones. Placing ourselves at a right node of the versatile tree, we show that a greedy strategy in the corresponding trigraph yields a constant approximation in the original graph.

► **Theorem 6.** *If the input graph comes with an $O(1)$ -sequence, MIN DOMINATING SET, DISTANCE-2 MIS, and more generally MIN r -DOMINATING SET, DISTANCE- $2r$ MIS for every positive r , admit $O(1)$ -approximation algorithms.*

These results are particular cases of the fact that when the twin-width of a matrix A is bounded, there is a linear gap between the packing number and the minimum hitting set of the hypergraph with incidence matrix A . Bounded twin-width matrices might more generally provide linear programs with bounded duality gap. It is noteworthy that MAX INDEPENDENT SET (which corresponds to DISTANCE-1 MIS) is *not* covered by the previous theorem. We further give some evidence that MIS may have a very different approximability status than MIN DOMINATING SET on bounded twin-width graphs.

Related work.

It is intrinsically difficult to compare our work to the existing literature since bounded twin-width graphs cover a wide spectrum of graph classes (more precisely, see Theorem 7 in Section 2) and is rather transversal to well-established graph classes (see in the same subsection which graphs *are* and which graphs are *not* of bounded twin-width). We sample some data points showing that our algorithms fare well even when compared to the state-of-the-art on a particular class of bounded twin-width (think, a single item on the list of Theorem 7). In that respect, the most flattering comparison point for our algorithms is perhaps with SUBGRAPH ISOMORPHISM and INDUCED SUBGRAPH ISOMORPHISM. On the contrary, k -INDEPENDENT SET admits parameterized subexponential algorithms on several sparse classes [12], an easy single-exponential algorithm on bounded-degeneracy graphs by bounded search tree, and polynomial-time algorithms on perfect graphs [25] and other classes [26], with which we cannot hope to uniformly compete.

INDUCED SUBGRAPH ISOMORPHISM, and particularly SUBGRAPH ISOMORPHISM, have a long history of parameterized algorithms on sparse classes. Let us recall some steps of that history. Eppstein showed how to solve (INDUCED) SUBGRAPH ISOMORPHISM in time $2^{O(k \log k)}n$ on planar graphs [18], and then on apex⁴-minor free graphs [19]. The latter algorithm would later be shown to work on every proper minor-closed class of graphs. In modern terms, Eppstein's algorithm is based on *low treewidth colorings*, and more precisely on the fact that planar graphs, but more generally H -minor free graphs, can be $k + 1$ -colored so that the union of any k color class has treewidth $O(k)$. Introducing a new kind of dynamic programming, dubbed *embedded*, Dorn [15] improved the running time of solving INDUCED SUBGRAPH ISOMORPHISM on planar graphs to $2^{O(k)}n$. More recently, Pilipczuk and Siebertz presented a polynomial-space $2^{O(k \log k)}n$ -time algorithm for INDUCED SUBGRAPH ISOMORPHISM on H -minor free graphs [34]. This mainly uses the treedepth counterpart of Eppstein's approach.

Given an $O(1)$ -sequence, our algorithm for (INDUCED) SUBGRAPH ISOMORPHISM also runs in time $2^{O(k \log k)}n$ (while it may face dense graphs) for the far-reaching generalization of bounded twin-width graphs (again we refer the reader to Theorem 7 for other examples of

⁴ An apex graph is one that can be made planar by removing a single vertex.

bounded twin-width classes). We also show with an elementary one-and-a-half-page proof that bounded twin-width classes are χ -bounded. This can be put in perspective with the χ -boundedness of graphs of bounded clique-width [16], which is not an easy result.

On general graphs, the current fastest algorithm for the vertex-weighted variant of ALL-PAIRS SHORTEST PATHS (APSP) is due to Yuster and runs in time $O(n^{2.842})$ [39], while no truly subcubic (i.e., running in time $O(n^{3-\varepsilon})$) algorithm is known without the use of fast matrix multiplication. Since SINGLE-SOURCE SHORTEST PATHS (SSSP) can easily be solved in time $O(n \log n)$ in sparse graphs, i.e., with $O(n)$ edges, the algorithm of Theorem 5 is only relevant on bounded twin-width classes that are dense. Among the dense classes of Theorem 7, one can find for example bounded clique-width graphs. Recently Kratsch and Nelles showed how to solve vertex-weighted APSP on graphs given with a clique-width expression of width cw in time $O(cw^2 n^2)$ [32].

Organization of the paper.

In Section 2 we introduce the relevant graph-theoretic background, then formally define contraction sequences and twin-width, and finally summarize which classes are known to have bounded twin-width and explain how d -sequences are given to our forthcoming algorithms. Section 3 contains a $2^{O(k)}n$ -time algorithm for k -INDEPENDENT SET (and r -SCATTERED SET) and a $2^{O(k \log k)}n$ -time algorithm for (INDUCED) SUBGRAPH ISOMORPHISM. In Section 4, we present a $2^{O(k)}n$ -time algorithm for k -DOMINATING SET. In Section 5, we show that bounded twin-width classes are χ -bounded and satisfy the strong Erdős-Hajnal property. In Section 6, we prove that bounded twin-width graphs can be edge-partitioned into linearly many bicliques whose sides are both on consecutive vertices, for a fixed ordering of the vertex set. We then use that property to derive algorithms solving SINGLE-SOURCE SHORTEST PATHS and ALL-PAIRS SHORTEST PATHS in time $O(n \log n)$ and $O(n^2 \log n)$, respectively. We also observe that DIAMETER is unlikely to be solvable in truly subquadratic time, in graphs of bounded twin-width. In Section 7, we give $O(1)$ -approximation algorithms for MIN DOMINATING SET and related problems, provided a d -sequence. We complement this result by some evidence that the approximability of MIS on bounded twin-width graphs may have a very different status. Finally in Section 8, we suggest some future work on approximation algorithms for bounded twin-width graphs and exact exponential algorithms for general graphs.

2 Preliminaries

We denote by $[i, j]$ the set of integers $\{i, i + 1, \dots, j - 1, j\}$, and by $[i]$ the set of integers $[1, i]$. If \mathcal{X} is a set of sets, we denote by $\cup \mathcal{X}$ their union. The notation $O_d(\cdot)$ gives an asymptotic behavior when d is seen as a constant. The notation $O^*(\cdot)$ suppresses polynomial factors.

Unless stated otherwise, all graphs are assumed undirected and simple, that is, they do not have parallel edges or self-loops. We denote by $V(G)$ and $E(G)$, the set of vertices and edges, respectively, of a graph G . For $S \subseteq V(G)$, we denote the *open neighborhood* (or simply *neighborhood*) of S by $N_G(S)$, i.e., the set of neighbors of S deprived of S , and the *closed neighborhood* of S by $N_G[S]$, i.e., the set $N_G(S) \cup S$. We simplify $N_G(\{v\})$ into $N_G(v)$, and $N_G[\{v\}]$ into $N_G[v]$. We denote by $G[S]$ the subgraph of G induced by S , and $G - S := G[V(G) \setminus S]$. A *connected subset* (or *connected set*) $S \subseteq V(G)$ is one such that $G[S]$ is connected. For two disjoint sets $A, B \subseteq V(G)$, $E(A, B)$ denotes the set of edges in $E(G)$ with one endpoint in A and the other one in B . We also denote by $G[A, B]$ the bipartite graph $(A \cup B, E(A, B))$. Two distinct vertices u, v such that $N(u) = N(v)$ are called *false*

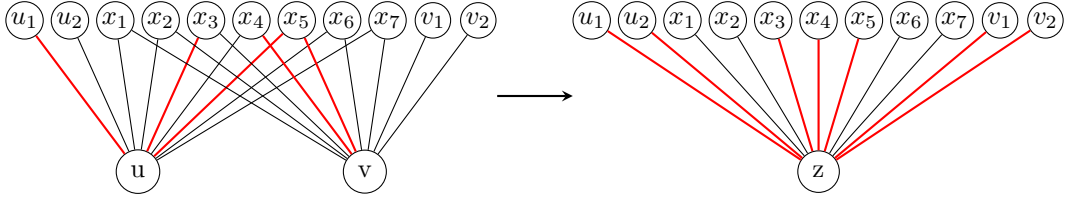

■ **Figure 1** Contraction of vertices u and v , and how the edges of the trigraph are updated.

twins, and *true twins* if $N[u] = N[v]$. Two vertices are *twins* if they are false twins or true twins. For two vertices $u, v \in V(G)$, the *distance* $d_G(u, v)$ is the number of edges in a shortest path from u to v , and ∞ if u and v are in two distinct connected components of G . Then the *radius* of a graph G is defined as $\min_{u \in V(G)} \max_{v \in V(G)} d_G(u, v)$ and the *diameter* $\text{diam}(G)$ as $\max_{u \in V(G)} \max_{v \in V(G)} d_G(u, v)$. In all the notations with a graph subscript, we may omit it if the graph is clear from the context.

A graph is H -free if it does not contain H as an induced subgraph. However we make an exception for $H = K_{t,t}$. A $K_{t,t}$ -free graph is a graph with no biclique $K_{t,t}$ as a subgraph. An *edge contraction*⁵ of two adjacent vertices u, v consists of merging u and v into a single vertex adjacent to $N(\{u, v\})$ (and deleting u and v). A graph H is a *minor* of a graph G if H can be obtained from G by a sequence of vertex and edge deletions, and edge contractions. A graph G is said H -minor free if G does not contain H as a minor. A class⁶ \mathcal{C} of graphs has *property II* if every graph of \mathcal{C} has property II . A class is *hereditary* if it is closed under taking induced subgraphs.

2.1 Trigraphs, contraction sequences, and twin-width of a graph

A *trigraph* G has vertex set $V(G)$, (black) edge set $E(G)$, and red edge set $R(G)$ (the error edges), with $E(G)$ and $R(G)$ being disjoint. The *set of neighbors* $N_G(v)$ of a vertex v in a trigraph G consists of all the vertices adjacent to v by a black or red edge. A d -trigraph is a trigraph G such that the *red graph* $(V(G), R(G))$ has degree at most d . In that case, we also say that the trigraph has *red degree* at most d . A (vertex) *contraction* or *identification* in a trigraph G consists of merging two (non-necessarily adjacent) vertices u and v into a single vertex z , and updating the edges of G in the following way. Every vertex of the symmetric difference $N_G(u) \Delta N_G(v)$ is linked to z by a red edge. Every vertex x of the intersection $N_G(u) \cap N_G(v)$ is linked to z by a black edge if both $ux \in E(G)$ and $vx \in E(G)$, and by a red edge otherwise. The rest of the edges (not incident to u or v) remain unchanged. We insist that the vertices u and v (together with the edges incident to these vertices) are removed from the trigraph. See Figure 1 for an illustration.

A d -*sequence* (or *contraction sequence*) is a sequence of d -trigraphs G_n, G_{n-1}, \dots, G_1 , where $G_n = G$, $G_1 = K_1$ is the graph on a single vertex, and G_{i-1} is obtained from G_i by performing a single contraction of two (non-necessarily adjacent) vertices. We observe that G_i has precisely i vertices, for every $i \in [n]$. The twin-width of G , denoted by $\text{tww}(G)$, is the minimum integer d such that G admits a d -sequence.

For $u \in V(G_i)$, we denote by $u(G)$ the subset of $V(G)$ that was contracted to the single vertex u in G_n, G_{n-1}, \dots, G_i . Twin-width and d -sequences can be equivalently seen

⁵ Not to be confused with our (vertex) contractions, which can be on non-adjacent vertices.

⁶ That is, a set of graphs closed under isomorphism

as a partition refinement process on $V(G)$. We start with the finest partition $\mathcal{P}_n = \{\{v\} : v \in V(G)\}$, and end with the coarsest partition $\mathcal{P}_1 = \{V(G)\}$. There is a *partition sequence* $\mathcal{P}_n, \mathcal{P}_{n-1}, \dots, \mathcal{P}_2, \mathcal{P}_1$ mimicking the contraction sequence, where the contraction of $u, v \in V(G_i)$ corresponds to the merge of parts $u(G_i), v(G_i) \in \mathcal{P}_i$ to form the part $u(G_i) \cup v(G_i) = z(G_{i-1}) \in \mathcal{P}_{i-1}$, while all the other parts are unchanged from \mathcal{P}_i to \mathcal{P}_{i-1} . The red degree (bounded by d) of a part $P \in \mathcal{P}_i$ now corresponds to the number of other parts $P' \in \mathcal{P}_i$ which are not fully adjacent nor fully non-adjacent to P in G . We may denote by $G_{\mathcal{P}}$ the trigraph corresponding to partition \mathcal{P} over $V(G)$. Thus $G_i = G_{\mathcal{P}_i}$.

2.2 Classes with bounded twin-width and how the sequences are given

The current paper is devoted to presenting efficient algorithms when the input has bounded twin-width, and the contraction sequence is given. It is therefore important to know how realistic this scenario is. Fortunately, in the first two papers of the series [5, 4] we showed that many central (di)graph classes, be it sparse or dense, have bounded twin-width. We summarize them here.

► **Theorem 7** ([5, 4]). *The following classes have bounded twin-width.*

- *Bounded clique-width/rank-width, and more generally, boolean-width graphs,*
- *every hereditary proper subclass of permutation graphs,*
- *posets of bounded antichain size (seen as digraphs),*
- *unit interval graphs,⁷*
- *K_t -minor free graphs,*
- *map graphs,⁸*
- *subgraphs of d -dimensional grids,*
- *K_t -free unit d -dimensional ball graphs,*
- *$\Omega(\log n)$ -subdivisions of all the n -vertex graphs,*
- *cubic expanders defined by iterative random 2-lifts⁹ from K_4 ,¹⁰*
- *strong products of two bounded twin-width classes one of which has also bounded degree,*
- *any subgraph closure of a $K_{t,t}$ -free bounded twin-width class, and*
- *any first-order interpretation¹¹ of a bounded twin-width class.*

Furthermore all our proofs are constructive and give rise to an $O(n^2)$ -time algorithm to find an $O(1)$ -sequence for an n -vertex graph of the class. For some sparse classes, or dense classes with a sparse representation (like unit interval graphs), the sequence can even be found in quasi-linear time or even linear time. Noticeably, we do *not* know a polynomial-time algorithm that, given a “general” graph with bounded twin-width, outputs an $O(1)$ -sequence. Thus these algorithms are mostly ad hoc and specifically use properties of each listed class. On the other hand, classes with unbounded twin-width include permutation graphs, cubic graphs, unit disk graphs, and K_t -free unit segment graphs.

It is striking that such a wide variety of seemingly unrelated graph classes allows for a unified algorithmic treatment. One may think that this has to come with a prohibitive running time. In fact our algorithms for k -INDEPENDENT SET and k -DOMINATING SET run in the essentially optimal $2^{O(k)}n$ -time (once the contraction sequence is computed), while

⁷ In this paper, we even show a linear-time algorithm finding a 2-sequence.

⁸ To find the contraction sequence, we need to be given a map embedding.

⁹ The actual definition of a 2-lift can be found in [4] but will not be needed here.

¹⁰ More generally, any graph built by successive s -lifts applied to K_t .

¹¹ Actually a more general result is shown in the first paper of the series [5].

our algorithms for INDUCED SUBGRAPH ISOMORPHISM and SUBGRAPH ISOMORPHISM match the best known running time of $2^{O(k \log k)}n$ on K_t -minor free graphs.

It may seem surprising that, given the contraction sequence, our algorithms are linear (for fixed k) in the number of vertices, while the input graph G may have $\Theta(n^2)$ edges. Also the sequence itself consists of n graphs on up to n vertices, and the total number of *vertices* in G_n, \dots, G_1 is $\Theta(n^2)$. The short answer is that we do not need to read the edges of G , nor all the vertices of all the trigraphs G_i . Instead we only look, for every $i \in [n]$, at balls of radius¹² $O(k)$ centered at the newly contracted vertex in the red graph of G_i . Each such vertex set has size $d^{O(k)}$, so we may query red *and* black edges within it. The total number of operations remains bounded by $g(d, k)n$, for some function g .

One may still wonder if our algorithms can work with a compact encoding of the d -sequence, such as the mere list of contracted vertices. The algorithms of Theorem 7 computing the d -sequences all produce the union tree of how the vertices of G are eventually merged into a single vertex. Given this tree, we can solve the disjoint set problem (union-find) in optimal $O(n)$ -time [24] (without inverse Ackermann function). Thus we can, starting from G , perform the next contraction on the list, when the next trigraph of the sequence is needed. The number of edge updates per contraction is a constant (more precisely $O(d)$). One shall not forget, though, that we need in general $\omega(n)$ -time to compute the sequence in the first place.

3 Practical algorithms for k -Independent Set and its generalizations

In this section, we present essentially optimal fixed-parameter algorithms for k -INDEPENDENT SET, INDUCED SUBGRAPH ISOMORPHISM, SUBGRAPH ISOMORPHISM, on graphs of bounded twin-width. The crux for the running time analysis is a simple bound on the number of connected subsets of size at most k in a bounded-degree graph. The key to show this folklore lemma is that a connected subgraph of size at most k can be spanned by a walk of length at most $2k - 3$.

► **Lemma 8** (folklore). *The number of vertex subsets of size at most k inducing a connected subgraph in an n -vertex graph of maximum degree d is at most $(d^{2k-2} + 1)n$.*

Proof. If $d = 0$ or $d = 1$, the total number of connected subgraphs is n or at most $3n/2$, respectively. Thus the claim holds in these cases, and we now assume that $d \geq 2$. Every connected subgraph H has a spanning tree, say, T_H rooted at v_H . The circumnavigation of T_H from v_H follows every edge of T_H at most twice. Moreover if we only span T_H without going back to v_H in the end, at least one edge of T_H is taken only once. Hence every connected subgraph of size at most k can be described by a starting vertex (n choices) followed by a walk on $2k - 3$ other vertices (at most d choices for each). Therefore the number of connected vertex subsets of size at most k is bounded by $n \sum_{0 \leq i \leq 2k-3} d^i \leq nd^{2k-2}$. ◀

We get the following as a direct corollary of the previous proof.

► **Corollary 9.** *The number of connected vertex sets of size at most k , intersecting a set X , in a graph of maximum degree d is at most $(d^{2k-2} + 1)|X|$. Furthermore they can be enumerated in time $O(d^{2k-2}|X|)$.*

We now show how to solve k -INDEPENDENT SET by dynamic programming on the connected subsets of size at most k in the red graphs of a d -sequence given with the input graph.

¹²For k -DOMINATING SET, the algorithm is more involved and this radius is function of k and d .

► **Theorem 10.** *Given an n -vertex graph G , a positive integer k , and a d -sequence $G = G_n, \dots, G_1 = K_1$, k -INDEPENDENT SET can be solved in time $O(k^2 d^{2k} n) = 2^{O_d(k)} n$.*

Proof. Our algorithm maintains a set of *optimum partial solutions* in the current trigraph, starting from G , and progressively going along the d -sequence. Let us start with a definition of the partial solutions and of their optimality.

A *partial solution* in the trigraph G_i is a pair (T, S) where $T \subseteq V(G_i)$ is a vertex set inducing a connected subgraph in the red graph $(V(G_i), R(G_i))$, and $S \subseteq V(G)$ is an independent set of G such that $S \subseteq \bigcup_{u \in T} u(G)$ and for every $u \in T$, $S \cap u(G) \neq \emptyset$. A partial solution (T, S) is said *optimum* if there is no partial solution (T, S') such that $|S| < |S'|$. A set $T \subseteq V(G_i)$ is said *realizable* (in G_i) if there is an $S \subseteq V(G)$ such that (T, S) is a partial solution in G_i . Notice that *not* every connected subset in the red graph is realizable. For instance, it is easy to engineer a situation where there is no independent set intersecting the three vertices of a 3-vertex red path. Initially, in G , the only connected subgraphs of the red graph are singletons (since there is no red edge). So there are exactly n (optimum) partial solutions in $G = G_n$: Each vertex v of G induces a partial solution $(\{v\}, \{v\})$. We denote by \mathcal{S}_n this set of n optimum partial solutions. It boils down to determining if there is a partial solution $(_, S)$ in G_1 (or actually in any G_i) with $|S| \geq k$. For i going from $n - 1$ down to 1, we will build a set of optimum partial solutions \mathcal{S}_i in G_i from the set \mathcal{S}_{i+1} , keeping the invariant that for every realizable set $T \subseteq V(G_i)$, there is a unique optimum partial solution (T, S) stored in \mathcal{S}_i (and no other partial solution in \mathcal{S}_i).

We shall then describe how we update the set of optimum partial solutions after a single contraction. Two partial solutions $(T, _)$ and $(T', _)$ in G_i are said *disjoint* if $T \cap T' = \emptyset$, and *separate*, if they are disjoint and there is no red edge $uu' \in R(G_i)$ with $u \in T$ and $u' \in T'$. Two separate partial solutions $(T, _)$ and $(T', _)$ are said *compatible* if there is no edge $uu' \in E(G_i) \cup R(G_i)$ with $u \in T$ and $u' \in T'$. The *union* of two compatible partial solutions (T_1, S_1) and (T_2, S_2) as $(T_1, S_1) \cup (T_2, S_2) := (T_1 \cup T_2, S_1 \cup S_2)$. By definition, such a union is *not* a partial solution since T induces two connected components in its current red graph. Nevertheless we will build the new (connected) partial solutions of G_i by making unions of up to $d + 2$ pairwise compatible partial solutions in G_{i+1} . These unions will be connected in G_i , hence will correspond to partial solutions as well.

Let us be more specific. Say $u, v \in V(G_{i+1})$ are contracted into $z \in V(G_i)$ to form G_i . We say that a partial solution $(T, _)$ in G_i *intersects* a set $X \subseteq V(G_i)$ if $T \cap X \neq \emptyset$. We initialize \mathcal{S}_i with all the partial solutions of \mathcal{S}_{i+1} not intersecting $\{u, v\}$. We now add one partial solution in \mathcal{S}_i per realizable set $T \ni z$ in G_i , of size at most k . For every $T \subseteq V(G_i)$ such that $z \in T$ and T induces a connected subgraph on at most k vertices in the red graph $(V(G_i), R(G_i))$, we observe three possibilities for a potential partial solution (T, S) . Either S intersects $u(G)$ and $v(G)$, or it intersects only $u(G)$, or it intersects only $v(G)$. (It is not possible that $S \cap (u(G) \cup v(G)) = \emptyset$ since T contains z .) Therefore we take the best (meaning with the largest S , breaking ties arbitrarily) of the potential partial solutions $\bigcup \text{dec}(T \setminus \{z\} \cup \{u, v\}), \bigcup \text{dec}(T \setminus \{z\} \cup \{u\}), \bigcup \text{dec}(T \setminus \{z\} \cup \{v\})$, where $\text{dec}(X)$ is the set with one partial solution per connected component of X in its red graph (here $(V(G_{i+1}), R(G_{i+1}))$). See Figure 2 for an illustration of this decomposition. In the very possible event that at least one such connected component of X is not realizable, $\text{dec}(X) = \text{None}$. The union $\bigcup \text{dec}(X)$ of all the partial solutions of $\text{dec}(X)$ is None if $\text{dec}(X) = \text{None}$ or if there is at least one black edge between two connected components. Otherwise $\bigcup \text{dec}(X)$ is a pair (T, S) as defined in the previous paragraph, since the partial solutions of $\text{dec}(X)$ are pairwise compatible. Since T is chosen connected in $(V(G_i), R(G_i))$, (T, S) is indeed a partial solution in G_i . If $\bigcup \text{dec}(T \setminus \{z\} \cup \{u, v\}), \bigcup \text{dec}(T \setminus \{z\} \cup \{u\}), \bigcup \text{dec}(T \setminus \{z\} \cup \{v\})$ all three evaluate to None ,

then $\text{best}\{\text{Udec}(T \setminus \{z\} \cup \{u, v\}), \text{Udec}(T \setminus \{z\} \cup \{u\}), \text{Udec}(T \setminus \{z\} \cup \{v\})\}$ also returns None. This would mean that T is not realizable. If instead T is realizable, we get a partial solution (T, S) that we put in \mathcal{S}_i . If $|S| \geq k$, we already have a large enough independent set; the algorithm outputs it and terminates.

If we finally build \mathcal{S}_1 , and no independent set of size at least k was found, we output S , the unique set such that $(_, S) \in \mathcal{S}_1$. \mathcal{S}_1 is indeed a singleton since there is only one realizable set in G_1 . That finishes the description of the algorithm **k-IndSet**, see Algorithm 1.

■ **Algorithm 1** **k-IndSet**

Input : A graph G , a positive integer k , and a d -sequence $G = G_n, \dots, G_1 = K_1$.
Output: An independent set of G of size at least $\min(k, \alpha(G))$.

- 1 $\mathcal{S}_n \leftarrow \bigcup_{v \in V(G)} \{(\{v\}, \{v\})\}$
- 2 **for** $i = n - 1 \rightarrow 1$ **do**
- 3 $u, v \leftarrow$ contracted pair in $G_{i+1} \rightarrow G_i$
- 4 $z \leftarrow$ contraction of u and v in G_i
- 5 $\mathcal{S}_i \leftarrow$ partial solutions of \mathcal{S}_{i+1} *not* intersecting $\{u, v\}$
- 6 **for every vertex subset** T **connected in** $(V(G_i), R(G_i))$, **with** $z \in T$ **and** $|T| \leq k$ **do**
- 7 $(T, S) \leftarrow \text{best}\{\text{Udec}(T \setminus \{z\} \cup \{u, v\}), \text{Udec}(T \setminus \{z\} \cup \{u\}), \text{Udec}(T \setminus \{z\} \cup \{v\})\}$
- 8 **if** $|S| \geq k$ **then**
- 9 **return** S
- 10 **if** $(T, S) \neq \text{None}$ **then**
- 11 $\mathcal{S}_i \leftarrow \mathcal{S}_i \cup \{(T, S)\}$
- 12 $\{(S, _)\} \leftarrow \mathcal{S}_1$
- 13 **return** S

Correctness. By a transparent induction, any set returned by **k-IndSet** is an independent set. Indeed the initial partial solutions (in \mathcal{S}_n) are singletons. Every new partial solution is formed by taking a union of independent sets such that there is no black or red edge between any pair of independent sets. Hence the union is overall an independent set.

We now claim that if there is an independent set of size at least k in G , then **k-IndSet** indeed outputs a solution of size at least k . Again we show by induction the following invariant: For every realizable set $T \subseteq V(G_i)$ (in G_i) of size at most k , \mathcal{S}_i (eventually) contains a solution (T, S) such that $|S| = \alpha(G[\bigcup_{u \in T} u(G)])$ or $|S| \geq k$. The former condition, “ $|S| = \alpha(G[\bigcup_{u \in T} u(G)])$ ”, is initially true for the singletons of \mathcal{S}_n . If the latter condition, “ $|S| \geq k$ ”, ever happens, **k-IndSet** outputs it and we are done. Thus for the induction hypothesis of \mathcal{S}_{i+1} , we suppose that the former condition always holds.

Say, $u, v \in V(G_{i+1})$ are contracted into $z \in V(G_i)$. Let T be a realizable set in G_i . If $z \notin T$, then T is also a realizable set in G_{i+1} . By the induction hypothesis, there is a partial solution (T, S^*) in \mathcal{S}_{i+1} such that $|S^*| = \alpha(G[\bigcup_{u \in T} u(G)])$. This partial solution was simply transmitted from \mathcal{S}_{i+1} to \mathcal{S}_i , hence $(T, S^*) \in \mathcal{S}_i$.

Let us now assume that $z \in T$. We fix S' , a maximum independent set in $G[\bigcup_{u \in T} u(G)]$. The algorithm **k-IndSet** defines the partial solution $(T, S) \in \mathcal{S}_i$ by taking the best of the at most three unions $\text{Udec}(T \setminus \{z\} \cup \{u, v\})$, $\text{Udec}(T \setminus \{z\} \cup \{u\})$, and $\text{Udec}(T \setminus \{z\} \cup \{v\})$ (note that at most two of those may not be defined). Build the set $\emptyset \neq I \subseteq \{u, v\}$ by putting u (resp. v) in I if $S' \cap u(G) \neq \emptyset$ (resp. $S' \cap v(G) \neq \emptyset$). We consider $\text{dec}(T \setminus \{z\} \cup I)$, the partial solutions in \mathcal{S}_{i+1} associated to each connected component of $T \setminus \{z\} \cup I$ in

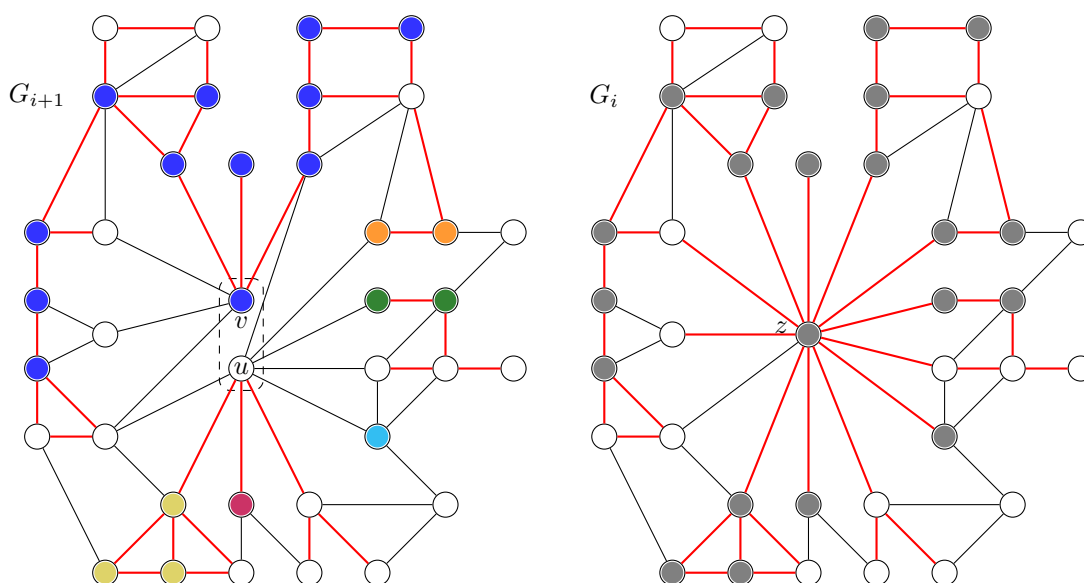

■ **Figure 2** Right: In gray, a connected vertex set T in the red graph of G_i in the vicinity of the just contracted vertex $z \in T$. Left: The decomposition $\text{dec}(T \setminus \{z\} \cup \{v\})$ in the previous trigraph G_{i+1} , where each color represents a connected component. If every color class is a realizable set in G_{i+1} , then T is realizable in G_i , with (optimum) partial solution $\bigcup \text{dec}(T \setminus \{z\} \cup \{v\})$. Note that, due to black edges between u and some vertices of T , the partial solutions in $\text{dec}(T \setminus \{z\} \cup \{u, v\})$ and in $\text{dec}(T \setminus \{z\} \cup \{u\})$ cannot be pairwise compatible.

$(V(G_{i+1}), E(G_{i+1}) \cup R(G_{i+1}))$ (by the existence of S' , each such connected component is indeed realizable). By the induction hypothesis, every partial solution of $\text{dec}(T \setminus \{z\} \cup I)$ is optimum. Thus the union $\bigcup \text{dec}(T \setminus \{z\} \cup I)$ has the same size as S' . This implies that the partial solution (T, S) put in \mathcal{S}_i is also optimum.

Finally if **k-IndSet** terminates without reporting an independent set of size at least k , our invariant on \mathcal{S}_1 indicates that $\alpha(G) < k$. In that case the unique (optimum) partial solution $(V(K_1), S) \in \mathcal{S}_1$ verifies $|S| = \alpha(G)$.

Running time. The claimed running time for **k-IndSet** essentially relies on Corollary 9. By this corollary, the sets T of the inner for loop (line 6) can be enumerated in time $O(d^{2k})$. The connected components of line 7 can be computed in time $O(\min(d, k)k)$, say, by breadth-first search in the red graph of G_i . Then checking the absence of black edges between potential partial solutions takes time $O(k^2)$. Thus the overall running time is $O(k^2 d^{2k} n)$. Interestingly, once the trigraphs of a d -sequence of G have been computed, **k-INDEPENDENT SET** can be solved in sublinear time in the size of G , when $k^2 d^{2k} n = o(|E(G)|)$. Another observation is that when the twin-width d is polylogarithmic in n , i.e., in $\Theta(\log^c n)$, **k-IndSet** is still fixed-parameter tractable in k . Indeed $\log^{O(k)} n = k^{O(k)} n$ as noticed by Sloper and Telle [37], which implies that **k-IndSet** runs in time $2^{O(k \log k)} n^2$ in that regime.

Optimizations. We suggest some improvements or variations of **k-IndSet** to generally improve over the worst-case running time of the inner for loop. A lot of sets T will trivially be *not* realizable because they induce a black edge. When enumerating the walks starting at z of length at most $2k - 3$, one can abort every branch $zv_1 \dots v_h$ inducing at least one black edge. It can even be done in a way that the enumeration takes time $O(t)$ where t is the number of sets $T \ni z$ of size at most k , such that T is connected in the red graph, and an independent set in the black graph.

Even if a set T satisfies those properties, we have no guarantee that T is realizable. In very dense instances, it is imaginable that the realizable sets are very rare. In that case, we will lose a lot of time generating sets T to observe immediately after that there is no associated partial solution (T, S) . An alternative to k -IndSet is to build the new partial solutions of \mathcal{S}_i directly as unions of pairwise compatible partial solutions of \mathcal{S}_{i+1} , without anticipating the nature of the possibly realizable set $T \subseteq V(G)$.

Let us be more precise. Let R_z be the set of red neighbors of z in G_i . For every set of at most $\max(2, d + 1)$ partial solutions $(T_1, S_1), \dots, (T_h, S_h) \in \mathcal{S}_{i+1}$ intersecting R_z , at least one of which intersects $\{u, v\}$, if the partial solutions are pairwise compatible, we update the realizable set $\bigcup_{i \in [h]} T_i$ with the partial solution $\bigcup_{i \in [h]} (T_i, S_i)$ if $\bigcup_{i \in [h]} S_i$ is larger than the current best solution. Following the first improvement, we can only generate the sets that are pairwise compatible. As we know, there are at most three ways to reach a given set $T \subseteq V(G_i)$ as a union of pairwise compatible partial solutions in \mathcal{S}_{i+1} . The running time of this variation of k -IndSet is $O^*(\sum_{i \in [n]} |\mathcal{S}_i^{\text{new}}|)$, where $\mathcal{S}_i^{\text{new}} := \mathcal{S}_i \setminus \mathcal{S}_{i-1}$ (and $\mathcal{S}_n^{\text{new}} := \mathcal{S}_n$) represents the new partial solutions computed at step i . In practice, this can be significantly better than $O(k^2 d^{2k} n)$. Such a dynamic programming, only generating “positive” subinstances, dubbed *positive-instance driven* by Tamaki, led to a breakthrough and current state-of-the-art practical algorithm for computing optimally the treewidth of a graph [38].

Weights. Without too many changes, k -IndSet may support weights, that is, find an independent set of size exactly $\min(k, \alpha(G))$ with largest total weight. Instead of keeping one solution S per realizable set T , we keep up to k solutions, one per pair (T, j) with $j \in [|T|, k]$. A partial solution (T, j, S) is defined as before except S is required to have size exactly j . To compute the new partial solutions, we add a third nested for loop after line 6: We iterate over all the ways of distributing $j \leq k$ units between the red connected components induced by $T' \in \{T \setminus \{z\} \cup \{u, v\}, T \setminus \{z\} \cup \{u\}, T \setminus \{z\} \cup \{v\}\}$ so that each connected component gets a positive integer (at least equal to its size). We then add to \mathcal{S}_i one partial solution (T, j, S) (if at least one exists) maximizing the weight of S for fixed T and j . We also skip lines 8 and 9 of k -IndSet.

This comes with a slight increase in the running time. Namely, there is an extra $2^{O(k \log k)}$ factor accounting for the ordered partition of integer $j \leq k$ into positive integers. Thus the overall running time with weights is $2^{O(k \log k)} d^{2k} n$. ◀

As twin-width and d -sequences are preserved when complementing the graph, we also solve k -CLIQUE in the same running time. One may wonder if the dependency in k of our $2^{O_d(k)} n$ -time algorithm can be improved. It turns out that this running time is essentially optimal. Due to the Sparsification Lemma [30] and folklore reductions, MIS restricted to subcubic n -vertex graphs cannot be solved in $2^{o(n)}$, under the Exponential Time Hypothesis¹³ (ETH) [29]. Thus, by the classic self-reduction consisting of performing an even subdivision of each edge [35], MIS cannot be solved in time $2^{o(n/\log n)}$ on $2\lceil \log n \rceil$ -subdivisions of n -vertex subcubic graphs, unless the ETH fails. In [4], we show how to find $O(1)$ -sequences in polynomial time for $2\lceil \log n \rceil$ -subdivisions of n -vertex graphs. Therefore this lower bound holds even if we are given the d -sequence. In particular, no algorithm solves k -INDEPENDENT SET in time $2^{o_d(k/\log k)} n^{O(1)}$, unless the ETH fails.

If \mathcal{T} is a d -sequence $G = G_n, \dots, G_1 = K_1$, we denote by $\mathcal{C}_{\mathcal{T}}$ denote the set of connected vertex subsets in a red graph of some trigraph $G_i \in \mathcal{T}$. Let us also denote by $\mathcal{C}_{\mathcal{T}, k}$ the set of connected vertex subsets of size at most k in a red graph of some trigraph $G_i \in \mathcal{T}$. In both

¹³The assumption that there is a constant $\delta > 0$, such that 3-SAT cannot be solved in time $2^{\delta n}$.

cases, the exact same vertex subset appearing connected in several trigraphs of \mathcal{T} counts only once. We know that $|\mathcal{C}_{\mathcal{T},k}| \leq d^{2k}n$ but, as we already observed, $|\mathcal{C}_{\mathcal{T},k}|$ can in principle be much smaller. As a consequence of our proof of Theorem 10, we obtain the following.

► **Theorem 11.** *Given as input an n -vertex graph G and a d -sequence $G = G_n, \dots, G_1 = K_1$, k -INDEPENDENT SET can be solved in time $O^*(|\mathcal{C}_{\mathcal{T},k}|)$ and MAX INDEPENDENT SET can be solved in time $O^*(|\mathcal{C}_{\mathcal{T}}|)$.*

We actually showed the stronger result that k -INDEPENDENT SET and MAX INDEPENDENT SET can be solved in time $O^*(|\mathcal{R}_{\mathcal{T},k}|)$ and $O^*(|\mathcal{R}_{\mathcal{T}}|)$, respectively, where $R_{\mathcal{T},k} \subseteq \mathcal{C}_{\mathcal{T},k}$ and $R_{\mathcal{T}} \subseteq \mathcal{C}_{\mathcal{T}}$ only consist of the realizable sets. In [5], we show how to find in polynomial time $f(\text{rw})$ -sequences for n -vertex graphs with rank-width (even boolean-width) at most rw . Importantly the sequences comprise only $g(\text{rw})n$ connected vertex subsets. Hence Theorem 11 in particular generalizes the $O(n)$ -time algorithm for MIS in graphs of bounded rank-width/cliue-width, given the rank- or cliue-decomposition. Indeed the polynomial algorithm computing the $f(\text{rw})$ -sequence takes time $O(n)$, provided the rank-width decomposition. Of course Theorem 11 is more general than that. In light of the next corollary, it also yields a polynomial-time algorithm when a 2-sequence can be efficiently computed.

► **Corollary 12.** *Given as input an n -vertex graph G and a 2-sequence $G = G_n, \dots, G_1 = K_1$, MAX INDEPENDENT SET can be solved in polynomial time.*

Proof. The red graphs of the trigraphs of the 2-sequence $\mathcal{T} = G_n, \dots, G_1$ are disjoint unions of paths and cycles (their degree is at most 2). Thus each $(V(G_i), R(G_i))$ has at most n^2 connected vertex subsets. Hence $|\mathcal{C}_{\mathcal{T}}| = O(n^3)$. We conclude by Theorem 11. ◀

As we will now see, Corollary 12 captures unit interval graphs, which have unbounded rank-width.

► **Lemma 13.** *Unit interval graphs have twin-width 2.*

Proof. Consider the unit interval graph $I_{k,nk}$ on vertex set $[nk]$ where, for every $j \in [nk]$, the interval of length exactly k and with left endpoint j is present. The family $I_{k,nk}$ is universal in the sense that every unit interval graph is an induced subgraph of some $I_{k,nk}$. For every $i \in [n]$, contract $ki - 1$ and ki . Then for every $i \in [n]$ in increasing order, contract $ki - 2$ with $\{ki - 1, ki\}$, etc. At every stage, the only red edges are between two consecutive contracted groups, forming a path. We eventually end up with only a red path, which has twin-width 2. ◀

We now extend Theorem 10 in two directions. We show that (INDUCED) SUBGRAPH ISOMORPHISM and r -SCATTERED SET can be solved in time $2^{O(k \log k)}n$ on graphs given with an $O(1)$ -contraction sequence.

► **Theorem 14.** *Given a graph G , a d -sequence $G = G_n, G_{n-1}, \dots, G_1 = K_1$, and a pattern graph H on k vertices, SUBGRAPH ISOMORPHISM and INDUCED SUBGRAPH ISOMORPHISM can be solved in time $2^{O(k \log k)}d^{2k}n = 2^{O_d(k \log k)}n$.*

Proof. The algorithms are almost identical and are obtained by making some additions and modifications to **k-IndSet**. We will first describe the algorithm **IndSub** for INDUCED SUBGRAPH ISOMORPHISM. The algorithm **SubIso** solving SUBGRAPH ISOMORPHISM will be obtained by changing a single word in the pseudo-code (see Algorithm 2).

We identify $V(H)$ to the set of integers $[k]$. A *division* of $T \subseteq V(G_i)$ ¹⁴ is a mapping η from T to $2^{[k]} \setminus \{\emptyset\}$ such that $\eta(u) \cap \eta(v) = \emptyset$ for every $u \neq v \in T$. We define $\eta(T)$ as $\bigcup_{u \in T} \eta(u)$. Given a realizable set $T \subseteq V(G_i)$ and a division η of T , a set $S \subseteq V(G)$ is said (T, η) -compliant (or simply compliant, if T and η are clear from the context) if there is an induced subgraph isomorphism λ from $H[\eta(T)]$ to $G[S]$, such that $S \cap u(G) = \lambda(\eta(u))$ for every $u \in T$. Now partial solutions in G_i are triples (T, η, S) where $T \subseteq V(G_i)$ is still a vertex set of size at most k inducing a connected subgraph in $(V(G_i), R(G_i))$, η is a division of T , and $S \subseteq V(G)$ is (T, η) -compliant. In particular $S \subseteq \bigcup_{u \in T} u(G)$ and $S \cap u(G) \neq \emptyset$, as it was the case for k -INDEPENDENT SET.

It is simpler to first present the new algorithms with a classic (static) dynamic programming. As before this can be turned into its “positive-instance driven” version. We maintain a table \mathcal{T} , where for every realizable set $T \subseteq V(G_i)$ and every division η of T , $\mathcal{T}[T, \eta]$ is intended to contain a (T, η) -compliant set $S \subseteq V(G)$ if it exists, and “None” otherwise. It can be observed that for every vertex $v \in V(G)$, the singleton $\{v\}$ is $(\{v\}, \eta)$ -compliant for every division η of $\{v\}$. Notice that a division of $\{v\}$ assigns a single vertex $j \in V(H) = [k]$ to v . We therefore initialize \mathcal{T} by putting $\{v\}$ in each cell $\mathcal{T}[\{v\}, \eta : v \mapsto \{j\}]$, for every $v \in V(G)$ and $j \in [k]$. By default, if a cell of \mathcal{T} is not filled, it contains the value “None”.

As in the algorithm of Theorem 10, we can compute the partial solutions in G_i from the partial solutions in G_{i+1} . Say that to go from G_{i+1} to G_i , we contract $u, v \in V(G_{i+1})$ into $z \in V(G_i)$. Note that every cell $\mathcal{T}[T, _]$ such that $T \subseteq V(G_i) \setminus \{z\}$ was previously filled. Indeed a set $T \subseteq V(G_i) \setminus \{z\}$ connected in $(V(G_i), R(G_i))$ is also connected in $(V(G_{i+1}), R(G_{i+1}))$ (and included in $V(G_{i+1}) \setminus \{u, v\}$). We shall fill the cells $\mathcal{T}[T, _]$ such that $z \in T \subseteq V(G_i)$. Again we build these partial solutions as union of partial solutions in G_{i+1} . The fact $z \in T$ entails that such a union may cover u , or v , or both. For every $I \in \{\{u\}, \{v\}, \{u, v\}\}$, we decompose $T' := T \setminus \{z\} \cup I$ into its connected component T_1, \dots, T_h in the red graph $(V(G_{i+1}), R(G_{i+1}))$. Any division η of T' naturally breaks into h divisions η_1, \dots, η_h where η_p is a division of T_p for every $p \in [h]$. We denote by $\text{dec}(T', \eta)$ the h pairs $(T_1, \eta_1), \dots, (T_h, \eta_h)$.

For every such pair (T', η) , we fill $\mathcal{T}[T', \eta]$ with an actual solution if the following holds. First, every entry $\mathcal{T}[T_p, \eta_p]$, for $p \in [h]$, should contain an actual solution S_p (which is not “None”). Secondly, for every $p \neq p' \in [h]$ the edges and non-edges in H between $\eta_p(T_p)$ and $\eta_{p'}(T_{p'})$ should match the edges and non-edges in G between S_p and $S_{p'}$. More precisely, there should be a bijection λ from $\eta_p(T_p) \cup \eta_{p'}(T_{p'})$ to $S_p \cup S_{p'}$ such that $\lambda(\eta(x)) = (S_p \cup S_{p'}) \cap x(G)$ for every $x \in T_p \cup T_{p'}$ where $\eta(x) := \eta_p(x)$ if $x \in T_p$ and $\eta(x) := \eta_{p'}(x)$ if $x \in T_{p'}$, and $ab \in E_H(\eta_p(T_p), \eta_{p'}(T_{p'}))$ if and only if $\lambda(a)\lambda(b) \in E_G(S_p, S_{p'})$. Such a bijection λ is called an $(\eta_p, \eta_{p'})$ -isomorphism. We also say that $H[\eta_p(T_p), \eta_{p'}(T_{p'})]$ is $(\eta_p, \eta_{p'})$ -isomorphic to $G[S_p, S_{p'}]$. Since T_p and $T_{p'}$ induce two connected components in the red graph of G_{i+1} , there are only black edges and non-edges between pairs $x \in T_p, x' \in T_{p'}$. Thus the notion of $(\eta_p, \eta_{p'})$ -isomorphism crucially does *not* depend on S_p and $S_{p'}$: If $ab \in E_H(\eta_p(T_p), \eta_{p'}(T_{p'}))$ (resp. $ab \notin E_H(\eta_p(T_p), \eta_{p'}(T_{p'}))$), we check that there is a black edge (resp. a non-edge) between $x \in T_p$ and $y \in T_{p'}$ where x and y are the only vertices in $T_p \cup T_{p'}$ such that $a \in \eta_p(x)$ and $b \in \eta_{p'}(y)$. If both conditions of this paragraph are fulfilled, we put $\bigcup_{p \in [h]} S_p$ in cell $\mathcal{T}[T', \eta]$ (otherwise the content of this cell remains unchanged).

If we ever fill a cell $\mathcal{T}[T', \eta]$ where $\eta(T') = [k]$ with an actual solution S , **IndSub** reports S as an overall solution of the INDUCED SUBGRAPH ISOMORPHISM-instance. If after all the partial solutions in G_1 are computed (i.e., after we exit the outermost for loop in Algorithm 2),

¹⁴ In this definition, we do *not* require that T is connected in the red graph.

no such solution was reported, `IndSub` outputs that no solution exists. This terminates the description of `IndSub`. For `SubIso`, we just replace the occurrences of “induced subgraph” by “subgraph”. In the definition of the partial solutions, the mapping λ is now a (non-induced) subgraph isomorphism from $H[\eta(T)]$ to $G[S]$. In the update of the partial solutions, we also relax the $(\eta_p, \eta_{p'})$ -isomorphism to be a mere $(\eta_p, \eta_{p'})$ -*subisomorphism* preserving the edges of H , but not necessarily its non-edges. See Algorithm 2 for the pseudo-code of both algorithms.

■ **Algorithm 2** `IndSub`, `SubIso` by changing *isomorphic* to *subisomorphic* (line 11)

Input : A graph G , a d -sequence $G = G_n, \dots, G_1 = K_1$, and a graph H on $[k]$.
Output : A set S such that $G[S]$ and H are isomorphic, if it exists.

```

1 for  $v \in V(G)$  do
2   for  $j = 1 \rightarrow k$  do
3      $\mathcal{T}[\{v\}, \eta : v \mapsto \{j\}] \leftarrow \{v\}$ 
4 for  $i = n - 1 \rightarrow 1$  do
5    $u, v \leftarrow$  contracted pair in  $G_{i+1} \rightarrow G_i$ 
6    $z \leftarrow$  contraction of  $u$  and  $v$  in  $G_i$ 
7   for every vertex subset  $T$  connected in  $(V(G_i), R(G_i))$ , with  $z \in T$  and  $|T| \leq k$  do
8     for  $I \in \{\{u, v\}, \{u\}, \{v\}\}$  do
9       for every division  $\eta$  of  $T \setminus \{z\} \cup I$  do
10         $(T_1, \eta_1), \dots, (T_h, \eta_h) \leftarrow \text{dec}(T \setminus \{z\} \cup I, \eta)$ 
11        if  $\bigcup_{p \in [h]} \mathcal{T}[T_p, \eta_p] \neq \text{None}$  and  $H[\eta_p(T_p), \eta_{p'}(T_{p'})]$  is
12            $(\eta_p, \eta_{p'})$ -isomorphic to  $G[\mathcal{T}[T_p, \eta_p], \mathcal{T}[T_{p'}, \eta_{p'}]]$ ,  $\forall p \neq p' \in [h]$  then
13            $\eta' \leftarrow x \in T \setminus \{z\} \mapsto \eta(x)$ ,  $z \mapsto \eta(u) \cup \eta(v)$ 
14            $\mathcal{T}[T, \eta'] \leftarrow \bigcup_{p \in [h]} \mathcal{T}[T_p, \eta_p]$ 
15           if  $\eta'(T) = [k]$  then
16             return  $\mathcal{T}[T, \eta']$ 
16 return None
```

Correctness. The soundness and completeness of `IndSub` and `SubIso` follow as in the proof of Theorem 10. Therefore we only state the invariant maintained to show the completeness: After iteration i (note that the first iteration is actually iteration $n - 1$, and that the initialization is iteration n) of the outermost for loop, for every set $T \subseteq V(G_i)$ of size at most $|V(H)| = k$ connected in the red graph $(V(G_i), R(G_i))$, and every division η of T , if there is a (T, η) -compliant set S , then $\mathcal{T}[T, \eta]$ contains such a set S . In particular if we skip the possible exit of lines 14 and 15, after the last iteration (iteration 1), $\mathcal{T}[V(K_1), \eta : x \in V(K_1) \mapsto [k]]$ contains an actual set S (and not “None”) if and only if the (INDUCED) SUBGRAPH ISOMORPHISM-instance admits a solution. The only “new” element (compared to k -INDEPENDENT SET) to prove the invariant is the potential presence of black edges between red connected components. Nevertheless this was already evoked in the description of `IndSub` and is dealt with straightforwardly.

Running time. There are four nested for loops in Algorithm 2. The first one (outermost) brings a multiplicative n factor to the overall running time, the second, an d^{2k} factor (by Corollary 9), the third one, a factor 3. The fourth and innermost for loop ranges over all

the divisions of a fixed set T' of size at most k . (T' could in principle be of size $k + 1$, but such sets can be automatically discarded since they do not admit any division.) Every such division can be seen as a bijective mapping from T' to the parts of a partition of a subset of $V(H) = [k]$. There are at most $2^k B_k = 2^{O(k \log k)}$ partitions of a subset of $[k]$, where B_k is the k -th Bell number. Then there are at most $k^k = 2^{k \log k}$ bijections from T' to these parts. Thus there are at most $2^{O(k \log k)}$ divisions, and the last for loop incurs a $2^{O(k \log k)}$ factor.

Decomposing (T', η) and checking for a potential compliant solution can be done in time $k^{O(1)}$. Thus the overall running time of **IndSub** and **SubIso** is $2^{O(k \log k)} d^{2k} n = 2^{O_d(k \log k)} n$. Again it can be observed that even when d is polylogarithmic in n , this running time is FPT in k [37].

As in Theorem 10, a better practical algorithm (with similar worst-case running time) consists of building the partial solutions in G_i by unions of at most $\min(2, d + 1)$ partial solutions in G_{i+1} that are pairwise disconnected in the red graph and neighboring the vertices u and v . ◀

The r -SCATTERED SET problem on an input graph G is equivalent to k -INDEPENDENT SET on $G^{\leq r}$. The following theorem is a consequence that FO interpretations preserve bounded twin-width [5]. As $G^{\leq r}$ can be obtained by FO interpretation ϕ of size $O(r)$ on G , $\text{tww}(G^{\leq r}) \leq f(\text{tww}(G), r)$. Treating $d = \text{tww}(G)$ and r as constants, it is noteworthy that the complexity of r -SCATTERED SET remains the essentially optimal $2^{O(k)} n$.

► **Theorem 15.** *Given a graph G , a d -sequence $G = G_n, G_{n-1}, \dots, G_1 = K_1$, r -SCATTERED SET can be solved in time $2^{O_{d,r}(k)} n$.*

4 A practical algorithm for k -Dominating Set

We solve k -DOMINATING SET with a more involved instantiation of the scheme of the previous section. We face some new conceptual difficulties compared to the algorithm for k -INDEPENDENT SET. For one thing, the partial solutions that we maintain are not feasible solutions in the whole graph. Also we now consider balls of radius $f(d)k$ in the red graphs, and not merely of radius k . In general, the arguments are more subtle to handle partially and fully dominated vertex sets, as well as the solution trace. This entails a worse dependency in d , but the same essentially optimal $2^{O(k)} n$ when d is treated as a constant.

► **Theorem 16.** *Given an n -vertex graph G , a positive integer k , and a d -sequence $G = G_n, \dots, G_1 = K_1$, k -DOMINATING SET can be solved in time $O(2^{2(d^2+1)(2+\log d)k} n) = 2^{O_d(k)} n$.*

Proof. As was the case with k -INDEPENDENT SET, the algorithm sequentially considers each trigraph in the d -sequence G_n, \dots, G_1 starting from G_n , and inductively updates a set of optimal partial solutions of the trigraph G_i to yield the next set for G_{i-1} . We recall that $E(G_i)$ and $R(G_i)$ respectively refer to the black and red edge set of the trigraph G_i . The ball of radius at most r in the red graph $(V(G_i), R(G_i))$ centered at a vertex $x \in V(G_i)$ is denoted as $B_i^r(x)$.

Profile of a partial solution. A *profile (of a partial solution)* of G_i is a triple (T, D, M) of vertex sets of $V(G_i)$ such that (i) T forms a connected set in the red graph $(V(G_i), R(G_i))$, (ii) $D, M \subseteq T$, and (iii) $\bigcup_{x \in D} B_i^2(x) \subseteq T$. The first entry T of a profile $P = (T, D, M)$ is called the *ground set* of P , and the size of P is defined as the size of its ground set. A profile (T, D, M) is said to be a *k -profile* if $|D| \leq k$. When the profile under consideration is clear from the context, we denote $T \setminus D$ and $T \setminus M$ by \bar{D} and \bar{M} respectively.

We say that a profile (T, D, M) is realizable with $S \subseteq V(G)$ if the following conditions hold.

1. $S \subseteq \bigcup_{x \in T} x(G)$,
2. for every $x \in V(G_i)$, $x \in D$ if and only if $x(G) \cap S \neq \emptyset$, and
3. for every $x \in V(G_i)$, $x \in M$ if and only if $x(G)$ is (fully) dominated by S .

A profile is said to be *realizable* if there exists S with which it is realizable.

Suppose that $x, y \in V(G_{i+1})$ are contracted to yield G_i with z being the new vertex. For a vertex set $T \subseteq V(G_i)$ connected in the red graph $V(G_i, R_i)$ and containing z , let T_1, \dots, T_ℓ be the red connected components of $T' = (T \setminus z) \cup \{x, y\}$ in G_{i+1} , i.e. the partition of T' into maximal vertex sets each of which is connected in $V(G_{i+1}, R_{i+1})$. The number of these red subgraphs does not exceed $d + 2$ because each T_i either contains x or y , or one of the newly created red neighbors of z . Notice also that ℓ can be equal to 1, which means that x and y belong to the same connected component of $(V(G_{i+1}), R(G_{i+1}))$.

For a k -profile (T, D, M) of G_i such that $z \in T$, we say that a set $\mathcal{P} = \{(T_1, D_1, M_1), \dots, (T_\ell, D_\ell, M_\ell)\}$ of k -profiles of G_{i+1} is *consistent with* (T, D, M) if the following holds. Let $T' := (T \setminus z) \cup \{x, y\}$, $D' := \bigcup_{j=1}^{\ell} D_j$ and $M' := \bigcup_{j=1}^{\ell} M_j$.

1. The ground sets of the profiles in \mathcal{P} are precisely the red components of T' in G_{i+1} .
2. $D \setminus z = D' \setminus \{x, y\}$.
3. $z \in D$ if and only if $x \in D'$ or $y \in D'$.
4. For every $u \in T \setminus z$, $u \in M$ if and only if $u \in M'$ or there exists $v \in D'$ such that uv is a black edge in G_{i+1} .
5. $z \in M$ if and only if for each $u \in \{x, y\}$, it holds that: $u \in M'$ or there exists $v \in D'$ such that uv is a black edge in G_{i+1} .

Algorithm, and how to compute τ_i from τ_{i+1} . At each iteration along the d -sequence, we maintain one mapping τ_i from k -profiles $P = (T, D, M)$ of G_i with $|T| < (d^2 + 1)k$ to a subset of $\bigcup_{t \in T} t(G)$. The assignment $\tau_i(P) = nil$ is interpreted as that P is not realizable whereas $\tau_i(P) \neq nil$ is intended to be a minimum-size vertex set of $V(G)$ realizing P . Again let G_i be obtained by contracting the vertices $x, y \in V(G_{i+1})$ and z be the new vertex. Our goal is to compute τ_i from τ_{i+1} , assuming τ_{i+1} has been computed correctly. Note that a k -profile $P = (T, D, M)$ of G_i such that $z \notin T$ is also a profile of G_i , and trivially one is realizable with S if and only if the other is realizable with S . Therefore, τ_i simply inherits the assignment of τ_{i+1} in this case as depicted in lines 6-7.

If $P = (T, D, M)$ has z in its ground set, the algorithm **k-DomSet** inspects all sets \mathcal{P} of k -profiles of G_{i+1} consistent with (T, D, M) and among the unions $\bigcup_{P \in \mathcal{P}} \tau_{i+1}(P)$ over all such \mathcal{P} , outputs the best one as $\tau_i(T, D, M)$, that is, the one of minimum cardinality is chosen. If $\bigcup_{P \in \mathcal{P}} \tau_{i+1}(P) = nil$ for each consistent \mathcal{P} , the algorithm concludes that (T, D, M) is not realizable and assigns nil . The case when \mathcal{P} contains a k -profile P with ground set of size at least $(d^2 + 1)k$, a special step is taken as τ_{i+1} is not defined on such P . In this situation, a vertex $v \in T' \setminus \bigcup_{t \in D'} B_{i+1}^2(t)$ is chosen, and the query at $(T' \setminus v, D' \setminus v, M' \setminus v)$ is made instead. Lines 15-18 handle this case. The uniqueness of k -profile in \mathcal{P} in line 16 and the existence of such v in line 17 will be discussed in the correctness proof.

Correctness. To show the correctness of Algorithm 3, it suffices to prove the following.

- (\star) For every $i \in [n]$ and every k -profile P of G_i , we have $\tau_i(P) \neq nil$ if and only if P is realizable with a set of size at most k . Furthermore, if $\tau_i(P) \neq nil$, then $\tau_i(P)$ is a set of minimum size with which P is realizable.

We prove (\star) by induction. In the base case when $i = n$, the claim trivially holds. Assume $i < n$ and let x, y be the vertices of G_{i+1} which were contracted to yield G_i , where z is the

Algorithm 3 k -DomSet

Input : A graph G , a positive integer k , and a d -sequence $G = G_n, \dots, G_1 = K_1$.
Output: A dominating set of G of size at most k , or report *nil* (NO-instance).

- 1 **for** $v \in V(G_n)$ **do**
- 2 $\tau_n(\{v\}, \{v\}, \{v\}) = \{v\}$, $\tau_n(\{v\}, \emptyset, \emptyset) = \emptyset$, $\tau_n(P) = \text{nil}$ for all other k -profiles P
- 3 **for** $i = n - 1 \rightarrow 1$ **do**
- 4 $x, y \leftarrow$ contracted pair in $G_{i+1} \rightarrow G_i$
- 5 $z \leftarrow$ contraction of x and y in G_i
- 6 **for every** k -profile (T, D, M) of G_i of size less than $(d^2 + 1)k$ s.t. $z \notin T$ **do**
- 7 $\tau_i(T, D, M) \leftarrow \tau_{i+1}(T, D, M)$
- 8 **for every** k -profile (T, D, M) of G_i of size less than $(d^2 + 1)k$ s.t. $z \in T$ **do**
- 9 $\tau_i(T, D, M) \leftarrow \text{nil}$
- 10 $T' \leftarrow (T \setminus z) \cup \{x, y\}$
- 11 **for every set** \mathcal{P} of k -profiles of G_{i+1} consistent with (T, D, M) **do**
- 12 **if each** k -profile of \mathcal{P} has size less than $(d^2 + 1)k$ **then**
- 13 **if** $\tau_{i+1}(P) \neq \text{nil}$ for all $P \in \mathcal{P}$ **then**
- 14 $\tau_i(T, D, M) \leftarrow \text{best}\{\tau_i(T, D, M), \bigcup_{P \in \mathcal{P}} \tau_{i+1}(P)\}$
- 15 **else**
- 16 Let (T', D', M') be the unique k -profile contained in \mathcal{P} .
- 17 Choose $v \in T' \setminus \bigcup_{t \in D'} B_{i+1}^2(t)$
- 18 $\tau_i(T, D, M) \leftarrow \text{best}\{\tau_i(T, D, M), \tau_{i+1}(T' \setminus v, D' \setminus v, M' \setminus v)\}$
- 19 **if** $\tau_i(T, D, M) \neq \text{nil}$ and has size larger than k **then**
- 20 $\tau_i(T, D, M) \leftarrow \text{nil}$
- 21 **return** $\tau_1(V(G_1), V(G_1), V(G_1))$

newly obtained vertex of G_i . By induction hypothesis, for any k -profile (T, D, M) of G_i with $z \notin T$ the claim holds as it is a k -profile of G_{i+1} as well.

Therefore, we assume that $z \in T$ and let $T' = (T \setminus z) \cup \{x, y\}$.

▷ **Claim 17.** Assume that (\star) holds for all $i' > i$ and let $P = (T, D, M)$ be a k -profile of G_i . If P is realizable with a set of size at most k , then $\tau_i(P) \neq \text{nil}$.

PROOF OF THE CLAIM: Suppose that $P = (T, D, M)$ is realizable with $S \subseteq V(G)$ of size at most k . Let T_1, \dots, T_ℓ be the red connected components of T' in G_i , and let $S_j = S \cap \bigcup_{t \in T_j} t(G)$ for every $j \in [\ell]$. The pairs T_j and S_j for $j = 1, \dots, \ell$ define a set of ℓ k -profiles (T_j, D_j, M_j) of G_{i+1} in a canonical way: D_j is precisely the set of vertices $t \in T_j$ such that $t(G) \cap S_j$ and M_j is the set of vertices $t \in T_j$ such that $t(G)$ is (fully) dominated by S_j . By construction, each k -profile (T_j, D_j, M_j) is realizable with S_j .

We argue that the set $\mathcal{P} = \{(T_j, D_j, M_j) : j \in [\ell]\}$ is consistent with $P = (T, D, M)$. The first and the second conditions for consistency are clearly satisfied. To verify the third condition, consider a vertex $u \in T$ distinct from z and without loss of generality we assume $u \in T_{j^*}$. If $u \in M$ and $u \notin M_{j^*}$, this means that S_{j^*} does not dominate $u(G)$ because S_{j^*} realizes $(T_{j^*}, D_{j^*}, M_{j^*})$. From $u \in M$ and the fact that S realizes (T, D, M) , we know that S dominates $u(G)$ and thus there is at least one vertex $S \setminus S_{j^*}$ which is adjacent (in G) with some vertex of $u(G)$. Consider an arbitrary vertex $v \in T$ to which some of $S \setminus S_{j^*}$ contracts to, and observe that $v \notin T_{j^*}$. This means that uv is a black edge. The converse direction of the third condition is clearly met. The fourth condition of consistency can be verified similarly as the third condition.

If \mathcal{P} does not contain any k -profile whose ground set has size at least $(d^2 + 1)k$, now the claim is immediate because each (T_j, D_j, M_j) is realizable with S_j : by induction hypothesis, we have $\tau_{i+1}(T_j, D_j, M_j) \neq \text{nil}$, and thus $\tau_i(T, D, M)$ is set to $\neq \text{nil}$ at line 14.

Suppose that \mathcal{P} contains a k -profile whose ground set has size at least $(d^2 + 1)k$. One can easily see that in this case, $\ell = 1$ or equivalently T' is a red connected component in $(V(G_{i+1}), R(G_{i+1}))$ consisting of exactly $(d^2 + 1)k$ vertices. Since the union of at most k balls of radius at most 2 which is connected in $(V(G_{i+1}), R(G_{i+1}))$ have less than $(d^2 + 1)k$ vertices, there exists $v \in T' \setminus \bigcup_{t \in D'} B_{i+1}^2(t)$. Moreover, by the choice of v , $(T' \setminus v, D' \setminus v, M' \setminus v)$ is now a k -profile of G_{i+1} . To conclude that $\tau_i(T, D, M) \neq \text{nil}$, it suffices to prove that $\tau_{i+1}(T' \setminus v, D' \setminus v, M' \setminus v) \neq \text{nil}$. We do this by showing that (T, D, M) , (T', D', M') and $(T' \setminus v, D' \setminus v, M' \setminus v)$ are equivalent in regards to realizability.

The equivalence of the first two is obvious. For the equivalence of the last two, note that if S realizes (T', D', M') , S does not intersect $v(G)$, and thus S trivially realizes $(T' \setminus v, D' \setminus v, M' \setminus v)$. Conversely, suppose that $(T' \setminus v, D' \setminus v, M' \setminus v)$ is realizable with S' . The crucial observation is that v has no red neighbor in D' since otherwise, v belongs to the union $\bigcup_{t \in D'} B_{i+1}^2(t)$, contradicting the choice of v . Therefore, we know that $v \in M'$ if and only if there exists $u \in D' \setminus v$ such that uv is a black edge. In the case when $v \in M'$, there exists a black neighbor $u \in D' \setminus v$ of v , and any S' realizing $(T' \setminus v, D' \setminus v, M' \setminus v)$ intersects $u(G)$. It follows that S' fully dominates $v(G)$ and S' realizes (T', D', M') . Else if $v \notin M'$, this means that not only the red neighbors of v are disjoint from D' but also no black neighbor of v is contained in D' . As a consequence $v(G)$ is not dominated by S' , thus S' realizes (T', D', M') . This proves the equivalence of (T', D', M') and $(T' \setminus v, D' \setminus v, M' \setminus v)$, and completes the proof of the claim. \diamond

To establish the other direction, suppose that $\tau_i(T, D, M) \neq \text{nil}$ and let \mathcal{P}^* be the set consistent with P such that $\tau_i(T, D, M) = \bigcup_{P \in \mathcal{P}^*} \tau_{i+1}(P)$ or $\tau_i(T, D, M) = \tau_{i+1}(T' \setminus v, D' \setminus v, M' \setminus v)$ for some v . Such \mathcal{P}^* clearly exists since otherwise only nil can be output. In the

former case, it is tedious to verify that if each (T_i, D_i, M_i) of \mathcal{P}^* is realizable with S_i , then $\bigcup_{i \in [l]} S_i$ realizes (T, D, M) .

In the latter case, we simply recall that (T, D, M) and $(T' \setminus v, D' \setminus v, M' \setminus v)$ are equivalent in regards to realizability. This completes the proof of the first statement of (\star) . The second statement immediately follows.

Running time. In an actual implementation of Algorithm 3, we maintain a single mapping τ . As we proceed from G_{i+1} to G_i , we modify the domain of τ consisting of k -profiles so that new k -profiles involving z are added and after calculating the assignments for the new k -profiles, all the domains and corresponding assignments involving x or y shall be discarded. Therefore, it suffices to check the running time for updating τ , which is performed in the inner loop of lines 6-20. By Corollary 9, there are $O(d^{2(d^2+1)k-2} \cdot 2^{2(d^2+1)k})$ new profiles of G_i to compute. For each k -profile (T, D, M) with $z \in T$, the ground sets T_1, \dots, T_ℓ of a potentially consistent set \mathcal{P} is already determined. Hence, we exhaust all possibilities of appending each T_i by M_i and D_i to form a k -profile and the inner loop of 8-20 will consider at most $2^{(d^2+1)k} \cdot 2^{(d^2+1)k}$ sets \mathcal{P} . The consistency of \mathcal{P} with (T, D, M) can be routinely verified. This establishes the claimed running time. \blacktriangleleft

5 Bounded twin-width classes are χ -bounded

So far, our algorithms followed the same recipe: Initialize partial solutions on single-vertex sets, stitch together a bounded number of partial solutions when they become connected in the red graph after the current contraction, and conclude with the partial solutions on the last (1-vertex) graph of the sequence. This is the original scheme of Guillemot and Marx [27], and of our model checking algorithm [5].

We now present a novel use of the contraction sequence. It consists of starting at the end, when all the vertices are contracted on a single vertex, and rewinding the sequence. The single vertex is first “split” into two vertices (linked by a black or red edge if G is connected). Then one of these two vertices is split into two new vertices, and so on. Typically, at first, edges are mostly red. As the vertex partition gets finer, black edges start appearing (eventually all edges are black). In this direction of time, black edges are irreversible: When a black edge first appears between x and y in $V(G_i)$, it stays or rather spreads into the biclique $(x(G), y(G))$. We use this new viewpoint to color triangle-free graphs of bounded twin-width with a constant number of colors. We show that the newly split vertices can be greedily colored, while the rest of the colors remains unchanged. Importantly for coloring, in a triangle-free graph, when a black edge appears between x and y we know that both sides $x(G)$ and $y(G)$ of the biclique are independent sets.

The following coloring procedure essentially contains the χ -boundedness of bounded twin-width classes. Despite its simplicity, this for instance generalizes the non-trivial result that bounded rank-width classes are χ -bounded [16]. The proof that graphs with bounded rank-width have bounded twin-width, presented in [5], is also elementary.

► **Theorem 18.** *Every triangle-free graph with twin-width at most d is $d + 2$ -colorable.*

Proof. Let G be an n -vertex triangle-free graph of twin-width at most d , and let $G = G_n, \dots, G_1 = K_1$ be a d -sequence of G . We show how to color G with $d + 2$ colors starting from G_1 , and iteratively coloring G_{i+1} based on the coloring of G_i . We give the unique vertex of $G_1 = K_1$ color 1. This defines coloring C_1 . For every i from 1 to $n - 1$, let z be the vertex of G_i split into $u, v \in V(G_{i+1})$. In coloring C_{i+1} , every vertex of $V(G_{i+1}) \setminus \{u, v\}$ keeps the color it received by C_i . Vertex u receives color $C_i(z)$. Finally, v receives color $C_i(z)$ if uv

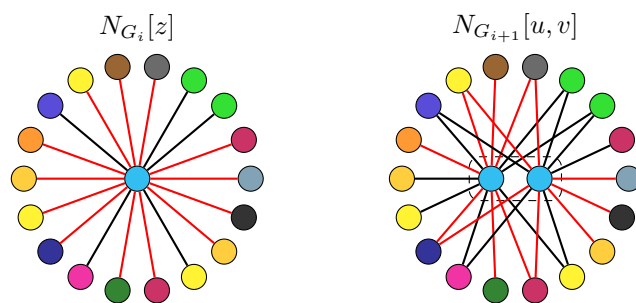

■ **Figure 3** Split, when z is incident to a black edge in G_i . As G is triangle-free, there cannot be an edge (red or black) between u and v . Thus both u and v can take the color of z , which does not appear in their neighborhood.

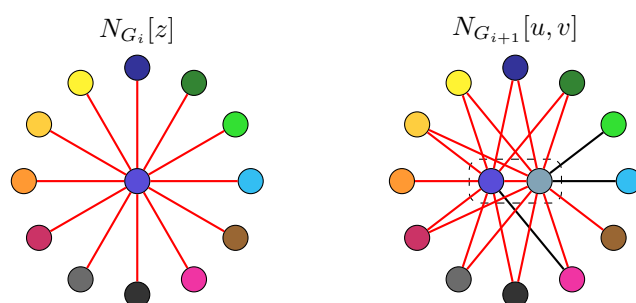

■ **Figure 4** Split, when z is only incident to red edges. Even if the red neighbors of z have d distinct colors, vertex v can find a color in $[d+2]$ which avoids these d colors plus the color of z and u .

is a non-edge in G_{i+1} , and the smallest positive integer *not* appearing in its neighborhood (black *and* red neighbors) in G_{i+1} , otherwise. We will now show that C_n is a proper coloring of G using at most $d+2$ distinct colors.

We show by induction on i that C_i is a proper $d+2$ -coloring of the graph $G'_i := (V(G_i), E(G_i) \cup R(G_i))$. Coloring C_1 is indeed proper in G'_1 and uses $1 \leq d+2$ color. We assume that C_i is a proper $d+2$ -coloring of G'_i , and distinguish two cases. If there is a black edge $yz \in E(G_i)$ (recall that z is the vertex split into u, v), then uv has to be a non-edge in G_{i+1} . Otherwise there is at least one edge between $u(G)$ and $v(G)$, and this edge forms a triangle with any vertex in $y(G)$. Thus in that case, $C_{i+1}(u) = C_{i+1}(v) = C_i(z)$. So the number of distinct colors given by C_{i+1} is still at most $d+2$ (see Figure 3). And C_{i+1} is a proper coloring of G'_{i+1} since $N_{G'_{i+1}}(\{u, v\}) = N_{G'_i}(z)$. If instead z has only red neighbors in G_i , then z has at most d neighbors in G'_i . Furthermore let us assume that $uv \in E(G'_{i+1})$, otherwise we conclude as previously. In that case, v is properly colored by C_{i+1} in G'_{i+1} by construction, and vertex u as well, since $N_{G'_{i+1}}(u) \setminus \{v\} \subseteq N_{G'_i}(z)$. Finally $C_{i+1}(v)$ is the smallest positive integer not appearing in a set of at most $d+1$ positive integers. Thus $C_{i+1}(v) \leq d+2$, and C_{i+1} is overall a proper $d+2$ -coloring of G'_{i+1} (see Figure 4).

In particular, C_n is a proper $d+2$ -coloring of $G'_n = G_n = G$. ◀

As a side note, it is, to our knowledge, possible that every triangle-free K_t -minor free graph has twin-width $O(t)$. If this turns out to be true, it offers a seemingly different approach to getting improved bounds in the triangle-free case of the Hadwiger's conjecture: Instead of trying to color these graphs, one could try to design contraction sequences for them.

We now show how to color any K_t -free graph G given with a d -sequence, with at most $(d+2)^{t-2}$ colors. We use the scheme of Theorem 18 and color some induced subgraphs of G by induction on t .

► **Theorem 19.** *For every integer $t \geq 3$, every K_t -free graph with twin-width at most d is $(d+2)^{t-2}$ -colorable.*

Proof. Let G_n, \dots, G_1 be a d -sequence of a K_t -free graph G with $t \geq 3$. In Theorem 18, whenever a vertex $x \in V(G_{i+1})$ was incident to a black edge for the first time (going from G_1 to G_n), the color of all the vertices in $x(G)$ was eventually set to the same value, namely $C_{i+1}(x)$. Now such a set $x(G)$ is not necessarily an independent set, but rather induces a K_{t-1} -free graph. Indeed, a K_{t-1} in $G[x(G)]$ would form a K_t in G with any vertex of $y(G)$, where $xy \in E(G_{i+1})$. By induction on t , we may color $G[x(G)]$ with tuples of at most $t-3$ integers of $[d+2]$, and prepends $C_{i+1}(x)$ to these tuples. The base case $t=3$ is Theorem 18. We make the general idea a bit more precise.

For every $i \in [n]$, we define G_i^* as the graph obtained from G_i by blowing every vertex $x \in V(G_i)$ into $G[x(G)]$ whenever x is incident to a black edge, and then turning every red edge into a black edge. We define the successive colorings C'_1, \dots, C'_n of G_1^*, \dots, G_n^* , respectively, following the algorithm of Theorem 18. While there are no black edge in the current trigraph G_i , we set $C'_i := C_i$, where C_i is the coloring in the triangle-free case. Say, at least one black edge appears for the first time in G_{i+1} (this is well-defined since G_n has only black edges). Again we adopt the convention that $z \in V(G_i)$ was split into $u, v \in V(G_{i+1})$. Let S be the set of (at most $d+2$) vertices with an incident black edge in G_{i+1} . (One may notice that $S \subseteq \{u, v\} \cup N_{G_i}(z)$ and $S \cap \{u, v\} \neq \emptyset$.) Every vertex $w \in V(G_{i+1}) \setminus S$ receives color $C_{i+1}(w)$. As we observed, for every $x \in S$, $G[x(G)]$ is K_{t-1} -free. By induction there is a coloring C^x of $G[x(G)]$ with tuples of at most $t-3$ integers from $[d+2]$. We permanently color every vertex $y \in x(G)$ by $(C_{i+1}(x), C^x(y))$. This defines the coloring C'_{i+1} of G_{i+1}^* .

We continue to follow Theorem 18, with the ensuing precisions. We go through all the splits, including the ones between two permanently colored vertices, since they may make some other vertices incident to a black edge for the first time. If the split vertex $z \in V(G_j)$ is *not* such that $z(G)$ was already permanently colored, the colors of the new vertices $u, v \in V(G_{j+1})$ are chosen according to the rules of Theorem 18 where we consider the trigraphs G_j and G_{j+1} (and not the graphs G_j^* and G_{j+1}^*), and the coloring C_j of $V(G_j)$ is defined as: $C_j(y)$ is the first coordinate of $C'_j(y)$ (or $C'_j(y)$ itself if it is not a tuple) if $y \in V(G_j^*)$, and the first coordinate of the color of any vertex in $y(G)$, otherwise. (One may observe that C_j is *not* necessarily a proper coloring of $(V(G_j), E(G_j) \cup R(G_j))$, but all the conflict edges lie within a permanently colored subgraph.) Every time a vertex x becomes incident to a black edge, we permanently color $x(G)$. This defines the sequence of colorings C'_1, \dots, C'_n .

We show by induction on i that C'_i properly colors G_i^* . Coloring C'_1 is indeed a proper coloring of $G_1^* = K_1$. We assume that C'_i is a proper coloring of G_i^* , and let xy be any edge in $E(G_{i+1}^*)$. By the outermost induction on t , if xy lies within a K_{t-1} -free graph permanently colored, then $C'_{i+1}(x) \neq C'_{i+1}(y)$. If instead x and y belong to two distinct vertices of G_{i+1} , by the proof of Theorem 18 and the fact that C'_i is a proper coloring of G_i^* , the first coordinate of $C'_{i+1}(x)$ and of $C'_{i+1}(y)$ differ.

In particular C'_n is a proper coloring of $G_n^* = G_n = G$. We pad every tuple $C'_n(x)$ of length $t' < t$ with $t-t'$ entries 1. From the previous proof, it can be observed that this new coloring of G is still proper, and uses at most $(d+2)^{t-2}$ colors. ◀

Theorem 19 directly implies that, provided $O(1)$ -sequences are given, MIN COLORING

can be $2^{O(\text{OPT})}$ -approximated on bounded twin-width graphs, and MAX INDEPENDENT SET can be $O(1)$ -approximated on K_t -free graphs of bounded twin-width (trivially because an independent set of size $n/O(1)$ can be found). In Sections 7.2 and 8.2 we discuss further the approximability of MIS in bounded twin-width graphs.

It would be interesting to determine if bounded twin-width classes are polynomially χ -bounded, that is, satisfies for some constant c , $\chi(G) = O(\omega(G)^c)$ for every graph G in the class. Bounded clique-width or rank-width classes were shown polynomially χ -bounded only recently [3]. We show however that bounded twin-width classes satisfy the related *strong Erdős-Hajnal property*. We recall that a class \mathcal{C} of graphs satisfies the *strong Erdős-Hajnal property* if there exists an $\varepsilon > 0$ such that every $G \in \mathcal{C}$ contains two disjoint subsets of vertices X, Y , both of size at least $\varepsilon|V(G)|$, with either all edges or no edges between X and Y . The strong Erdős-Hajnal property of a hereditary class implies the existence of a clique or a stable set of polynomial size, that is, the Erdős-Hajnal property [1].

► **Theorem 20.** *The class of graphs with twin-width at most d satisfies the strong Erdős-Hajnal property with $\varepsilon = 1/(d + 4)$.*

Proof. Let G be an n -vertex graph with twin-width at most d . Consider in a fixed d -sequence G_n, \dots, G_1 the maximum index i such that there is a vertex $z \in V(G_i)$ satisfying $|z(G)| \geq n/(d + 4)$. Since $X := z(G)$ is the union of $u(G)$ and $v(G)$ for some $u, v \in V(G_{i+1})$, its size is at most $2n/(d + 4)$. Vertex z has at most d red neighbors in G_i . These neighbors constitute a set $S \subseteq V(G)$ of at most $d \cdot n/(d + 4)$ vertices. Thus $|V(G) \setminus (z(G) \cup S)| \geq n - 2n/(d + 4) - dn/(d + 4) = 2n/(d + 4)$. By construction, every vertex in $V(G) \setminus (z(G) \cup S)$ is fully adjacent to X or fully non-adjacent to X . Let $Y \subseteq V(G) \setminus (z(G) \cup S)$ be the subset of all vertices in the majority regarding these two outcomes. Set Y has size at least $n/(d + 4)$ vertices and X, Y is therefore an appropriate pair. ◀

6 Interval biclique partitions and computing shortest paths

In this section, we show how to build on the viewpoint of the previous section to compute shortest paths efficiently. We first show that bounded twin-width graphs admit favorable edge partitions into linearly many bicliques.

An *interval biclique partition* (or *IBP*, for short) of a graph G on vertex set $[n]$ is a set \mathcal{B} of bicliques that edge-partitions G where each biclique $(A_i, B_i) \in \mathcal{B}$ is such that both *sides* A_i and B_i are two (disjoint) discrete intervals of $[n]$ (see Figure 5). Observe that the latter condition makes interval biclique partitions a more restricted form of the mere biclique (edge-)partitions. However every graph admits an IBP, since a biclique of \mathcal{B} can be a single edge of G . Such an edge-partition becomes interesting when the number of bicliques in \mathcal{B} is small, say, at most linear in the number of vertices. We will show that bounded twin-width graphs admit linear-sized IBPs. To give an example, the clique K_n admits $\{([1], [2, n]), ([2], [3, n]), ([3], [4, n]), \dots, ([n - 1], [n])\}$ as an IBP. The IBP \mathcal{B} gives a $4\lceil \log n \rceil |\mathcal{B}|$ -bits representation of the graph.

The *ordered union tree* of a d -sequence $\mathcal{S} : G = G_n, \dots, G_1 = K_1$, is a pair $(\mathcal{T}, \mathcal{A})$ where \mathcal{T} is a rooted binary tree whose leaves are in one-to-one correspondence with $V(G)$, and \mathcal{A} is an array of length $n - 1$ whose i -th entry is a pointer to the (distinct) internal node of \mathcal{T} representing the i -th contraction of \mathcal{S} , i.e., whose rooted subtree has for leaves all the vertices of G “contained” in the contracted vertex. Our algorithms in [5, 4] can output an ordered union tree in the same running time as for computing the d -sequence. The ordered union tree can thus be seen as an alternative way of presenting the d -sequence.

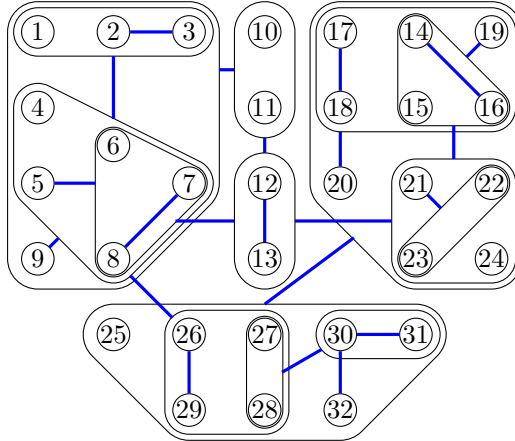

■ **Figure 5** Example of an interval biclique partition following a contraction sequence. The bicliques are represented in bold blue. See Figure 6 for a part of the corresponding union tree.

► **Lemma 21.** *Every n -vertex graph of twin-width d has an interval biclique partition \mathcal{B} of size at most $(d + 1)(n - 1)$. Furthermore \mathcal{B} can be computed in time $O(dn) = O_d(n)$ given the ordered union tree of a d -sequence for G .*

Proof. We relabel the nodes of the tree starting from the leaves. From left to right, their label now describes the integers from 1 to n (see Figure 6). An internal node gets label $[i, j]$ if the leaves of its subtree precisely form the interval $[i, j]$. This step can be done in $O(n)$ -time.

Now we read the d -sequence backwards, starting from the end $G_1 = K_1$, and tracking black edges appearing for the first time. Let $u, v \in V(G_{i+1})$ be obtained by splitting $z \in V(G_i)$. Formally we say that a *black edge* $xy \in E(G_{i+1})$ *appears for the first time* in G_{i+1} , if xy is not a black edge of G_i (this implies that $\{x, y\} \cap \{u, v\} \neq \emptyset$) and xy is not of the form uy or vy with $zy \in E(G_i)$. Intuitively, not only the black edge is new, but it did not originate from a black edge $zy \in E(G_i)$. Note that the latter automatically creates two black edges $uy, vy \in E(G_{i+1})$, but the information carried by these edges is contained in the biclique $(y(G), z(G))$ already detected.

At each of the $n - 1$ steps, at most $d + 1$ black edges can appear for the first time: possibly one between the two vertices u, v , and at most one between $\{u, v\}$ and every red neighbor of z in G_i . We append the corresponding bicliques to \mathcal{B} . This takes overall time $O(dn)$, and shows that $|\mathcal{B}| \leq (d + 1)(n - 1)$. By the previous relabeling, the two sides of the bicliques are discrete intervals. By the final observation in the previous paragraph, the bicliques of \mathcal{B} cover all the edges of G . By the definition of a “black edge appearing for the first time”, no edge is covered twice, so \mathcal{B} is indeed a biclique partition of $E(G)$. ◀

An interesting additional property of the computed IBP \mathcal{B} , in the case of bounded twin-width graphs, is that the whole set of biclique sides (partite sets) defines a laminar family. Indeed, by definition of a contraction sequence, there cannot be two overlapping sides. Our algorithm will not use this additional property.

For the next algorithm, the interval biclique partition \mathcal{B} is stored in a look-up table \mathcal{Z} . One accesses in constant time, with $\mathcal{Z}[A]$, the head of the list of sides B such that (A, B) or (B, A) is in \mathcal{B} . The table \mathcal{Z} can be initialized in time $O(|\mathcal{B}|)$, given the list of bicliques \mathcal{B} .

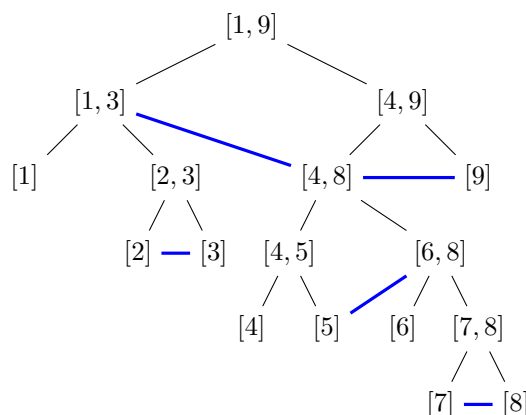

■ **Figure 6** The subtree $[1, 9]$ of the union tree corresponding to the graph and sequence of Figure 5. The bicliques of the IBP are represented in bold blue. The order of the splits does not appear.

► **Theorem 22.** *Given an IBP \mathcal{B} of an n -vertex graph G and a vertex $s \in V(G)$, SINGLE-SOURCE SHORTEST PATHS can be solved in time $O((n + |\mathcal{B}|) \log n)$.*

Proof. Essentially we will perform a breadth-first search (BFS) from vertex s , following the bicliques instead of single edges.

To start with, we need a quick access to all the bicliques of \mathcal{B} containing a given vertex $u \in V(G)$. As the sides of the bicliques are intervals, we in fact want to solve the interval stabbing problem: Preprocess a set \mathcal{I} of intervals to answer queries of the form “list all intervals of \mathcal{I} containing p ”. For instance, if we query vertex 21 of Figure 5, we want the fast output of the list of intervals $[14, 24]$, $[21, 24]$, $[21]$. That way we can then get the neighborhood of 21 in the compact form $[12, 13]$, $[14, 16]$, $[22, 23]$, $[25, 32]$. Since our intervals range over $[n]$, there are optimal *static* data structures for that problem, with preprocessing time $O(n)$ and query time $O(q)$ where q is the number of output intervals and n is the total number of intervals (see for instance [36] and [7]). To our knowledge, there is no dynamic version of these data structures that would further support deletions in time $o(\log n)$, let alone in constant amortized time. However it will be crucial in our algorithm to remove intervals. We thus accept to pay an extra logarithmic factor, and resolve to the simpler use of self-balancing binary search trees such as red-black trees [8]. Red-black trees take $O(n \log n)$ to build (by n successive insertions in time $O(\log n)$), and support search queries in $O(\log n + q)$ and deletions in $O(\log n)$. Here the search queries are of the form: “list all nodes (intervals) containing a query element or intersecting a query interval”.

We maintain two red-black trees. The first, $\mathcal{T}_{\mathcal{B}}$, is initialized to the $2|\mathcal{B}|$ nodes of $\{A, B \mid (A, B) \in \mathcal{B}\}$, that is the sides of the bicliques of the IBP. These intervals are sorted by lexicographic order on their pairs of endpoints. This tree will maintain which bicliques are still untraversed in a given direction (we will distinguish the two orientations). The second, \mathcal{T}_U , initially comprises the n vertices in $V(G) = [n]$, sorted in the usual order. (The integers can be seen as singleton intervals to unify $\mathcal{T}_{\mathcal{B}}$ and \mathcal{T}_U into the same kind of objects.) It will maintain which vertex of G are still unexplored.

The primitive $\text{Bel}(u, \mathcal{T}_{\mathcal{B}})$ (as in *belongs*) reports all the biclique sides $S \in \mathcal{T}_{\mathcal{B}}$ such that $u \in S$, while $\text{Adj}(u, \mathcal{T}_{\mathcal{B}})$ (as in *adjacency*) reports the set of biclique sides $B \in \mathcal{T}_{\mathcal{B}}$ such that there is a biclique $(A, B) \in \mathcal{B}$ with $u \in A$. Finally $\text{Int}(\mathcal{T}_U, [i, j])$ (as in *intersection*) lists all the elements of \mathcal{T}_U that are in $[i, j]$, and we denote by $\text{delete}(u, \mathcal{T})$ the deletion of u from the red-black tree \mathcal{T} .

We can now write our algorithm SINGLE-SOURCE SHORTEST PATHS from a classic BFS, by replacing the access to edges of the current vertex u by $\text{Adj}(u, \mathcal{T}_B)$, and the vertices to enqueue (and explore later) by $\bigcup_{[i,j] \in \text{Adj}(u, \mathcal{T}_B)} \text{Int}(U, [i, j])$. More precisely, we initialize a queue Q to $\{s\}$, a set of unexplored vertices U to $V(G) \setminus \{s\}$ as a red-black tree \mathcal{T}_U , a set of unaccessed biclique sides of \mathcal{B} as another red-black tree \mathcal{T}_B , a shortest-path tree parent relation p by $p(s) := s$, and a distance table d to the source s by $d(s) := 0$. We remove s from \mathcal{T}_U . As long as Q is non-empty, we dequeue u from it, and set $\mathcal{S}_u := \text{Bel}(u, \mathcal{T}_B)$, and $\mathcal{N}_u := \text{Adj}(u, \mathcal{T}_B)$. We remove all the biclique sides of \mathcal{S}_u from \mathcal{T}_B . We set $N_u := \bigcup_{[i,j] \in \mathcal{N}_u} \text{Int}(\mathcal{T}_U, [i, j])$. For every $v \in N_u$, we set $p(v)$ to u , $d(v)$ to $d(u) + 1$, we enqueue v in Q , and remove it from \mathcal{T}_U . We finally return p and d (see Algorithm 4 for the pseudo-code).

■ **Algorithm 4** SSSP

Input : A graph G , a source $s \in V(G)$, and an interval biclique partition \mathcal{B} of G .
Output: A shortest-path tree p rooted at s , with a distance table d to s .

- 1 $\mathcal{T}_U \leftarrow V(G)$
- 2 $\mathcal{T}_B \leftarrow \{A, B \mid (A, B) \in \mathcal{B}\}$
- 3 $Q \leftarrow \{s\}$
- 4 $p(s) \leftarrow s$
- 5 $d(s) \leftarrow 0$
- 6 $\text{delete}(s, \mathcal{T}_U)$
- 7 **while** $Q \neq \emptyset$ **do**
- 8 $u \leftarrow \text{dequeue}(Q)$
- 9 $\mathcal{S}_u \leftarrow \text{Bel}(u, \mathcal{T}_B)$
- 10 $\mathcal{N}_u \leftarrow \text{Adj}(u, \mathcal{T}_B)$
- 11 **for** $S \in \mathcal{S}_u$ **do**
- 12 $\text{delete}(S, \mathcal{T}_B)$
- 13 $N_u \leftarrow \bigcup_{[i,j] \in \mathcal{N}_u} \text{Int}(\mathcal{T}_U, [i, j])$
- 14 **for** $v \in N_u$ **do**
- 15 $p(v) \leftarrow u$
- 16 $d(v) \leftarrow d(u) + 1$
- 17 $\text{enqueue}(Q, v)$
- 18 $\text{delete}(v, \mathcal{T}_U)$
- 19 **return** p, d

Correctness. Our algorithm is a BFS in which some edges that are not traversed may still disappear in one direction (line 12). We only need to argue that these arcs cannot be part of a shortest-path tree rooted at s . Say the current vertex is u , and the set of unexplored vertices is U (i.e., the nodes of \mathcal{T}_U). We consider the set $\mathcal{S}_u := \text{Bel}(u, \mathcal{T}_B)$ of biclique sides still in \mathcal{T}_B and containing u . All these intervals are then removed from \mathcal{T}_B . Let $u' \neq u$ be a vertex in a side $S \in \mathcal{S}_u$, and let S' be another side such that $(S, S') \in \mathcal{B}$. The deletion of \mathcal{S}_u implies that an arc from S to S' can no longer be taken. We claim that it is safe to remove the arcs from u' (or more generally from S) to S' . Indeed if u' is visited after u , then $d(u) \leq d(u')$. Thus all the vertices in $N_u \supseteq S' \cap U$ have already had their distance set to $d(u) + 1$ ($\leq d(u') + 1$) and their parent set to u .

Note however that the biclique (S', S) may still be traversed (in the other direction, from S' to S). These arcs can very well be on a shortest-path tree. That is why we are removing biclique sides and not bicliques.

Running time. The initialization of \mathcal{T}_U and \mathcal{T}_B takes time $O(n \log n)$ and $O(|\mathcal{B}| \log |\mathcal{B}|) = O(|\mathcal{B}| \log n)$, respectively (observe that $|\mathcal{B}| \leq n^2$, thus $O(\log |\mathcal{B}|) = O(\log n)$). Each call $\text{Bel}(u, T_B)$ reporting q sides takes time $O(\log n + q)$. It is immediately followed by the deletion of these sides from \mathcal{T}_B , in time $O(q \log n)$. Therefore in the entire while loop, these operations take overall time $O(|\mathcal{B}| \log n)$. Observe that $\text{Adj}(u, T_B)$ is built from $\text{Bel}(u, T_B)$ by simple access to the look-up table \mathcal{Z} encoding \mathcal{B} . This takes time $O(|\text{Adj}(u, T_B)|)$. Since every biclique can be traversed at most twice (once in each direction), overall the calls $\text{Adj}(u, T_B)$ take time $O(|\mathcal{B}|)$. Each call $\text{Int}(\mathcal{T}_U, [i, j])$ reporting q vertices takes time $O(\log n + q)$. This is followed by removing these vertices from \mathcal{T}_U in time $O(q \log n)$. Hence this part takes overall time $O(n \log n)$. The rest of the instructions take constant time. Therefore the running time of SSSP is $O((n + |\mathcal{B}|) \log n)$. ◀

As a direct corollary of Lemma 21 and Theorem 22, we get the following two theorems.

▶ **Theorem 23.** *Let \mathcal{C} be a class of bounded twin-width on which there is an $O_d(n \log n)$ -time algorithm computing d -sequences for n -vertex graphs. Then SINGLE-SOURCE SHORTEST PATHS can be solved in \mathcal{C} in time $O_d(n \log n)$.*

▶ **Theorem 24.** *Let \mathcal{C} be a class of bounded twin-width on which there is an $O_d(n^2 \log n)$ -time algorithm computing d -sequences for n -vertex graphs. Then ALL-PAIRS SHORTEST PATHS can be solved in \mathcal{C} in time $O_d(n^2 \log n)$.*

Note that for all the classes shown to have bounded twin-width in the first two papers of the series [5, 4], an $O_d(n^2)$ -time algorithm computes a d -sequence (where d does not depend on n). For some sparse classes (K_t -minor free graphs), or some dense classes sparsely presented (unit interval graphs, posets of bounded antichain), it is even possible to obtain the contraction sequence in time $O_d(n \log n)$. For the latter kind, it yields $O(n \log n)$ -time algorithms (that is, sublinear in the number of edges) computing shortest-path trees from a given source. However in these individual classes, much simpler arguments would give $O(n)$ -time algorithms. Thus the strength of Theorems 23 and 24 lies more in unifying and generalizing graph classes where $\tilde{O}(n)$ and $\tilde{O}(n^2)$ are achievable for SSSP and APSP, and in the simplicity of the algorithm (a slightly modified BFS).

One could wonder if the diameter of a graph given with an $O(1)$ -sequence can be computed significantly faster than in $O(n^2 \log n)$, by simply calling APSP and reporting the longest distance. We observe that no truly subquadratic algorithm is possible, unless the Strong Exponential Time Hypothesis¹⁵ (SETH) fails.

▶ **Theorem 25.** *For every $\varepsilon, \varepsilon' > 0$, DIAMETER on bounded twin-width graphs cannot be computed, or $3/2 - \varepsilon'$ -approximated, in time $n^{2-\varepsilon}$, unless the SETH fails, even if an $O(1)$ -sequence of the input graph is given.*

Proof. Such an SETH lower bound exists on graphs of bounded degree (see [20]). We subdivide $\ell - 1$ times each edge of a hard instance H , with degree bounded by Δ and $n' > 1$ vertices, where $\ell := \lceil \log n' \rceil$. We attach a pending path on ℓ edges to the n' original vertices of H . This defines a graph G with $n \leq \Delta/2 \cdot (\ell - 1)n' + \ell n' = O(n' \log n')$ vertices. Thus $n = O(n'^{1+\frac{\varepsilon}{2}})$. We observe that $\text{diam}(G) = \ell + \ell \cdot \text{diam}(H) + \ell = (\ell + 2)\text{diam}(H)$. Besides we show in [4] that the $\log n'$ -subdivision of n' -vertex graphs have bounded twin-width. Furthermore an $O(1)$ -sequence can be computed in $O(n)$ -time if the initial graph has

¹⁵The assumption that, for every $\varepsilon > 0$, SAT cannot be solved in time $(2 - \varepsilon)^n$ by a classical algorithm.

bounded degree. An $n^{2-\varepsilon}$ -time algorithm computing the diameter of such a graph G , would give an $O((n^{1+\frac{\varepsilon}{2}})^{2-\varepsilon}) = O(n^{2-\frac{\varepsilon}{2}})$. Such a subquadratic algorithm is ruled out, even to obtain a $3/2 - \varepsilon'$ -approximation of the diameter, unless the SETH fails. Finally one may observe that the reduction preserves the inapproximability gap. ◀

A related SETH lower bound is obtained by Coudert et al. [9], who show that DIAMETER cannot be solved in time $2^{o(\text{cw})}n^{2-\varepsilon}$ on n -vertex graphs with clique-width cw . The lower bound of Theorem 25 is quantitatively stronger (albeit in an admittedly larger graph class) since it rules out any algorithm solving DIAMETER in time $f(d)n^{2-\varepsilon}$ for any function f , on graphs of twin-width at most d . Let us recall that when the diameter is guaranteed constant, DIAMETER can be expressed as a first-order formula. Thus we can compute the exact diameter in $O(n)$ -time provided the contraction sequence of the input graph [5].

7 Approximation Algorithms

Provided $O(1)$ -sequences of the inputs, we give constant-approximation algorithms for MIN DOMINATING SET and the DISTANCE-2 MIS problem, where one seeks a maximum-cardinality subset of vertices not containing a pair at distance at most 2. Next we show that such an algorithm for DISTANCE-1 MIS, that is MIS, would have the unexpected consequence of leading to a polynomial-time approximation scheme.

7.1 Constant approximation for Min Dominating Set

In this section, we prove that MIN DOMINATING SET and its dual DISTANCE-2 MIS have bounded integrality gaps in classes of bounded twin-width. Constant factor approximation algorithms follow for these two problems. We will use the following technical lemma from the second paper of the series.

► **Theorem 26** (Section 3, Lemma 20 in [4]). *For every integer t , there are integers s and t' such that every graph G with a t -sequence admits a rooted tree \mathcal{T} with the following properties.*

- *Every node of \mathcal{T} is labeled by a t' -trigraph.*
- *The root of \mathcal{T} is labeled by G .*
- *All the leaves of \mathcal{T} are labeled by the 1-vertex graph K_1 .*
- *If a node x of \mathcal{T} is labeled by H , and a child node of x is labeled by H' , there is a t' -contraction in H that yields H' . In particular $|V(H)| = |V(H')| + 1$.*
- *Every internal node of \mathcal{T} labeled by H has at least $|V(H)|/s$ children coming from t' -contractions on pairwise disjoint pairs of vertices of H .*

Such a tree is called an s -versatile tree of t' -contractions. Informally Theorem 26 says that, by degrading the twin-width bound, one can move away from the “linear nature” of the contraction sequence to a profusely branching contraction witness.

Theorem 26 is effective: The s -versatile tree of t' -contractions can be computed in polynomial time, if a t -sequence for G is provided.

► **Theorem 27.** *In classes of bounded twin-width, MIN DOMINATING SET has bounded integrality gap.*

Proof. Let G be a graph of twin-width at most t . By Theorem 26, there exist t', s function of t only such that G admits an s -versatile tree of t' -contraction. Let $w^* : V(G) \rightarrow [0, 1]$ be

the weight function of a minimum fractional dominating set, with total weight γ^* . Thus w^* is an optimum solution of the linear program

$$\begin{aligned} & \text{minimize} && \sum_{x \in V(G)} w(x) \\ & \text{with } \forall x \in V(G), && \sum_{y \in N[x]} w(y) \geq 1, \text{ and } 0 \leq w(x) \leq 1, \end{aligned}$$

and $\gamma^* = \sum_{x \in V(G)} w^*(x)$. The weight function w^* is extended to subsets of vertices by sum. We assume that G has at least one vertex, so $\gamma^* \geq 1$.

We now greedily perform contractions in G following the versatile tree of contractions with a restriction: contractions involving a part of total weight at least $\frac{1}{2(t'+1)}$ are forbidden. Let us explain what this means in more detail. We start at the root, labeled G , of the versatile tree. We move to a(ny) child node along an edge corresponding to a non-forbidden t' -contraction. A *non-forbidden* contraction is one of u, v with $w^*(u(G)) < \frac{1}{2(t'+1)}$ and $w^*(v(G)) < \frac{1}{2(t'+1)}$. We iterate that until we get stuck (every child of the current node entails a forbidden contraction).

We adopt the partition viewpoint of the t' -sequence. Let \mathcal{P} be the partition of $V(G)$ obtained when this process finishes, and let $G_{\mathcal{P}}$ be the corresponding trigraph (that is, the label of the node where we stop). We observe that we cannot end at a leaf of the versatile tree. Indeed that would mean that the last contraction merged a bipartition $\{X, Y\}$ of $V(G)$ into $\{V(G)\}$. As $\gamma^* \geq 1$, this would imply that $w^*(X) \geq 1/2$ or $w^*(Y) \geq 1/2$, contradicting $\max(w^*(X), w^*(Y)) < \frac{1}{2(t'+1)}$.

▷ **Claim 28.** The partition \mathcal{P} has at most $2s(t'+1)\gamma^*$ classes.

Proof. As we explained, we cannot end up with a partition \mathcal{P} at a leaf of the versatile tree. Thus at least $|\mathcal{P}|/s$ disjoint pairs of vertices are t' -contractions in $G_{\mathcal{P}}$. Therefore all these contractions must be forbidden by our restriction imposed on the weights. It follows that at least $|\mathcal{P}|/s$ parts of \mathcal{P} have weight at least $\frac{1}{2(t'+1)}$. Since the sum of all weights in \mathcal{P} is γ^* , it follows that $|\mathcal{P}| \leq 2s(t'+1)\gamma^*$. ◀

▷ **Claim 29.** Let $P \in \mathcal{P}$ be any part. Either $w^*(P) < \frac{1}{t'+1}$ or P is a singleton.

Proof. Let $P \in \mathcal{P}$, and assume that P is not a singleton. Then P has been obtained by contracting two parts P_1, P_2 during the contraction sequence leading to \mathcal{P} . The restriction on the contraction sequence ensures that $w^*(P_1) < \frac{1}{2(t'+1)}$ and $w^*(P_2) < \frac{1}{2(t'+1)}$. Therefore $w^*(P) = w^*(P_1) + w^*(P_2) < \frac{1}{t'+1}$. ◀

Let $D \subseteq V(G)$ be obtained by picking arbitrarily one vertex x_P in each part $P \in \mathcal{P}$. By Claim 28, $|D| \leq 2s(t'+1)\gamma^*$, which is linear in γ^* when t is fixed. Let us prove that D is a dominating set. We let $P \in \mathcal{P}$, and prove that all vertices of P are dominated by D .

Suppose first that there exists $P' \in \mathcal{P}$ such that P, P' is a black edge in $G_{\mathcal{P}}$. Then $x_{P'} \in P'$ is adjacent to all vertices of P , which are thus dominated by D .

Hence we may instead assume that P does not have any black neighbor in $G_{\mathcal{P}}$. Consider any vertex $y \in P$, and let P_1, \dots, P_k the parts of $\mathcal{P} \setminus \{P\}$ such that there exists an edge between y and some vertex of P_i . Then P_1, \dots, P_k are neighbors of P in $G_{\mathcal{P}}$, and must be red neighbors since P has no black neighbor. Since $G_{\mathcal{P}}$ is a t' -trigraph, it follows that $k \leq t'$.

We now claim that one of the parts P, P_1, \dots, P_k must be a singleton. Indeed, since w^* is a fractional dominating set, and since $P \cup \bigcup_{i=1}^k P_i$ contains y and its neighborhood, it must be that $w^*(P) + \sum_{i=1}^k w^*(P_i) \geq 1$. Because $k \leq t'$, it follows that one part among

P, P_1, \dots, P_k has weight at least $\frac{1}{t'+1}$. By Claim 29, that same part P_h must be a singleton. Let z be the single vertex in P_h . Necessarily $z \in D$. If this singleton part is P , then $z = y$. Otherwise z is a neighbor of y by definition of P_1, \dots, P_k . In either case y is dominated in D by z . ◀

We now consider the following linear programming formulation of DISTANCE-2 MIS, which is dual to MIN DOMINATING SET:

$$\begin{aligned} & \text{maximize} && \sum_{x \in V(G)} w(x) \\ & \text{with } \forall x \in V(G), && \sum_{y \in N[x]} w(y) \leq 1, \text{ and } 0 \leq w(x) \leq 1. \end{aligned}$$

Similar arguments prove the same result for this dual problem.

► **Theorem 30.** *In classes of bounded twin-width, DISTANCE-2 MIS has bounded integrality gap.*

Proof. Consider G of twin-width t , and t', s function of t such that G admits an s -versatile tree of t' -contraction. Let $w^* : V(G) \rightarrow \mathbb{R}$ be the weight function of a maximum fractional 2-independent set, with total weight α_2^* .

We greedily perform contractions in G following the versatile tree of contractions with the restriction: contractions involving a part with total weight more than 1 are forbidden. Let \mathcal{P} be the partition of $V(G)$ obtained when this process finishes, and $G_{\mathcal{P}}$ be the corresponding trigraph. Again the weight function w^* is extended to \mathcal{P} by sum. With our restriction on allowed contractions, it is immediate that all classes of \mathcal{P} have weight at most 2. Therefore $|\mathcal{P}| \geq \frac{\alpha_2^*}{2}$. We can safely assume that $\alpha_2^* > 2$, thus $|\mathcal{P}| > 1$. In particular, the node of the versatile tree labeled $G_{\mathcal{P}}$ in which we stopped is an internal node.

$$\text{Let } A = \{P \in \mathcal{P} : w^*(P) > 1\}.$$

▷ **Claim 31.** $|A| \geq \frac{\alpha_2^*}{2s}$.

Proof. The elements of A are exactly the ones which cannot be used for contractions in $G_{\mathcal{P}}$. The versatile tree of contractions ensures at least $|\mathcal{P}|/s \geq \frac{\alpha_2^*}{2s}$ pairwise disjoint t' -contractions in $G_{\mathcal{P}}$. All these contractions must be forbidden, meaning that they all involve a vertex of A . Since they are contractions of disjoint pairs of vertices, it follows that $|A| \geq \frac{\alpha_2^*}{2s}$. ◀

▷ **Claim 32.** No element of A has a black neighbor in $G_{\mathcal{P}}$.

Proof. Suppose that there exist $P \in A, P' \in \mathcal{P}$ such that PP' is a black edge in $G_{\mathcal{P}}$. Then for any $x \in P'$ we have $P \subseteq N_G(x)$ and $w^*(P) > 1$, which violates the LP constraint. ◀

▷ **Claim 33.** There exists $S \subseteq A$ a 2-independent set in $G_{\mathcal{P}}$ such that $|S| \geq \frac{\alpha_2^*}{2s(t'^2+1)}$.

Proof. By Claim 32, a path of length at most 2 in $G_{\mathcal{P}}$ between elements of A can only consist of red edges. Since the red graph in $G_{\mathcal{P}}$ has maximum degree at most t' , given $P \in A$, there are at most t'^2 other elements of A at distance 2 or less of P . Thus one can choose a 2-independent set in A of size at least $\frac{|A|}{t'^2+1}$, which is at least $\frac{\alpha_2^*}{2s(t'^2+1)}$ by Claim 31. ◀

To conclude, we pick one vertex of G within each part of S . This gives a 2-independent set in G of size at least $\frac{\alpha_2^*}{2s(t'^2+1)}$. ◀

Reporting approximated solutions for MIN DOMINATING SET and DISTANCE-2 MIS requires that a t -sequence of the input is provided (or that it can be computed in polynomial time, as it is the case on many bounded twin-width classes). Interestingly, deciding the associated constant-gap problem can be done without t -sequences, with the mere knowledge of the twin-width bound.

The constant approximations more generally work for MIN r -DOMINATING SET and DISTANCE- $2r$ MIS, for every positive integer r . Indeed solving these problems in G is equivalent to solving MIN DOMINATING SET and DISTANCE-2 MIS in $G^{\leq r}$ (where $G^{\leq r}$ is the graph obtained by putting an edge between every pair of vertices at distance at most r in G). Besides the twin-width of $G^{\leq r}$ is bounded by a function of the twin-width of G and r , and an $O_r(1)$ -sequence for $G^{\leq r}$ can be computed in polynomial time, given an $O(1)$ -sequence for G [5, Section 8, Theorem 41].

7.2 A constant approximation for MIS would imply a PTAS

A pessimistic stance on the result of this section is that, perhaps surprisingly, the constant approximations of MIN DOMINATING SET and DISTANCE-2 MIS are unlikely to be generalizable to the closely related MIS (that can be seen as DISTANCE-1 MIS). We indeed observe that the self-improving reduction of Feige et al. [21] preserves the twin-width. As a consequence a constant approximation for MIS would provide a polynomial-time approximation scheme (PTAS).

► **Theorem 34.** *If MAX INDEPENDENT SET on graphs of twin-width at most d has a constant-approximation algorithm, then it admits a PTAS.*

For G_1 and G_2 two non-empty graphs, and $u \in V(G_1)$, we denote by $G_1(u \leftarrow G_2)$ the substitution in G_1 of u by G_2 . That is, u is replaced by G_2 , and every vertex of $V(G_1) \setminus \{u\}$ initially adjacent to u is made adjacent to the whole $V(G_2)$.

► **Lemma 35.** $tww(G_1(u \leftarrow G_2)) = \max(tww(G_1), tww(G_2))$.

Proof. We set $G := G_1(u \leftarrow G_2)$. G_1 and G_2 are both induced subgraphs of G , so $tww(G) \geq \max(tww(G_1), tww(G_2))$. For the reverse inequality, one just applies the sequence of d_2 -contractions on the copy of G_2 in G , with $d_2 := tww(G_2)$. This results in the graph G_1 without red edges. Then, one applies the sequence of d_1 -contractions to G_1 , with $d_1 := tww(G_1)$. This shows that $tww(G) \leq \max(d_1, d_2)$. ◀

For G a graph, let G^t be the graph on the vertex set $V(G)^t$, such that for $\bar{x} = (x_1, \dots, x_t)$, $\bar{y} = (y_1, \dots, y_t)$ distinct vertices, $\bar{x}\bar{y} \in E(G^t)$ if and only if $x_i y_i \in E(G)$ where i is the smallest index such that $x_i \neq y_i$. This definition can be restated inductively: G^0 is the 1-vertex graph, and G^t is obtained from G by substituting each vertex by a copy of G^{t-1} . With the notations of the initial definition, for $x \in V(G)$, the set of vertices of G^t of the form (x, x_2, \dots, x_t) is a copy isomorphic to G^{t-1} .

The following holds as a direct consequence of Lemma 35.

► **Lemma 36.** *For any graph G and integer $t > 0$, $tww(G^t) = tww(G)$.*

We now show that the independence number of G^t is tightly related to the one of G .

► **Lemma 37.** *For any graph G , both following conditions hold.*

1. *Given any independent set of size k in G , one can compute an independent of size k^t in G^t , in time $O(k^t)$.*

2. Given any independent set of size k' in G^t , one can compute an independent of size at least $\sqrt[t]{k'}$ in G , in time $O(k')$.

Proof. Let I be an independent set in G . Then I^t seen as a subset of $V(G)^t$ is an independent of G^t , which proves the first item.

For the second item, let I be an independent set in G^t of size at least r^t . We define

$$I' := \{x \in V(G) : \exists x_2, \dots, x_t, (x, x_2, \dots, x_t) \in I\}.$$

Then I' is an independent set in G . If $|I'| \geq r$, we are done. Otherwise, for each $x \in I'$, let

$$I_x := \{(x_2, \dots, x_t) \in V(G)^{t-1} : (x, x_2, \dots, x_t) \in I\}.$$

For any x , I_x is an independent set in G^{t-1} . Furthermore we have $\sum_{x \in I'} |I_x| = |I|$, $|I| = r^t$, and $|I'| < r$, hence there exists some $x \in I'$ such that $|I_x| \geq r^{t-1}$. By induction on t we obtain an independent of size at least r in G . ◀

As an immediate corollary, $\alpha(G^t) = \alpha(G)^t$ where, we recall, $\alpha(H)$ denotes the size of a maximum independent set in H .

Proof of Theorem 34. Assume there is a polynomial-time β -approximation for MIS on graphs of twin-width at most d . Let G be a graph with twin-width at most d . By Lemma 36 the algorithm can be ran on G^t to obtain an independent set of size at least $\frac{\alpha(G^t)}{\beta} = \frac{\alpha(G)^t}{\beta}$. By Lemma 37, this independent set in G^t can be turned into an independent set in G of size at least $\alpha(G)/\sqrt[t]{\beta}$. This gives a polynomial-time $\sqrt[t]{\beta}$ -approximation for arbitrary t . Thus the approximation ratio can be made arbitrarily close to 1. ◀

7.3 Linear Erdős-Pósa property

Given a 0,1-matrix M , two natural integer programs naturally arise: One can ask for a minimum-weight 0,1-vector X_h such that $M \cdot X_h \geq 1$ or for a maximum-weight 0,1-vector Y_p such that $M^t \cdot Y_p \leq 1$. In the usual representation of M as a hypergraph H where columns are vertices and rows are hyperedges (each row seen as an indicator vector of a subset of vertices), X_h is a minimum *hitting set* and Y_p is a maximum *packing*. We usually denote by $\mu(H)$ the size of a maximum packing and by $\tau(H)$ the size of a minimum hitting set.

One can then consider the fractional relaxation of these parameters, $\mu^*(H)$ and $\tau^*(H)$. Since the corresponding linear programs are dual, we obtain the following chain of (in)equalities $\mu(H) \leq \mu^*(H) = \tau^*(H) \leq \tau(H)$. A class \mathcal{H} of hypergraphs for which there exists a function f such that every hypergraph $H \in \mathcal{H}$ satisfies $\tau(H) \leq f(\mu(H))$ has the *Erdős-Pósa property*. If furthermore $\tau(H) \leq c \cdot \mu(H)$ for some constant c , \mathcal{H} has the *linear Erdős-Pósa property*.

By a result of Haussler and Welzl [28], the class of hypergraphs with bounded VC-dimension satisfies that $\tau(H) \leq f(\tau^*(H))$, but is not by itself sufficient to imply the Erdős-Pósa property (the integrality gap for μ is unbounded). A result of Ding et al. [13] asserts that the Erdős-Pósa property holds for matrices which do not contain the transpose of incidence matrices of cliques as submatrices; the function f is polynomial but not linear. Dvořák [17] proved that, for every fixed r , r -neighborhood hypergraphs of bounded expansion classes have the linear Erdős-Pósa property. Recently, Bousquet et al [6] showed that ball hypergraphs (of any radius) of proper minor-closed classes have the linear Erdős-Pósa property.

The *incidence bipartite graph* $B(H)$ of a hypergraph H is the bipartite graph on vertex set $V(H) \cup E(H)$ where ve is an edge if $v \in V(H)$, $e \in E(H)$ and $v \in e$. The *twin-width* of

hypergraph H is defined here as the twin-width of $B(H)$. A straightforward adaptation of the proofs of Theorems 27 and 30 gives:

► **Theorem 38.** *For every integer t , there is a constant c_t such that every hypergraph H with twin-width at most t satisfies $\tau(H) \leq c_t \cdot \mu(H)$.*

In other words, the class of bounded twin-width hypergraphs have the linear Erdős-Pósa property. A particularly interesting line of research would be to generalize this integrality-gap result to integer matrices rather than just 0, 1-matrices. This requires a suitable definition for bounded twin-width in the general integer case.

8 Future work and open questions

We have now a rather fine-grained understanding of the classic parameterized graph problems (k -INDEPENDENT SET, k -DOMINATING SET, and their relatives) when a contraction sequence is given in addition to the bounded twin-width graph. For k -INDEPENDENT SET for example there is a $2^{O(k)}n$ -time algorithm, while a $2^{O(k/\log k)}n^{O(1)}$ -time (even $2^{O(n/\log n)}$ -time) algorithm would refute the ETH. It is natural to wonder if better approximation algorithms of NP-hard problems are possible when a contraction sequence is given. Before we detail that a bit, as well as the possibility of getting improved exact exponential algorithms on general graphs, we note that bounded twin-width does not seem to help to get polynomial kernels.

8.1 No polynomial kernels on bounded twin-width classes

We already observed that k -INDEPENDENT SET is unlikely to have $k^{O(1)}$ kernels on graphs of twin-width at most a fixed constant d [5]. We sketch here that the same applies to the vertex-weighted k -DOMINATING SET (that is, the problem of the existence of a weight- k dominating set). The following is an OR-composition producing from, say, t instances of the NP-hard DOMINATING SET on planar graphs, one instance of WEIGHTED DOMINATING SET whose underlying unweighted graph has constant twin-width.

We make the disjoint union of the t planar DOMINATING SET-instances $(G_1, k), \dots, (G_t, k)$. We add t vertices u_1, \dots, u_t each of weight $k + 1$, and link u_i to all the vertices of every G_j but G_i . It is easy to see that the existence of a weight- $2k + 1$ dominating set in this new graph is equivalent to one of the instances $(G_1, k), \dots, (G_t, k)$ being positive. As planar graphs have bounded twin-width [5], the built graph (forgetting its weights) also has bounded twin-width. One can first contract every G_i into single vertices, thus obtaining the (black) anti-matching on t edges (i.e., the bipartite complement of t independent edges), which itself has twin-width 2. Thus a polynomial kernel would imply the unlikely containment $\text{NP} \subseteq \text{co-NP/poly}$ [2]. It is not so satisfactory that the lower bound is for WEIGHTED DOMINATING SET, while the twin-width is computed on the unweighted graph. It turns out that the same negative result is attainable for DOMINATING SET but the reduction is far more involved. Thus we will not sketch it here.

8.2 Better approximation algorithms

We ask for the approximability status of MAX INDEPENDENT SET, MIN DOMINATING SET, and MIN COLORING on bounded twin-width graphs (given with d -sequences).

One can observe that the arguments of Section 7.2 show that a $\log^c n$ -approximation algorithm for MIS (for some constant c) implies a $\log^\varepsilon n$ -approximation for any $\varepsilon > 0$. We let the reader decide if this is a sign that $\log^c n$ -approximation algorithms are unlikely.

Approximation algorithms of MIS on bounded twin-width graphs with worst ratios (for instance n^ε for every $\varepsilon > 0$) would also be interesting, as they are far from existing in general graphs. For MIN DOMINATING SET on bounded twin-width graphs, we ask for a constant-approximation algorithm with ratio independent on the twin-width bound, or even for a PTAS. For MIN COLORING, we ask for any improvement over our $2^{O(\text{OPT})}$ -approximation algorithm. A first step is to reach approximation factor $\text{OPT}^{O(1)}$. While we do not see any obvious obstruction to an $O_d(1)$ -approximation, a PTAS is ruled out by the 3 vs 4 hardness of COLORING in planar graphs (class for which d -sequences can be computed in polynomial time [5]).

8.3 Exact exponential algorithms

A possible algorithmic success for a novel graph invariant, like twin-width, is to eventually lead to (faster) algorithms on general graphs, and not merely on graphs where the invariant is bounded. A natural way this happens (for instance for treewidth) is by a win-win argument. Either the parameter is small and we exploit it, or it is large, and some complex structure appears, which actually helps our decision.

But win-win arguments are not the only way. Algorithms initially designed for bounded twin-width graphs may turn out also interesting on general graphs. We see Theorem 11 as a promising starting point to get exact exponential algorithms for MAX INDEPENDENT SET on general graphs. This asks for a new game related to, but also fundamentally different from twin-width. Can we find a contraction sequence for any n -vertex graph such that the total number of connected sets in the red graphs is at most $O^*(c^n)$ for some constant c ? (Showing this result with $c = 1.19$ would improve the current best exact algorithm for MIS.) Note that creating vertices with large red degree is no longer forbidden.

References

- 1 Noga Alon, János Pach, Rom Pinchasi, Radoš Radoičić, and Micha Sharir. Crossing patterns of semi-algebraic sets. *Journal of Combinatorial Theory, Series A*, 111(2):310–326, 2005. URL: <http://www.sciencedirect.com/science/article/pii/S0097316505000063>, doi:<https://doi.org/10.1016/j.jcta.2004.12.008>.
- 2 Hans L. Bodlaender, Rodney G. Downey, Michael R. Fellows, and Danny Hermelin. On problems without polynomial kernels. *J. Comput. Syst. Sci.*, 75(8):423–434, 2009. doi:10.1016/j.jcss.2009.04.001.
- 3 Marthe Bonamy and Michal Pilipczuk. Graphs of bounded cliquewidth are polynomially χ -bounded. *CoRR*, abs/1910.00697, 2019. URL: <http://arxiv.org/abs/1910.00697>, arXiv:1910.00697.
- 4 Édouard Bonnet, Colin Geniet, Eun Jung Kim, Stéphan Thomassé, and Rémi Watrigant. Twin-width II: small classes. In *Proceedings of the 2021 ACM-SIAM Symposium on Discrete Algorithms (SODA)*, pages 1977–1996, 2021. doi:10.1137/1.9781611976465.118.
- 5 Édouard Bonnet, Eun Jung Kim, Stéphan Thomassé, and Rémi Watrigant. Twin-width I: tractable FO model checking. In *61st IEEE Annual Symposium on Foundations of Computer Science, FOCS 2020, Durham, NC, USA, November 16-19, 2020*, pages 601–612. IEEE, 2020. doi:10.1109/FOCS46700.2020.00062.
- 6 Nicolas Bousquet, Wouter Cames van Batenburg, Louis Esperet, Gwenaël Joret, William Lochet, Carole Muller, and François Pirot. Packing and covering balls in graphs excluding a minor, 2020. arXiv:2001.04517.
- 7 Bernard Chazelle. Filtering search: A new approach to query-answering. *SIAM J. Comput.*, 15(3):703–724, 1986. doi:10.1137/0215051.

- 8 Thomas H. Cormen, Charles E. Leiserson, Ronald L. Rivest, and Clifford Stein. *Introduction to Algorithms, 3rd Edition*. MIT Press, 2009. URL: <http://mitpress.mit.edu/books/introduction-algorithms>.
- 9 David Coudert, Guillaume Ducoffe, and Alexandru Popa. Fully polynomial FPT algorithms for some classes of bounded clique-width graphs. *ACM Trans. Algorithms*, 15(3):33:1–33:57, 2019. doi:10.1145/3310228.
- 10 Bruno Courcelle. The monadic second-order logic of graphs. I. Recognizable sets of finite graphs. *Information and Computation*, 85(1):12 – 75, 1990. URL: <http://www.sciencedirect.com/science/article/pii/089054019090043H>, doi:[https://doi.org/10.1016/0890-5401\(90\)90043-H](https://doi.org/10.1016/0890-5401(90)90043-H).
- 11 Bruno Courcelle, Johann A. Makowsky, and Udi Rotics. Linear time solvable optimization problems on graphs of bounded clique-width. *Theory Comput. Syst.*, 33(2):125–150, 2000. doi:10.1007/s002249910009.
- 12 Erik D. Demaine, Fedor V. Fomin, Mohammad Taghi Hajiaghayi, and Dimitrios M. Thilikos. Subexponential parameterized algorithms on bounded-genus graphs and H -minor-free graphs. *J. ACM*, 52(6):866–893, 2005. doi:10.1145/1101821.1101823.
- 13 Guoli Ding, Paul D. Seymour, and Peter Winkler. Bounding the vertex cover number of a hypergraph. *Comb.*, 14(1):23–34, 1994.
- 14 Irit Dinur and David Steurer. Analytical approach to parallel repetition. In David B. Shmoys, editor, *Symposium on Theory of Computing, STOC 2014, New York, NY, USA, May 31 - June 03, 2014*, pages 624–633. ACM, 2014. doi:10.1145/2591796.2591884.
- 15 Frederic Dorn. Planar subgraph isomorphism revisited. In Jean-Yves Marion and Thomas Schwentick, editors, *27th International Symposium on Theoretical Aspects of Computer Science, STACS 2010, March 4-6, 2010, Nancy, France*, volume 5 of *LIPICs*, pages 263–274. Schloss Dagstuhl - Leibniz-Zentrum für Informatik, 2010. doi:10.4230/LIPICs.STACS.2010.2460.
- 16 Zdeněk Dvořák and Daniel Král'. Classes of graphs with small rank decompositions are χ -bounded. *Eur. J. Comb.*, 33(4):679–683, 2012. doi:10.1016/j.ejc.2011.12.005.
- 17 Zdeněk Dvořák. Constant-factor approximation of the domination number in sparse graphs. *European Journal of Combinatorics*, 34(5):833 – 840, 2013. URL: <http://www.sciencedirect.com/science/article/pii/S0195669812002028>, doi:<https://doi.org/10.1016/j.ejc.2012.12.004>.
- 18 David Eppstein. Subgraph isomorphism in planar graphs and related problems. *J. Graph Algorithms Appl.*, 3(3):1–27, 1999. doi:10.7155/jgaa.00014.
- 19 David Eppstein. Diameter and treewidth in minor-closed graph families. *Algorithmica*, 27(3):275–291, 2000. doi:10.1007/s004530010020.
- 20 Jacob Evald and Søren Dahlgaard. Tight hardness results for distance and centrality problems in constant degree graphs. *CoRR*, abs/1609.08403, 2016. URL: <http://arxiv.org/abs/1609.08403>, arXiv:1609.08403.
- 21 Uriel Feige, Shafi Goldwasser, László Lovász, Shmuel Safra, and Mario Szegedy. Approximating Clique is almost NP-complete (preliminary version). In *32nd Annual Symposium on Foundations of Computer Science, San Juan, Puerto Rico, 1-4 October 1991*, pages 2–12. IEEE Computer Society, 1991. doi:10.1109/SFCS.1991.185341.
- 22 Jörg Flum and Martin Grohe. Fixed-parameter tractability, definability, and model-checking. *SIAM J. Comput.*, 31(1):113–145, 2001. doi:10.1137/S0097539799360768.
- 23 Markus Frick and Martin Grohe. The complexity of first-order and monadic second-order logic revisited. *Ann. Pure Appl. Log.*, 130(1-3):3–31, 2004. doi:10.1016/j.apal.2004.01.007.
- 24 Harold N. Gabow and Robert Endre Tarjan. A linear-time algorithm for a special case of disjoint set union. *J. Comput. Syst. Sci.*, 30(2):209–221, 1985. doi:10.1016/0022-0000(85)90014-5.
- 25 Martin Grötschel, László Lovász, and Alexander Schrijver. The ellipsoid method and its consequences in combinatorial optimization. *Combinatorica*, 1(2):169–197, 1981. doi:10.1007/BF02579273.

- 26 Andrzej Grzesik, Tereza Klimosova, Marcin Pilipczuk, and Michal Pilipczuk. Polynomial-time algorithm for maximum weight independent set on P_6 -free graphs. In *Proceedings of the Thirtieth Annual ACM-SIAM Symposium on Discrete Algorithms, SODA 2019, San Diego, California, USA, January 6-9, 2019*, pages 1257–1271, 2019. doi:10.1137/1.9781611975482.77.
- 27 Sylvain Guillemot and Dániel Marx. Finding small patterns in permutations in linear time. In *Proceedings of the Twenty-Fifth Annual ACM-SIAM Symposium on Discrete Algorithms, SODA 2014, Portland, Oregon, USA, January 5-7, 2014*, pages 82–101, 2014. doi:10.1137/1.9781611973402.7.
- 28 D. Haussler and E. Welzl. Epsilon-nets and simplex range queries. *Discrete Computational Geometry*, 2:127–151, 1987.
- 29 Russell Impagliazzo and Ramamohan Paturi. On the Complexity of k-SAT. *J. Comput. Syst. Sci.*, 62(2):367–375, 2001. doi:10.1006/jcss.2000.1727.
- 30 Russell Impagliazzo, Ramamohan Paturi, and Francis Zane. Which problems have strongly exponential complexity? *J. Comput. Syst. Sci.*, 63(4):512–530, 2001. doi:10.1006/jcss.2001.1774.
- 31 David S. Johnson. Approximation algorithms for combinatorial problems. *J. Comput. Syst. Sci.*, 9(3):256–278, 1974. doi:10.1016/S0022-0000(74)80044-9.
- 32 Stefan Kratsch and Florian Nelles. Efficient parameterized algorithms for computing all-pairs shortest paths. In Christophe Paul and Markus Bläser, editors, *37th International Symposium on Theoretical Aspects of Computer Science, STACS 2020, March 10-13, 2020, Montpellier, France*, volume 154 of *LIPICs*, pages 38:1–38:15. Schloss Dagstuhl - Leibniz-Zentrum für Informatik, 2020. doi:10.4230/LIPICs.STACS.2020.38.
- 33 László Lovász. On the ratio of optimal integral and fractional covers. *Discret. Math.*, 13(4):383–390, 1975. doi:10.1016/0012-365X(75)90058-8.
- 34 Michal Pilipczuk and Sebastian Siebertz. Polynomial bounds for centered colorings on proper minor-closed graph classes. In Timothy M. Chan, editor, *Proceedings of the Thirtieth Annual ACM-SIAM Symposium on Discrete Algorithms, SODA 2019, San Diego, California, USA, January 6-9, 2019*, pages 1501–1520. SIAM, 2019. doi:10.1137/1.9781611975482.91.
- 35 Svatopluk Poljak. A note on stable sets and colorings of graphs. *Commentationes Mathematicae Universitatis Carolinae*, 15(2):307–309, 1974.
- 36 Jens M. Schmidt. Interval stabbing problems in small integer ranges. In Yingfei Dong, Ding-Zhu Du, and Oscar H. Ibarra, editors, *Algorithms and Computation, 20th International Symposium, ISAAC 2009, Honolulu, Hawaii, USA, December 16-18, 2009. Proceedings*, volume 5878 of *Lecture Notes in Computer Science*, pages 163–172. Springer, 2009. doi:10.1007/978-3-642-10631-6_18.
- 37 Christian Sloper and Jan Arne Telle. An overview of techniques for designing parameterized algorithms. *Comput. J.*, 51(1):122–136, 2008. doi:10.1093/comjnl/bxm038.
- 38 Hisao Tamaki. Positive-instance driven dynamic programming for treewidth. *J. Comb. Optim.*, 37(4):1283–1311, 2019. doi:10.1007/s10878-018-0353-z.
- 39 Raphael Yuster. Efficient algorithms on sets of permutations, dominance, and real-weighted APSP. In Claire Mathieu, editor, *Proceedings of the Twentieth Annual ACM-SIAM Symposium on Discrete Algorithms, SODA 2009, New York, NY, USA, January 4-6, 2009*, pages 950–957. SIAM, 2009. URL: <http://dl.acm.org/citation.cfm?id=1496770.1496873>.