

SIMPLE LENGTH SPECTRA AS MODULI FOR HYPERBOLIC SURFACES AND RIGIDITY OF LENGTH IDENTITIES

HYUNGRYUL BAIK, INHYEOK CHOI, AND DONGRYUL M. KIM

ABSTRACT. In this article, we revisit classical length identities enjoyed by simple closed curves on hyperbolic surfaces. We state and prove rigidity of such identities over Teichmüller spaces. Due to this rigidity, simple closed curves with few intersections are characterised on generic hyperbolic surfaces by their lengths.

As an application, we construct a meagre set V in the Teichmüller space of a topological surface S , possibly of infinite type. Then the isometry class of a (Nielsen-convex) hyperbolic structure on S outside V is characterised by its unmarked simple length spectrum. Namely, we show that the simple length spectra can be used as moduli for generic hyperbolic surfaces. In the case of compact surfaces, an analogous result using length spectra was obtained by Wolpert.

1. INTRODUCTION

Given a closed Riemannian manifold M , one can define the Laplace-Beltrami operator Δ acting on $\mathcal{L}^2(M)$. The (*eigenvalue*) *spectrum* of M is the collection of eigenvalues of Δ , counting multiplicities. A closely related notion is the (*unmarked*) *length spectrum* (*simple length spectrum*, resp.) of M , the collection of lengths of closed geodesics (simple closed geodesics, resp.) in M counting multiplicities. A classical result of Huber ([Hub59], [Hub61]) asserts that the spectrum determines the length spectrum in general, and vice versa in the case of hyperbolic surfaces of constant curvature.

The $9g - 9$ theorem implies that the marked length spectrum of a closed surface determines its isometry class. We remark its generalisation to negatively curved surfaces in [Ota90] and [Cro90]. In this spirit, Gel'fand conjectured in [Gel62] that the length spectrum of a closed surface determines its isometry class. (See [Kac66] for an analogous question by Kac for planar domains.) Since then, various attempts have been made to extract the Riemannian structure of manifolds from their spectra.

In general, a closed surface of genus g is isospectral to at most finitely many other surfaces. McKean provided the first upper bound on this number as a function of g in [McK72]; see [Bus92] and [Par18] for further development. However, Vignéras provided in [Vig78] the first examples of isospectral, non-isometric closed surfaces. Sunada explained in [Sun85] a general

Date: February 18, 2021.

recipe for isospectral closed manifolds in general dimensions including 2. These answer to Gelfand's conjecture in a negative direction.

Meanwhile, the length spectrum indeed determines the isometry class of some surfaces of low complexity. The case of one-holed torus with a fixed boundary length was proved by Haas in [Haa85], and the restriction on the boundary length was removed by Buser and Semmler in [BS88]. We note that their approaches equally work when the length spectrum is replaced with the simple length spectrum.

Nonetheless, it is not known whether the simple length spectrum determines the isometry class of a general hyperbolic surface. In [Mau13], Maungchang investigated examples of isospectral, non-isometric hyperbolic surfaces constructed in [Sun85] and showed that their simple length spectra differ. [ALLX20] observed the relationship between this question and characterising finite covers of surfaces via simple closed curves. See also [Mon17] for a variation of this question involving the length-angle spectrum.

One can instead focus on the simple length spectra of *generic* hyperbolic surfaces. In [MP08], McShane and Parlier asked whether there is a surface for which all the multiplicities are 1. They showed that the set of marked hyperbolic surfaces (of a given finite type) that does not have this property is meagre, providing a strongly affirmative answer. They also related this set with other questions on low-genus surfaces, including the Markoff conjecture.

The strategy of McShane and Parlier is investigating the length equality $l_X(\alpha) = l_X(\beta)$ for simple closed curves α, β over the Teichmüller space. If two curves are same, then the equality clearly holds on the entire space; otherwise, the equality holds only on a submanifold of the Teichmüller space. We note that this strategy is not applicable for non-simple closed curves. Indeed, there are arbitrary many distinct curves on a surface that have the same length with respect to any hyperbolic structure [Ran80].

Motivated by McShane and Parlier, we consider other length identities enjoyed by few-intersecting simple closed curves. As in McShane and Parlier's work, we construct a meagre subset V of the Teichmüller space; few-intersecting simple closed curves and their topological configuration are characterised by their lengths on any hyperbolic surface outside V . In other words, we prove the following proposition (which is an interpretation of Proposition 3.11 in plain words). This argument does not rely on the finiteness of the surface type and equally applies to surfaces of infinite type.

Proposition 1.1 (Interpretation of the main proposition). *There exists a meagre subset $V \subseteq \mathcal{T}(S)$ such that for $X \in \mathcal{T}(S) \setminus V$ and a hyperbolic surface X' homeomorphic to either one-holed torus or p -punctured b -holed sphere where $p + b = 4$, the following implication holds:*

$$\mathcal{L}(X') \subseteq \mathcal{L}(X) \Rightarrow \begin{array}{c} \exists \text{ isometric immersion} \\ X' \rightarrow X \end{array}$$

Here, \mathcal{L} stands for the simple length spectrum.

As an application of this result, we prove that the simple length spectra of generic surfaces determine their isometry classes. An analogous result for the length spectra was obtained by Wolpert in [Wol79]. Wolpert considered a subvariety V_g of the Teichmüller space \mathcal{T}_g of genus g and proved the following; if $[f_1, X] \in \mathcal{T}_g \setminus V_g$ and $[f_2, X'] \in \mathcal{T}_g$ have the same length spectrum, then $[f_1, X]$ and $[f_2, X']$ belong to the same orbit of the extended mapping class group Mod_g^\pm .

We note that Wolpert's argument requires length information of some non-simple closed curves, which are not available from the simple length spectrum. In addition, Wolpert's argument heavily relies on Mumford's compactness theorem, which is hard to be generalised to infinite-type surfaces. Our main result replaces the length spectrum in Wolpert's theorem with the simple length spectrum, using techniques that apply to both finite-type and infinite-type surfaces.

The following is the main theorem of this paper.

Theorem 1.2 (Simple length spectra as moduli). *Let S be a surface with nonabelian fundamental group and $\mathcal{T}(S)$ be the Teichmüller space of S . Then there exists a meagre subset V of $\mathcal{T}(S)$ satisfying the following; if $[f_1, X] \in \mathcal{T}(S) \setminus V$ and $[f_2, X'] \in \mathcal{T}(S)$ have the same simple length spectra, then $[f_1, X]$ and $[f_2, X']$ belong to the same orbit of $\text{Mod}^\pm(S)$.*

We emphasize again that in the above theorem S does not have to be of finite type. Further, V is negligible with respect to measures on S that are compatible with Weil-Petersson measures on finite-type subsurfaces. (See Property 2.9.) In particular, when S is of finite type, then V is of Weil-Petersson measure 0.

Organisation of the paper. In Section 2, we cover backgrounds for the paper. It especially includes Teichmüller spaces and pants decompositions of infinite-type surfaces, and the fractional Dehn twists. The relation between topological configurations of curves and identities among their lengths is dealt with in Section 3. In Section 4, the main theorems for surfaces of low complexity are proved. They serve as base cases for the induction argument in the proof of the main theorem provided in Section 5. Further questions are asked in Section 6. For some lemmas which seem to be well-known to the experts while the authors could not find explicit references, we provide their proofs in Appendix A, B, and C for the sake of completeness.

Acknowledgments. We appreciate Changsub Kim, KyeongRo Kim, Bram Petri, Philippe A. Tranchida, Scott Wolpert for helpful conversations. The first and second authors were partially supported by Samsung Science & Technology Foundation grant No. SSTF-BA1702-01.

2. BACKGROUNDS

2.1. Surfaces, curves and hyperbolic geometry. In this section, we introduce basic notions. For details, we refer the readers to [FM12] and [ALP⁺11].

In this article, (topological) surfaces are 2nd-countable, connected, oriented 2-dimensional manifolds with compact boundaries. Those with finitely generated fundamental groups are said to be of finite type; others are said to be of infinite type. Finite-type surfaces are characterised by their genus, the number of boundary components, and the number of ends. Topologically, a finite-type surface is homeomorphic to the connected sum of a sphere and finitely many tori, with finitely many open discs and points removed. We denote by $S_{g,p,b}$ the genus g surface with p punctures and b boundaries.

A homotopy on a surface is required to preserve each boundary component of the surface setwise, but not necessarily pointwise. A *loop* on a surface is a continuous map from S^1 to the surface. A loop is said to be *simple* if it is injective. A *curve* on a surface is a nontrivial free homotopy class of simple loop. A curve bounding an annulus is said to be *peripheral*; otherwise it is said to be *essential*. Each peripheral curve either bounds a puncture or a boundary component.

An *arc* on a surface is either an essential curve or the homotopy class of an essential simple arc connecting ends or boundary components. A *multicurve* (*multi-arc*, respectively) is a finite union of disjoint essential curves (arcs, respectively). All curves, arcs, multicurves, and multi-arcs are unoriented in this article, unless stated otherwise.

A (*properly embedded*) *subsurface* of a surface S is a proper embedding ψ of a surface S' into S . By abuse of notation, we sometimes refer to the image $\psi(S')$ in S as a subsurface. An *immersed subsurface* of a surface S is a proper immersion ψ of a surface S' into S whose restriction on $\text{int}(S')$ is an embedding. For example, a subsurface of type $S_{1,0,2}$ can be viewed as an immersed subsurface of type $S_{0,0,4}$.

The following are terminologies for surfaces with small complexity. A *generalised pair of pants* is a surface whose interior is homeomorphic to a 3-punctured sphere. These include $S_{0,p,b}$ with $b + p = 3$. A *generalised shirt* is a surface whose interior is homeomorphic to a 4-punctured sphere. These include $S_{0,p,b}$ with $b + p = 4$. Note that some literature use *Y-piece* and *X-piece* to denote the generalised pair of pants and the generalised shirt, respectively.

Definition 2.1. A pants decomposition \mathcal{P} of a surface S is a collection of disjoint, distinct curves $\{C_i\}_{i \in I}$ satisfying the following:

- (1) each component of $S \setminus \bigcup_i C_i$ is a generalised pair of pants without boundary, and
- (2) there exist disjoint annular neighborhoods N_i of C_i in S .

Note that a pants decomposition of a surface should include all of its boundary components.

Definition 2.2. A seam \mathcal{S} for a pants decomposition \mathcal{P} is a collection of disjoint, distinct arcs $\{A_j\}_{j \in J}$ satisfying the following:

- (1) *On each generalised pair of pants of $S \setminus \bigcup_i C_i$, $\bigcup_j A_j$ connects each pair of ends and decomposes the pair of pants into two generalised hexagons.*
- (2) *There exist disjoint tubular neighborhoods N'_j of A_j in X .*

Infinite-type surfaces are characterised by their genus, number of boundary components and the nested space of ends [Ric63]. From this characterisation, we obtain pants decompositions of surfaces that will be used in the proof of Theorem 1.2. The construction is apparent in Figure 1; nonetheless, we include a proof in Appendix A for the sake of completeness. (See also [HMV19])

Proposition 2.3. *Let S be a topological surface. Then there exists a pants decomposition $\mathcal{C} = \{C_i\}_{i \in I}$ and finite-type subsurfaces $\{S_n\}$ satisfying the following;*

- (1) *$\{S_n\}$ is an exhaustion of S , i.e., $S_n \subseteq S_{n+1}$ for each n , $S = \bigcup_n S_n$ and each compact subset of S is contained in some S_n ;*
- (2) *each of S_n is bounded by some curves in \mathcal{C} ; and*
- (3) *S_{n+1} is made by attaching a generalised pair of pants or a one-holed torus to S_n along only one curve.*

Notation 2.4. *From now on, S shall be reserved for a surface with the nonabelian fundamental group, equipped with a seamed pants decomposition $\mathcal{P} = (\{C_i\}_{i \in I}, \{A_j\}_{j \in J})$ obtained from Proposition 2.3. Moreover, $I_0 \subseteq I$ denotes the set of indices corresponding to the boundary components of S .*

A hyperbolic surface is a 2-dimensional Riemannian manifold, possibly with compact geodesic boundary, of constant curvature -1 . Subsurfaces and generalised subsurfaces of a hyperbolic surface are always assumed to have geodesic boundary. A hyperbolic surface is *convex* if every arc is homotoped to a geodesic arc, fixing endpoints. Convex hyperbolic surfaces are obtained as a quotient of a convex subset of \mathbb{H} by free, properly discontinuous action of a subgroup of $\text{Isom}^+(\mathbb{H})$. A hyperbolic surface is *Nielsen-convex* if every point is contained in a geodesic segment whose endpoints lie on simple closed geodesics. Such hyperbolic structures are suitable for our purpose due to the following fact.

Fact 2.5 (Theorem 4.5, [ALP⁺11]). *Let X be a hyperbolic surface. Then the following facts are equivalent:*

- (1) *X is obtained by gluing some hyperbolic pairs of pants along their boundary components.*
- (2) *X is Nielsen-convex.*
- (3) *X has topological pants decompositions, each of which can be promoted to a geometric pants decomposition via homotopy of curve systems.*

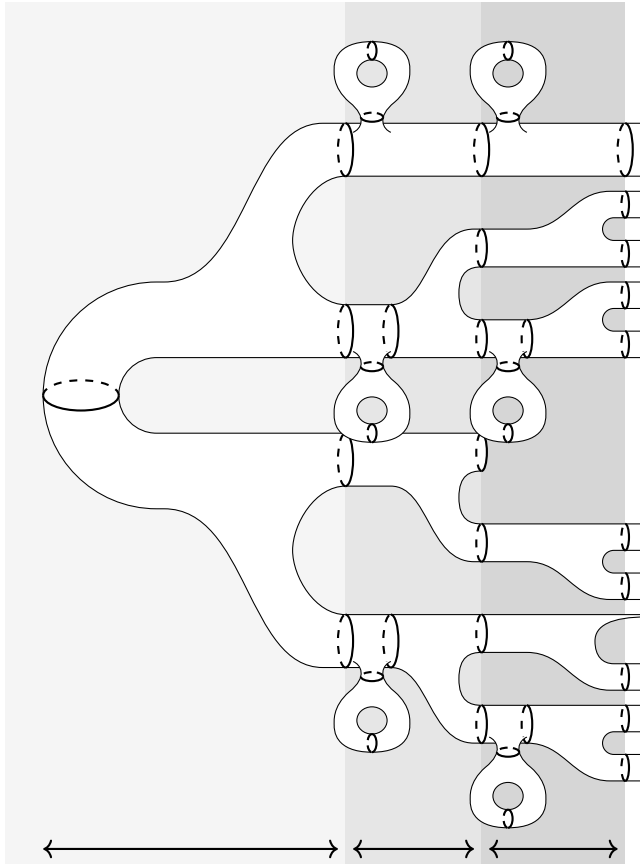

FIGURE 1. Pants decomposition of a surface of infinite type.

Here, geometric pants decomposition means a decomposition into subsurfaces homeomorphic to generalised pairs of pants, whose boundaries are geodesics.

Especially, a Nielsen-convex hyperbolic surface cannot contain a funnel or a hyperbolic half-plane. Thus, all isolated ends are punctures, that means, quotients of \mathbb{H} by parabolic elements. Conversely, a finite-type hyperbolic surface is Nielsen-convex if it does not contain funnels, or equivalently, if it has finite area. As a result, finite-type subsurfaces of a Nielsen-convex hyperbolic surface are again Nielsen-convex.

Let X be a hyperbolic surface. A curve C on X not bounding a puncture has a unique geodesic representative; we denote its length by $l_X(C)$. By an abuse of notation, we sometimes refer to the geodesic representative as C . Similarly, each arc A on X attains a unique geodesic representative. If C is bounding a puncture, it does not have a geodesic representative, and we conventionally set $l_X(C)$ by 0. Instead, it is associated to a representative called *horocycle*, a simple loop with uniform curvature. Then every

geodesic arc A emanating from that puncture intersects with the horocycle perpendicularly.

For a hyperbolic surface X , we define its *marked length spectrum* $\mathcal{L}^m(X) \in \mathbb{R}^{\mathbb{N}}$ by the function sending each essential or boundary curve C on X to its length $l_X(C)$. The (*unmarked*) *length spectrum* $\mathcal{L}(X)$ is the unordered set of curve lengths on X counting multiplicities. If we consider the quotient map $\varphi : \mathbb{R}^{\mathbb{N}} \rightarrow \mathbb{R}^{\mathbb{N}}/S_{\mathbb{N}}$ by permutations $S_{\mathbb{N}}$, then $\mathcal{L}(X)$ is the image of $\mathcal{L}^m(X)$ under φ .

2.2. Teichmüller space and moduli space. Teichmüller space of S can be defined in various ways. Those definitions are compatible if the base surface is of finite type, but not necessarily if the base surface is of infinite type. For details, see [FLP79], [IT92], [Hub06] or [ALP⁺11]. Our definition follows:

Definition 2.6. *The Teichmüller space $\mathcal{T}(S)$ of S is the set of equivalence classes $[f, X]$ of pairs (f, X) , where X is a Nielsen-convex hyperbolic surface of topological type S and $f : S \rightarrow X$ is a homeomorphism. Here, two pairs (f, X) and (g, Y) are considered equivalent if $g \circ f^{-1}$ is homotopic to an isometry.*

The (extended) mapping class group $\text{Mod}^{\pm}(S)$ of S is the set of equivalence classes $[f]$ of self-homeomorphism f on S , where f and g are considered equivalent if $g \circ f^{-1}$ is isotopic to the identity.

The moduli space $\mathcal{M}(S)$ is the set of Nielsen-convex hyperbolic surfaces of topological type S .

We note that $\text{Mod}^{\pm}(S)$ acts on $\mathcal{T}(S)$ by pre-composition, and the quotient of $\mathcal{T}(S)$ by $\text{Mod}^{\pm}(S)$ is equal to $\mathcal{M}(S)$.

In contrast to the case of finite-type surfaces, there are several (different) ways to give a topology on the Teichmüller space of infinite-type surfaces. Since our argument deals with finitely many curves at one time, our argument works for any topology on the Teichmüller space satisfying the following property.

Property 2.7. *Let $S_1 \subseteq S$ be a finite-type subsurface of S . Then the Teichmüller space $\mathcal{T}(S)$ of S can be decomposed into $\mathcal{T}(S_1)$ and another space $\mathcal{T}(S; S_1)$:*

$$\mathcal{T}(S) = \mathcal{T}(S_1) \times \mathcal{T}(S; S_1)$$

Moreover, we denote the projection to each factor by $\pi_{S_1} : \mathcal{T}(S) \rightarrow \mathcal{T}(S_1)$ and $\pi_{S; S_1} : \mathcal{T}(S) \rightarrow \mathcal{T}(S; S_1)$.

One way to equip $\mathcal{T}(S)$ with a topology satisfying Property 2.7 is to define the *Fenchel-Nielsen coordinates*. Let $[f, X]$ be an element of $\mathcal{T}(S)$. Recall that S is equipped with a seamed pants decomposition $\mathcal{P} = (\{C_i\}, \{A_j\})$. This induces a (topological) seamed pants decomposition $\mathcal{P}' = (\{C'_i := f(C_i)\}, \{A'_j := f(A_j)\})$ on X . Since X is Nielsen-convex, $\{C'_i\}$ can be

considered a geometric pants decomposition; we call $l_X(C'_i)$ the i -th *length parameter* of X .

If C'_i is two-sided, i.e., is not a boundary component, then we further define another parameter. We consider an arc A'_j that passes through pairs of pants P_t 's of X and curves C'_{k_t} 's (where $k_0 = i$) in the order of $\dots, P_t, C'_{k_t}, P_{t+1}, \dots$. We denote by L_t the geodesic segment on P_t perpendicular to $C'_{k_{t-1}}$ and C'_{k_t} . Then A'_j is homotopic to a concatenation $\dots K_{t-1}L_tK_tL_{t+1}\dots$ of L_t 's and geodesic segments K_t along C'_{k_t} , respectively. We define the signed length along $C'_{k_0} = C'_i$ using the orientation of the surface, in such a way that the (right) Dehn twist corresponds to the positive direction (cf. Subsection 2.5). Then the signed length of K_0 along $C'_{k_0} = C'_i$ divided by $l(C'_i)$ is called the i -th *twist parameter* $\tau_X(C'_i)$ of X . There are a priori two choices of twist parameter at C'_i , one defined with A'_j and one defined with another arc $A'_{j'}$ passing through C'_i . Nonetheless, two values are always equal so no confusion occurs.

Using the Fenchel-Nielsen parameters, we can construct a bijection

$$FN : \mathcal{T}(S) \ni [f, X] \mapsto \left((\log l_X(C'_i))_{i \in I}, (l_X(C'_i)\tau_X(C'_i))_{i \in I \setminus I_0} \right)$$

between $\mathcal{T}(S)$ and $\mathbb{R}^I \times \mathbb{R}^{I \setminus I_0}$. We now endow the space with the l^∞ -topology. In detail, we define the *Fenchel-Nielsen distance* d_{FN} between $[f, X], [g, Y] \in \mathcal{T}(S)$ by

$$d_{FN}([f, X], [g, Y]) := \sup_{i \in I} \left\{ \left| \log \frac{l_X(f(C_i))}{l_Y(g(C_i))} \right|, |l_X(f(C_i))\tau_X(f(C_i)) - l_Y(g(C_i))\tau_Y(g(C_i))| \right\}$$

where we set $\tau_X(f(C_i)) = \tau_Y(g(C_i)) = 0$ for $i \in I_0$.

Then the balls $B_r([f, X]) := \{[g, Y] \in \mathcal{T}(S) : d_{FN}([f, X], [g, Y]) < r\}$ generate the l^∞ -topology on $\mathcal{T}(S)$. If S is of infinite type, this space contains uncountably many components, each comprised of elements d_{FN} -bounded to each other.

Remark 2.8. *The Fenchel-Nielsen Teichmüller space was originally constructed in [ALP⁺11], whose convention differs with ours. Precisely, the convention in [ALP⁺11] picks a hyperbolic structure $[f, X_0]$ and considers the component of $\mathcal{T}(S)$ containing $[f, X_0]$ as the Fenchel-Nielsen Teichmüller space $\mathcal{T}(X_0)$. To see how the choice of basepoint X_0 affects the property of $\mathcal{T}(X_0)$, see [ALP⁺11].*

If S is of finite type, $\mathcal{T}(S)$ is a connected cell and is compatible with all other standard definitions (using quasiconformal maps or discrete and faithful representations to $\text{Isom}^+(\mathbb{H})$). Especially, the Fenchel-Nielsen parameters for different seamed pants decompositions give rise to the same analytic structure on $\mathcal{T}(S)$. The length of a curve on S then becomes an analytic function on $\mathcal{T}(S)$.

To see that the Fenchel-Nielsen topology satisfies the desired property, consider a surface S made by gluing a finite-type surface S_1 with another surface S_2 along curves $\{C_i\}_{i \in I_1}$. Then pants decompositions $\{C_i\}_{i \in I_1 \cup I_2}$ on S_1 and $\{C_i\}_{i \in I_1 \cup I_3}$ on S_2 give rise to a pants decomposition $\{C_i\}_{i \in I}$ on X_0 , where $I = I_1 \cup I_2 \cup I_3$. We can further construct a seamed pants decomposition $\mathcal{P} = (\{C_i\}_{i \in I}, \{A_j\}_{j \in J})$ on S , which gives seamed pants decomposition \mathcal{Q} and \mathcal{R} on S_1 and S_2 , respectively, by restriction. Then the Fenchel-Nielsen parametrisation of $\mathcal{T}(S)$ is decomposed into that of $\mathcal{T}(S_1)$, that of $\mathcal{T}(S_2)$ (omitting the length parameters for I_1), and twist parameters for I_1 . Thus, $\mathcal{T}(S)$ is the product space of $\mathcal{T}(S_1)$ and another space $\mathcal{T}(S; S_1)$ as desired.

Now we impose a measure on $\mathcal{T}(S)$. If S is of finite type, we can come up with one standard measure, Weil-Petersson measure, on $\mathcal{T}(S)$. In contrast, it is not clear which measure is reasonable for surfaces of infinite type. Together with a topology satisfying Property 2.7, we consider a measure ρ on $\mathcal{T}(S)$ so that the following property holds.

Property 2.9. *Let $S_1 \subseteq S$ be a finite-type subsurface of S and $N \subseteq \mathcal{T}(S_1)$ be of Weil-Petersson measure 0. Then $\pi_{S_1}^{-1}(N) \subseteq \mathcal{T}(S)$ is of ρ -measure 0.*

Again, we can indeed obtain a measure on $\mathcal{T}(S)$ satisfying Property 2.9 as follows. Let us keep the notations in defining Fenchel-Nielsen coordinates above. In addition, let m be the standard Lebesgue measure on \mathbb{R} and $dm' = e^x dm$. We consider the product measure

$$\mu = \left(\otimes_{i \in I} m' \right) \otimes \left(\otimes_{i \in I \setminus I_0} m \right)$$

on $\mathbb{R}^I \times \mathbb{R}^{I \setminus I_0}$, as defined in [Bak04]. This measure enjoys the following property: if $\{R'_i\}_{i \in I}$, $\{R_i\}_{i \in I_0}$ are Borel sets in \mathbb{R} , depending on the index, then

$$\mu \left(\prod_{i \in I} R'_i \times \prod_{i \in I \setminus I_0} R_i \right) = \left(\prod_{i \in I} m'(R'_i) \right) \times \left(\prod_{i \in I \setminus I_0} m(R_i) \right). \quad (\dagger)$$

This measure induces a pullback measure ρ_{WP} on $\mathcal{T}(S)$ by the map FN . Note that if S is of finite type, ρ_{WP} is equal to the Weil-Petersson measure on $\mathcal{T}(S)$. In general, the following lemma holds:

Lemma 2.10. *Property 2.9 holds for ρ_{WP} .*

This lemma follows immediately from Property (\dagger) .

2.3. Intersection number. Let us first assume that α , β are oriented multicurves on S . Let A , B be representatives of α and β , respectively, transversing each other at a point p . The *index* of (A, B) at p is defined as +1 if tangent vectors (A_p, B_p) agree with the orientation of the surface, and -1 otherwise. We further define the *algebraic intersection number* of α and β by the sum of indices of (A, B) over all intersection points, and denote it by $i_{alg}(\alpha, \beta)$. Note that the value of algebraic intersection number does not

depend on the choice of representatives A and B . It does depend on the orientations of α and β but is well-defined up to sign.

However, the total number of intersection points depends on the choice of representatives. The minimum of such number is called the *geometric intersection number*, denoted by $i_{geom}(\alpha, \beta)$ (or $i(\alpha, \beta)$ in short). Note that geometric intersection number is well-defined for unoriented multicurves also. Representatives A, B of α, β realizing $i(\alpha, \beta)$ are said to be *in minimal position*. The following fact serves as a practical criterion for representatives in minimal position.

Fact 2.11. [FLP79, Proposition 3.10] *Representatives A, B of two multicurves are in minimal position if and only if A and B do not form a bigon, a null-homotopic region of $S \setminus (A \cup B)$ bounded by one segment of A and one segment of B .*

We introduce an abuse of notation as follows: curves α and β may also refer to representatives A and B of α and β , respectively, in minimal position. Such representatives are chosen up to simultaneous ambient isotopy thanks to the following fact.

Fact 2.12. [FM12, Lemma 2.9] *Let S be a finite-type surface, γ_1, γ_2 be distinct essential curves on S , and c_i, c'_i be representatives of γ_i . Then there exists an isotopy of S that takes c'_i to c_i for all i simultaneously.*

The intersection numbers with finitely many curves are sufficient to determine a multicurve. This fact is due to Dehn and Thurston, and we record one variant suited for our purpose.

Fact 2.13. *cf.* [FLP79, Théorème 4.8] *Let $\{B_1, \dots, B_m, C_1, \dots, C_n\}$ be a pants decomposition of a finite-type surface, where B_i 's are boundary curves. Then there exist curves $\{C'_i, C''_i\}_{i=1}^n$ on the surface satisfying the following:*

- (1) $i(C_i, C'_j) = 0 \Leftrightarrow i \neq j \Leftrightarrow i(C_i, C''_j) = 0$, and
- (2) *if D, D' are distinct essential multicurves (i.e., not containing boundary curves), then we have $i(D, C) \neq i(D', C)$ for at least one $C \in \{C_i, C'_i, C''_i\}$.*

Here C'_i and C''_i are used to measure the ‘twist’ of multicurves along C_i 's. See also Fact 2.18.

2.4. Pinching a length. Let α be a curve on S . Since α is compact, it is contained in a finite-type subsurface S_1 . Now for each $[X, f] \in \mathcal{T}(S)$, the curve $f(\alpha)$ has its geodesic representative A on X realising the minimum length. Abusing notation, we denote $l_X(A)$ by $l_X(\alpha)$. Then the function $l_X(\alpha)$ is continuous on $\mathcal{T}(S)$ and descends to an analytic function on $\mathcal{T}(S_1)$.

We state a lemma regarding the pinching process, whose proof is deferred to Appendix C. The pinching process is, roughly speaking, fixing a simple closed curve and then making its length to converge to 0. For a detailed discussion, see [Wol90].

Let $\{C_1, C_2, \dots\}$ be a pants decomposition on S and $X \in \mathcal{T}(S)$. Pinching the length of C_1 means that we follow the path $\{X_r\}_{r>0} \subseteq \mathcal{T}(S)$ where

$$l_{X_r}(C_i) = \begin{cases} r & i = 1 \\ l_X(C_i) & i \neq 1 \end{cases}, \quad \tau_{X_r}(C_i) = \tau_X(C_i) \quad \text{for all } i.$$

Lemma 2.14. *Let α be a multicurve on S with $i(\alpha, C_1) = k$.*

- (1) *If $k = 0$, then $l_{X_r}(\alpha)$ converges to a finite value as $r \rightarrow 0$.*
- (2) *If $k > 0$, then $\lim_{r \rightarrow 0} l_{X_r}(\alpha) / \ln r = -2k$.*

2.5. Fractional Dehn twists. Let α be a curve and β be a multicurve with $i(\alpha, \beta) = k$. By abuse of notation, suppose that α and β are in minimal position. To define the fractional Dehn twist $T_\alpha^j(\beta)$ for $j \in \mathbb{Z}$, let us take an annular neighborhood

$$N = S^1 \times [-1, 1] = \{(e^{2\pi is}, t) : s \in [0, 1], t \in [-1, 1]\}$$

of α , where the parametrisation respects the orientation on N . In other words, the vector $(\partial/\partial s, \partial/\partial t)$ is positively oriented with respect to the orientation on the surface. We assume that α is parametrized by $[0, 1] \rightarrow N$, $s \mapsto (e^{2\pi is}, 0)$ and $\beta \cap N = \{(e^{\frac{2\pi ni}{k}}, t) : t \in [-1, 1], n = 1, \dots, k\}$.

We now define a homeomorphism $\varphi : N \rightarrow N$ by

$$\varphi(z, t) = \begin{cases} (ze^{\frac{2\pi jt}{k}}, t) & , t \in [0, 1] \\ (z, t) & , t \in [-1, 0]. \end{cases}$$

We then extend φ to Φ on the whole surface by setting Φ to be an identity outside of N . Even though Φ may not be continuous on the surface, $\Phi(\beta)$ is an unoriented multicurve on the surface. We define the fractional Dehn twist

$$T_\alpha^j(\beta) := \Phi(\beta).$$

We note that the definition of $T_\alpha^j(\beta)$ does not depend on the representatives of curves we chose, thanks to Fact 2.12.

Remark 2.15. *The fractional Dehn twist should be distinguished from the roots of Dehn twists that Margalit and Schleimer introduced in [MS09]. The latter ones are mapping classes while the former ones are a priori not defined so. As a result, the latter ones always send a single curve to another single curve while the former ones may not.*

Note that the superscript notation is consistent with composition. Indeed, we observe that $T_\alpha^{i+j}(\beta) = T_\alpha^i(T_\alpha^j(\beta))$ for $i, j \in \mathbb{Z}$. Also note that $T_\alpha^k(\beta)$ is merely a right Dehn twist of β along α . We now record two facts on the intersection number and fractional Dehn twists.

Fact 2.16. [FM12, Proposition 3.4] *Let α, β, γ be a curve on a surface S and $i(\alpha, \beta) = k \geq 1$. Then*

$$\left| i(T_\alpha^{nk}(\beta), \gamma) - nki(\alpha, \gamma) \right| \leq i(\beta, \gamma).$$

Lemma 2.17. $i(T_\alpha^j(\beta), \alpha) = i(\alpha, \beta)$ and $i(T_\alpha^j(\beta), \beta) = |j|i(\alpha, \beta)$.

Proof. In this proof, we denote by $N(\gamma)$ an annular neighborhood of a curve γ .

We temporarily orient β and fix a representative C of $T_\alpha^j(\beta)$ as in Figure 2. Here, segments of C parallel to β (called type B) is drawn on the left side of β if j is positive, and on the right side otherwise.

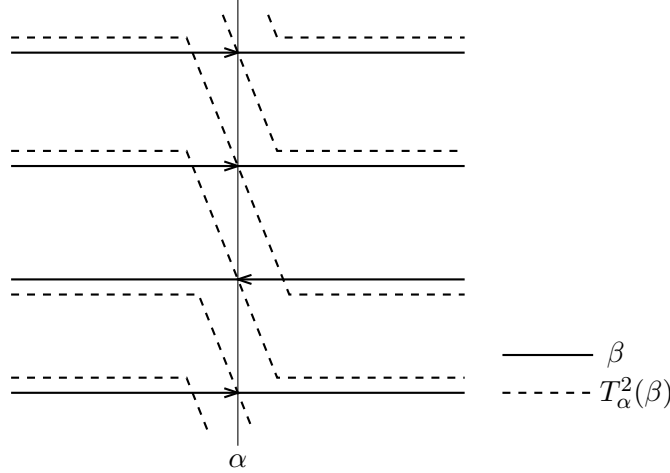

FIGURE 2. α , β and $T_\alpha^2(\beta)$. Here β is equipped with an orientation in order to determine a representative of $T_\alpha^2(\beta)$ in minimal position with α and β .

C also has segments in $N(\alpha) \setminus \beta$ (called type A), which are classified further into two subtypes: the shorter ones (called type A_1) and the longer ones (called type A_2). See Figure 3. We observe in Figure 3 that

- (1) each type B segment and β are disjoint;
- (2) each type B segment either closes itself, or is sandwiched by a type A_1 segment and a type A_2 segment;
- (3) each type A_1 segment is adjacent to a type B segment and β .

We claim that the curves in Figure 2 are indeed in minimal position. First, a complementary region of $T_\alpha^j(\beta) \cup \alpha$ can be isotoped to a complementary region of $\alpha \cup \beta$. Since α and β are assumed to be in minimal position, such complementary regions are not bigons. Consequently, $T_\alpha^j(\beta)$ and α are also in minimal position.

We now discuss the minimal position of $T_\alpha^j(\beta)$ and β . To this end, suppose to the contrary that a segment τ of $T_\alpha^j(\beta)$ and a segment σ of β bound a bigon. From the observation, τ falls into one of the following.

- τ consists of only one type A_2 segment a_2 ;
- τ is a concatenation of type A_1 segment a_1 , type B segment b_1 and type A_2 segment a_2 ; or

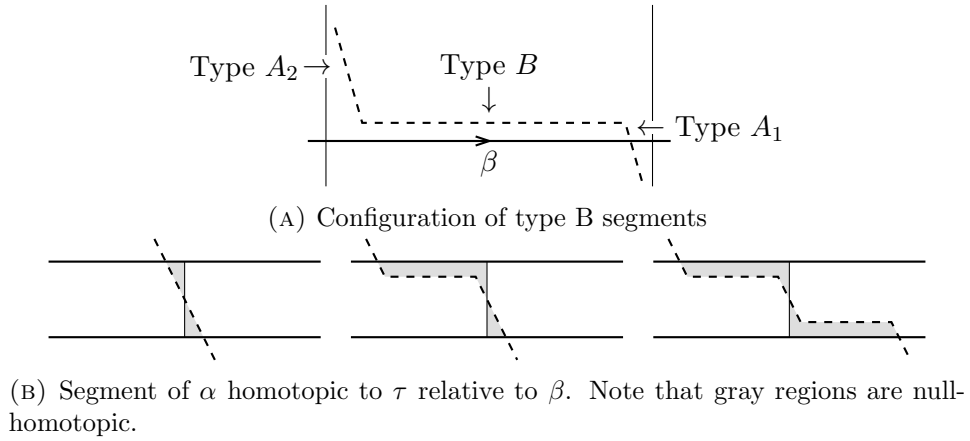
FIGURE 3. Configurations of β and C

- τ is a concatenation of type A_1 segment a_1 , type B segment b_1 and type A_2 segment a_2 , type B segment b_2 and type A_1 segment a_3 .

In any case, τ is homotopic (relative to β) to a segment of α ; we deduce that α and β bound a bigon, contradicting to the minimal position assumption. Thus, we conclude that $T_\alpha^j(\beta)$ and β are also in minimal position.

Given this conclusion, the intersection numbers follow immediately. \square

We will make use of the following variant of Fact 2.13 later on to characterise the fractional Dehn twists.

Fact 2.18. *Let S be a surface of finite type and $\{C_i, C'_i, C''_i\}_{i=1}^n$ be the curves on S mentioned in Fact 2.13. Fix j and suppose that D, D' are essential multicurves satisfying $i(C_i, D) = i(C_i, D')$ for all i , $i(C'_i, D) = i(C'_i, D')$ for $i \neq j$, and $i(C''_i, D) = i(C''_i, D')$ for $i \neq j$. Then D and D' only differ by a fractional Dehn twist along C_j .*

3. LENGTH IDENTITIES

In this section, we show how length identities of curves record their topological configuration. This is a converse procedure of previously known result, introduced in Subsection 3.1.

We begin by referring to a theorem of McShane and Parlier.

Theorem 3.1. [MP08, Theorem 1.1] *For each distinct essential or boundary curves α, β on a surface S of finite type, there exists a connected analytic submanifold $E(\alpha, \beta)$ of $\mathcal{T}(S)$ such that $l_X(\alpha) \neq l_X(\beta)$ for $X \in \mathcal{T}(S) \setminus E(\alpha, \beta)$. Consequently, points in $\mathcal{T}(S) \setminus \bigcup_{\alpha \neq \beta} E(\alpha, \beta)$ have simple length spectra.*

This theorem asserts that essential or boundary curves on S are faithfully labelled by their lengths at almost every point of $\mathcal{T}(S)$, although not everywhere. Note that this can be generalised to surfaces of infinite type as

follows. Let α, β be distinct curves on a surface S of infinite type. Since curves are compact, they are contained in some finite-type subsurface S_1 of S bounded by some curves C_{i_1}, \dots, C_{i_n} . Then $l_X(\alpha) - l_X(\beta)$ becomes a non-constant analytic function on $\mathcal{T}(S_1)$. By Theorem 3.1, there exists a submanifold E of $\mathcal{T}(S_1)$ such that $l_X(\alpha) - l_X(\beta)$ does not vanish outside E . Since E is nowhere dense, $\tilde{E} := \pi_{S_1}^{-1}(E) \subseteq \mathcal{T}(S)$ is also nowhere dense. Moreover, submanifolds in $\mathcal{T}(S_1)$ are of WP-measure 0 so \tilde{E} is ρ -measure 0 by Property 2.9.

The key observation for Theorem 3.1 is that $E(\alpha, \beta)$ is the zero locus of a non-constant analytic function $l_X(\alpha) - l_X(\beta)$ of X on $\mathcal{T}(S)$. The purpose of this section is proving analogous results for other length identities.

3.1. From topological configurations to length identities. Here we review classical length identities of curves on hyperbolic surfaces. For details, see [KF12], [McK72] or [Luo98]. Given curves η_1, η_2 on a surface S , we define the following functions on $\mathcal{T}(S)$:

$$f(X; \eta_1, \eta_2) := 2 \cosh \frac{l_X(\eta_1)}{2} \cosh \frac{l_X(\eta_2)}{2},$$

$$g(X; \eta_1, \eta_2) := \cosh \frac{l_X(\eta_1)}{2} + \cosh \frac{l_X(\eta_2)}{2}.$$

Both $f(X; \eta_1, \eta_2)$ and $g(X; \eta_1, \eta_2)$ are functions on $\mathcal{T}(S)$ with infimum 2. Moreover, if $\lim_r f(X_r; \eta_1, \eta_2) = 2$ or $\lim_r g(X_r; \eta_1, \eta_2) = 2$ for some path $\{X_r\} \subseteq \mathcal{T}(S)$, then both $l_{X_r}(\eta_1), l_{X_r}(\eta_2)$ converge to 0. We also note that $l_X(\eta)$ becomes a constant function over $\mathcal{T}(S)$ if η is bounding a puncture.

Now let α, γ be two curves on S with $i(\alpha, \gamma) = 1$. Then $\alpha \cup \gamma$ becomes a spine of a one-holed/punctured torus with boundary $\delta := \alpha\gamma\alpha^{-1}\gamma^{-1}$. See Figure 4.

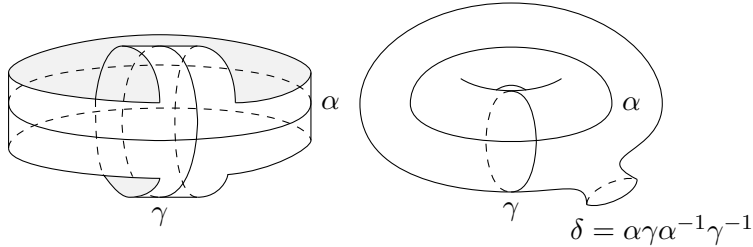

FIGURE 4. One-holed torus with spine $\alpha \cup \gamma$

Fact 3.2. *Let α and γ be as above. Then $f(X; \alpha, \gamma) = g(X; T_\gamma^1(\alpha), T_\gamma^{-1}(\alpha))$ identically holds on $\mathcal{T}(S)$.*

We then set $\alpha_i := T_\gamma^i(\alpha)$ and $\gamma_i := T_\alpha^i(\gamma)$. Note that

$$i(\gamma, \alpha_i) = i(\alpha_{i-1}, \alpha_i) = 1 \text{ and } i(\alpha, \gamma_i) = i(\gamma_{i-1}, \gamma_i) = 1.$$

Moreover, one of $\{T_{\alpha_i}^{\pm 1}(\alpha_{i-1})\}$ is γ ; we denote the other one by β_i . Similarly, one of $\{T_{\gamma_i}^{\pm 1}(\gamma_{i-1})\}$ is α and we denote the other one by ϵ_i . See Figure 5.

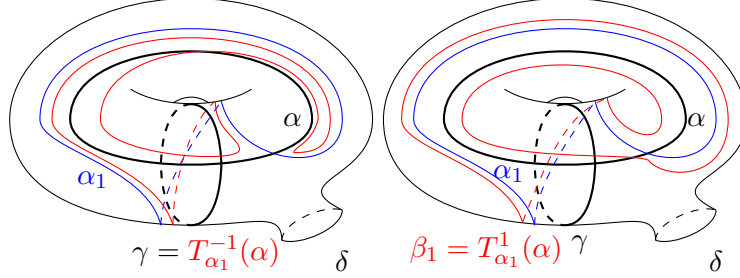

FIGURE 5. Fractional Dehn twists of α along α_1

Lemma 3.3. *For each $i \in \mathbb{Z}$ and any of $(\eta_1, \eta_2, \eta_3, \eta_4) = (\alpha_i, \gamma_0, \alpha_{i-1}, \alpha_{i+1})$, $(\alpha_{i-1}, \alpha_i, \gamma_0, \beta_i)$, $(\gamma_i, \alpha_0, \gamma_{i-1}, \gamma_{i+1})$, $(\gamma_{i-1}, \gamma_i, \alpha_0, \epsilon_i)$, the identity*

$$(3.1) \quad f(X; \eta_1, \eta_2) = g(X; \eta_3, \eta_4)$$

holds on entire $\mathcal{T}(S)$.

This time, we consider α, γ satisfying $i_{alg}(\alpha, \gamma) = 0$ and $i_{geom}(\alpha, \gamma) = 2$. Then $\alpha \cup \gamma$ becomes a spine of an immersed subsurface $\psi : S' \rightarrow S$ where S' is a generalised shirt. This shirt is accompanied by peripheral curves $\delta_1, \dots, \delta_4$. They are labelled in such a manner that γ separates $\{\delta_1, \delta_2\}$ from $\{\delta_3, \delta_4\}$ and α separates $\{\delta_1, \delta_3\}$ from $\{\delta_2, \delta_4\}$. Note that $T_{\gamma}^{\pm 1}(\alpha)$ then separates $\{\delta_2, \delta_3\}$ from $\{\delta_1, \delta_4\}$; see Figure 6.

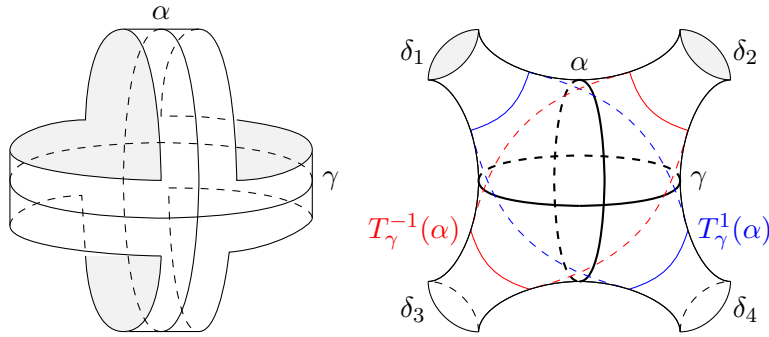

FIGURE 6. A shirt with spine $\alpha \cup \gamma$

Fact 3.4. *Let $\alpha, \gamma, \{\delta_i\}$ be as above. Then the identity*

$$f(\alpha, \gamma) = g(T_{\gamma}^1(\alpha), T_{\gamma}^{-1}(\alpha)) + f(\delta_2, \delta_3) + f(\delta_1, \delta_4)$$

holds on entire $\mathcal{T}(S)$.

We now set $\alpha_i := T_\gamma^i(\alpha)$ and $\gamma_i := T_\alpha^i(\gamma)$. Then

$$i_{alg}(\gamma, \alpha_i) = i_{alg}(\alpha, \gamma_i) = i_{alg}(\alpha_{i-1}, \alpha_i) = i_{alg}(\gamma_{i-1}, \gamma_i) = 0$$

and

$$i_{geom}(\gamma, \alpha_i) = i_{geom}(\alpha, \gamma_i) = i_{geom}(\alpha_{i-1}, \alpha_i) = i_{geom}(\gamma_{i-1}, \gamma_i) = 2$$

hold. Consequently, one of $\{T_{\alpha_i}^{\pm 1}(\alpha_{i-1})\}$ ($\{T_{\gamma_i}^{\pm 1}(\gamma_{i-1})\}$, resp.) is γ (α , resp.) and the other one is denoted by β_i (ϵ_i , resp.).

Lemma 3.5. *For each $i \in \mathbb{Z}$ and any of*

$$(\eta_1, \dots, \eta_8) = \begin{cases} (\alpha_{2i}, \gamma_0, \alpha_{2i-1}, \alpha_{2i+1}, \delta_2, \delta_3, \delta_1, \delta_4) \\ (\alpha_{2i+1}, \gamma_0, \alpha_{2i}, \alpha_{2i+2}, \delta_1, \delta_3, \delta_2, \delta_4) \\ (\gamma_{2i}, \alpha_0, \gamma_{2i-1}, \gamma_{2i+1}, \delta_2, \delta_3, \delta_1, \delta_4) \\ (\gamma_{2i+1}, \alpha_0, \gamma_{2i}, \gamma_{2i+2}, \delta_1, \delta_2, \delta_3, \delta_4) \\ (\alpha_{i-1}, \alpha_i, \gamma_0, \beta_i, \delta_1, \delta_2, \delta_3, \delta_4) \\ (\gamma_{i-1}, \gamma_i, \alpha_0, \epsilon_i, \delta_1, \delta_3, \delta_2, \delta_4) \end{cases},$$

the identity

$$(3.2) \quad f(\eta_1, \eta_2) = g(\eta_3, \eta_4) + f(\eta_5, \eta_6) + f(\eta_7, \eta_8)$$

holds on entire $\mathcal{T}(S)$.

3.2. First length identity: one-holed/punctured torus. We now discuss the converse of Lemma f 3.3. For the converse of Lemma 3.5, see Subsection 3.3. The following lemma partially relates the length identities with the configuration of the curves involved.

Lemma 3.6. *Let $\alpha_{-2}, \alpha_{-1}, \alpha, \alpha_1, \alpha_2, \gamma, \beta_0, \beta_1$ be essential or boundary curves on S , where $\alpha, \alpha_{-1}, \alpha_1$ and γ are distinct. If the inequalities*

$$(3.3a) \quad f(X; \alpha, \gamma) \geq g(X; \alpha_{-1}, \alpha_1),$$

$$(3.3b) \quad f(X; \alpha_{-1}, \gamma) \geq g(X; \alpha_{-2}, \alpha),$$

$$(3.3c) \quad f(X; \alpha_1, \gamma) \geq g(X; \alpha, \alpha_2),$$

$$(3.3d) \quad f(X; \alpha, \alpha_1) \geq g(X; \gamma, \beta_1),$$

$$(3.3e) \quad f(X; \alpha_{-1}, \alpha) \geq g(X; \gamma, \beta_0)$$

are satisfied by all $X \in \mathcal{T}(S)$, then

$$i(\alpha, \gamma) > 0 \text{ and } \{\alpha_1, \alpha_{-1}\} = \{T_\gamma^1(\alpha), T_\gamma^{-1}(\alpha)\}.$$

Proof. Suppose first that $i(\alpha, \gamma) = 0$. We fix a pants decomposition containing α and γ , and pinch them simultaneously. Since $\alpha_{\pm 1}$ are neither α nor γ , their lengths tend to either infinity (if they intersect with α or γ) or a finite value (if they do not intersect with α and γ). Thus, $f(X; \alpha, \gamma)$ tends to 2 while $g(X; \alpha_{-1}, \alpha_1)$ converges to a term greater than 2. This contradicts to Inequality 3.3a, and we conclude $i(\alpha, \gamma) > 0$. In particular, both α, γ are essential.

Now we fix a pants decomposition containing α and pinch α . Then $f(X; \alpha, \gamma)$ grows in the order of $l(\alpha)^{-i(\alpha, \gamma)}$, while $g(X; \alpha_{-1}, \alpha_1)$ grows in the order of $l(\alpha)^{-\max(i(\alpha, \alpha_{-1}), i(\alpha, \alpha_1))}$. From this and Inequality 3.3a, we deduce that $i(\alpha, \gamma) \geq i(\alpha, \alpha_{\pm 1})$.

Meanwhile, $f(\alpha_{-1}, \alpha)$ grows in the order of $l(\alpha)^{-i(\alpha, \alpha_{-1})}$ while $g(\gamma, \beta_0)$ grows in the order of $l(\alpha)^{-\max(i(\alpha, \gamma), i(\alpha, \beta_0))}$. Then Inequality 3.3e implies that $i(\alpha, \alpha_{-1}) \geq i(\alpha, \gamma)$. Similarly, investigating each side of Inequality 3.3d yields that $i(\alpha, \alpha_1) \geq i(\alpha, \gamma)$. Thus, we obtain

$$(3.4) \quad i(\alpha, \alpha_{\pm 1}) = i(\alpha, \gamma).$$

Next, we fix a pants decomposition containing γ and pinch γ . We again investigate Inequality 3.3a to deduce that $i(\gamma, \alpha) \geq i(\gamma, \alpha_{\pm 1})$. The reverse inequalities are now obtained from Inequality 3.3b and 3.3c and we conclude

$$(3.5) \quad i(\alpha, \gamma) = i(\alpha_{\pm 1}, \gamma).$$

Finally, we consider arbitrary interior curve η disjoint from γ , fix a pants decomposition containing γ and η , and pinch η . Once again, Inequality 3.3a, 3.3b and 3.3c tell us that

$$(3.6) \quad i(\alpha, \eta) = i(\alpha_{\pm 1}, \eta).$$

Combined with Equation 3.5 and 3.6, Fact 2.18 implies that α , α_{-1} , α_1 differ only by twists at γ . Then Lemma 2.17 reads Equation 3.4 as $\{\alpha_1, \alpha_{-1}\} = \{T_\gamma^1(\alpha), T_\gamma^{-1}(\alpha)\}$. (Here we used the condition that α_{-1} and α_1 are distinct) \square

Before stating the next lemma, we first introduce some notations. Let α , γ be two curves on S with $k = i(\alpha, \beta) > 1$. Then α is cut by γ into k segments $\{a_1, \dots, a_k\}$ and γ is cut by α into k segments $\{c_1, \dots, c_k\}$. Each segment a_i then splits γ into two segments, giving a partition of $\{c_j\}$. The segment with fewer c_j 's is denoted by $\gamma(a_i)$ and its number of c_j 's is denoted by $N_\gamma(a_i)$. (If two numbers equal, then take any segment.) See Figure 7.

The annular neighborhood of γ is separated by γ into two sides, which we label by left and right from now on. Then $\{a_i\}$ is partitioned into three collections, A_1 , A_2 and A_3 . A_1 (A_2 , resp.) consists of those segments departing from and arriving to γ on the left side (right side, resp.); A_3 consists of those segments connecting two sides of γ .

Recall that a fractional Dehn twist of a curve along another curve is a priori a multicurve, not necessarily a curve.

Lemma 3.7. *Let α , γ be curves on S with $k = i(\alpha, \gamma) > 1$. If $T_\alpha^i(\gamma)$ and $T_\gamma^i(\alpha)$ are single curves for $i = 0, 1, \dots, k-1$, then*

- (1) $A_3 = \emptyset$ and k is even,
- (2) the indices of (α, γ) alternate along each of α and γ , and
- (3) $N_\gamma(a_i)$ is odd for each segment $a_i \in A_1 \cup A_2$.

If $k > 2$ moreover, then

- (4) $N_\gamma(a_i) \neq N_\gamma(a_{i'})$ for all $a_i \in A_1$ and $a_{i'} \in A_2$.

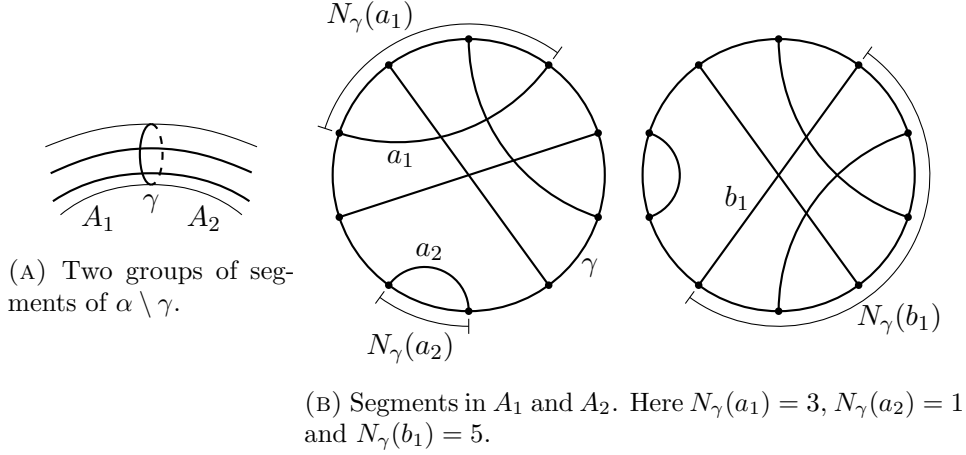

FIGURE 7. Grouping segments

Proof. We first suppose that one segment of $\alpha \setminus \gamma$ joins two sides of γ . Then some twist T_γ^i will tie this segment into a closed curve, while other segments of $\alpha \setminus \gamma$ will constitute at least one more curve. This contradicts to the assumption that $\alpha_i = T_\gamma^i(\alpha)$ is a single curve. Thus, $A_3 = \emptyset$ and $\alpha \setminus \gamma$ is partitioned into A_1 and A_2 . Since $|A_1| = |A_2|$, their sum k is even. This proves (1).

We then observe that the indices of (α, γ) at endpoints of each a_i are different. This implies that the indices alternate along α . Similarly, the indices alternate along γ , proving (2).

Now fix an a_i with endpoints p and q , separating γ into two segments Γ_1 and Γ_2 . Without loss of generality, assume that the index of (α, γ) is 1 at p and -1 at q . Since the indices of (α, γ) alternate along γ , the number of c_j 's along Γ_1 is odd. Similarly, the number of c_j 's along Γ_2 is odd, so their minimum $N_\gamma(a_i)$ is also odd. Now (3) follows.

Now suppose further that $i(\alpha, \gamma) > 2$. If $N_\gamma(a_i) = N_\gamma(a_{i'})$ for some $a_i \in A_1$ and $a_{i'} \in A_2$, then some twist T_γ^j will tie them into a single curve, while other segments will constitute at least one more curve. This again contradicts to the assumption, so it cannot happen. It completes the proof of (4). \square

Proposition 3.8. *Let $\{\alpha_i, \beta_i, \gamma_i, \epsilon_i\}_{i \in \mathbb{Z}}$ be essential or boundary curves on S , where $\{\alpha_i\}_{i \in \mathbb{Z}} \cup \{\gamma_0\}$ and $\{\gamma_i\}_{i \in \mathbb{Z}} \cup \{\alpha_0\}$ are collections of distinct curves.*

Suppose that for each of

$$(\eta_1, \dots, \eta_4) = \left\{ \begin{array}{l} (\alpha_i, \gamma_0, \alpha_{i-1}, \alpha_{i+1}) \\ (\alpha_{i-1}, \alpha_i, \gamma_0, \beta_i) \\ (\gamma_i, \alpha_0, \gamma_{i-1}, \gamma_{i+1}) \\ (\gamma_{i-1}, \gamma_i, \alpha_0, \epsilon_i) \end{array} \right\},$$

Equation 3.1 holds for every $X \in \mathcal{T}(S)$. Then

$$i(\alpha_i, \gamma_0) = 1 \text{ and } \{\alpha_1, \alpha_{-1}\} = \{T_{\gamma_0}^1(\alpha_0), T_{\gamma_0}^{-1}(\alpha_0)\}.$$

Proof. For convenience, we will denote α_0 by α and γ_0 by γ . Since f and g are symmetric with respect to the curves involved, the assumption still holds after relabelling α_i into α_{-i} and β_i into β_{-i+1} . We will perform such relabelling in case α_1 is equal to $T_\gamma^{-1}(\alpha)$. Similarly, we relabel γ_i into γ_{-i} and ϵ_i into ϵ_{-i+1} in case γ_1 is equal to $T_\alpha^{-1}(\gamma)$.

Step 1. Proving that $\alpha_i = T_\gamma^i(\alpha)$ and $\gamma_i = T_\alpha^i(\gamma)$ for $i \geq -1$.

Now, Lemma 3.6 implies $i(\alpha, \gamma) > 0$ and $\{\alpha_1, \alpha_{-1}\} = \{T_\gamma^1(\alpha), T_\gamma^{-1}(\alpha)\}$. However, α_1 is not equal to $T_\gamma^{-1}(\alpha)$ due to the relabelling procedure. Thus we obtain that $\alpha_i = T_\gamma^i(\alpha)$ for $i = -1, 0, 1$.

We further assume $\alpha_i = T_\gamma^i(\alpha)$ for $i = -1, 0, \dots, n$ as the induction hypothesis. Applying Lemma 3.6 to curves $(\alpha_{n-2}, \dots, \alpha_{n+2}, \gamma, \beta_n, \beta_{n+1})$, we deduce that $\alpha_{i+1} = T_\gamma^1(\alpha_i) = T_\gamma^{i+1}(\alpha)$. Thus, by the mathematical induction, we conclude that $\alpha_i = T_\gamma^i(\alpha)$ for $i \geq -1$. Exactly the same argument shows that $\gamma_i = T_\alpha^i(\gamma)$ for $i \geq -1$.

Step 2. Proving that $i(\alpha, \gamma) = 1$.

Let $k := i(\alpha, \gamma)$, and first assume that $k > 2$. Then by Lemma 3.7, the segments of $\alpha \setminus \gamma$ are partitioned into $A_1 = \{a_1, \dots, a_{k/2}\}$ and $A_2 = \{b_1, \dots, b_{k/2}\}$. Moreover, $N_1 := \{N_\gamma(a_i) : a_i \in A_1\}$ and $N_2 := \{N_\gamma(b_i) : b_i \in A_2\}$ become disjoint sets of odd integers.

Without loss of generality, assume $\min N_1 > \min N_2$ and $N_\gamma(a_j) = \min N_1$. We pick b_l such that $N_\gamma(b_l) = \max\{n \in N_2 : n < \min N_1\}$. Note that $1 \leq N(b_l) \leq N_\gamma(a_j) - 2$.

Some fractional Dehn twist T_γ^i ties a_j with b_l in a manner that $\gamma(a_j)$, $\gamma(b_l)$ overlap each other. In other words, a_j is adjacent to b_l in $\alpha_i = T_\gamma^i(\alpha)$. b_l is then adjacent to yet another segment $a_{j'}$ in α_i . We now define a curve σ by concatenating a_j , $a_{j'}$ and b_l twice, together with two segments c_1 , c_2 along γ as in Figure 8.

The number of segments of $\gamma \setminus \alpha_i$ present in Figure 8 is at most

$$N_\gamma(a_j) + \max\{N_\gamma(a_{j'}), k - N_\gamma(a_{j'})\} - N_\gamma(b_l) \leq N_\gamma(a_j) + (k - N_\gamma(a_j)) - 1 < k.$$

Thus, c_1 and c_2 do not overlap and σ is indeed a simple curve. We also note that c_1 contains at least

$$N_\gamma(a_j) - N_\gamma(b_l) \geq 2$$

segments of $\gamma \setminus \alpha$, and so does c_2 . We now claim the following lemma.

Lemma 3.9. $i(\sigma, \gamma) = 4$ and $i(\sigma, T_\gamma^{\pm 1}(\alpha_i)) \leq i(\sigma, \alpha_i) + 2$.

We postpone the proof of this lemma at the moment and finish the proof of the theorem. Consider a pants decomposition on S containing σ and pinch σ . Then $f(\alpha_i, \gamma)$ grows in the order of $l(\sigma)^{-i(\alpha_i, \sigma)-4}$, while $g(T_\gamma^1(\alpha_i), T_\gamma^{-1}(\alpha_i))$ grows in the order of $l(\sigma)^{-i(\alpha_i, \sigma)-2}$ at most. This contradiction rules out the case that $i(\alpha, \gamma) > 2$.

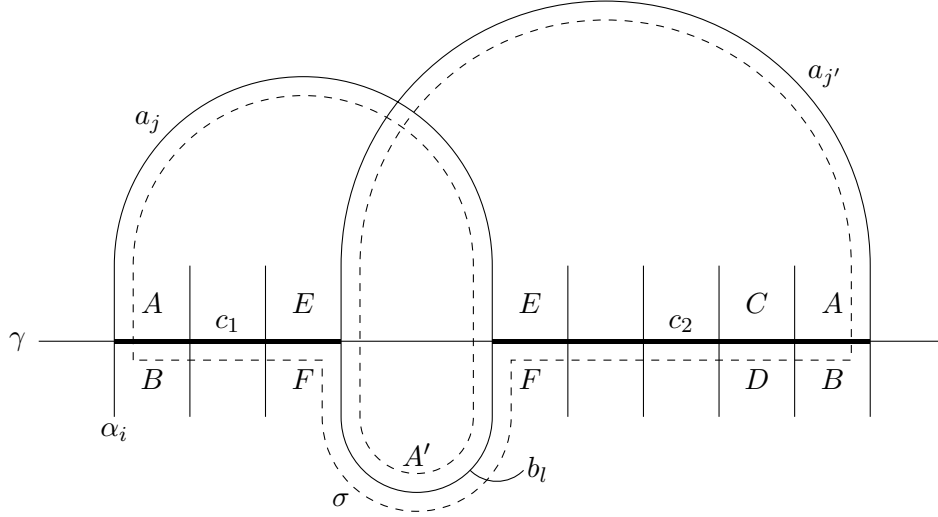

FIGURE 8. Configurations of α_i and σ . Here α_i and γ are presented in minimal position. Note that σ and α_i are intersecting at 6 points.

In conclusion, α and γ satisfy either

- (1) $i(\alpha, \gamma) = 1$ or
- (2) $i(\alpha, \gamma) = 2$.

Let us assume the latter case. Note that Lemma 3.7 asserts $i_{alg}(\alpha, \gamma) = 0$. Thus, $f(X; \alpha, \gamma) \equiv g(X; T_\alpha^1(\alpha), T_\gamma^{-1}(\alpha)) + f(X; \delta_2, \delta_3) + f(X; \delta_1, \delta_4)$ holds, where δ_i are curves as in Fact 3.4. Recall that we also have an identity $f(X; \alpha, \gamma) \equiv g(X; T_\alpha^1(\alpha), T_\gamma^{-1}(\alpha))$. However, their difference

$$2 \cosh \frac{l_X(\delta_2)}{2} \cosh \frac{l_X(\delta_3)}{2} + 2 \cosh \frac{l_X(\delta_1)}{2} \cosh \frac{l_X(\delta_4)}{2}$$

never vanishes. This contradiction excludes the latter case, and we conclude $i(\alpha, \gamma) = 1$. \square

Proof of Lemma 3.9. We claim that σ and γ in Figure 8 are in minimal position. First, (the segment parallel to) a_j cannot form a bigon with γ , since two segments of γ separated by a_j intersect with yet another segment of σ , namely (the segment parallel to) $a_{j'}$. Similarly, $a_{j'}$ cannot form a bigon with γ . Considering each side of the remaining segments of $\sigma \setminus \gamma$, we are left with complementary regions of $\sigma \cup \gamma$ containing A' , b_l and F .

The rectangle containing b_l is clearly not a bigon. If the region containing A' were a bigon, that region would be homotopic to a region made by b_l and a segment of γ . This contradicts to the assumption that α_i and γ are in minimal position. Similarly, if the region containing F were a bigon, that region would be homotopic to a region made by $b_l \subseteq \alpha_i$ and a segment of γ ,

another contradiction. In summary, no complementary region of $\sigma \cup \gamma$ is a bigon.

We next claim that σ and α_i are also in minimal position. To prove the claim, we first investigate the properties of segments of $\sigma \setminus \alpha_i$. Recall that σ contains two segments parallel to b_l . These segments belong to distinct components of $\sigma \setminus \alpha_i$, since both of c_1, c_2 are dissected by α_i . Besides of these components, there may be segments of $\sigma \setminus \alpha_i$ parallel to c_1 or c_2 , respectively. Suppose first that one such segment forms a bigon with α_i . (In Figure 8, consider the region containing part C) Then such bigon is homotopic to another bigon formed by α_i and $c_1 \cup c_2$. This contradicts to the fact that α_i and γ are in minimal position.

Now the left are two segments of $\sigma \setminus \alpha_i$ containing segments parallel to b_l . Suppose first that the region containing part A (and A') is a bigon. This implies that $a_j, b_l, a_{j'}$ are homotopic (relative to γ) to another segments $a_m, b_{m'}, a_{m''}$, respectively, which are joined together to form an α_i -side of that bigon. This in particular indicates that $N_\gamma(a_j)$ is not the minimum of N_1 , a contradiction.

If the region containing part B were a bigon, then we could collapse the ‘strip’ along a_j, b_l and $a_{j'}$ to obtain two bigons, one made by α_i and c_1 , and another one made by α_i and c_2 . This again contradicts to the minimal position assumption. Similarly, the region containing part E shall not be a bigon. Finally, if the region containing part F were a bigon, then b_l would be homotopic (relative to γ) to another segment $b_{l'}$ satisfying $N_\gamma(b_{l'}) = N_\gamma(b_l) + 2$. This contradicts to the definition of b_l .

So far we have concluded that curves in Figure 8 are pairwise in minimal position. Together with the representative of $T_\gamma^1(\alpha_i)$ drawn in Figure 9, we can then deduce that

$$i(\gamma, \sigma) = 4 \quad \text{and} \quad i(T_\gamma^{\pm 1}(\alpha_i), \sigma) \leq i(\alpha_i, \sigma) + 2.$$

□

Using this result, we can construct a subset of $\mathcal{T}(S)$ as follows. Let $\{\alpha_i\}_{i=-k-1}^{k+1}$, $\{\beta_i\}_{i=-k}^{k+1}$, $\{\gamma_i\}_{i=-k-1}^{k+1}$ and $\{\epsilon_i\}_{i=-k}^{k+1}$ be essential or boundary curves on S , where $\{\alpha_i\} \cup \{\gamma_0\}$ and $\{\gamma_i\} \cup \{\alpha_0\}$ consist of distinct curves and $k = i(\alpha_0, \gamma_0) \neq 1$. Since curves are compact, they are contained in a finite-type subsurface S_1 of S bounded by some curves C_{i_1}, \dots, C_{i_n} .

Then

$$h(X; \eta_1, \dots, \eta_4) := f(X; \eta_1, \eta_2) - g(X; \eta_3, \eta_4)$$

for each (η_1, \dots, η_4) among

$$\begin{aligned} & \{(\alpha_i, \gamma_0, \alpha_{i-1}, \alpha_{i+1})\}_{i=-k}^k, & & \{(\alpha_i, \alpha_{i-1}, \gamma_0, \beta_i)\}_{i=-k+1}^k, \\ & \{(\gamma_i, \alpha_0, \gamma_{i-1}, \gamma_{i+1})\}_{i=-k}^k, & & \{(\gamma_i, \gamma_{i-1}, \alpha_0, \eta_i)\}_{i=-k+1}^k \end{aligned}$$

becomes an analytic function on $\mathcal{T}(S_1)$. We index them into a single function $(h_i) : \mathcal{T}(S_1) \rightarrow \mathbb{R}^{8k+2}$. Now the proof of Proposition 3.8 indicates that (h_i) does not vanish identically on $\mathcal{T}(S_1)$. Using Lemma B.1, we then construct

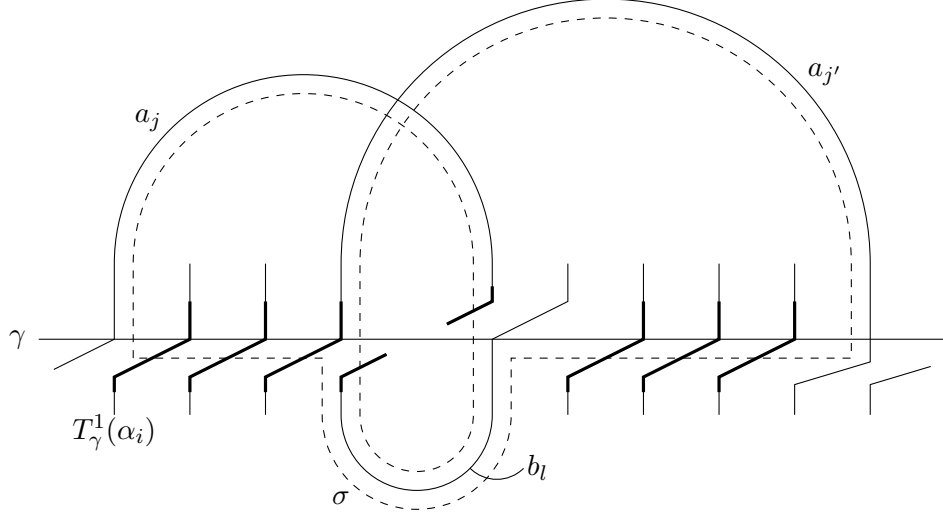

FIGURE 9. Configurations of $T_\gamma^1(\alpha_i)$ and σ . Two curves are intersecting at 8 points.

a countable family $\mathcal{F} = \{F_n\}$ of submanifolds of $\mathcal{T}(S_1)$ such that (h_i) does not vanish outside $\cup_n F_n$. Then $\tilde{F}_n := \pi_{S_1}^{-1}(F_n) \subseteq \mathcal{T}(S)$ is nowhere dense in $\mathcal{T}(S)$ and their union \tilde{F} becomes a meagre set. Moreover, submanifolds F_n are of WP-measure 0 in $\mathcal{T}(S_1)$ so \tilde{F}_n and \tilde{F} are also of ρ -measure 0 by Property 2.9.

3.3. Second length identity: generalised shirt. We now prove the following converse of Lemma 3.5.

Proposition 3.10. *Let $\{\alpha_i, \beta_i, \gamma_i, \eta_i\}_{i \in \mathbb{Z}}$ be essential or boundary curves on S , where $\{\alpha_i\}_{i \in \mathbb{Z}} \cup \{\gamma_0\}$ and $\{\gamma_i\}_{i \in \mathbb{Z}} \cup \{\alpha_0\}$ are collections of distinct curves. Further, let $\{\delta_1, \dots, \delta_4\}$ be curves on S .*

Suppose that Equation 3.2 holds for each $X \in \mathcal{T}(S)$ and each (η_1, \dots, η_8) mentioned in Lemma 3.5. Then $\alpha_0 \cup \gamma_0$ forms a spine of an immersed sub-surface $\psi : S' \rightarrow S$, where S' is a generalised shirt. Moreover, $\{\alpha_{-1}, \alpha_1\} = \{T_\gamma^{-1}(\alpha), T_\gamma^1(\alpha)\}$.

Further, we can label the peripheral curves of S' by $\{\eta_1, \dots, \eta_4\}$ such that:

- δ_i, η_i are both bounding punctures or $\delta_i = \eta_i$, and
- α_0 separates $\{\eta_1, \eta_3\}$ from $\{\eta_2, \eta_4\}$ and γ_0 separates $\{\eta_1, \eta_2\}$ from $\{\eta_3, \eta_4\}$.

Proof. As in the proof of Proposition 3.8, we will denote α_0 by α and γ_0 by γ . Moreover, we may assume that $\alpha_1 \neq T_\gamma^{-1}(\alpha)$ and $\gamma_1 \neq T_\alpha^{-1}(\gamma)$.

We note that Lemma 3.6 equally applies, since $f(\eta, \eta') \geq 0$ for any curves η and η' . As in the proof of Proposition 3.8, we thus obtain $k := i(\alpha, \gamma) > 0$ and $\alpha_i = T_\gamma^i(\alpha)$, $\gamma_i = T_\alpha^i(\gamma)$ for $i \geq -1$.

We now prove that δ_1 and γ are disjoint. From the assumption, we have

$$f(X; \alpha_i, \gamma) = g(X; \alpha_{i-1}, \alpha_{i+1}) + f(X; \delta_1, \delta_4) + f(X; \delta_2, \delta_3)$$

for even i . Here note that

$$i(\alpha_i, \gamma) = i(T_\gamma^i(\alpha), \gamma) = k.$$

Now, if γ intersects δ_1 , then

$$i(\alpha_{nk}, \delta_1) = i(T_\gamma^{nk}(\alpha), \delta_1) \geq nk i(\gamma, \delta_1) - i(\alpha, \delta_1) \geq nk - i(\alpha, \delta_1)$$

by Fact 2.16. Thus, if we take $i = nk$ to be an even integer larger than $i(\alpha, \delta_1) + k + 1$ and pinch α_i , then $f(X; \alpha_i, \gamma)$ grows in the order of $l(\alpha_i)^{-k}$ while $f(X; \delta_1, \delta_4)$ grows in the order at least of $l(\alpha_i)^{-(k+1)}$, a contradiction. Thus $i(\gamma, \delta_1) = 0$ and similarly $i(\alpha, \delta_1) = 0$. Other δ_i 's can be dealt with similarly, so we find that δ_i 's and $\alpha \cup \gamma$ are disjoint.

Now, if $k = i(\alpha, \gamma) > 2$, then we construct σ as in the step 2 of the proof of Proposition 3.8. Since $\sigma \subseteq N(\alpha) \cup N(\gamma)$ and δ_j are disjoint, we see that $f(X; \delta_j, \delta_{j'})$ remains bounded while pinching σ . Accordingly, the same contradiction is deduced by comparing each side of

$$f(X; \alpha_i, \gamma) = g(X; \alpha_{i-1}, \alpha_{i+1}) + f(\delta_j, \delta_{j'}) + f(\delta_{j''}, \delta_{j'''}).$$

while pinching σ .

We are thus led to the same dichotomy:

- (1) $i(\alpha, \gamma) = 1$ or
- (2) $i(\alpha, \gamma) = 2$ and $i_{alg}(\alpha, \gamma) = 0$.

As noted before, we cannot simultaneously have $f(X; \alpha, \gamma) = g(X; \alpha_{-1}, \alpha_1)$ and $f(X; \alpha, \gamma) \equiv g(X; \alpha_{-1}, \alpha_1) + f(X; \delta_2, \delta_3) + f(X; \delta_1, \delta_4)$. The latter one is already assumed, while $i(\alpha, \gamma) = 1$ forces the former one. This contradiction rules out the case $i(\alpha, \gamma) = 1$ and we conclude the other one. Consequently, $\alpha \cup \gamma$ becomes a spine of an immersed subsurface of S' that is a generalised shirt.

Let $\{\eta_j\}$ be the boundaries/punctures of S' labelled as in Fact 3.4. At this moment, Fact 3.4 and the assumption gives the following set of identities;

$$(3.7) \quad \begin{aligned} f(X; \eta_2, \eta_3) + f(X; \eta_1, \eta_4) &\equiv f(X; \alpha, \gamma) - g(X; \alpha_{-1}, \alpha_1) \\ &\equiv f(X; \delta_2, \delta_3) + f(X; \delta_1, \delta_4), \end{aligned}$$

$$(3.8) \quad \begin{aligned} f(X; \eta_1, \eta_3) + f(X; \eta_2, \eta_4) &\equiv f(X; \alpha_1, \gamma) - g(X; \alpha, \alpha_2) \\ &\equiv f(X; \delta_1, \delta_3) + f(X; \delta_2, \delta_4). \end{aligned}$$

Let Λ (Γ , resp.) be the set of η_j 's (δ_j 's, resp.) that are not punctures. Note that the LHS (RHS, resp.) of Equation 3.7 can attain the value 4 at one and all $X \in \mathcal{T}(S)$ if and only if all of η_j (δ_i , resp.) are punctures. This settles the case of 4-punctured sphere, and we now assume $\Lambda, \Gamma \neq \emptyset$.

Since S' is an immersed subsurface, Λ consists of disjoint curves. Thus we can fix a pants decomposition including Λ and pinch simultaneously; the

LHS of Equation 3.7 converges to 4 so the RHS should also do so. This is possible only when $l_X(\delta_i) \rightarrow 0$ during the pinching, so $\emptyset \neq \Gamma \subseteq \Lambda$.

We now pick some δ_i in Γ ; since $\Gamma \subseteq \Lambda$, $\delta_i = \eta_j$ for some j . Note that the following permutations on the indices of δ_i, η_j :

$$\begin{aligned} (1, 2, 3, 4) &\mapsto (1, 2, 3, 4), & (1, 2, 3, 4) &\mapsto (2, 1, 4, 3), \\ (1, 2, 3, 4) &\mapsto (3, 4, 1, 2), & (1, 2, 3, 4) &\mapsto (4, 3, 2, 1) \end{aligned}$$

do not affect the assumption and the conclusion. Thus, we may assume that $\delta_1 = \eta_1 \in \Gamma$.

We now show $\delta_i = \eta_i$ (up to the permutations above) for all i . We first increase $l_X(\eta_1) = l_X(\delta_1)$ to infinity, retaining lengths of $\eta_j \in \Lambda \setminus \{\delta_1\}$ as t .

- If $\eta_1 = \eta_3$, then η_2, η_4 are distinct from η_1 . In this case, the LHS of Equation 3.8 grows in the order of $e^{2l_X(\eta_1)}$; this implies that at least one of $\delta_3 = \delta_1 = \eta_1$ or $\delta_2 = \delta_4 = \delta_1 = \eta_1$ holds. However, the latter case is excluded by comparing $f(X; \eta_2, \eta_4)$ and $f(X; \delta_1, \delta_3)$ then. Thus, we conclude $\eta_1 = \eta_3 = \delta_1 = \delta_3$ and $f(X; \eta_1, \eta_3) = f(X; \delta_1, \delta_3)$. Now we increase $l_X(\eta_2)$ and $l_X(\eta_4)$ separately, if possible, in Equation 3.8 to deduce the conclusion.
- If $\eta_1 = \eta_4$, then η_2, η_3 are distinct from η_1 . In this case, the LHS of Equation 3.7 grows in the order of $e^{2l_X(\eta_1)}$; this implies that either $\delta_4 = \delta_1 = \eta_1$ or $\delta_2 = \delta_3 = \delta_1 = \eta_1$. However, the latter case is excluded by comparing $f(X; \eta_2, \eta_3)$ and $f(X; \delta_1, \delta_4)$ then. Thus, we conclude $\eta_1 = \eta_4 = \delta_1 = \delta_4$ and $f(X; \eta_1, \eta_4) = f(X; \delta_1, \delta_4)$. Now we increase $l_X(\eta_2)$ and $l_X(\eta_3)$ separately, if possible, in Equation 3.8 to deduce the conclusion.
- If $\eta_1 = \eta_2$, then η_3, η_4 are distinct from η_1 . In this case, the LHS of Equation 3.7 and 3.8 grow in the order of $e^{l_X(\eta_1)}$. Accordingly, both δ_3, δ_4 are not η_1 . If moreover δ_2 is not η_1 , then

$$\lim_{l_X(\eta_1) \rightarrow \infty} \frac{(\text{RHS of Equation 3.8})}{e^{l_X(\eta_1)}} = \begin{cases} 1 & \delta_3 \notin \Gamma \\ \cosh 2 & \delta_3 \in \Gamma \setminus \{\delta_1\} \end{cases}$$

according to whether δ_3 is a curve or not. However,

$$\lim_{l_X(\eta_1) \rightarrow \infty} \frac{(\text{LHS of Equation 3.8})}{e^{l_X(\eta_1)}} = \begin{cases} 2 & \eta_3, \eta_4 \notin \Lambda \\ 2 \cosh 2 & \eta_3, \eta_4 \in \Lambda \setminus \{\eta_1\} \\ 1 + \cosh 2 & \text{otherwise.} \end{cases}$$

giving a contradiction. Thus $\delta_2 = \eta_1$. Now we increase $l_X(\eta_3)$ and $l_X(\eta_4)$ separately to deduce that $\{\eta_3, \eta_4\} = \{\delta_1, \delta_2\}$.

- The rest is that η_1 is not equal to any of $\{\eta_2, \eta_3, \eta_4\}$. We first set $l_X(\eta_3)$ as 3 if $\eta_3 \in \Lambda$, and set lengths $l_X(\eta_j)$ for $\eta_j \in \Lambda \setminus \{\eta_1, \eta_3\}$ as 2. Finally, we increase $l_X(\eta_1) = l_X(\delta_1)$ to infinity. We then observe

$$\lim_{l_X(\eta_1) \rightarrow \infty} \frac{(\text{LHS of Equation 3.8})}{e^{l_X(\eta_1)}} = \begin{cases} \cosh 2 & \eta_3 \in \Lambda \\ 1 & \text{otherwise,} \end{cases}$$

$$\lim_{l_X(\eta_1) \rightarrow \infty} \frac{(\text{RHS of Equation 3.8})}{e^{l_X(\eta_1)}} = \begin{cases} \cosh 2 & \delta_3 = \eta_3 \in \Lambda \\ \cosh 1 & \delta_3 \in \Lambda \setminus \eta_3 \\ 1 & \text{otherwise.} \end{cases}$$

Thus we conclude that η_3, δ_3 are both bounding punctures or $\eta_3 = \delta_3$. Similar conclusion for η_4, δ_4 follows from Equation 3.7. Finally, we increase $l_X(\eta_2)$ and $l_X(\eta_4)$ separately in Equation 3.8 to deduce the conclusion. \square

Using this result, we can construct a subset of $\mathcal{T}(S)$ as follows. Let $\{\alpha_i\}_{i=-(M+k+2)}^{M+k+2}$, $\{\beta_i\}_{i=-k}^k$, $\{\gamma_i\}_{i=-(M+k+2)}^{M+k+2}$, $\{\epsilon_i\}_{i=-k}^k$ and $\{\delta_1, \dots, \delta_4\}$ be curves on S such that:

- $\{\alpha_i, \beta_i, \gamma_i, \epsilon_i\}$ are essential or boundary curves,
- $\{\alpha_i\} \cup \{\gamma_0\}$, $\{\gamma_i\} \cup \{\alpha_0\}$ consist of distinct curves,
- $i(\alpha_0, \gamma_0) = k$ and $i(\alpha_0, \delta_i), i(\gamma_0, \delta_i) \leq M$, and
- $(\alpha_0, \gamma_0, \delta_i)$ do not satisfy the conclusion of Proposition 3.10.

Since curves are compact, they are contained in a finite-type subsurface S_1 of S bounded by some curves C_{i_1}, \dots, C_{i_n} .

Then

$$h(X; \eta_1, \dots, \eta_8) := f(X; \eta_1, \eta_2) - g(X; \eta_3, \eta_4) - f(X; \eta_5, \eta_6) - f(X; \eta_7, \eta_8)$$

for (η_1, \dots, η_8) mentioned in Lemma 3.5 becomes an analytic functions on $\mathcal{T}(S_1)$. We index them into a single function $(h_i) : \mathcal{T}(S_1) \rightarrow \mathbb{R}^N$ for some N . Now the proof of Proposition 3.10 indicates that (h_i) does not vanish identically on $\mathcal{T}(S_1)$. Using Lemma B.1, we then construct a countable family $\mathcal{G} = \{G_n\}$ of submanifolds of $\mathcal{T}(S_1)$ such that $(h_i) \neq 0$ outside $\cup_n G_n$. Then $\tilde{G}_n := \pi_{S_1}^{-1}(G_n) \subseteq \mathcal{T}(S)$ is nowhere dense in $\mathcal{T}(S)$ and their union \tilde{G} becomes a meagre set. Moreover, submanifolds G_n are of WP-measure 0 in $\mathcal{T}(S_1)$ so \tilde{G}_n and \tilde{G} are also of ρ -measure 0 by Property 2.9.

We now gather all $\tilde{E}(\alpha, \beta)$, $\tilde{F}(\{\alpha_i\}, \dots, \{\epsilon_i\})$, $\tilde{G}(\{\alpha_i\}, \dots, \{\delta_i\})$ that have been constructed so far, and denote their union by V . These are countable collection of meagre subsets of $\mathcal{T}(S)$, so V is also meagre. Since $\mathcal{T}(S)$ is locally homeomorphic to a complete metric space l^∞ , we again invoke the Baire category theorem to deduce that $\mathcal{T}(S) \setminus V$ is dense in $\mathcal{T}(S)$. Moreover, V is also of ρ -measure 0 since each $\tilde{E}, \tilde{F}, \tilde{G}$ is. Here Theorem 3.1, Proposition 3.8 and Proposition 3.10 imply the following proposition.

Proposition 3.11. *Suppose that $X \in \mathcal{T}(S) \setminus V$ and $\{\xi_1, \xi_2\}, \{\alpha_i, \beta_i, \gamma_i, \epsilon_i\}_{i \in \mathbb{Z}}$ be essential or boundary curves on S .*

- (1) *If $\xi_1 \neq \xi_2$, then $l_X(\xi_1) \neq l_X(\xi_2)$.*
- (2) *Suppose that at X , $\{\alpha_i, \beta_i, \gamma_i, \epsilon_i\}_{i \in \mathbb{Z}}$ satisfy the identities of Lemma 3.3 and each of $\{\alpha_i\}_{i \in \mathbb{Z}} \cup \{\gamma_0\}$, $\{\gamma_i\}_{i \in \mathbb{Z}} \cup \{\alpha_0\}$ contains no curves with the same length. Then $i(\alpha_0, \gamma_0) = 1$ and $\{\alpha_{-1}, \alpha_1\} = \{T_{\gamma_0}^{\pm 1}(\alpha_0)\}$;*
- (3) *In addition, let $\{\delta_1, \dots, \delta_4\}$ be curves on S . Suppose that at X , $\{\alpha_i, \beta_i, \gamma_i, \epsilon_i\}_{i \in \mathbb{Z}}$ and $\{\delta_1, \dots, \delta_4\}$ satisfy the identities of Lemma 3.5*

and each of $\{\alpha_i\}_{i \in \mathbb{Z}} \cup \{\gamma_0\}$, $\{\gamma_i\}_{i \in \mathbb{Z}} \cup \{\alpha_0\}$ contains no curves with the same length.

Then $\alpha_0 \cup \gamma_0$ forms a spine of an immersed subsurface $\psi : S' \rightarrow S$, where S' is a generalised shirt. Moreover, $\{\alpha_{-1}, \alpha_1\} = \{T_\gamma^{\pm 1}(\alpha)\}$.

Further, we can label the peripheral curves of S' by $\{\eta_1, \dots, \eta_4\}$ such that:

- δ_i, η_i are both bounding punctures or $\delta_i = \eta_i$, and
- α_0 separates $\{\eta_1, \eta_3\}$ from $\{\eta_2, \eta_4\}$ and γ_0 separates $\{\eta_1, \eta_2\}$ from $\{\eta_3, \eta_4\}$.

Suppose now that S is a surface composed of at least two generalised pairs of pants. If η_1, η_2 are disjoint curves on S and η_1 is essential, then we can perform the following procedure. We connect η_1 and η_2 with a segment τ ; then η_1, η_2 , and concatenation $\eta_1 \tau \eta_2 \tau^{-1}$ bound a pair of pants P in S . Moreover, at least one of η_1 or η_2 is adjacent to yet another pair of pants Q , and $P \cup Q$ becomes an immersed generalised shirt. Here one of η_1, η_2 separates the shirt into P and Q , and the other one becomes a boundary curve of $P \cup Q$. From this observation, we deduce the following lemma.

Lemma 3.12. *Suppose that S is a surface that is not a generalised pair of pants or a one-holed/punctured torus, $X \in \mathcal{T}(S) \setminus V$ and η_1, η_2 are essential or boundary curves on X . Then the following are equivalent:*

- (1) η_1 and η_2 are disjoint;
- (2) there exists essential or boundary curves $\{\alpha_i, \beta_i, \gamma_i, \epsilon_i\}_{i \in \mathbb{Z}}$ on X and curves $\{\delta_1, \dots, \delta_4\}$ such that:
 - each of $\{\alpha_i\}_{i \in \mathbb{Z}} \cup \{\gamma_0\}$, $\{\gamma_i\}_{i \in \mathbb{Z}} \cup \{\alpha_0\}$ contains no curves with the same length;
 - $\{\gamma_0, \delta_1\} = \{\eta_1, \eta_2\}$; and
 - the identities of Lemma 3.5 are satisfied.

4. SURFACES WITH LOW COMPLEXITY

Before proving the main theorem in the general setting, we first deal with surfaces with low complexity. The case of generalised pair of pants is dealt with the following lemma.

Lemma 4.1. *Let X, X' be generalised pairs of pants with peripheral curves $\{\delta_i\}_{i=1,2,3}$ and $\{\delta'_i\}_{i=1,2,3}$, respectively.*

- (1) *If $l_X(\delta_i) = l_{X'}(\delta'_i)$ for each i , then X and X' are isometric.*
- (2) *Suppose in addition that $l_X(\delta_1) \neq l_X(\delta_2)$, and let η (η' , resp.) be the geodesic segment perpendicular to δ_1 and δ_2 (δ'_1 and δ'_2 , resp.). Then there exist exactly two isometries $\phi_1, \phi_2 : X \rightarrow X'$ sending each δ_i to δ'_i and η to η' . Here $\phi_2^{-1} \circ \phi_1$ becomes an orientation-reversing automorphism of X fixing all boundaries setwise.*

We now begin our discussion on one-holed/punctured tori and generalised shirts.

Proposition 4.2. *Theorem 1.2 holds when S is a one-holed/punctured torus.*

Proof. Note that the assumption $\mathcal{L}(X) = \mathcal{L}(X')$ forces $\mathcal{L}(X')$ to be simple since $\mathcal{L}(X)$ is assumed to be so.

Let γ' be an essential curve on X' . There exists another essential curve α' on X' intersecting with γ' once. We then set essential curves $\{\alpha'_i, \beta'_i, \gamma'_i, \epsilon'_i\}_{i \in \mathbb{Z}}$ on X' as the curves involved in Lemma 3.3;

- (1) $\alpha'_i = T_{\gamma'}^i(\alpha')$, $\gamma'_i = T_{\alpha'}^i(\gamma')$, and
- (2) $\{T_{\alpha'_i}^{\pm 1}(\alpha'_{i-1})\} = \{\gamma', \beta'_i\}$ and $\{T_{\gamma'_i}^{\pm 1}(\gamma'_{i-1})\} = \{\alpha', \epsilon'_i\}$.

Since $\{\alpha'_i, \beta'_i, \gamma'_i, \epsilon'_i\}$ are essential, their lengths are witnessed by $\mathcal{L}(X')$. Note also that $\{\alpha'_i\}_{i \in \mathbb{Z}} \cup \{\gamma'\}$ and $\{\beta'_i\}_{i \in \mathbb{Z}} \cup \{\alpha'\}$ are collections of distinct curves; their lengths are distinct in $\mathcal{L}(X')$.

From the equality $\mathcal{L}(X) = \mathcal{L}(X')$ between simple length spectra, we can take essential or boundary curves $\{\alpha_i, \beta_i, \gamma_i, \epsilon_i\}_{i \in \mathbb{Z}}$ on X such that

$$l_X(\alpha_i) = l_{X'}(\alpha'_i), \quad l_X(\beta_i) = l_{X'}(\beta'_i), \quad l_X(\gamma_i) = l_{X'}(\gamma'_i), \quad l_X(\epsilon_i) = l_{X'}(\epsilon'_i).$$

Note that $\{\alpha_i\}_{i \in \mathbb{Z}} \cup \{\gamma_0\}$ and $\{\gamma_i\}_{i \in \mathbb{Z}} \cup \{\alpha_0\}$ are comprised of distinct lengths. We then apply Proposition 3.11 to deduce that $i(\alpha_0, \gamma_0) = 1$ and $\{\alpha_{-1}, \alpha_1\} = \{T_{\gamma_0}^{\pm 1}(\alpha_0)\}$. Thus, $\alpha_0 \cup \gamma_0$ serves as a spine of X .

Moreover, $l_X(\alpha_0), l_X(\gamma_0), l_X(T_{\gamma_0}^{\pm 1}(\alpha_0))$ determine a unique isometry class of X in the following way. First, three consecutive ‘twists’ of α_0 by γ_0 reads the (unsigned) twist parameter at γ_0 , or equivalently, the (unsigned) angle between the geodesics α_0 and γ_0 . Using $l_X(\alpha_0), l_X(\gamma_0)$ and this angle, one can compute the length of (geodesic representative of) $\alpha_0 \gamma_0 \alpha_0^{-1} \gamma_0^{-1}$, the boundary curve of X . As a result, we obtain three boundary lengths of the pair of pants for X , and the twist for the gluing along γ_0 . Since this information agree with that of X' , we conclude that X and X' are isometric.

Let ϕ be the isometry from X to X' . Then $f_2^{-1} \circ \phi \circ f_1$ becomes a (possibly orientation-reversing) homeomorphism on S that sends $[f_2, X']$ to $[f_1, X]$ by pre-composition. \square

Note that $l_{X'}(\gamma'), l_{X'}(T_{\gamma'}^{\pm 1}(\alpha'))$ have distinct lengths since they are distinct curves. Consequently, the twist $\tau_{X'}(\gamma')$ read off by these lengths cannot be 0 or π . Thus, there exist exactly two isometries between X and X' , related by the hyperelliptic involution.

We now move on to the case of generalised shirt. Note that a generalised shirt may be not embedded into another surface but only immersed. For instance, a generalised shirt is immersed in a closed surface of genus 2, while it cannot be embedded. As such, we need a variant in the following format.

Proposition 4.3. *Suppose that $[f_1, Y] \in \mathcal{T}(S) \setminus V$ and $[f_2, Y'] \in \mathcal{T}(S)$ have the same simple length spectrum. Let $\psi' : X' \rightarrow Y'$ be an immersed subsurface of Y' where X' is a generalised shirt. Then there exists an immersed subsurface $\psi : X \rightarrow Y$ of Y such that X and X' are isometric. In particular, Theorem 1.2 holds when S is a generalised shirt.*

Proof. Note again that $\mathcal{L}(Y')$ is forced to be simple, and so is $\mathcal{L}(X')$.

Let γ' be an essential curve on X' . We take another essential curve α' on X' such that $i(\alpha', \gamma') = 2$ and $i_{alg}(\alpha', \gamma') = 0$. Then $\alpha' \cup \gamma'$ serves as a spine of X' , bounded by peripheral curves $\{\delta'_i\}_{i=1}^4$ labelled as in Figure 6. Let P' (Q' , resp.) be the generalised pair of pants of X' bounded by δ'_1, δ'_2 and γ' (δ'_3, δ'_4 and γ' , resp.)

We then draw a geodesic segment $\kappa'_{P'}$ on P' , departing from δ'_1 and arriving at γ' orthogonally. Similarly we draw a segment $\kappa'_{Q'}$ on Q' from δ'_3 to γ' . Then there exists a unique segment ξ' immersed along γ' such that $\alpha' = (\kappa'^{-1}_{P'} \delta'_1 \kappa'_{P'}) \xi' (\kappa'^{-1}_{Q'} \delta'_3 \kappa'_{Q'}) \xi'^{-1}$.

We now set essential curves $\{\alpha'_i, \beta'_i, \gamma'_i, \epsilon'_i\}_{i \in \mathbb{Z}}$ on X' as the curves involved in Lemma 3.5. The corresponding essential or boundary curves $\{\alpha_i, \beta_i, \gamma_i, \epsilon_i\}_{i \in \mathbb{Z}}$ on Y are taken by comparing the length spectra of Y and X' . In other words, we require

$$l_Y(\alpha_i) = l_{X'}(\alpha'_i), \quad l_Y(\beta_i) = l_{X'}(\beta'_i), \quad l_Y(\gamma_i) = l_{X'}(\gamma'_i), \quad l_Y(\epsilon_i) = l_{X'}(\epsilon'_i).$$

Note that $\{\alpha_i\}_{i \in \mathbb{Z}} \cup \{\gamma_0\}$ and $\{\gamma_i\}_{i \in \mathbb{Z}} \cup \{\alpha_0\}$ are comprised of distinct lengths. We also take δ_i 's appropriately; δ_i is taken as any puncture if the corresponding δ'_i is; otherwise δ_i is the essential or boundary curve on Y having the same length with δ'_i .

We then apply Proposition 3.11 to deduce that $i(\alpha_0, \gamma_0) = 2$, $i_{alg}(\alpha_0, \gamma_0) = 0$ and $\{\alpha_{-1}, \alpha_1\} = \{T_{\gamma_0}^{\pm 1}(\alpha_0)\}$. Thus, $\alpha_0 \cup \gamma_0$ serves as a spine of a generalised shirt X , immersed in Y . Further, we may assume that δ_i are indeed the peripheral curves of X , α_0 separates $\{\delta_1, \delta_3\}$ from $\{\delta_2, \delta_4\}$ and γ_0 separates $\{\delta_1, \delta_2\}$ from $\{\delta_3, \delta_4\}$. We then define generalised pairs of pants P, Q and segments κ_P, κ_Q and ξ on X analogously to X' .

From now on, we orient X, X' such that α_1 (α'_1 , resp.) becomes the positive twist $T_{\gamma}^1(\alpha)$ ($T_{\gamma'}^1(\alpha')$, resp.). By Lemma 4.1, there exist unique orientation-preserving isometries $\phi_P : P \rightarrow P'$ and $\phi_Q : Q \rightarrow Q'$ sending κ_P to $\kappa_{P'}$ and κ_Q to $\kappa_{Q'}$. It remains to show that ϕ_P and ϕ_Q agree on γ .

In short, the twist at γ (γ' , resp.) is read off by $l_X(\alpha), l_X(T_{\gamma}^{\pm 1}(\alpha))$ ($l_{X'}(\alpha'), l_{X'}(T_{\gamma'}^{\pm 1}(\alpha'))$, resp.). Indeed, the signed length of ξ is determined by $(l_X(T_{\gamma}^1(\alpha)), l_X(T_{\gamma}^{-1}(\alpha))) = (l_X(\alpha_1), l_X(\alpha_{-1}))$ and the boundary lengths $(l_X(\delta_1), \dots, l_X(\delta_4))$. (See Proposition 3.3.11 and 3.3.12 of [Bus92] for an explicit calculation) Similarly, the signed length of ξ' is determined by lengths $(l_{X'}(\alpha'_1), l_{X'}(\alpha'_{-1}), l_{X'}(\delta'_1), \dots, l_{X'}(\delta'_4))$. Since the lengths involved are identical, we conclude that the signed length of ξ, ξ' are also same and ϕ_P, ϕ_Q agree on γ . Thus X is isometric to X' . \square

As in Proposition 4.2, the twist $\tau_{X'}(\gamma')$ of X' at γ' cannot be a multiple of π . This is because the lengths of $\{T_{\gamma'}^i(\alpha')\}_{i=-2,0,2}$ differ. If moreover, say, δ'_1 and δ'_2 have same lengths (e.g. they are punctures), then multiples of $\pi/2$ are also forbidden for $\tau_{X'}(\gamma')$. In any case, there exists only one isometry between X and X' .

Proposition 4.4. *Theorem 1.2 holds when S is of type $S_{1,p,b}$ for $p + b = 2$.*

Proof. We first take a curve γ' separating X' into a one-holed torus and a generalised pair of pants. Inside that one-holed torus, there exists a curve δ' longer than γ' ; indeed, we may pick any once-intersecting curves inside one-holed torus and twist one along the other sufficiently many times. Now if we take a curve α' on X' such that $i(\delta', \alpha') = 0$, $i(\gamma', \alpha') = 2$, and $i_{alg}(\gamma', \alpha') = 0$, then $\alpha' \cup \gamma'$ becomes a spine of an immersed subsurface $\psi'_0 : X'_0 \rightarrow X'$, where X'_0 is a generalised shirt. Let us label the boundaries of X'_0 by δ'_i as in Lemma 3.5, where $\delta'_1 = \delta'_2 = \delta$.

Let κ'_i be the geodesic segment perpendicular to γ' and δ'_i for $i = 1, \dots, 4$, oriented toward γ' . Further, let ξ'_i be the arc immersed along γ' such that

$$\alpha' = (\kappa_1'^{-1} \delta_1' \kappa_1') \xi_1' (\kappa_3'^{-1} \delta_3' \kappa_3') \xi_1'^{-1} = (\kappa_2'^{-1} \delta_2' \kappa_2') \xi_2' (\kappa_4'^{-1} \delta_4' \kappa_4') \xi_2'^{-1}.$$

Finally, we set ζ'_i to be the geodesic segment perpendicular to δ'_i and δ'_{i+2} for $i = 1, 2$. See Figure 10.

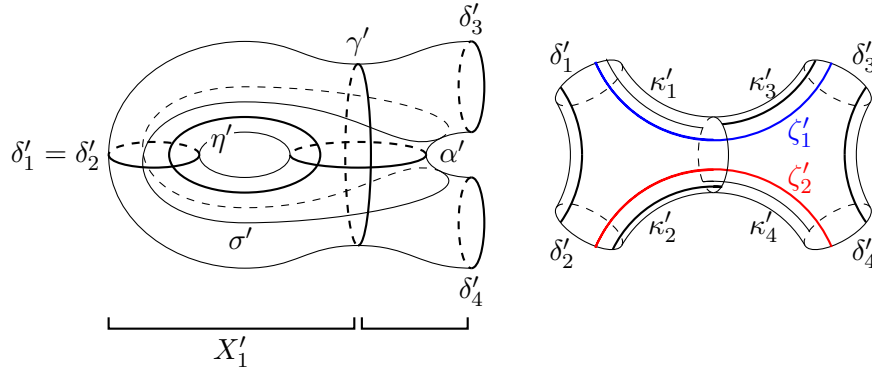

FIGURE 10. Curves on the surface $S_{1,p,b}$ with $p + b = 2$

We now set curves $\{\alpha'_i, \beta'_i, \gamma'_i, \epsilon'_i\}_{i \in \mathbb{Z}}$ on X' as in Lemma 3.5. The corresponding essential or boundary curves $\{\alpha_i, \beta_i, \gamma_i, \epsilon_i\}_{i \in \mathbb{Z}}$ on X are taken by comparing the lengths, i.e., requiring

$$l_X(\alpha_i) = l_{X'}(\alpha'_i), \quad l_X(\beta_i) = l_{X'}(\beta'_i), \quad l_X(\gamma_i) = l_{X'}(\gamma'_i), \quad l_X(\epsilon_i) = l_{X'}(\epsilon'_i).$$

Note that $\{\alpha_i\}_{i \in \mathbb{Z}} \cup \{\gamma_0\}$ and $\{\gamma_i\}_{i \in \mathbb{Z}} \cup \{\alpha_0\}$ are comprised of distinct lengths. We also take δ_i appropriately; δ_i is taken as any puncture if the corresponding δ'_i is; otherwise δ_i is the essential or boundary curve on X having the same length with δ'_i . Here $\delta_1 = \delta_2$ since δ'_1 and δ'_2 are identical. From now on, we fix the orientation of X so that $\alpha_1 = T_{\gamma_0}^1(\alpha_0)$ and similarly for X' .

We first cut X along δ_1 to obtain an immersed subsurface $\psi_0 : X_0 \rightarrow X$; Proposition 3.11 tells us that X_0 is a generalised shirt. Thus, we can also define κ_i, ξ_i, ζ_i on X_0 analogously. Now, Proposition 4.3 gives an isometry $\phi_0 : X_0 \rightarrow X'_0$ sending each δ_i to δ'_i . In particular, ϕ_0 becomes orientation-preserving due to our choice of orientations. Moreover, κ_i, ξ_i, ζ_i are sent to the corresponding $\kappa'_i, \xi'_i, \zeta'_i$ with orientations preserved.

We further take η', σ' on X' such that $i(\delta', \eta') = i(\eta', \alpha') = 1$, $i(\eta', \gamma') = 0$, and $i(\alpha', \sigma') = 0$, $i(\delta', \sigma') = 2$ and $i_{alg}(\delta', \sigma') = 0$. Then $\delta' \cup \eta'$ ($\delta' \cup \sigma'$, resp.) becomes a spine of an immersed subsurface $\psi'_1 : X'_1 \rightarrow X'$ ($\psi'_2 : X'_2 \rightarrow X'$, resp.) where X'_1 (X'_2 , resp.) is a one-holed torus (generalised shirt, resp.). See Figure 10.

Similarly, one can copy η', σ' (and other necessary curves) to X using the length spectra. Then X cut along γ becomes an immersed subsurface $\psi_1 : X_1 \rightarrow X$ where X_1 is a one-holed torus, and X cut along α becomes an immersed subsurface $\psi_2 : X_2 \rightarrow X$ where X_2 is a generalised shirt. Furthermore, Proposition 4.2 gives an isometry $\phi_1 : X_1 \rightarrow X'_1$, sending κ_1 to κ'_1 and κ_2 to κ'_2 . Proposition 4.3 also gives an isometry $\phi_2 : X_2 \rightarrow X'_2$, sending ζ_1 to ζ'_1 and ζ_2 to ζ'_2 .

At this moment, ϕ_1 may or may not agree with ϕ_0 on $X_0 \cap X_1$, depending on whether ϕ_1 is orientation-preserving or not. Once ϕ_1 is shown to be orientation-preserving, the gluing of ϕ_0 and ϕ_1 becomes an isometry between X and X' , completing the proof. Suppose to the contrary that ϕ_1 is orientation-reversing. For clearer explanation, we from now on flip the orientation of X' ; now ϕ_0 is assumed to be orientation-reversing, while ϕ_1 is orientation-preserving. We then show that the (unsigned) distance between ζ_1 and ζ_2 along δ_1 differs with the analogous one on X' . This will then contradict to the fact that ϕ_2 is an isometry, which must preserve the unsigned twist of X_2 at δ_1 .

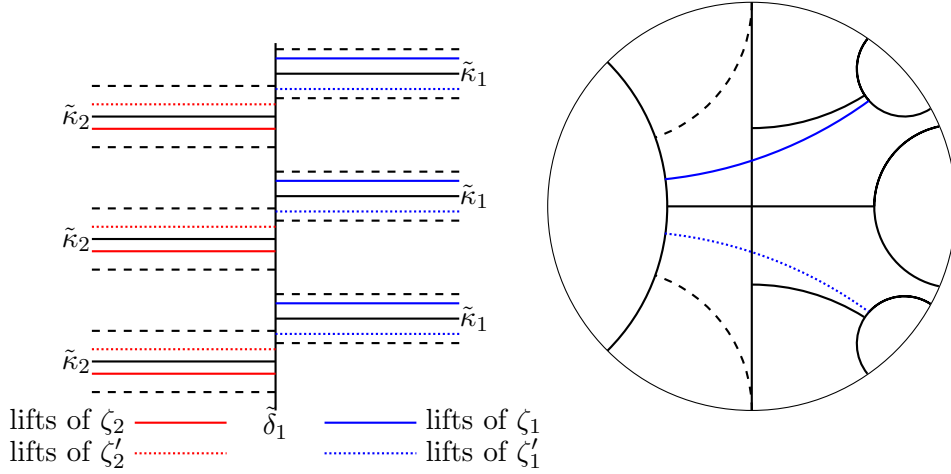

FIGURE 11. Description on the hyperbolic plane

We now parametrise δ_1 by arc length λ so that κ_1 is located on the right side of δ_1 while λ increases, as in Figure 11. On X , we denote the signed displacement from κ_1 (κ_2 , resp.) to ζ_1 (ζ_2 , resp.) along δ_1 by d_1 (d_2 , resp.). Further, we denote the signed displacement from κ_1 to κ_2 along δ_1 by D . Similarly, we define the displacements d'_1 , d'_2 and D' for curves and segments on X' .

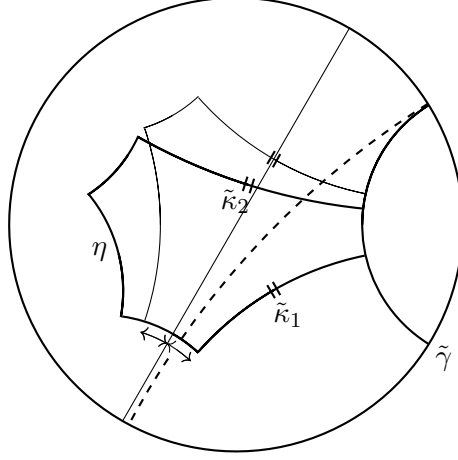

FIGURE 12. A hexagon bounded by $\tilde{\delta}_1$, $\tilde{\gamma}$, $\tilde{\kappa}_1$ and other geodesics.

From the assumption, the twist at γ , γ' are nonzero and opposite: this forces $d_1 = -d'_1 \neq 0$ and $d_2 = -d'_2 \neq 0$. Furthermore, d_1, d_2 have opposite signs. Finally, note that a lift $\tilde{\zeta}_1$ must cross the corresponding lift $\tilde{\gamma}$. This forces $\tilde{\zeta}_1$ to be sandwiched between $\tilde{\kappa}_1$ and a geodesic from $\tilde{\delta}_1$ ‘spiraling toward’ γ (the black dashed line in the right of Figure 11). If we denote their displacement by L , then we observe that $2L < l_X(\delta_1)/2$, as depicted in Figure 12. Here, our choice of δ_1 with large length plays a role.

Now we calculate the unsigned displacements between ζ_1 and ζ_2 (ζ'_1 and ζ'_2 , respectively). The former one is $|D + d_1 + d_2 + nl_X(\delta_1)|$ for integers n and the latter one is $|D + d'_1 + d'_2 + nl_X(\delta_1)| = |D - d_1 - d_2 + nl_X(\delta_1)|$ for integers n . If some of them are equal, then either

$$2D = nl_X(\delta_1) \text{ for some } n \in \mathbb{Z} \quad \text{or} \quad 2(d_1 + d_2) = nl_X(\delta_1) \text{ for some } n \in \mathbb{Z}.$$

The former case is excluded since D cannot be a multiple of $l_X(\delta_1)$. For the latter case, note first that d_1, d_2 are nonzero values having same sign: their sum cannot vanish. However, since $|d_1|, |d_2| < l_X(\delta_1)/4$, $2(d_1 + d_2)$ cannot become other multiples of $l_X(\delta_1)$. □

The proof equally applies to the case of genus 2 surface. In both cases, only one isometry is allowed between X and X' .

Proposition 4.5. *Suppose that $[f_1, Y] \in \mathcal{T}(S) \setminus V$ and $[f_2, Y'] \in \mathcal{T}(S)$ have the same simple length spectrum. Let $\psi' : X' \rightarrow Y'$ be an immersed subsurface of Y' where X' is a surface of type $S_{0,p,b}$ where $p + b = 5$. Then there exists an immersed subsurface $\psi : X \rightarrow Y$ of Y such that X and X'*

are isometric. In particular, Theorem 1.2 holds when S is of type $S_{0,p,b}$ for $p + b = 5$.

Proof. Let us take curves $\gamma'_1, \gamma'_2, \alpha'_0, \alpha'_1, \alpha'_2$ on X' as in Figure 13, and label the peripheral curves as δ'_i . Then we obtain two immersed subsurface $\psi'_i : X'_i \rightarrow X'$ for $i = 1, 2$, where X'_i is the generalised shirt with spine $\alpha'_i \cup \gamma'_i$. In addition, cutting X' along α'_2 also gives another immersed subsurface $\phi'_0 : X'_0 \rightarrow X'$.

We also draw geodesic segments κ'_i perpendicular to δ'_{2i} and γ'_i, η' perpendicular to γ'_1 and γ'_2 , and ζ' perpendicular to δ'_4 and γ'_1 .

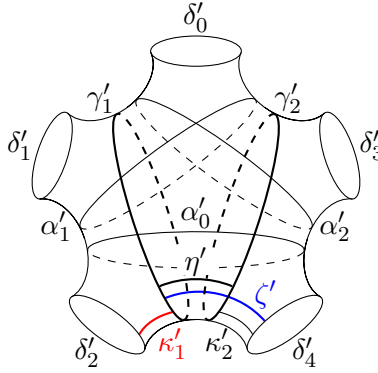

FIGURE 13. Configuration of curves on X' of type $S_{0,p,b}$, $p + b = 5$.

Now we take curves $\{\gamma_i, \alpha_i\}$ on Y by requiring $l_Y(\gamma_i) = l_{X'}(\gamma'_i)$ and $l_Y(\alpha_i) = l_{X'}(\alpha'_i)$. Then as in the previous proofs, using other auxilliary curves, Proposition 3.11 detects the intersection patterns of curves, which means that:

- some curves of Y can be labelled as δ_i such that $l_X(\delta_i) = l_{X'}(\delta'_i)$ for each i ;
- for $i = 1, 2$, $\alpha_i \cup \gamma_i$ serves as a spine of generalised shirt X_i immersed in X by $\psi_i : X_i \rightarrow Y$;
- $\alpha_0 \cup \gamma_1$ also serves a spine of generalised shirt X_0 immersed in X by $\psi_0 : X_0 \rightarrow Y$;
- $\sigma \in \{\alpha_i, \gamma_i\}$ separates $\{\delta_{i_1}, \delta_{i_2}\}$ from $\{\delta_{i_3}, \delta_{i_4}, \delta_{i_5}\}$ if and only if $\sigma' \in \{\alpha'_i, \gamma'_i\}$ separates $\{\delta'_{i_1}, \delta'_{i_2}\}$ from $\{\delta'_{i_3}, \delta'_{i_4}, \delta'_{i_5}\}$.

Moreover, ψ_1 and ψ_2 induce an immersion $\psi : X \rightarrow Y$ of a surface X of type $S_{0,p,b}$ for $p + b = 5$, and we may assume that each δ_i is peripheral curve of X again from Proposition 3.11. We then orient X, X' by requiring that $T_{\gamma_1}(\alpha_1)$ and $T_{\gamma'_1}(\alpha'_1)$ have the same length. We also define segments κ_i, η, ζ on X , analogously to those on X' .

Now Proposition 4.3 give isometries $\phi_i : X_i \rightarrow X'_i$ that send each boundary to the corresponding boundary. This in particular implies that ϕ_i sends κ_i to κ'_i and η to η' for $i = 1, 2$; ϕ_0 sends κ_1 to κ'_1 and ζ to ζ' .

Moreover, due to our choice of orientations, ϕ_1 can be chosen as orientation-preserving. If ϕ_2 is also orientation-preserving, the proof is done by gluing ϕ_1 and ϕ_2 . Suppose to the contrary that ϕ_2 is orientation-reversing. Our goal is to show that the (unsigned) distance between κ_1 and ζ differs with that between κ'_1 and ζ' . This will then contradict to the fact that ϕ_0 is an isometry, which must preserve the unsigned twist of γ_1 at X .

We now parametrise γ_1 by arc length λ so that κ_1 is located on the left side of δ_1 while λ increases, as in Figure 14. On X , we denote the signed displacement from η_1 to ζ_1 along γ_1 by d . Further, we denote the signed displacement from κ_1 to η along γ_1 by D . Similarly, we define the displacements d' and D' for curves and segments on X' .

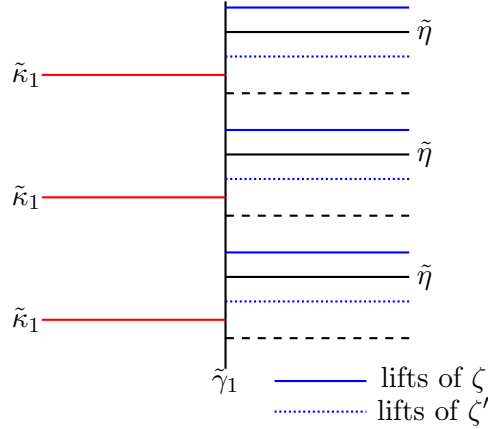

FIGURE 14. Description on the lifts of curves in Figure 13. Here the black dashed lines are lifts of the geodesic segment perpendicular to γ_1 and δ_0 .

From the assumption, the twist at γ_2, γ'_2 are nonzero and opposite: this forces $d = -d' \neq 0$. We also observe that $|d|, |d'|$ is bounded by half of $l_X(\gamma_1) = l_{X'}(\gamma'_1)$. This is because the geodesic perpendicular to γ_1 and δ_0 is equidistant from η along γ_1 , and ζ, ζ' cannot go across it. (See Figure 14: the black dashed lines are lifts of the geodesic perpendicular to γ_1 and δ_0 .)

Now we calculate the unsigned displacements between κ_1 and ζ (κ'_1 and ζ' , respectively). The former one is $|D + d + nl_X(\gamma_1)|$ for integers n and the latter one is $|D + d' + nl_X(\gamma_1)| = |D - d + nl_X(\gamma_1)|$ for integers n . If some of them are equal, then either

$$2D = nl_X(\gamma_1) \text{ for some integer } n \quad \text{or} \quad 2d = nl_X(\gamma_1) \text{ for some integer } n.$$

The former case is excluded since D cannot be a multiple of $l_X(\gamma_1)$. For the latter case, $2d$ is neither 0 (since γ_2 has nonzero twist) nor other multiples of $l_X(\gamma_1)$ (since $|d| < l_X(\gamma_1)/2$). This ends the proof. \square

5. PROOF OF THE MAIN THEOREM

We are now ready to prove the main theorem, which we state here again.

Theorem 1.2 (Simple length spectra as moduli). *Let S be a surface with nonabelian fundamental group and $\mathcal{T}(S)$ be the Teichmüller space of S . Then there exists a meagre subset V of $\mathcal{T}(S)$ satisfying the following; if $[f_1, X] \in \mathcal{T}(S) \setminus V$ and $[f_2, X'] \in \mathcal{T}(S)$ have the same simple length spectra, then $[f_1, X]$ and $[f_2, X']$ belong to the same orbit of $\text{Mod}^\pm(S)$.*

Proof. Suppose that $X \in \mathcal{T}(S) \setminus V$, $X' \in \mathcal{T}(S)$ and $\mathcal{L}(X) = \mathcal{L}(X')$. Recall that we have fixed the pants decomposition \mathcal{C} from Proposition 2.3, which gives an exhaustion $\{S_n\}$ of S by subsurfaces. Furthermore, after modifying the pants decomposition as in the proof of Proposition 4.4, one may assume the following; if $C_k \in \mathcal{C}$ bounds a one-holed torus that hosts another curve $C_{k'} \in \mathcal{C}$, then $l_{X'}(C_{k'}) > l_X(C_k)$. Since taking different pants decomposition does not alter the simple length spectrum, we may assume so.

We denote the subsurface of X' corresponding to S_n by X'_n . Put in other words, X' is decomposed into generalised pair of pants P'_i , glued with each other along boundaries, and $X'_n = \cup_{i=1}^n P'_i$ for each n .

We can first rule out the cases of generalised pair of pants and one-holed/punctured torus since they were treated in the last section. Thus, we may begin with X'_2 , a subsurface made out of two generalised pairs of pants. These cases were dealt with in Proposition 4.3 and 4.4, so we can assume the isometric embedding ψ_2 of X'_2 into X .

Now suppose that $\psi_n : X'_n \rightarrow X$ is an isometric embedding. Let us denote the subsurface $X'_{n+1} \setminus X'_n$ by P' . Then P' is attached to a pair of pants $Q' \subseteq X'_n$ along a curve γ'_1 comprising \mathcal{C}' . Since X'_n contains at least two pairs of pants, Q' is connected to yet another pair of pants $R' \subseteq X'_n$ along a curve $\gamma'_2 \neq \gamma'_1$ comprising \mathcal{C}' . Let Q, R be their image on X , respectively.

Let us first assume that P' is a generalised pair of pants. We now define curves $\{\alpha'_i, \gamma'_i, \delta'_i\}$ on P', Q', R' as in Figure 13, and read $\alpha_i, \gamma_i, \delta_i$ on X by comparing lengths. Then the proof of Proposition 4.5 shows that $\alpha_1 \cup \gamma_1$ becomes a spine of an immersed generalised shirt in X , which is divided into Q and another immersed generalised pair of pants P . Moreover, the proposition gives an isometry $\phi : P' \cup Q' \cup R' \rightarrow P \cup Q \cup R$ sending each of $\{\alpha'_i, \gamma'_i, \delta'_i\}$ to corresponding $\{\alpha_i, \gamma_i, \delta_i\}$.

In fact, more can be said from the proof of Proposition 4.5. Note that $\psi_n|_{Q' \cup R'} : Q' \cup R' \rightarrow Q \cup R$ is also an isometry; in particular, it sends each of $\alpha'_i, \gamma'_i, \delta'_i$ on $Q' \cup R'$ to the corresponding curve on $Q \cup R$. The proof then guarantees that such isometry can be extended to the entire isometry $\phi : P' \cup Q' \cup R' \rightarrow P \cup Q \cup R$. Thus, ψ_n and ϕ can be glued on $Q' \cup R'$.

It remains to show that $P \cap X_n$ is a single curve, the image of C'_n by ψ_n . We first claim that $\int(P)$ is disjoint from $\text{int}(X_n)$. First, X_n cannot cover entire $\text{int}(P)$ since the annular neighborhood of γ_1 inside P is never covered by X_n . Thus, if X_n intersects with $\text{int}(P)$, a boundary curve η of X_n should pass through $\text{int}(P)$. Since P does not host any essential curve, η is not

contained inside P and intersects with one of δ_1, δ_2 . However, since δ'_1, δ'_2 are assumed to be disjoint from X'_n , Lemma 3.12 prevents this.

Furthermore, since P' is attached to X'_n only along γ' , δ'_1 and δ'_2 are not equal to any boundary curves of X'_n . Thus, δ_1 and δ_2 are also different with the boundary curves of X_n , and P is also attached to X_n only along γ . Thus, gluing ψ_n and ϕ on $Q' \cup R'$ is sufficient to construct ψ_{n+1} .

If P' is a one-holed torus, we still have to investigate whether ϕ respects the gluing at $\delta'_1 = \delta'_2$. This time, we observe that $\phi|_{P' \cup Q'}$ becomes an isometry from $P' \cup Q'$, as an immersed generalised pair of pants, onto $P \cup Q$. Again, the proof of Proposition 4.4 asserts that $\phi|_{P' \cup Q'}$ can be extended to the isometry $P' \cup Q'$, as a 2-holed/punctured torus this time, onto $P \cup Q$. Thus, ψ_{n+1} is well-defined also in this case.

Since $\{X'_n\}$ is an exhaustion of X' , we obtain an isometric embedding $\psi : X' \rightarrow X$ after this induction process. We now claim that ψ is surjective. To show this suppose not; $\psi(X')$ is a subsurface of X . Since X is connected, the only possibility is that X' has a boundary curve C'_n while $C = \psi(C'_n)$ is an interior curve of X . In this case, C has an intersecting curve η ; if it is non-separating, then there exists another curve η such that $i(C, \eta) = 1$; otherwise, there exists another curve η such that $i(C, \eta) = 2$ and $i_{alg}(C, \eta) = 0$. Since $\mathcal{L}(X') = \mathcal{L}(X)$, there exists a curve $\eta' \subseteq X'$ such that $l_{X'}(\eta') = l_X(\eta)$. Since $\psi : X' \rightarrow X$ is an isometric embedding and $\mathcal{L}(X)$ is simple, it follows that $\psi(\eta') = \eta$. As such, $i(\psi(\eta'), C) = i(\eta, C) > 0$, which contradicts to the assumption that C is a boundary curve of $\psi(X')$. □

6. FURTHER QUESTIONS

We conclude this article by suggesting some further questions.

- (1) It can be asked whether the meagre set V we constructed is optimal. Indeed, it is not known whether the isometry classes of *every* hyperbolic surfaces are determined by their *simple* length spectra.
- (2) For surfaces of finite type, our argument can be brought down to the moduli space. Indeed, we know that $\text{Mod}^+(S_{g,p,b})$ acts on $\mathcal{T}_{g,p,b}$ properly discontinuously, whose quotient is the moduli space $\mathcal{M}(S)$. Thus, for example, $V/\text{Mod}^+(S_{g,p,b})$ is a meagre, WP-measure 0 subset of $\mathcal{M}(S_{g,p,b})$, and (unmarked) hyperbolic surfaces outside it will be distinguished by their simple length spectra.

The authors hope that a similar argument can be made for surfaces of infinite type. For example, the mapping class group acts on the quasiconformal Teichmüller space of some Riemann surfaces discretely and faithfully (See [FST04]). Similar discussion for Fenchel-Nielsen Teichmüller space is expected.

- (3) While studying Question (1), Aougab et al. suggested in [ALLX20] that finite covers of a closed topological surface might be probed via

simple lifts of closed curves. Our result suggests at least one (actually abundant) hyperbolic structure whose simple length spectrum is topologically rigid on comeagre subset of the Teichmüller space; this structure may help deal with this problem.

APPENDIX A. PANTS DECOMPOSITIONS OF SURFACES

We begin with a version of Richards' classification of surfaces. Besides of the genus g (which may be infinite), each surface S is associated with three invariants:

- the space X of ends of $\text{int}(S)$,
- the space Y of non-planar ends, and
- the space Z of boundaries.

Here X is a compact, separable, totally disconnected space and Y, Z are disjoint closed subsets of X , where Z consists of isolated points of X . Then S is made from a sphere by removing $X \setminus Z$, then removing disjoint open discs, each containing one element of Z and not containing any other elements of X , and then attaching g handles that accumulate to points of Y . (See Theorem 3 of [Ric63])

Before dealing with general cases, we first consider the case $|X| \leq 3$. This corresponds to finite-type surfaces $S_{g,p,b}$ with $p + b \leq 3$, the Loch Ness monster with $p + b \leq 2$, 1-punctured/bordered Jacob's ladder or the tripod surface. In any case, they admit the pants decompositions desired in Proposition 2.3. (See Figure 15.)

Thus, from now on, we consider the case of $|X| \geq 4$. Let Σ be a sphere, K be a Cantor set on Σ , $Y \subseteq X \subseteq K$ be closed sets of Σ , and Z be a subset of $X \setminus Y$ consisting of isolated points. Note that there exist open discs $\{U_{k,i}\}_{i=1}^{2^k}$ on Σ such that

- $\overline{U_{k,1}}, \dots, \overline{U_{k,2^k}}$ are disjoint for each k ,
- $U_{k,i}$ contains $\overline{U_{k+1,2i-1}} \cup \overline{U_{k+1,2i}}$, and
- $\bigcap_k \left(\bigcup_{i=1}^{2^k} U_{k,i} \right) = K$.

Since $|X| \geq 4$, there exists disjoint U_{k_t, i_t} for $t = 1, \dots, 4$ such that $X \cap U_{k_t, i_t} \neq \emptyset$ for each t and $X \subseteq \bigcup_{t=1}^4 U_{k_t, i_t}$. By relabelling, we may assume that U_{k_t, i_t} are $U_{2,1}, U_{2,2}, U_{2,3}$ and $U_{2,4}$.

We further modify as follows. if $U_{k+1,4i-3}$ and $U_{k+1,4i-2}$ contain elements of X but $U_{k+1,4i-1}$ and $U_{k+1,4i}$ do not, then erase $U_{k,2i-1}, U_{k,2i}$, and discs in $U_{k,2i}$ from the collection and let $U_{k+1,4i-3}, U_{k+1,4i-2}$ replace the roles of $U_{k,2i-1}$ and $U_{k,2i}$. The other way is done similarly. After this procedure, one may assume that each $U_{k,i}$ either contains 0 or 1 elements of X , or both $U_{k+1,2i-1}$ and $U_{k+1,2i}$ contain elements of X . (†)

We first remove $X \setminus Z$ from Σ . Next, each point of Z is bounded by open discs $U_{k,i}$ not containing any other points of X ; we remove the one with smallest k ; these discs for different points of Z are disjoint. Next, for each disc $U_{k,i}$ ($k > 2$) containing a point of Y , we consider a smaller open disc

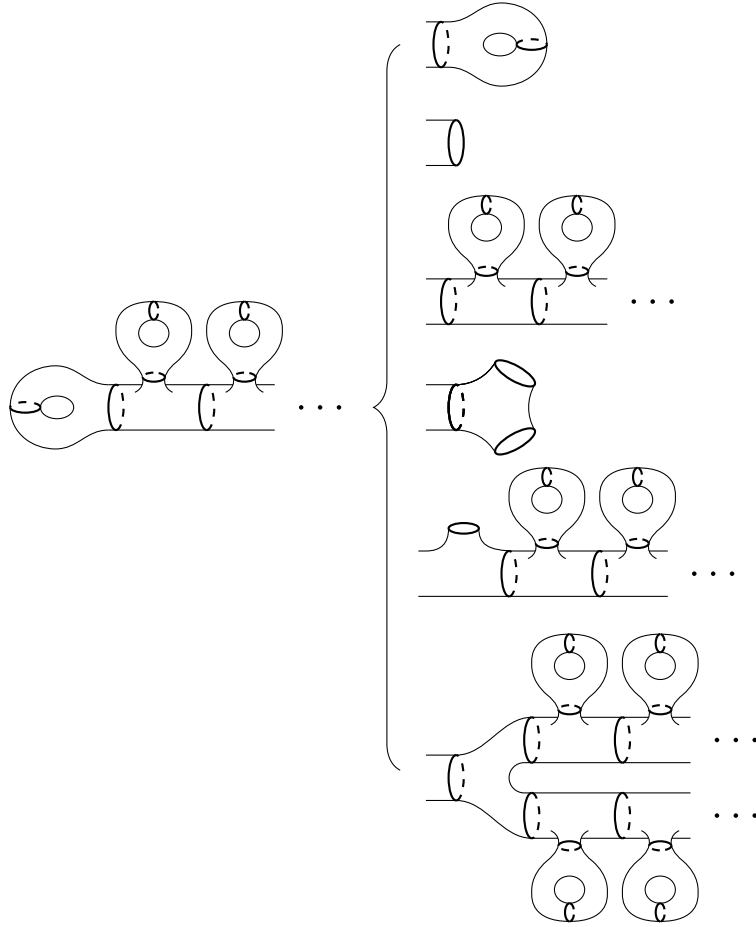

FIGURE 15. Pants decompositions of few-ended surfaces

$V_{k,i} \subseteq U_{k,i}$ still containing $\overline{U_{k+1,2i-1}}$ and $\overline{U_{k+1,2i}}$. Now $U_{k,i} \setminus \overline{V_{k,i}}$ is replaced with $(U_{k,i} \setminus \overline{V_{k,i}}) \# (S^1 \times S^1)$, a connected sum with a torus. Finally, if $Y = \emptyset$ and $1 < g < \infty$, then we perform the above procedure for g number of $U_{k,i}$'s. After this, points in Z correspond to boundary components, X becomes the space of ends and Y becomes the space of non-planar ends.

We now observe a pants decomposition of this surface. Let \mathcal{V} (\mathcal{U} , resp.) be the collection of discs $V_{k,i}$ ($U_{k,i}$ not having $V_{k,i}$, resp.) containing at least 2 elements of X . For each $V_{k,i} \in \mathcal{V}$, we see that $U_{k+1,2i-1}$ and $U_{k+1,2i}$ contain elements of X . For $t = 2i - 1, 2i$, remove $U_{k+1,t}$ from $\overline{V_{k,i}}$ if $U_{k+1,t} \in \mathcal{U}$; otherwise we remove the unique element of X in $U_{k+1,t}$ from $\overline{V_{k,i}}$. This gives a generalised pair of pants $P(V_{k,i})$ for $V_{k,i}$. We can obtain similar generalised pairs of pants $P(U_{k,i})$ for $U_{k,i} \in \mathcal{U}$. Finally, the part $\overline{U_{k,i}} \setminus V_{k,i}$ is considered a union of a pair of pants and a one-holed torus.

Note that $U_{0,1}, U_{1,1}, U_{1,2} \in \mathcal{U}$. Here $P(U_{0,1}) \cup (\Sigma \setminus U_{0,1})$ becomes a cylinder that joins two generalised pairs of pants $P(U_{1,1})$ and $P(U_{1,2})$; these comprise

a generalised shirt S_1 that serves as a base case. Further, suppose that S_n is a subsurface containing all of $\Sigma \setminus (\cup_{i=1}^{2^n} U_{n,i})$. We first attach 2-holed tori corresponding to $(\overline{U_{n,i}} \setminus V_{n,i}) \# (S^1 \times S^1)$ along boundaries of S_n whenever available; and then we attach generalised pair of pants corresponding to $V_{n,i} \in \mathcal{V}$ or $U_{n,i} \in \mathcal{U}$, again whenever available. The resulting subsurface S_{n+1} then contains all of $\Sigma \setminus (\cup_{i=1}^{2^{n+1}} U_{n+1,i})$. Since $\Sigma \setminus (\cup_{i=1}^{2^n} U_{n,i})$ gives an exhaustion of S , we conclude that $\{S_n\}$ serves as an exhaustion of S .

See Figure 1 for the resulting pants decomposition.

APPENDIX B. ANALYTIC FUNCTIONS

In this section, we prove the following lemma.

Lemma B.1. *Let $f : U \rightarrow \mathbb{R}^m$ be an analytic function on a domain $U \subseteq \mathbb{R}^n$ that does not vanish identically. Then there exists a countable family of submanifolds $\{S_i\}_{i \in \mathbb{N}}$ of U such that $f \neq 0$ outside $\cup_i S_i$.*

Proof. It suffices to prove for $m = 1$. We define the sets

$$C_j = \{x \in U : \partial_\alpha f(x) = 0 \text{ for all index } \alpha \text{ with } |\alpha| \leq j\}$$

for $j \geq 0$. We observe that $C_0 \supseteq C_1 \supseteq \dots$ and $\cap_i C_i = \emptyset$. Indeed, the existence of a point $x \in \cap_i C_i$ will imply $f \equiv 0$ due to the analyticity of f .

We now define $S_i = C_{i-1} \setminus C_i$. It follows from the previous observation that $\cup_{i \in \mathbb{N}} S_i = C_0$, and $f \neq 0$ outside C_0 . It remains to show that S_i is contained in a finite union of submanifolds. For each index α we define $S_{\alpha,j} = \{x : \partial_\alpha f(x) = 0 \text{ but } \partial_{\alpha'} f(x) \neq 0\}$, where $\alpha'_i = \alpha_i + \delta_{ij}$. Then the implicit function theorem tells us that $S_{\alpha,j}$ is a submanifold. Since $S_i \subseteq \cup_{|\alpha|=i, 1 \leq j \leq n} S_{\alpha,j}$, the proof is done. \square

APPENDIX C. PROOF OF LEMMA 2.14

This appendix stands for the proof of the following lemma.

Lemma 2.14. *Let α be a multicurve on S with $i(\alpha, C_1) = k$.*

- (1) *If $k = 0$, then $l_{X_r}(\alpha)$ converges to a finite value as $r \rightarrow 0$.*
- (2) *If $k > 0$, then $\lim_{r \rightarrow 0} l_{X_r}(\alpha) / \ln r = -2k$.*

Proof. Here C_1 is adjacent to one or two pairs of pants. In each case, we draw the geodesic segments perpendicular to the boundaries of pairs of pants as described in Figure 16. We also pick basepoints $\eta \cap \kappa_3 = p$, $\eta^\pm \cap \kappa_3^\pm = p^\pm$ in each case. The complement of these pants in S is denoted by R .

For the sake of simplicity, we explain for the case that C_1 is non-separating. In order to define representations for X_r , we first fix a unit vector \vec{V} on \mathbb{H} based at some $\tilde{p} \in \mathbb{H}$. Also, let \vec{v} be a unit vector on X_r based at p . Then there exists representations $\Gamma_r : \pi_1(S, p) \rightarrow \text{PSL}(2, \mathbb{R})$ corresponding to X_r 's such that \vec{v} is lifted to \vec{V} .

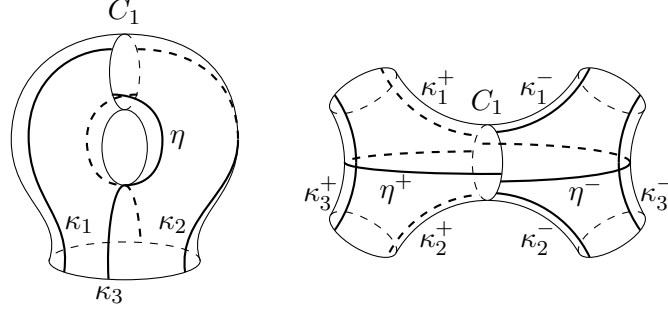
 FIGURE 16. Pants containing C_1

We now investigate the monodromy of loops α in $\pi_1(S)$. Suppose first that α and C_1 are disjoint. On each X_r , α is homotopic to a concatenation of the following segments:

- geodesics on R (meeting ∂R orthogonally),
- geodesics along ∂R or
- geodesic κ_3 .

The angles among such geodesics are kept perpendicular during the pinching. Moreover, the lengths of the first two types are unchanged during the pinching. The length of κ_3 continuously grows and converges to a finite value. Moreover, the length proportion of segments of κ_3 cut by p also varies continuously and converges to a finite value. Consequently, the image $\vec{V}_{\alpha,r} = \Gamma_r(\alpha)(\vec{V})$ of \vec{V} by the monodromy along α varies continuously along r , converging to a limit $\vec{V}_{\alpha,0}$ as $r \rightarrow 0$.

Let us now consider a segment β from p to C_1 , where β is not transversing C_1 but only meets at one endpoint. Concatenating β with a segment along η , from C_1 to p , it follows that β is homotopic to a concatenation of a loop $\alpha \in \pi_1(S)$ disjoint from C_1 and a segment along η . This segment along η is exactly half of entire η . Then, we can characterise the lift \bar{C}_1 of C_1 on \mathbb{H} as follows: the geodesic transport $\vec{V}'_{\alpha,r}$ of $V_{\alpha,r}$ by distance $\pm l_{X_r}(\eta)/2$ becomes a normal vector to \bar{C}_1 . Such lifts bound a convex region in \mathbb{H} , which we denote by K . As $r \rightarrow 0$, those lifts converge to points in $\partial\mathbb{H}$, namely, the endpoints of the geodesic along $\vec{V}_{\alpha,0}$ for various α . Accordingly, K becomes the full \mathbb{H} .

We now discuss the asymptotic behavior (along the pinching process) of a curve α with $i(\alpha, C_1) = k > 0$. On each X_r , α is homotopic to a concatenation of geodesics $\{\beta_i\}_{i=1}^k$ along C_1 and $\{\gamma_i\}_{i=1}^k$ orthogonal to C_1 . It follows that

$$(C.1) \quad \sum_i l_{X_r}(\gamma_i) \leq l_{X_r}(\alpha) \leq \sum_i l_{X_r}(\beta_i) + \sum_i l_{X_r}(\gamma_i).$$

We claim that $l_{X_r}(\beta_i)$ is of class $O(r)$ during the pinching. This is because γ_i, γ_{i+1} never crosses η 's. To see this, note that the geodesics orthogonally

departing from C_1 are parametrized by their departure point on C_1 . If we slightly perturb η , it will still return to C_1 but not orthogonally. Moreover, the threshold of this perturbation is locally uniform along r . Thus, if γ_i were η at a moment X_r , then it would stay at η forever. Note also that the shear among the lifts $\bar{\eta}$ of η each side of \bar{C}_1 is kept constant during the pinching. As a result, if a lift $\bar{\alpha}$ of α is sandwiched by two η 's on each side of \bar{C}_1 marking twist τ , then $l_{X_r}(\beta_i)$ is always dominated by $\tau l(\bar{C}_1) = \tau r$. See Figure 17.

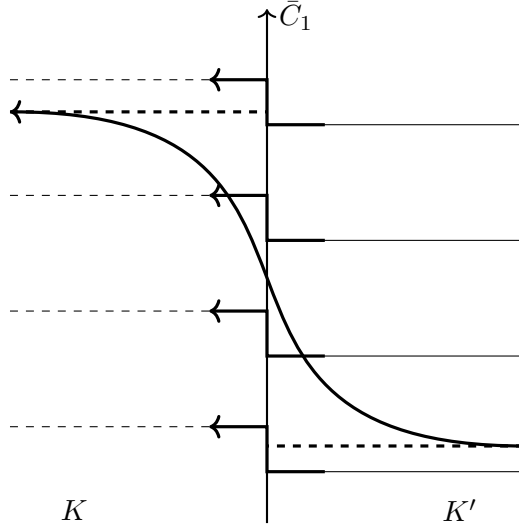

FIGURE 17. Twist at C_1

Meanwhile, $l_{X_r}(\gamma_i)$ grows exponentially. To elaborate this, we first fix a lift $\bar{\gamma}_i$ of γ_i in K , which meets lifts \bar{C}_1, \bar{C}'_1 of C_1 at endpoints. As explained before, \bar{C}_1 and \bar{C}'_1 converge to limits $c, c' \in \partial\mathbb{H}$, respectively. (Here $c \neq c'$ because γ_i is nontrivial) Let $\hat{\gamma}_i$ be the geodesic connecting c and c' , and fix an arbitrary point p_{ref} on $\hat{\gamma}_i$. Let p_{perp} be the foot of perpendicular from p_{ref} to $\bar{\gamma}_i$. Note that $d(p_{perp}, p_{ref}) \rightarrow 0$ as $r \rightarrow 0$.

\bar{C}_1 is adjacent to a sequence of lifts of η . Among them we pick two consecutive lifts $\bar{\eta}_+, \bar{\eta}_-$ inside K , sandwiching the ray $\bar{\gamma}_i$. (Recall that $\bar{\gamma}_i$ will not cross $\bar{\eta}_+$ or $\bar{\eta}_-$ during pinching) $\bar{\eta}_+$ meets \bar{C}_1 at one endpoint and meets another lift $\bar{C}_{1,+}$ of C_1 at another endpoint. Similarly, $\bar{\eta}_-$ meets \bar{C}_1 and another lift $\bar{C}_{1,-}$ of C_1 at endpoints. $\bar{C}_{1,+}$ and $\bar{C}_{1,-}$ also converge to points c_+ and c_- on $\partial\mathbb{H}$, respectively, as $r \rightarrow 0$.

Let us work on the upper half plane model with $c = \infty, c_+ = 1$ and $c_- = 0$. We fix points a_{\pm}, b_{\pm}, d on the real line as in Figure 18, and define $r_{1,\pm}$ and $r_{2,\pm}$ as follows:

$$r_{1,\pm} := \left| a_{\pm} - \frac{a_{\pm} + b_{\pm}}{2} \right|, \quad r_{2,\pm} := \left| d - \frac{a_{\pm} + b_{\pm}}{2} \right|.$$

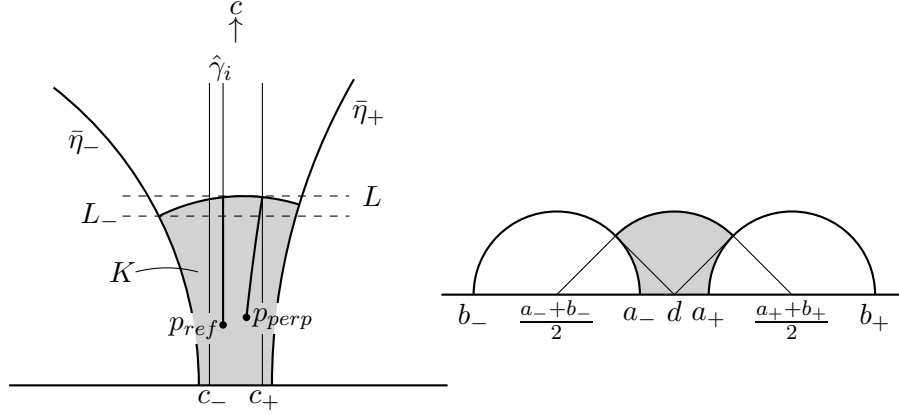
 FIGURE 18. Pinching described on \mathbb{H}

Note that a_{\pm}, d remain bounded while $|b_{\pm}| \rightarrow \infty$ as $r \rightarrow 0$. Thus, $r_{1,\pm}/r_{2,\pm}$ tends to 1 during the pinching.

We now consider three horocycles based at ∞ : L passing through the highest point of \bar{C}_1 , and L_{\pm} passing through $\bar{C}_1 \cap \bar{\eta}_{\pm}$. We record their Euclidean y -coordinates of L , L_{\pm} , and p_{perp} by y_L , $y_{L_{\pm}}$, and $y_{p_{perp}}$, respectively. Then we have

$$(C.2) \quad \lim_{r \rightarrow 0} \frac{y_{L_{\pm}}}{y_L} = \lim_{r \rightarrow 0} \frac{r_{1,\pm}}{r_{2,\pm}} = 1$$

and

$$(C.3) \quad \ln \frac{\min(y_{L_+}, y_{L_-})}{y_{p_{perp}}} \leq d(p_{perp}, \bar{C}_1) \leq \ln \frac{y_L}{y_{p_{perp}}}.$$

from the geometry.

Let w be the Euclidean width of \bar{C}_1 . Then we finally relate the length r of C_1 with y_L as follows:

$$\begin{aligned} \ln \left(\frac{1}{y_L} \int_{\bar{C}_1} dx \right) &= \ln w - \ln y_L \leq \ln r = \ln \left(\int_{\bar{C}_1} \frac{ds}{y} \right) \\ &\leq \ln \left(\frac{y_L}{\min(y_{L_+}, y_{L_-})^2} \int_{\bar{C}_1} dx \right) = \ln w - \ln y_L + \ln \frac{y_L^2}{\min(y_{L_+}, y_{L_-})^2}. \end{aligned}$$

Here the Euclidean width w of \bar{C}_1 is equal to

$$\frac{r_{2,+}^2 - r_{1,+}^2}{r_{2,+}} + \frac{r_{2,-}^2 - r_{1,-}^2}{r_{2,-}}.$$

Recall that $r_{1,\pm}/r_{2,\pm} \rightarrow 1$ as $r \rightarrow 0$. Moreover,

$$\lim_{r \rightarrow 0} [(r_{2,+} - r_{1,+}) + (r_{2,-} - r_{1,-})] = \lim_{r \rightarrow 0} (a_+ - a_-) = 1.$$

Using this, we conclude that $w \rightarrow 2$ and $\ln y_L / \ln r \rightarrow -1$ as $r \rightarrow 0$. From this conclusion and Equation C.2, C.3, we obtain that

$$\lim_{r \rightarrow 0} \frac{d(p_{\text{perp}}, \bar{C}_1)}{-\ln r} = 1.$$

The same logic applies to \bar{C}'_1 , the other end. Thus we obtain

$$\lim_{r \rightarrow 0} \frac{l_{X_r}(\gamma_i)}{-\ln r} = 2.$$

Similar discussion also holds for other γ_i 's. Since $l_{X_r}(\beta_i)$'s are of class $O(r)$, we conclude that

$$\begin{aligned} 2i(\alpha, C_1) &= \lim_{r \rightarrow 0} \sum_{i=1}^k \frac{l_{X_r}(\gamma_i)}{-\ln r} \leq \liminf_{r \rightarrow 0} \frac{l_{X_r}(\alpha)}{-\ln r} \\ &\leq \limsup_{r \rightarrow 0} \frac{l_{X_r}(\alpha)}{-\ln r} \leq \lim_{r \rightarrow 0} \sum_{i=1}^k \left(\frac{l_{X_r}(\gamma_i)}{-\ln r} + \frac{l_{X_r}(\beta_i)}{-\ln r} \right) = 2i(\alpha, C_1). \quad \square \end{aligned}$$

REFERENCES

- [ALLX20] Tarik Aougab, Max Lahn, Marissa Loving, and Yang Xiao. Characterizing covers via simple closed curves. *arXiv*, 2020.
- [ALP⁺11] Daniele Alessandrini, Lixin Liu, Athanase Papadopoulos, Weixu Su, and Zongliang Sun. On Fenchel-Nielsen coordinates on Teichmüller spaces of surfaces of infinite type. *Annales Academiæ Scientiarum Fennicæ. Mathematica*, 36:621–659, 2011.
- [Bak04] Richard L. Baker. “Lebesgue measure” on \mathbb{R}^∞ , II. *Proceedings of the American Mathematical Society*, 132(9):2577–2591, 2004.
- [BS88] Peter Buser and Klaus-Dieter Semmler. The geometry and spectrum of the one holed torus. *Commentarii Mathematici Helvetici*, 63:259–274, 1988.
- [Bus92] Peter Buser. *Geometry and Spectra of Compact Riemann Surfaces*. Number 106 in Progress in Mathematics. Birkhäuser, 1992.
- [Cro90] Christopher B. Croke. Rigidity for surfaces of nonpositive curvatures. *Commentarii Mathematici Helvetici*, 65:150–169, 1990.
- [FLP79] Albert Fathi, François Laudenbach, and Valentin Poénaru. *Travaux de Thurston sur les surfaces*, volume 66 of *Astérisque*. Société Mathématique de France, Paris, 1979. Séminaire Orsay, With an English summary.
- [FM12] Benson Farb and Dan Margalit. *A primer on mapping class groups*, volume 49 of *Princeton Mathematical Series*. Princeton University Press, Princeton, NJ, 2012.
- [FST04] Ege Fujikawa, Hiroshige Shiga, and Masahiko Taniguchi. On the action of the mapping class group for riemann surfaces of infinite type. *Journal of the Mathematical Society of Japan*, 56(4):1069–1086, 2004.
- [Gel62] Israil M. Gel’fand. Automorphic functions and the theory of representations. *Proceedings of the International Congress of Mathematics*, Stockholm:74–85, 1962.
- [Haa85] Andrew Haas. Length spectra as moduli for hyperbolic surfaces. *Duke Mathematical Journal*, 52:923–934, 1985.

- [HMV19] Jesús Hernández Hernández, Israel Morales, and Ferrán Valdez. The Alexander method for infinite-type surfaces. *The Michigan Mathematical Journal*, 68(4):743–753, 2019.
- [Hub59] Heinz Huber. Zur analytischen theorie hyperbolischer raumformen und bewegungsgruppen. *Mathematische Annalen*, 138:1–26, 1959.
- [Hub61] Heinz Huber. Zur analytischen theorie hyperbolischer raumformen und bewegungsgruppen II. *Mathematische Annalen*, 142:385–398, 1961.
- [Hub06] John H. Hubbard. *Teichmüller Theory and applications to geometry, topology, and dynamics*. Matrix Editions, 2006.
- [IT92] Yoichi Iwayoshi and Masahiko Taniguchi. *An Introduction to Teichmüller Spaces*. Springer-Verlag, 1992.
- [Kac66] Mark Kac. Can one hear the shape of a drum? *American Mathematical Monthly*, 73(4):1–23, 1966.
- [KF12] Felix Klein and Robert Fricke. *Vorlesungen über die Theorie der Elliptischen Modulfunctionen/Automorphenfunktionen*. G. Teubner, Leipzig, 1896/1912.
- [Luo98] Feng Luo. Geodesic length functions and Teichmüller spaces. *Journal of Differential Geometry*, 48:275–317, 1998.
- [Mau13] Rasimate Maungchang. The Sunada construction and the simple length spectrum. *Geometriae Dedicata*, 163:349–360, 2013.
- [McK72] Henry P. McKean. Selberg’s trace formula as applied to a compact Riemann surface. *Communications on Pure and Applied Mathematics*, 15:225–246, 1972.
- [Mon17] Sugata Mondal. Rigidity of length-angle spectrum for closed hyperbolic surfaces. *arXiv*, 2017.
- [MP08] Greg McShane and Hugo Parlier. Multiplicities of simple closed geodesics and hypersurfaces in Teichmüller space. *Geometry & Topology*, 12(4):1883–1919, 2008.
- [MS09] Dan Margalit and Saul Schleimer. Dehn twists have roots. *Geometry & Topology*, 13(3):1495–1497, 2009.
- [Ota90] Jean-Pierre Otal. Le spectre marque des longueurs des surfaces a courbure negative. *Annals of Mathematics*, 131(1):151–162, 1990.
- [Par18] Hugo Parlier. Interrogating surface length spectra and quantifying isospectrality. *Mathematische Annalen*, 370:1759–1787, 2018.
- [Ran80] Burton Randol. The length spectrum of a Riemann surface is always of unbounded multiplicity. *Proceedings of the American Mathematical Society*, 78(3):455–456, 1980.
- [Ric63] Ian Richards. On the classification of noncompact surfaces. *Transactions of the American Mathematical Society*, 106(2):259–269, 1963.
- [Sun85] Toshikazu Sunada. Riemannian coverings and isospectral manifolds. *Annals of Mathematics*, 121(1):169–186, 1985.
- [Vig78] Marie-France Vignéras. Exemples de sous-groupes discrets non conjugués de $\mathrm{PSL}(2, \mathbb{R})$ qui ont la même fonction zêta de selberg. *Comptes rendus de l’Académie des Sciences Série I Mathématiques*, 287:171–195, 1978.
- [Wol79] Scott Wolpert. The length spectra as moduli for compact Riemann surfaces. *Annals of Mathematics*, 109(2):323–351, 1979.
- [Wol90] Scott W. Wolpert. The hyperbolic metric and the geometry of the universal curve. *Journal of Differential Geometry*, 31(2):417–472, 1990.

DEPARTMENT OF MATHEMATICAL SCIENCES, KAIST, 291 DAEHAK-RO YUSEONG-GU,
DAEJEON, 34141, SOUTH KOREA

Email address: `hrbaik@kaist.ac.kr`

DEPARTMENT OF MATHEMATICAL SCIENCES, KAIST, 291 DAEHAK-RO YUSEONG-GU,
DAEJEON, 34141, SOUTH KOREA

Email address: `inhyeokchoi@kaist.ac.kr`

DEPARTMENT OF MATHEMATICAL SCIENCES, KAIST, 291 DAEHAK-RO YUSEONG-GU,
DAEJEON, 34141, SOUTH KOREA

Email address: `dongryul.kim@kaist.ac.kr`