TRUSTWORTHY REPRESENTATION LEARNING ACROSS DOMAINS

A PREPRINT

Ronghang Zhu
University of Georgia
ronghangzhu@uga.edu

Dongliang Guo
University of Virginia
dongliang.guo@virginia.edu

Daiqing Qi
University of Virginia
daiqingqi@virginia.edu

Zhixuan Chu
Ant Group
chuzhixuan.czx@alibaba-inc.com

Xiang Yu
Amazon, Prime Video
yuxiang03@gmail.com

Sheng Li
University of Virginia
shengli@virginia.edu

August 31, 2023

ABSTRACT

As AI systems have obtained significant performance to be deployed widely in our daily live and human society, people both enjoy the benefits brought by these technologies and suffer many social issues induced by these systems. To make AI systems good enough and trustworthy, plenty of researches have been done to build guidelines for trustworthy AI systems. Machine learning is one of the most important parts for AI systems and representation learning is the fundamental technology in machine learning. How to make the representation learning trustworthy in real-world application, e.g., cross domain scenarios, is very valuable and necessary for both machine learning and AI system fields. Inspired by the concepts in trustworthy AI, we proposed the first trustworthy representation learning across domains framework which includes four concepts, i.e, robustness, privacy, fairness, and explainability, to give a comprehensive literature review on this research direction. Specifically, we first introduce the details of the proposed trustworthy framework for representation learning across domains. Second, we provide basic notions and comprehensively summarize existing methods for the trustworthy framework from four concepts. Finally, we conclude this survey with insights and discussions on future research directions.

Keywords Trustworthy, Representation Learning, Domain Adaptation, Few Shot, Open Set, Domain Generalization, Robustness, Fairness, Privacy, Explainability

1 Introduction

Representation learning stands as a cornerstone challenge within the realm of machine learning. Its primary purpose is to encapsulate and delineate data in a manner conducive to the application of machine learning techniques. The efficacy of machine learning algorithms is profoundly contingent upon the caliber of data representation. Invariably, the potency of these algorithms is closely intertwined with the discriminative nature of the representations learned. Notably, representations endowed with heightened discriminative attributes consistently yield superior performance in contrast to their less-discriminative counterparts. As a consequence, much of the efforts have been devoted to feature engineering works which aim to design a good feature representation from raw data that can benefit machine learning. Early feature engineering works are highly depended on domain specific and human ingenuity. For example, in computer vision, some hand-designed feature descriptors, e.g., Local Binary Pattern (LBP) [Guo et al., 2010], Scale Invariant Feature Transform (SIFT) [Lowe, 1999], and Histogram of Oriented Gradients (HOG) [Dalal and Triggs, 2005], are proposed to extract the representations of the data for recognition and detection related tasks. However, these well-designed descriptors are heavily relied on human effort and domain specialist knowledge. In order to reduce the dependence on feature engineering, an automatic representation learning strategy, i.e., deep learning, is proposed to reduce the need of human labor and the requirement of specific expert knowledge. Deep learning [Pouyanfar et al., 2018, Guo et al., 2016] has emerged as an omnipresent facet of representation learning, finding extensive application

across a plethora of real-world domains including but not limited to image classification, video captioning, and social network analysis. The confluence of burgeoning data availability and remarkable advancements in high-performance computing resources has catalyzed the proliferation of deep learning frameworks. Noteworthy examples encompass Convolutional Neural Network (CNN) [LeCun et al., 1995], Recurrent Neural Network (RNN) [Jordan, 1997], Graph Neural Network (GNN) [Scarselli et al., 2008], Generative Adversarial Network (GAN) [Goodfellow et al., 2020], and Transformer [Vaswani et al., 2017]. This lineage of deep learning frameworks has charted remarkable strides in contrast to earlier paradigms of feature engineering. Their prowess spans a spectrum of domains including computer vision, natural language processing, speech, audio processing, and beyond. The amalgamation of these frameworks with vast and diverse domains has culminated in substantial advancements and accomplishments.

Despite the impressive achievements exhibited by these sophisticated representation learning methodologies on extensive datasets across an array of tasks [Karras et al., 2019, Liu and Liu, 2020, Donahue et al., 2014], their effectiveness often falters when confronted with the complexities of real-world situations. A glaring example of this lies in their inability to seamlessly adapt to uncharted territories, such as novel datasets or unfamiliar environments. A pertinent illustration is that of a human detector fine-tuned on indoor images, which proves inadequate when exposed to testing images derived from outdoor contexts. This predicament can be attributed to the concept of domain shift [Zhou et al., 2022, Wang and Deng, 2018, Wang et al., 2022], wherein a discernible disparity emerges between the distribution of the training data and that of the testing data. Even slight modifications in the training data can lead to significant performance degradation in numerous deep learning methods [Hendrycks and Dietterich, 2019, Recht et al., 2019, Oquab et al., 2014, Yosinski et al., 2014] when applied to a target dataset. To enhance the performance of representation learning across domains in real-world scenarios, a multitude of techniques and architectures have been proposed. These approaches aim to tackle the challenges from various angles, collectively striving to address the impact of diverse factors. For instance, in the field of domain adaptation [Wang and Deng, 2018], learning the representations that can reduce the domain gap between source and target is crucial for models to improve the performance [Long et al., 2015, Tzeng et al., 2015, Long et al., 2018]; in the context of domain generalization problem [Wang et al., 2022, Zhou et al., 2022], it is very important to learn the generalizable representations to improve the robustness of the systems under different application scenarios; with regard to cross-domain few-shot problem, how to enrich the diversity of the support set is one of the pivotal directions to learn the reliable representation to benefit downstream tasks. Inspired by the distinct demands posed by various problems in representation learning across domains, researchers are dedicating increased attention and diligence towards rendering this process more dependable, resilient, equitable, and ethically sound. The objective is to instill trust across diverse domains. In the context of this article, our aim is to deliver a timely and comprehensive survey of recent endeavors that confront the multifaceted challenges associated with establishing "trustworthiness" in representation learning across domains.

1.1 Trustworthy for AI and Representation Learning Across Domains

In recent years, Artificial Intelligence (AI) has deeply reshaped our daily lives and society. Various AI systems have been deployed in every corner of our life, including transportation, education, public health, security, business, and so forth. We enjoy the economic and social benefits provided by AI but also face the challenges that come from AI. Because of the complex system design in AI, massive demand for data, the bottleneck of computing power, and the favor of accuracy-only, AI systems are not as reliable as expected. On the contrary, AI has induced plenty of challenges, including individual and social problems, and reduced the trust of people on it directly or indirectly. For example, many facial recognition systems suffer from higher error rates for African-Americans, women, and young people. Another example is the AI systems used in US hospitals to predict which patients would likely need extra medical care heavily favored white patients over black patients. Therefore, many organizations [2020, 2020, Commission, 2018] and researchers [Li et al., 2021a, Kaur et al., 2022] have put much effort to propose guidelines on how to build a more reliable AI system from different stages of the lifecycle. These endeavors lead to the requirement for AI systems to switch from accuracy to trustworthiness.

Drawing inspiration from the achievements of trustworthy AI, the trustworthiness of representation learning across various domains is contingent upon its alignment with the fundamental principles inherent in trustworthy AI. As a result, we are convinced of the necessity for a meticulous endeavor to translate the tenets of trustworthy AI into the realm of representation learning across diverse domains. This endeavor seeks to establish a comprehensive framework that harmonizes these principles. Figure 1 provides a visual depiction of this framework, highlighting the central components: robustness, explainability, privacy, and fairness.

1.2 Concepts in Trustworthy Representation Learning Across Domains

As the trustworthy representation learning across domains is one of the specific cases in trustworthy AI, it inherits the conventional characteristics from trustworthy AI but possesses unique properties. To better illustrate our proposed

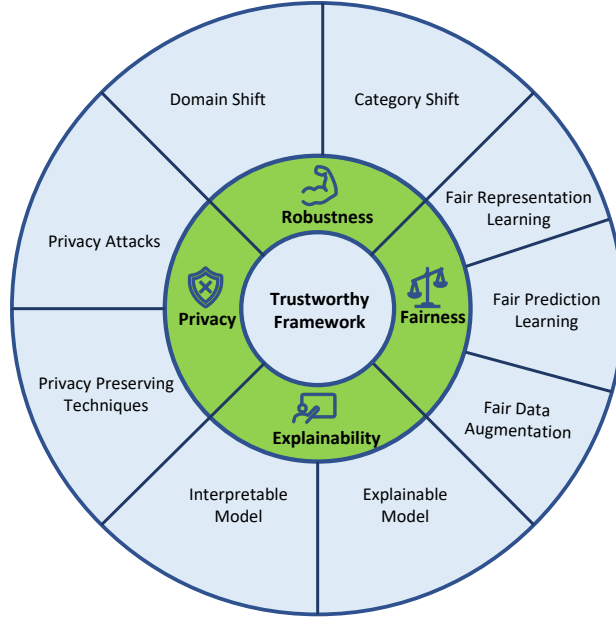

Figure 1: Illustration of our proposed trustworthy framework which including four concepts, i.e., robustness, privacy, fairness, explainability.

trustworthy representation learning across domains framework, we will give a brief review of each concept in the framework, including concept definition and research challenges. Please note that these concepts are not orthogonal but closely correlated.

1.2.1 Robustness

In the realm of trustworthy AI, robustness entails endowing AI systems with the capability to handle errors—be it data inaccuracies, attacks, or unanticipated inputs—during decision-making, thereby yielding dependable outcomes. This is a foundational concept underpinning the application of trustworthy AI in practical scenarios. The absence of robustness renders an AI system susceptible, where even minor input perturbations can lead to starkly different results. A prime example is the case of an AI system incorrectly classifying a panda image as a gibbon with high confidence due to minute, carefully designed noise [Goodfellow et al., 2014]. Within the domain of representation learning across diverse data sources, robustness assumes a distinct connotation. Here, it signifies the capacity of data representations to authentically and accurately depict the underlying distribution spanning different domains. While it’s impractical to account for all possible vulnerabilities, our focus chiefly centers on algorithms that facilitate learning data representations enabling consistent performance across domains. Therefore, they could guarantee that AI systems remain robust and keep the trustworthy representation learning intact.

1.2.2 Explainability

With the widespread adoption of powerful deep learning models like CNN [LeCun et al., 1995] and GAN [Goodfellow et al., 2020], contemporary AI systems have become integral to our daily lives, aiding us in decision-making. However, the opaque nature of these complex deep learning models and the inherent black-box property raise concerns. These concerns, voiced by both industry and academia, highlight the lack of internal explanations in many AI systems. The inability to elucidate AI system behaviors has spurred the demand for transparency. Explainability emerges as a pivotal attribute in cultivating trustworthy AI systems. In the context of representation learning across diverse domains, the end-to-end nature of black-box deep learning models often renders learned representations less interpretable. This poses challenges in providing definitive evidence to understand model predictions. Consequently, the focus shifts towards enabling data representations to be more traceable. This traceability empowers researchers to gain deeper insights into learned data representations and offer more comprehensive explanations for model behaviors. For instance, techniques such as saliency maps [Simonyan et al., 2014] can highlight discriminative evidence within images across domains, bolstering the interpretability of models [Zunino et al., 2021].

1.2.3 Privacy

The objective of privacy is to safeguard the data and model within an AI system from unauthorized exposure. Given that data can encompass sensitive details like familial ties, credit histories, and medical records, the risk of unauthorized access leading to various complications is considerable. In representation learning across domains, the emphasis is on preserving data privacy. In contrast to single-domain scenarios, the exchange of information between multiple domains heightens privacy concerns. The intricate challenge lies in ensuring the security of data when dealing with diverse domains, where the potential for data leakage becomes more pronounced.

1.2.4 Fairness

Fairness demands that AI systems exhibit equality, impartiality, and lack of bias towards individuals or groups with varying attributes when making decisions or predictions. Unfortunately, the rapid proliferation of AI systems in our daily routines has exposed instances of human-like discriminatory biases and unjust decisions. For instance, the Association for Computing Machinery (ACM) has advocated for discontinuing the use of facial recognition technologies in both private and government spheres due to glaring biases tied to human characteristics like ethnicity, race, and gender. Additionally, Microsoft’s AI-based chatbot on Twitter generated a slew of inappropriate comments, including misogynistic, racist, and anti-Semitic content, underscoring the gravity of the fairness challenge within AI deployment. Therefore, the principle of fairness is an irreplaceable role in the AI system and is vital to eliminate or alleviate the influence of biases that may cause harm to anyone related to the system. In the context of representation learning across domains, Fairness is widely applied to different domains so its definition may vary. However, it can basically be defined as the absence of any prejudice or favoritism towards an individual or a group based on their intrinsic or acquired traits in the context of decision-making [Saxena et al., 2019, Mehrabi et al., 2021]. Particularly, fairness refers to the ability to correct data bias or algorithm bias, especially in different domains. In other words, it aims to make the representations and model outputs invariant to sensitive attributes. As for more specific downstream tasks, like cross-domain face recognition, fairness have different goals, such as group fairness [Dwork et al., 2012, Hardt et al., 2016], individual fairness [Dwork et al., 2012] and counterfactual fairness [Kusner et al., 2017]. For example, fairness through unawareness can effectively address group unfairness issues even in new domains, as long as the embeddings used do not contain inherent biased information, such as gender. Additionally, the Lipschitz condition can promote individual fairness in cross-domain areas by ensuring that similar individuals are treated similarly within different domains.

1.3 Related Surveys

Representation learning constitutes the foundational challenge in machine learning, and the pervasive integration of artificial intelligence (AI) systems has harnessed the potency of machine learning to achieve notable performance levels, permeating various facets of our societal fabric. In pursuit of fostering trustworthiness, substantial efforts have been channeled, compelling us to address this very concern within representation learning. Particularly, when representation learning encounters cross-domain scenarios, its ability to generalize across varying domains often falters. This realization propelled us to introduce a comprehensive review framework for trustworthy representation learning across domains. While several related surveys exist—spanning the realm of trustworthy AI [Liu et al., 2021a, Thiebes et al., 2021, Kaur et al., 2022, Li et al., 2021a] and representation learning across domains [Zhou et al., 2022, Wang et al., 2022, Zhao et al., 2020a, Kouw and Loog, 2019, Wang and Deng, 2018]—none have ventured into the domain we’ve put forth. Distinguishing itself from these surveys, our endeavor applies universal concepts within trustworthy AI and adapts them to the nuances of representation learning across diverse domains. By bridging this gap, our survey contributes a unique perspective to the intersection of these two crucial spheres.

1.4 Contributions

Our contributions are thus summarized as:

- **An Instantiated Trustworthy Framework:** We introduce the pioneering trustworthy representation learning across domains framework, outlining its application in various representation learning scenarios across domains. Guided by the principles of trustworthy AI, this framework serves as a roadmap, organizing directions and corresponding technologies in representation learning across domains.
- **Comprehensive Review of Trustworthy Concepts:** For each concept embedded within our trustworthy framework, we offer an exhaustive review, delving into the core concepts from fundamental definitions to intricate methodologies.

Table 1: Illustration of the typical representation learning across domains scenarios. \mathcal{D}_s denotes source domain and \mathcal{D}_t indicates target domain. \mathcal{D}_t^l : few labeled target domain. In cross-domain few-shot learning scenario, $\mathcal{D}_t = \{\mathcal{D}_t^l, \mathcal{D}_t^u\}$, where \mathcal{D}_t^l is few labeled target domain which can be used in training stage and \mathcal{D}_t^u is unseen target domain used to evaluate the learned model.

Scenarios	Training Data	Test Data	Condition
Domain Adaptation [Wang and Deng, 2018]	$\mathcal{D}_s, \mathcal{D}_t$	\mathcal{D}_t	$P(X_s, Y_s) \neq P(X_t, Y_s)$
Domain Generalization [Zhou et al., 2022, Wang et al., 2022]	$\mathcal{D}_{s_1}, \dots, \mathcal{D}_{s_n}$	\mathcal{D}_t	$P(X_{s_1}, Y_{s_1}) \neq \dots \neq P(X_{s_n}, Y_{s_n}) \neq P(X_t, Y_s)$
Cross-Domain Few-Shot Learning [Guo et al., 2020]	$\mathcal{D}_s, \mathcal{D}_t^l$	\mathcal{D}_t^u	$P(X_s, Y_s) \neq P(X_t^l, Y_t^l), \mathcal{Y}_s \cap \mathcal{Y}_t^l = \emptyset$

- **Exploring Future Research Avenues:** Through a holistic survey of the diverse representation learning across domains directions encapsulated by our trustworthy framework, we identify promising avenues for future research. By illuminating these potential trajectories, we aim to stimulate further exploration and advancements in the realm of trustworthy representation learning across domains.

The remainder of this survey is organised as follows. We first introduce the background of representation learning across domains and the concepts of trustworthy in our framework in Sec. 2. Then, Sec. 3, 4, 5, 6 summarizes existing methods for trustworthy representation learning across domains from different concepts in trustworthy. We provide potential directions for our trustworthy framework in Sec. 7. Finally, We conclude the survey in Sec. 8

2 Background and Concepts

In this section, we will present the foundational background and essential concepts. The section 2.1 provides the essential notions related to trustworthy representation learning across domains. The sections 2.2 and 2.3 present problem definitions with representation learning across domains.

2.1 Notions and Definitions

We first give some notions and definitions that will be involved in this article. Let \mathcal{X} be the input data space and \mathcal{Y} be the label space. A domain can be defined as a joint distribution $P(X, Y)$ on $\mathcal{X} \times \mathcal{Y}$. For a specific domain $\mathcal{D} = \{X, Y\}$, we define the $P(X)$ as the marginal distribution on X , the $P(Y|X)$ as the conditional probability distribution of Y given X , and the $P(X|Y)$ as the class conditional distribution of X given Y . In general, we can learn the conditional probability distribution $P(Y|X)$ in a supervised way with a specified domain.

In the context of representation learning across domains, we assume to have two kinds of domains, i.e., source domain \mathcal{D}_s which is usually full labeled, and target domain \mathcal{D}_t which is usually unlabeled. Sometimes, the source domain may consist of more than one domain. In general, we hypothesize that there exists a domain shift between source and target domains, i.e., $P(X_s, Y_s) \neq P(X_t, Y_t)$. For source domain \mathcal{D}_s , it contains i.i.d. data-label pairs sampled from $P(X_s, Y_s)$, specifically, $\mathcal{D}_s = \{(x_s^i, y_s^i)\}_{i=1}^{n_s}$ with $(x_s^i, y_s^i) \sim P(X_s, Y_s)$. For target domain $\mathcal{D}_t = \{x_t^j\}_{j=1}^{n_t}$, the data are sampled from the marginal distribution $P(X_t)$ due to the label are inaccessible. In general, given the source domain \mathcal{D}_s and target domain \mathcal{D}_t , the goal of representation learning across domains is to learn a model f with \mathcal{D}_s or \mathcal{D}_s and \mathcal{D}_t such that the f can generalize well on the target domain \mathcal{D}_t .

Problems in representation learning across domains can be organized into several scenarios such as domain adaptation [Zhu et al., 2021], domain generalization [Li et al., 2018a], and cross-domain few-shot learning [Guo et al., 2020]. See Table 1 for an overview. We also consider their combinations with federated learning [Peng et al., 2020] and continual learning [Lenga et al., 2020]. Different application scenarios of representation learning across domains contain different tasks. More details of these application scenarios and related tasks are given below:

2.2 Domain Adaptation

2.2.1 Existing Domain Adaptation Tasks

Domain Adaptation (DA) is the topic that has been broadly researched over the articles [Gong et al., 2012, Ganin and Lempitsky, 2015, Saito et al., 2018a, Li et al., 2021b]. In general, given two domains, i.e., source domain \mathcal{D}_s which is full labeled and target domain \mathcal{D}_t which is unlabeled or partially labeled. The goal is to develop a model that effectively harnesses data from both the source and target domains to achieve accurate classification of data in the target domain. The key hurdle in domain adaptation arises from the fact that data in these two domains are drawn from dissimilar distributions, compounded by the absence of label information from the target domain. This challenge necessitates

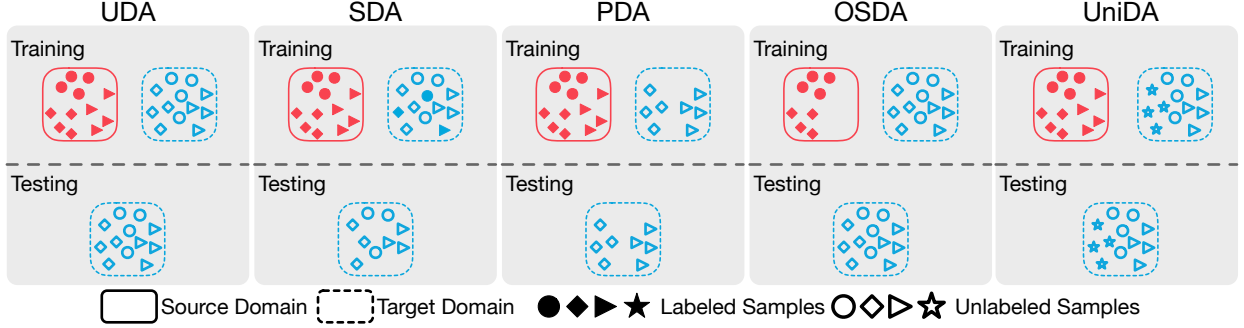

Figure 2: Illustration of label space of unsupervised domain adaptation (UDA), Semi-supervised Domain Adaptation (SDA), Partial Domain Adaptation (PDA), Open-Set Domain Adaptation (OSDA), and Universal Domain Adaptation (UniDA). Different colors represent different domains.

Table 2: Illustration of the existing domain adaptation (DA) tasks. **UDA** means Unsupervised Domain Adaptation. **SDA** means Semi-supervised Domain Adaptation. **PDA** means Partial Domain Adaptation. **OSDA** means Open-Set Domain Adaptation. **UniDA** means Universal Domain Adaptation. Y_s denotes source label space and Y_t indicates target label space. X_s and X_t represent the source and target data.

Tasks	Label Set				Data Set		
	$Y_s = Y_t$	$Y_t \in Y_s$	$Y_s \in Y_t$	$Y_s \cap Y_t \neq \emptyset$	X_s full labeled	X_t full unlabeled	X_t few labeled
UDA [Zhu et al., 2021]	✓	×	×	✓	✓	✓	×
SDA [Li et al., 2021b]	✓	×	×	✓	✓	×	✓
PDA [Cao et al., 2018a]	×	✓	×	✓	✓	✓	×
OSDA [Panareda Busto and Gall, 2017]	×	×	✓	✓	✓	✓	×
UniDA [You et al., 2019]	×	×	×	✓	✓	✓	×

innovative strategies to bridge this distribution gap and enable effective classification in the target domain. Learning the data presentations to alleviate the domain shift between two domains and adapting source knowledge to target domain is the major direction to solve the domain adaptation problem. Early, the main goal of the DA is to deal with the domain shift problem where $P(X_s, Y_s) \neq P(X_t, Y_t)$. Recently, DA [Cao et al., 2018a, Panareda Busto and Gall, 2017, Jing et al., 2021, You et al., 2019, Li et al., 2021c] considers a more practical application situation that aims to address both domain shift problem and label shift problem which means that the label spaces of source and target domains are not exactly same ($\mathcal{Y}_s \neq \mathcal{Y}_t$). Many existing domain adaptation (DA) methods fall under the umbrella of Unsupervised Domain Adaptation (UDA) Gong et al. [2012], Ganin and Lempitsky [2015], Saito et al. [2018a], Chen et al. [2022a], Du et al. [2021], Lee et al. [2019], Sun and Saenko [2016], Long et al. [2018]. These methods operate under the assumption that the label spaces of both domains are identical, aiming to mitigate the challenges posed by domain shift. On the other hand, Partial Domain Adaptation (PDA) Li et al. [2021b], Cao et al. [2018a], Xiao et al. [2021], Gu et al. [2021], Liang et al. [2020], Cao et al. [2018b] relaxes this assumption by considering scenarios where the source domain's label space encompasses the target domain's label space. Open-Set Domain Adaptation (OSDA) Panareda Busto and Gall [2017], Jing et al. [2021], Bucci et al. [2020], Luo et al. [2020], Pan et al. [2020], Baktashmotlagh et al. [2019] addresses a more realistic application context where the label space of the target domain includes the label space of the source domain. In alignment with real-world needs, Universal Domain Adaptation (UniDA) You et al. [2019], Fu et al. [2020], Li et al. [2021c], Saito and Saenko [2021], Chen et al. [2022b], ?, Zhu and Li [2021] relaxes label space constraints, accommodating private classes unique to each domain and shared common classes between them. These diverse methodologies cater to varying levels of label space alignment, catering to a wide spectrum of DA scenarios. Figure 2 illustrates the relationship between source and target label spaces in different DA tasks. We also summarize the difference among different tasks in Table 2

2.2.2 Existing Domain Adaptation Methods

The ultimate goal lies in domain adaptation is to reduce the domain shift between source and target domains. To address this, Ben-David [Ben-David et al., 2006] proposed the bound for target risk $\epsilon^t(h)$ by using the available source risk $\epsilon^s(h)$ as follows:

$$\epsilon^t(h) \leq \epsilon^s(h) + d_{\mathcal{H}\Delta\mathcal{H}}(P(X_s), P(X_t)) + \lambda_{\mathcal{H}}, \quad (1)$$

where $\epsilon(h)^{s/t} := \epsilon(h, h^{*s/t}) = \mathbf{E}_{x_{s/t} \sim P(X_{s/t})} [h(x_{s/t}) \neq h^*(x_{s/t})]$, the h can be any classifier from a hypothesis space \mathcal{H} and the $h^{*s/t}$ is the true classifier on the $P(X_{s/t})$. The $\mathcal{H}\Delta\mathcal{H}$ -divergence is defined as:

$$d_{\mathcal{H}\Delta\mathcal{H}}(P(X_s), P(X_t)) := \sup_{h, h' \in \mathcal{H}} |\epsilon^s(h, h') - \epsilon^t(h, h')|, \quad (2)$$

and the $\lambda_{\mathcal{H}}$ denotes the difference in classifier across two domain and is written as:

$$\lambda_{\mathcal{H}} := \inf_{h \in \mathcal{H}} |\epsilon^s(h) + \epsilon^t(h)|. \quad (3)$$

Inspired by this theoretical analysis, the existing DA methods mainly explore the direction of learning domain-invariant feature representations. In general, these methods can be roughly organized into two groups: the moment matching based methods [Long et al., 2015, Tzeng et al., 2014, Zhang et al., 2019, Long et al., 2017], adversarial learning based methods [Saito et al., 2018a, Ganin and Lempitsky, 2015, Long et al., 2018, Ma et al., 2019, Tzeng et al., 2017, Cui et al., 2020].

Moment matching based methods explicitly measure the discrepancy between the source and target domains on the learned data representations and match the discrepancy with well-defined moment-based distribution measurements [Zhang, 2021]. The Maximum Mean Discrepancy (MMD) is one of the most typical measurements defined as:

$$MMD(X_s, X_t) = \left\| \frac{1}{n_s} \sum_{i=1}^{n_s} \phi(x_s^i) - \frac{1}{n_t} \sum_{j=1}^{n_t} \phi(x_t^j) \right\|_{\mathcal{H}}, \quad (4)$$

where n_s and n_t are the number of data in the source and target domains, $\phi(\cdot)$ is the kernel-induced feature map that projects from the Reproducing Kernel Hilbert Space (RKHS), and $\|\cdot\|_{\mathcal{H}}$ is the RKHS norm. Early, Long et al. [Long et al., 2015] proposed the Deep Adaptation Network (DAN) by designing the multiple kernel variant of maximum mean discrepancies (MK-MMD) [Gretton et al., 2012] layers to project the hidden representations into an RKHS and match the mean embeddings of source and target domains. The authors of Residual Transfer Networks (RTN) [Long et al., 2016] further extended the DAN with a residual layer and relaxed the restriction on the classifier. Yan et al. [Yan et al., 2017] designed the Weighted Maximum Mean Discrepancy (WMMD) to address the class weight bias across domains problem by providing the class-specific auxiliary weights strategy to alleviate the drawback of MMD on class weight bias. Long et al. [Long et al., 2017] considered to align source and target representations by optimizing the joint distributions of multiple domain-specific layers on a joint maximum mean discrepancy (JMMD) measurement with an adversarial training way.

Correlation Alignment (CORAL) is another measurement to align the second-order statistics (covariance) of source and target domains, which is defined as:

$$CORAL(X_s, X_t) = \frac{1}{4d^2} \|C_s - C_t\|_F^2, \quad (5)$$

where d indicates the feature dimensionality, $\|\cdot\|_F^2$ represents the squared matrix Frobenius norm, C_s and C_t denotes the feature covariance matrices of X_s and X_t , respectively. The authors of Deep Correlation Alignment (Deep CORAL) [Sun and Saenko, 2016] revised the CORAL to nonlinear transformation by incorporating it to the last layer of the deep neural network and designing the corresponding differentiable loss function. Zhuo et al. [Zhuo et al., 2017] proposed the Deep Unsupervised Convolutional domain Adaptation (DUCDA), which extended the CORAL not only to fully connected layers in deep neural network but also to convolutional layers, and further improve the generalization of learned representations. Furthermore, Morerio et al. [Morerio et al., 2018] jointly combined the correlation alignment and entropy minimization into a unified framework, i.e., Minimal-Entropy Correlation Alignment (MECA), with geodesic distances to align source and target domains in the learned representations. Chen et al. [Chen et al., 2019a] presented the Joint Discriminative Domain Alignment (JDDA) framework, which consists of CORAL loss, instance-based discriminative loss, and center-based based discriminative loss, to learn the discriminative feature representations across domains.

Beside the measurements of MMD and CORAL, there are many other measurements include but not limited to: (1) Zellinger et al. [Zellinger et al., 2017] proposed a new measurement, i.e., Central Moment Discrepancy (CMD), to match the high order central moments of probability distributions tried to match the higher-order moments by means of order-wise moment differences; (2) Chen et al. [Chen et al., 2020] investigated the higher order statistics, e.g., third and fourth order statistics, for domain alignment by designing the Higher-order Moment Matching (HoMM) framework and further extending the HoMM into RKHS; (3) Shen et al. [Shen et al., 2018] designed the Wasserstein Distance Guided Representation Learning (WDGRL) framework to learning domain-invariant feature representations by minimizing the the estimated Wasserstein distance between source and target domains in an adversarial manner;

(4) Jiang et al. [Jiang et al., 2020a] presented the Resource Efficient Domain Adaptation (REDA) framework, which distills the transfer knowledge across source and target domains from the top layers to shallower layers in deep neural network by minimizing the Jensen-Shannon Divergence (JSD) [Fuglede and Topsoe, 2004] between the probability distributions of student and teacher models. (5) Li et al. [Li et al., 2018b] induced the Adaptive Batch Normalization (AdaBN) model to replace the statistics, e.g., moving average mean and variance, of Batch Normalization (BN) layers trained via source domain to these estimated from the target domain.

Adversarial learning based methods are inspired by the generative adversarial networks (GAN) [Goodfellow et al., 2020], which aim to reduce the domain shift across different domains via an adversarial manner. This mechanism has been proved to be the most influential mechanism over others in domain adaptation. Mathematically, the adversarial learning in domain adaptation can be formulated as a minimax optimization problem with two competitive loss objectives: (a) $\epsilon(C)$ on classifier C , which is optimized by minimizing the classification error on the source domain; (b) $\epsilon(D, G)$ on domain discriminator D and feature extractor G over source and target domains, which is minimized on D but maximized over G :

$$\epsilon(C) = \mathbb{E}_{(x_s^i, y_s^i) \sim \mathcal{D}_s} \mathcal{L}_{ce}(C(G(x_s^i), y_s^i)), \quad (6)$$

$$\epsilon(D, G) = -\mathbb{E}_{x_s^i \sim \mathcal{D}_s} \log[D(G(x_s^i))] - \mathbb{E}_{x_t^j \sim \mathcal{D}_t} \log[1 - D(G(x_t^j))], \quad (7)$$

where \mathcal{L}_{ce} is the cross-entropy loss. The general formulation of minimax game in adversarial learning is defined as:

$$\begin{aligned} & \min_{C, G} \epsilon(C) - \lambda \epsilon(D, G) \\ & \min_D \epsilon(D, G), \end{aligned} \quad (8)$$

where λ is the hyper-parameter to balance source risk and domain adversary. One of the earliest adversarial learning based domain adaptation is Domain Adversarial Neural Network (DANN) [Ganin et al., 2016], which incorporated a minimax game framework into a single feed-forward network with a gradient reversal layer. While the other earliest method, i.e., Adversarial Discriminative Domain Adaptation (ADDA) [Tzeng et al., 2017], adopted an inverted label GAN loss to divide the optimization process into two independent steps for feature extractor and domain discriminator. Instead of only considering how to align the marginal distribution over source and target domains, Long et al. [Long et al., 2018] jointly aligned the marginal distribution and conditional distribution with the proposed Conditional Domain Adversarial Networks (CDAN), which includes a conditional discriminator with the concatenate input from feature representation and the corresponding classifier predictions. Zhang et al. [Zhang et al., 2019] provided a new adversarial domain adaptation margin theory based on the hypothesis-induced discrepancy, and designed a novel measurement, i.e., Margin Disparity Discrepancy (MDD), to facilitate the minimax optimization with rigorous generalization bounds. Xu et al. [Xu et al., 2020] addressed two problems in adversarial domain adaptation, i.e., insufficient data from two domains to ensure domain-invariance over the whole representation space and hard label for the discriminator to judge real and fake data, and induced the adversarial Domain Adaptation with Domain Mixup (DM-ADA) framework, which includes a mixup version discriminator to guarantee domain-invariance in a more continuous latent space and result in a robustness model across domains. Wei et al. [Wei et al., 2021] alleviated the adverse effort of adversarial domain alignment induced by ignoring how to make the alignment proactively serve the classification task by proposing the Task-oriented Alignment (ToAlign) to decompose the source feature and guide the alignment between source and target features with the prior knowledge from the classification task. Chen et al. [Chen et al., 2022a] tackled the mode collapse problem caused by failing to make full use of predicted discriminative information and design a Discriminator-free Adversarial Learning Network (DALN) which reuses the classifier to replace the discriminator and realizes domain alignment with discriminative feature presentations.

2.3 Domain Generalization

2.3.1 Existing Domain Generalization Tasks

Domain Generalization (DG) addresses a scenario where the target domain is not accessible during model training. In this setup, multiple fully labeled source domains $\mathcal{D}_{s_1}, \dots, \mathcal{D}_{s_{n_s}}$ are typically available. The key challenge in domain generalization revolves around devising a model that effectively generalizes to an unseen target domain \mathcal{D}_t based on information from diverse source domains. DG is introduced as a solution to both the domain shift problem and the absence of target domain data during model training. Its significance has garnered significant interest from both academia and industry, owing to its potential for real-world applications [Zhou et al., 2022, Wang et al., 2022]. The initial focus of Domain Generalization (DG) was on scenarios involving multiple source domains, each stemming from a distinct distribution. The core objective of DG entails training a model using these diverse source domains, with the aim of enabling it to generalize effectively to an unseen target domain. This specific DG variant is referred to as Multi-Source Domain Generalization (MSDG) [Li et al., 2018a, Ahuja et al., 2021, Zhou et al., 2021a, Gulrajani and Lopez-Paz, 2020, Zhao et al., 2020b, Dou et al., 2019, Shankar et al., 2018, Muandet et al., 2013, Zhou et al., 2020a].

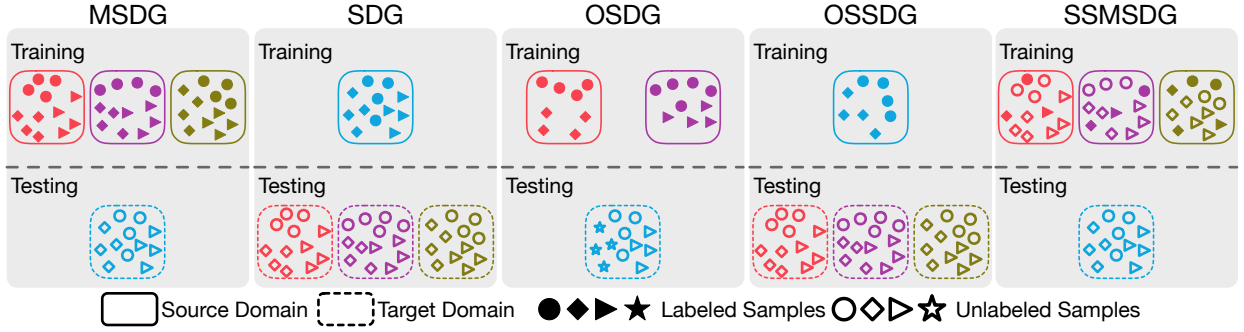

Figure 3: Illustration of label space of Multi-Source Domain Generalization (MSDG), Single Domain Generalization (SDG), Open-Set Domain Generalization (OSDG), Open-Set Single Domain Generalization (OSSDG), and Semi-Supervised Multi-Source Domain Generalization (SSMSDG). Different colors represent different domains. As there is no prior knowledge about the target domains, existing MSDG and SDG methods cannot handle unknown classes in target domain.

Table 3: Illustration of the existing domain generalization (DA) tasks. **MSDG** means Multi-Source Domain Generalization. **SDG** means Single Domain Generalization. **OSDG** Open-Set Domain Generalization **OSSDG** means Open-Set Single Domain Generalization. **SSMSDG** means Semi-Supervised Multi-Source Domain Generalization. Y_s denotes source label space and Y_t indicates target label space. X_s and X_t represent the source and target data.

Tasks	Label Set				Data Set	
	$Y_s = Y_t$	$Y_t \in Y_s$	$Y_s \in Y_t$	$Y_s \cap Y_t \neq \emptyset$	X_s full labeled	X_s few labeled
MSDG [Zhu et al., 2021]	✓	×	×	✓	✓	×
SDG [Li et al., 2021b]	✓	×	×	✓	✓	×
OSDG [Cao et al., 2018a]	×	×	×	✓	✓	×
OSSDG [Panareda Busto and Gall, 2017]	×	×	✓	✓	✓	×
SSMSDG [You et al., 2019]	✓	×	×	✓	×	✓

In MSDG, the central challenge revolves around training a model that can harness the information from multiple source domains to perform effectively on a target domain that has not been seen during training. Recently, a more challenging and realistic problem, i.e., Single Domain Generalization (SDG) [Qiao et al., 2020, Wang et al., 2021a, Fan et al., 2021, Li et al., 2021d, Wan et al., 2022, Ilke et al., 2022], is proposed for DG where only one source domain is accessible for model training. Meanwhile, some researchers further consider more challenging tasks that the label space of source and target domains are not consistent in MSDG and SDG, i.e., Open-Set Domain Generalization (OSDG) [Shu et al., 2021] and Open-Set Single Domain Generalization (OSSDG) [Zhu and Li, 2022]. In addition to this, the Semi-Supervised Multi-Source Domain Generalization (SSMSDG) [Zhou et al., 2021b] is proposed to address the task where the data in multi-source domain is few labeled. Figure 3 illustrates the relationship between source and target label spaces in different DG tasks. We also summarize the difference among different tasks in Table 3

2.3.2 Existing Domain Generalization Methods.

The primary objective of domain generalization is to train a model using either a single or multiple distinct but interconnected source domains in a way that it demonstrates strong generalization performance on an unseen target domain. The absence of target domain data during model training complicates the estimation of domain shift. In light of this challenge, DG centers on acquiring domain-invariant representations that preserve discriminative qualities on target data. Existing DG methods can be broadly categorized into several groups, including but not limited to: feature alignment-based approaches, meta-learning-based techniques, and data augmentation-based strategies. These methodologies collectively address the task of enabling models to generalize effectively across domains, contributing to the broader landscape of domain generalization research.

Feature alignment based methods aim to align features between different source domains, and hope the learned representations can be invariant to unseen target domain. Along this direction, there are a plethora of methods that adopt different domain alignment strategies such as adversarial learning based and moment matching based, to reduce the domain shift among different source domains. This direction shares the similar motivation to domain adaptation, in some degree, the domain alignment strategies applied in domain adaptation can be used to domain generalization. For example, Li et al. [Li et al., 2018a] utilized the Maximum Mean Discrepancy (MMD) to minimize the domain shift

between source domains, and align the feature distribution to a prior distribution in an adversarial learning manner. Li et al. [Li et al., 2018c] designed Conditional Invariant Deep Domain Generalization (CIDDG) framework to learn domain-invariant representations via a conditional invariant adversarial network. Zhao et al. [Zhao et al., 2020b] jointly minimized the KL divergence between the conditional distribution of multiple source domains and applied adversarial learning to match the feature distributions in multiple source domains. Matsuura et al. [Matsuura and Harada, 2020] considered a practical application scenario where domain label information is unavailable, and proposed a framework that can jointly cluster source data into different latent domains and align them under the adversarial learning way. See [Zhou et al., 2022, Wang et al., 2022] for comprehensive surveys on domain generalization)

Meta-learning based methods have drawn increasing attention from the domain generalization community in recent years. The meta-learning is commonly known as learning-to-learn, which attempts to benefit the learning algorithm itself via multiple learning episodes by dividing multiple source data into meta-train \mathcal{D}_{train} and meta-test \mathcal{D}_{test} parts to simulate domain shift. Here we loosely define the model parameters as θ , the overall meta-learning framework can be written as:

$$\begin{aligned}\hat{\theta} &= \theta^* - \alpha \nabla_{\theta^*} \mathcal{L}_{outer}(\mathcal{D}_{test}; \theta^*) \\ \theta^* &= \theta - \beta \nabla_{\theta} \mathcal{L}_{inner}(\mathcal{D}_{train}; \theta),\end{aligned}\quad (9)$$

where α and β are hyper-parameters, $\mathcal{L}_{inner}(\cdot)$ and $\mathcal{L}_{outer}(\cdot)$ are designed different meta-learning algorithms. The $\mathcal{L}_{outer}(\cdot)$ aims to simulate domain shift and back-propagate the gradients all the way back to the original parameters such that model learned by \mathcal{L}_{inner} can be improved. This learning process is a bi-level optimization and can be formulated as:

$$\hat{\theta} = \theta - \alpha \frac{\partial (\beta \mathcal{L}_{inner}(\mathcal{D}_{train}; \theta) + \mathcal{L}_{outer}(\mathcal{D}_{test}; \theta^*))}{\partial \theta}.\quad (10)$$

One of the most popular meta-learning frameworks is proposed by Finn [Finn et al., 2017], i.e., Model-Agnostic Meta-Learning (MAML), which separates data into meta-train and meta-test sets, and optimizes the model under meta-train and meta-test tasks to improve the generalization of the learned model. Inspired by this, Li et al. [Li et al., 2018d] are the first to apply MAML to domain generalization problems. They proposed the framework, i.e., Meta-Learning for Domain Generalization (MLDG), which divides multiple source domains into uncorrelated meta-train and meta-test to mimic the domain shift. The optimization goal is to learn a model with meta-train data that can get low error on meta-test data. In this manner, the learned model can generalize to unseen target domains. Balaji et al. [Balaji et al., 2018] proposed a regularization based meta learning method (MetaReg) for the classifier, which is different from MLDG meta-learned the entire model. Dou et al. [Dou et al., 2019] combine two complementary losses which aim to regularize the semantic structure of the feature space, with MAML framework in such a way that the learned representations would keep semantic information across domains and generalize to unseen target domain. Du et al. [Du et al., 2020a] designed Meta Variational Information Bottleneck (MetaVIB) to jointly learn domain-invariant representation and improve the model performance by applying KL Divergence regularization between distributions of latent coding of the samples with the same category but from different domains. Du et al. [Du et al., 2020b] designed an extended version of batch normalization named MetaNorm. They utilize the meta-learning framework to learn adaptive statistics for batch normalization which can improve the reliability and generalizability of learned representations.

Data augmentation based methods usually combine the above-mentioned DG methods such as feature alignment based and meta-learning based, to investigate the benefit brought by data augmentation [Shorten and Khoshgoftaar, 2019]. The ultimate goal of data augmentation is to avoid overfitting problem and improve the generalizability of the learned model by generating plenty of diverse data to enrich the original data. Specifically, given the original data x , the data augmentation provides the transformation function $Aug(\cdot)$ to generate new data $Aug(x)$ where x and $Aug(x)$ share same semantic information. Early data augmentation techniques focus on basic image manipulations such as: random flip, color space change or transformation, random crop, random rotation, noise injection, kernel filter, random erase, and so on. They can design different $Aug(\cdot)$ by including single or multiple image manipulations. But these $Aug(\cdot)$ are only suitable for certain scenarios. For example, rotation and flip are not applicable for digit classification problems such as "6" and "9" images are easily confused after augmentation. Later, inspired by adversarial attacks [Chakraborty et al., 2018], adversarial data augmentation [Volpi et al., 2018, Zhao et al., 2020c, Li et al., 2021d] is proposed, which generates new data by adding sign-flipped gradients back-propagated from classifier to original data. The augmentation process is an iterative way:

$$x_{t+1} \leftarrow x_t + \eta \nabla_{x_t} \mathcal{L}(\theta; x_t),\quad (11)$$

a small number of iterations are needed to produce sufficient perturbations. θ denotes the parameters in model, and the $\mathcal{L}(\theta; x_t)$ is defined as:

$$\mathcal{L}(\theta; x) = \underbrace{\mathcal{L}_{task}(\theta; x)}_{\text{Task}} - \alpha \underbrace{\mathcal{L}_{res}(\theta; f)}_{\text{Restrict}},\quad (12)$$

where \mathcal{L}_{task} is the task loss defined to optimize the model, α is the hyperparameter, f is the feature of original data x extracted by model. The second item in Eq. 12 is noted as $\mathcal{L}_{res}(\theta; f) = \|f - f^*\|_2^2$ where f^* is the feature of

Table 4: Commonly used benchmark datasets for domain adaption and domain generalization.

Dataset	Domain	Class	Sample	Description
Office-Caltech Qiao and Peng [2021]	4	10	2,533	Caltech, Amazon, Webcam, DSLR
Office-31 Qiao and Peng [2021]	3	31	4,110	Amazon, Webcam, DSLR
PACS Quinonero-Candela et al. [2008]	4	7	9,991	Art, Cartoon, Photos, Sketches
VLCS Kim et al. [2021a]	4	5	10,729	Caltech101, LabelMe, SUN09, VOC2007
Office-Home Huang et al. [2020]	4	65	15,588	Art, Clipart, Product, Real
Terra IncognitaShi et al. [2021]	4	10	24,788	Wild animal images at locations L100, L38, L43, L46
Rotated MNIST Wang et al. [2021a]	6	10	70,000	Digits rotated from 0° to 90° with an interval of 15°
DomainNet Rame et al. [2022]	6	345	586,575	Infograph, Clipart, Painting, Quickdraw, Sketch, Real

augmented data x^* which is generated via Eq. 11 with original data x as input. This augmentation process can enrich the diversity of the original data while keeping the semantic information. However, these adversarial data augmentation methods fail to simulate the real-world domain shift because the augmented data are visually similar to the original data, e.g., share the same image style. Meanwhile, another direction of data augmentation is proposed [Yue et al., 2019, Zhou et al., 2020b,a, Yang et al., 2021], which considers to enrich the diversity of source domains by synthesizes new domains out-of-source distribution. For example, Zhou et al. [Zhou et al., 2020b] proposed the Deep Domain-Adversarial Image Generalization (DDAIG) to map the source domains to unseen domains by learning a transformation network in an adversarial manner. Yang et al. [Yang et al., 2021] design the Adversarial Teacher-Student Representation Learning (ATSRL) to alternatively learn generalizable representations and generate novel-domain data. Recently, feature-level augmentation has been a fast growing area, motivated by mixup [Zhang et al., 2018a] which linearly interpolates any two data and their labels, respectively, to generate new data, Shu et al. [Shu et al., 2021] propose Domain-Augmented Meta-Learning framework to learn generalizable representation by enrich source domains on feature-level via a new designed Dirichlet mixup and label-level though KL divergence. Meanwhile, Zhou et al. [Zhou et al., 2021a] mix the feature statistics, i.e., mean and standard deviation, of two instances with random ratio to implicitly synthesize new domains.

2.4 Others

Cross-Domain Few-Shot Learning. Very recently, many efforts [Chen et al., 2019b, Guo et al., 2020] have proven that most of existing few-shot learning [Wang et al., 2020a, Song et al., 2022] methods fail to exhibit generalization capacity when there is a big domain shift between the source and target domains. To investigate this challenge, Cross-Domain Few-Shot Learning (CDFSL) [Tseng et al., 2020, Guo et al., 2020] has been proposed. In CDFSL, there are two typical stages involved: 1) meta-learning stage, which utilizes existing source domain \mathcal{D}_s consists of plenty of base category classes to learn a model; 2) meta-testing stage, which adapts the learned model with few-labeled target domain \mathcal{D}_t^l contains a set of novel classes, and hope this adapted model can generalize well to target domain. There is no overlap between the base category classes and the novel classes, i.e., $\mathcal{Y}_f \cap Y_t = \emptyset$, the size of few-labeled target domain is much less than the size of the source domain, and the source and target domains have significant domain shift, e.g., source domain data come from natural images while target domain data come from medical images.

Federated Learning. Federated learning McMahan et al. [2017], Zhang et al. [2021a] aims to maintain a powerful global model via communications with distributed clients without access to their local data. A typical challenge in federated learning is the non-IID data distribution, where the data distributions learnt by different clients are different. Formally, A typical Federated Learning paradigm can be formalized as follows: Assume we have a set $\mathcal{C} = \{\mathcal{C}_1, \mathcal{C}_2, \dots, \mathcal{C}_n\}$ of n different clients, where each client \mathcal{C}_k has its private data \mathcal{D}_k with the corresponding task \mathcal{T}_k , and a global model parameterized by θ_g deployed on a centralized server, which communicates with the clients during their training on their own local data. FL learns a global model that minimizes its risk on each of the client tasks:

$$\min_{\theta_g} \mathbb{E}_{\mathcal{T}_k \in \mathcal{T}} [\mathcal{L}_k(\theta_g)], \quad (13)$$

where \mathcal{L}_k is the objective of \mathcal{T}_k .

2.5 Datasets

In this section, we summarize several commonly used benchmark datasets in domain adaptation and domain generalization. In table. 4, we first provide an overview of some widely used detests of the image classification task, including Office-Caltech Qiao and Peng [2021], Office-31 Qiao and Peng [2021], PACS Quinonero-Candela et al. [2008], VLCS Kim et al. [2021a], Office-Home Huang et al. [2020], Terra IncognitaShi et al. [2021], Rotated MNIST Wang et al.

[2021a], DomainNet Rame et al. [2022]. Each dataset consists of images from n domains and data from different domains share the same label space.

3 Robustness in Representation Learning Across Domains

The robustness is the fundamental element in the trustworthy AI framework. In general, it refers to capability of the AI system that remains high performance under different scenarios. It’s vital for AI system to establish well reputation of trustworthiness in people and society in real-world application. Ignoring the importance of robustness in AI system will raise massive problems when these systems are deployed to tasks related to safety [Häuslschmid et al., 2017], ethnicity [Ross, 2010], healthy [Finlayson et al., 2019], and so forth. As the results, the earned well reputation will be gradually eroded. In the field of representation learning across domains, the term robustness is to describe the capability of learned representations that lead to a robust model under different circumstances. For example, a self-driving model learned by using urban data should perform well under rural circumstance. A face recognition model trained using asian face data should accurately recognize non-asian face.

In this section, we present a comprehensive review of robustness with domain adaptation, domain generalization, and others, from different aspects such as pseudo-labeling, self-supervision, open-set, and so on. Instead of providing an exhaustive review on every direction, we aim to introduce the mainly focusing lines of the researches and try to lay out how robustness problem in trustworthy representation learning across domains is addressed in recent years. We also demonstrate some potential direction in robustness for future research.

3.1 Domain Adaptation

Even though typical domain adaptation (DA) methods have obtained significant achievement in many applications, they still need to improve their robustness in real-world application scenarios. In this section, we mainly focus on three branches to improve the robustness of DA: pseudo-labeling [Saito et al., 2017, Xie et al., 2018, Zhang et al., 2018b, Deng et al., 2019, Chen et al., 2019c, Jiang et al., 2020b, Liu et al., 2021b], self-supervision Sun et al. [2019], Park et al. [2020], Saito et al. [2020], Zhu and Li [2021], Kim et al. [2021b], and open-set [Saito et al., 2018b, Feng et al., 2019, Liu et al., 2019, Bucci et al., 2020, You et al., 2019, Fu et al., 2020, Saito et al., 2020, Zhu and Li, 2021, Li et al., 2021c, Saito and Saenko, 2021, Chen et al., 2022b]. Most of these methods combine with the typical DA methods, i.e., moment matching based and adversarial learning based, to jointly explore their advantage for robust domain adaptation. Recently, pseudo-labeling has been successfully applied to DA and gains promising performance on many DA tasks. The main challenge for pseudo-labeling base methods is how to fully take advantage of pseudo-labeled target data to benefit the domain alignment instead of misleading domain alignment. Meanwhile, in more real-world situations where the labels in the target domain aren’t exactly the same as those in the source domains, researchers have come up with open-set related domain adaptation problems. These are designed to make existing adaptation methods stronger and more adaptable, considering differences in label spaces between different domains. This helps these methods work more robust in practical scenarios. The main goal is to accurately classify target data from the common label space shared with source label space while identify target data from the private label space different from source label space. Very recently, self-supervised learning has shown significant improvement on representation learning by fabricating pretext tasks to excavate supervisory signals from data itself instead of category information. Several endeavors have utilized self-supervised learning to DA problems and achieved significantly performance.

3.1.1 Robust Domain Adaptation with Pseudo-Labeling

Pseudo-labeling in DA operates under the idea that certain target data can be given pseudo-labels and used for training. Saito and colleagues introduced an approach [Saito et al., 2017] involving two networks to create pseudo-labels for target data. Then, a third network is trained using these pseudo-labeled target data to develop representations that are specifically geared towards the target domain. Xie et al. [Xie et al., 2018] designed the Moving Semantic Transfer Network (MSTN) to realize class-level feature alignment between source and target distribution by assigning pseudo-labels to target data. See Figure 4 for an overview. Specifically, the MSTN jointly eliminates the domain shift between source and target domains via adversarial learning manner and align the centroids of source and target via semantic transfer objective. This objective is defined as:

$$\mathcal{L}_{SM}(X_s, Y_s, X_t) = \sum_{k=1}^K \phi(C_s^k, C_t^k), \quad (14)$$

where K is the number of classes, $\phi(\cdot, \cdot)$, C_s^k and C_t^k denote the centroid of source and target for k -th category, respectively. The target centroids are estimated by pseudo-labeled target data. To avoid the error accumulation problem

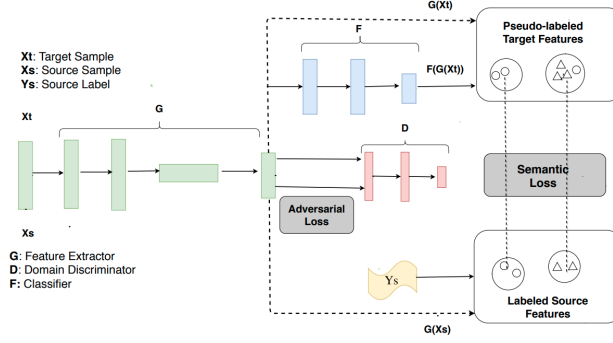

Figure 4: The framework of Moving Semantic Transfer Networks (MSTN). (Image from [Xie et al., 2018])

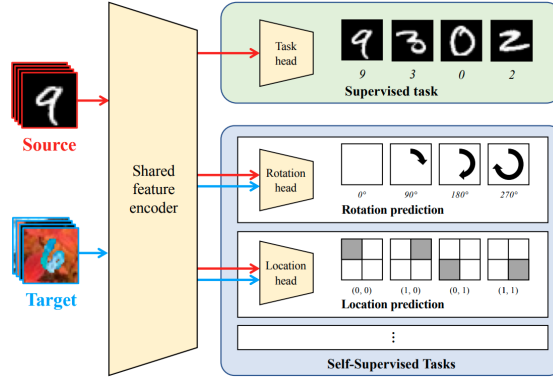

Figure 5: The self-supervised learning based framework for unsupervised domain adaptation. (Image from [Sun et al., 2019])

and insufficient categorical information in each batch, they adopted exponential moving average strategy to estimate centroids for source and target domains, which is formulated as:

$$\begin{aligned} C_s^k &\leftarrow \gamma C_s^k + (1 - \gamma) C_{s(batch)}^k \\ C_t^k &\leftarrow \gamma C_t^k + (1 - \gamma) C_{t(batch)}^k, \end{aligned} \quad (15)$$

where γ is the hyperparameter controls the contribution of each batch to estimate centroids. $C_{s/t(batch)}^k$ is the mean value of data in source/target batch that belong to k -th class. Later, how to safely assign pseudo-label to target data and select pseudo-labeled target data has been explored by many works. For example, Zhang et al. [Zhang et al., 2018b] designed the Incremental Collaborative and Adversarial Network (iCAN) to iteratively sample a subset of pseudo-labeled target data with a classification or discriminator confidence scores based criterion to retrain the model. Den et al. [Deng et al., 2019] proposed Cluster Alignment with a Teacher (CAT) to investigate the class-wise alignment between source and target distribution by reliably assigning pseudo-labels to target data with a teacher classifier. To further alleviate the error accumulation induced by unreliable pseudo-labels on target data, Chen et al. [Chen et al., 2019c] presented the Progressive Feature Alignment Network (PFAN) [Chen et al., 2019c]. This approach involves a step-by-step process to choose trustworthy pseudo-labeled target data using cross-domain similarity measurements. It also dynamically adjusts the alignment of source and target class centers to enhance the alignment between different domains. Jiang et al. [Jiang et al., 2020b] addressed the error accumulation problem from sample selection aspect. Specifically, they presented a sampling based implicit method, which utilizes pseudo-labels implicitly to guide data sampling and align the joint distribution between features and labels. Liu et al. [Liu et al., 2021b] provided a cycle self-training (CST) based method, which improves the reliability of target pseudo-labels by inducing the Tsalli entropy regularization, and promotes the generalizability of pseudo-labels across domains.

3.1.2 Robust Domain Adaptation with Self-Supervision

self-supervision in DA shares the spirit of the self-supervised learning [Jing and Tian, 2020], and incorporates the self-supervised learning pretext tasks, e.g., image rotation [Gidaris et al., 2018], patch location prediction [Noroozi and

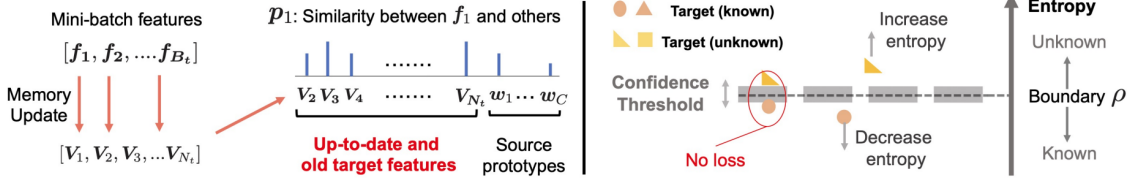

Figure 6: The illustration of Domain Adaptive Neighborhood Clustering via Entropy Optimization (DANCE). **Left:** Similarity distribution calculation in neighborhood clustering. **Right:** An overview of the entropy separation loss. (Image from [Saito et al., 2020])

Favaro, 2016], and instance discrimination [Wu et al., 2018] (used for contrastive learning), into existing DA methods to improve their robustness. Early, Sun et al. [Sun et al., 2019] added auxiliary self-supervised tasks such as rotation prediction, flip prediction, and patch location prediction, for source and target domains. See Figure 5 for details. In this framework, the over objective is written as:

$$\min_{\theta, h_k, k=0 \dots K} \mathcal{L}_0(X_s; \theta, h_0) + \sum_{k=1}^K \mathcal{L}_k(X_s, X_t; \theta, h_k), \quad (16)$$

where θ is parameters of feature encoder, h_k denotes the parameters of the k -th head task model, e.g., rotation prediction and location prediction task models, h_0 is the actual prediction task, and \mathcal{L}_k is the predefined loss function for k -th head task model and feature encoder. By optimizing the objective, the model will encourage both domains to align together along the direction related to tasks. Recently, inspired by the success of contrastive learning in self-supervised learning, Park et al. [Park et al., 2020] proposed the Joint Contrastive Learning (JCL) to learn discriminative feature representations, which investigates the mutual information between features and labels under the contrastive learning framework. Different from previous DA methods, Saito et al. [Saito et al., 2020] proposed a universally applicable domain adaptation framework, named as Domain Adaptive Neighborhood Cluster via Entropy Optimization (DANCE), to tackle arbitrary category shift. See Figure 6 for an overview. The over optimization function is defined as:

$$\mathcal{L}_{all} = \mathcal{L}_{ce} + \lambda(\mathcal{L}_{nc} + \mathcal{L}_{es}), \quad (17)$$

where λ is the hyperparameter, \mathcal{L}_{ce} is the cross-entropy loss function, \mathcal{L}_{nc} denotes the proposed neighborhood clustering loss function (See Figure 6 left part for an overview), and \mathcal{L}_{es} represents the well-designed entropy separation loss function (See Figure 6 right part for an overview). The goal of \mathcal{L}_{nc} is to learn discriminative and generalizable representation for target domain, which defined as:

$$\mathcal{L}_{nc} = -\frac{1}{|B_t|} \sum_{i \in B_t} \sum_{j=1, j \neq i}^{N_t+K} p_{i,j} \log(p_{i,j}), \quad (18)$$

where B_t is the sets of target samples' indices in the batch, N_t is the number of target data, K is the number of source classes, and $p_{i,j}$ denotes the probability of the target feature f_i is the neighbor of j -th item in memory bank V , which stores all target features and prototype weight vectors. The $p_{i,j}$ is computed by:

$$p_{i,j} = \frac{\exp(F_j f_i / \tau)}{\sum_{j=1, j \neq i}^{N_t+K} \exp(F_j f_i / \tau)}. \quad (19)$$

In order to separate target data into known classes and unknown classes, the entropy separation loss function \mathcal{L}_{es} is formulated as:

$$\mathcal{L}_{es} = \frac{1}{|B_t|} \sum_{i \in B_t} \mathcal{L}_{es}(p_i), \mathcal{L}_{es}(p_i) = \begin{cases} -|H(p_i) - \rho|, & |H(p_i) - \rho| > m, \\ 0, & otherwise. \end{cases} \quad (20)$$

In \mathcal{L}_{es} , p_i is the output of classifier for target feature f_i , $H(p_i)$ is the entropy value, ϕ is threshold to separate target data into known and unknown classes defined as $\frac{\log(K)}{2}$. The over all functions aim to learn the representations for target domain by incorporating contrastive learning to dig the similarity of target data and source class prototypes. Zhu et al. [Zhu and Li, 2021] further extended DANCE by providing different neighbors for different target data to excavate the similarity under the constrastive learning framework and improve the consistency of classifier for each target under different augmentations. Kim et al. [Kim et al., 2021b] proposed Cross-Domain Self-supervision (CDS) to learn discriminative and domain-invariant representations by jointly mining the similarity of source and target data in-domain and cross-domain under the contrastive learning.

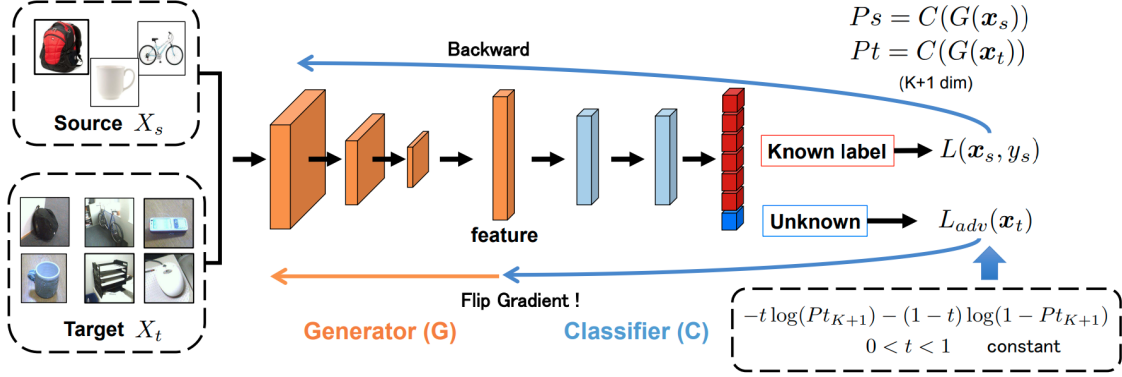

Figure 7: The adversarial learning based framework for open-set domain adaptation.(Image from [Saito et al., 2018b])

3.1.3 Robust Domain Adaptation with Open-Set

Open-set in DA aims to address the practical problem where source and target have different label spaces, and promote the robustness of DA in real-world application. In general, open-set in DA considers two kinds of tasks: the first one is Open-Set Domain Adaptation (OSDA), which assumes that the target label space contains unknown classes for source label space. The later one is Universal Domain Adaptation (UniDA), which removes the restrictions on both label spaces, which allows source and target domains not only have their private label spaces but also share a common label space.

For OSDA, the early method [Saito et al., 2018b] is based on adversarial learning framework, which aligns target data with source domain or reject them as the unknown target classes which don't belong to source label space. See Figure 7 for an overview. They designed the classifier C to classify data into $K + 1$ classes where K is the number of classes in source label space while 1 indicates the target data from unknown classes. The overall objective function is defined as:

$$\begin{aligned} \min_C \mathcal{L}_{ce}(x_s, y_s) + \mathcal{L}_{adv}(x_t), \\ \min_G \mathcal{L}_{ce}(x_s, y_s) - \mathcal{L}_{adv}(x_t), \end{aligned} \quad (21)$$

where $\mathcal{L}_{ce}(\cdot, \cdot)$ is the cross-entropy loss, and $\mathcal{L}_{adv}(\cdot)$ is a binary cross-entropy loss formulated as:

$$\mathcal{L}_{adv}(x_t) = -\alpha \log(p(y = K + 1|x_t)) - (1 - \alpha) \log(1 - p(y = K + 1|x_t)), \quad (22)$$

where $p(y = K + 1|x_t)$ denotes the probability of x_t being classified as the unknown class. α is designed to train the classifier to output $p(y = K + 1|x_t) = \alpha$, which is set to 0.5. Under the adversarial optimization process, the learned representations would gradually separate the target data into known and unknown classes. For these known classes data, they will be aligned to source data. Later, Feng et al. [Feng et al., 2019] and Liu et al. [Liu et al., 2019] shared the similar idea of separating target data into known and unknown classes, and aligning the target data from known classes to source data. Both of them are based on adversarial learning framework. In one approach, researchers delved into the semantic structure of both the source and target domains. They achieved this by aligning the centroid of target data from recognized classes with their corresponding centroid from the source domain. This strategy also involved pushing target data from unfamiliar classes away from the decision boundary. In another approach, a coarse-to-fine weighting mechanism was introduced. This technique gradually separated target data into known and unknown classes. Then, they devised a weighted adaptation process to align the distributions of target and source data, refining the alignment step by step. Recently, instead of using adversarial learning, Bucci et al. [Bucci et al., 2020] proposed a self-supervision based framework, which uses rotation recognition as the pretext task, to separate known and unknown target data and align the distributions of source and known target. To explore the useful information in target data belong to unseen classes, Jiang et al. [Jing et al., 2021] proposed a novel problem, termed as Semantic Recovery Open-Set Domain Adaptation (SR-OSDA), which based on the OSDA problem definition and further provides the semantic attribute annotation on source domain. They designed a framework to simultaneously learn domain-invariant representation and build visual-semantic projection to restore the lacking of semantic attribute of target unknown classes.

For UniDA, a more practical and challenging problem than OSDA, the first UniDA method is Universal Adaptation Network (UAN) [You et al., 2019], which employs a metric consists of entropy and domain similarity values to measure the transferability of each target data and distinguish target data from common classes and those from private classes. See Figure 8 for an overview. In the training phase, the overall optimization objective is defined in an adversarial

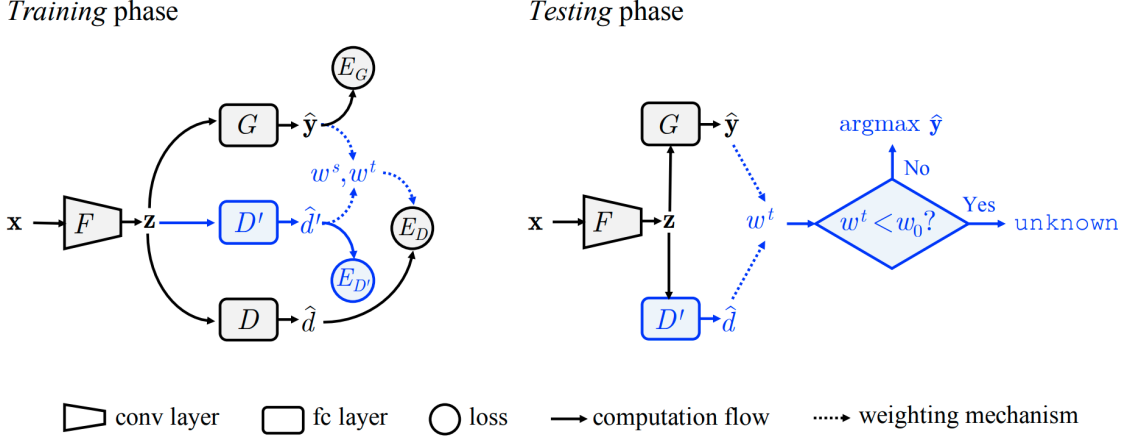

Figure 8: The framework of Universal Adaptation Network (UAN). F is the feature extractor, G indicates the classifier, D represents the adversarial domain discriminator, and D' denotes the non-adversarial domain discriminator which used to compute the domain similarity value. the (Image from [You et al., 2019])

manner:

$$\begin{aligned} \max_D \min_{F,G} E_G - \lambda E_D, \\ \min_{D'} E_{D'}, \end{aligned} \quad (23)$$

where E_G , E_D , and $E_{D'}$ are the error for classifier G , adversarial domain discriminator D , and non-adversarial domain discriminator D' . They are defined as:

$$\begin{aligned} E_G &= \mathbb{E}_{(x_s, y_s) \sim \mathcal{D}_s} \mathcal{L}_{cc}(G(F(x_s)), y_s), \\ E_D &= -\mathbb{E}_{x_s \sim \mathcal{D}_s} \omega_s(x_s) \log D(F(x_s)) - \mathbb{E}_{x_t \sim \mathcal{D}_t} \omega_t(x_t) \log(1 - D(F(x_t))), \\ E_{D'} &= -\mathbb{E}_{x_s \sim \mathcal{D}_s} \log D'(F(x_s)) - \mathbb{E}_{x_t \sim \mathcal{D}_t} \log(1 - D'(F(x_t))), \end{aligned} \quad (24)$$

where $\omega_s(x_s)$ and $\omega_t(x_t)$ are two sample-level transferability criteria for source and target data, that used to constrain the D to distinguish the source and target data in the common label space. They are defined as:

$$\begin{aligned} \omega_s(x_s) &= \frac{H(G(F(x_s)))}{\log(C_s)} - D'(F(x_s)) \\ \omega_t(x_t) &= D'(F(x_t)) - \frac{H(G(F(x_t)))}{\log(C_s)}, \end{aligned} \quad (25)$$

where $H(\cdot)$ is the entropy value. By utilizing these two criteria, UAN can disentangle source and target data into common classes and their private classes. In this way, the category gap and domain shift are jointly reduced. However, the proposed metric is less robust when entropy value is less reliable and domain similarity value is overconfident. Fu et al. [Fu et al., 2020] proposed Calibrate Multiple Uncertainties (CMU) to offer a more robust metric, which consists of entropy, confidence, and consistency from an ensemble framework. Different from UAN and CMU, Saito et al. [Saito et al., 2020] deal with the UniDA problem by utilizing contrastive learning to learn generalizable and discriminative representations and using entropy value of classifier to separate target data into known and unknown classes. Inspired by [Saito et al., 2020], Zhu et al. [Zhu and Li, 2021] proposed a more robust framework to learn better representations and improve the robustness of entropy value of classifier by inducing consistency regularization on target data under different data augmentation. Recently, Li et al. [Li et al., 2021c] investigate discriminative clusters in source and target domains to discover the intrinsic structure of target domain and separate target data into known classes and unknown classes by exploiting domain consensus knowledge. Saito et al [Saito and Saenko, 2021] proposed One-vs-All Network (OVANet) to adaptively learn the threshold to separate target data into known and unknown classes by exploring the inter-class distance between source categories. However above methods ignore the importance of utilizing the intrinsic manifold structure relationship between source and target domains, which could lead their model less robust to real-world application. To address this issue, Chen et al. [Chen et al., 2022b] proposed a global joint local learning framework, which includes geometric adversarial learning for domain alignment, subgraph-level contrastive learning for local region aggregation, and universal incremental classifier for automatic unknown threshold learning, to better align target data from known classes to source data while separate these from target unknown classes data.

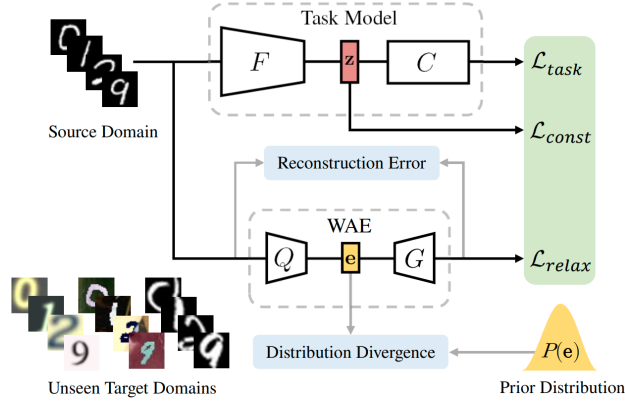

Figure 9: The framework of Meta-Learning based Adversarial Domain Augmentation (M-ADA). F is the feature extractor, C represents the classifier, Q and G denote encoder and decoder, respectively. (Image from [Qiao et al., 2020])

3.2 Domain Generalization

Compared with domain adaptation, domain Generalization (DG) is more difficult to learn a robust model that can generalize to target domain. Because it has to not only address the domain shift between source and target domains but also face the absence of target domain in training stage. Although plenty of existing DG methods have achieved significant performance, there is still a long way to realize robustness for domain generalization in real-world application. In this section, we mainly focus on two branches to review how to learn robust representations in DG under the real application scenarios: single source domain based methods and open-set related methods. Different from the assumption in typical domain generation methods that these are multiple source domain can be used to learn the model, single source domain base methods consider a more challenging and realistic problem, which assumes only one labeled source domains is available for training and many unseen target domains for test. Very recently, open-set related tasks have been proposed under the domain generalization, which require the learned model can accurately classify each target data into either a known class in source label space or an unknown class.

3.2.1 Robust Domain Generalization with Single Source Domain

Single source domain in DG addresses a practical application scenario in DG that only one source domain is available to train the model. This problem is also well-known as Single Domain Generalization (SDG), which is the worst-case domain generalization scenario. One of the earliest SDG methods, named as Meta-Learning based Adversarial Domain Augmentation (M-ADA), is proposed by Qiao et al. [Qiao et al., 2020], which adopts the adversarial data augmentation (ADA) [Volpi et al., 2018] into meta-learning framework and utilizes an auxiliary Wasserstein autoencoder to help ADA generate more challenging data to enrich the diversity of source domain. See Figure 9 for details. They relaxed the ADA objective in Eq. 5 to:

$$\mathcal{L}(\theta; x) = \underbrace{\mathcal{L}_{task}(\theta; x)}_{\text{Task}} - \alpha \underbrace{\mathcal{L}_{res}(\theta; f)}_{\text{Restrict}} + \beta \underbrace{\mathcal{L}_{rel}(\psi; x)}_{\text{Relax}}, \quad (26)$$

where ψ denotes the parameters in encoder Q and decoder G . \mathcal{L}_{rel} ensures large domain transportation defined as:

$$\mathcal{L}_{rel}(\psi; x) = \|x - G(Q(x))\|, \quad (27)$$

here Q and G are pre-trained to capture the distribution of the source domain. Adopting the same augmentation process as ADA in Eq. 11, the M-ADA will generate diverse data to enrich source distribution. They further jointed source data and its augmented version into a meta learning framework to learn the model that can generalize to unseen target domain. Zhao et al. [Zhao et al., 2020c] proposed Maximum-Entropy Adversarial Data Augmentation (MEADA) to generate effective new data distributions consisting of "hard" data that are significantly different from source data by adding the maximum-entropy regularizer to ADA. Fan et al. [Fan et al., 2021] explored the impact of the statistics, i.e., standardization and rescaling statistics, of normalization layers to improve the generalization of the model. They proposed the Adaptive Standardization and Rescaling Normalization (ASR-Norm) to complete the ADA for data augmentation by learning related statistics in network. Wang et al. [Wang et al., 2021a] proposed a style-complement module to improve the capability of model on generating new data that are out of source distribution. In their framework, a mutual information based minmax game is played to enhance the ability of style-complement

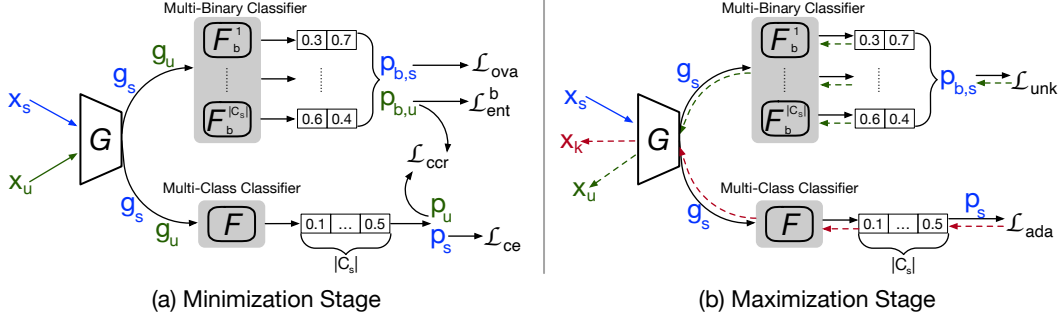

Figure 10: The framework of Cross-Match. G is the feature extractor, F represents the classifier, multi-binary classifier is denoted as $F_b = \{F_b^1, \dots, F_b^{|C_s|}\}$ where $|C_s|$ is the number of classes in source label space. (Image from [Zhu and Li, 2022])

module on data generation and promote the generalizability of model on unseen target domain. Li et al. [Li et al., 2021d] designed Progressive Domain Expansion Network (PDNE) to jointly generate new domains in a progressive manner via the domain expansion subnetwork and learn domain-invariant representation through a contrastive learning based subnetwork. Cugu et al. [Ilke et al., 2022] apply a diverse set of visual corruptions to enrich source distribution and propose an attention consistency loss to align the class activation maps between original data and the corrupted version. Different from above data augmentation based methods, Wan et al. [Wan et al., 2022] address the SDG problem from the aspect of model architecture, they proposed a new convolutional model to extract unbiased universal feature for unseen target data.

3.2.2 Robust Domain Generalization with Open-Set

Open-set in DG simulates the real-world application scenarios that unseen target domain has domain shift and a different label space from the source domains. This practical problem is difficult for existing typical DG methods. Because their learned domain-invariant representations can generalize to target domain is based on the assumption that source and target domains share the same label space. When target domain contains data not belong to source label space, the learned representation would likely fail to generalize to target domain. Very recently, there are two works [Shu et al., 2021, Zhu and Li, 2022] try to tackle the open-set problem from different aspects. Shu et al. [Shu et al., 2021] address the open-set problem under the assumption that there are multiple source domains available for model training. They proposed Domain-Augmented Meta-Learning (DAML) to learn generalizable representation by enriching source domains on feature-level via a new designed Dirichlet mixup and label-level through KL divergence. While, Zhu et al. [Zhu and Li, 2022] tackle the open-set problem under the assumption that there only one source domain accessible for model training. They proposed CrossMatch framework, which jointly generates auxiliary data to simulate target unknown classes data and applies consistency regularization on generated auxiliary data between multi-binary classifiers and the model to improve the capability of learned model on unknown class identification. See Figure 10 for an overview. One of their major contributions is to generate auxiliary data that potentially out of source distribution to simulate unknown classes data. They followed the same strategy in adversarial data augmentation [Volpi et al., 2018] to generate auxiliary data. Similar as the Eq. 12, their augmentation process is written as:

$$x_u^{t+1} \leftarrow x_u^t + \eta \nabla_{x_u^t} \{\mathcal{L}_{unk}(x_u^t) + \gamma \mathcal{L}_{res}(\theta_g; x_u^t, x_s)\}, \quad (28)$$

where \mathcal{L}_{res} is the worst-case guarantee defined in Eq. 12. \mathcal{L}_{unk} is their designed auxiliary data generalization objective which is formulated as:

$$\mathcal{L}_{unk}(x_s, y_s) = -\log(p_{b,s}^{y_s}(t=0|x_s)) + \sum_{i \neq y_s}^k \log p_{b,s}^i(t=1|x_s), \quad (29)$$

where $p_{b,s}^{y_s}(t=0|x_s)$ and $p_{b,s}^{y_s}(t=1|x_s)$ represent the probabilities of being y_s -th class and other classes from the y_s -th binary classifier, respectively. By maximizing \mathcal{L}_{unk} at the maximization stage, it encourages the model to generate new samples that all binary classifiers in F_b predict it as ‘‘other class’’. Thus, the new generated sample could belong to unknown classes.

3.3 Others

Apart from the above mentioned directions in representation learning across domains, which aim to improve the robustness in representation learning in real-world application scenarios. We also provide another two new directions: cross-domain few-shot learning and federated learning across domain.

The Cross-Domain Few-Shot Learning (CDFSL) [Chen et al., 2019b, Tseng et al., 2020, Guo et al., 2020, Wang and Deng, 2021, Liang et al., 2021, Hu et al., 2022, Das et al., 2022, Li et al., 2022] aim to understand and address the domain shift problem for few-shot learning [Wang et al., 2020a, Song et al., 2022]. Early, Chen et al. [Chen et al., 2019b] found that existing few-shot learning methods fail to address the domain shift problem. Guo et al. [Guo et al., 2020] proposed the Broader Study of Cross-Domain Few-Shot Learning (BSCD-FSL) benchmark, which including image data from diverse domains, and evaluated plenty methods, e.g., meta-learning methods, transfer learning methods, few-shot learning method, and newly CDFSL methods. Tseng et al. [Tseng et al., 2020] utilized feature-wise transformation layers to generate various feature distribution to improve the generalization capability of the learned model. Inspired by adversarial data augmentation [Volpi et al., 2018], Wang et al. [Wang and Deng, 2021] proposed an adversarial meta task augmentation based framework to alleviate inductive bias problem and improve the robustness of the model under domain shift. Liang et al. [Liang et al., 2021] proposed a Novel-enhanced Supervised Autoencoder (NSAE) to help model capture broader variations of the feature representation and increase the discrimination and generalization capability of learned model on target domain. Recently, Das et al. [Das et al., 2022] used contrastive learning to learn a generalizable representation and train a masking module to select features that can benefit target domain classification.

The Federated Learning Across Domain (FLAD) [Peng et al., 2020, Zhang et al., 2021b, Liu et al., 2021c, Yao et al., 2022] aims to address the domain adaptation and domain generalization problems under the data privacy constraint. Although federated learning [Zhang et al., 2021a] have addressed data privacy and efficiency problem under the networks of distributed devices for deep learning. The learned model still suffer from domain shift problem which would degrade the robustness of the model in real-world application scenarios. In the context of federated learning, addressing domain adaptation challenges, Peng [Peng et al., 2020] introduced a novel concept known as Unsupervised Federated Domain Adaptation (UFDA). This approach involves transferring knowledge from decentralized nodes to a new node with a distinct data domain, referred to as the target domain. To tackle domain shift in federated learning, they introduced Federated Adversarial Domain Adaptation (FADA), which employs a dynamic attention model to effectively manage the domain shift problem. Different from [Peng et al., 2020], Zhang et al. [Zhang et al., 2021b] addressed the domain generalization problem under federated learning. They proposed FedADG framework, which including Adversarial Learning Network (ALN) for each node to align each source domain to the generated reference distribution, and a distribution generator in server to generated reference distribution.

4 Privacy in Representation Learning Across Domains

Deep neural networks are experiencing a surge in popularity across diverse domains including natural language processing, computer vision, rapid recognition, and recommendation systems. The wide use of machine learning models, at the same time, also brings privacy concerns. In recent years, customers are gradually provided with access to software interfaces (e.g., from Google, Microsoft, Amazon) that allow them to easily use machine learning tasks for their own applications. However, if the training data are able to be recovered by some malicious users, serious issues can be caused by such information leaking, especially when the training data is sensitive, say, medical records. Likewise, the parameters of the model, which are considered as proprietary information, should also be protected from being stolen with access to the interface. In representation learning across different domains, due the information exchange among multiple domains, the risk of potential information leakage can be increased and requires more attention. Within this section, we initially provide a concise overview of common privacy challenges. Subsequently, our focus shifts towards addressing privacy concerns when undertaking cross-domain learning. Concluding, we shed light on less-explored challenges and potential avenues for forthcoming research.

4.1 Privacy in Deep Learning

In this section, we briefly discuss what privacy threats exist for a deep learning model De Cristofaro [2020] and roughly categorize them into three classes.

4.1.1 Inference of the population

1. *Statistical disclosure* : given the trained model, the adversary tries to learn about the input of the model. Theoretically, to control statistical disclosure, it is required that applying the trained model should not reveal more knowledge about its training input than it is not applied.

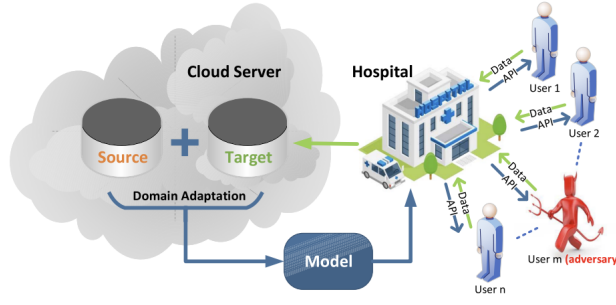

Figure 11: An illustration of domain adaptation and the risk of privacy leakages. (image from Wang et al. [2020b])

2. *Model inversion* : The adversary seeks to deduce the sensitive attributes of the input to the model using the model’s output, provided the input.
3. *Inference of class features* : Relaxing the sensitive attributes in model inversion to arbitrary class attributes which characters a particular task, the adversary tries to learn about the characters of each class with access to the model.

4.1.2 Inference of the training dataset

This aspect focuses on the privacy of the individuals who provide data for the training of the model.

1. *Membership inference* : given a model and an instance, the adversary discriminates if the instance was in its training dataset.
2. *Property inference* : In cases where training data are distributed across different clients, the adversary tries to infer characters that are true of a subset of the training data.

4.1.3 Inference of Model Parameters

Different from previous aspects which focus on the data, this aspect concentrates on the privacy of the model itself.

1. *Model Extraction* : The adversary tries to learn an equivalent or near-equivalent model with the access to the model (e.g., query access).

4.2 Privacy issue in learning across different domains

Transfer learning aims to enhance the learning of weakly labeled or unlabeled target domain with the acquired knowledge of source domain. Nowadays, the growing privacy protection awareness, which restricts access to different data sources makes traditional transfer learning more difficult to work. Thus transfer learning technologies under strict privacy constraints should be developed to keep in step with changing regulations.

Existing research efforts in the realm of privacy within transfer learning predominantly concentrate on safeguarding data privacy. Particularly, the concept of differential privacy, which offers a mathematically rigorous framework for data privacy, is commonly employed as the guiding principle. Given a randomized algorithm M with an output space Ω and a well-defined probability distribution, it is considered (ϵ, δ) -differentially private if, for all pairs of adjacent datasets \mathbf{D} and \mathbf{D}' differing by a single data point d , and for all measurable sets $\omega \in \Omega$, the following inequality holds:

$$\Pr[M(\mathbf{D}) \in \omega] \leq \exp(\epsilon) \Pr[M(\mathbf{D}') \in \omega] + \delta$$

Differential privacy necessitates that upon obtaining the output of a differentially private algorithm \mathbf{M} applied to the confidential dataset \mathbf{D} , there should be no means of ascertaining whether a specific data point d is present in the private dataset \mathbf{D} or not. The parameter ϵ represents the privacy budget, signifying the extent of privacy inherent to the model. A diminished value corresponds to an augmented level of privacy.

Wu et al. (2022) and Wang et al. (2018) address the domain of differential privacy within multi-source transfer learning, encompassing the presence of multiple source domains. While prevailing endeavors in data privacy predominantly

exploit differential privacy mechanisms within single-domain settings, these approaches often overlook the shifts in distribution across diverse domains. To counter this limitation, Wang et al. (2018) introduce a methodology for differentially private multi-source hypothesis transfer learning. This technique assesses the interplay between source and target domains by utilizing hypotheses trained on the source domain. This strategy amplifies the refinement of target hypothesis acquisition by utilizing an accessible public unlabeled source dataset. Concurrently, Wu et al. (2022) present the MultiSTLP algorithm, which engages in multi-source selection transfer learning with an emphasis on privacy preservation. Distinct from Wang et al. (2018), this approach leverages samples from a representative dataset culled from various sources, alongside unlabeled group probability samples within the target domain.

Domain adaptation, a subset of transfer learning, endeavors to adjust a model trained in a source domain to a target domain. This adaptation occurs when the distributions of the source and target domains differ yet maintain a certain level of interrelation. In scenarios where data from the source domain possess labels while data from the target domain remain unlabeled, the term "unsupervised domain adaptation" (UDA) is commonly used. Contemporary UDA techniques proficiently convey knowledge from the labeled source domain to the unlabeled target domain. However, in practical contexts, as exemplified in Figure 1, where disparate institutions furnish data for the source and target domains, the potential for privacy risks surfaces due to the information exchange between these distinct domains.

While most existing works fail to take this aspect into consideration, a few recent works Wang et al. [2020b], Jin et al. [2021], Zhuang et al. [2021], An et al. [2022], Stan and Rostami [2021] study how to perform unsupervised domain adaptation with privacy guarantees for training data. Wang et al. Wang et al. [2020b] propose to perform domain adaptation with privacy assurance in an adversarial learning way and embed the differential private design into specific layers and learning processes. Different from Wang et al. Wang et al. [2020b], Jin et al. Jin et al. [2021] proposes a private correlation alignment approach for domain adaptation (PRIMA). In pursuit of privacy assurances, perturbations are introduced into the authentic covariance matrix, resulting in a confidential covariance matrix for the target domain. Moreover, during gradient-based model training, perturbations are applied to gradients to achieve a privacy-preserving model. Supplementary enhancements are implemented to address the constraints arising from the integration of these perturbation techniques.

Common unsupervised domain adaptation algorithms typically involve access to source domain data. However, in cases where heightened data privacy is imperative—such as with sensitive data like medical records—sharing source data with the target domain becomes unfeasible. Notably, Stan et al. Stan and Rostami [2021] and An et al. An et al. [2022] delve into the UDA challenge under such privacy constraints. To address this issue, Stan et al. Stan and Rostami [2021] employ an innovative approach where they encode information from source data into a prototypical distribution. This intermediate distribution serves as a means to align the distributions of the source and target domains. On a similar note, An et al. An et al. [2022] propose an alternative strategy, where the feature distribution of the source domain, rather than the raw data, is shared. To counter membership inference attacks, An et al. An et al. [2022] model the source feature distribution using Gaussian Mixture Models within a differentially private framework. This modeled distribution is then transmitted to the target domain for adaptation. Subsequently, the target client resamples differentially private source features from the Gaussian Mixture Models and adapts using state-of-the-art unsupervised domain adaptation techniques tailored for the target domain data.

Federated Learning adheres to data privacy constraints, typically disallowing data sharing between the server model and client models. A line of research Peng et al. [2020], Sun et al. [2021], Liu et al. [2021c], Reddi et al. [2020], Zhang et al. [2021b] study domain adaptation or domain generalization under the federated learning setting, where only parameter transmission is allowed. Different from traditional federated learning, it is more challenging because datasets may differ in both the sample and feature space. In such a setting, transferring the knowledge safely without violating the privacy constraints is required. They are subject to the privacy constraint in federated learning setting, however, prohibiting data sharing is merely a basic approach to protect data privacy. For higher levels of data privacy protection, several recent works especially Zhang et al. [2020], Gao et al. [2019], Song et al. [2020], Zhuang et al. [2021] focus on the privacy protection in such setting. Different strategies are proposed for better adaptation under privacy constraints. To protect client data privacy, homomorphic encryption based approaches Zhang et al. [2020], Gao et al. [2019], Song et al. [2020] are proposed for effective knowledge transfer. More specifically, Zhang et al. Zhang et al. [2020] improves the commonly used maximum mean discrepancy with secure-aware technologies based on homomorphic encryption for effective knowledge transfer without compromising privacy. Song et al. Song et al. [2020] exploit homomorphic encryption to encrypt intermediate results which need transmitting to protect privacy. Gao et al. Gao et al. [2019] builds a federated transfer learning framework with a privacy preserving learning approach with two variants based on homomorphic encryption and secret sharing techniques. Zhuang et al. Zhuang et al. Zhuang et al. [2021] further explore unsupervised domain adaptation within a federated learning context, with a primary emphasis on enhancing model performance through iterative aggregation of knowledge from the source domain via federated learning. In this approach, data privacy is safeguarded by exclusively transferring models, rather than raw data, between domains,

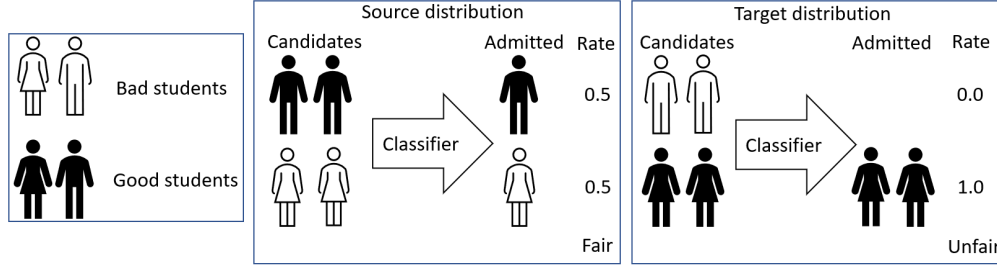

Figure 12: an example for **unfairness in covariate shift**. It shows the same prediction model for admission in different data distribution environments. In source domain, in order to satisfy same admission rate between males and females, the classifier will give the higher weight on gender attributes. However, in target domain, the model preference would cause the unfairness that female admission rate is higher than male's.

omitting additional privacy-preserving techniques. Different from other existing works, Kohen et al. Kohen and Sheffet [2022] first presents a general framework for transfer learning in the hybrid-model.

5 Fairness in Representation Learning Across Domains

Fairness in machine learning attracts a lot of attention nowadays. It protects interests of any individuals and groups in decision making or recommendation systems. In the context of across domains, fairness becomes more realistic but more difficult to achieve. In this section, we firstly talk about the unfairness circle and sources in across domain areas. We mainly focus on across domain in train/test situation, because across domain in training stage only, like class incremental continual learning, is very similar to traditional fairness settings. Then we introduce some approaches, bounding based, training based, causal inference based, to achieve fairness. At last, we discuss the current challenges and possible future directions.

5.1 Unfairness Circle

For transitional unfairness issues, the original bias emerges from imbalanced data, algorithms and user interactions. It is almost invariant in cross domain area. For data perspective, imbalanced data in source domain first introduce unfairness. For example, the dominant attribute classes would play more important role in prediction while ignore minor classes. In addition, though it satisfies great in source domain, it may cause serious unfairness when deploying in real world due to distribution shift. Algorithms, however, in order to fit the source domain distribution, it will inevitably skew the distribution in target domain and make less accurate and less fair predictions [Chen et al., 2022c, Coston et al., 2019, Rezaei et al., 2021]. Moreover, the prediction result would further influence user preferences. The behavioural biases will aggregate the unfairness in data.

5.2 Source of Unfairness in across domain area

Unfairness issues in cross domain areas are mainly result from distribution shift [Amodei et al., 2016] or domain shift [Sun et al., 2016]. Distribution shift means that data distribution between training dataset and real world situation is different. In general, distribution shift can be classified as two types, including **covariate shift** [Shimodaira, 2000, Sugiyama et al., 2007, Gretton et al., 2009] and **label shift** [Schölkopf et al., 2012, Lipton et al., 2018, Azizzadenesheli et al., 2019]. Covariate shift means the disparity of input variables distribution between different datasets. It will raise unfairness issues. For example, Fig. 12 shows a classifier is fair in source distribution while it would produce unfairness results in target distribution since it would give higher weights on female attributes. As for the label shift, it means that feature distribution remains the same, the label distribution might changes. For example, one school may admit students with grades of B or higher, but another school will only admit students with grades of A. It is obvious that a fair model training on one school dataset will not be fair on the other school. However, a lot of works [Chen et al., 2022c, Coston et al., 2019, Rezaei et al., 2021, Oneto et al., 2020, Singh et al., 2021] try to mitigate such unfairness and improve the fairness transferability.

5.3 Main work in fairness

With different training stages, fairness can be divided into pre-process method, in-process method and post-process method. We summarize the related papers in table 5. Pre-processing methods mitigate unfairness by modifying training

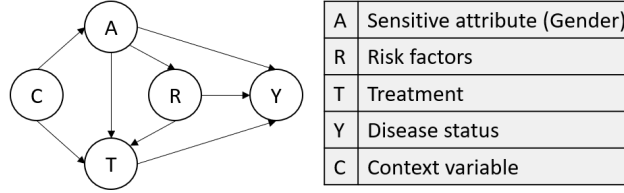

Figure 13: **Causal graph** for a disease treatment example. A, R, T, Y are system variables. C is the context variable. Arrow indicates the causality. For example, $T \rightarrow Y$ indicates that treatment will influence disease status.

data, such as data augmentation. For example, wang et al. [Wang et al., 2021b] tried to deal with fair domain adaptation classification problem. They generate supplementary samples in the source domain for few-shot classes to improve classification accuracy for minor class. However, in across domain area, there are not much work in pre-processing category since it is intractable to include all possible data distribution during training process by modifying data. In-processing methods focuses on model itself to find a balance between accuracy and fair. post-processing approaches apply modification on model output while keep model fixed. Pre-processing methods mitigate unfairness by modifying training data, such as data augmentation. Most of existing work are in-processing methods because only in-processing approaches can directly optimize model to achieve fairness. In this section, we will mainly talk about in-processing methods.

In processing approaches mainly consist of this three categories, **bounding based, training based, causal inference based**.

5.3.1 Bounding based Approaches

The most popular and intuitive methods are bounding based approaches. They set up a fairness bound, e.g., fairness definition, to regulate representations or downstream tasks. Chen et al. [Chen et al., 2022c] formulates a general upper bound for transferred group fairness violation subject to distribution shift, including covariate shift and label shift; Coston et al. [Coston et al., 2019] made the problem more challenge. It focuses on a situation that sensitive attributes are only available either in source domain or target domain. They use demographic parity as their fairness metric. They use weighting methods to minimize empirical risk in order to bring group-specific prevalence closer together; zhao et al. [Zhao et al., 2021] applied fairness in online meta-learning. It applies decision boundary covariance to regulate model.

5.3.2 Causal inference based Approaches

Causal inference methods leverage the causal information to deal with the unfairness issues, especially in counterfactual fairness. We can draw a common causal graph to illustrate the problem and fairness objective. As shown in Figure.13, A, R, T, Y are system variables. A is the sensitive attribute and Y is the label for prediction. C is the context variable, which indicates the domain distribution. In other words, $P(A, R, T, Y|C = 0)$ and $P(A, R, T, Y|C = 1)$ represent joint distribution as source and target domains, respectively. Now the fairness problem can be formulated as a minimization problem, i.e.

$$f_{target}^* = \arg \min_{f \in F} \{ (P(f(S) \neq Y|C = 1) + G(f, P(Y, S|C = 1))) \leq \epsilon \} \quad (30)$$

, where $S = A, R, T$ is the input features, and $G(f, P_{target})$ is the fairness constraint, and f is the learnable function and ϵ is the hyperparameter controlling the intensity of constraints. In this equation, we have two terms. $P(f(S) \neq Y|C = 1)$ describes the classification error. Minimizing it would result in higher accuracy. $G(f, P(Y, S|C = 1))$ is the fairness constraint in target domain. Lower value indicates higher fairness achievement. For example, Demographic parity can be formulated as

$$|P(f(S)|A = 0) - P(f(S)|A = 1)| \leq \epsilon_0$$

Singh et al. [Singh et al., 2021] studied the problem that the target distribution is unseen. They leverage the causal information to model data shifts and exploit conditional independencies in the data to estimate model accuracy and fairness metrics. They not only use group-fairness metrics, i.e. demographic parity and Equalized odds, but also extend to counterfactual fairness. Zhao et al. [Zhao et al., 2020d] inferred decision boundary covariance from fair causality and casual effect. They ensure fairness by controlling the covariance between the protected variables and the signed distance from the feature vectors to the decision boundary.

Table 5: Summary of the typical fairness in across domains scenarios. Goal refers to the target task. Specifically, "Data" means making training data unbiased; Bound means setting up a fairness upper bound; prediction is predicting labels; and representation refers generate fair latent embeddings. In the fairness metric column, DP denotes demographic parity [Dwork et al., 2012] or statistic parity and EO refers to Equal opportunity [Hardt et al., 2016] and CF means counterfactual fairness [Kusner et al., 2017], and DBC is Decision Boundary Covariance [Zafar et al., 2017].

Methods	Goal	Fairness metric	Phase	Condition
Wang et al. [2021b]	Data	-	Pre	few-shot DA
Chen et al. [2022c]	Bound	DP, EO	In	-
Coston et al. [2019]	Prediction	DP	In	Missing sensitive attributes
Zhao et al. [2021]	Prediction	DP,EO	In	Online learning
Singh et al. [2021]	Prediction	DP, EO, CF	In	Unseen test set
Zhao et al. [2020d]	Prediction	DBC	In	few shot
Rezaei et al. [2021]	Prediction	EO	In	target data with unknown label
Mandal et al. [2020]	Prediction	DP, EO	In	-
Hong et al. [2021]	Prediction	EO	In	federated learning
Oneto et al. [2020]	Representation	DP	In	-

5.3.3 Training based Approaches

Training based methods aim to construct a training strategy to achieve fairness. For example, adversarial training strategy trains a fair representation to fool a sensitive discriminator. If the sensitive discriminator can not predict sensitive information, the representation and its downstream task can achieve fairness. Rezaei et al. [Rezaei et al., 2021] converted fair prediction problem to a competition between an adversary to fairly minimize predictive loss and an adversary to maximize that objective loss. Rezaei et al. [Rezaei et al., 2021] proposed a approach to obtain a predictor that is robust to covariate shift and satisfy target fairness requirements. They formulate a penalty term that can evaluate the fairness in target distribution and optimize the problem based on that. While Mandal et al. [Mandal et al., 2020] moved a step forward. They train a fair classifier that is robust to any distributions that could represent any arbitrary weighted mixtures of training distributions. They formulate a min-max objective function. On the one hand, it minimizes distributionally robust training loss; on the other hand, it finds a fair classifier with respect to a class of distribution. Hong et al. [Hong et al., 2021] considered federated learning situation. The debiasing process does not involve accessing users' sensitive group information, ensuring their privacy. Additionally, users have the freedom to choose whether to participate in the adversarial component, particularly when they have concerns about privacy or computational costs.

Multi-task training strategy can also formulate fair and robust representations. Oneto [Oneto et al., 2020] focused on generate robust and fair representations. they learn fair and transferable representations by leveraging multi-tasks learning with guarantees on generalization to the target domain.

6 Explainability in Representation Learning Across Domains

Interpretable and explainable machine learning models emerge from a situation that human is model agnostic. In order to understand why model works well or not, interpretable and explainable models are proposed to help explain machine learning models in an intuitional way. Explainability has been studied in many areas. It can be defined as "the ability to explain or to present in understandable terms to a human" [Doshi-Velez and Kim, 2017]. In the context of representation learning across domains, we hope we can know what a model learn from source domain and how a model apply it to target domain. Thus, when a model is deployed in real world that work poor or violate some safety [Häuslschmid et al., 2017] or ethnicity [Ross, 2010] rules, we can easily troubleshoot them.

In this section, we first introduce the goal of explainability models and some concepts, and then we summarise current work in explainable and interpretable work in across domain area. We divide them into explainable models and interpretable models. At last, we will talk about its future directions.

6.1 Concepts

6.1.1 interpretability

Interpretability requires models to give accurate and meaningful outputs, i.e., it not only answers what the results are but also explains why the results are presented. Specifically, interpretable models reflect physical constraints, monotonicity, additivity, causality, sparsity and/or other desirable properties [Rudin, 2019, Carvalho et al., 2019, Marcinkevičs and

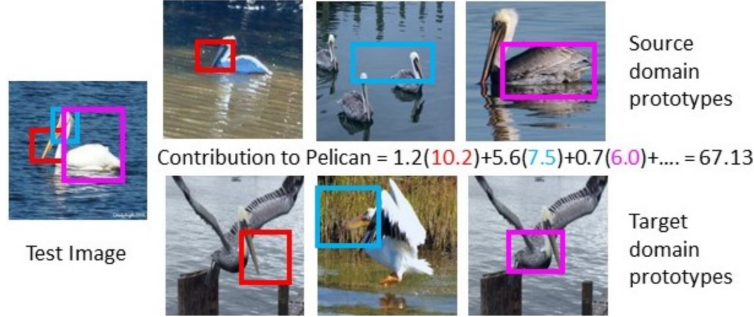

Figure 14: XSDA-Net instance-level explanation. It extract some image prototypes from source domain and target domain. According to comparing test images with these prototypes, the similarity scores are forwarded to prediction. Image from [Kamakshi and Krishnan, 2022].

Vogt, 2020]. In the context of representation in across domains, the interpretability of models leverage intrinsically interpretable designs to explain predictions or generations.

6.1.2 explainability

explainability refers to explain an existing black-box model post hoc. Explainable model is independent to target model that we try to explain. Bascially, it aims to analyze the results that a model gives in a textual, visual or symbolic way [Lipton, 2018]. It can be model agnostic or model specific. In either way, it should satisfy Faithfulness, Consistency, Comprehensibility, Certainty, Representativeness. [Carvalho et al., 2019]

6.2 Main work

6.2.1 Interpretable model

Interpretable models can be divided into instance-level, group-level and class-level models in terms of interpretable objects. Instance-level models can give explanations for each samples. Kamakshi et al. [Kamakshi and Krishnan, 2022] proposed XSDA-Net to explain the prediction of every test instance in terms of prototypes in the source and target samples. XSDA-Net extracts prototypes and calculates similarity with these prototypes, like Fig. 14. Zunino et al. [Zunino et al., 2021] explains their across domain classification network by means of a saliency map conveying how much each pixel contributed to the network prediction. Raab et al. [Raab et al., 2022] also adapted saliency map to interpretable their model. Though saliency map is wildly used in interpretable models, it has some limitations. For example, saliency map is unable to give sufficient explanations for those false predictions since it focuses on the same pixels when it predicts correctly.

Other across domain generating task also involves interpretability, such as semantic autoencoder (SAE), Generative adversarial network(GAN). Back from [Kodirov et al., 2017], Kodirov et al. tried to align latent feature space with semantic feature space. In this way, image features can be translated into semantic level, vice versa. Conditional GAN [Mirza and Osindero, 2014] also wants to generate images while controlling some semantic information. Gao et al. [Gao et al., 2020] used variational autoencoder (VAE) and generative adversarial network (GAN) jointly to generate unseen features. Li et al. [Li et al., 2019] proposed LisGAN, which can directly generate the unseen features from random noises which are conditioned by the semantic descriptions. These generative methods inherit explainability.

6.2.2 explainable model

Explainable models aim to explain black box prediction models. It can be divided as model-agnostic and model-specific categories. However, this topic in across domain is not studied very much. Hou et al. [Hou and Zheng, 2021] is model-agnostic one, which visualizes the adapted knowledge difference with image translation. Like Fig. 15, they portray the knowledge learned from different UDA models and find that these generated images are able to capture the difference between source and target domains.

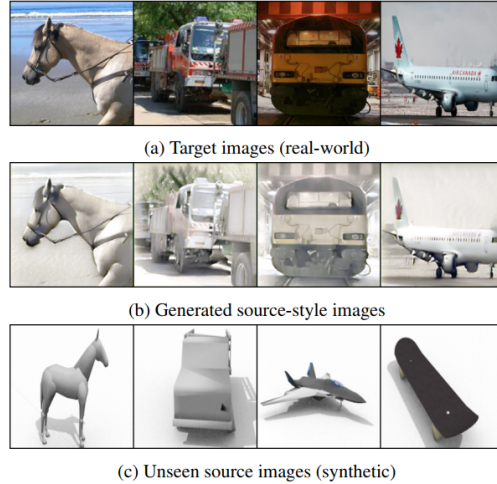

Figure 15: Visualization of adapted knowledge in unsupervised domain adaptation on the VisDA dataset [Peng et al., 2017]. Fig.a shows the target images. Fig.b are images generated from fig.a. Fig.c is the source images which is inaccessible during generating process. Image from [Hou and Zheng, 2021].

7 Future Research Directions

We have introduced our trustworthy in representation learning across domains framework in Sec. 1.2 and go through the existing methodologies developed for each concepts in Sec.3, 4, 5, 6. Instead of only reviewing the existing methods, we also try to share some insights on future research directions in our trustworthy framework.

7.1 Future Research Direction of Robustness

We have reviewed several directions from different scenarios for representation learning across domains in terms of Robustness. In this section, we provide four potential research directions.

Novel Categories Recognition. In representation learning across domains, a key task within the open-set framework is identifying target data that lies outside the source label space. These endeavors [Saito et al., 2018b, Feng et al., 2019, Fu et al., 2020, Li et al., 2021c, Shu et al., 2021, Zhu and Li, 2022] typically center on mining valuable insights from data to aid in classifying target data into either known or unknown categories. In some cases, augmenting data with more information can facilitate the development of robust representations, pertinent to real-world applications. For instance, Jiang et al. [Jing et al., 2021] introduced semantic attribute annotations for the source domain. This approach yielded a more resilient model compared to existing methods. Another avenue for inducing meaningful information involves leveraging vision and language models [Jia et al., 2021, Li et al., 2021e, Radford et al., 2021]. These models are trained using image-caption pairs, offering beneficial impacts on various computer vision tasks, including object detection [Zhao et al., 2022] and object classification [Xu and Le, 2022]. This alternative direction has the potential to enrich the representations and enhance the performance of models in a range of applications.

Few Labeled Data. In the realm of representation learning across domains, a prevailing assumption is that target data remains unlabeled. However, fully annotating all target data can be both time-consuming and costly in practical applications. In many scenarios, having access to a small set of labeled target data is feasible and economical. Exploring effective strategies to maximize the utility of these limited labeled target data represents a promising avenue to enhance the robustness of learning representations. This direction holds potential for further advancements in representation learning across domains.

Feature Generation. The efficacy of data augmentation in bolstering the robustness of representation learning across diverse domains has been firmly established [Zhao et al., 2020c, Yue et al., 2019, Zhou et al., 2020b, Shu et al., 2021]. These methods often focus on generating new data to enrich the diversity of the original data distribution. However, the concept of feature generation has received relatively limited attention. Only a handful of studies have explored this aspect, yielding substantial improvements. For instance, Xu and collaborators [Xu and Le, 2022] introduced a model based on conditional variational autoencoders to generate new features that complement the original feature distribution. Li et al. [Li et al., 2020], on the other hand, harnessed conditional Wasserstein generative adversarial networks to

produce a variety of distinctive and discerning features. These efforts emphasize the untapped potential of enhancing features through data augmentation, offering a unique perspective on advancing representation learning across domains.

Privacy Issue based Cross-Domain Tasks. When People and society are paying more and more attention to data privacy, federated learning is proposed to address this issue. But this also leads to the learning model is vulnerable in real-world applications. To improve the robustness of the model under the requirement of protecting data privacy, several attempts have been done. For example, solving the unsupervised domain adaptation [Peng et al., 2020] and domain generalization [Zhang et al., 2021b] via federated learning framework. There still existing plenty of cross-domain tasks, e.g., various tasks in domain adaptation and domain generalization, to be solved through federated learning framework.

Foundation Models. Recently, foundation models such as Contrastive Language-Image Pre-Training (CLIP)Radford et al. [2021] and Segment Anything Model (SAM)Kirillov et al. [2023] have demonstrated remarkable capabilities in generalization, particularly in zero-shot and few-shot learning scenarios. However, these foundation models still face challenges in cross-domain learning tasks. Several studies [Ge et al., 2022, Zara et al., 2023, Shu et al., 2023] have highlighted that the generalization of these foundation models needs improvement, especially when dealing with tasks involving significant domain shifts between the source and target domains. Consequently, a promising avenue of research involves enhancing the generalization of foundation models for downstream tasks in the presence of domain shifts. This represents an emerging direction worth exploring.

7.2 Future Research Direction of Privacy

While most existing works pay attention to the data privacy on unsupervised domain adaptation, the data privacy issue in other existing domain adaption and domain generalization tasks mentioned in Sec. 2 also deserve attention such as: semi-supervised domain adaption, open-set domain adaption, and open-set domain generalization. Besides, in existing works, the focus of privacy in representation learning across domains is data privacy. However, other types of privacy, as discussed in Sec. 4.1.1 are still under-explored in the context of learning across different domains. There are still many challenging problems remaining to be explored in the future.

7.3 Future Research Direction of Fairness

Fairness Definition and Evaluation. The fairness in across domain area is still a emerging topic. The definition of fairness mostly rely on traditional metrics, i.e. demographic parity [Dwork et al., 2012], equal odds [Hardt et al., 2016]. However, most work currently focus on a fixed target domain. In realistic, target domain may varied and even changes every time. Thus, how to define a general fairness to cover the online situation. In addition, in some tasks, such as face recognition, it is important to achieve fairness in both source and target domains. How to define such fairness which can cover both domains.

Interpretable Fairness. Fairness models are working on achieve fairness in mathematical or statistical way no matter in independent and identically distributed data or across domain data. How can we use some explainable way, such as causal graph, saliency map, to interpret models so that it can further direct human to make non-discriminatory judgments.

Fairness in Foundation Models. Foundation models such as the Segment Anything Model (SAM) [Kirillov et al., 2023] and CLIP-based models exhibit remarkable zero-shot capabilities. However, their effectiveness is often hindered by inherent biases and imbalances present in their training data, leading to challenges in ensuring fairness across various contexts. Several recent studies [Seth et al., 2023, Wolfe et al., 2023] have diligently quantified the extent of unfairness exhibited by these multi-modal models. Addressing these fairness concerns requires innovative research directions that focus on enhancing the fairness of foundation models for downstream tasks, even in the face of domain shifts. A promising avenue involves strategies to mitigate these issues. For instance, one approach is through prompt learning. This technique encompasses the design of carefully crafted prompts or the acquisition of dynamically adaptable soft prompts, enabling the foundation model to consciously reduce attention towards sensitive attributes. This adjustment can significantly contribute to improving the fairness performance of the model.

7.4 Future Research Direction of Explainability

Explainable Metrics. Explainability of existing models are unquantifiable. For example, these works [Raab et al., 2022, Zunino et al., 2021] use saliency map to explain their models. However, it is intractable to prove whether they give great explanations or not. Thus, a metric for explainability is needed to measure those explainable models.

High-level explanations. No matter interpretable models [Kamakshi and Krishnan, 2022, Zunino et al., 2021] or explainable models [Hou and Zheng, 2021] explain across domain models in a low-level way, such as saliency map,

Although it can bring some latent information for us to understand a model, it is still unable to troubleshoot misclassified samples. Therefore, high-level explanations, like nature language, semantic information, are necessary to better assist human to understand models.

8 Conclusion

In this survey, we instantiate the trustworthy AI core concepts to representation learning across domains. We introduce four foundational crucial concepts of trustworthy AI system, i.e., robustness, privacy, fairness, and explainability, to build our trustworthy representation learning across domains framework. For each concepts, we present a comprehensive overview of related methodologies to help reader understand, how each concepts is addressed. Additionally, we provide comprehensive details of advanced technologies to ensure a thorough understanding of the research. Furthermore, we delve into potential future research directions related to each concept, aiming to inspire further advancements in trustworthy representation learning across domains.

References

- Zhenhua Guo, Lei Zhang, and David Zhang. A completed modeling of local binary pattern operator for texture classification. *IEEE transactions on image processing*, 19(6):1657–1663, 2010.
- David G Lowe. Object recognition from local scale-invariant features. In *Proceedings of the seventh IEEE international conference on computer vision*, volume 2, pages 1150–1157. Ieee, 1999.
- Navneet Dalal and Bill Triggs. Histograms of oriented gradients for human detection. In *2005 IEEE computer society conference on computer vision and pattern recognition (CVPR'05)*, volume 1, pages 886–893. Ieee, 2005.
- Samira Pouyanfar, Saad Sadiq, Yilin Yan, Haiman Tian, Yudong Tao, Maria Presa Reyes, Mei-Ling Shyu, Shu-Ching Chen, and Sundaraja S Iyengar. A survey on deep learning: Algorithms, techniques, and applications. *ACM Computing Surveys (CSUR)*, 51(5):1–36, 2018.
- Yanming Guo, Yu Liu, Ard Oerlemans, Songyang Lao, Song Wu, and Michael S Lew. Deep learning for visual understanding: A review. *Neurocomputing*, 187:27–48, 2016.
- Yann LeCun, Yoshua Bengio, et al. Convolutional networks for images, speech, and time series. *The handbook of brain theory and neural networks*, 3361(10):1995, 1995.
- Michael I Jordan. Serial order: A parallel distributed processing approach. In *Advances in psychology*, volume 121, pages 471–495. Elsevier, 1997.
- Franco Scarselli, Marco Gori, Ah Chung Tsoi, Markus Hagenbuchner, and Gabriele Monfardini. The graph neural network model. *IEEE transactions on neural networks*, 20(1):61–80, 2008.
- Ian Goodfellow, Jean Pouget-Abadie, Mehdi Mirza, Bing Xu, David Warde-Farley, Sherjil Ozair, Aaron Courville, and Yoshua Bengio. Generative adversarial networks. *Communications of the ACM*, 63(11):139–144, 2020.
- Ashish Vaswani, Noam Shazeer, Niki Parmar, Jakob Uszkoreit, Llion Jones, Aidan N Gomez, Łukasz Kaiser, and Illia Polosukhin. Attention is all you need. *Advances in neural information processing systems*, 30, 2017.
- Tero Karras, Samuli Laine, and Timo Aila. A style-based generator architecture for generative adversarial networks. In *Proceedings of the IEEE/CVF conference on computer vision and pattern recognition*, pages 4401–4410, 2019.
- Feng Liu and Xiaoming Liu. Learning implicit functions for topology-varying dense 3d shape correspondence. *Advances in Neural Information Processing Systems*, 33:4823–4834, 2020.
- Jeff Donahue, Yangqing Jia, Oriol Vinyals, Judy Hoffman, Ning Zhang, Eric Tzeng, and Trevor Darrell. Decaf: A deep convolutional activation feature for generic visual recognition. In *International conference on machine learning*, pages 647–655. PMLR, 2014.
- Kaiyang Zhou, Ziwei Liu, Yu Qiao, Tao Xiang, and Chen Change Loy. Domain generalization: A survey. *IEEE Transactions on Pattern Analysis and Machine Intelligence*, 2022.
- Mei Wang and Weihong Deng. Deep visual domain adaptation: A survey. *Neurocomputing*, 312:135–153, 2018.
- Jindong Wang, Cuiling Lan, Chang Liu, Yidong Ouyang, Tao Qin, Wang Lu, Yiqiang Chen, Wenjun Zeng, and Philip Yu. Generalizing to unseen domains: A survey on domain generalization. *IEEE Transactions on Knowledge and Data Engineering*, 2022.
- Dan Hendrycks and Thomas Dietterich. Benchmarking neural network robustness to common corruptions and perturbations. In *International Conference on Learning Representations*, 2019.

- Benjamin Recht, Rebecca Roelofs, Ludwig Schmidt, and Vaishaal Shankar. Do imagenet classifiers generalize to imagenet? In *International Conference on Machine Learning*, pages 5389–5400. PMLR, 2019.
- Maxime Oquab, Leon Bottou, Ivan Laptev, and Josef Sivic. Learning and transferring mid-level image representations using convolutional neural networks. In *Proceedings of the IEEE conference on computer vision and pattern recognition*, pages 1717–1724, 2014.
- Jason Yosinski, Jeff Clune, Yoshua Bengio, and Hod Lipson. How transferable are features in deep neural networks? *Advances in neural information processing systems*, 27, 2014.
- Mingsheng Long, Yue Cao, Jianmin Wang, and Michael Jordan. Learning transferable features with deep adaptation networks. In *International conference on machine learning*, pages 97–105. PMLR, 2015.
- Eric Tzeng, Judy Hoffman, Trevor Darrell, and Kate Saenko. Simultaneous deep transfer across domains and tasks. In *Proceedings of the IEEE international conference on computer vision*, pages 4068–4076, 2015.
- Mingsheng Long, Zhangjie Cao, Jianmin Wang, and Michael I Jordan. Conditional adversarial domain adaptation. *Advances in neural information processing systems*, 31, 2018.
- ISO 24028:2020. 2020. Information technology-artificial intelligence-overview of trustworthiness in artificial intelligence. *International Organization for Standardization*, 2020.
- European Commission. Ethics guidelines for trustworthy ai. 2018. URL <https://ec.europa.eu/digital-single-market/en/news/ethics-guidelines-trustworthy-ai>.
- Bo Li, Peng Qi, Bo Liu, Shuai Di, Jingen Liu, Jiquan Pei, Jinfeng Yi, and Bowen Zhou. Trustworthy ai: From principles to practices. *arXiv preprint arXiv:2110.01167*, 2021a.
- Davinder Kaur, Suleyman Uslu, Kaley J Rittichier, and Arjan Durrresi. Trustworthy artificial intelligence: a review. *ACM Computing Surveys (CSUR)*, 55(2):1–38, 2022.
- Ian J Goodfellow, Jonathon Shlens, and Christian Szegedy. Explaining and harnessing adversarial examples. *arXiv preprint arXiv:1412.6572*, 2014.
- Karen Simonyan, Andrea Vedaldi, and Andrew Zisserman. Deep inside convolutional networks: Visualising image classification models and saliency maps. In *International Conference on Learning Representations*, 2014.
- Andrea Zunino, Sarah Adel Bargal, Riccardo Volpi, Mehrnoosh Sameki, Jianming Zhang, Stan Sclaroff, Vittorio Murino, and Kate Saenko. Explainable deep classification models for domain generalization. In *Proceedings of the IEEE/CVF Conference on Computer Vision and Pattern Recognition Workshops*, pages 3233–3242, 2021.
- Nripsuta Ani Saxena, Karen Huang, Evan DeFilippis, Goran Radanovic, David C. Parkes, and Yang Liu. How do fairness definitions fare? examining public attitudes towards algorithmic definitions of fairness. In *Proceedings of the 2019 AAAI/ACM Conference on AI, Ethics, and Society*, AIES '19, page 99–106, New York, NY, USA, 2019. Association for Computing Machinery. ISBN 9781450363242. doi:10.1145/3306618.3314248. URL <https://doi.org/10.1145/3306618.3314248>.
- Ninareh Mehrabi, Fred Morstatter, Nripsuta Saxena, Kristina Lerman, and Aram Galstyan. A survey on bias and fairness in machine learning. *ACM Computing Surveys (CSUR)*, 54(6):1–35, 2021.
- Cynthia Dwork, Moritz Hardt, Toniann Pitassi, Omer Reingold, and Richard Zemel. Fairness through awareness. In *Proceedings of the 3rd innovations in theoretical computer science conference*, pages 214–226, 2012.
- Moritz Hardt, Eric Price, and Nati Srebro. Equality of opportunity in supervised learning. *Advances in neural information processing systems*, 29, 2016.
- Matt J Kusner, Joshua Loftus, Chris Russell, and Ricardo Silva. Counterfactual fairness. *Advances in neural information processing systems*, 30, 2017.
- Haochen Liu, Yiqi Wang, Wenqi Fan, Xiaorui Liu, Yaxin Li, Shaili Jain, Yunhao Liu, Anil K Jain, and Jiliang Tang. Trustworthy ai: A computational perspective. *arXiv preprint arXiv:2107.06641*, 2021a.
- Scott Thiebes, Sebastian Lins, and Ali Sunyaev. Trustworthy artificial intelligence. *Electronic Markets*, 31(2):447–464, 2021.
- Sicheng Zhao, Xiangyu Yue, Shanghang Zhang, Bo Li, Han Zhao, Bichen Wu, Ravi Krishna, Joseph E Gonzalez, Alberto L Sangiovanni-Vincentelli, Sanjit A Seshia, et al. A review of single-source deep unsupervised visual domain adaptation. *IEEE Transactions on Neural Networks and Learning Systems*, 2020a.
- Wouter M Kouw and Marco Loog. A review of domain adaptation without target labels. *IEEE transactions on pattern analysis and machine intelligence*, 43(3):766–785, 2019.

- Yunhui Guo, Noel C Codella, Leonid Karlinsky, James V Codella, John R Smith, Kate Saenko, Tajana Rosing, and Rogerio Feris. A broader study of cross-domain few-shot learning. In *European conference on computer vision*, pages 124–141. Springer, 2020.
- Ronghang Zhu, Xiaodong Jiang, Jiasen Lu, and Sheng Li. Cross-domain graph convolutions for adversarial unsupervised domain adaptation. *IEEE Transactions on Neural Networks and Learning Systems*, 2021.
- Haoliang Li, Sinno Jialin Pan, Shiqi Wang, and Alex C Kot. Domain generalization with adversarial feature learning. In *Proceedings of the IEEE conference on computer vision and pattern recognition*, pages 5400–5409, 2018a.
- Xingchao Peng, Zijun Huang, Yizhe Zhu, and Kate Saenko. Federated adversarial domain adaptation. In *International Conference on Learning Representations*, 2020.
- Matthias Lenga, Heinrich Schulz, and Axel Saalbach. Continual learning for domain adaptation in chest x-ray classification. In *Medical Imaging with Deep Learning*, pages 413–423. PMLR, 2020.
- Boqing Gong, Yuan Shi, Fei Sha, and Kristen Grauman. Geodesic flow kernel for unsupervised domain adaptation. In *2012 IEEE conference on computer vision and pattern recognition*, pages 2066–2073. IEEE, 2012.
- Yaroslav Ganin and Victor Lempitsky. Unsupervised domain adaptation by backpropagation. In *International conference on machine learning*, pages 1180–1189. PMLR, 2015.
- Kuniaki Saito, Kohei Watanabe, Yoshitaka Ushiku, and Tatsuya Harada. Maximum classifier discrepancy for unsupervised domain adaptation. In *Proceedings of the IEEE conference on computer vision and pattern recognition*, pages 3723–3732, 2018a.
- Bo Li, Yezhen Wang, Shanghang Zhang, Dongsheng Li, Kurt Keutzer, Trevor Darrell, and Han Zhao. Learning invariant representations and risks for semi-supervised domain adaptation. In *Proceedings of the IEEE/CVF Conference on Computer Vision and Pattern Recognition*, pages 1104–1113, 2021b.
- Zhangjie Cao, Lijia Ma, Mingsheng Long, and Jianmin Wang. Partial adversarial domain adaptation. In *Proceedings of the European conference on computer vision (ECCV)*, pages 135–150, 2018a.
- Pau Panareda Busto and Juergen Gall. Open set domain adaptation. In *Proceedings of the IEEE international conference on computer vision*, pages 754–763, 2017.
- Taotao Jing, Hongfu Liu, and Zhengming Ding. Towards novel target discovery through open-set domain adaptation. In *Proceedings of the IEEE/CVF International Conference on Computer Vision*, pages 9322–9331, 2021.
- Kaichao You, Mingsheng Long, Zhangjie Cao, Jianmin Wang, and Michael I Jordan. Universal domain adaptation. In *Proceedings of the IEEE/CVF conference on computer vision and pattern recognition*, pages 2720–2729, 2019.
- Guangrui Li, Guoliang Kang, Yi Zhu, Yunchao Wei, and Yi Yang. Domain consensus clustering for universal domain adaptation. In *Proceedings of the IEEE/CVF Conference on Computer Vision and Pattern Recognition*, pages 9757–9766, 2021c.
- Lin Chen, Huaian Chen, Zhixiang Wei, Xin Jin, Xiao Tan, Yi Jin, and Enhong Chen. Reusing the task-specific classifier as a discriminator: Discriminator-free adversarial domain adaptation. In *Proceedings of the IEEE/CVF Conference on Computer Vision and Pattern Recognition*, pages 7181–7190, 2022a.
- Zhekai Du, Jingjing Li, Hongzu Su, Lei Zhu, and Ke Lu. Cross-domain gradient discrepancy minimization for unsupervised domain adaptation. In *Proceedings of the IEEE/CVF conference on computer vision and pattern recognition*, pages 3937–3946, 2021.
- Seungmin Lee, Dongwan Kim, Namil Kim, and Seong-Gyun Jeong. Drop to adapt: Learning discriminative features for unsupervised domain adaptation. In *Proceedings of the IEEE/CVF International Conference on Computer Vision*, pages 91–100, 2019.
- Baochen Sun and Kate Saenko. Deep coral: Correlation alignment for deep domain adaptation. In *European conference on computer vision*, pages 443–450. Springer, 2016.
- Wenxiao Xiao, Zhengming Ding, and Hongfu Liu. Implicit semantic response alignment for partial domain adaptation. *Advances in Neural Information Processing Systems*, 34:13820–13833, 2021.
- Xiang Gu, Xi Yu, Jian Sun, Zongben Xu, et al. Adversarial reweighting for partial domain adaptation. *Advances in Neural Information Processing Systems*, 34:14860–14872, 2021.
- Jian Liang, Yunbo Wang, Dapeng Hu, Ran He, and Jiashi Feng. A balanced and uncertainty-aware approach for partial domain adaptation. In *European Conference on Computer Vision*, pages 123–140. Springer, 2020.
- Zhangjie Cao, Mingsheng Long, Jianmin Wang, and Michael I Jordan. Partial transfer learning with selective adversarial networks. In *Proceedings of the IEEE conference on computer vision and pattern recognition*, pages 2724–2732, 2018b.

- Silvia Bucci, Mohammad Reza Loghmani, and Tatiana Tommasi. On the effectiveness of image rotation for open set domain adaptation. In *European Conference on Computer Vision*, pages 422–438. Springer, 2020.
- Yadan Luo, Zijian Wang, Zi Huang, and Mahsa Baktashmotlagh. Progressive graph learning for open-set domain adaptation. In *International Conference on Machine Learning*, pages 6468–6478. PMLR, 2020.
- Yingwei Pan, Ting Yao, Yehao Li, Chong-Wah Ngo, and Tao Mei. Exploring category-agnostic clusters for open-set domain adaptation. In *Proceedings of the IEEE/CVF Conference on Computer Vision and Pattern Recognition*, pages 13867–13875, 2020.
- Mahsa Baktashmotlagh, Masoud Faraki, Tom Drummond, and Mathieu Salzmann. Learning factorized representations for open-set domain adaptation. In *International Conference on Learning Representations*, 2019.
- Bo Fu, Zhangjie Cao, Mingsheng Long, and Jianmin Wang. Learning to detect open classes for universal domain adaptation. In *European Conference on Computer Vision*, pages 567–583. Springer, 2020.
- Kuniaki Saito and Kate Saenko. Ovanet: One-vs-all network for universal domain adaptation. In *Proceedings of the IEEE/CVF International Conference on Computer Vision*, pages 9000–9009, 2021.
- Liang Chen, Yihang Lou, Jianzhong He, Tao Bai, and Minghua Deng. Geometric anchor correspondence mining with uncertainty modeling for universal domain adaptation. In *Proceedings of the IEEE/CVF Conference on Computer Vision and Pattern Recognition*, pages 16134–16143, 2022b.
- Ronghang Zhu and Sheng Li. Self-supervised universal domain adaptation with adaptive memory separation. In *2021 IEEE International Conference on Data Mining (ICDM)*, pages 1547–1552. IEEE, 2021.
- Shai Ben-David, John Blitzer, Koby Crammer, and Fernando Pereira. Analysis of representations for domain adaptation. *Advances in neural information processing systems*, 19, 2006.
- Eric Tzeng, Judy Hoffman, Ning Zhang, Kate Saenko, and Trevor Darrell. Deep domain confusion: Maximizing for domain invariance. *arXiv preprint arXiv:1412.3474*, 2014.
- Yuchen Zhang, Tianle Liu, Mingsheng Long, and Michael Jordan. Bridging theory and algorithm for domain adaptation. In *International Conference on Machine Learning*, pages 7404–7413. PMLR, 2019.
- Mingsheng Long, Han Zhu, Jianmin Wang, and Michael I Jordan. Deep transfer learning with joint adaptation networks. In *International conference on machine learning*, pages 2208–2217. PMLR, 2017.
- Xinhong Ma, Tianzhu Zhang, and Changsheng Xu. Gcan: Graph convolutional adversarial network for unsupervised domain adaptation. In *Proceedings of the IEEE/CVF Conference on Computer Vision and Pattern Recognition*, pages 8266–8276, 2019.
- Eric Tzeng, Judy Hoffman, Kate Saenko, and Trevor Darrell. Adversarial discriminative domain adaptation. In *Proceedings of the IEEE conference on computer vision and pattern recognition*, pages 7167–7176, 2017.
- Shuhao Cui, Shuhui Wang, Junbao Zhuo, Chi Su, Qingming Huang, and Qi Tian. Gradually vanishing bridge for adversarial domain adaptation. In *Proceedings of the IEEE/CVF conference on computer vision and pattern recognition*, pages 12455–12464, 2020.
- Youshan Zhang. A survey of unsupervised domain adaptation for visual recognition. *arXiv preprint arXiv:2112.06745*, 2021.
- Arthur Gretton, Dino Sejdinovic, Heiko Strathmann, Sivaraman Balakrishnan, Massimiliano Pontil, Kenji Fukumizu, and Bharath K Sriperumbudur. Optimal kernel choice for large-scale two-sample tests. *Advances in neural information processing systems*, 25, 2012.
- Mingsheng Long, Han Zhu, Jianmin Wang, and Michael I Jordan. Unsupervised domain adaptation with residual transfer networks. *Advances in neural information processing systems*, 29, 2016.
- Hongliang Yan, Yukang Ding, Peihua Li, Qilong Wang, Yong Xu, and Wangmeng Zuo. Mind the class weight bias: Weighted maximum mean discrepancy for unsupervised domain adaptation. In *Proceedings of the IEEE conference on computer vision and pattern recognition*, pages 2272–2281, 2017.
- Junbao Zhuo, Shuhui Wang, Weigang Zhang, and Qingming Huang. Deep unsupervised convolutional domain adaptation. In *Proceedings of the 25th ACM international conference on Multimedia*, pages 261–269, 2017.
- Pietro Morerio, Jacopo Cavazza, and Vittorio Murino. Minimal-entropy correlation alignment for unsupervised deep domain adaptation. In *International Conference on Learning Representations*, 2018.
- Chao Chen, Zhihong Chen, Boyuan Jiang, and Xinyu Jin. Joint domain alignment and discriminative feature learning for unsupervised deep domain adaptation. In *Proceedings of the AAAI conference on artificial intelligence*, volume 33, pages 3296–3303, 2019a.

- Werner Zellinger, Thomas Grubinger, Edwin Lughofer, Thomas Natschläger, and Susanne Saminger-Platz. Central moment discrepancy (cmd) for domain-invariant representation learning. In *International Conference on Learning Representations*, 2017.
- Chao Chen, Zhihang Fu, Zhihong Chen, Sheng Jin, Zhaowei Cheng, Xinyu Jin, and Xian-Sheng Hua. Himm: Higher-order moment matching for unsupervised domain adaptation. In *Proceedings of the AAAI conference on artificial intelligence*, volume 34, pages 3422–3429, 2020.
- Jian Shen, Yanru Qu, Weinan Zhang, and Yong Yu. Wasserstein distance guided representation learning for domain adaptation. In *Proceedings of the AAAI Conference on Artificial Intelligence*, volume 32, 2018.
- Junguang Jiang, Ximei Wang, Mingsheng Long, and Jianmin Wang. Resource efficient domain adaptation. In *Proceedings of the 28th ACM International Conference on Multimedia*, pages 2220–2228, 2020a.
- Bent Fuglede and Flemming Topsoe. Jensen-shannon divergence and hilbert space embedding. In *International Symposium on Information Theory, 2004. ISIT 2004. Proceedings.*, page 31. IEEE, 2004.
- Yanghao Li, Naiyan Wang, Jianping Shi, Xiaodi Hou, and Jiaying Liu. Adaptive batch normalization for practical domain adaptation. *Pattern Recognition*, 80:109–117, 2018b.
- Yaroslav Ganin, Evgeniya Ustinova, Hana Ajakan, Pascal Germain, Hugo Larochelle, François Laviolette, Mario Marchand, and Victor Lempitsky. Domain-adversarial training of neural networks. *The journal of machine learning research*, 17(1):2096–2030, 2016.
- Minghao Xu, Jian Zhang, Bingbing Ni, Teng Li, Chengjie Wang, Qi Tian, and Wenjun Zhang. Adversarial domain adaptation with domain mixup. In *Proceedings of the AAAI Conference on Artificial Intelligence*, volume 34, pages 6502–6509, 2020.
- Guoqiang Wei, Cuiling Lan, Wenjun Zeng, Zhizheng Zhang, and Zhibo Chen. Toalign: Task-oriented alignment for unsupervised domain adaptation. *Advances in Neural Information Processing Systems*, 34:13834–13846, 2021.
- Kartik Ahuja, Ethan Caballero, Dinghuai Zhang, Jean-Christophe Gagnon-Audet, Yoshua Bengio, Ioannis Mitliagkas, and Irina Rish. Invariance principle meets information bottleneck for out-of-distribution generalization. *Advances in Neural Information Processing Systems*, 34:3438–3450, 2021.
- Kaiyang Zhou, Yongxin Yang, Yu Qiao, and Tao Xiang. Domain generalization with mixstyle. In *International Conference on Learning Representations*, 2021a.
- Ishaan Gulrajani and David Lopez-Paz. In search of lost domain generalization. In *International Conference on Learning Representations*, 2020.
- Shanshan Zhao, Mingming Gong, Tongliang Liu, Huan Fu, and Dacheng Tao. Domain generalization via entropy regularization. *Advances in Neural Information Processing Systems*, 33:16096–16107, 2020b.
- Qi Dou, Daniel Coelho de Castro, Konstantinos Kamnitsas, and Ben Glocker. Domain generalization via model-agnostic learning of semantic features. *Advances in Neural Information Processing Systems*, 32, 2019.
- Shiv Shankar, Vihari Piratla, Soumen Chakrabarti, Siddhartha Chaudhuri, Preethi Jyothi, and Sunita Sarawagi. Generalizing across domains via cross-gradient training. In *International Conference on Learning Representations*, 2018.
- Krikamol Muandet, David Balduzzi, and Bernhard Schölkopf. Domain generalization via invariant feature representation. In *International Conference on Machine Learning*, pages 10–18. PMLR, 2013.
- Kaiyang Zhou, Yongxin Yang, Timothy Hospedales, and Tao Xiang. Learning to generate novel domains for domain generalization. In *European conference on computer vision*, pages 561–578. Springer, 2020a.
- Fengchun Qiao, Long Zhao, and Xi Peng. Learning to learn single domain generalization. In *Proceedings of the IEEE/CVF Conference on Computer Vision and Pattern Recognition*, pages 12556–12565, 2020.
- Zijian Wang, Yadan Luo, Ruihong Qiu, Zi Huang, and Mahsa Baktashmotlagh. Learning to diversify for single domain generalization. In *Proceedings of the IEEE/CVF International Conference on Computer Vision*, pages 834–843, 2021a.
- Xinjie Fan, Qifei Wang, Junjie Ke, Feng Yang, Boqing Gong, and Mingyuan Zhou. Adversarially adaptive normalization for single domain generalization. In *Proceedings of the IEEE/CVF Conference on Computer Vision and Pattern Recognition*, pages 8208–8217, 2021.
- Lei Li, Ke Gao, Juan Cao, Ziyao Huang, Yepeng Weng, Xiaoyue Mi, Zhengze Yu, Xiaoya Li, and Boyang Xia. Progressive domain expansion network for single domain generalization. In *Proceedings of the IEEE conference on computer vision and pattern recognition*, pages 224–233, 2021d.

- Chaoqun Wan, Xu Shen, Yonggang Zhang, Zhiheng Yin, Xinmei Tian, Feng Gao, Jianqiang Huang, and Xian-Sheng Hua. Meta convolutional neural networks for single domain generalization. In *Proceedings of the IEEE/CVF Conference on Computer Vision and Pattern Recognition*, pages 4682–4691, 2022.
- Cugu Ilke, Massimiliano Mancini, Yanbei Chen, and Zeynep Akata. Attention consistency on visual corruptions for single-source domain generalization. In *Proceedings of the IEEE/CVF Conference on Computer Vision and Pattern Recognition*, 2022.
- Yang Shu, Zhangjie Cao, Chenyu Wang, Jianmin Wang, and Mingsheng Long. Open domain generalization with domain-augmented meta-learning. In *Proceedings of the IEEE/CVF Conference on Computer Vision and Pattern Recognition*, pages 9624–9633, 2021.
- Ronghang Zhu and Sheng Li. Crossmatch: Cross-classifier consistency regularization for open-set single domain generalization. In *International Conference on Learning Representations*, 2022.
- Kaiyang Zhou, Chen Change Loy, and Ziwei Liu. Semi-supervised domain generalization with stochastic stylematch. In *NeurIPS 2021 Workshop on Distribution Shifts: Connecting Methods and Applications*, 2021b.
- Ya Li, Xinmei Tian, Mingming Gong, Yajing Liu, Tongliang Liu, Kun Zhang, and Dacheng Tao. Deep domain generalization via conditional invariant adversarial networks. In *Proceedings of the European Conference on Computer Vision (ECCV)*, pages 624–639, 2018c.
- Toshihiko Matsuura and Tatsuya Harada. Domain generalization using a mixture of multiple latent domains. In *Proceedings of the AAAI Conference on Artificial Intelligence*, volume 34, pages 11749–11756, 2020.
- Chelsea Finn, Pieter Abbeel, and Sergey Levine. Model-agnostic meta-learning for fast adaptation of deep networks. In *International conference on machine learning*, pages 1126–1135. PMLR, 2017.
- Da Li, Yongxin Yang, Yi-Zhe Song, and Timothy Hospedales. Learning to generalize: Meta-learning for domain generalization. In *Proceedings of the AAAI conference on artificial intelligence*, volume 32, 2018d.
- Yogesh Balaji, Swami Sankaranarayanan, and Rama Chellappa. Metareg: Towards domain generalization using meta-regularization. *Advances in neural information processing systems*, 31, 2018.
- Yingjun Du, Jun Xu, Huan Xiong, Qiang Qiu, Xiantong Zhen, Cees GM Snoek, and Ling Shao. Learning to learn with variational information bottleneck for domain generalization. In *European Conference on Computer Vision*, pages 200–216. Springer, 2020a.
- Yingjun Du, Xiantong Zhen, Ling Shao, and Cees GM Snoek. Metanorm: Learning to normalize few-shot batches across domains. In *International Conference on Learning Representations*, 2020b.
- Connor Shorten and Taghi M Khoshgoftaar. A survey on image data augmentation for deep learning. *Journal of big data*, 6(1):1–48, 2019.
- Anirban Chakraborty, Manaar Alam, Vishal Dey, Anupam Chattopadhyay, and Debdeep Mukhopadhyay. Adversarial attacks and defences: A survey. *arXiv preprint arXiv:1810.00069*, 2018.
- Riccardo Volpi, Hongseok Namkoong, Ozan Sener, John C Duchi, Vittorio Murino, and Silvio Savarese. Generalizing to unseen domains via adversarial data augmentation. In *Advances in Neural Information Processing Systems*, 2018.
- Long Zhao, Ting Liu, Xi Peng, and Dimitris Metaxas. Maximum-entropy adversarial data augmentation for improved generalization and robustness. In *Advances in Neural Information Processing Systems*, 2020c.
- Xiangyu Yue, Yang Zhang, Sicheng Zhao, Alberto Sangiovanni-Vincentelli, Kurt Keutzer, and Boqing Gong. Domain randomization and pyramid consistency: Simulation-to-real generalization without accessing target domain data. In *Proceedings of the IEEE/CVF International Conference on Computer Vision*, pages 2100–2110, 2019.
- Kaiyang Zhou, Yongxin Yang, Timothy Hospedales, and Tao Xiang. Deep domain-adversarial image generation for domain generalisation. In *Proceedings of the AAAI Conference on Artificial Intelligence*, volume 34, pages 13025–13032, 2020b.
- Fu-En Yang, Yuan-Chia Cheng, Zu-Yun Shiao, and Yu-Chiang Frank Wang. Adversarial teacher-student representation learning for domain generalization. *Advances in Neural Information Processing Systems*, 34:19448–19460, 2021.
- Hongyi Zhang, Moustapha Cisse, Yann N Dauphin, and David Lopez-Paz. mixup: Beyond empirical risk minimization. In *International Conference on Learning Representations*, 2018a.
- Wei-Yu Chen, Yen-Cheng Liu, Zsolt Kira, Yu-Chiang Frank Wang, and Jia-Bin Huang. A closer look at few-shot classification. In *International Conference on Learning Representations*, 2019b.
- Yaqing Wang, Quanming Yao, James T Kwok, and Lionel M Ni. Generalizing from a few examples: A survey on few-shot learning. *ACM computing surveys (csur)*, 53(3):1–34, 2020a.

- Yisheng Song, Ting Wang, Subrota K Mondal, and Jyoti Prakash Sahoo. A comprehensive survey of few-shot learning: Evolution, applications, challenges, and opportunities. *arXiv preprint arXiv:2205.06743*, 2022.
- Hung-Yu Tseng, Hsin-Ying Lee, Jia-Bin Huang, and Ming-Hsuan Yang. Cross-domain few-shot classification via learned feature-wise transformation. In *IJCAI*, 2020.
- H. Brendan McMahan, Eider Moore, Daniel Ramage, Seth Hampson, and Blaise Agüera y Arcas. Communication-efficient learning of deep networks from decentralized data, 2017.
- Chen Zhang, Yu Xie, Hang Bai, Bin Yu, Weihong Li, and Yuan Gao. A survey on federated learning. *Knowledge-Based Systems*, 216:106775, 2021a.
- Fengchun Qiao and Xi Peng. Uncertainty-guided model generalization to unseen domains. In *Proceedings of the IEEE/CVF Conference on Computer Vision and Pattern Recognition*, pages 6790–6800, 2021.
- Joaquin Quinero-Candela, Masashi Sugiyama, Anton Schwaighofer, and Neil D Lawrence. *Dataset shift in machine learning*. Mit Press, 2008.
- Jin Kim, Jiyoung Lee, Jungin Park, Dongbo Min, and Kwanghoon Sohn. Self-balanced learning for domain generalization. In *2021 IEEE International Conference on Image Processing (ICIP)*, pages 779–783. IEEE, 2021a.
- Zeyi Huang, Haohan Wang, Eric P Xing, and Dong Huang. Self-challenging improves cross-domain generalization. In *European Conference on Computer Vision*, pages 124–140. Springer, 2020.
- Yuge Shi, Jeffrey Seely, Philip HS Torr, N Siddharth, Awni Hannun, Nicolas Usunier, and Gabriel Synnaeve. Gradient matching for domain generalization. *arXiv preprint arXiv:2104.09937*, 2021.
- Alexandre Rame, Corentin Dancette, and Matthieu Cord. Fishr: Invariant gradient variances for out-of-distribution generalization. In *International Conference on Machine Learning*, pages 18347–18377. PMLR, 2022.
- Renate Häußlschmid, Max von Buelow, Bastian Pfleging, and Andreas Butz. Supporting trust in autonomous driving. In *Proceedings of the 22nd international conference on intelligent user interfaces*, pages 319–329, 2017.
- Adam Ross. Are face-detection cameras racist? *Time Business*, 2010.
- Samuel G Finlayson, John D Bowers, Joichi Ito, Jonathan L Zittrain, Andrew L Beam, and Isaac S Kohane. Adversarial attacks on medical machine learning. *Science*, 363(6433):1287–1289, 2019.
- Kuniaki Saito, Yoshitaka Ushiku, and Tatsuya Harada. Asymmetric tri-training for unsupervised domain adaptation. In *International Conference on Machine Learning*, pages 2988–2997. PMLR, 2017.
- Shaoan Xie, Zibin Zheng, Liang Chen, and Chuan Chen. Learning semantic representations for unsupervised domain adaptation. In *International conference on machine learning*, pages 5423–5432. PMLR, 2018.
- Weichen Zhang, Wanli Ouyang, Wen Li, and Dong Xu. Collaborative and adversarial network for unsupervised domain adaptation. In *Proceedings of the IEEE conference on computer vision and pattern recognition*, pages 3801–3809, 2018b.
- Zhijie Deng, Yucen Luo, and Jun Zhu. Cluster alignment with a teacher for unsupervised domain adaptation. In *Proceedings of the IEEE/CVF international conference on computer vision*, pages 9944–9953, 2019.
- Chaoqi Chen, Weiping Xie, Wenbing Huang, Yu Rong, Xinghao Ding, Yue Huang, Tingyang Xu, and Junzhou Huang. Progressive feature alignment for unsupervised domain adaptation. In *Proceedings of the IEEE/CVF conference on computer vision and pattern recognition*, pages 627–636, 2019c.
- Xiang Jiang, Qicheng Lao, Stan Matwin, and Mohammad Havaei. Implicit class-conditioned domain alignment for unsupervised domain adaptation. In *International Conference on Machine Learning*, pages 4816–4827. PMLR, 2020b.
- Hong Liu, Jianmin Wang, and Mingsheng Long. Cycle self-training for domain adaptation. *Advances in Neural Information Processing Systems*, 34:22968–22981, 2021b.
- Yu Sun, Eric Tzeng, Trevor Darrell, and Alexei A Efros. Unsupervised domain adaptation through self-supervision. *arXiv preprint arXiv:1909.11825*, 2019.
- Changhwa Park, Jonghyun Lee, Jaeyoon Yoo, Minhoe Hur, and Sungroh Yoon. Joint contrastive learning for unsupervised domain adaptation. *arXiv preprint arXiv:2006.10297*, 2020.
- Kuniaki Saito, Donghyun Kim, Stan Sclaroff, and Kate Saenko. Universal domain adaptation through self supervision. *Advances in neural information processing systems*, 33:16282–16292, 2020.
- Donghyun Kim, Kuniaki Saito, Tae-Hyun Oh, Bryan A Plummer, Stan Sclaroff, and Kate Saenko. Cds: Cross-domain self-supervised pre-training. In *Proceedings of the IEEE/CVF International Conference on Computer Vision*, pages 9123–9132, 2021b.

- Kuniaki Saito, Shohei Yamamoto, Yoshitaka Ushiku, and Tatsuya Harada. Open set domain adaptation by backpropagation. In *Proceedings of the European Conference on Computer Vision (ECCV)*, pages 153–168, 2018b.
- Qianyu Feng, Guoliang Kang, Hehe Fan, and Yi Yang. Attract or distract: Exploit the margin of open set. In *Proceedings of the IEEE/CVF International Conference on Computer Vision*, pages 7990–7999, 2019.
- Hong Liu, Zhangjie Cao, Mingsheng Long, Jianmin Wang, and Qiang Yang. Separate to adapt: Open set domain adaptation via progressive separation. In *Proceedings of the IEEE/CVF Conference on Computer Vision and Pattern Recognition*, pages 2927–2936, 2019.
- Longlong Jing and Yingli Tian. Self-supervised visual feature learning with deep neural networks: A survey. *IEEE transactions on pattern analysis and machine intelligence*, 43(11):4037–4058, 2020.
- Spyros Gidaris, Praveer Singh, and Nikos Komodakis. Unsupervised representation learning by predicting image rotations. *arXiv preprint arXiv:1803.07728*, 2018.
- Mehdi Noroozi and Paolo Favaro. Unsupervised learning of visual representations by solving jigsaw puzzles. In *European conference on computer vision*, pages 69–84. Springer, 2016.
- Zhirong Wu, Yuanjun Xiong, Stella X Yu, and Dahua Lin. Unsupervised feature learning via non-parametric instance discrimination. In *Proceedings of the IEEE conference on computer vision and pattern recognition*, pages 3733–3742, 2018.
- Haoqing Wang and Zhi-Hong Deng. Cross-domain few-shot classification via adversarial task augmentation. In *IJCAI*, 2021.
- Hanwen Liang, Qiong Zhang, Peng Dai, and Juwei Lu. Boosting the generalization capability in cross-domain few-shot learning via noise-enhanced supervised autoencoder. In *Proceedings of the IEEE/CVF International Conference on Computer Vision*, pages 9424–9434, 2021.
- Zhengdong Hu, Yifan Sun, and Yi Yang. Switch to generalize: Domain-switch learning for cross-domain few-shot classification. In *International Conference on Learning Representations*, 2022.
- Debasmit Das, Sungrack Yun, and Fatih Porikli. Confess: A framework for single source cross-domain few-shot learning. In *International Conference on Learning Representations*, 2022.
- Wei-Hong Li, Xialei Liu, and Hakan Bilen. Cross-domain few-shot learning with task-specific adapters. In *Proceedings of the IEEE/CVF Conference on Computer Vision and Pattern Recognition*, pages 7161–7170, 2022.
- Liling Zhang, Xinyu Lei, Yichun Shi, Hongyu Huang, and Chao Chen. Federated learning with domain generalization. *arXiv preprint arXiv:2111.10487*, 2021b.
- Quande Liu, Cheng Chen, Jing Qin, Qi Dou, and Pheng-Ann Heng. Feddg: Federated domain generalization on medical image segmentation via episodic learning in continuous frequency space. In *Proceedings of the IEEE/CVF Conference on Computer Vision and Pattern Recognition*, pages 1013–1023, 2021c.
- Chun-Han Yao, Boqing Gong, Hang Qi, Yin Cui, Yukun Zhu, and Ming-Hsuan Yang. Federated multi-target domain adaptation. In *Proceedings of the IEEE/CVF Winter Conference on Applications of Computer Vision*, pages 1424–1433, 2022.
- Emiliano De Cristofaro. An overview of privacy in machine learning. *arXiv preprint arXiv:2005.08679*, 2020.
- Qian Wang, Zixi Li, Qin Zou, Lingchen Zhao, and Song Wang. Deep domain adaptation with differential privacy. *IEEE Transactions on Information Forensics and Security*, 15:3093–3106, 2020b.
- Kaizhong Jin, Xiang Cheng, Jiayi Yang, and Kaiyuan Shen. Differentially private correlation alignment for domain adaptation. In *IJCAI*, volume 21, pages 3649–3655, 2021.
- Weiming Zhuang, Xin Gan, Yonggang Wen, Xuesen Zhang, Shuai Zhang, and Shuai Yi. Towards unsupervised domain adaptation for deep face recognition under privacy constraints via federated learning. *arXiv preprint arXiv:2105.07606*, 2021.
- Qiyuan An, Ruijiang Li, Lin Gu, Hao Zhang, Qingyu Chen, Zhiyong Lu, Fei Wang, and Yingying Zhu. A privacy-preserving unsupervised domain adaptation framework for clinical text analysis. *arXiv preprint arXiv:2201.07317*, 2022.
- Serban Stan and Mohammad Rostami. Privacy preserving domain adaptation for semantic segmentation of medical images. *arXiv preprint arXiv:2101.00522*, 2021.
- Benyuan Sun, Hongxing Huo, Yi Yang, and Bo Bai. Partialfed: Cross-domain personalized federated learning via partial initialization. *Advances in Neural Information Processing Systems*, 34:23309–23320, 2021.
- Sashank Reddi, Zachary Charles, Manzil Zaheer, Zachary Garrett, Keith Rush, Jakub Konečný, Sanjiv Kumar, and H Brendan McMahan. Adaptive federated optimization. *arXiv preprint arXiv:2003.00295*, 2020.

- Bin Zhang, Cen Chen, and Li Wang. Privacy-preserving transfer learning via secure maximum mean discrepancy. *arXiv preprint arXiv:2009.11680*, 2020.
- Dashan Gao, Yang Liu, Anbu Huang, Ce Ju, Han Yu, and Qiang Yang. Privacy-preserving heterogeneous federated transfer learning. In *2019 IEEE International Conference on Big Data (Big Data)*, pages 2552–2559. IEEE, 2019.
- Lei Song, Chunguang Ma, Guoyin Zhang, and Yun Zhang. Privacy-preserving unsupervised domain adaptation in federated setting. *IEEE Access*, 8:143233–143240, 2020.
- Refael Kohen and Or Sheffet. Transfer learning in differential privacy’s hybrid-model. In Kamalika Chaudhuri, Stefanie Jegelka, Le Song, Csaba Szepesvari, Gang Niu, and Sivan Sabato, editors, *Proceedings of the 39th International Conference on Machine Learning*, volume 162 of *Proceedings of Machine Learning Research*, pages 11413–11429. PMLR, 17–23 Jul 2022. URL <https://proceedings.mlr.press/v162/kohen22a.html>.
- Yatong Chen, Reilly Raab, Jialu Wang, and Yang Liu. Fairness transferability subject to bounded distribution shift. *arXiv preprint arXiv:2206.00129*, 2022c.
- Amanda Coston, Karthikeyan Natesan Ramamurthy, Dennis Wei, Kush R Varshney, Skyler Speakman, Zairah Mustahsan, and Supriyo Chakraborty. Fair transfer learning with missing protected attributes. In *Proceedings of the 2019 AAAI/ACM Conference on AI, Ethics, and Society*, pages 91–98, 2019.
- Ashkan Rezaei, Anqi Liu, Omid Memarrast, and Brian D Ziebart. Robust fairness under covariate shift. In *Proceedings of the AAAI Conference on Artificial Intelligence*, volume 35, pages 9419–9427, 2021.
- Dario Amodei, Chris Olah, Jacob Steinhardt, Paul Christiano, John Schulman, and Dan Mané. Concrete problems in ai safety. *arXiv preprint arXiv:1606.06565*, 2016.
- Baochen Sun, Jiashi Feng, and Kate Saenko. Return of frustratingly easy domain adaptation. In *Proceedings of the AAAI Conference on Artificial Intelligence*, volume 30, 2016.
- Hidetoshi Shimodaira. Improving predictive inference under covariate shift by weighting the log-likelihood function. *Journal of statistical planning and inference*, 90(2):227–244, 2000.
- Masashi Sugiyama, Matthias Krauledat, and Klaus-Robert Müller. Covariate shift adaptation by importance weighted cross validation. *Journal of Machine Learning Research*, 8(5), 2007.
- Arthur Gretton, Alex Smola, Jiayuan Huang, Marcel Schmittfull, Karsten Borgwardt, and Bernhard Schölkopf. Covariate shift by kernel mean matching. *Dataset shift in machine learning*, 3(4):5, 2009.
- Bernhard Schölkopf, Dominik Janzing, Jonas Peters, Eleni Sgouritsa, Kun Zhang, and Joris Mooij. On causal and anticausal learning. *arXiv preprint arXiv:1206.6471*, 2012.
- Zachary Lipton, Yu-Xiang Wang, and Alexander Smola. Detecting and correcting for label shift with black box predictors. In Jennifer Dy and Andreas Krause, editors, *Proceedings of the 35th International Conference on Machine Learning*, volume 80 of *Proceedings of Machine Learning Research*, pages 3122–3130. PMLR, 10–15 Jul 2018. URL <https://proceedings.mlr.press/v80/lipton18a.html>.
- Kamyar Azizzadenesheli, Anqi Liu, Fanny Yang, and Animashree Anandkumar. Regularized learning for domain adaptation under label shifts. *arXiv preprint arXiv:1903.09734*, 2019.
- Luca Oneto, Michele Donini, Massimiliano Pontil, and Andreas Maurer. Learning fair and transferable representations with theoretical guarantees. In *2020 IEEE 7th International Conference on Data Science and Advanced Analytics (DSAA)*, pages 30–39. IEEE, 2020.
- Harvineet Singh, Rina Singh, Vishwali Mhasawade, and Rumi Chunara. Fairness violations and mitigation under covariate shift. In *Proceedings of the 2021 ACM Conference on Fairness, Accountability, and Transparency*, pages 3–13, 2021.
- Tongxin Wang, Zhengming Ding, Wei Shao, Haixu Tang, and Kun Huang. Towards fair cross-domain adaptation via generative learning. In *Proceedings of the IEEE/CVF Winter Conference on Applications of Computer Vision*, pages 454–463, 2021b.
- Chen Zhao, Feng Chen, and Bhavani Thuraisingham. Fairness-aware online meta-learning. In *Proceedings of the 27th ACM SIGKDD Conference on Knowledge Discovery & Data Mining*, pages 2294–2304, 2021.
- Chen Zhao, Changbin Li, Jincheng Li, and Feng Chen. Fair meta-learning for few-shot classification. In *2020 IEEE International Conference on Knowledge Graph (ICKG)*, pages 275–282. IEEE, 2020d.
- Debmalya Mandal, Samuel Deng, Suman Jana, Jeannette Wing, and Daniel J Hsu. Ensuring fairness beyond the training data. *Advances in neural information processing systems*, 33:18445–18456, 2020.

- Junyuan Hong, Zhuangdi Zhu, Shuyang Yu, Zhangyang Wang, Hiroko H. Dodge, and Jiayu Zhou. Federated adversarial debiasing for fair and transferable representations. In Feida Zhu, Beng Chin Ooi, and Chunyan Miao, editors, *KDD '21: The 27th ACM SIGKDD Conference on Knowledge Discovery and Data Mining, Virtual Event, Singapore, August 14-18, 2021*, pages 617–627. ACM, 2021. doi:10.1145/3447548.3467281. URL <https://doi.org/10.1145/3447548.3467281>.
- Muhammad Bilal Zafar, Isabel Valera, Manuel Gomez Rogriguez, and Krishna P Gummadi. Fairness constraints: Mechanisms for fair classification. In *Artificial intelligence and statistics*, pages 962–970. PMLR, 2017.
- Finale Doshi-Velez and Been Kim. Towards a rigorous science of interpretable machine learning. *arXiv preprint arXiv:1702.08608*, 2017.
- Cynthia Rudin. Stop explaining black box machine learning models for high stakes decisions and use interpretable models instead. *Nature Machine Intelligence*, 1(5):206–215, 2019.
- Diogo V Carvalho, Eduardo M Pereira, and Jaime S Cardoso. Machine learning interpretability: A survey on methods and metrics. *Electronics*, 8(8):832, 2019.
- Ričards Marcinkevičs and Julia E Vogt. Interpretability and explainability: A machine learning zoo mini-tour. *arXiv preprint arXiv:2012.01805*, 2020.
- Zachary C Lipton. The mythos of model interpretability: In machine learning, the concept of interpretability is both important and slippery. *Queue*, 16(3):31–57, 2018.
- Vidhya Kamakshi and Narayanan C Krishnan. Explainable supervised domain adaptation. *arXiv preprint arXiv:2205.09943*, 2022.
- Christoph Raab, Manuel Röder, and Frank-Michael Schleif. Domain adversarial tangent subspace alignment for explainable domain adaptation. *Neurocomputing*, 506:418–429, 2022.
- Elyor Kodirov, Tao Xiang, and Shaogang Gong. Semantic autoencoder for zero-shot learning. In *Proceedings of the IEEE conference on computer vision and pattern recognition*, pages 3174–3183, 2017.
- Mehdi Mirza and Simon Osindero. Conditional generative adversarial nets. *arXiv preprint arXiv:1411.1784*, 2014.
- Rui Gao, Xingsong Hou, Jie Qin, Jiabin Chen, Li Liu, Fan Zhu, Zhao Zhang, and Ling Shao. Zero-vae-gan: Generating unseen features for generalized and transductive zero-shot learning. *IEEE Transactions on Image Processing*, 29:3665–3680, 2020. doi:10.1109/TIP.2020.2964429.
- Jingjing Li, Mengmeng Jing, Ke Lu, Zhengming Ding, Lei Zhu, and Zi Huang. Leveraging the invariant side of generative zero-shot learning. In *Proceedings of the IEEE/CVF Conference on Computer Vision and Pattern Recognition (CVPR)*, June 2019.
- Yunzhong Hou and Liang Zheng. Visualizing adapted knowledge in domain transfer. In *Proceedings of the IEEE/CVF Conference on Computer Vision and Pattern Recognition*, pages 13824–13833, 2021.
- Xingchao Peng, Ben Usman, Neela Kaushik, Judy Hoffman, Dequan Wang, and Kate Saenko. Visda: The visual domain adaptation challenge. *arXiv preprint arXiv:1710.06924*, 2017.
- Chao Jia, Yinfei Yang, Ye Xia, Yi-Ting Chen, Zarana Parekh, Hieu Pham, Quoc Le, Yun-Hsuan Sung, Zhen Li, and Tom Duerig. Scaling up visual and vision-language representation learning with noisy text supervision. In *International Conference on Machine Learning*, pages 4904–4916. PMLR, 2021.
- Junnan Li, Ramprasaath Selvaraju, Akhilesh Gotmare, Shafiq Joty, Caiming Xiong, and Steven Chu Hong Hoi. Align before fuse: Vision and language representation learning with momentum distillation. *Advances in neural information processing systems*, 34:9694–9705, 2021e.
- Alec Radford, Jong Wook Kim, Chris Hallacy, Aditya Ramesh, Gabriel Goh, Sandhini Agarwal, Girish Sastry, Amanda Askell, Pamela Mishkin, Jack Clark, et al. Learning transferable visual models from natural language supervision. In *International Conference on Machine Learning*, pages 8748–8763. PMLR, 2021.
- Shiyu Zhao, Zhixing Zhang, Samuel Schulter, Long Zhao, Anastasis Stathopoulos, Manmohan Chandraker, Dimitris Metaxas, et al. Exploiting unlabeled data with vision and language models for object detection. *arXiv preprint arXiv:2207.08954*, 2022.
- Jingyi Xu and Hieu Le. Generating representative samples for few-shot classification. In *Proceedings of the IEEE/CVF Conference on Computer Vision and Pattern Recognition*, pages 9003–9013, 2022.
- Kai Li, Yulun Zhang, Kunpeng Li, and Yun Fu. Adversarial feature hallucination networks for few-shot learning. In *Proceedings of the IEEE/CVF Conference on Computer Vision and Pattern Recognition*, pages 13470–13479, 2020.
- Alexander Kirillov, Eric Mintun, Nikhila Ravi, Hanzi Mao, Chloe Rolland, Laura Gustafson, Tete Xiao, Spencer Whitehead, Alexander C Berg, Wan-Yen Lo, et al. Segment anything. *arXiv preprint arXiv:2304.02643*, 2023.

- Chunjiang Ge, Rui Huang, Mixue Xie, Zihang Lai, Shiji Song, Shuang Li, and Gao Huang. Domain adaptation via prompt learning. *arXiv preprint arXiv:2202.06687*, 2022.
- Giacomo Zara, Subhankar Roy, Paolo Rota, and Elisa Ricci. Autolabel: Clip-based framework for open-set video domain adaptation. In *Proceedings of the IEEE/CVF Conference on Computer Vision and Pattern Recognition*, pages 11504–11513, 2023.
- Yang Shu, Xingzhuo Guo, Jialong Wu, Ximei Wang, Jianmin Wang, and Mingsheng Long. Clipood: Generalizing clip to out-of-distributions. *arXiv preprint arXiv:2302.00864*, 2023.
- Ashish Seth, Mayur Hemani, and Chirag Agarwal. Dear: Debiasing vision-language models with additive residuals. In *Proceedings of the IEEE/CVF Conference on Computer Vision and Pattern Recognition (CVPR)*, pages 6820–6829, June 2023.
- Robert Wolfe, Yiwei Yang, Bill Howe, and Aylin Caliskan. Contrastive language-vision ai models pretrained on web-scraped multimodal data exhibit sexual objectification bias. In *Proceedings of the 2023 ACM Conference on Fairness, Accountability, and Transparency*, pages 1174–1185, 2023.