

Short text classification with machine learning in the social sciences: The case of climate change on Twitter

Karina Shyrokykh^{*}, Max Girnyk, Lisa Dellmuth

Department of Economic History and International Relations, Stockholm University, Stockholm, Sweden

^{*}karina.shyrokykh@ekohist.su.se

Abstract

To analyse large numbers of texts, social science researchers are increasingly confronting the challenge of text classification. When manual labeling is not possible and researchers have to find automatized ways to classify texts, computer science provides a useful toolbox of machine-learning methods whose performance remains understudied in the social sciences. In this article, we compare the performance of the most widely used text classifiers by applying them to a typical research scenario in social science research: a relatively small labeled dataset with infrequent occurrence of categories of interest, which is a part of a large unlabeled dataset. As an example case, we look at Twitter communication regarding climate change, a topic of increasing scholarly interest in interdisciplinary social science research. Using a novel dataset including 5,750 tweets from various international organizations regarding the highly ambiguous concept of climate change, we evaluate the performance of methods in automatically classifying tweets based on whether they are about climate change or not. In this context, we highlight two main findings. First, supervised machine-learning methods perform better than state-of-the-art lexicons, in particular as class balance increases. Second, traditional machine-learning methods, such as logistic regression and random forest, perform similarly to sophisticated deep-learning methods, whilst requiring much less training time and computational resources. The results have important implications for the analysis of short texts in social science research.

Introduction

Contemporary society is characterized by the ever-greater production of textual data. Citizens post on social media, politicians give speeches which are commented upon live, and international organizations publish reports. Such activities provide social scientists with large amounts of freely available data, enabling them to advance theories in areas such as international relations, comparative politics, media studies, and public opinion.

An example is the field of social media studies which is growing apace, as social networks have become an important aspect of people's lives. The popularity of social media platforms means that they often serve as a means of communication for citizens living in distant places, civil society organizations, business representatives, and political institutions. Such societal and political actors tend to make use of social media platforms to exchange information with the broader public. Social media has thus been defined as a social tool shaping new and unmanaged communication dynamics [8]. For example, the microblogging site Twitter is often used to package information in short messages [9–11].

In the study of short texts, researchers are often interested in categorizing or labelling texts according to their topic, relevance, or stance before carrying out further analysis. This text classification process is a key challenge for two main reasons. First, manual classification of large numbers of texts might not be feasible and automated methods might be required. However, little is known about the relative performance of such methods in the context of social science research [12]. Second, concepts in the social sciences are often ambiguous and complex. This makes it difficult for automated classifiers to categorize texts based on those.

A case in point is the topic of climate change and the risks it causes for societies and ecosystems. Over the past thirty years, framings of climate change as a policy challenge have proliferated and differentiated across sectors and scales. Political debates about “climate adaptation”, “climate mitigation”, “carbon emissions”, “climate-induced displacement”, “disaster risk reduction”, and “climate vulnerability” all illustrate the complex nature of the concept [13,14]. When classifying texts about climate change and its governance, researchers need to know how the concept of climate change is being referred to in the specific context in which it is being studied.

Several approaches to automated text classification are known. Lexicon-based methods are the most popular among social scientists [15–17]. These are based on lexicons or dictionaries of meaningful words related to a topic of interest, crafted by experts, and made available to the research community. Because such dictionaries are not always available, machine-learning (ML) algorithms are being increasingly applied. The two main categories of ML methods are supervised and unsupervised learning.

In unsupervised ML methods, the computer may cluster the words in texts around unknown categories. These clusters, and the categories they might indicate, are then interpreted by the researcher [18]. However, such approaches might not be a good choice when seeking to classify texts using labels that have been defined *a priori*. When the categories are known, supervised learning is more appropriate [19,20]. Here, researchers first manually label a smaller dataset, which is then used to train a model that identifies the specified categories in a larger dataset in an automated way. Remarkably, in recent years, a subset of these methods, deep learning (DL), has achieved human-level performance carrying out certain tasks, such as image recognition [21] and text translation [22]. DL methods have proven very efficient at handling complex non-linear relationships within data, but require large amounts of advanced computations [23].

The choice of algorithm used for ML depends principally on the task at hand, but should also be motivated by model performance. In this article, we compare several alternatives to find the best-performing algorithm. Drawing on the literature on text classification in the social sciences [12,16,24–26], we identify the most widely-used lexicon-based and supervised ML text-classification methods. We then investigate the performance of these methods in a typical social science research setting: a small labeled dataset with rare-event data. Our empirical focus is on Twitter communication about climate change, which is studied in a rapidly growing body of interdisciplinary social science research [9,27–31].

To delineate the empirical material, we make use of the Twitter communication of eight international organizations in different policy areas that are known to be central in communicating about climate change, and which are comparable in their communication as they are all part of the United Nations (UN): the Food and Agriculture Organization (FAO), the Office for the Coordination of Humanitarian Affairs (UNOCHA), the UN Development Programme (UNDP), the UN Office for Disaster Risk Reduction (UNDRR), the UN Environmental Program (UNEP), the UN International Children’s Emergency Fund (UNICEF), the UN High Commissioner for Refugees (UNHCR), and the World Health Organization (WHO) [32,33]. Not only the communication by these organizations on climate change, but also political debates, in

general, are often complex and relate to multiple policy areas at the same time. The case of climate change debates on Twitter is not unique in this regard. This means that the findings reported in this article about the use of text classification methods for this case can also be applicable to other political debates.

In this article, we make three main contributions to social science research using short texts. First, we identify relevant dictionary-based and ML methods, showing how these methods might be employed for text classification. Second, we show, in the context of small labeled datasets exhibiting class imbalance, that supervised ML methods perform better than lexicons, in particular as class balance increases. Third, we find that traditional ML methods, such as logistic regression and random forest, perform similarly to sophisticated DL methods, whilst requiring much less training time and computational resources. In all, these contributions have important implications for the use of text classifiers in the social sciences, as we elaborate in the conclusions.

The remainder of this article proceeds as follows. We begin by discussing the text classification problem that we address with automated text classification methods. We then review the most commonly used automated text classification methods. Next, we present the dataset of UN agencies' tweets and compare the performance of these methods in analysing the texts within this dataset. Finally, we summarize our findings and sketch avenues for future methodological research on text classification.

Automated text classification methods

In this section, we review existing automated text-classification methods. These methods rely on a similar workflow consisting of the collection of data and various text preprocessing techniques, which we discuss in detail in the supplementary information (SI) Appendix. We start with the lexicon-based classifier. After this, we move on to the basics of the supervised-learning approach to classification. This is followed by an overview of relevant traditional ML algorithms. Finally, we discuss advanced neural classifiers.

To describe the methods, we use the following notation. Boldface letters, such as \mathbf{a} , denote vectors. Capital boldface letters, such as \mathbf{A} , denote matrices and calligraphic letters, such as \mathcal{A} , denote sets. Estimates are denoted as \hat{a} . A vector transpose is denoted as \mathbf{a}^T . Lower indices, such as in $a_j^{(i)}$, are used to denote features, whilst upper indices denote observations. The probability distribution of a variable a is denoted as $p(a)$, and $p(a|b)$ designates the conditional probability distribution of a given b has been observed, where we deliberately do not distinguish between the random variables and their realizations.

Lexicon-based classifier

Lexicon-based classification is the most widely used approach to text classification in the social sciences. It is an unsupervised technique that is based on the filtering or labeling of texts with the help of a lexicon, or a list of relevant key terms (e.g., [15, 17]). Typically, the lexicon that is used is created by an expert in the area of interest, who has knowledge of the terminology used in context in this area.

When we use lexicon-based classification to categorize Twitter data from UN agencies, the content of tweets is tokenized (or split up into separate words) and then inspected. If one or more of the tokenized words in the tweet matches with key terms contained within the lexicon, then the tweet is classified as dealing with climate change. If no words match, then the tweet is classified as not dealing with climate change. The number of tokenized words which need to match for positive classification is a design parameter.

There are many possible ways to classify tweets with respect to the topic of climate change. However, there is no standard lexicon for this type of classification. For this article, in order to benchmark the ML methods with a reasonable classifier, we select the lexicon from [10]. It consists of the following key terms: “climate”, “climatechange”, “globalwarming”, “climaterealists” and “agw” (an abbreviation for “anthropogenic global warming”). The lexicon has a decent performance and constitutes a good baseline for our empirical performance assessment.

Supervised approach to text classification

An efficient alternative to lexicon-based classifiers is the use of supervised ML methods. This class of methods requires a manually labeled dataset \mathcal{D} (see eq. (8) and Fig. 11 in the SI Appendix). By fitting a set of N examples given in this labeled dataset, the methods obtain a model that approximates the predictor function. To fit the model, we choose a mapping $\hat{f}(\cdot)$ that minimizes the empirical *average loss*. This means that, in fitting the model, the computer attempts to minimize the difference between the predicted value and the actual observation. This can be formally expressed as:

$$L(\hat{f}) = \frac{1}{N} \sum_{i=1}^N \ell(\hat{f}(\mathbf{x}^{(i)}), y^{(i)}), \quad (1)$$

where $\ell(\hat{f}(\mathbf{x}^{(i)}), y^{(i)})$ is some chosen loss function that reflects the closeness of the model prediction $\hat{f}(\mathbf{x}^{(i)})$ for features $\mathbf{x}^{(i)}$ to the true label $y^{(i)}$ for observation i .

The model $\hat{f}(\cdot)$, being a function of the features \mathbf{x} , is also a function of a set of its own parameters $\mathbf{w} = [w_0, \dots, w_{K-1}]$. The fitting of the model is therefore carried out by searching the parameter vector \mathbf{w} that minimizes the average loss in eq. (1). This process is referred to as the training of the model. By monitoring loss $L(\hat{f})$ we can track the in-sample performance of the model, or more specifically how closely $\hat{f}_{\mathbf{w}}(\cdot)$ corresponds with the data to which it is being fitted. Because the model learns the “average” mapping from features into labels, we also expect the model to have a decent out-of-sample performance (i.e., performance on new and as-yet-unseen examples). Unfortunately, the in-sample performance of a model might not be indicative of its out-of-sample performance, as we shall see below.

If the model is too simple (i.e., it has too few parameters \mathbf{w} to capture the behavior of the data), it is unable to fit the data well and has poor in-sample performance. This is known as underfitting and is an indicator that the model is poor in general. To avoid underfitting, more complex models have to be considered. The true predictor $f(\cdot)$ can be a complicated relation between features and labels. To approximate it well, the model $\hat{f}_{\mathbf{w}}(\cdot)$ may sometimes need to be complicated and include many parameters K . For example, a linear model of this kind could be given by the following expression: $\hat{f}_{\mathbf{w}}(\mathbf{x}) = w_0 + w_1\varphi_1(\mathbf{x}) + \dots + w_{K-1}\varphi_{K-1}(\mathbf{x})$, where $\varphi_k(\mathbf{x})$ is some function of features \mathbf{x} for $k = 1, \dots, K - 1$. More complicated models (e.g., polynomials) might involve even larger numbers of parameters.

The more complex the model $\hat{f}_{\mathbf{w}}(\cdot)$, the greater the possibility to decrease the empirical loss $L(\hat{f})$ in eq. (1) and improve its in-sample performance on the given dataset \mathcal{D} . However, when the number of parameters becomes too high (relative to the number of examples N in the dataset), the training process might start confusing the noise in the data with the behavior of the feature variables. The model $\hat{f}_{\mathbf{w}}(\cdot)$ becomes tied to particular examples in the dataset and does not generalize to unseen data. That is, the in-sample performance of the model on the dataset becomes highly misleading and does not reflect its out-of-sample performance, which is known as overfitting. Thus,

a general rule for picking the model is the following: the model should be complex enough to overcome underfitting, but simple enough to not reach overfitting.

To detect overfitting, the entire dataset \mathcal{D} can be split into two parts: a training set $\mathcal{D}_{\text{train}}$ and a validation set $\mathcal{D}_{\text{valid}}$. This makes it possible to validate the out-of-sample performance of a model on the validation set. Then several models can be fitted to the training set, while also validating their out-of-sample performance using the validation set. This validation can be used as a basis for selecting a model that is complex enough to generalize to new examples and performs the best in terms of average loss among all other considered models. Following this, the best model can be retrained using the entire dataset (minus the test set), whilst also ensuring that it generalizes well when applied to as-yet-unseen data.

This approach makes it possible to validate the models and select the best one in terms of the out-of-sample loss. However, it might still not be possible to assess the actual performance of the model on as yet unseen data. This is because the process of model selection contaminates the dataset, injecting a dependency between the model and the data based on which it was selected. Hence, the validation loss is not representative of the actual performance on yet unseen data. To tackle this problem, it is necessary to make yet another partition of the dataset \mathcal{D} . That is, prior to cutting subsets $\mathcal{D}_{\text{train}}$ and $\mathcal{D}_{\text{valid}}$ from the dataset \mathcal{D} , another subset of data, called a test set $\mathcal{D}_{\text{test}}$ is withheld from the validation set. This test set is not touched during the training and validation, and is used purely for assessing the classifier’s performance on unseen data.

Traditional machine-learning classifiers

By traditional ML classifiers we mean a collection of ML algorithms which have previously been developed for classification tasks. Those are built on different principles and have different computational complexities. Their performance depends on the task at hand. In this section, we will review the most popular ML classifiers and specify the variants of the classifiers that will be used for our subsequent performance comparisons. In our analysis, we use the SciKit-Learn implementations [34] of the traditional ML algorithms, whereas for the deep neural classifiers, we use the TensorFlow implementations set up via the Keras API [35]. For each of the methods, we test the three available vectorizers, as well as optimize the number of features to maximize the classifier’s performance.

Logistic regression. Logistic regression (LR) is a classification algorithm that was invented in [36] and has been widely applied in text classification [37, 38]. The classifier models a binary random variable representing the label y given the data \mathbf{x} . The model, parameterized by weights \mathbf{w} , is given by

$$\hat{f}_{\mathbf{w}}(\mathbf{x}) = \sigma \left(w_0 + \sum_{j=1}^M w_j x_j \right), \quad (2)$$

where $\sigma(\cdot)$ is the *sigmoid function* representing the conditional probability of a positive class label given the observed features x_1, \dots, x_M .

An example of a LR classifier in action is shown in Fig 1 on exemplary synthetic data. The two classes are separated by a decision boundary, which is determined by the equal-probability line on the sigmoid-based probability map (see the black solid line on Fig 1). For all data points with probability above the decision threshold we predict $\hat{y} = 1$, while for the rest we predict $\hat{y} = 0$.

The advantages of the LR classifier are its simplicity, efficient training, interpretability and the absence of assumptions about the class distribution. The

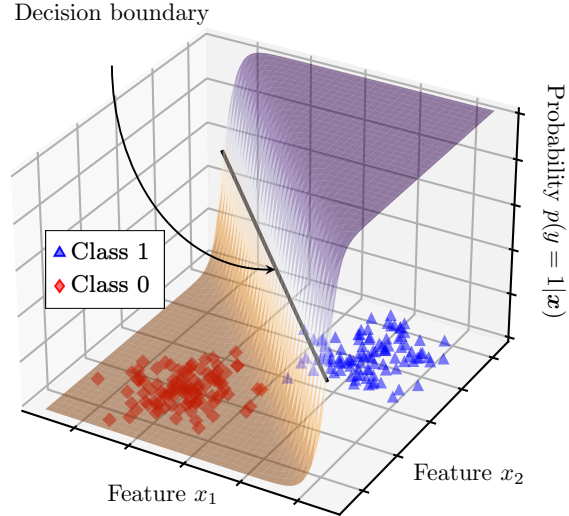

Fig 1. Illustration of a logistic regression classifier. The sigmoid-based surfaces shows the probability of the positive class given the observed data.

downsides are overfitting for a large number of features (compared to the number of observations) and sensitivity to multicollinearity among predictors.

A classifier is characterized by a set of *hyperparameters* which refer to parameters related to the model’s architecture and whose values are set before the learning process begins. This is in contrast to the model’s own *parameters* which are learned during the training. The SciKit-Learn implementation of the LR classifier has several hyperparameters, including regularization strength and maximum number of iterations. For our numerical performance assessment, these are tuned to get the best classification performance.

Support vector machines. Support vector machines (SVMs) were first proposed in [39] for linearly separable problems and later generalized to non-linear problems in [40]. SVMs have been frequently used for the classification of political texts [19, 20, 25]. They are sometimes seen to be *the* classification method to be used for short texts in social sciences [15]. Unlike the LR method which provides a probability as its output, the output of an SVM gives the direct prediction of the label.

SVM classification works by fitting a hyperplane that separates the classes and maximizes the separation margin [39]. *Support vectors* refer to those samples that are the closest to the separating hyperplane. These are the only samples that impact the SVM training, as they are most likely to cause misclassification. The margin is given by the length of the projections of the supporting vectors onto the vector of parameters \mathbf{w} which is perpendicular to the separating hyperplane. The average loss is given by eq. (1) with a hinge loss function.

The above intuition only works for cases where classes are linearly separable (see Fig 2a). In the general case, when classes may overlap in such a way that it is not possible to fit a separating hyperplane between their data points, the SVM principle can be extended to *soft margins*. This allows some observations to reside on the other side of the hyperplane [41]. Furthermore, a non-linear transformation $\phi(\cdot)$ can also be applied to the data, expanding the feature space to a higher dimension in which there may be a linearly separating hyperplane. This transformation can be done, e.g., by adding higher-order polynomial terms. However, a problem with this approach is that it

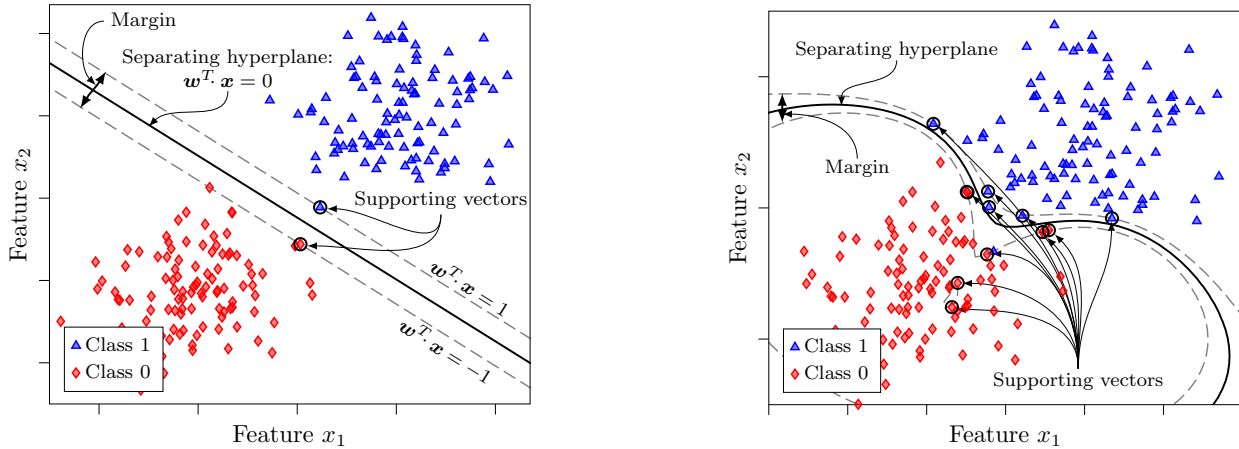

(a) Linear kernel.

(b) Radial basis function kernel.

Fig 2. Illustration of a support vector machine classifier. A hyperplane is fitted to separate the two classes and maximize the margin. Linear kernel (a) is used for the case of linearly separable classes, while radial basis function kernel is used for the case with class overlap.

might explode the computational complexity of the algorithm and lead to overfitting. In order to overcome this problem, the “kernel trick” can be invoked. Namely, by means of Lagrangian duality, the maximization of the soft margin is reformulated in terms of scalar products between data points. There are *kernel functions* $k(\cdot)$ where $k(\mathbf{x}^{(i)}, \mathbf{x}^{(j)}) = \phi(\mathbf{x}^{(i)})\phi(\mathbf{x}^{(j)})$ —e.g., polynomial, Bessel, radial basis functions (RBFs). This means that it is possible to skip computing the data transformation $\phi(\mathbf{x})$. Instead, only computing the kernel function will give the dot products in the transformed feature space for the optimization. The obtained separating hyperplane translates back to the original feature space as a non-linear decision boundary (see Fig 2b that illustrates an SVM with an RBF kernel on synthetic data).

The advantages of the SVM classifier are its operation efficiency with high-dimensional data, ability to model non-linear decision boundaries, and efficient handling of small datasets. The downsides are its sensitivity to the choice of the kernel function, high computational complexity for very large datasets, and the lack of probabilistic interpretation (unlike in LR).

Because it is known that text classification is usually linearly-separable [19], we use an SVM implementation with a linear kernel for our empirical analysis. The regularization hyperparameter, defining the “softness” of the margin, is tuned to maximize the performance of the SVM.

Random forest. Random forest (RF) classifiers [42, 43] are widely used for text classification (see, e.g., [44, 45]). The algorithm uses the so-called *decision tree* approach [46, 47]. The latter relies on the intuition that, instead of seeking a complicated mapping function $\hat{f}(\mathbf{x})$, one can partition the feature space into disjoint regions and fit a simpler model in each of those. This is done during training by recursively splitting the space of possible values for each feature at a certain threshold. For example, at a given iteration, the entire input space is split into a pair of half-spaces $\{\mathbf{x} : x_j \geq t_j\}$ and $\{\mathbf{x} : x_j < t_j\}$, where t_j is a threshold for a certain feature j . The split is done in a greedy way to minimize some loss function (e.g., misclassification error, Gini impurity, or entropy), without looking ahead at future splits. This process is repeated on each of the half-spaces recurrently until a stopping criterion is fulfilled (e.g.,

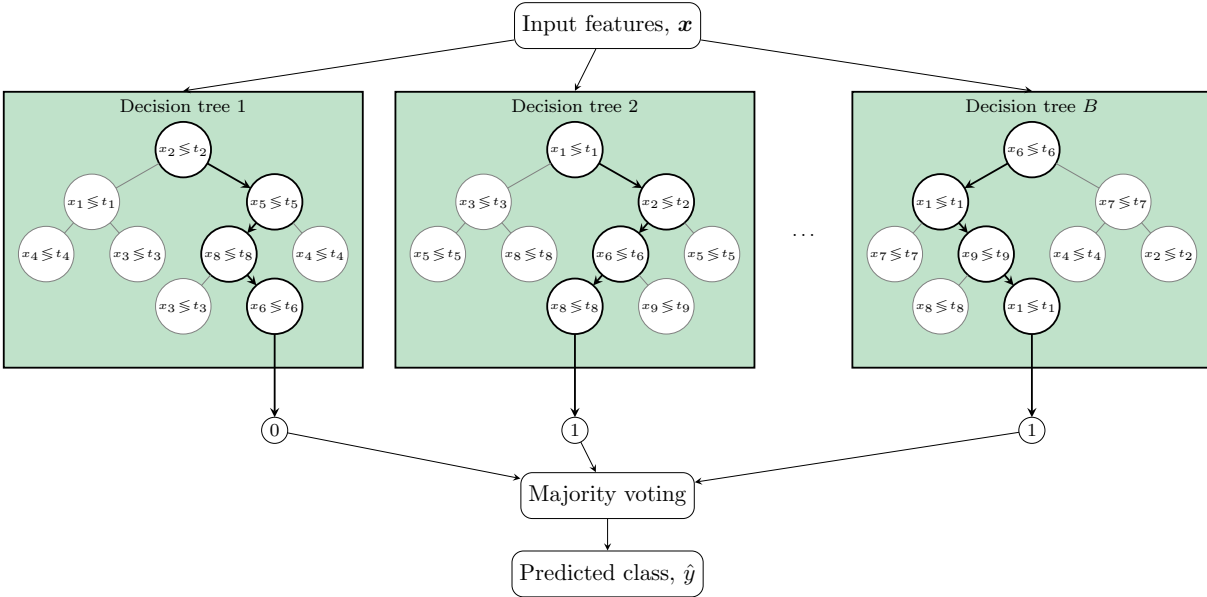

Fig 3. Illustration of a random forest classifier. The classifier consists of a collection of decision trees, each making its own prediction regarding the class of an unseen data point. The predictions are then used in a majority voting for producing the final prediction.

there is no information gain from further splits). In this way, a binary “decision tree” is constructed, which sets the thresholds for the classification of new samples.

Once the training is done, a new observation (\mathbf{x}, y) is passed through the entire decision tree. As it passes through the tree, the observation experiences a sequence of learned conditional statements (greater or lower than a threshold) for each feature x_j where $j = 1, \dots, M$. At the bottom of the tree (in a leaf node, where there is no further split), the prediction is obtained as the majority class of the data points satisfying all the conditions along the path. Illustrations of predictions with decision trees are shown as one block in Fig 3. Each circle depicts a conditional statement over a feature with respect to a threshold. The thick lines depict the paths of observations as they travel through the decision tree, satisfying all the conditions on their way. The numbers below the trees indicate the predicted classes.

An issue with decision trees is that they typically overfit training data. A widely-used way to improve generalizability is to average the predictions of a number of decision trees by means of bagging [48]. With bagging, several bootstrap training sets $\mathcal{D}_1, \mathcal{D}_2, \dots, \mathcal{D}_B$ are randomly sampled (with replacements). A decision-tree model is then fitted to each of these training sets. The predictions from the models are combined, e.g., using majority voting over decision trees in the forest. This improves the model’s generalizability by reducing the variance of the classifier, without increasing its bias. The RF approach is an extension of bagging that also randomly selects subsets of features used in each data sample. Fig 3 illustrates an RF classifier in action. A total of B decision trees are formed by considering various subsets of available features. Each decision tree makes its own prediction on its own subset of the training data. Then majority vote defines the final prediction label of the random forest classifier.

The RF classifier has the advantages of good interpretability, possibility to assess the importance of input features, and efficient avoidance of overfitting with many trees. The main disadvantage of this method is its computational complexity and slow speed with a large number of trees, which limits its applicability for real-time operation.

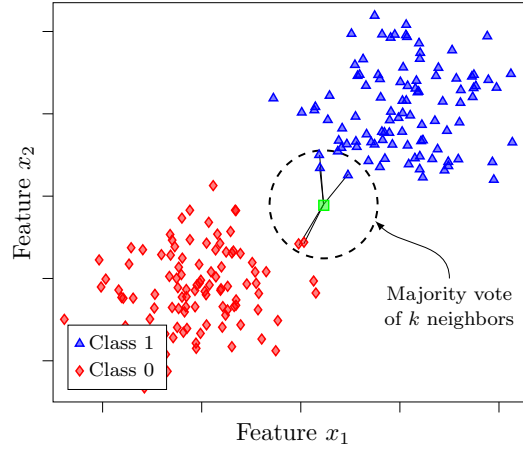

Fig 4. Illustration of a k nearest neighbors classifier. For an unseen data point, the distances towards its k nearest neighbors are computed, and the majority class gets assigned.

For our empirical analysis, we adjusted the maximum depth of the decision trees and the number of estimators in order to optimize the RF classifier’s performance.

k nearest neighbors. The k nearest neighbors (KNN) algorithm [49] is a simple classifier which has been widely used by researchers for text categorization (see, e.g., [50, 51]). In contrast to other ML algorithms, KNN does not have a training phase. Instead the training set is simply stored and the actual computation is deferred to the prediction phase. In a nutshell, given an unlabeled observation \mathbf{x} , the algorithm calculates the distances $d(\mathbf{x}, \mathbf{x}^{(i)})$ to training observations $\mathbf{x}^{(i)}$, for $i = 1, \dots, N$, in the feature space and finds k nearest neighbors to \mathbf{x} . The classes of these neighbors are used to weigh the available classes for the given observation. That is, majority voting is performed on the observations within the set of k nearest neighbors. Fig 4 illustrates a KNN classifier in action on synthetic data.

In our analysis, we use KNN with uniform weights. Because of the majority voting procedure, we set the hyperparameter k to an odd number. We sweep k and another hyperparameter, leaf size, to optimize the KNN performance.

Naïve Bayes. Naïve Bayes (NB) is a probabilistic classifier whose basic idea is to use the joint probabilities of words and categories to estimate the conditional category probabilities given a data point [52]. It has been successfully used for text classification [53, 54]. It is called “naïve” because it makes an assumption that features are conditionally independent given the label. This assumption simplifies the computations carried out by the NB classifier, when compared to a non-naïve Bayes classifier, because the NB classifier does not use word combinations as predictors.

Given an observation \mathbf{x} , such as a short text, the NB classifier assigns the most probable category \hat{y} according to

$$\hat{y} = \operatorname{argmax}_{c \in \mathcal{C}} \{p(c|\mathbf{x})\} = \operatorname{argmax}_{c \in \mathcal{C}} \{p(\mathbf{x}|c)p(c)\}, \quad (3)$$

due to Bayes’ theorem. The term $p(\mathbf{x})$ is not dependent on class c and hence skipped. Since it is difficult to estimate $p(\mathbf{x}|c)$, the naïve Bayes assumption is made. Namely, we factorize this conditional distribution as $p(\mathbf{x}|c) = p(x_1|c)p(x_2|c) \cdots p(x_M|c)$, which simplifies the computations. Moreover, $p(c)$ is estimated as the fraction of the tweets in class y in the training set. Meanwhile, $p(x_j|c)$ is estimated as the relative count of feature x_j in class c to all features, with applied Laplace smoothing.

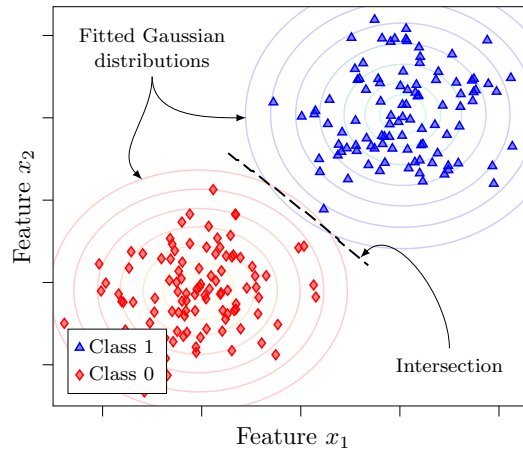

Fig 5. Illustration of a Gaussian naïve Bayes classifier. The classifier fits two Gaussian distributions (depicted with contour plots) to the categorized labels in the training set. The decision boundary is determined by the point where the probability densities for the two categories take the same value.

The advantages of the NB classifier are its simplicity, good scalability, quick training and insensitivity to irrelevant data. The disadvantages of the method are the assumption of independent predictor features and zero-probability problem for features present in the test set, but not occurring in the training set.

There are several versions of the NB classifier (e.g., Gaussian, Bernoulli, multinomial). The operation of a Gaussian NB classifier on exemplary data is demonstrated in Fig 5. Studies have reported that a multinomial mixture model shows improved performance scores on several data collections, when compared to other commonly used versions of the NB approach [53]. Because of this, for our empirical analysis, we use a multinomial NB classifier with the smoothing hyperparameter tuned to achieve the best performance.

Deep learning

Deep learning (DL) is a prominent supervised ML framework for data-driven predictive modeling. Despite its promising classification capacities, DL continues to be a much less used approach to text classification in social science, when compared to its use in such fields as computer science. A DL classifier can be thought of as a black box: data go in, decisions come out (see Fig 6a). Inside the black box there are a large number of parameters that are learned during the training. In this way, the DL model approximates a predictor function that describes the observed data. Because of the way its operations resemble those of the human brain, the broader class of methods to which DL belongs is often referred to as *artificial intelligence* (AI).

A central element of DL is the concept of an artificial *neural network* (NN) which describes the inner-workings of the DL black box. It consists of a layered structure of units conducting mathematical operations on their inputs and passing along the results (see Fig 6b). The usefulness of an NN lies in its ability to infer a function from observations. In this way, the DL model can approximate the predictor function that describes the observed data which is essential for both classification and regression tasks. The idea of an NN was first proposed by Hebb [55] as an abstraction of a real biological network of neurons in the mammalian brain.

A biological NN comprises numerous layers, each consisting of a set of neurons (see

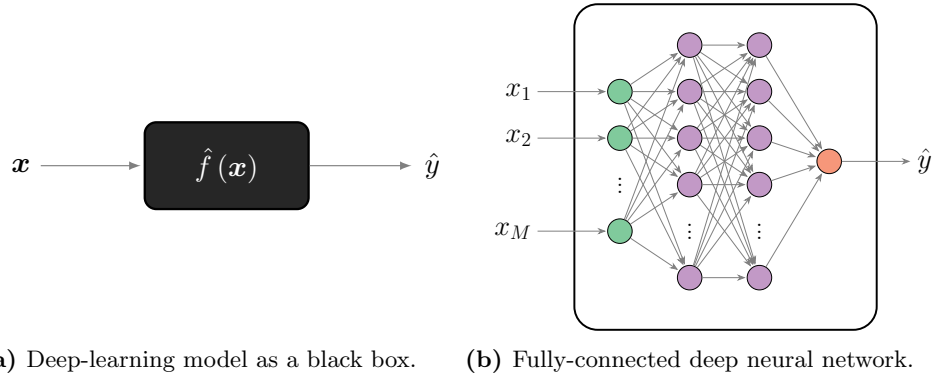

Fig 6. Illustration of a deep-learning model. The classifier provides a complex non-linear function (a) that maps an input feature vector into a predicted label. The function is learned from the training set by adjusting the parameters of a set of internal units arranged in, e.g., a layered fully-connected structure (b).

Fig. 12 in the SI appendix). Each neuron consists of *dendrites* that receive input signal pulses, a *cell body* that performs a transformation of the incoming combination of pulses, and an *axon*. The axon carries the output pulse through its trunk (covered with isolating *myelin sheaths*) to its ramified terminal, which has a set of *synapses* that connect to the dendrites of the upstream neurons in the network. The functioning of biological NNs has been studied and formalized independently in [56] and [57].

Each neuron in the network conducts a non-linear operation on the superposition of the signals received by its dendrites. These signals are weighted by the strength of the connection of its synapses of the upstream neurons. The process carried out by each neuron can therefore be modeled as a simple unit computing the weighted sum of its inputs x_1, \dots, x_M with weights $w_{j,1}, \dots, w_{j,M}$, adding a bias term b_j and applying a non-linear transformation $a(\cdot)$, called an *activation function* on the weighted sum (see Fig. 12a in the SI appendix). This unit, first proposed in [58], is referred to as an *artificial neuron* (see Fig. 12b in the SI Appendix) and it constitutes the basic building block of every NN.

Information travels through the NN from the input layer towards the output layer, passing through all neurons on its way. For binary classification tasks, the output layer consists of a single neuron that outputs the probability of the observation belonging to one of the classes. The layers in between are called *hidden layers*, as they are not directly visible from the outside of the black box. An NN is referred to as a *deep* NN if it contains two hidden layers or more. Note that NNs could equally well be adapted for regression and multi-class classification tasks. For the latter, the last layer would consist of the same number of neurons as there are classes, each having a softmax activation function and outputting the probability of belonging to that class.

It has been proven that sufficiently deep NNs are able to approximate any arbitrarily complex function $f(\cdot)$ [59]. Hence, deep NNs are particularly useful in applications where there are large amounts of data and significant computational resources available, and where manual analysis is tedious or the performance of traditional ML algorithms is unsatisfactory. In the context of text classification, NNs were first applied in [60, 61]. Only recently have they started to be used for political science research [62, 63]. There

are various neural architectures available for this task. We review the most relevant ones below.

Fully-connected neural networks. The first attempt to combine artificial neurons into a layer was made by Rosenblatt [64]. He devised the concept of a *perceptron*, a binary classifier mapping an input feature vector into one of several available classes. Formally, given a feature vector \mathbf{x} , the perceptron outputs

$$\hat{y} = a \left(\sum_{j=1}^M w_j x_j \right), \quad (4)$$

where $\{w_j\}_{j=1}^M$ is the set of weights, and $a(\cdot)$ is the activation function. This step is referred to as the *forward pass*. Given an actual training output y , the algorithm readjusts its weights according to the *gradient descent* rule

$$w_j \leftarrow w_j + \alpha (y - \hat{y}) x_j, \quad (5)$$

where α is the so-called learning rate which determines the convergence speed of loss minimization. This adjustment process is referred to as the *backward pass*. The process continues iteratively until the loss function in eq. (1) is below an acceptance threshold. If the classification problem is linearly separable, the perceptron is guaranteed to converge, and the predictor function is given by the forward pass with the learned weights w_j for all $j = 1, \dots, M$.

In a nutshell, the perceptron is an NN with a single layer. To improve its performance, Werbos [65] proposed stacking several perceptrons in consecutive layers. That study coined the concept of a multi-layer perceptron, also known as a *fully-connected* NN (FCNN). FCNNs exhibit a much better learning ability than that of the perceptron, and are the simplest form of a general class of feedforward NNs, which are neural architectures without cycles, being the most common architectures used nowadays.

An FCNN comprises a set of fully-connected (or dense) layers stacked in a line topology (see Fig 6b). Due to the presence of multiple layers, an FCNN is capable of having multiple levels of abstraction. An example is its use for facial recognition [63]. Based on an input image, the first layers of the NN capture the simple characteristics of the image, such as oriented edges or corners. Then further layers react to more complicated shapes, such as noses or eyes. Finally, the last layers are able to detect the face itself. In this way, adding extra layers to the NN can enable solutions to a lot of otherwise non-separable problems.

For a deep FCNN with P hidden layers, the input-output relation at each layer $p = 1, \dots, P + 1$ is given in a matrix form as

$$\mathbf{z}_p = a_p(\mathbf{W}_p \mathbf{z}_{p-1} + \mathbf{b}_p), \quad (6)$$

where \mathbf{z}_{p-1} and \mathbf{z}_p are vectors of the inputs and outputs of layer p , respectively. Then \mathbf{W}_p is the matrix of weights between the input and output neurons of the layer, while \mathbf{b}_p is the vector of bias terms of the given layer. Moreover, $a_p(\cdot)$ is the activation function, which is often chosen as sigmoid, hyperbolic tangent (tanh), or rectified linear unit (ReLU). Also note that here the input of the first layer is given by the input feature vector $\mathbf{z}_0 = \mathbf{x}$. Meanwhile, during the training, the output of the last layer in the network is set to the true label, i.e., $\mathbf{z}_{P+1} = y$. For a new data point, the output of the last layer provides the predicted label, i.e., $\mathbf{z}_{P+1} = \hat{y}$.

Learning for feedforward NNs is usually done by means of backpropagation. The NN parameters (i.e., weights and biases) for each layer are adjusted based on the adopted loss function which captures the difference (or error) between the observation, y , and

the output of the forward pass based on current parameters \hat{y} . The adjustment is done based on the loss function (1). This learning process is often carried out by means of the stochastic gradient descent, or any other known optimization algorithms used for learning, such as, e.g., Adam [66] and RMSProp [67]. This involves recursively propagating the gradients of the parameters backwards, from the last to the first layer, similarly to eq. (5). It is noteworthy that a mini-batch version of the gradient update is often used for more robust convergence. More concretely, the training dataset is split into small batches for which the model loss is calculated and model parameters are updated. In this way, the batch updates are computationally more efficient because they do not need the training data to be held in the computer's memory.

The advantages of FCNNs are their ability to solve complex non-linear problems, efficiency of handling large amounts of data, and quick predictions after the slow process of training is completed. Their disadvantages are slow training, poor interpretability due to their black-box nature, large numbers of parameters due to the fully-connected structure, and ignoring spatial information by accepting only vectorized inputs.

For our analysis, we have used the same architecture for all NNs under consideration, with difference in only a single layer that is particular to the given NN. For FCNN, this layer comprised a fully-connected layer with a certain number of units and a ReLU activation function. The number of neurons was optimized, alongside other hyperparameters, such as batch size, number of epochs, dropout rate, learning rate, regularization strength, embedding dimension, and maximum vocabulary length.

Convolutional neural networks. Convolutional neural networks (CNNs) refer to another subclass of feedforward NNs that are designed to capture spatial and temporal dependencies through the application of kernels. CNNs have the benefit of having a reduced number of parameters and reusable weights. The use of CNNs has become a state-of-the-art approach for the analysis of images [23]. They have also been shown to be useful for text classification [62, 68].

A CNN consists of two parts, where the first part is dedicated to feature extraction, while the second part performs the actual classification by means of an FCNN (see Fig. 13 in the SI Appendix). CNNs often start with an *embedding layer* that maps a discrete variable to a vector of continuous numbers. This is done by means of a single fully-connected layer (or a set thereof) that is either learned during the training or substituted by a pre-trained embedding. In the subsequent *convolution layer*, a set of fixed-size kernels slide through the list of embeddings, performing a convolution operation. This layer functions as the CNN's feature extractor because it learns to find local spatial features in the output of the embedding layer. The size of the kernel is the number of embeddings it sees at once multiplied by the length of an entire word embedding. The output of this layer is a set of feature maps that serve as the input for the subsequent *pooling layer*. Zero-padding is often used in this step, surrounding the input so that a feature map does not shrink.

The pooling layer then subsamples the feature maps input to it. It does this by selecting a single element from each region of the feature maps covered by its filter. The pooling layer operates on each feature map independently. This reduces the size of the feature representation, thereby effectively reducing the amount of parameters in the network, whilst preserving the most prominent features. Oftentimes, a *dropout layer* is also applied as a means to improve generalizability. By destroying the learned co-dependencies between neurons that compensate for errors from the previous layers, overfitting is prevented at a cost of longer training. The output is then fed into a fully-connected layer (or an FCNN) that conducts the classification based on the features extracted by the previous layers.

CNNs have important advantages, such as automatic feature extraction, with the possibility of using those for new tasks, and weight sharing, which leads to a reduced

number of parameters. They also have lower computational complexity than FCNNs. Their drawbacks are ignoring the position and orientation of the object in their predictions, their need for large amounts of data, and long training times.

In our performance comparisons, the CNN architecture includes an embedding layer, a dropout layer, a convolution layer and a max-pooling layer with output flattened to match a single neuron for final classification. We optimize the same hyperparameters as we tuned for the FCNN, except for the number of units. Instead, for a convolution layer we tune the number of filters and the size of the kernel.

Long short-term memory neural networks. An alternative to feedforward NNs for text classification are *recurrent neural networks* (RNNs). These are NN architectures that are comprised of a chain of repeating modules. This allows previous outputs to be used as the next inputs of the same neural layer. Because of this feature, RNNs are able to incorporate context from previous steps when dealing with a current step. They can use their internal state—also known as memory—to process sequences of inputs with variable lengths.

Unfortunately, plain versions of RNNs suffer from the vanishing gradient problem during training with backpropagation. This limits the number of passes information can make through RNNs, making them impractical. A solution to this problem, so-called *long short-term memory* (LSTM) NNs, has been proposed [69]. This is nowadays considered as one of the breakthroughs in the field of DL.

An LSTM neural network is an RNN with an LSTM cell in place of a neural layer (see Fig. 14 in the SI Appendix). This can let information pass through the cells, as well as adding/removing information while it is passing through a cell. This is regulated by various gates, each comprising a neural layer and an element-wise multiplication operation. The neural layers are equipped with a sigmoid activation function, which determines the amount of information that should pass through (between 0% and 100%). The forget gate then controls what information is kept and what is thrown away from the cell state. It comprises a neural layer with a sigmoid activation. Next, the input gate decides what information to update and what to store. This is followed by a layer with hyperbolic tangent (tanh) activation that outputs a vector of new candidate values that could be added to the cell state to update it. After this, the output gate decides what information to output, which is followed by yet another tanh gate that takes the current state as an input and multiplies the result with the output of the output gate.

The benefits of LSTN networks are their ability to handle long-term dependencies, avoidance of the vanishing-gradient problem and efficient handling of complex sequential data. The disadvantages are their need for large amounts of data and, consequently, slow training and high computational complexity, as well as their worse performance on data that is not of sequence type or contains a lot of noise.

In practice, a bi-directional model [70] is added on top of the LSTM layer. This runs separately in forward and backward directions, concatenating the predictions of both models, and sending them to an LR model. This allows one, at any point in time, to preserve information from both the past and the future. For our experiments, we optimize the same parameters as for the FCNN and CNN. There is a slight difference for the bi-directional LSTM layer, where we tune the number of units and the layer dropout rate.

Results

Next, we evaluate how well the methods discussed in the previous section perform in the task of tweet classification. For the sake of reproducibility, notebooks containing the codes are available at our repository [71].

Table 1. Summary of the collected dataset.

Organization	Account	Start date	End date	Tweets
FAO	@FAO	Jan. 2009	Dec. 2019	753
UNDP	@UNDP	Jul. 2009	Dec. 2019	1,199
UNDRR	@UNDRR	Oct. 2010	Dec. 2019	256
UNEP	@UNEP	May 2009	Dec. 2019	540
UNHCR	@Refugees	Jun. 2008	Dec. 2019	1,114
UNICEF	@UNICEF	Jul. 2009	Nov. 2019	910
UNOCHA	@UNOCHA	Jul. 2011	Jul. 2019	366
WHO	@WHO	May 2008	Dec. 2019	612
			Total	5,750

Data

For the analysis, we have collected a dataset [72] with tweets from eight Twitter accounts: @UNOCHA, @UNDP, @FAO, @WHO, @UNICEF, @UNDP, @UNDRR, and @Refugees. As elaborated in the introduction, these accounts correspond to international organizations in the UN system that deal with climate change in different policy areas [32, 33].

The tweets were downloaded and parsed via the Twitter Academic Research API. In total, the dataset contains 222,191 tweets posted by the eight UN organizations from their official accounts. This number represents the total number of tweets by these eight selected UN organizations between the beginning of their tweeting history and the end of 2019. The data comprises all tweets posted by the official accounts of the selected UN organizations, whether or not these tweets are concerned with climate change. Each tweet is considered as an observation in our dataset.

From the entire dataset, 5,750 tweets were randomly selected and labeled manually as either “climate change-related” or “not climate change-related”. Three research assistants, with training in climate governance, each labeled 2,000 tweets, working independently from each other. After this manual coding, we obtained a dataset containing 5,750 observations, see Table 1. We “lost” 250 observations due to overlaps between the three datasets produced by the research assistants, with 125 overlaps between each pair. This overlap between the datasets was used to track the agreement between the three research assistants’ coding.

The inter-coder reliability was high: on average, the coders agreed on 96% of coding decisions, which corresponds to Cohen’s $\kappa = 0.95$ [73], viz., very high inter-coder agreement [74]. Two senior researchers trained the research assistants and supervised the coding. In this manual coding, tweets about climate change mitigation and adaptation were both classified as climate change-related, i.e., assigned label “1”.

Performance assessment

For model training and performance assessment, we split the dataset into a training set (85%) and a test set (15%). To avoid data leakage, we made sure that the test set is never used until the final step of the performance evaluation. The latter was carried out by comparing the labels outputted by a classifier to the ground truth (labels marked by our research assistants).

Additionally, a part of the training set (ca. 15%) was taken as a validation set for hyperparameter tuning.

There are many known optimization algorithms used for hyperparameter tuning, e.g., Bayesian optimization [75], random search [76] and metaheuristics, such as genetic algorithm [77], simulated annealing [78], differential evolution [79] and swarm

intelligence [80]. For tuning the hyperparameters of all the methods considered herein, we have chosen to use Bayesian optimization, i.e., learning the probability distribution of the model loss conditioned on a given hyperparameter from the historical data gathered from its previous iterations. In particular, we used the tree-structured Parzen estimator [81] for our evaluations.

For the traditional ML methods, in addition to model-specific parameters, we chose the best feature vectorization approach (count vectorizer vs. TF-IDF). For DL models, the Keras tokenizer is used for the conversion of texts to sequences. We also treated the maximum number of considered features as a hyperparameter and tuned it for all models. All NNs have a common architecture. They contain the following layers: an embedding layer, a dropout layer, a layer with a certain type of units (FCNN, CNN or LSTM) and a ReLU activation function, a flattening layer (where applicable), and a fully connected layer. The actual weights and biases of the neural network are optimized with the help of the Adam optimizer [66]. The weights and biases of the NNs are initialized using the Xavier rule [82] to avoid problems with vanishing gradients.

During the training of NNs, we tracked the loss values on the training and validation sets (binary cross-entropy is used as a loss function). We picked the model that achieves the lowest validation loss. We have also used the technique of early stopping to catch the minimum of the validation loss before potential overfitting kicks in. Also, note that in all DL-based methods we utilize self-learned embeddings. An investigation of the improvements from pre-trained embeddings (see, e.g., [83, 84]) has been left for future research. Further details on the NN architectures and optimized hyperparameters can be found in our repository. Finally, it is worth noting that we run all our experiments in the Google Colab environment [85], using graphic processing units (GPUs) to accelerate the training of the DL classifiers.

Performance metrics

The choice of performance indicators is central to our analysis. For this purpose, it is necessary to consider that our dataset is imbalanced, as only ca. 9% of the tweets in the dataset are about climate change. Prediction accuracy, defined as the share of correct predictions out of all predictions made, is typically used as a performance metric for classification problems. However, for an imbalanced dataset, accuracy becomes a misleading metric. For instance, for our dataset, a simple guess that a tweet is not about climate change would yield 91% accuracy. However, this is not useful for the classification task at hand. Therefore, when choosing evaluation criteria, one has to take into account the dataset imbalance (see [86] for a discussion).

Thus, we relied on alternative performance indicators based on the so-called confusion matrix [86]. For each tweet in the test set, based on the observed features \mathbf{x} , the classifier under consideration makes a categorization \hat{y} . It classifies the tweet as either “positive” (about climate change, $\hat{y} = 1$) or “negative” (not about climate change, $\hat{y} = 0$). When we compared the predicted label \hat{y} (or a classifier’s decision) with the corresponding manually-coded label y , each observation falls into one of four sets: true negatives (with N_{TN} entries), true positives (with N_{TP} entries), false positives (with N_{FP} entries), false negatives (with N_{FN} entries)—see Fig 7.

Based on the confusion matrix, precision refers to the fraction of correctly classified examples among all the examples classified as being in a category. Meanwhile, recall refers to the fraction of correctly classified examples amongst all the examples that belong to a category in the dataset. These two metrics can have values between 0 and 1, and are computed as

$$P = \frac{N_{TP}}{N_{TP} + N_{FP}}, \quad R = \frac{N_{TP}}{N_{TP} + N_{FN}}. \quad (7)$$

		Predicted	
		Positive ($\hat{y} = 1$)	Negative ($\hat{y} = 0$)
True	Positive ($y = 1$)	True positives (N_{TP})	False negatives (N_{FN})
	Negative ($y = 0$)	False positives (N_{FP})	True negatives (N_{TN})

Fig 7. Confusion matrix containing counts of four sets of test observations. The categorization of each observation is based on the comparison of the predicted label with the true one.

The higher the value of each of these two metrics, the better the performance of the classifier. However, each of these metrics are in a trade-off against the other. Changing the classifier’s cutoff threshold (which determines which of the categories an observation falls into) can improve precision – at the expense of recall. And vice versa, improvements in recall can result in losses in precision.

Given this trade-off, the preferred metric in this article is the so-called *F1 score* as a compromise metric [86, 87] which is computed as the harmonic mean of the two aforementioned metrics, i.e., $F_1 = 2PR/(P + R)$. Various alternative metrics have been used in the literature for assessing the performance of classifiers on imbalanced datasets, e.g., ROC AUC [88], PR AUC [89] and MCC [90]. However, all of these come with their respective advantages and disadvantages. For the purpose of imbalanced classification, there is no single performance metric that can capture all aspects and tell us exactly how well a particular classifier performs. It therefore might be more informative to separately report several metrics, including precision and recall [91]. Nonetheless, in this article, we focus on the F1 score as the primary performance metric as it has been widely used in the existing literature to assess the performance of classifiers applied to imbalanced datasets.

Table 2. Classification performance of considered classifiers on the original collected dataset.

Method	Accuracy	Precision	Recall	F1 score	AUC ROC	AUC PR	MCC
LR	0.957077	0.829268	0.531250	0.647619	0.913945	0.694443	0.643570
RF	0.952436	0.716981	0.593750	0.649573	0.924048	0.685173	0.627497
Lexicon	0.957077	0.909091	0.468750	0.618557	0.732525	0.709352	0.635333
SVM	0.941995	0.606061	0.625000	0.615385	0.881050	0.641829	0.584106
LSTM	0.944316	0.642857	0.562500	0.600000	0.863565	0.591703	0.571686
FCNN	0.938515	0.593220	0.546875	0.569106	0.890488	0.615837	0.536574
NB	0.937355	0.586207	0.531250	0.557377	0.919447	0.617646	0.524492
CNN	0.935035	0.568966	0.515625	0.540984	0.891115	0.605069	0.506828
KNN	0.938515	1.000000	0.171875	0.293333	0.887287	0.598238	0.401461

Note: The results are sorted by the preferred metric, highlighted in bold font.

Performance results

Table 2 presents the performance of the ML algorithms under consideration in terms of all of the metrics discussed above given the original collected dataset. The results suggest that the best-performing approaches are the LR and RF classifiers. This finding is remarkable since these classifiers beat all the sophisticated neural classifiers at much lower computational complexity.

At the same time, we note that the performance scores are generally quite low (the best method, LR, having $F_1 \approx 65\%$ only). This is likely due to the characteristics of the dataset: imbalance and a rather small size. Also notable is the comparatively high performance of the lexicon-based classifier, which reaches $F_1 \approx 62\%$. Another

interesting result is the poor performance of the KNN algorithm (with as little as $F_1 \approx 29\%$). Finally, it is noteworthy that the advanced DL methods (FCNN, CNN and LSTM) require significantly longer training (see Table 3).

The poor classification performance of all the classifiers discussed above can likely be attributed to class imbalance in the dataset. To investigate the influence of this imbalance, we prepare a balanced dataset. To do this, we supplement our original dataset with additional tweets taken from Kaggle’s “Twitter Climate Change Sentiment Dataset” [92]. This dataset contains 43,943 tweets about climate change, manually labeled for sentiment. We are not interested in the sentiment labels, but instead take all of these tweets as ones about climate change (or labeled with “1”). We pick enough samples from the Kaggle dataset to balance out our own dataset and run the same algorithms on the new balanced dataset. We ensure that the same train/test split (i.e., 85%/15%) is maintained and the training and test sets in the original dataset remain parts of the new training and test sets, without mixing between the two. In this way, we make sure that the models see only new data during the performance evaluation stage.

Table 3. Training and execution times (in seconds) of considered classifiers on the original collected dataset.

Method	Training time [s]	Execution time [s]
NB	0.004	0.008
KNN	0.004	0.156
Lexicon	0.246	0.102
LR	0.255	0.004
SVM	0.485	0.136
RF	0.897	0.160
CNN	119	0.200
FCNN	133	0.319
LSTM	185	1.050

Note: Here, training time is the time required to train an ML model on the training set. Meanwhile, execution time is the time required to run a trained ML model on the test set for the given dataset size and split (85%/15%).

Table 4 shows how the classification algorithms perform on the new, balanced dataset. It is notable how dramatically the overall performance scores have improved when the classification methods are applied to the balanced dataset. Almost all methods now exhibit very high F1 scores, larger than 96%. The only outliers are the KNN algorithm ($F_1 \approx 90\%$) and the lexicon-based classifier ($F_1 \approx 86\%$ only). We note that the poor performance of the KNN classifier, compared to other ML algorithms, is in line with the conclusions of [93]. Meanwhile, the relative performance of the lexicon classifier was higher for the imbalanced dataset. This is likely because the proposed keywords better fit the collected dataset of UN organizations, rather than the Kaggle dataset containing all kinds of tweets.

In the new setting, the ranking of the best-performing methods has changed. The number one is now CNN with $F_1 \approx 97\%$. This indicates that CNN might be an appropriate choice for classification with balanced datasets when the best possible performance needs to be squeezed out at a cost of higher complexity. In Table 4, CNN is closely followed by the RF and LR classifiers. It is however unclear whether the differences in the performance of these classifiers is statistically significant or not. To investigate this, we conduct pair-wise McNemar’s tests [94] on every possible pair of classifiers under consideration. The corresponding methodology is described in the SI Appendix, where Fig. 16 presents the results of the statistical tests. The results show

Table 4. Classification performance of considered classifiers on the artificially balanced dataset.

Method	Accuracy	Precision	Recall	F1 score	AUC ROC	AUC PR	MCC
CNN	0.970551	0.977128	0.963659	0.970347	0.990883	0.992459	0.941192
RF	0.970551	0.992136	0.948622	0.969891	0.990770	0.993153	0.942009
LR	0.969298	0.980745	0.957393	0.968928	0.990146	0.992391	0.938863
FCNN	0.968045	0.977011	0.958647	0.967742	0.989988	0.991918	0.936256
SVM	0.968045	0.979461	0.956140	0.967660	0.988149	0.991014	0.936356
LSTM	0.961153	0.956576	0.966165	0.961347	0.986301	0.987585	0.922352
NB	0.960526	0.955390	0.966165	0.960748	0.989931	0.992488	0.921111
KNN	0.895363	0.846323	0.966165	0.902282	0.972934	0.974146	0.798776
Lexicon	0.875313	0.995041	0.754386	0.858161	0.875384	0.936210	0.773593

Note: The results are sorted by the preferred metric, highlighted in bold font.

that the performance of almost all the considered methods does not significantly differ from one another, with the exception of KNN and lexicon classifiers. That is, for scenarios where the dataset is balanced, it matters less which classification algorithm is chosen (with the exception of the KNN and lexicon classifiers).

We also sought to investigate the role of the imbalance further. To do this, we sweep the degree of balance in the dataset, adding new data from the Kaggle dataset to the training and test sets, keeping the same class proportions in both. We then compute the F1 scores for all the considered methods (see Fig 8). The dataset imbalance is captured by the balance ratio, which is defined as the ratio of positive to negative labels in the dataset. As mentioned before, for our original collected dataset, this ratio is only 0.09, hence it is heavily imbalanced. For the new completely balanced dataset, the balance ratio becomes 1.0. For each balance-ratio point in this experiment, we keep the balance between the classes the same for the training, validation and test sets.

Fig 8 shows that the performance of all classification algorithms improves with a higher balance ratio. The difference in performance diminishes as the balance ratio increases. This underpins the above observation that for nearly balanced datasets, the classification algorithms tend to perform similarly, with the exception of less capable KNN and lexicon classifiers. At the same time, the same algorithms—namely LR, RF and, to some extent, SVM and LSTM—perform best for almost all degrees of balance.

Taken together, we conclude that, for short text classification, it appears to make more sense to turn to traditional ML algorithms instead of computationally-demanding deep neural architectures. The benefits of the latter are marginal, while their training requires significantly more time. In contrast, DL methods might be more useful when datasets are balanced and of a large scale, and when extensive computational resources are available.

Conclusions

In this article, we have compared the performance of various methods for the automated categorization of short texts in a small and imbalanced dataset. This classification task frequently occurs in social science research when researchers analyse short texts such as sentences, paragraphs, tweets, or article abstracts. Moreover, it is often the case that the concepts that are being examined are only present in a small proportion of the overall dataset. We have reviewed the most widely used text classifiers and compared their performance in this challenging setting. For this purpose, we have used a novel dataset on the communication about climate change on Twitter by eight international organizations operating in the UN system in different policy areas.

The article has made three main contributions to social science research engaging in

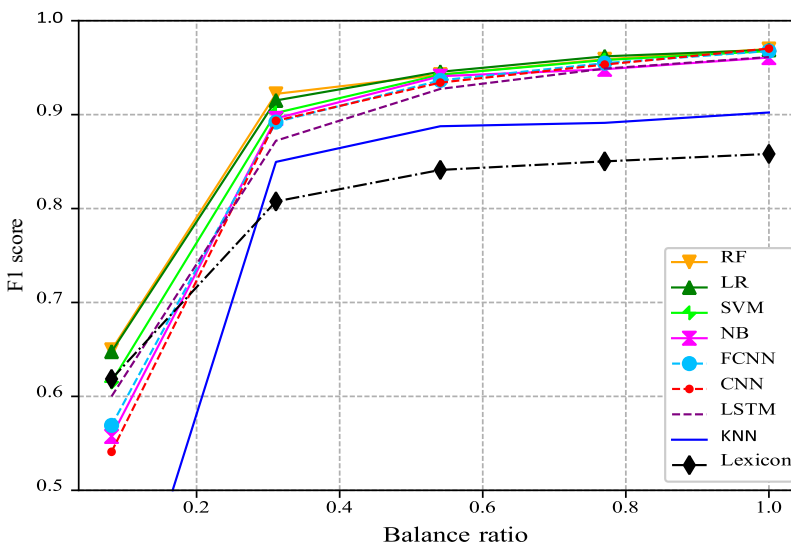

Fig 8. F1 score vs. balance ratio for the classifiers under consideration. Solid lines show the performance of traditional ML methods, dashed lines show that of DL-based approaches, while the dash-dotted line illustrates the performance of the unsupervised lexicon-based classifier.

automated text classification. First, it has provided a systematic overview of central text classification methods, including lexicons, traditional machine learning, and deep learning. In doing so, the article helps to reduce the entry barrier for researchers seeking to use such methods in their work. Computer science is a vast field and it is important to filter for the state-of-the-art methods that can be used to advance various fields in the social sciences.

Second, the performance assessment suggests that among the aforementioned classification methods, lexicons are clearly outperformed by machine-learning methods. However, it is important to take into account the role of class imbalance. For instance, the use of a convolutional neural network was found to be the best choice when there is a balanced dataset, but for an imbalanced dataset, its performance is rather mediocre. We therefore recommend that researchers balance their datasets, for instance by complementing the dataset with more labeled data and by applying techniques of active learning [95]. Classifiers trained on balanced datasets are shown to perform much better.

Third, we have shown that simple traditional supervised classifiers, such as random forest and logistic regression, tend to perform as well as advanced neural networks in the aforementioned settings, while having much lower computational complexity. It therefore seems warranted to use deep learning only in those cases where there is a lot of high-quality data and extensive computational resources.

All told, future research should study the application of advanced methods, such as pretrained embeddings [96] and transformers [97], as well as novel hyperparameter tuning techniques [80], in combination with the methods discussed in this article. In the rapidly changing textual data landscape, the need for a systematic understanding of how the prominent methods for coding political texts perform is becoming ever more pressing.

Supporting information appendix

Classification of textual data: The workflow

In the following, we introduce the problem of automated text classification and present the corresponding workflow. We will also discuss various feature extraction methods, as well as text preprocessing techniques.

The general text classification problem can be formally described as follows. Given a text \mathcal{T} find a label y from a set of available classes \mathcal{C} that best associates with \mathcal{T} . Because we do not know the true label y , we can only make the best guess \hat{y} which, hopefully, matches y . The corresponding workflow is depicted in Fig. 9.



Fig 9. Text classification workflow.

In general, a text can refer to a whole document, or to a section, paragraph, or sentence within a document. In this article, we are analysing Twitter data and so we work with tweets. On the Twitter microblogging platform, tweets are the name given to short texts that may contain one or several sentences of anything up to 280 characters (or 140 characters prior to 2012, when for English language the limit was increased due to commonly observed cramming). Generally speaking, tweet texts are considered to be unstructured data. This might be acceptable for a human analyst, who would recognize the context and the meaning in each text and would usually have little or no difficulty with labeling them. However, the unstructured nature of tweets is problematic for an automated text classifier. This requires the conversion of a text into a structured numerical representation. For instance, a lexicon-based classifier needs to tokenize the text, or to break it up into separate words. After the text is tokenized, the classifier can then match the words within it with the key terms from the lexicon. More advanced ML-based classifiers need to map the text into a feature space and create a numerical representation of it, \mathbf{x} , which is referred to as a *feature vector*. A feature here is referred to as a measurable property of the observed phenomenon, acting as an input to a classifier.

The above process is referred to as *feature extraction* (see Fig. 10). The process starts with downloading the tweets which are then parsed for text. This is followed by text preprocessing [87] of the text extracted from each tweet. Tweets contain considerable noise including redundant content, such as special characters, web links, infrequent terms, and technical words that have been preserved by Twitter. These elements do not contribute to the quality of the text analysis, while increasing its complexity. The text from tweets should therefore be cleaned, making it all lower case, filtering out non-alphabet characters such as hashtag symbols, and removing web links and user names. The punctuation in the tweets also needs to be removed, along with any outstanding single characters and multiple spaces. Short words and stopwords (e.g., such words as “an” and “the”) are filtered out, and all the words are further stemmed or lemmatized. Depending on the method of text classification and the type of input it requires, this is then followed by text tokenization and vectorization.

The tokenization and vectorization of texts are typically carried out by means of so-called *bag-of-words* representation. With this approach, all of the input texts are split into separate words. Then, a *count vectorizer* [2] is applied. This vectorizer counts the frequency of appearance of all of the separate words. It therefore forms a global vocabulary of unique words and corresponding per-tweet vectors of indicators of the word presence. These vectors contain the positions of the entries in the global

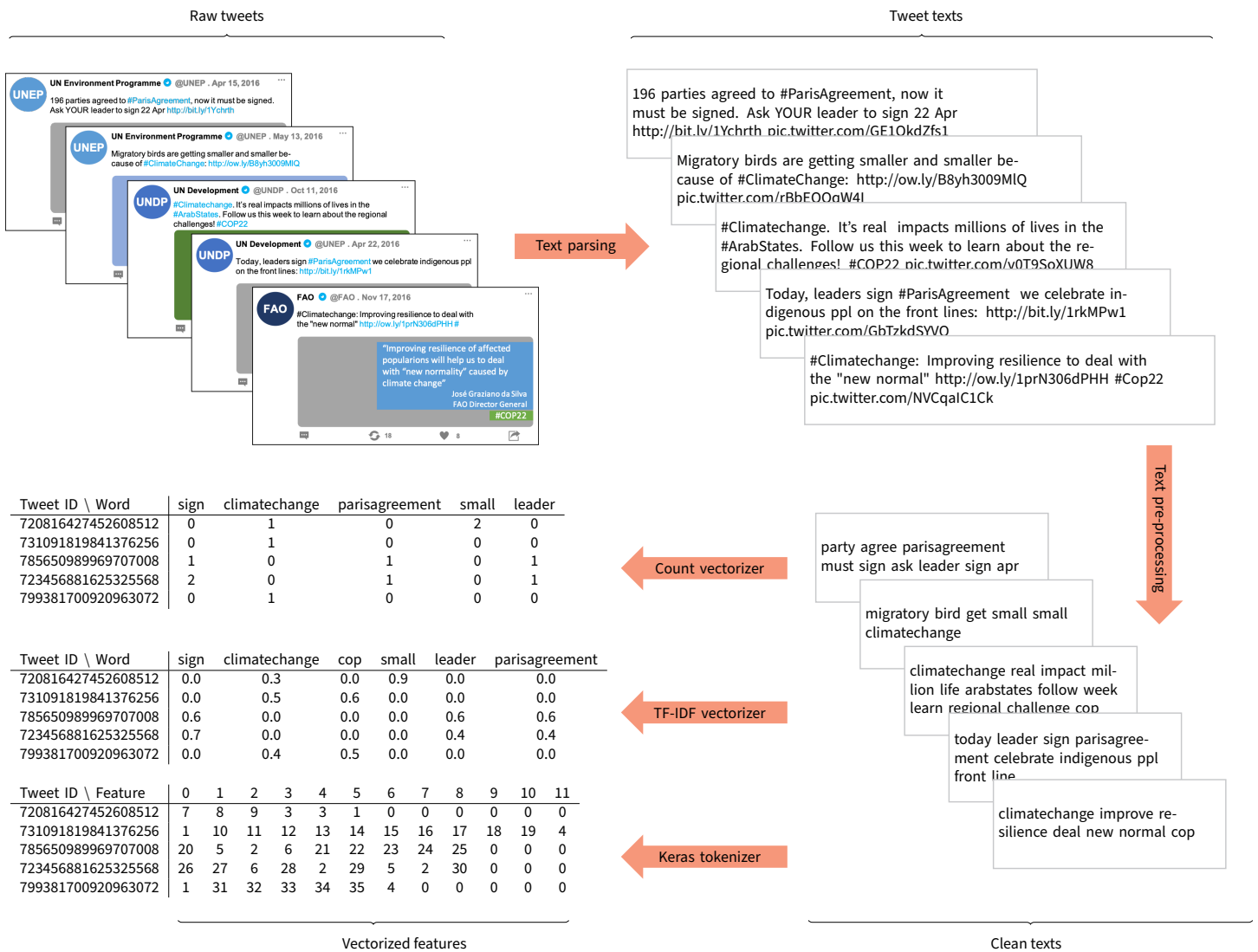

Fig 10. Feature extraction workflow: from raw tweets to numerical vector representations.

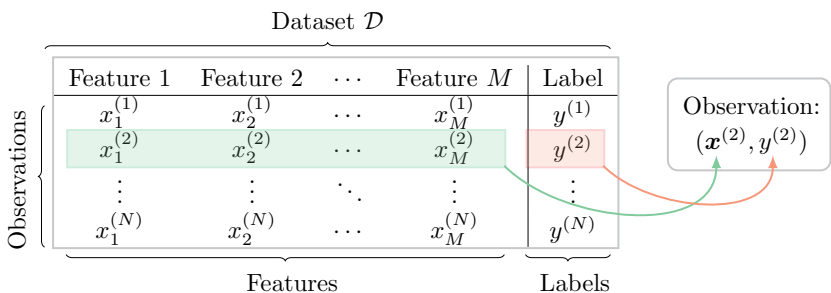

Fig 11. Dataset format: a set of observations, each consisting of a feature vector and a label.

vocabulary. Because of this, they can then be used as input features for a supervised ML model. However, such a (sparse) representation of words might contain lots of noise in terms of frequent common words which provide very little information.

To compensate for this noise in the representation, *TF-IDF weighting* [3] is often used. This technique involves rewarding each word based on its frequency of appearance within a tweet and penalizing it based on an inverse of its frequency across all the tweets in the dataset. In this way, weighting highlights important (frequent) words within the tweet that are also unique within the entire dataset. A computationally efficient implementation of the above two mechanisms, suitable for advanced neural classifiers, is the *Keras tokenizer* [4].

Another alternative representation that is often used is based on *word embeddings* [5, see Chapter 6]. The aforementioned bag-of-words approach creates features that are independent from each other. That is, each new unique word found to occur within the texts adds a new entry to the vocabulary (i.e., the list of words found in all the texts) and therefore adds a new dimension to the latent space. This is problematic for more sophisticated supervised ML methods such as deep neural networks because the more dimensions the feature vector has, the higher the computational complexity of the model. A denser (and fixed-sized) representation is therefore preferable. In this denser representation, the features are embedded into a lower-dimensional space. A denser representation can also capture the context of a word within a sentence and how it is similar to other words. This representation is obtained by multiplying the sparse feature vector with a matrix, where the number of rows corresponds to the desired feature dimensionality. Embedding matrices are obtained by means of a neural network learning from a training set. Nevertheless, we will not investigate the influence of word embeddings here, as this aspect is beyond the scope of the current article.

After the vectorization, we obtain a dataset in a matrix format: columns represent features, with the last column designating the label, while rows represent observations,

$$\mathcal{D} = \{(\mathbf{x}^{(i)}, y^{(i)})\}_{i=1}^N, \quad (8)$$

where i is an observation index that corresponds to a single tweet from the N tweets in the dataset. Each observation is a tuple $(\mathbf{x}^{(i)}, y^{(i)})$, where $\mathbf{x}^{(i)}$ is a feature vector consisting of M features and $y^{(i)}$ is a (scalar) label (see Fig. 11 for an illustration). Without loss of generality, we consider the labels to be binary variables, coded as “1” if a given tweet is about climate change, and “0” otherwise. Generalization to multiple classes can be done by means of the so-called *one-hot* encoding, transforming the problem into binary classification for each class vs. all the other classes.

Formally, the classification task is defined as learning an unknown *predictor function*

$f(\cdot)$, that maps a feature vector \mathbf{x} into a predicted label y for any possible observation (\mathbf{x}, y) . However, there may not be a perfect mapping between the features and the labels. This is especially considering the fact that the features are chosen by an analyst and are therefore subject to omitted variables. The latter results in variations in the data due to these “unmodeled” variables which manifest themselves as seemingly random noise. In practice, therefore, a *good* mapping $\hat{f}(\cdot)$ (or one that approximates the true predictor function $f(\cdot)$)—referred to as a model or a hypothesis—is obtained by means of an automated classifier instead. The classifier then outputs a predicted label $\hat{y} = \hat{f}(\mathbf{x}^{(i)})$ which should potentially match the true label y most of the time.

Illustrations of deep learning

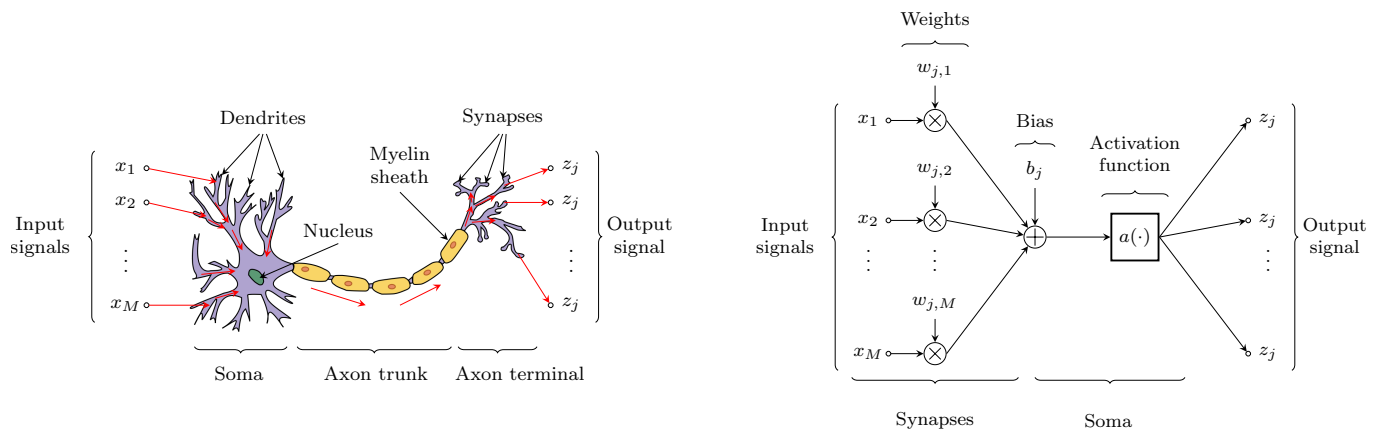

(a) Biological neuron.

(b) Artificial neuron.

Fig 12. Modeling of a neuron. A biological neuron (a) processing an aggregation of its input signals is modeled as an artificial neuron (b) weighing its inputs, adding a bias and applying a non-linear activation function.

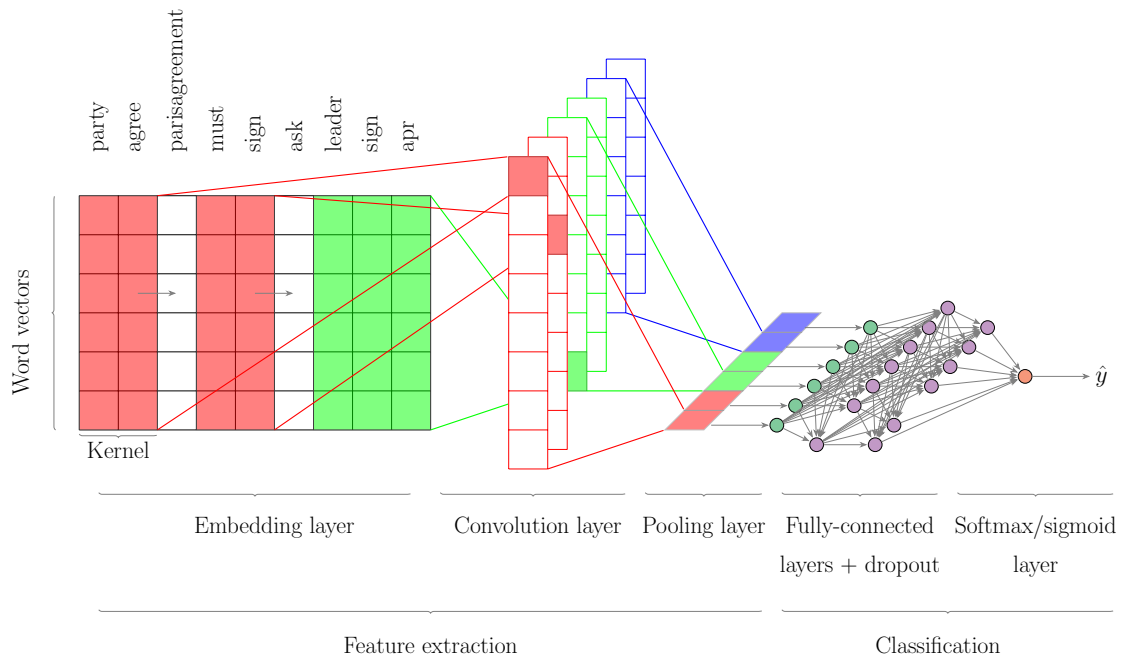

Fig 13. An illustrative architecture of a CNN. A kernel is convolved over the output of the embedding layer to produce feature maps. These are convolved by a kernel and pooled to provide features for the subsequent classification by a fully-connected layer.

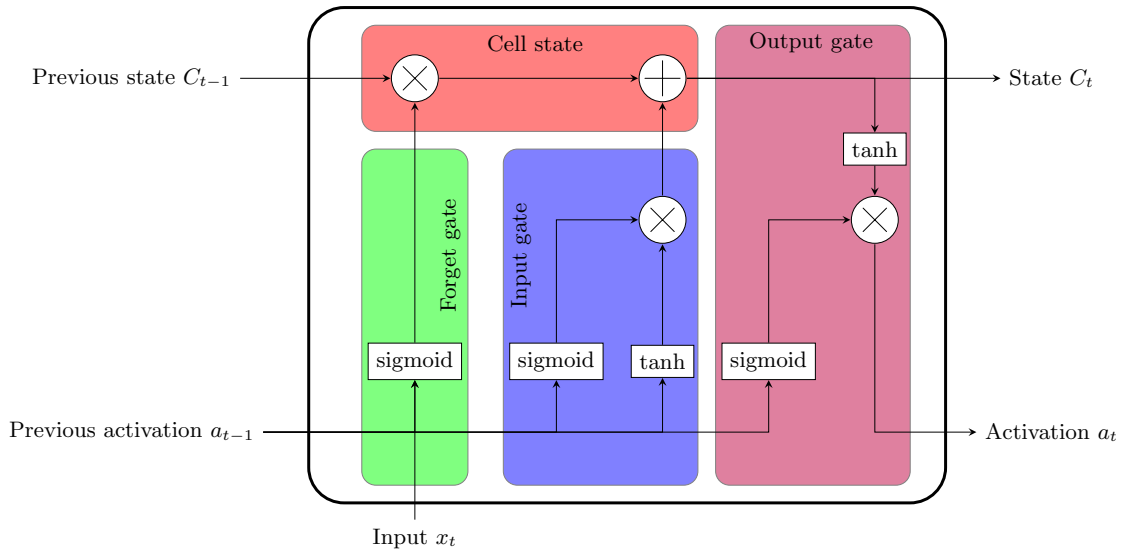

Fig 14. Architecture of an LSTM neural cell. Its state is represented by a horizontal line running from time instance $t - 1$ to time instance t . The cell input is concatenated with the previous instance's activation and goes through the cell's gates to result in the output cell state and activation function at the current instance.

Statistical tests

In this section, we present the statistical validation of the performance results of the classification methods under consideration. To that end, we investigate whether the

		Model 2	
		Classified incorrectly	Classified correctly
Model 1	Classified incorrectly	Both incorrect ($N_{0,0}$)	Model 1 incorrect ($N_{0,1}$)
	Classified correctly	Model 2 incorrect ($N_{1,0}$)	Both correct ($N_{1,1}$)

Fig 15. Contingency table containing counts of four sets of test observations. The categorization of each observation is based on the comparison of the label predicted by the two models with the true one.

differences in performance are statistically significant by relying on the widely-used non-parametric McNemar test [94]. This is done by conducting the pair-wise comparison of the classifiers in terms of the contingency table [7] which assesses their performance vs. the true labels on the test set. The contingency table is illustrated in Fig. 15, showing that the observations in the test set fall into one of four sets: misclassified by both models (with $N_{0,0}$ entries), misclassified by model 1, but not model 2 (with $N_{0,1}$ entries), misclassified by model 2, but not model 1 (with $N_{1,0}$ entries), classified correctly by both models (with $N_{1,1}$ entries). Based on this, McNemar’s test checks for the null hypothesis of the marginal homogeneity of the outcomes, viz., $N_{0,1} = N_{1,0}$. To verify the letter, for each pair of classifiers, we compute the McNemar statistic

$$\mu = \frac{(N_{0,1} - N_{1,0})^2}{N_{0,1} + N_{1,0}}. \quad (9)$$

Given a sufficiently large number of discordants in the test set (i.e., observations falling into $N_{0,1}$ and $N_{1,0}$), this statistic follows the χ^2 distribution with a single degree of freedom. If μ is statistically significant, we have grounds to reject the null hypothesis and conclude that the marginal proportions in the contingency table are statistically different, viz. the two classifiers have different error rates. Otherwise, we conclude that the null hypothesis cannot be rejected and the two models have very similar performance.

The results of McNemar’s test on the test set withheld from the balanced dataset are presented in Fig. 16. Namely, Fig 16a shows the McNemar test statistic of the pair-wise comparison of the model performance. Meanwhile, Fig. 16b shows the corresponding p-values. Setting the significance value to $p = 0.05$, we get from the χ^2 distribution density the corresponding threshold on the test statistic of $\mu^* = 3.841$. Using these values, we can make a decision whether to reject or accept the null hypothesis in every pair-wise performance comparison. The results of such comparison are presented in Fig. 16c.

It can be clearly seen from the figure that for most classifier pairs we cannot reject the null hypothesis, meaning that the difference in their performance is not statistically significant. There are two exceptions—lexicon-based classifier and KNN—whose performance significantly differs from the rest of the models. This is in line with our observations from Table 4 in the manuscript which clearly shows that lexicon and KNN are performance outliers, exhibiting the lowest F1 score among the tested models. These observations underpin our conclusion that the more balanced the data, the better is the performance of the classifiers, regardless of whether those are representatives of traditional machine learning or deep learning. The difference in their performance becomes negligible, with the exception of the two aforementioned less capable classifiers.

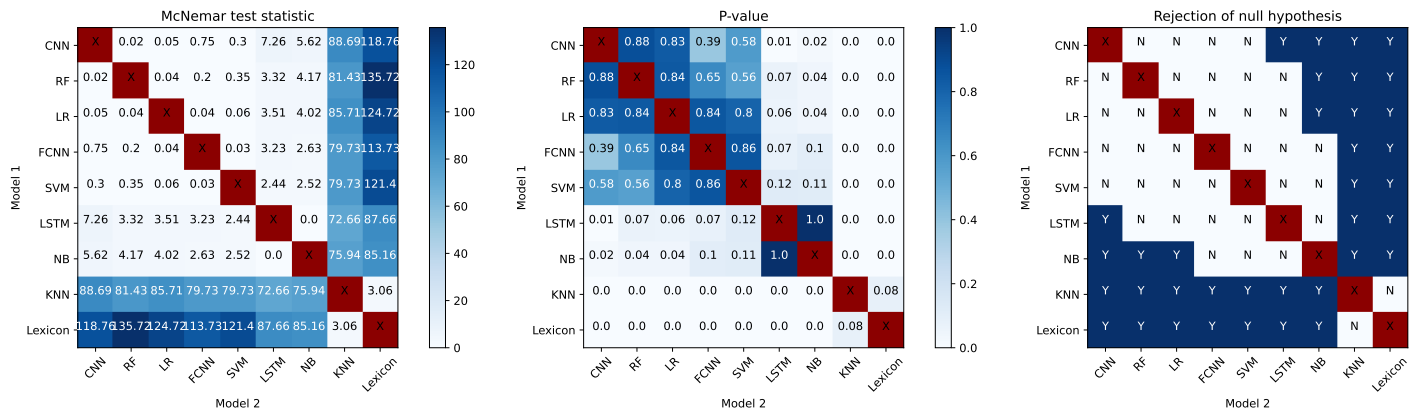

(a) McNemar test statistics. (b) P-values. (c) Null hypothesis rejection decisions.

Fig 16. Results of McNemar’s test. Pair-wise test statistics (a) and corresponding p-values (b) provide a basis for a decision on the rejection of the null hypothesis of statistically similar performance of the classifiers under consideration (c).

Acknowledgments

The authors would like to thank to Hugo de Vos, Nicholas Olczak, and Maryna Povitkina for helpful comments. Earlier version of this paper was presented at the 2021 Annual Meeting of the American Political Science Association.

References

1. Denny MJ, Spirling A. Text preprocessing for unsupervised learning: Why it matters, when it misleads, and what to do about it. *Political Analysis*. 2018;26(2):168–189.
2. du Boisberranger J, den Bossche JV, Estève L, Fan TJ, Gramfort A, Grisel O, et al.. Count Vectorizer; 2023. https://scikit-learn.org/stable/modules/generated/sklearn.feature_extraction.text.CountVectorizer.html, accessed Apr. 2023.
3. Salton G, Buckley C. Term-weighting approaches in automatic text retrieval. *Information processing & management*. 1988;24(5):513–523.
4. Chollet F, Görner M, Gulli A, Moolayil J, Heaton J, Allaire JJ, et al.. TensorFlow Tokenizer; 2023. https://www.tensorflow.org/api_docs/python/tf/keras/preprocessing/text/Tokenizer, accessed Apr. 2023.
5. Jurafsky D. *Speech & language processing*. Pearson Education India; 2000.
6. McNemar Q. Note on the sampling error of the difference between correlated proportions or percentages. *Psychometrika*. 1947;12(2):153–157.
7. Pearson K. On the theory of contingency and its relation to association and normal correlation. In: *Drapers’ Company research memoirs*. Biometric series. vol. 1. Dalau and Co.; 1904.
8. Shirky C. *Here Comes Everybody: The Power of Organizing without Organizations*. Penguin Books; 2008.

9. Cody EM, Reagan AJ, Mitchell L, Dodds PS, Danforth CM. Climate change sentiment on Twitter: An unsolicited public opinion poll. *PLoS ONE*. 2015;10(8):e0136092.
10. Williams HT, McMurray JR, Kurz T, Lambert FH. Network analysis reveals open forums and echo chambers in social media discussions of climate change. *Global Environmental Change*. 2015;32:126–138.
11. Ecker-Ehrhardt M. IO public communication going digital? Understanding social media adoption and use in times of politicization. In: Bjola C, Zaiotti R, editors. *Digital Diplomacy and International Organisations Autonomy, Legitimacy and Contestation*. 1st ed. Routledge; 2020. p. 21–51.
12. Sebők M, Kacsuk Z. The multiclass classification of newspaper articles with machine learning: The hybrid binary snowball approach. *Political Analysis*. 2021;29(2):236—249.
13. Hall N. What is adaptation to climate change? Epistemic ambiguity in the climate finance system. *International Environmental Agreements*. 2017;17:37–53.
14. Persson Å. Global adaptation governance: An emerging but contested domain. *WIREs Climate Change*. 2019;10(6):1–18.
15. Taboada M, Brooke J, Tofiloski M, Voll K, Stede M. Lexicon-based methods for sentiment analysis. *Computational Linguistics*. 2011;37(2):267–307.
16. He Y, Saif H, Wei Z, Wong KF. Quantising opinions for political tweets analysis. In: *Proceedings of the 8th International Conference on Language Resources and Evaluation*; 2012. p. 3901–3906.
17. Cameletti M, Fabris S, Schlosser S, Toninelli D. Dictionary-based classification of tweets about environment. *Journal of Mathematics and Statistical Science*. 2020;8(1).
18. Blei DM, Ng AY, Jordan MI. Latent Dirichlet allocation. *Journal of Machine Learning Research*. 2003;3(Jan):993–1022.
19. Joachims T. Text categorization with support vector machines: Learning with many relevant features. In: *Proceedings of the European Conference on Machine Learning*; 1998. p. 137–142.
20. D’Orazio V, Landis ST, Palmer G, Schrodtt P. Separating the wheat from the chaff: Applications of automated document classification using support vector machines. *Political Analysis*. 2014;22(2):224–242.
21. He K, Zhang X, Ren S, Sun J. Delving deep into rectifiers: Surpassing human-level performance on ImageNet classification. In: *Proceedings of the IEEE International Conference on Computer Vision*; 2015. p. 1026–1034.
22. Popel M, Tomkova M, Tomek J, Kaiser L, Uszkoreit J, Bojar O, et al. Transforming machine translation: A deep learning system reaches news translation quality comparable to human professionals. *Nature Communications*. 2020;11(1):1–15.
23. LeCun Y, Bengio Y, Hinton G. Deep learning. *Nature*. 2015;521(7553):436–444.
24. Grimmer J, Stewart BM. Text as data: The promise and pitfalls of automatic content analysis methods for political texts. *Political Analysis*. 2013;21(3):267–297.

25. Boussalis C, Coan TG, Holman MR. Climate change communication from cities in the USA. *Climatic Change*. 2018;149(2):173–187.
26. Greene KT, Park B, Colaresi M. Machine learning human rights and wrongs: How the successes and failures of supervised learning algorithms can inform the debate about information effects. *Political Analysis*. 2019;27(2):223–230.
27. Effrosynidis D, Sylaios G, Arampatzis A. Exploring climate change on Twitter using seven aspects: Stance, sentiment, aggressiveness, temperature, gender, topics, and disasters. *PLoS ONE*. 2022;17(9).
28. Falkenberg M, Galeazzi A, Torricelli M, Di Marco N, Larosa F, Sas M, et al. Growing polarization around climate change on social media. *Nature Climate Change*. 2022;12:1114—1121.
29. Jang SM, Hart PS. Polarized frames on “climate change” and “global warming” across countries and states: Evidence from Twitter big data. *Global Environmental Change*. 2015;32:11–17.
30. Toupin R, Millerand F, Larivière V. Who tweets climate change papers? Investigating publics of research through users’ descriptions. *PLoS ONE*. 2022;17(6):e0268999.
31. Walter S, Lörcher I, Brüggemann M. Scientific networks on Twitter: Analyzing scientists’ interactions in the climate change debate. *Public Understanding of Science*. 2019;28(6):696–712.
32. Kural E, Dellmuth L, Gustafsson MT. International organizations and climate change adaptation: A new dataset for the social scientific study of adaptation, 1990–2017. *PLoS ONE*. 2021;16(9):e0257101.
33. Dellmuth L, Gustafsson MT. Global adaptation governance: How intergovernmental organizations mainstream climate change adaptation. *Climate Policy*. 2021;21(7):1–16.
34. Pedregosa F, Varoquaux G, Gramfort A, Michel V, Thirion B, Grisel O, et al. SciKit-Learn: Machine learning in Python. *Journal of Machine Learning Research*. 2011;12:2825–2830.
35. Chollet F, Görner M, Gulli A, Moolayil J, Heaton J, Allaire JJ, et al.. Keras; 2015. <https://keras.io>, accessed Apr. 2023.
36. Verhulst PF. Notice sur la loi que la population suit dans son accroissement. *Correspondance Mathématique et Physique*. 1838;10:113–126.
37. Zhang T, Oles FJ. Text categorization based on regularized linear classification methods. *Information Retrieval*. 2001;4(1):5–31.
38. Aseervatham S, Gaussier É, Antoniadis A, Burlet M, Denneulin Y. Logistic regression and text classification. In: Gaussier É, Yvon F, editors. *Textual Information Access: Statistical Model*. John Wiley & Sons; 2012. p. 61–84.
39. Cortes C, Vapnik V. Support-vector networks. *Machine Learning*. 1995;20(3):273–297.
40. Schölkopf B, Smola AJ, Bach F. *Learning with Kernels: Support Vector Machines, Regularization, Optimization, and Beyond*. MIT Press; 2002.

41. Lampert CH. Kernel Methods in Computer Vision. Now Publishers Inc.; 2009.
42. Kwok SW, Carter C. Multiple decision trees. In: Shchter RD, Levitt TS, Kanal LN, Lemmer JF, editors. Machine Intelligence and Pattern Recognition. vol. 9. Elsevier; 1990. p. 327–335.
43. Breiman L. Random forests. Machine Learning. 2001;45(1):5–32.
44. Bouaziz A, Dartigues-Pallez C, da Costa Pereira C, Precioso F, Lloret P. Short text classification using semantic random forest. In: Proceedings of the International Conference on Data Warehousing and Knowledge Discovery; 2014. p. 288–299.
45. Wu Q, Ye Y, Zhang H, Ng MK, Ho SS. ForesTexter: An efficient random forest algorithm for imbalanced text categorization. Knowledge-Based Systems. 2014;67:105–116.
46. Quinlan JR. Induction of decision trees. Machine Learning. 1986;1(1):81–106.
47. Apté C, Damerau F, Weiss SM. Automated learning of decision rules for text categorization. ACM Transactions on Information Systems. 1994;12(3):233–251.
48. Breiman L. Bagging predictors. Machine Learning. 1996;24(2):123–140.
49. Weiss SM, Kulikowski CA. Computer Systems that Learn: Classification and Prediction Methods from Statistics, Neural Nets, Machine Learning, and Expert Systems. Morgan Kaufmann Publishers Inc.; 1991.
50. Masand B, Linoff G, Waltz D. Classifying news stories using memory based reasoning. In: Proceedings of the 15th Annual International ACM Conference on Research and Development in Information Retrieval; 1992. p. 59–65.
51. Trstenjak B, Mikac S, Donko D. KNN with TF-IDF based framework for text categorization. Procedia Engineering. 2014;69:1356–1364.
52. Domingos P, Pazzani M. Beyond independence: Conditions for the optimality of the simple Bayesian classifier. In: Proceedings of the 13th International Conference on Machine Learning; 1996. p. 105–112.
53. McCallum A, Nigam K. A comparison of event models for naive bayes text classification. In: Proceedings of the AAAI Workshop on Learning for Text Categorization. vol. 752; 1998. p. 41–48.
54. Tang B, Kay S, He H. Toward optimal feature selection in naive Bayes for text categorization. IEEE Transactions on Knowledge and Data Engineering. 2016;28(9):2508–2521.
55. Hebb DO. The Organization of Behavior. New York: Wiley; 1949.
56. Bain A. Mind and Body: The Theories of their Relation. vol. 4. Appleton; 1873.
57. James W, Burkhardt F, Bowers F, Skrupskelis IK. The Principles of Psychology. vol. 1. Macmillan London; 1890.
58. McCulloch WS, Pitts W. A logical calculus of the ideas immanent in nervous activity. The Bulletin of Mathematical Biophysics. 1943;5(4):115–133.
59. Cybenko G. Approximation by superpositions of a sigmoidal function. Mathematics of Control, Signals and Systems. 1989;2(4):303–314.

60. Wiener E, Pedersen JO, Weigend AS, et al. A neural network approach to topic spotting. In: Proceedings of the 4th Annual Symposium on Document Analysis and Information Retrieval. vol. 317; 1995. p. 332.
61. Ng HT, Goh WB, Low KL. Feature selection, perceptron learning, and a usability case study for text categorization. In: Proceedings of the 20th International ACM Conference on Research and Development in Information Retrieval; 1997. p. 67–73.
62. Kim Y. Convolutional Neural Networks for Sentence Classification. In: Proceedings of the Conference on Empirical Methods in Natural Language Processing; 2014. p. 1–6.
63. Torres M, Cantú F. Learning to see: Convolutional neural networks for the analysis of social science data. *Political Analysis*. 2021; p. 1–19.
64. Rosenblatt F. The perceptron: A probabilistic model for information storage and organization in the brain. *Psychological review*. 1958;65(6):386.
65. Werbos P. Beyond regression: New tools for prediction and analysis in the behavioral sciences. Ph.D. thesis, Harvard University; 1974.
66. Kingma DP, Ba J. Adam: A method for stochastic optimization. In: Proceedings of the 3rd International Conference on Learning Representations; 2015. p. 1–15.
67. Hinton G, Srivastava N, Swersky K. Coursera course on neural networks for machine learning: Lecture 6a—Overview of mini-batch gradient descent; 2012.
68. Collobert R, Weston J. A unified architecture for natural language processing: Deep neural networks with multitask learning. In: Proceedings of the 25th International Conference on Machine learning; 2008. p. 160–167.
69. Hochreiter S, Schmidhuber J. Long short-term memory. *Neural Computation*. 1997;9(8):1735–1780.
70. Graves A, Schmidhuber J. Framewise phoneme classification with bidirectional LSTM and other neural network architectures. *Neural Networks*. 2005;18(5-6):602–610.
71. Shyrokykh K. Replication codes and data for: Short Text Classification with Machine Learning in the Social Sciences; 2023.
https://github.com/shikarina/short_text_classification.
72. Shyrokykh K, Girnyk M, Dellmuth L. A Dataset of UN Agencies' Public Communication about Climate Change on Twitter; 2023.
<https://zenodo.org/record/7633599/#.Y-1bTS8w1qs>, accessed Apr. 2023.
73. Cohen J. A coefficient of agreement for nominal scales. *Educational and Psychological Measurement*. 1960;20(1):37–46.
74. Landis JR, Koch GG. The measurement of observer agreement for categorical data. *Biometrics*. 1977; p. 159–174.
75. Mockus J. The application of Bayesian methods for seeking the extremum. *Towards global optimization*. 1998;2:117.
76. Bergstra J, Bengio Y. Random search for hyper-parameter optimization. *Journal of Machine Learning Research*. 2012;13(2).

77. Aszemi NM, Dominic P. Hyperparameter optimization in convolutional neural network using genetic algorithms. *International Journal of Advanced Computer Science and Applications*. 2019;10(6).
78. Fischetti M, Stringher M. Embedding simulated annealing within stochastic gradient descent. In: *Proceedings of the 4th International Conference on Optimization and Learning*; 2021. p. 3–13.
79. Schmidt M, Safarani S, Gastinger J, Jacobs T, Nicolas S, Schülke A. On the performance of differential evolution for hyperparameter tuning. In: *Proceedings of the International Joint Conference on Neural Networks*; 2019. p. 1–8.
80. Bacanin N, Zivkovic M, Stoean C, Antonijevic M, Janicijevic S, Sarac M, et al. Application of natural language processing and machine learning boosted with Swarm Intelligence for spam email filtering. *Mathematics*. 2022;10(22):4173.
81. Bergstra J, Bardenet R, Bengio Y, Kégl B. Algorithms for hyper-parameter optimization. *Advances in Neural Information Processing Systems*. 2011;24.
82. Glorot X, Bengio Y. Understanding the difficulty of training deep feedforward neural networks. In: *Proceedings of the 13th International Conference on Artificial Intelligence and Statistics*; 2010. p. 249–256.
83. Jang B, Kim I, Kim JW. Word2vec convolutional neural networks for classification of news articles and tweets. *PLoS ONE*. 2019;14(8):e0220976.
84. Nandanwar AK, Choudhary J. Semantic features with contextual knowledge-based web page categorization using the GloVe model and stacked BiLSTM. *Symmetry*. 2021;13(10):1772.
85. Google. Colaboratory; 2023. <https://research.google.com/colaboratory>, verified Apr. 2023.
86. He H, Garcia EA. Learning from imbalanced data. *IEEE Transactions on Knowledge and Data Engineering*. 2009;21(9):1263–1284.
87. Denny MJ, Spirling A. Text preprocessing for unsupervised learning: Why it matters, when it misleads, and what to do about it. *Political Analysis*. 2018;26(2):168–189.
88. Fawcett T. ROC graphs: Notes and practical considerations for researchers. *Machine Learning*. 2004;31(1):1–38.
89. Davis J, Goadrich M. The relationship between precision-recall and ROC curves. In: *Proceedings of the 23rd International Conference on Machine learning*; 2006. p. 233–240.
90. Matthews BW. Comparison of the predicted and observed secondary structure of T4 phage lysozyme. *Biochimica et Biophysica Acta (BBA)-Protein Structure*. 1975;405(2):442–451.
91. Lipton ZC, Elkan C, Naryanaswamy B. Optimal thresholding of classifiers to maximize F1 measure. In: *Proceedings of the Joint European Conference on Machine Learning and Knowledge Discovery in Databases*; 2014. p. 225–239.
92. Kaggle. Twitter Climate Change Sentiment Dataset; 2019. <https://www.kaggle.com/datasets/edqian/twitter-climate-change-sentiment-dataset>, accessed Nov. 2021.

93. Hartmann J, Huppertz J, Schamp C, Heitmann M. Comparing automated text classification methods. *International Journal of Research in Marketing*. 2019;36(1):20–38.
94. McNemar Q. Note on the sampling error of the difference between correlated proportions or percentages. *Psychometrika*. 1947;12(2):153–157.
95. Miller B, Linder F, Mebane WR. Active learning approaches for labeling text: Review and assessment of the performance of active learning approaches. *Political Analysis*. 2020;28(4):532–551.
96. Mikolov T, Chen K, Corrado G, Dean J. Efficient estimation of word representations in vector space. In: *Proceedings of International Conference on Learning Representations*; 2013. p. 1–12.
97. Devlin J, Chang MW, Lee K, Toutanova K. BERT: Pre-training of deep bidirectional transformers for language understanding. In: *Proceedings of the Conference of the North American Chapter of the Association for Computational Linguistics: Human Language Technologies*; 2019. p. 4171–4186.