

Affine \mathcal{W} -algebras and Miura maps from 3d $\mathcal{N} = 4$ non-Abelian quiver gauge theories

Ioana Coman,¹ Myungbo Shim,^{2,1,3} Masahito Yamazaki,^{1,4} and Yehao Zhou¹

¹*Kavli Institute for the Physics and Mathematics of the Universe (WPI),
University of Tokyo, Kashiwa, Chiba 277-8583, Japan*

²*Yau Mathematical Sciences Center, Tsinghua University
Beijing 100084, China*

³*Department of Physics and Research Institute of Basic Science, Kyung Hee University,
Seoul 02447, Korea*

⁴*Trans-Scale Quantum Science Institute, University of Tokyo, Tokyo 113-0033, Japan*
*E-mail: ioana.coman@ipmu.jp, mbshim@tsinghua.edu.cn,
masahito.yamazaki@ipmu.jp, yehao.zhou@ipmu.jp*

ABSTRACT: We study Vertex Operator Algebras (VOAs) obtained from the H-twist of 3d $\mathcal{N} = 4$ linear quiver gauge theories. We find that H-twisted VOAs can be regarded as the “chiralization” of the extended Higgs branch: many of the ingredients of the Higgs branch are naturally “uplifted” into the VOAs, while conversely the Higgs branch can be recovered as the associated variety of the VOA. We also discuss the connection of our VOA with affine \mathcal{W} -algebras. For example, we construct an explicit homomorphism from an affine \mathcal{W} -algebra $\mathcal{W}^{-n+1}(\mathfrak{gl}_n, f_{\min})$ into the H-twisted VOA for $T_{[1^n]}^{[2, 1^{n-2}]}[\mathrm{SU}(n)]$ theories. Motivated by the relation with affine \mathcal{W} -algebras, we introduce a reduction procedure for the quiver diagram, and use this to give an algorithm to systematically construct novel free-field realizations for VOAs associated with general linear quivers.

Contents

1	Introduction	1
2	VOAs from 3d $\mathcal{N} = 4$ SQFTs	3
2.1	Setup	3
2.2	VOA as BRST reduction	5
2.3	BRST reduction	6
3	General quiver gauge theories	7
3.1	Matter contents from quiver diagrams	7
3.2	Higgs branches as quiver varieties	8
4	Linear quiver gauge theories and $T_\rho^\sigma[\text{SU}(N)]$ Theories	10
4.1	Some notations	10
4.2	Pair of partitions	11
4.3	Partitions and quiver data	12
4.4	Higgs and Coulomb branches	13
4.5	Higgs branch from paths on the linear quivers	14
4.6	Balanced linear quivers	14
5	VOAs associated to quivers	15
5.1	Vertex algebra before BRST reduction	15
5.2	Boundary anomaly cancellation and BRST reduction	16
5.3	Conformal vector	20
6	Boundary VOAs for linear quivers gauge theories	21
6.1	Anomaly cancellation on the boundary	21
6.2	VOA before BRST reduction	22
6.3	BRST reduction	24
6.4	Match of central charges with \mathcal{W} -algebras	27
7	Higgs branch and associated varieties	28
7.1	Zhu's algebra and associated varieties	29
7.2	Conjecture	30
8	Vertex algebra for $T_{[1^n]}^{[2,1^{n-2}]}[\text{SU}(n)]$	30
8.1	BRST reduction	31
8.2	Map from \mathcal{W} -algebra to boundary VOA	32
8.3	Check of OPE Relations for $n = 4$	35
9	Vertex algebra for $T_{[1^{2n}]}^{[n,n]}[\text{SU}(2n)]$	37
9.1	General n	37
9.2	$n = 2$	38

10 Localization of quiver vertex algebra	39
10.1 Sheaf of BRST cohomologies	43
10.2 Vertex superalgebra of global sections	45
10.3 Associated variety	47
11 Quiver reduction	48
11.1 The building block	50
11.2 Reduction for vertex (super)algebras associated to quivers	53
11.3 Generalization	59
12 Examples of quiver reductions	62
12.1 Example: $T[\mathrm{SU}(n)]$ quiver	62
12.2 Example: $T_{[1^4]}^{[2^2]}[\mathrm{SU}(4)]$ quiver	64
12.3 Example: $T_{[1^n]}^{[2, 1^{n-2}]}[\mathrm{SU}(n)]$ quiver	68
12.4 Example: $T_{[1^n]}^{[n-1, 1]}[\mathrm{SU}(n)]$ quiver	72
12.5 Expectation in the case of $T_{[1^n]}^\sigma[\mathrm{SU}(n)]$ quiver	75
13 Comparison with 4d $\mathcal{N} = 2$ VOAs	77
14 Discussions	79
A Glossary	80
B BRST reduction	81
B.1 Some BRST exact elements	82
C Proof of (6.24)	83
D Minimal generators in terms of paths	84
E Criteria for two Virasoro operators coincide	86

1 Introduction

Over decades we have encountered a plethora of mathematical structures in the study of quantum field theories (QFTs), and this has facilitated a successful interplay between physics and mathematics.

Vertex operator algebras (VOAs) [1–3] provide one of the mathematical characterizations of the chiral half of two-dimensional conformal field theories (CFTs) [4]. In addition, they often arise as the boundary edge modes of three-dimensional topological quantum field theories (TQFTs), as exemplified in the celebrated correspondence between the boundary current algebras and the bulk three-dimensional pure Chern-Simons theories [5, 6]. Since

we can obtain TQFTs from the topological twists of the supersymmetric QFTs (SQFTs) [7], it is natural to ask what VOAs we obtain when we consider the boundary theories of the topological twists of three-dimensional SQFTs.

In this paper we study VOAs arising on the boundary of topological H-twists (also known as A-twists) of 3d $\mathcal{N} = 4$ theories [8] (see also [9]). While there have been discussions of the boundary VOAs in the literature (see e.g. [10–15]), previous studies have either been limited to Abelian gauge theories or case-by-case analysis of non-Abelian gauge theories. It is therefore left as an important problem to systematically analyze boundary VOAs for general non-Abelian gauge theories.

The goal of this paper is to study VOAs associated with non-Abelian quiver gauge theories. We explicitly write down detailed procedures for defining the H-twisted VOA for a general quiver gauge theory, as a BRST reduction of a product VOA, and then study the BRST cohomologies.

One of the important ideas of this paper is that the H-twisted VOA should be regarded as a “chiralization” of the (extended) quiver variety, which is the (extended) Higgs branch of the theory. Many of the concepts of the geometry of the Higgs branch are naturally “uplifted” into the VOAs, and conversely the Higgs branch can be recovered as the “associated variety” of the VOA; see table 1 for a dictionary, which will be explained in detail in the rest of this paper.

Geometry of Quiver Variety	Vertex Operator Algebra
$\text{Hom}(V, V)$	X and Y
$\text{Hom}(W, V)$	I and J
Cartan Matrix of Q	OPE coefficients of BRST invariant currents
(Extended) moment maps	BRST invariant currents
Relaxed balance condition	Anomaly cancellation with extra Fermi multiplets
Paths on Q	BRST closed operators up to Fermion bilinears
Path algebra on Q	OPE structures of BRST cohomology
Quiver reduction of Q	Miura map

Table 1: Correspondences between the geometry of quiver varieties and VOAs.

We also discuss the connection of our VOAs with affine \mathcal{W} -algebras. We construct an explicit homomorphism from affine \mathcal{W} -algebras into the H-twisted VOA for $T_{[1^n]}^\sigma[\text{SU}(N)]$ theories for some choices of σ and N given in table 2. Motivated by the relation with affine \mathcal{W} -algebras, we introduce a reduction procedure implementing free-field realizations of the VOAs, thereby recovering many of the results on Miura transformations from the literature while also obtaining many new results in greater generality.

While this paper is written primarily in physics language, many of our contents have bearings in mathematics and require new mathematical results. For this reason, we prepared a companion paper [16] written in the style of mathematics, and comment on the relations between the two manuscripts where appropriate.¹

¹A similar discussion for a particular example of the Jordan quiver has recently appeared in [17].

(σ, N)	\mathcal{W} -algebra
$([2, 1^{N-2}], N)$	$\mathcal{W}^{-N+1}(\mathfrak{gl}_N, f_{\min})$
$([2^2], 4)$	$\mathcal{W}^{-3}(\mathfrak{gl}_4, [2^2])$
$([N-1, 1], N)$	$\mathcal{W}^{-N+1}(\mathfrak{sl}_N, f_{\text{sub}})$
$([1^N], N)$	$V^{-N+1}(\mathfrak{sl}_N)$

Table 2: Correspondence between $T_\rho^\sigma[\text{SU}(N)]$ theories associated with pairs of partitions ($\rho = [1^N], \sigma$), and the \mathcal{W} -algebras obtained from their boundary VOAs.

The rest of this paper is organized as follows (see Fig. 1 for interrelations between different sections). In section 2 we begin by introducing H-twisted VOAs for general 3d $\mathcal{N} = 4$ SQFTs. We introduce the 3d $\mathcal{N} = 4$ quiver gauge theories themselves in section 3, and highlight the case of linear quiver gauge theories and in particular $T_\rho^\sigma[\text{SU}(N)]$ theories in section 4. In section 5 we describe VOAs associated with a general quiver gauge theories, and in section 6 we will specialize to the case of linear quiver gauge theories. In section 7 we introduce the concept of the associated variety of a vertex algebra (VA), a variety which we conjecture to be identified with an extended Higgs branch. In section 8 we propose an explicit homomorphism from an affine \mathcal{W} -algebra into the H-twisted VOAs for $T_{[1^n]}^{[2, 1^{n-2}]}[\text{SU}(n)]$ theories, and verify our proposal for the $T_{[1^4]}^{[2, 1^2]}[\text{SU}(4)]$ theory in section 8.3. In section 9 we discuss another example, specifically the $T_{[1^{2n}]}^{[n, n]}[\text{SU}(2n)]$ theory, and construct a homomorphism from a rectangular affine \mathcal{W} -algebra into the corresponding H-twisted VOA. In section 10 we introduce the localization of quiver vertex algebras and make contact with our companion paper [16]. One of the highlights of this paper is section 11, in which we introduce a reduction procedure for the quiver diagram, wherein we obtain a free-field realization of the VOAs for general quiver gauge theories. We will illustrate this idea with explicit examples in section 12. In section 13 we discuss the relations of our VOAs with those originating from 4d $\mathcal{N} = 2$ theories. We conclude in section 14 with a summary and comments on future directions. We also include appendix A for a glossary of notations, and more appendices with technical materials.

2 VOAs from 3d $\mathcal{N} = 4$ SQFTs

2.1 Setup

Suppose that we are given a 3d $\mathcal{N} = 4$ supersymmetric quantum field theory (SQFT) \mathcal{T} with a Lagrangian description. This theory is defined by

- a gauge group G ($\mathcal{N} = 4$ vector multiplet),
- and a symplectic representation M of G ($\mathcal{N} = 4$ hypermultiplet).

The vacuum moduli space of the theory consists of the Higgs branch \mathcal{M}_H , the Coulomb branch \mathcal{M}_C , as well as the mixed branches. This theory has $\text{SO}(4)_R \simeq \text{SU}(2)_H \times \text{SU}(2)_C$ R-symmetry, where $\text{SU}(2)_H$ ($\text{SU}(2)_C$) is the symmetry acting non-trivially on the Higgs

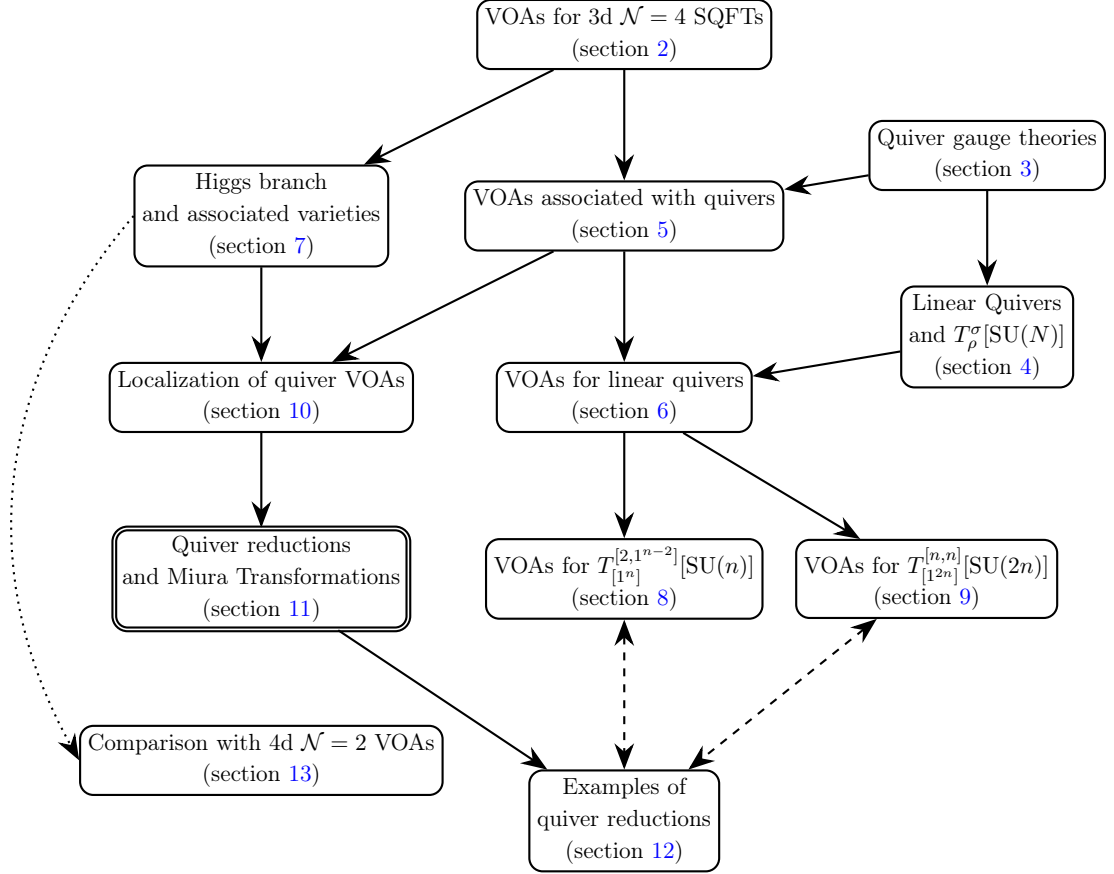

Figure 1: Approximate dependencies of the sections of this paper.

branch (Coulomb branch); the Higgs/Coulomb branches are hyperKähler manifolds and the $SU(2)_{H,C}$ symmetries rotate the triplet of complex structures therein. The two branches \mathcal{M}_H and \mathcal{M}_C , and hence their corresponding symmetries $SU(2)_H$ and $SU(2)_C$, are exchanged by the celebrated 3d mirror symmetry [18].

We consider topological twists of the theory \mathcal{T} . On a 3-manifold M , the $SO(3)_M \simeq SU(2)_M$ symmetry acting on the tangent space of M is mixed either with the $SU(2)_H$ or $SU(2)_C$ symmetry, and correspondingly we have an H-twisted TQFT or a C-twisted TQFT; these theories are also called A-twisted and B-twisted TQFT, respectively.² In this paper we will for the most part concentrate on the H-twisted/A-twisted TQFTs.

Now the H-twisted VOA \mathcal{V}_H (or hereafter simply \mathcal{V}), the central player of this paper, is obtained by considering the H-twisted TQFT on the geometry of the form $\mathbb{R}_{t \geq 0} \times \mathcal{C}$, where \mathcal{C} is a holomorphic curve³ — the VOA is defined on the holomorphic boundary $\{t = 0\} \times \mathcal{C}$. In more detail, we choose an $\mathcal{N} = (0, 4)$ -preserving boundary condition consistent with the supercharge preserved under the H-twist, with Neumann boundary conditions for both the

²The H/A-twist is the dimensional reduction of the Donaldson twist [6] in four dimensions. The early references on C/B-twist include [19, 20]. We can also consider a holomorphic twist [21–23] along a holomorphic curve, deformation of which gives rise to topological A/B-twists.

³The holomorphic structure here is more generally taken as a transverse holomorphic foliation [21, 22, 24].

vector and hyper multiplets [8, 25]. In order to cancel boundary gauge anomalies, we also need to choose boundary Fermi multiplets $\text{Ff}[R]$ in a representation R of the bulk gauge group G .

2.2 VOA as BRST reduction

It was proposed in [8] (see also [13]) that the H-twisted VOA \mathcal{V} in question is determined from the BRST reduction (to be discussed in more detail in the next subsection):

$$\mathcal{V} = \mathcal{V}[G, M, R] := \mathcal{V}^\sharp[M, R] // G = \left\{ \mathcal{V}^\sharp[M, R] \otimes \mathcal{V}_{\text{bc}}[G], \mathcal{Q} \right\}, \quad (2.1)$$

$$\mathcal{V}^\sharp = \mathcal{V}^\sharp[M, R] := \mathcal{V}_{\beta\gamma}[M] \otimes \mathcal{V}_{\text{Ff}}[R], \quad (2.2)$$

where the VOAs $\mathcal{V}_{\beta\gamma}[M]$, $\mathcal{V}_{\text{Ff}}[R]$, $\mathcal{V}_{\text{bc}}[G]$ are given respectively by

- $\mathcal{V}_{\beta\gamma}[G]$ is a set of $\beta - \gamma$ bosons (symplectic bosons [26]) $(X_i, Y_i)_{i=1, \dots, \dim M}$ originating from 3d $\mathcal{N} = 4$ hypermultiplets in a representation M of G , with non-trivial OPE given by

$$X_i(z)Y_j(w) \sim \frac{\delta_{i,j}}{z-w}. \quad (2.3)$$

The stress-energy operator is

$$T_{\beta\gamma} = \frac{1}{2} \sum_{i=1}^{\dim M} \text{Tr}(:X_i \partial Y_i: - :\partial X_i Y_i:), \quad (2.4)$$

and hence the conformal dimensions of (X_i, Y_i) are $(1/2, 1/2)$, and the total central charge is $c_{\beta\gamma} = -\dim M$.

- $\mathcal{V}_{\text{Ff}}[R]$ is a set of free fermions $(\Phi_i, \Psi_i)_{i=1, \dots, \dim R}$ arising from the free Fermi multiplets on the boundary, with OPE

$$\Phi_i(z)\Psi_j(w) \sim \frac{\delta_{i,j}}{z-w}. \quad (2.5)$$

We choose the stress-energy operator to be

$$T_{\text{Ff}} = -\frac{1}{2} \sum_{i=1}^{\dim R} \text{Tr}(:\Phi_i \partial \Psi_i: - :\partial \Phi_i \Psi_i:), \quad (2.6)$$

and hence the conformal dimensions of (Φ_i, Ψ_i) are $(1/2, 1/2)$, and the total central charge is $c_{\text{Ff}} = \dim R$.

- $\mathcal{V}_{\text{bc}}[G]$ is the bc-ghost $(\mathbf{b}^\alpha, \mathbf{c}_\alpha)_{\alpha=1, \dots, \dim G}$ in the adjoint representation of G . The OPEs are given by

$$\mathbf{b}^\alpha(z)\mathbf{c}_\beta(w) \sim \frac{\delta_\beta^\alpha}{z-w}. \quad (2.7)$$

We choose the stress-energy operator to be

$$T_{\text{bc}} = - \sum_{\alpha=1}^{\dim G} \text{Tr}(:\mathbf{b}^\alpha \partial \mathbf{c}_\alpha:), \quad (2.8)$$

and consequently conformal dimensions of (\mathbf{b}, \mathbf{c}) to be $(1, 0)$. The total central charge is $c_{\text{bc}} = -2 \dim G$.

This trio defines a product VOA $\mathcal{V}^\sharp[M, R] \otimes \mathcal{V}_{\text{bc}}[G] = \mathcal{V}_{\beta\gamma}[M] \otimes \mathcal{V}_{\text{Ff}}[R] \otimes \mathcal{V}_{\text{bc}}[G]$. We denote by \mathcal{Q} a supercharge defined below, with respect to which the BRST reduction is performed.

In general there will be boundary gauge anomalies at $\{t = 0\} \times \mathcal{C}$ coming separately from the $\beta\gamma$ -systems, the free fermions Ff and the bc-ghosts. When combined, these contributions to the boundary gauge anomaly cancel within $\mathcal{V}^\sharp[M, R] \otimes \mathcal{V}_{\text{bc}}[G]$. This cancellation and its conditions will be discussed further in section 5.2. Note however that in general, there is no unique way to cancel such anomalies, and the definition of the VOA depends on the specific choice of the boundary anomaly-canceling matter contents in a representation R ; different choices of R will lead to different VOAs with different characters.

2.3 BRST reduction

In this subsection we discuss the BRST reduction in (2.1). This is the VOA counterpart of imposing the Gauss law for the gauge symmetry.

Let us denote the Lie algebra associated to the group G by \mathfrak{g} . Since the 3d $\mathcal{N} = 4$ SQFT \mathcal{T} has a gauge symmetry G , we have a corresponding \mathfrak{g} -current, which is promoted to a holomorphic current algebra $J_{\mathcal{V}^\sharp}^\alpha(z)$ on the the boundary VOA \mathcal{V}^\sharp , satisfying the OPE

$$J_{\mathcal{V}^\sharp}^\alpha(z) J_{\mathcal{V}^\sharp}^\beta(w) \sim \frac{k_{\mathcal{V}^\sharp} \delta_{\alpha,\beta}}{(z-w)^2} + \sum_{\gamma} i f^{\alpha\beta\gamma} \frac{J_{\mathcal{V}^\sharp}^\gamma(w)}{z-w}, \quad (2.9)$$

where $f^{\alpha\beta\gamma}$ are the structure constants for the Lie algebra \mathfrak{g} and we have chosen a basis for \mathfrak{g} such that the Killing form is diagonalized. We have adopted the standard notation in OPE that \sim represents an equivalence up to non-singular terms. The integer $k_{\mathcal{V}^\sharp}$ is the level of the current algebra.

The bc ghost system \mathcal{V}_{bc} in itself has an affine \mathfrak{g} current algebra

$$J_{\text{bc}}^\alpha(z) = f^{\alpha\beta\gamma} c_\beta \mathbf{b}^\gamma(z) \quad (2.10)$$

with level $k_{\text{bc}} = 2\mathfrak{h}_{\mathfrak{g}}^\vee$, where $\mathfrak{h}_{\mathfrak{g}}^\vee$ is the dual Coxeter number of the Lie algebra \mathfrak{g} , defined by the relation $f^{\alpha\gamma\delta} f^{\beta\gamma\delta} = 2\mathfrak{h}_{\mathfrak{g}}^\vee \delta^{\alpha\beta}$.

Now suppose that the \mathfrak{g} -current algebra is critical, i.e.

$$k_{\mathcal{V}^\sharp} = -2\mathfrak{h}_{\mathfrak{g}}^\vee. \quad (2.11)$$

so that we have $k_{\mathcal{V}^\sharp} + k_{\text{bc}} = 0$. (We will relate this condition to the anomaly cancellation condition below.) We can then define the supercharge \mathcal{Q} on the product VOA $\mathcal{V}^\sharp \otimes \mathcal{V}_{\text{bc}}$ as

$$\mathcal{Q} := \oint \frac{dz}{2\pi i} \mathcal{J}(z), \quad (2.12)$$

where the BRST current \mathcal{J} is defined by [27, 28]

$$\mathcal{J}(z) := c_\alpha \left(J_{\mathcal{V}^\#}^\alpha + \frac{1}{2} J_{\mathcal{V}_{bc}^\bullet}^\alpha \right) (z) . \quad (2.13)$$

We can then verify the nilpotency of \mathcal{Q} , and use this as a supercharge in the BRST reduction of (2.1): the boundary VOA \mathcal{V} is given by the \mathcal{Q} -cohomology on the vertex operator $\mathcal{V}^\# \otimes \mathcal{V}_{bc}^\bullet$, i.e. \mathcal{Q} -closed operators up to equivalence relation defined by \mathcal{Q} -exact terms. In mathematical language, the BRST complex defines a semi-infinite complex $C^{\frac{\infty}{2}}(\mathcal{V}^\# \otimes \mathcal{V}_{bc}^\bullet, \mathcal{Q})$, and this defines a semi-infinite cohomology [29] $H^{\frac{\infty}{2} + \bullet}(\mathcal{V}^\#)$, where the grading \bullet is given by the ghost number; see appendix B for further explanation.

3 General quiver gauge theories

As a preparation for our discussions of VOAs, we first summarize some basics of quiver gauge theories themselves. Readers who are familiar with quiver varieties can skip this section, and come back here when necessary for notations.

3.1 Matter contents from quiver diagrams

A quiver Q is an oriented graph consisting of a finite set of nodes Q_0 and a finite set of arrows Q_1 together with two maps $\mathfrak{h}, \mathfrak{t} : Q_1 \rightarrow Q_0$ sending an arrow to its head and tail respectively.

The quiver diagram encapsulates the matter contents in the following manner:

- A vertex $i \in Q_0$ of the quiver represents a 3d $\mathcal{N} = 4$ vectormultiplet; the gauge group is $U(v_i)$ if the rank at the i^{th} vertex is v_i . The total gauge group is thus $G = \prod_{i \in Q_0} U(v_i)$.
- An edge $a \in Q_1$ of the quiver represents a 3d $\mathcal{N} = 4$ hypermultiplet. There are two types of hypermultiplets:
 - An edge connecting two circled vertices of the quiver represents a bifundamental hypermultiplet with respect to the gauge groups on the two ends of the edge.
 - An edge connecting a circular vertex to a squared vertex represents a fundamental hypermultiplet charged under the $U(w_i)$ flavor symmetry (Fig. 2).

As is clear from these discussions, we will in general need to specify the dimension vectors $\mathbf{v} = \{v_i\}$ and $\mathbf{w} = \{w_i\}$.

For later purposes we introduce the balancing condition [30] on the quiver. We will see in section 5.2 that this condition is equivalent to the vanishing of the SU gauge anomalies on the boundary.

We define the adjacency matrix \mathbf{Q} to be

$$\mathbf{Q}_{i,j} := \#(a \in Q_1 : \mathfrak{h}(a) = j, \mathfrak{t}(a) = i) , \quad (3.1)$$

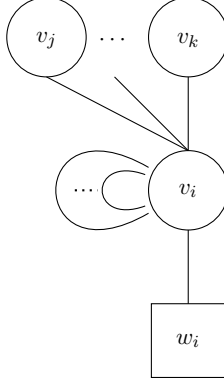

Figure 2: Local neighborhood of a general quiver around the i^{th} vertex

and the Cartan matrix \mathbf{C} to be

$$\mathbf{C}_{i,j} := 2\delta_{i,j} - \mathbf{Q}_{i,j} - \mathbf{Q}_{j,i} . \quad (3.2)$$

The *balance condition* is then given by

$$-\mathbf{C} \cdot \mathbf{v} + \mathbf{w} = \mathbf{0} . \quad (3.3)$$

When this condition is satisfied the quiver is referred to be *balanced*. While not all the theories discussed in this paper are balanced, we can impose a weaker condition, which we call the *anomaly cancellation condition*

$$\mathbf{d} := -\mathbf{C} \cdot \mathbf{v} + \mathbf{w} \in \mathbb{Z}_{\geq 0}^{Q_0} . \quad (3.4)$$

3.2 Higgs branches as quiver varieties

Let us next describe the Higgs branch of the quiver gauge theories. In mathematical language, the Higgs branch is the Nakajima quiver variety [31, 32] defined from the same quiver, whose description will be needed in the rest of this paper.

Define the space of representation of Q with gauge dimension vector \mathbf{v} and framing dimension vector \mathbf{w} to be

$$\text{Rep}(Q, \mathbf{v}, \mathbf{w}) := \bigoplus_{i \in Q_0} \text{Hom}(W_i, V_i) \oplus \bigoplus_{a \in Q_1} \text{Hom}(V_{\mathbf{t}(a)}, V_{\mathbf{h}(a)}) , \quad (3.5)$$

where $V = \bigoplus_{i \in Q_0} V_i$ and $W = \bigoplus_{i \in Q_0} W_i$ are Q_0 -graded vector spaces of dimensions $\dim V = \mathbf{v}$ and $\dim W = \mathbf{w}$ respectively. The space of representations $\text{Rep}(\mathbf{v}, \mathbf{w})$ naturally possesses an action of the complexified gauge group

$$\text{GL}(\mathbf{v}) := \prod_{i \in Q_0} \text{GL}(\mathbf{v}_i) , \quad (3.6)$$

and this action induces an Hamiltonian $\text{GL}(\mathbf{v})$ -action on the cotangent bundle $T^*\text{Rep}(\mathbf{v}, \mathbf{w})$. Note that $T^*\text{Rep}(\mathbf{v}, \mathbf{w})$ is naturally isomorphic to the space of representations of the doubled

quiver \overline{Q} , which has the same set of nodes as Q while its set of arrows is $\overline{Q}_1 = Q_1 \sqcup Q_1^*$, where Q_1^* is the orientation reverse of Q_1 . Explicitly

$$T^*\text{Rep}(\mathbf{v}, \mathbf{w}) = \bigoplus_{i \in Q_0} \text{Hom}(W_i, V_i) \oplus \bigoplus_{i \in Q_0} \text{Hom}(V_i, W_i) \\ \oplus \bigoplus_{a \in Q_1} \text{Hom}(V_{\mathbf{t}(a)}, V_{\mathbf{h}(a)}) \oplus \bigoplus_{a \in Q_1} \text{Hom}(V_{\mathbf{h}(a)}, V_{\mathbf{t}(a)}) . \quad (3.7)$$

We introduce the notation for the elements in the direct summands in $T^*\text{Rep}(Q, \mathbf{v}, \mathbf{w})$ as follows

$\text{Hom}(V_{\mathbf{t}(a)}, V_{\mathbf{h}(a)})$	$\text{Hom}(V_{\mathbf{h}(a)}, V_{\mathbf{t}(a)})$	$\text{Hom}(W_i, V_i)$	$\text{Hom}(V_i, W_i)$
x_a	y_a	α_i	β_i

The moment map $\mu : T^*\text{Rep}(Q, \mathbf{v}, \mathbf{w}) \rightarrow \mathfrak{gl}(\mathbf{v})^*$ for the Hamiltonian $\text{GL}(\mathbf{v})$ -action on $T^*\text{Rep}(Q, \mathbf{v}, \mathbf{w})$ is

$$\mu(x, y, \alpha, \beta) = - \sum_{a \in Q_1} [x_a, y_a] - \sum_{i \in Q_0} \alpha_i \beta_i . \quad (3.8)$$

Inside $\mathfrak{gl}(\mathbf{v})^* = \bigoplus_{i \in Q_0} \mathfrak{gl}(\mathbf{v}_i)^*$ there is a linear subspace \mathcal{Z} which is the span of scalar matrices

$$\mathcal{Z} := \bigoplus_{i \in Q_0} \mathbb{C} \cdot \text{Id}_{V_i} . \quad (3.9)$$

Definition 3.1. The affine quiver variety $\mathcal{M}^0(Q, \mathbf{v}, \mathbf{w})$ and its deformation $\widetilde{\mathcal{M}}^0(Q, \mathbf{v}, \mathbf{w})$ are defined as the Hamiltonian reductions

$$\mathcal{M}^0(Q, \mathbf{v}, \mathbf{w}) := \mu^{-1}(0) // \text{GL}(\mathbf{v}) , \quad \widetilde{\mathcal{M}}^0(Q, \mathbf{v}, \mathbf{w}) := \mu^{-1}(\mathcal{Z}) // \text{GL}(\mathbf{v}) . \quad (3.10)$$

Alternatively, one can define the extended moment map

$$\begin{array}{ccc} \widetilde{\mu} : T^*\text{Rep}(Q, \mathbf{v}, \mathbf{w}) \times \mathcal{Z} & \longrightarrow & \mathfrak{gl}(\mathbf{v})^* \\ \downarrow & & \downarrow \\ ((x, y, \alpha, \beta), z) & \longmapsto & \mu(x, y, \alpha, \beta) - z . \end{array} \quad (3.11)$$

Then we obviously have

$$\mu^{-1}(\mathcal{Z}) \cong \widetilde{\mu}^{-1}(0) .$$

Definition 3.2. A representation $(x, y, \alpha, \beta) \in T^*\text{Rep}(Q, \mathbf{v}, \mathbf{w})$ is called stable if there is no proper Q_0 -graded linear subspace $S_i \subset V_i$ such that

$$\alpha_i(W_i) \subset S_i , \quad x_a(S_{\mathbf{t}(a)}) \subset S_{\mathbf{h}(a)} , \quad y_a(S_{\mathbf{t}(a)}) \subset S_{\mathbf{h}(a)} .$$

A representation $(x, y, \alpha, \beta) \in T^*\text{Rep}(Q, \mathbf{v}, \mathbf{w})$ is called costable if there is no proper Q_0 -graded linear subspace $T_i \subset V_i$ such that

$$\beta_i(T_i) = 0 , \quad x_a(T_{\mathbf{t}(a)}) \subset T_{\mathbf{h}(a)} , \quad y_a(T_{\mathbf{t}(a)}) \subset T_{\mathbf{h}(a)} .$$

Denote by $T^*\text{Rep}(Q, \mathbf{v}, \mathbf{w})^{\text{st}}$ (resp. $T^*\text{Rep}(Q, \mathbf{v}, \mathbf{w})^{\text{cst}}$) the locus of stable (resp. costable) representations, and for every $\text{GL}(\mathbf{v})$ -invariant subset $S \subset T^*\text{Rep}(Q, \mathbf{v}, \mathbf{w})$ we set

$$S^{\text{st}} := S \cap T^*\text{Rep}(Q, \mathbf{v}, \mathbf{w})^{\text{st}}, \quad S^{\text{cst}} := S \cap T^*\text{Rep}(Q, \mathbf{v}, \mathbf{w})^{\text{cst}}. \quad (3.12)$$

Definition 3.3. The Nakajima quiver variety $\mathcal{M}(Q, \mathbf{v}, \mathbf{w})$ and its deformation $\widetilde{\mathcal{M}}(Q, \mathbf{v}, \mathbf{w})$ are defined as the Hamiltonian reductions

$$\mathcal{M}(Q, \mathbf{v}, \mathbf{w}) := \mu^{-1}(0)^{\text{st}} // \text{GL}(\mathbf{v}), \quad \widetilde{\mathcal{M}}(Q, \mathbf{v}, \mathbf{w}) := \mu^{-1}(\mathcal{Z})^{\text{st}} // \text{GL}(\mathbf{v}). \quad (3.13)$$

Note that $\mathcal{M}(Q, \mathbf{v}, \mathbf{w})$ is a closed subscheme of $\widetilde{\mathcal{M}}(Q, \mathbf{v}, \mathbf{w})$. In fact, if $\mu^{-1}(\mathcal{Z})^{\text{st}}$ is nonempty, then the natural projection $\mu^{-1}(\mathcal{Z})^{\text{st}} \rightarrow \mathcal{Z}$ is smooth and the action of $\text{GL}(\mathbf{v})$ on $\mu^{-1}(\mathcal{Z})^{\text{st}}$ is free. After passing to the quotient we get a smooth morphism $p : \widetilde{\mathcal{M}}(Q, \mathbf{v}, \mathbf{w}) \rightarrow \mathcal{Z}$, and $\mathcal{M}(Q, \mathbf{v}, \mathbf{w}) = p^{-1}(0)$. Since $\mathcal{M}(Q, \mathbf{v}, \mathbf{w})$ is a good quotient, its dimension is the expected one:

$$\dim \mathcal{M}(Q, \mathbf{v}, \mathbf{w}) = \mathbf{v} \cdot (2\mathbf{w} - \mathbf{C}\mathbf{v}). \quad (3.14)$$

Note that the right hand side is always non-negative thanks to the condition (3.4).

4 Linear quiver gauge theories and $T_\rho^\sigma[\text{SU}(N)]$ Theories

In this section, we specialize to the case of 3d $\mathcal{N} = 4$ gauge theories with linear quivers of type A, as shown in Fig. 3. We in particular highlight a family of 3d $\mathcal{N} = 4$ theories known as $T_\rho^\sigma[\text{SU}(N)]$ theories introduced in [30].⁴ In the following we follow the convention of $T_\rho^\sigma[\text{SU}(N)]$ theories in [33].

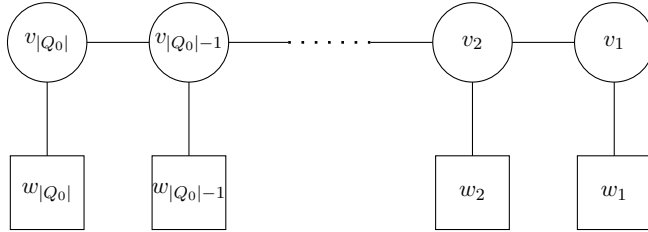

Figure 3: A-type linear quiver diagram with gauge nodes $\{v_i\}_{i \in Q_0}$ and framing nodes $\{w_i\}_{i \in Q_0}$.

4.1 Some notations

In the linear quiver of Fig. 3, an edge of the quiver always connects neighboring gauge node vertices. By choosing an orientation of the arrow, the oriented adjacency matrix \mathbf{Q} can be obtained as

$$\mathbf{Q}_{i,j} = \begin{cases} 1 & (j - i = 1), \\ 0 & (\text{otherwise}). \end{cases} \quad (4.1)$$

⁴The theory was denoted as $T_\rho^{\rho'}[\text{SU}(N)]$ in [30], where their notations and ours are related by $\sigma_{\text{here}} = \rho'_{\text{there}}$ and $\rho_{\text{here}} = \rho_{\text{there}}$.

This means that $a \in Q_1$ can be traded for $i \in Q_0$ with $i = 1, \dots, |Q_0| - 1$, where $i \in Q_0$ now represents an edge connecting vertices i and $i + 1$.

The Cartan matrix is given by

$$C_{i,j} = \begin{cases} 2 & (i = j) , \\ -1 & (|i - j| = 1) , \\ 0 & (\text{otherwise}) , \end{cases} \quad (4.2)$$

which is nothing but the standard Cartan matrix of type $A_{|Q_0|}$.

The notation for the elements in the direct summands in $T^*\text{Rep}(Q, \mathbf{v}, \mathbf{w})$ is now

$\text{Hom}(V_{i+1}, V_i)$	$\text{Hom}(V_i, V_{i+1})$	$\text{Hom}(W_i, V_i)$	$\text{Hom}(V_i, W_i)$
x_i	y_i	α_i	β_i

The moment map $\mu : T^*\text{Rep}(Q, \mathbf{v}, \mathbf{w}) \rightarrow \mathfrak{gl}(v_i)^*$ for the Hamiltonian $\text{GL}(v_i) \subset \text{GL}(\mathbf{v})$ action on $T^*\text{Rep}(Q, \mathbf{v}, \mathbf{w})$ is

$$\mu_i(x, y, \alpha, \beta) = -x_i y_i + y_{i-1} x_{i-1} - \alpha_i \beta_i , \quad (4.3)$$

where we have set $x_{|Q_0|} = y_{|Q_0|} = 0$ for simplicity of the equation .

4.2 Pair of partitions

The $T_\rho^\sigma[\text{SU}(N)]$ theory is specified by ρ and σ , each of which represents a conjugacy class of $\text{SU}(2)$ embeddings,

$$\rho, \sigma : \text{SU}(2) \rightarrow \text{SU}(N) . \quad (4.4)$$

When we denote the standard Pauli generators of $\mathfrak{su}(2)$ as $t_{i=1,2,3}$, we can write, up to conjugation by an element of $\text{SU}(N)$,

$$\rho(t^3) = \text{diag} \left(\underbrace{\frac{n_1 - 1}{2}, \frac{n_1 - 3}{2}, \dots, -\frac{n_1 - 1}{2}}_{n_1}, \dots, \underbrace{\frac{n_k - 1}{2}, \dots, -\frac{n_k - 1}{2}}_{n_k} \right) . \quad (4.5)$$

The integers n_i define a partition of N ,

$$\rho = [n_1, n_2, \dots, n_k] , \quad n_1 \geq n_2 \geq n_k > 0 , \quad \sum_{i=1}^k n_i = N . \quad (4.6)$$

The same comment applies to σ . When $\rho = \sigma = [1, \dots, 1]$ the $T_\rho^\sigma[\text{SU}(N)]$ theory is denoted simply as $T[\text{SU}(N)]$.

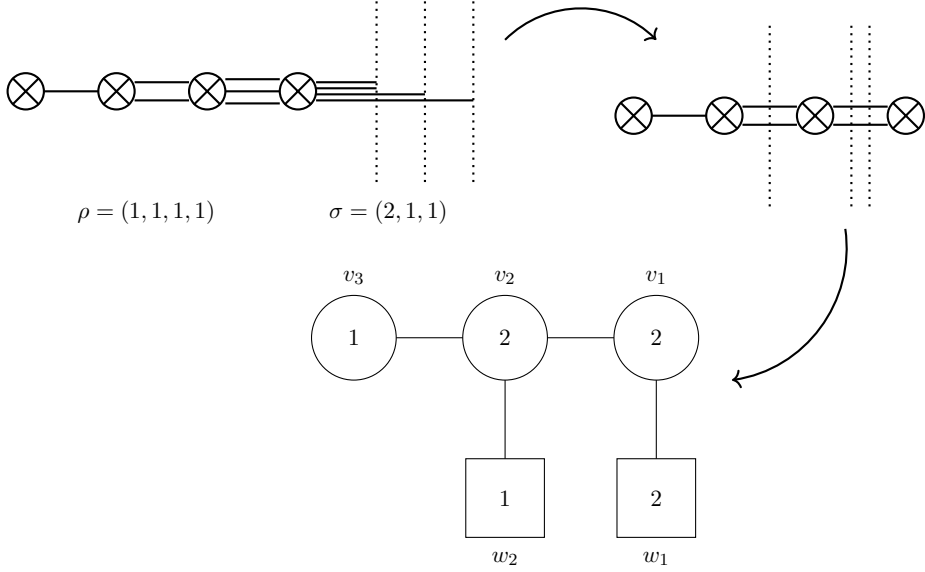

Figure 4: Brane realization, before and after Hanany-Witten moves, with NS5 branes (circles with crosses), D3 branes (horizontal segments) and D5 branes (dashed lines) and the corresponding quiver for the gauge theory example $T_\rho^\sigma[\text{SU}(N)]$ with $N = 4$, $\rho = (1, 1, 1, 1)$ and $\sigma = (2, 1, 1)$ that appeared in [33].

4.3 Partitions and quiver data

The $T_\rho^\sigma[\text{SU}(N)]$ theory is defined by a D3-NS5-D5 boundary condition, where we have N D3-branes on an interval, ending on the NS5-type boundary conditions defined by ρ on one end and D5-type boundary conditions defined by σ on the other end, as depicted in Fig. 4 — we have n_i D3-branes ending on the i^{th} NS5-brane for $\rho = [n_1, n_2, \dots, n_k]$, with similar pattern for the D5-branes and σ .⁵

The matter contents of the gauge theory can be extracted after the Hanany-Witten transition [34]. The resulting theory is a quiver gauge theory as in Fig. 5, where the ranks $v = (v_1, \dots, v_{k-1})$ and $w = (w_1, \dots, w_{k-1})$ of the gauge and flavor symmetry groups for $T_\rho^\sigma[\text{SU}(N)]$ are determined by

$$v_{k-1} = n_k, \quad 2v_i = v_{i+1} + v_{i-1} + w_i + n_{i+1} - n_i, \quad (i = 1, \dots, k-2), \quad (4.7)$$

for

$$\rho = [n_1, n_2, \dots, n_{k-1}, n_k], \quad (4.8)$$

$$\sigma = [\underbrace{(k-1), \dots, (k-1)}_{w_{k-1}}, \dots, \underbrace{i, \dots, i}_{w_i}, \dots]. \quad (4.9)$$

⁵Since we have 4d $\mathcal{N} = 4$ $\text{SU}(N)$ super Yang-Mills gauge theory on N D3-branes, we can regard this as a setup where 4d $\mathcal{N} = 4$ $\text{SU}(N)$ super Yang-Mills theory is placed on an interval, with D5 and NS5 boundary conditions on the two ends.

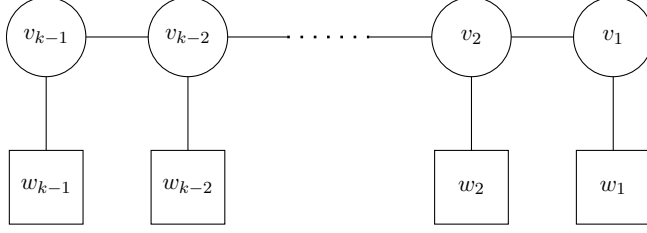

Figure 5: The quiver diagram for the $T_\rho^\sigma[\text{SU}(N)]$ theory.

The 3d mirror symmetry is realized by the S-duality of type IIB string theory [34], which exchanges the NS5-branes with the D5-branes while preserving the D3-branes. This means that the mirror of the $T_\rho^\sigma[\text{SU}(N)]$ theory is the $T_\sigma^\rho[\text{SU}(N)]$ theory, and in particular $T[\text{SU}(N)]$ theory (whose quiver is shown in Fig. 6) is mirror to itself.

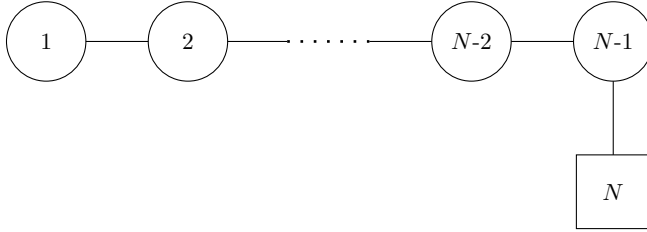

Figure 6: The quiver diagram for the $T[\text{SU}(N)]$ theory.

4.4 Higgs and Coulomb branches

The $T_\rho^\sigma[\text{SU}(N)]$ theory has non-trivial vacuum moduli space of vacua, consisting of the Higgs branch \mathcal{M}_H , the Coulomb branch \mathcal{M}_C and the mixed branches. The Higgs branch of $T_\rho^\sigma[\text{SU}(N)]$ has three different descriptions:

- (1) Nakajima quiver variety $\mathcal{M}(v, w)$ associated to the quiver of Fig. 5,
- (2) Slodowy variety $\overline{\mathcal{S}}_\sigma^{\rho^t}$ defined as an intersection $\overline{\mathcal{O}}(\rho^t) \cap \mathcal{S}(\sigma)$, where $\overline{\mathcal{O}}(\rho^t)$ is the closure of SL_N -orbit through a nilpotent element of \mathfrak{sl}_N with Jordan blocks associated to the partition ρ^t (transpose of ρ), and $\mathcal{S}(\sigma)$ is the transverse slice to a nilpotent element of \mathfrak{sl}_N with Jordan blocks associated to the partition σ ,
- (3) Slice $\overline{\mathcal{W}}_\rho^{\sigma^t}$ of the affine Grassmannian $\text{Gr}_{\text{PSL}_{|w|}}$, where $|w| = \sum_{i=1}^{k-1} w_i$, and both σ^t and ρ are regarded as coweights of $\text{PSL}_{|w|}$,

with the three varieties having been shown to be isomorphic by Mirković-Vybornov [35]. By the work of Braverman-Finkelberg-Nakajima [36, 37], the Coulomb branch of $T_\sigma^\rho[\text{SU}(N)]$ is the slice $\overline{\mathcal{W}}_\rho^{\sigma^t}$ of the affine Grassmannian Gr_{PSL_k} , which is isomorphic to the Slodowy variety $\overline{\mathcal{S}}_\sigma^{\rho^t}$ of SL_N . This is expected since the 3d mirror symmetry $T_\sigma^\rho[\text{SU}(N)] \leftrightarrow T_\rho^\sigma[\text{SU}(N)]$ swaps the Coulomb branches and Higgs branches

$$\overline{\mathcal{S}}_\sigma^{\rho^t} \cong \mathcal{M}_H(T_\rho^\sigma[\text{SU}(N)]) \cong \mathcal{M}_C(T_\sigma^\rho[\text{SU}(N)]) \cong \overline{\mathcal{W}}_\rho^{\sigma^t}. \quad (4.10)$$

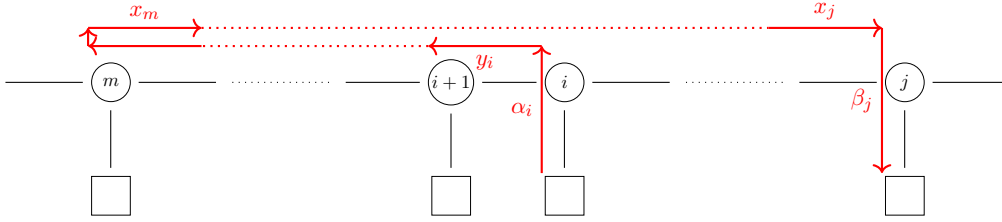

Figure 7: A path on the quiver diagram representing a gauge-invariant operator on the Higgs branch. In this figure we have shown the case $j < i$, but we allow for $j \geq i$ in the definition of the generator $g_{(i \rightarrow m \rightarrow j)}$.

The symmetry of the Higgs branch is the commutant of $\sigma(\mathrm{SU}(2))$, more precisely $\mathrm{S}(\mathrm{U}(w_1) \times \cdots \times \mathrm{U}(w_{k-1}))$. To see the hidden natural symmetry of the Coulomb branch, collect quiver nodes of $d_i = 0$ and construct a Dynkin diagram from these (corresponding to the balanced sub-quiver), see [37, Appendix A], then the Coulomb branch symmetry is the Levi subgroup of $\mathrm{PSU}(k)$ corresponding to the balanced subquiver. Equivalently, if we regard ρ as a cocharacter of $\mathrm{PSU}(k)$, then the Coulomb branch symmetry is the commutant of $\rho(\mathrm{U}(1))$ in $\mathrm{PSU}(k)$.

4.5 Higgs branch from paths on the linear quivers

For an explicit analysis of the Higgs branch, it is useful to have concrete parametrizations of the Higgs branch. In the algebraic language, this is to identify an element of the coordinate ring $\mathbb{C}[\mathcal{M}(Q, \mathbf{v}, \mathbf{w})]$ of the quiver variety.

The elements of the coordinate ring of the Higgs branch are given by gauge-invariant operators (mesons)⁶, which on the quiver diagram are either (i) closed paths or (ii) open paths which begin at a framing node and end at another framing node. Not all of these operators are independent since we can use the moment map relations $\mu = \mathcal{Z}$, where μ was given in (4.3).

Now, Theorem 2.2.1 of [38] has shown⁷ that the coordinate ring is generated by operators of the form (see Fig. 7)

$$g_{(i \rightarrow m \rightarrow j)} := \beta_j \cdot x_j \cdots x_{m-2} \cdot x_{m-1} \cdot y_{m-1} \cdots y_{i+1} \cdot y_i \cdot \alpha_i. \quad (4.11)$$

In particular, when parameterising the Higgs branch \mathcal{M}_H , it is only necessary to consider paths on the quiver diagram which do not loop around any of the edges.

There are still dependencies between the operators of the form (4.11) and not all of them are required to generate the Higgs branch.

4.6 Balanced linear quivers

In the following we will specialize to the case of balanced quivers.

⁶There are no baryons since the gauge groups are $\mathrm{U}(N)$.

⁷See also Theorem 10.1.1 of [38], [39] and [40]. This statement holds for a general linear quiver diagram, not necessarily one of the $T_\rho^\sigma[\mathrm{SU}(N)]$ theories.

We can verify that a linear type A quiver (as in Fig. 3) is balanced if and only if it can be expressed as a $T_\rho^\sigma[\text{SU}(N)]$ theory, where

$$N = kv_{k-1} , \quad (4.12)$$

$$\rho = \underbrace{[v_{k-1}, v_{k-1}, \dots, v_{k-1}]}_k , \quad (4.13)$$

$$\sigma = [\underbrace{(k-1), \dots, (k-1)}_{w_{k-1}}, \dots, \underbrace{i, \dots, i}_{w_i}, \dots] . \quad (4.14)$$

This include, as special cases (with $v_{k-1} = 1$), $T_\rho^\sigma[\text{SU}(N)]$ theory with $k = N$ and

$$\rho = \underbrace{[1, 1, \dots, 1]}_N , \quad (4.15a)$$

$$\sigma = [\underbrace{(N-1), \dots, (N-1)}_{w_{k-1}}, \dots, \underbrace{i, \dots, i}_{w_i}, \dots] . \quad (4.15b)$$

In the latter special case, we have $T_{[1, \dots, 1]}^\sigma[\text{SU}(N)]$ theories with a general partition σ , and v_i are related to w_i by

$$v_i = N - i - \sum_{j>i} (j - i)w_j . \quad (4.16)$$

5 VOAs associated to quivers

In the following sections we will concretely describe the VOA \mathcal{V} (2.1) for a quiver gauge theory, following the steps outlined in the previous section. In this section, we will actually describe a VOA $\mathcal{V}(Q, \mathbf{v}, \mathbf{w})$ which is canonically associated to a quiver Q with gauge and framing dimensions \mathbf{v}, \mathbf{w} , in contrast to the boundary VOA of the quiver gauge theory associated to $(Q, \mathbf{v}, \mathbf{w})$ which involves a choice of boundary fermions. The difference is that we fix a canonical choice of anomaly cancellation scheme which is determined solely by the quiver data.

We first describe the naive VA for the BRST reduction in section 5.1. We then analyze in section 5.2 the global \mathfrak{g} -symmetry currents and identify the boundary theories needed for anomaly cancellation. We can then carry out the BRST reduction to identify the VA \mathcal{V} . In section 5.3 we analyze the conformal vector, to promote the VA into a VOA.

5.1 Vertex algebra before BRST reduction

Let us begin by writing down the VOA before the BRST reduction. Note that at this point we will set aside the boundary anomaly cancellation condition, which will be fully taken into account in the next subsection.

In our discussion of VOAs we impose $\mathcal{N} = (0, 4)$ -preserving Neumann boundary conditions for $\mathcal{N} = 4$ vector and hyper multiplets. This leaves the following degrees of freedom on the boundary:

- a collection of $\beta\gamma$ -systems

- $(I_i, J_i)_{i \in Q_0}$ valued in fundamental or antifundamental representations of the $i \in \{1, \dots, |Q_0|\}$ flavor nodes and
- $(X_a, Y_a)_{a \in Q_1}$ valued in bifundamental representations of the gauge groups.

These fields are associated to the scalar fields coming from the 3d $\mathcal{N} = 4$ hypermultiplets valued in a symplectic representation of the gauge group G , as well as those from 3d $\mathcal{N} = 4$ vectormultiplets.

- a system \mathbf{bc} of fermionic fields $(\mathbf{b}_i, \mathbf{c}_i)_{i \in Q_0}$ from the \mathbf{bc} ghosts needed to fix the gauge freedom. The conformal weights of \mathbf{b} and \mathbf{c} are chosen to be 1 and 0, respectively.

The convention we adopt is summarized pictorially in Fig. 8, which presents the information locally around the i^{th} gauge node of the quiver. For example X_a is associated to the quiver edge directed from the $\mathbf{t}(a)^{\text{th}}$ gauge node to the $\mathbf{h}(a)^{\text{th}}$ gauge node.

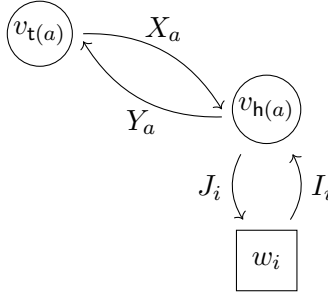

Figure 8: Conventions for the quiver arrows and associated fields in the vertex algebra.

The boundary field content defines a vertex operator algebra $\mathcal{V}_{\beta\gamma} \otimes \mathcal{V}_{\mathbf{bc}}$ on the boundary ∂M_3 , where the collection of fields obeys the following nontrivial OPEs

$$\begin{aligned}
(X_a)^\alpha{}_\beta(z) (Y_b)^\gamma{}_\delta(w) &\sim \frac{\delta_\delta^\alpha \delta_\beta^\gamma \delta_{a,b}}{z-w}, \\
(I_i)^\alpha{}_\beta(z) (J_j)^\gamma{}_\delta(w) &\sim \frac{\delta_\delta^\alpha \delta_\beta^\gamma \delta_{i,j}}{z-w}, \\
(\mathbf{b}_i)^\alpha{}_\beta(z) (\mathbf{c}_j)^\gamma{}_\delta(w) &\sim \frac{\delta_\delta^\alpha \delta_\beta^\gamma \delta_{i,j}}{z-w},
\end{aligned} \tag{5.1}$$

while all other OPEs are trivial.

5.2 Boundary anomaly cancellation and BRST reduction

Our boundary conditions leave unconstrained some fermions, which contribute to gauge anomalies on the boundary. These anomalies need to be canceled by the addition of extra degrees of freedom on the boundary [8, 41, 42].

A viable prescription for quiver gauge theories is to cancel a boundary anomaly locally at each of the quiver nodes. For the supersymmetric quiver gauge theories with A-type quiver depicted in Fig. 3 and gauge group of the form $G = \prod_{i \in Q_0} G_i$, with $G_i = \mathrm{U}(v_i) = \mathrm{SU}(v_i) \times \mathrm{U}(1)_{i,\text{diag}}$, one should separate the gauge anomaly for the semi-simple non-Abelian parts $\mathrm{SU}(v_i)$ from the Abelian components $\mathrm{U}(1)_{i,\text{diag}}$.

5.2.1 SU anomalies

The contribution to the boundary gauge anomaly from a 3d $SU(v_i)$ $\mathcal{N} = 2$ gauge multiplet with Neumann boundary conditions is $v_i \text{Tr}(F^2)$, where F denotes the $SU(v_i)$ connection field strength [42, Section 2]. On the other hand, the fermions from the 3d $\mathcal{N} = 2$ chiral multiplets in a fundamental or antifundamental representation of G_i , which correspond to edges of the quiver diagram and which have Neumann boundary conditions, each of these

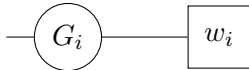

contributes $-\frac{1}{2}\text{Tr}(F^2)$ to the anomaly polynomial. From the G_i - w_i part of the quiver, the number of fundamental hypermultiplets is equal to the dimension of the fundamental or antifundamental representation for the flavor symmetry. The total contribution at the i^{th} node of the quiver is therefore $-\frac{1}{2}(w_i - \sum_{j \in Q_0} C_{i,j} v_j) \text{Tr}(F^2)$ associated to the pairs of arrows on the quiver pointing away from and respectively into the gauge node (see Fig. 9). Then in order for the $SU(v_i)$ gauge anomaly to cancel at each node i , the corresponding dimension vectors $\mathbf{v} = (v_i)_{i \in Q_0}$ and $\mathbf{w} = (w_i)_{i \in Q_0}$ should satisfy the balance condition (recall (3.3))

$$w_i - \sum_{j \in Q_0} C_{i,j} v_j = 0 . \quad (5.2)$$

When this condition is satisfied the quiver is referred to as *balanced* [30].

If instead we have the anomaly cancellation condition (recall (3.4))

$$d_i := w_i - \sum_{j \in Q_0} C_{i,j} v_j \geq 0 , \quad (5.3)$$

then it is necessary to add d_i additional left-handed symplectic 3d fermions in a fundamental or antifundamental representation of the gauge group $SU(v_i)$, which contribute $\frac{1}{2}d_i \text{Tr}(F^2)$ to the gauge anomaly polynomial. In this case, the quiver locally resembles that depicted in Fig. 9 around the gauge node $i \in Q_0$. One could think of the framing vector space being promoted from $W_i = \mathbb{C}^{w_i}$ to $\mathbb{C}^{w_i+d_i}$.

The end result of our analysis is that we need to include

- a collection of boundary Fermi multiplets \mathcal{V}_{Ff} satisfying the OPE relations

$$(\Phi_i)^\alpha{}_\beta(z) (\Psi_j)^\gamma{}_\delta(w) \sim \frac{\delta_\delta^\alpha \delta_\beta^\gamma \delta_{i,j}}{z-w} , \quad (5.4)$$

(All other OPEs are non-singular.)

Analysis of global symmetry currents We can arrive at the same conclusion by directly analyzing the global symmetry currents.

We have explained previously that we need to identify the current algebra symmetry originating from the gauge symmetry of the 3d $\mathcal{N} = 4$ theory we started with. For a quiver gauge theory, we have the gauge group $G = \prod_{i \in Q_0} G_i$, and this implies that there exists an

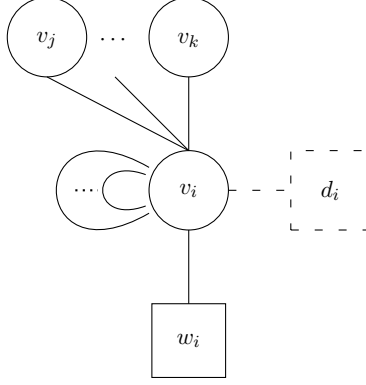

Figure 9: Local neighborhood of a general quiver around the i^{th} vertex. The SU anomaly cancellation requires introduction of boundary Fermi multiplets, which are represented as dotted arrows connecting to the newly-added framing node $SU(d_i)$.

affine \mathfrak{g}_i current $J_{\mathfrak{g}_i}(z)$ of the $\beta\gamma$ system associated to the gauge node v_i for every $i \in Q_0$. At the i^{th} gauge node, the generic form of which is depicted in Fig. 9, there is an affine $\mathfrak{u}(v_i)$ current of the form (cf. [8])

$$(J_{\mathfrak{u}(v_i)})^{\alpha\beta} = - \sum_{\mathfrak{h}(a)=i} (X_a)^\alpha{}_\gamma (Y_a)^\gamma{}_\beta + \sum_{\mathfrak{t}(a)=i} (Y_a)^\alpha{}_\gamma (X_a)^\gamma{}_\beta - (I_i)^\alpha{}_\gamma (J_i)^\gamma{}_\beta + (\Phi_i)^\alpha{}_\gamma (\Psi_i)^\gamma{}_\beta. \quad (5.5)$$

In view of comparison between (5.5) with (3.8), we shall call $J_{\mathfrak{u}(v_i)}$ the *chiral moment map* associated to the i^{th} node, denoted by $\mu_{\text{ch},i}$.

The $\mathfrak{su}(v_i)$ part of the current (5.5) is given by

$$(J_{\mathfrak{su}(v_i)})^{\alpha\beta} = (J_{\mathfrak{u}(v_i)})^{\alpha\beta} - \frac{\delta_\beta^\alpha}{v_i} (J_{\mathfrak{u}(v_i)})^\gamma{}_\gamma. \quad (5.6)$$

These $\mathfrak{su}(v_i)$ currents are akin to the BRST current $J_{\mathfrak{V}_i}^\alpha$ in (2.1), where the level of the corresponding bc ghost system current is $2\mathfrak{h}_{\mathfrak{su}(v_i)}^\vee = 2v_i$. Thus the level of the affine $\mathfrak{su}(v_i)$ currents $J_{\mathfrak{su}(v_i)}$ must be $-2\mathfrak{h}_{\mathfrak{su}(v_i)}^\vee = -2v_i$ in order for these to be anomaly free and to define a nilpotent charge in equation (2.13). We can see this is indeed the case from the OPE

$$(J_{\mathfrak{su}(v_i)})^{\alpha\beta}(z)(J_{\mathfrak{su}(v_i)})^\gamma{}_\delta(w) \sim \frac{\delta_\delta^\alpha \delta_\beta^\gamma (-\sum_{j \in Q_0} \mathbf{Q}_{i,j} v_j - w_i + d_i)}{(z-w)^2} + \frac{\delta_\beta^\gamma (J_{\mathfrak{su}(v_i)})^{\alpha\delta} - \delta_\delta^\alpha (J_{\mathfrak{su}(v_i)})^\gamma{}_\beta}{z-w}. \quad (5.7)$$

The level of the $\mathfrak{su}(v_i)$ current algebra is then $-\sum_{j \in Q_0} \mathbf{Q}_{i,j} v_j - w_i + d_i$, and this coincides with $-2v_i$ if and only if the anomaly cancellation condition (5.3) is satisfied.

5.2.2 U(1) anomalies

The $\mathfrak{u}(v_i)$ current (5.5) also has a diagonal $\mathfrak{u}(1)$ component

$$J_{\mathfrak{u}(1)}^{(i)} = \frac{1}{v_i} (J_{\mathfrak{u}(v_i)})^\gamma{}_\gamma, \quad (5.8)$$

which represents its trace part and which is anomalous, as is evident from the presence of singular terms in the OPE

$$J_{\mathbf{u}(1)}^{(i)}(z) J_{\mathbf{u}(1)}^{(j)}(w) \sim \frac{-C_{ij}}{(z-w)^2}, \quad (5.9)$$

where the existence of the second-order pole represents the existence of the U(1) anomalies.

While there is far from a unique choice to cancel the anomalies, there exists a minimal choice to cancel the anomalies:

- We add U(1)^{Q₀} current algebras satisfying the commutation relation

$$h_i(z) h_j(w) \sim \frac{C_{ij}}{(z-w)^2}, \quad (5.10)$$

(All other OPEs are non-singular.)

We can then modify the $\mathbf{u}(1)$ current (5.8) to be

$$J_{\mathbf{u}(1)}^{(i)} = \frac{1}{v_i} (J_{\mathbf{u}(v_i)})^\gamma_\gamma - h_i. \quad (5.11)$$

We can then easily verify that this current has a regular OPE with itself for all $i \in Q_0$.

5.2.3 Definition of $\mathcal{V}(Q, \mathbf{v}, \mathbf{w})$

Let us summarize the ingredients. Starting from a quiver Q with gauge and framing dimensions \mathbf{v}, \mathbf{w} , we associate

- $\beta\gamma$ systems $(X_a, Y_a)_{a \in Q_1}$ and $(I_i, J_i)_{i \in Q_0}$,
- pairs of free fermions $(\Phi_i, \Psi_i)_{i \in Q_0}$,
- Heisenberg algebra $\mathcal{H} = (h_i)_{i \in Q_0}$.

Let us denote the tensor product of the above trio by $\mathcal{V}^\sharp(Q, \mathbf{v}, \mathbf{w})$. We call

$$\tilde{\mu}_{\text{ch},i} := J_{\mathbf{u}(v_i)} - h_i \cdot \text{id} \quad (5.12)$$

the *chiral extended moment map* associated to the i^{th} node, which is a chiralization of extended moment map (3.11), in the sense that $\tilde{\mu}_{\text{ch}}$ gives rise to a vertex algebra map

$$\tilde{\mu}_{\text{ch}} : V^{-\kappa_{\mathfrak{g}}}(\mathfrak{g}) \rightarrow \mathcal{V}(Q, \mathbf{v}, \mathbf{w}), \quad (E_i)^\alpha_\beta \mapsto (\tilde{\mu}_{\text{ch},i})^\alpha_\beta,$$

where $\mathfrak{g} = \prod_{i \in Q_0} \mathfrak{gl}(v_i)$ and $\kappa_{\mathfrak{g}}$ is the Killing form on \mathfrak{g} . Then we can gauge the $\widehat{\mathfrak{g}}$ -symmetry, using the BRST reduction described in section 2.3, and define

$$\mathcal{V}^\bullet(Q, \mathbf{v}, \mathbf{w}) := H_{\text{BRST}}^{\infty/2+\bullet}(\mathfrak{g}, \mathcal{V}^\sharp(Q, \mathbf{v}, \mathbf{w})) \quad \text{and} \quad \mathcal{V}(Q, \mathbf{v}, \mathbf{w}) := \mathcal{V}^0(Q, \mathbf{v}, \mathbf{w}), \quad (5.13)$$

from the semi-infinite cohomology $H_{\text{BRST}}^{\infty/2+\bullet}(\mathfrak{g}, \mathcal{V}^\sharp(Q, \mathbf{v}, \mathbf{w}))$ defined by the BRST complex.

We now make two remarks. First, the presence of the current algebra is required irrespective of the choice of the quiver. Second, when the Cartan matrix C has a non-trivial kernel (i.e. C is not invertible), then a linear combination of the h 's have a non-singular OPE with all other fields and hence decouples from the rest of the VA; in this case it is more natural to decouple these fields to generate a smaller VA. The exception is the case where C is invertible, for example when the quiver is of the ADE type.

5.3 Conformal vector

Let us discuss a conformal vector of the theory so that we promote the VA into the VOA.

Since we already know the stress-energy operator for each of the building blocks, we can immediately write down the total stress-energy tensor to be

$$T = T_{\beta\gamma} + T_{\text{Ff}} + T_h + T_{\text{bc}} , \quad (5.14)$$

where $T_{\beta\gamma}$, T_{Ff} , T_h and T_{bc} are defined by

$$T_{\beta\gamma} := \frac{1}{2} \sum_{a \in Q_1} \text{Tr}(X_{(a)} \partial Y_{(a)} - \partial X_{(a)} Y_{(a)}) + \frac{1}{2} \sum_{i \in Q_0} \text{Tr}(I_i \partial J_i - \partial I_i J_i) , \quad (5.15)$$

$$T_{\text{Ff}} := -\frac{1}{2} \sum_{i \in Q_0} \text{Tr}(\Phi_i \partial \Psi_i - \partial \Phi_i \Psi_i) , \quad (5.16)$$

$$T_h := \frac{1}{2} \sum_{i,j \in Q_0} (\mathbf{C}^{-1})_{i,j} h_i h_j , \quad (5.17)$$

$$T_{\text{bc}} := - \sum_{i \in Q_0} \text{Tr}(\mathbf{b}_i \partial \mathbf{c}_i) , \quad (5.18)$$

where we assume for now that \mathbf{C} is invertible.

In order to verify that the BRST reduction defines a VOA, we need to ensure that the BRST operator is consistent with the stress-energy tensor of the VOA $\mathcal{V}^\sharp \otimes \mathcal{V}_{\text{bc}}$. To see this, first note that the \mathfrak{g} -current $J_{\mathcal{V}^\sharp}^\alpha(z)$ is a primary field of weight 1, having OPE with the stress-energy tensor $T_{\mathcal{V}^\sharp}(w)$ of \mathcal{V}^\sharp :

$$T_{\mathcal{V}^\sharp}(z) J_{\mathcal{V}^\sharp}^\alpha(w) \sim \frac{J_{\mathcal{V}^\sharp}^\alpha(w)}{(z-w)^2} + \frac{\partial J_{\mathcal{V}^\sharp}^\alpha(w)}{z-w} . \quad (5.19)$$

The total stress-energy tensor $T(z) = T_{\mathcal{V}^\sharp}(z) + T_{\text{bc}}(z) = T_{\mathcal{V}^\sharp}(z) - \mathbf{b}^\alpha \partial \mathbf{c}_\alpha(z)$ of the product VOA $\mathcal{V}^\sharp \otimes \mathcal{V}_{\text{bc}}$ is invariant under the BRST supercharge \mathcal{Q} , as can be seen by computing the OPE

$$T(z) \mathcal{J}(w) \sim \frac{c_\alpha J_{\mathcal{V}^\sharp}^\alpha(w)}{(z-w)^2} + \frac{f^{\alpha\beta} \mathbf{b}^\gamma \mathbf{c}_\alpha \mathbf{c}_\beta(w)}{2(z-w)^2} . \quad (5.20)$$

and hence

$$[\mathcal{Q}, T(w)] = \oint_{|z-w|=1} \frac{dz}{2\pi i} \mathcal{J}(z) T(w) = 0 . \quad (5.21)$$

The stress-energy tensor (5.14) is hence BRST invariant.

There are more BRST-closed operators associated with paths of the quiver diagram. Explicit expressions of these operators will depend on the details of the quiver, and for simplicity of the presentation we will discuss them in section 6, when we specialize our discussion to linear quivers.

The central charge of the stress-energy tensor (5.14) is

$$\begin{aligned}
c_{\mathcal{V}^\sharp \otimes \mathcal{V}_{bc}} &= - \underbrace{\sum_{i \in Q_0} Q_{i,i} v_i^2 - \sum_{i \neq j} Q_{i,j} v_i v_j - \sum_{i \in Q_0} v_i w_i}_{\beta\gamma} + \underbrace{\sum_{i \in Q_0} v_i d_i}_{\text{Ff}} + \underbrace{|Q_0|}_h - 2 \underbrace{\sum_{i \in Q_0} v_i^2}_{bc} \\
&= |Q_0| - \frac{1}{2} \mathbf{v} \cdot \mathbf{C} \mathbf{v} - 3 \mathbf{v} \cdot \mathbf{v} ,
\end{aligned} \tag{5.22}$$

where the equality on the second line follows from substituting the anomaly cancellation condition (5.3).

When the Cartan matrix \mathbf{C} is not invertible, there is a central part inside $\mathcal{V}(Q, \mathbf{v}, \mathbf{w})$ strongly generated by $\{h \in \mathbb{C}^{Q_0} \mid Ch = 0\}$. Let us denote the vertex ideal of $\mathcal{V}^\sharp(Q, \mathbf{v}, \mathbf{w})$ strongly generated by the kernel of \mathbf{C} by $\ker(\mathbf{C})$. We define $\mathcal{V}^\sharp(Q, \mathbf{v}, \mathbf{w})_{\text{red}}$ to be the quotient of $\mathcal{V}^\sharp(Q, \mathbf{v}, \mathbf{w})$ by the vertex ideal $\ker(\mathbf{C})$, and subsequently define $\mathcal{V}(Q, \mathbf{v}, \mathbf{w})_{\text{red}}$ to be the BRST reduction of $\mathcal{V}^\sharp(Q, \mathbf{v}, \mathbf{w})_{\text{red}}$, i.e.

$$\begin{aligned}
\mathcal{V}^\bullet(Q, \mathbf{v}, \mathbf{w})_{\text{red}} &:= H_{\text{BRST}}^{\infty/2+\bullet}(\mathfrak{g}, \mathcal{V}^\sharp(Q, \mathbf{v}, \mathbf{w})_{\text{red}}) , \\
\mathcal{V}(Q, \mathbf{v}, \mathbf{w})_{\text{red}} &:= \mathcal{V}^0(Q, \mathbf{v}, \mathbf{w})_{\text{red}} .
\end{aligned} \tag{5.23}$$

Now $\mathcal{V}^\sharp(Q, \mathbf{v}, \mathbf{w})_{\text{red}}$ admits a stress-energy tensor $T = T_{\beta\gamma} + T_{\text{Ff}} + T_{\bar{h}} + T_{bc}$, where

$$T_{\bar{h}} := \frac{1}{2} \sum_{i,j} (\bar{\mathbf{C}}^{-1})_{i,j} \bar{h}_i \bar{h}_j . \tag{5.24}$$

Here \bar{h}_i are chosen from a basis of $\mathbb{C}^{Q_0} / \ker(\mathbf{C})$, and $\bar{\mathbf{C}}$ is the induced inner form on $\mathbb{C}^{Q_0} / \ker(\mathbf{C})$. The same argument as above shows that T is BRST closed, thus it defines a stress-energy operator of $\mathcal{V}(Q, \mathbf{v}, \mathbf{w})_{\text{red}}$, and its central charge can be computed similarly:

$$c_{\mathcal{V}_{\text{red}}} = \text{rank}(\mathbf{C}) - \frac{1}{2} \mathbf{v} \cdot \mathbf{C} \mathbf{v} - 3 \mathbf{v} \cdot \mathbf{v} . \tag{5.25}$$

6 Boundary VOAs for linear quivers gauge theories

Having discussed the VOAs associated with general quiver gauge theories, let us next discuss the boundary VOAs of linear quiver gauge theories presented in section 4.

6.1 Anomaly cancellation on the boundary

Since we are now merely specializing the discussion from section 5, all the statements therein will be applicable here.

SU anomalies: For cancellation of SU anomalies it is necessary to add d_i additional left-handed symplectic 2d fermions in a fundamental or antifundamental representation of the gauge group $\text{SU}(v_i)$, where $\{d_i\}$ are determined by the anomaly cancellation condition (5.3):

$$d_i := v_{i-1} + v_{i+1} - 2v_i + w_i \in \mathbb{Z}_{\geq 0}^{|Q_0|} . \tag{6.1}$$

In this case, the quiver locally resembles that depicted in Fig. 10 around the gauge node $i \in Q_0$.

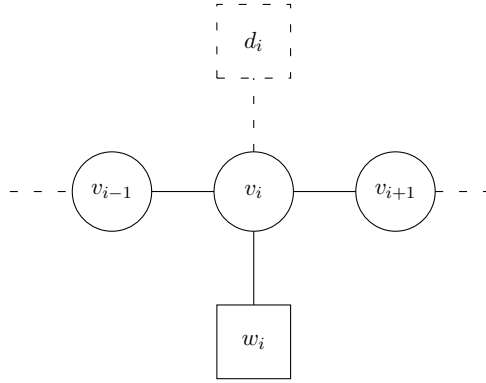

Figure 10: Local portion of an A-type quiver around the i^{th} gauge node. The condition for $SU(v_i)$ gauge anomaly cancellation is $2v_i - v_{i-1} - v_{i+1} - w_i + d_i = 0$. The dashed square node represents not a part of the quiver diagram of the bulk 3d theory, but rather boundary degrees of freedom which are introduced only to cancel the boundary gauge anomaly.

U(1) anomalies For linear quivers there exists a somewhat canonical way of canceling U(1) anomalies—a collection of $\mathcal{N} = (0, 2)$ Fermi multiplets with chiral free fermions (χ_i, ψ_i) and label $i = 0, 1, \dots, |Q_0|$ are added on the boundary to cancel the Abelian gauge anomaly $\prod_{i \in Q_0} U(1)_{i, \text{diag}}$. This generates the U(1) current algebra strongly generated by

$$h_i = : \chi_i \psi_i : - : \chi_{i-1} \psi_{i-1} : . \quad (6.2)$$

It is straightforward to see that $h_i(z)h_j(w) \sim C_{i,j}/(z-w)^2$, therefore the Heisenberg algebra $\{h_i\}_{i \in Q_0}$ cancels the U(1) anomaly as we discussed in section 5.2.

6.2 VOA before BRST reduction

Having discussed the anomaly cancellation, we can now write down the VA $\mathcal{V}_\partial^\sharp \otimes \mathcal{V}_{\text{bc}}$ before the BRST reduction:

- A collection of $\beta\gamma$ -systems
 - $(I_i, J_i)_{i \in Q_0}$ valued in fundamental or antifundamental representations of the $i \in \{1, \dots, |Q_0|\}$ flavor nodes and
 - $(X_i, Y_i)_{i \in \{1, \dots, |Q_0|-1\}}$ valued in bifundamental representations of the gauge groups.

These fields are associated to the scalar fields coming from the 3d $\mathcal{N} = 4$ hypermultiplets valued in a symplectic representation of the gauge group G , which will be denoted by $\mathcal{V}_{\beta\gamma}$.

- A set of free fermions (Φ_i, Ψ_i) for any gauge nodes with $d_i \neq 0$ for labels $i \in \{1, \dots, |Q_0|\}$, which will be denoted by \mathcal{V}_{Ff} .
- A set of chiral free fermions $(\chi_i, \psi_i)_{i=0,1,\dots,|Q_0|}$ introduced on the boundary to cancel the Abelian gauge anomaly, with pairs (χ_i, ψ_i) and (χ_{i-1}, ψ_{i-1}) for each gauge node $i \in \{1, \dots, |Q_0|\}$. This system of free fermions will be denoted by $\mathcal{V}_{\chi\psi}$.

- A bc ghost system of fermionic fields $(\mathbf{b}_i, \mathbf{c}_i)_{i \in Q_0}$ which is needed to fix the gauge freedom. The conformal weights of \mathbf{b} and \mathbf{c} are chosen to be 1 and 0, respectively. The bc ghost system will be denoted \mathcal{V}_{bc} .

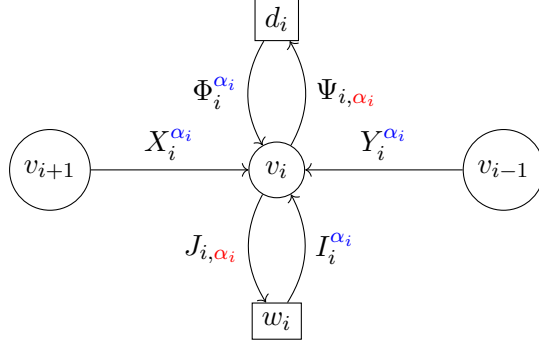

Figure 11: Index convention at the gauge node i , where α_i is the gauge index for the gauge subgroup G_i . Other indices are suppressed.

The convention we adopt is summarized pictorially in Fig. 11, which presents the information locally around the i^{th} gauge node of the quiver similarly to Fig. 10. It shows how the symplectic bosons X_i, Y_i, I_i and J_i and the fermions Φ_i and Ψ_i are associated to arrows on the quiver edges, together with the convention for their indices. For example X_i is associated to the quiver edge directed from the $(i+1)^{\text{th}}$ gauge node to the i^{th} gauge node, with the convention

$$\textcircled{v_{i+1}} \xrightarrow{(X_i)^{\alpha_i \alpha_{i+1}}} \textcircled{v_i},$$

where α_i is an index for the gauge group G_i and α_{i+1} , an index for the gauge group G_{i+1} .

The boundary field content defines a vertex operator algebra $\mathcal{V}_\partial^\sharp \otimes \mathcal{V}_{bc}$ on ∂M_3 where

$$\mathcal{V}_\partial^\sharp := \mathcal{V}_{\beta\gamma} \otimes \mathcal{V}_{\text{FF}} \otimes \mathcal{V}_{\chi\psi}. \quad (6.3)$$

The collection of fields obeys the following nontrivial OPEs

$$\begin{aligned} (X_i)^\alpha_\beta(z) (Y_j)^\gamma_\delta(w) &\sim \frac{\delta_\delta^\alpha \delta_\beta^\gamma \delta_{i,j}}{z-w}, \\ (I_i)^\alpha_\beta(z) (J_j)^\gamma_\delta(w) &\sim \frac{\delta_\delta^\alpha \delta_\beta^\gamma \delta_{i,j}}{z-w}, \\ (\Phi_i)^\alpha_\beta(z) (\Psi_j)^\gamma_\delta(w) &\sim \frac{\delta_\delta^\alpha \delta_\beta^\gamma \delta_{i,j}}{z-w}, \\ (\mathbf{b}_i)^\alpha_\beta(z) (\mathbf{c}_j)^\gamma_\delta(w) &\sim \frac{\delta_\delta^\alpha \delta_\beta^\gamma \delta_{i,j}}{z-w}, \\ \chi_i(z) \psi_j(w) &\sim \frac{\delta_{i,j}}{z-w}, \end{aligned} \quad (6.4)$$

while all other OPEs are trivial.

The total stress-energy tensor is

$$T = T_{\beta\gamma} + T_{\text{Ff}} + T_{\chi\psi} + T_{\text{bc}} , \quad (6.5)$$

where $T_{\beta\gamma}$, T_{Ff} , and T_{bc} are defined in the same way as in the (5.14), and $T_{\chi\psi}$ is defined by

$$T_{\chi\psi} := -\frac{1}{2} \sum_{i=0}^{|Q_0|} (\chi_i \partial \psi_i - \partial \chi_i \psi_i) , \quad (6.6)$$

The central charge of the stress-energy tensor (6.5) is

$$\begin{aligned} c_{\mathcal{V}_\partial^\sharp \otimes \mathcal{V}_{\text{bc}}} &= - \underbrace{\sum_{i=1}^{|Q_0|-1} v_i v_{i+1}}_{\beta\gamma} - \underbrace{\sum_{i=1}^{|Q_0|} v_i w_i}_{\text{Ff}} + \underbrace{\sum_{i=1}^{|Q_0|} v_i d_i}_{\chi\psi} + \underbrace{1 + |Q_0|}_{\chi\psi} - \underbrace{2 \sum_{i=1}^{\mathcal{I}} v_i^2}_{\text{bc}} \\ &= 1 + |Q_0| + \sum_{i=1}^{|Q_0|-1} v_i v_{i+1} - 4 \sum_{i=1}^{|Q_0|} v_i^2 , \end{aligned} \quad (6.7)$$

where the equality on the second line follows from substituting the anomaly cancellation condition (5.3).

6.3 BRST reduction

Let us next perform a BRST reduction of the VOA $\mathcal{V}_\partial^\sharp$. We notice that $\mathcal{V}_\partial^\sharp$ contains the vertex subalgebra $\mathcal{V}^\sharp := \mathcal{V}_{\beta\gamma} \otimes \mathcal{V}_{\text{Ff}} \otimes \mathcal{H}$ where \mathcal{H} is the Heisenberg algebra strongly generated by $\{h_i\}_{i \in Q_0}$ in (6.2), \mathcal{V}^\sharp being exactly the vertex algebra associated to the quiver $(Q, \mathbf{v}, \mathbf{w})$ before BRST reduction defined in section 5.2. The stress-energy tensor T in (6.5) belongs to the vertex subalgebra \mathcal{V}^\sharp . We also notice that the boson-fermion correspondence provides a decomposition of $\mathcal{V}_\partial^\sharp$

$$\mathcal{V}_\partial^\sharp = \bigoplus_{\lambda \in \mathbb{Z}^{|Q_0|+1}} \mathcal{V}_{\partial, \lambda}^\sharp , \quad (6.8)$$

into a lattice extension of the vertex subalgebra $\mathcal{V}_{\partial, 0}^\sharp$, where

$$\mathcal{V}_{\partial, 0}^\sharp = \mathcal{V}^\sharp \otimes J_{\chi\psi}, \quad J_{\chi\psi} = \sum_{i=0}^{|Q_0|} \chi_i \psi_i . \quad (6.9)$$

Therefore we can perform BRST reduction of $\mathcal{V}_\partial^\sharp$ using the chiral extended moment map (5.12), and define

$$\mathcal{V}_\partial^\bullet := H_{\text{BRST}}^{\infty/2+\bullet}(\mathfrak{g}, \mathcal{V}_\partial^\sharp) , \quad \text{and } \mathcal{V}_\partial := \mathcal{V}_\partial^0 . \quad (6.10)$$

Then we have a decomposition of \mathcal{V}_∂

$$\mathcal{V}_\partial = \bigoplus_{\lambda \in \mathbb{Z}^{|Q_0|+1}} \mathcal{V}_{\partial, \lambda} , \quad \mathcal{V}_{\partial, 0} = \mathcal{V} \otimes J_{\chi\psi} , \quad (6.11)$$

into a lattice extension of the vertex subalgebra $\mathcal{V} \otimes J_{\chi\psi}$, where $\mathcal{V} = \mathcal{V}(Q, \mathbf{v}, \mathbf{w})$ is the vertex algebra associated to the quiver $(Q, \mathbf{v}, \mathbf{w})$ defined in (5.13). The $\mathcal{V} \otimes J_{\chi\psi}$ -module $\mathcal{V}_{\partial, \lambda}$ is

$$H_{\text{BRST}}^{\infty/2+0}(\mathfrak{g}, \mathcal{V}_{\beta\gamma} \otimes \mathcal{V}_{\text{FF}} \otimes \mathcal{H}_{\bar{\lambda}}) \otimes J_{\chi\psi} ||\lambda\rangle, \quad (6.12)$$

where $\mathcal{H}_{\bar{\lambda}}$ is the module of \mathcal{H} generated by $|\bar{\lambda}\rangle$ such that $h_{i,(0)}|\bar{\lambda}\rangle = (\lambda_i - \lambda_{i-1})|\bar{\lambda}\rangle$, and $||\lambda\rangle$ generates a module of $J_{\chi\psi}$ such that $J_{\chi\psi,(0)}||\lambda\rangle = \sum_{i=0}^{|\mathcal{Q}_0|} \lambda_i ||\lambda\rangle$.

Let us discuss examples of bosonic operators that can be constructed for A-type quivers and which are invariant with respect to the action of BRST charges (2.13) defined using the affine $\mathfrak{u}(v_i)$ currents $\tilde{\mu}_{\text{ch},i}$ (5.12):

- The stress energy tensor T defined in equation (6.5) .
- The U(1) current $J_{\chi\psi}$, which is constructed using the chiral free fermions

$$J_{\chi\psi} = \sum_{i=0}^{|\mathcal{Q}_0|} \chi_i \psi_i, \quad (6.13)$$

This current is invariant with respect to the BRST currents (2.13) constructed using the currents $\tilde{\mu}_{\text{ch},i}$ (5.12), the former having only regular terms in the OPEs with the latter

$$J_{\chi\psi}(z) \tilde{\mu}_{\text{ch},i}(w) \sim 0. \quad (6.14)$$

- Currents associated to paths on the quiver diagram in Fig. 3 which begin and end at framing nodes. For example, one can consider operators

$$\begin{aligned} G_{(i,j)} &:= J_j X X \dots X I_i \quad (i > j), \\ G_{(i,j)} &:= J_j Y Y \dots Y I_i \quad (i < j), \end{aligned} \quad (6.15)$$

which are represented by a path on the quiver diagram as in Fig. 12.

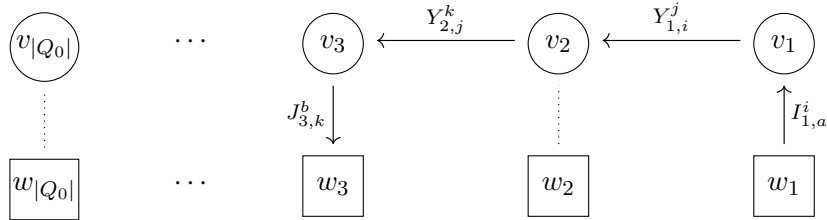

Figure 12: The operator $G_{(3,1)} = J_3 Y_2 Y_1 I_1$

The operators (6.15) are primary fields of dimension $(|i - j| + 2)/2$, and moreover are BRST exact.

To explain the BRST exactness, let us for example compute the OPE of $\tilde{\mu}_{\text{ch},2}$ with the operator $G_{(3,1)} = J_3 Y_2 Y_1 I_1$ of Fig. 12. Most of the terms in the definition of the current (5.12) have trivial OPEs with $G_{(3,1)}$, with the exception of

$$(\tilde{\mu}_{\text{ch},2})^\alpha{}_\beta \supset (X_2)^\alpha{}_\gamma (Y_2)^\gamma{}_\beta - (Y_2)^\alpha{}_\gamma (X_1)^\gamma{}_\beta . \quad (6.16)$$

We can compute

$$\begin{aligned} [(X_2)^\alpha{}_\gamma (Y_2)^\gamma{}_\beta](z) G_{(3,1)}(w) &\sim \overline{(X_2)^\alpha{}_\gamma (Y_2)^\gamma{}_\beta [J_3 Y_2 Y_1 I_1]}(w) \\ &\sim \frac{1}{z-w} (J_3 Y_2)_\beta (Y_1 I_1)^\alpha . \end{aligned} \quad (6.17)$$

Similarly, we can compute

$$[(Y_1)^\alpha{}_\gamma (X_1)^\gamma{}_\beta](z) G_{(3,1)}(w) \sim \frac{1}{z-w} (J_3 Y_2)_\beta (Y_1 I_1)^\alpha . \quad (6.18)$$

and hence $(\tilde{\mu}_{\text{ch},2})^\alpha{}_\beta G_{(3,1)} \sim 0$. Since the bc ghosts have trivial OPE with $G_{(3,1)}$, we have OPE $\mathcal{J}(z) G_{(3,1)}(w) \sim 0$ and this proves the BRST invariance of $G_{(3,1)}$.

The proof for a more general $G_{(i,j)}$ operator (6.15) works in essentially the same way, since the discussion is localized in the neighborhood of the quiver diagram.

We can consider a more general path. The simplest possibility is the path in Fig. 13. In this case, the naive operator $G_{(i,i)} \stackrel{?}{=} J_i I_i$ is not BRST invariant due to the presence of a double pole in the OPE of $G_{(i,i)}$ and $\text{Tr}(I_i \partial J_i - \partial I_i J_i) \subset T$. This problem, however, can be dealt with by introducing an extra term involving fermions:

$$(G_{(i,i)})^a{}_b = (J_i I_i)^a{}_b + (\chi_i \psi_i + \chi_{i+1} \psi_{i+1} + \chi_{i+2} \psi_{i+2} + \dots) \delta^a{}_b , \quad (6.19)$$

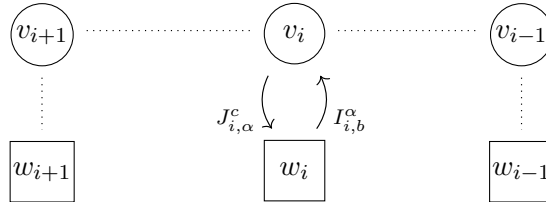

Figure 13: The bosonic generators $G_{(i,i),b}^c$ at framing node w_i .

More generally, one considers operators which are schematically of the form

$$G \sim J_j \mathcal{O}_1 \mathcal{O}_2 \dots \mathcal{O}_m I_i , \quad \mathcal{O}_i = X \text{ or } Y . \quad (6.20)$$

The expression (6.20) is not meant to be a precise expression in general, and as we will see we might need to add extra terms to make the operator BRST-invariant, similarly to those in equation (6.19). On the quiver diagram the operator (6.20) represents a path starting from one of the framing nodes i , going around the quiver, and then ending at another framing node j .

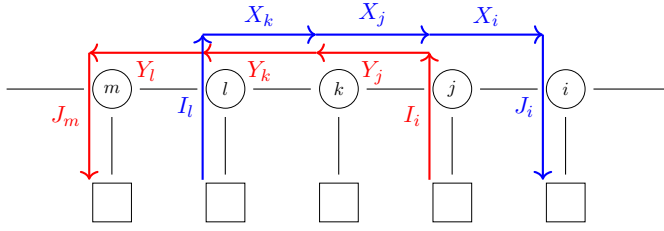

Figure 14: We consider the OPE of two BRST-invariant operators, one represented by a red path and another by a blue path; see the LHS of (6.22).

Readers will have noticed that the discussion of the BRST-closed operators in this subsection is reminiscent of the generators of the coordinate ring of the Higgs branch in section 4.5. This is not a coincidence, and we will see throughout the rest of this paper the close parallel between the geometry of the Higgs branch and the its associated VOA: the VOA is a “chiralization” of the Higgs branch. We will in particular formalize in section 7 this correspondence in the language of the associated variety.

We have to this point listed examples of BRST-invariant operators which will survive after the BRST quotient and hence will define non-trivial operators in \mathcal{V}_∂ . However, it turns out that the generators (6.20) still contain redundancies and cannot be used as a subset for a strong generator of VOA. Here a strong generator of a VOA is a set of operators generating the VOA, such that none of the generators appear in the non-singular terms of the OPEs of other generators. In other words, we do not include composite operators in the set of generators. We will come back to this issue in section 7.2.

The connections between BRST-invariant operators and paths on the quiver also sheds light on the OPE between operators. Defining for example an operator $G_{(m \leftarrow j)}$ associated to a path on the quiver diagram in Fig. 14 starting at the framing node j and ending at the framing node m , and an operator $G_{(l \rightarrow i)}$ associated to a path starting at the framing node l and ending at the framing node i

$$G_{(m \leftarrow j)} = J_m Y_l Y_k Y_j I_j, \quad G_{(l \rightarrow i)} = J_i X_i X_j X_k I_l, \quad (6.21)$$

their OPE takes the form

$$G_{(m \leftarrow j)}(z) G_{(l \rightarrow i)}(w) \sim \frac{v_k G_{(m \leftarrow l)} G_{(j \rightarrow i)}(w)}{(z-w)^2} + \frac{G_{(j \rightarrow i)} \mathcal{O}_1(w) + G_{(m \leftarrow l)} \mathcal{O}_2(w)}{(z-w)}, \quad (6.22)$$

for some operators \mathcal{O}_1 and \mathcal{O}_2 . At the level of the paths on the quiver, this operation removes pairs of juxtaposed segments in Fig. 14 with opposite orientation, each such pair producing a singular contribution $(z-w)^{-1}$ and operators associated to the paths formed by the remaining segments in Fig. 15.

6.4 Match of central charges with \mathcal{W} -algebras

Let us comment on some numerology before closing this section.

For the case (4.15), we claim that the central charge (5.22) equals the central charge of $\mathcal{W}^{-N+1}(\mathfrak{gl}(N), f)$, where f is a nilpotent element of $\mathfrak{gl}(N)$ of type $((N-1)^{w_{N-1}} \dots i^{w_i} \dots 1^{w_1})$.

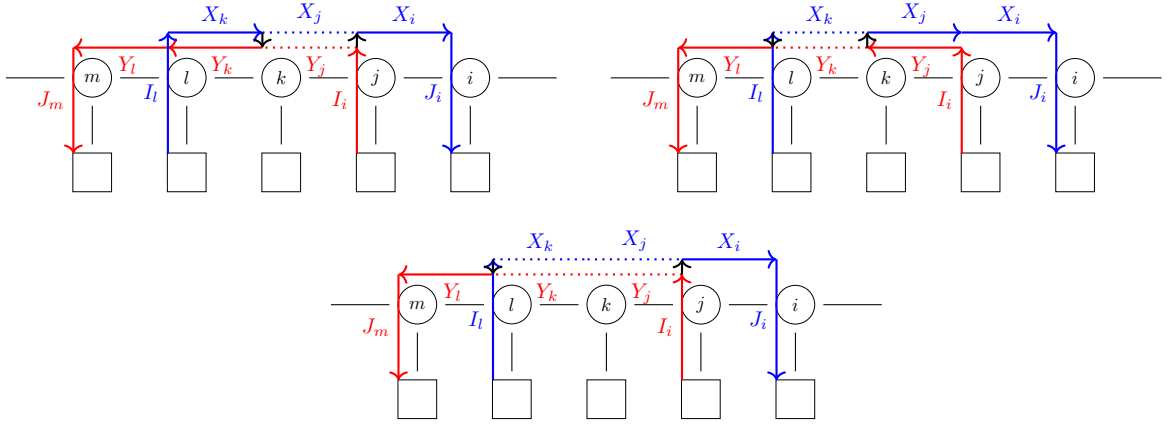

Figure 15: The OPE of two operators represented in Fig. 15 generates three singular terms as in the RHS of (6.22), each of which can be represented graphically as in this figure. As is evident from this example, the schematic structures OPEs between path operators are well represented by paths on the quiver.

Here we use the decomposition $\mathcal{W}^{-N+1}(\mathfrak{gl}(N), f) \cong \mathcal{W}^{-N+1}(\mathfrak{sl}(N), f) \otimes \widehat{\mathfrak{gl}}(1)_1$, and we take the energy momentum operator of $\mathcal{W}^{-N+1}(\mathfrak{gl}(N), f)$ to be the sum of energy momentum operators of $\mathcal{W}^{-N+1}(\mathfrak{sl}(N), f)$ and $\widehat{\mathfrak{gl}}(1)_1$ respectively. The energy momentum operator of $\mathcal{W}^k(\mathfrak{g}, f)$ for a simple Lie algebra \mathfrak{g} of level k and a nilpotent element f is given in [43, (2.5)], whose central charge is [43, (2.6)] (see also [44])

$$c(\mathfrak{g}, x, f, k) = \frac{k \dim \mathfrak{g}}{k + \mathfrak{h}_{\mathfrak{g}}^{\vee}} - 12k(x|x) - \sum_{\alpha \in S_+} (12m_{\alpha}^2 - 12m_{\alpha} + 2) - \frac{1}{2} \dim \mathfrak{g}_{1/2}, \quad (6.23)$$

Here $\{x, e, f\}$ represents the \mathfrak{sl}_2 -triple with diagonalizable x (so that $[e, f] = x, [x, e] = e, [x, f] = -f$), and $(\cdot|\cdot)$ is a non-degenerate \mathfrak{g} -invariant symmetric bilinear form. The adjoint action of x decomposes the Lie algebra into the weight spaces $\mathfrak{g} = \bigoplus_{j \in \frac{1}{2}\mathbb{Z}} \mathfrak{g}_j$. For a root $\alpha \in \mathfrak{g}_j$ we define $m_{\alpha} = j$, and S_+ denotes the set of positive roots.

Although the two expressions (6.7) and (6.23) look quite different, we verify in appendix C that

$$c_{\mathcal{V}_{\partial}^{\#} \otimes \mathcal{V}_{\text{bc}}} = 1 + c(\mathfrak{sl}(N), x, f, -N + 1), \quad (6.24)$$

where f is a nilpotent element of $\mathfrak{sl}(N)$ of type $((N-1)^{w_{N-1}} \dots i^{w_i} \dots 1^{w_1})$.

The match of the central charge discussed here is not a coincidence. Indeed, we will see in the examples explored in later sections that there are homomorphisms from $\mathcal{W}^{-N+1}(\mathfrak{gl}(N), f)$ into our H-twisted VOA \mathcal{V}_{∂} , such that the stress-energy operator of the former is mapped into the stress-energy operator T described above.

7 Higgs branch and associated varieties

In the previous section, we pointed out that the H-twisted VOA \mathcal{V} can be regarded as the chiralization of the Higgs branch. One can then ask if there is a way to extract the latter

from the former. It turns out that the answer is positive, and we can “de-chiralize” the VOA by considering Zhu’s C_2 algebra, from which we can extract the geometry of the associated variety, as we will explain in this section.

7.1 Zhu’s algebra and associated varieties

We introduce some standard concepts in the literature on vertex algebras (see e.g. [45]).

The canonical filtration⁸ F^\bullet of a vertex algebra \mathcal{V} is defined by

$$\begin{aligned} \mathcal{V} &= F^0\mathcal{V} \supset F^1\mathcal{V} \supset \dots \supset F^p\mathcal{V} \supset F^{p+1}\mathcal{V} \supset \dots, \\ F^p\mathcal{V} &:= \text{Span} \left\{ \mathcal{O}_{(-n_1-1)}^1 \cdots \mathcal{O}_{(-n_k-1)}^k | 0 \rangle \left| \mathcal{O}^1, \dots, \mathcal{O}^k \in \mathcal{V}, \sum_{i=1}^k n_i \geq p \in \mathbb{Z}_{\geq 0} \right. \right\}. \end{aligned} \quad (7.1)$$

It is known that the associated graded vector space

$$\text{gr}_F\mathcal{V} := \bigoplus_{p=0} \text{gr}_F^p\mathcal{V}, \quad \text{gr}_F^p\mathcal{V} := F^p\mathcal{V}/F^{p+1}\mathcal{V}, \quad (7.2)$$

admits a natural vertex Poisson algebra structure [45, Proposition 3.14]. Note that $\text{gr}_F\mathcal{V}$ is isomorphic to \mathcal{V} as vector spaces, while the vertex Poisson algebra structure of the former replaces the vertex operator algebra structure of the latter. In this sense, the former can be regarded as a “semiclassical analogue” of the latter.

Zhu’s C_2 -algebra of \mathcal{V} is defined to be the zeroth graded algebra

$$\mathcal{R}(\mathcal{V}) := F^0\mathcal{V}/F^1\mathcal{V}. \quad (7.3)$$

It was proven that $\mathcal{R}(\mathcal{V})$ is a Poisson algebra [45, Proposition 3.15]. We denote the image of $\mathcal{O} \in \mathcal{V}$ under the surjection $\mathcal{V} \rightarrow \mathcal{R}(\mathcal{V})$ by $\overline{\mathcal{O}}$. In physics language, Zhu’s algebra is basically generated by primary operators with respect to the global $\text{SL}(2, \mathbb{R})$ conformal group, except there are extra subtleties when we have null states relating primaries to descendants; one can also think of Zhu’s algebra as describing the dimensional reduction of the VOA [46, 47].

We say that \mathcal{V} is finitely strongly generated by a set of elements $\mathcal{O}^1, \mathcal{O}^2, \dots, \mathcal{O}^n \in \mathcal{V}$ if their images $\overline{\mathcal{O}^1}, \overline{\mathcal{O}^2}, \dots, \overline{\mathcal{O}^n} \in \mathcal{R}(\mathcal{V})$ generate $\mathcal{R}(\mathcal{V})$ as a \mathbb{C} -algebra.

We have defined Zhu’s C_2 algebra $\mathcal{R}(\mathcal{V})$ as a reduction of $\text{gr}_F\mathcal{V}$. We can conversely ask if we can recover $\text{gr}_F\mathcal{V}$ from $\mathcal{R}(\mathcal{V})$. Physically, this is natural since all we need to do is to consider the descendant operators. More mathematically, this can be answered by introducing the concept of the ∞ -jet $J_\infty\mathcal{R}(\mathcal{V})$, which admits a natural vertex Poisson algebra structure [45, Theorem 3.9]. According to [45, Theorem 3.17], there exists a natural surjective map

$$J_\infty\mathcal{R}(\mathcal{V}) \twoheadrightarrow \text{gr}_F\mathcal{V}. \quad (7.4)$$

In particular, if \mathcal{V} is finitely strongly generated by a set of elements $\mathcal{O}^1, \mathcal{O}^2, \dots, \mathcal{O}^n \in \mathcal{V}$, then \mathcal{V} is spanned by elements

$$\mathcal{O}_{(-n_1)}^{i_1} \cdots \mathcal{O}_{(-n_k)}^{i_k} | 0 \rangle, \quad \text{with } k \geq 0, n_i \geq 1.$$

⁸Also known as the Li’s filtration.

In this sense, we do not lose much information by replacing the VOA by its C_2 algebra.

The associated variety $X_{\mathcal{V}}$ is defined as the geometry corresponding to the reduced part of the C_2 algebra, i.e. geometry corresponding to the non-nilpotent part of the algebra [48]:

$$(\mathcal{R}(\mathcal{V}))_{\text{red}} = \mathbb{C}[X_{\mathcal{V}}]. \quad (7.5)$$

Summarizing, given a vertex algebra \mathcal{V} we can extract the associated variety $X_{\mathcal{V}}$ by a sequence of surjective maps

$$\mathcal{V} \rightarrow \mathcal{R}(\mathcal{V}) \rightarrow (\mathcal{R}(\mathcal{V}))_{\text{red}} = \mathbb{C}[X_{\mathcal{V}}]. \quad (7.6)$$

7.2 Conjecture

We can now formulate the following conjecture:

Conjecture 7.1. *When \mathcal{V}_{∂} is the H -twisted boundary vertex algebra for a type A linear quiver gauge theory specified by $(Q, \mathbf{v}, \mathbf{w})$, then its associated variety $X_{\mathcal{V}_{\partial}}$ can be identified with the affine quiver variety $\mathcal{M}^0(Q, \mathbf{v}, \mathbf{w})$ of the theory.*

The vertex algebra is called quasi-lisse when the associated variety has finitely many symplectic leaves. The conjecture implies that the H -twisted VOA is quasi-lisse.

Our conjecture is reminiscent of, and is partly inspired by, a similar discussion for VOAs associated with 4d $\mathcal{N} = 2$ theories [49]. As we will discuss in section 13, the precise relation between VOAs associated with 3d $\mathcal{N} = 4$ theories and those with 4d $\mathcal{N} = 2$ theories is subtle, and at this point we do not expect that the conjecture in [49] immediately implies our conjecture (or vice versa).

In our discussion to this point we have obtained the Higgs branch from the VOA. We can try to go in the other direction, by “uplifting” Higgs branch operators to BRST-closed VOA operators. In this regard, we can formulate the following corollary to Conjecture 7.1:

Corollary 7.1. *Let Q be a balanced linear quiver. We can choose a set of elements $\{\mathcal{O}^i\}$ of \mathcal{V}_{∂} such that their images under the natural map (7.6) generate $\mathbb{C}[X_{\mathcal{V}_{\partial}}] = \mathbb{C}[\mathcal{M}^0]$. Moreover, $\{\mathcal{O}^i\}$ can be taken as a subset of strong generators of the VOA.*

Notice that we have here stated “a subset of a strong generator” instead of “a strong generator”. This is because the associated variety is defined from the reduced part of Zhu’s algebra, and hence we will in general lose the information of some generators by the time we arrive at the Higgs branch. In general, we do expect some operators in the non-reduced part. For example, the stress-energy operator is BRST-closed and defines a non-trivial operator in the VOA; it is expected to be absent after passing to associated variety (cf. [49]).

8 Vertex algebra for $T_{[1^n]}^{[2, 1^{n-2}]}[\text{SU}(n)]$

In the previous sections we discussed boundary VOAs of 3d $\mathcal{N} = 4$ theories associated with linear balanced A -type quivers. In this section, we specialize further to a family of such

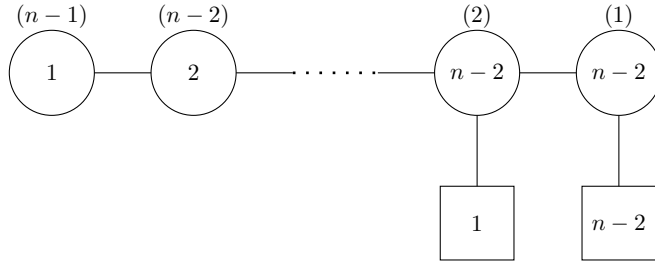

Figure 16: Quiver diagram for a $T_{[1^n]}^{[2, 1^{n-2}]}[\text{SU}(n)]$ theory. This quiver has two framing nodes (represented by boxes). The labeling of the quiver nodes is also shown as numbers in parentheses.

theories whose quivers are given in Fig. 16. These theories are $T_{[1^n]}^{[2, 1^{n-2}]}[\text{SU}(n)]$ theories in the language of section 4.

One of the important properties of the $T_{[1^n]}^{[2, 1^{n-2}]}[\text{SU}(n)]$ theories is that they have balanced quivers, as we have seen in (4.6). Since the anomaly cancellation condition (6.1) is satisfied for these examples, the simplification for the associated H-twisted VOAs is that we do not need to incorporate extra Fermi multiplets to cancel SU anomalies. (We still need to cancel U(1) anomalies, however.)

In this section, we discuss a set of BRST-closed operators. As a byproduct we afterwards propose an explicit vertex algebra homomorphism into the H-twisted boundary VOA $\mathcal{V}(T_{[1^n]}^{[2, 1^{n-2}]}[\text{SU}(n)])$ from another known VOA in the literature: the affine \mathcal{W} -algebra $\mathcal{W}^{-n+1}(\mathfrak{gl}_n, f_{\min})$, where f_{\min} refers to $[2, 1^{n-2}]$.

8.1 BRST reduction

Ingredients: Following the recipe, we assign U(1) Fermi multiplets at each gauge node i

$$(\chi_i, \psi_i)_{i=1, \dots, n-1}, \quad \text{for a gauge vertex } i, \quad (8.1)$$

symplectic bosons corresponding to scalar fields from bifundamental $\mathcal{N} = 4$ hypermultiplets

$$(X_i, Y_i)_{i=1, 2, \dots, n-2}, \quad \text{for a gauge vertex } i, \quad (8.2)$$

and symplectic bosons for scalar fields from fundamental $\mathcal{N} = 4$ hypermultiplets in flavor

$$(I_i, J_i)_{i=1, 2}, \quad \text{for gauge-flavor nodes } i, \quad (8.3)$$

where (X_i, I_i) and (Y_i, J_i) are incoming to and outgoing from the i -th vertex.

BRST currents: We can take the BRST currents defined in equation (5.12).

BRST cohomology We choose the bosonic generators for the BRST cohomology to be:⁹

⁹While not needed for the rest of the paper, let us comment on fermionic generators. It turns out that some fermionic generators are also represented by a path on the quiver diagram. This representation reproduces the examples in [8]. We can generalize fermionic BRST-closed operators charged under $U(1)_k$

- (1) Stress-energy operator $T = T_{\beta\gamma} + T_{\psi\chi} + T_{bc}$.
- (2) U(1) current: $J_F = \sum_{i=0}^{n-1} \chi_i \psi_i$.
- (3) Extension of Kac-Moody currents: $(G^{(1,1)})_j^i, (G^{(1,2)})_j, (G^{(2,1)})^i$, where $1 \leq i, j \leq n-2$

$$\begin{aligned}
(G^{(1,1)})_j^i &= (J_1)_k^i (I_1)_j^k + \chi_0 \psi_0 \delta_j^i, \\
(G^{(1,2)})_j^1 &= (J_1)_k^1 (X_1)_i^k (I_2)_j^i, \\
(G^{(2,1)})_1^i &= (J_2)_j^i (Y_1)_k^j (I_1)_1^k,
\end{aligned} \tag{8.5}$$

The currents listed in equations (8.5) are associated to particularly simple paths as in Fig. 17 on the quiver diagram depicted in Fig. 16.

We claim that it is sufficient to consider only these three types of operators, out of many operators of the form (6.20). This is proven in appendix D.

Moment Map

$$(\tilde{\mu}_{\text{ch},i})^a_b = X_i^a Y_{i,b} - Y_{i-1}^a X_{i-1,b} + \delta_b^a (\chi_{i-1} \psi_{i-1} - \chi_i \psi_i) + I_i^a J_{i,b} \delta_{(i<3)}. \tag{8.6}$$

8.2 Map from \mathcal{W} -algebra to boundary VOA

We now claim there exists an injection as a VOA from an affine W -algebra $\mathcal{W}^{-n+1}(\mathfrak{gl}_n, f_{\min})$ into the H-twisted VOA for the $T_{[1^n]}^{[2,1^{n-2}]}[\text{SU}(n)]$ theory, where f_{\min} refers to $[2, 1^{n-2}]$.

The strong generators and their OPEs for $\mathcal{W}^{-n+1}(\mathfrak{gl}_n, [2, 1^{n-2}])$ were obtained by Ueda [50].¹⁰ The strong generators are given by

$$\left\{ W_{i,j}^{(1)} \mid 1 \leq i \leq n-2, 1 \leq j \leq n-1 \text{ or } i = j = n-1 \right\} \cup \left\{ W_{i=n-1,j}^{(2)} \mid 1 \leq j \leq n-1 \right\}, \tag{8.7}$$

as in [8] as

$$\begin{aligned}
\mathcal{O}_0 &= \psi_0 \epsilon^{ij} \epsilon_{ab} I_{1,i}^a I_{1,j}^b, \\
\mathcal{O}_1 &= \psi_1 \epsilon^{ab} J_{2,a} J_{2,b}, \\
\mathcal{O}_2 &= \psi_2 \epsilon^{ab} Y_{2,a} J_{2,b}, \\
\mathcal{O}_3 &= \psi_3 X_2^a J_{2,a},
\end{aligned} \tag{8.4}$$

Operators in (8.4) are charged under the Coulomb branch symmetry.

¹⁰We have $[2, 1^{n-2}]$, whereas [50] has $[2^n, 1^{m-n}]$. So we need to send $n_{\text{there}} \rightarrow 1, m_{\text{there}} \rightarrow n-1$, and hence $m_{\text{there}} - n_{\text{there}} \rightarrow n-2$, in the result from [50]. We take the level to be $k = -n+1$, which sets the parameter α_1, α_2 in [50] as $\alpha_1 = -n+2, \alpha_2 = 0$.

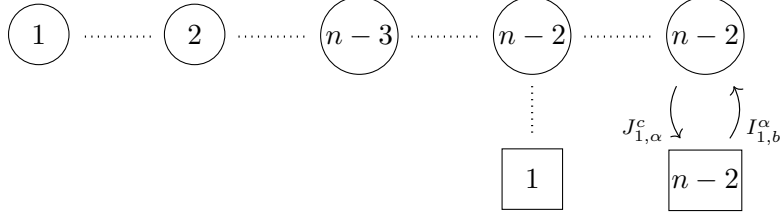

(a) The path for $G^{(1,1)}$

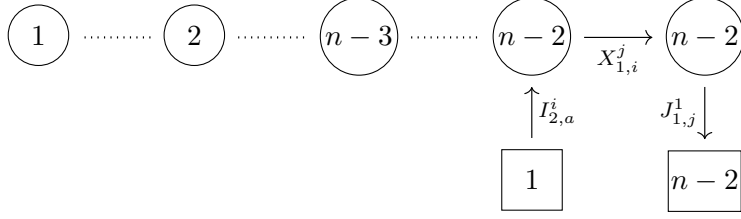

(b) The path of $G^{(1,2)}$

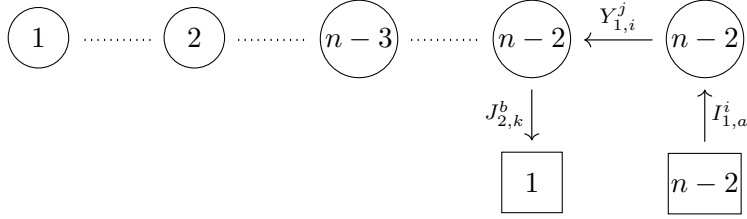

(c) The path of $G^{(2,1)}$

Figure 17: Simple paths on the quiver diagram from Fig. 16, for BRST closed operators.

and their OPEs are given by:

$$\begin{aligned}
(W_{p,q}^{(1)})_{(0)} W_{i,j}^{(2)} &= -\delta_{p,j} W_{i,q}^{(2)} + \delta_{i,q} \delta(p > 2) W_{p,j}^{(2)} + \delta(p \leq 2, q > 2) (W_{p,j}^{(1)})_{(-1)} W_{i,q}^{(1)} \\
&\quad - \delta_{i,q} \delta(p \leq 2) \sum_{w \leq 2} (W_{w,j}^{(1)})_{(-1)} W_{p,w}^{(1)}, \\
(W_{p,q}^{(1)})_{(1)} W_{i,j}^{(2)} &= \delta_{p,j} \alpha_1 \delta(q > 2) W_{i,q}^{(1)} - \delta_{i,q} \delta(p \leq 2) \alpha_1 W_{p,j}^{(1)} \\
&\quad + \delta_{p,q} \delta(j > 2) W_{i,j}^{(1)} - \delta_{i,j} \delta(q \leq 2) W_{p,q}^{(1)} + \delta_{p,j} \delta_{q,i} \sum_{w \leq 2} W_{w,w}^{(1)}, \\
(W_{p,q}^{(1)})_{(2)} W_{i,j}^{(2)} &= -\delta_{q,i} \delta_{p,j} \alpha_1^2 - \delta_{p,q} \delta_{i,j} \delta(p, q \leq 2) \alpha_1, \\
(W_{p,q}^{(1)})_{(s)} W_{i,j}^{(2)} &= 0 \quad \forall s > 2.
\end{aligned} \tag{8.8}$$

Here $(\mathcal{O}_1)_{(n)}(\mathcal{O}_2)$ for $n = 0, 1, \dots$ are defined from the OPE of the operators as

$$\mathcal{O}_1(z)\mathcal{O}_2(w) \sim \sum_n \frac{1}{(z-w)^{n+1}} ((\mathcal{O}_1)_{(n)}(\mathcal{O}_2))(w), \quad (8.9)$$

with $\alpha_1 := -n + 2$.

We propose the following map from an affine W -algebra $\mathcal{W}^{-n+1}(\mathfrak{gl}_n, f_{\min})$ into the bosonic part of the H-twisted VOA for the $T_{[1^n]}^{[2, 1^{n-2}]}[\mathrm{SU}(n)]$ theory:

$$W_{i,j}^{(1)} = (G^{(1,1)})_j^i, \quad 1 \leq i, j \leq n-2, \quad (8.10)$$

$$W_{i,n-1}^{(1)} = (G^{(1,2)})^i, \quad 1 \leq i \leq n-2, \quad (8.11)$$

$$W_{n-1,n-1}^{(1)} = J_F - \sum_{i=1}^{n-2} (G^{(1,1)})_i^i, \quad (8.12)$$

$$W_{n-1,l}^{(2)} = (G^{(2,1)})_l, \quad 1 \leq l \leq n-2, \quad (8.13)$$

$$\begin{aligned} W_{n-1,n-1}^{(2)} = &: \chi_{(0)}\psi_{(0)}W_{n-1,n-1}^{(1)} : + : X_{1,b}^c Y_{1,c}^a : : J_{2,a}^1 I_{2,1}^b : : + \mathrm{Tr}(\mathbf{b}_1 \partial \mathbf{c}_1) \\ &- (: \partial J_{1,a}^i I_{1,i}^a : - : \partial X_{1,a}^b Y_{1,b}^a : - (n-2) : J_{1,a}^1 \partial I_{2,1}^a : + \partial \chi_0 \psi_0 - \chi_0 \partial \psi_0). \end{aligned} \quad (8.14)$$

In principle it is a matter of computations to verify that our proposed map is a vertex algebra homomorphism. Some OPEs are easier to verify. For example, we can check OPEs between $W^{(1)}$'s as follows:

$$W_{p,q}^{(1)}(z)W_{i,j}^{(1)}(w) \sim \frac{(2-n)\delta_{p,j}\delta_{q,i} + \delta_{p,q}\delta_{i,j}(1 + \delta(p, i > n-2))}{(z-w)^2} + \frac{\delta_{q,i}W_{p,j}^{(1)}(w) - \delta_{p,j}W_{i,q}^{(1)}(w)}{z-w}. \quad (8.15)$$

We can also check some of the OPEs by remembering the discussions in terms of paths in section 6.3. In general, however, the OPEs are complicated and require repeated use of the moment map relations. We will discuss the special case of $n = 4$ in detail in the next section, where we check explicitly all the relations of the \mathcal{W} -algebra (and hence prove that we have a vertex algebra homomorphism).

Later we will show that the map (8.14) is indeed a vertex algebra map for all $n \geq 3$, and in fact it is injective, see section 12.3. But there is a caveat: we need to modify the target of the map (8.14). Namely what we actually find is a vertex algebra map from $\mathcal{W}^{-n+1}(\mathfrak{gl}_n, f_{\min})$ to a certain vertex algebra denoted by $\mathrm{D}^{\mathrm{ch}}(\widetilde{\mathcal{M}})$, which can be regarded as a ‘‘chiralization’’ of the extended Higgs branch $\widetilde{\mathcal{M}}$. $\mathrm{D}^{\mathrm{ch}}(\widetilde{\mathcal{M}})$ is closely related to the H-twisted boundary vertex algebra of $T_{[1^n]}^{[2, 1^{n-2}]}[\mathrm{SU}(n)]$ theory, in the sense that there exists a vertex algebra map $\mathcal{V}_{\partial,0} \rightarrow \mathrm{D}^{\mathrm{ch}}(\widetilde{\mathcal{M}})$, where $\mathcal{V}_{\partial,0}$ is the degree zero component in the decomposition (6.11). When $n = 4$, we can show that such map is injective, thus providing another way to show that (8.14) is a vertex algebra map.

Before proceeding to the computation of OPE, we note that the map (8.14) is a vertex algebra homomorphism (instead of a VOA homomorphism) and have not specified the stress-energy operator (i.e. conformal vector). It will be shown in the later section that our stress-energy operator T in (6.5) is in the image of $\mathcal{W}^{-n+1}(\mathfrak{gl}_n, f_{\min})$, moreover it equals

and using the moment map again, we find

$$\underbrace{\chi_0\psi_0 + \chi_1\psi_1 - W_{3,3}^{(1)} + : J_{2,a}^1 I_{2,1}^a :}_{\text{Tr}(\mu_1 + \mu_2 + \mu_3)} = 0, \quad (8.21)$$

therefore $(W_{1,3}^{(1)})_{(0)}W_{3,2}^{(2)}$ agrees with [50]. On the other hand, we verified

$$(W_{1,3}^{(1)})_{(1)}W_{3,2}^{(2)} = 2W_{1,2}^{(1)}, \quad (W_{1,3}^{(1)})_{(n)}W_{3,2}^{(2)} = 0, \quad \forall n > 1. \quad (8.22)$$

Hence $W_{1,3}^{(1)}W_{3,2}^{(2)}$ OPE are checked in all orders.

$W_{1,3}^{(1)}W_{3,1}^{(2)}$ **OPE**

- 1 $(W_{1,3}^{(1)})_{(2)}W_{3,1}^{(2)}$ OPE is easily checked.
- 2 $(W_{1,3}^{(1)})_{(1)}W_{3,1}^{(2)}$ OPE is checked with the combinations of the moment map equations listed below.

The moment map for $(W_{1,3}^{(1)})_{(1)}W_{3,1}^{(2)}$: $-3\text{Tr}(\mu_1) - 2\text{Tr}(\mu_2) - 2\text{Tr}(\mu_3)$

$$(W_{1,3}^{(1)})_{(1)}W_{3,1}^{(2)} = -2W_{3,3}^{(1)} + 3W_{1,1}^{(1)} + W_{2,2}^{(1)} - 3\text{Tr}(\mu_1) - 2\text{Tr}(\mu_2) - 2\text{Tr}(\mu_3). \quad (8.23)$$

- 3 $(W_{1,3}^{(1)})_{(0)}W_{3,1}^{(2)}$ OPE is checked by

$$\begin{aligned} & (W_{1,3}^{(1)})_{(0)}W_{3,1}^{(2)} + \sum_{w \leq 2} (W_{w,1}^{(1)})_{(-1)}W_{1,w}^{(1)} - (W_{1,1}^{(1)})_{(-1)}W_{3,3}^{(1)} + W_{3,3}^{(2)} \\ &= \underbrace{W_{3,3}^{(2)} - : W_{1,1}^{(1)}W_{3,3}^{(1)} : + : \partial J_{1,a}^i I_{1,i}^a : - : \partial X_{1,a}^b Y_{1,b}^a : - 2 : J_{2,a}^1 \partial I_{2,1}^a : + \partial \chi_0 \psi_0 - \chi_0 \partial \psi_0}_{W_{3,3}^{(2)} - (W_{3,3}^{(2)} - \text{Tr}(b\partial c)) = \text{Tr}(b\partial c)} \\ &+ \underbrace{: J_{1,b}^1 I_{1,1}^a : (\chi_0 \psi_0 + \chi_1 \psi_1) + : J_{1,a}^1 I_{1,1}^a :: J_{2,b}^1 I_{2,1}^b : - : J_{1,b}^1 I_{1,1}^a W_{3,3}^{(1)} :}_{: J_{1,a}^1 I_{1,1}^a : \text{Tr}(\mu_1 + \mu_2 + \mu_3) = 0} \\ &+ \underbrace{: J_{1,a}^1 I_{1,1}^a : (\chi_0 \psi_0 - \chi_1 \psi_1) + : J_{1,b}^1 I_{1,1}^a :: X_{1,c}^b Y_{1,a}^c :: + : J_{1,b}^1 I_{1,1}^a :: I_{1,k}^b J_{1,a}^k ::}_{: J_{1,b}^1 I_{1,1}^a : (\mu_1)_a^b = -\text{Tr}(b\partial c)} \\ &= 0, \end{aligned} \quad (8.24)$$

where in the last step we have used the fact that $: J_{1,b}^1 I_{1,1}^a :$ transforms under the μ_1 as an adjoint representation with anomalous level -1 , and discussion in appendix B.1 implies that $:: J_{1,b}^1 I_{1,1}^a : (\mu_1)_a^b :$ is BRST equivalent to $-\text{Tr}(b\partial c)$.

$W_{2,3}^{(1)}W_{3,2}^{(2)}$ **OPE** The computation is essentially the same as the $W_{1,3}^{(1)}W_{3,1}^{(2)}$ OPE, and we do not repeat here.

$W_{1,3}^{(1)}W_{3,3}^{(2)}$ and $W_{2,3}^{(1)}W_{3,3}^{(2)}$ **OPE**

$$\begin{aligned} & (W_{1,3}^{(1)})_{(0)}W_{3,3}^{(2)} + : W_{1,3}^{(1)}(W_{1,1}^{(1)} - W_{3,3}^{(1)}) : + : W_{2,3}^{(1)}W_{1,2}^{(1)} : \\ &= : W_{1,3}^{(1)}\text{Tr}(\mu_1 + \mu_2 + \mu_3) : - : J_{1,b}^1 X_{1,c}^a I_{2,1}^c : (\mu_1)_a^b = 0. \end{aligned} \quad (8.25)$$

$$\begin{aligned} & (W_{2,3}^{(1)})_{(0)}W_{3,3}^{(2)} + : W_{2,3}^{(1)}(W_{2,2}^{(1)} - W_{3,3}^{(1)}) : + : W_{1,3}^{(1)}W_{2,1}^{(1)} : \\ &= : W_{2,3}^{(1)}\text{Tr}(\mu_1 + \mu_2 + \mu_3) : - : J_{1,b}^2 X_{1,c}^a I_{2,1}^c : (\mu_1)_a^b = 0. \end{aligned} \quad (8.26)$$

9 Vertex algebra for $T_{[1^{2n}]}^{[n,n]}[\text{SU}(2n)]$

Let us next discuss one more example of a class of balanced quivers, those for the $T_{[1^{2n}]}^{[n,n]}[\text{SU}(2n)]$ theories. The corresponding quiver is presented in Fig. 18.

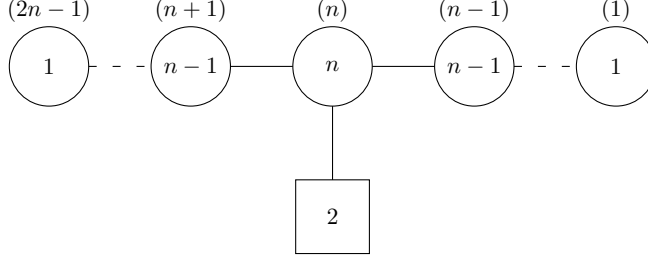

Figure 18: A quiver diagram for $T_{[1^{2n}]}^{[n,n]}[\text{SU}(2n)]$

9.1 General n

Ingredients: Following the recipe, we assign U(1) Fermi multiplets at each gauge node i

$$(\chi_i, \psi_i)_i, \quad i = 1, \dots, 2n-1, \quad (9.1)$$

Symplectic bosons:

$$(X_i, Y_i)_{i=1,2,\dots,2n-2}, \quad (I_i, J_i)_{i=n}, \quad (9.2)$$

where $(X_i, I_i)_i$ and $(Y_i, J_i)_i$ are incoming to and outgoing from the i -th vertex.

The moment maps are

$$(\mu_i)^\alpha_\beta = X_i^\alpha Y_{i,\beta} - Y_{i-1}^\alpha X_{i-1,\beta} + \delta^\alpha_\beta (\chi_{i-1} \psi_{i-1} - \chi_i \psi_i) + I_a^\alpha J_\beta^a \delta_{i,n}, \quad (9.3)$$

where $i = 1, \dots, 2n-2$, and $a = 1, 2$.

The BRST cohomology consists of T , $\{(G^{(i)})^a_b\}$, and $J_F = \sum_i \chi_i \psi_i$ as before. The extension of Kac-Moody currents is represented by n independent paths on the quiver in Fig. 18. All of the bosonic operators corresponding to paths on the quiver are written as below,

$$\begin{aligned} & J^a \underbrace{X_n \cdots X_{n+k_1-1}}_{k_1} \underbrace{Y_{n+k_1-1} \cdots Y_{n-k_2}}_{k_1+k_2} \underbrace{X_{n-k_2} \cdots X_{n-1}}_{k_2} I_b, \\ & J^a \underbrace{Y_{n-1} \cdots Y_{n-k_1}}_{k_1} \underbrace{X_{n-k_1} \cdots X_{n+k_2-1}}_{k_1+k_2} \underbrace{Y_{n+k_2-1} \cdots Y_n}_{k_2} I_b, \end{aligned} \quad (9.4)$$

where $k_i = 0, \dots, n-1$, and we omit all dummy indices that are contracted. One may choose for example the linearly independent bosonic operators to correspond to paths on the quiver that begin at the framing node, turn left at the rank- n gauge node and loop around the rank- $(n+k)$ gauge node for some $0 \leq k \leq 2n-1$, before returning to the framing node. All of the other bosonic operators, which correspond to the remaining possible paths, are

related to these via the moment map relations. The corresponding BRST closed operators are $(G^{(1)})_b^a$ and $(G^{(m+1)})_b^a$ of the form

$$(G^{(1)})_b^a = J^a I_b + \frac{1}{2} \delta_b^a \left(\sum_{k=0}^{n-1} \chi_k \psi_k - \sum_{k=n}^{2n-1} \chi_k \psi_k \right), \quad (9.5)$$

$$(G^{(m)})_b^a = J^a \underbrace{X_n \cdots X_{n+m-2}}_{n \geq m \geq 2} \underbrace{Y_{n+m-2} \cdots Y_n}_{n \geq m \geq 1} I_b + (\text{corr.}), \quad (9.6)$$

for $2 \leq m \leq n$ and where (corr.) represent correction terms involving $(G^{(m')})_b^a$ with $m' < m$ and fermion bilinears.

9.2 $n = 2$

9.2.1 BRST reduction

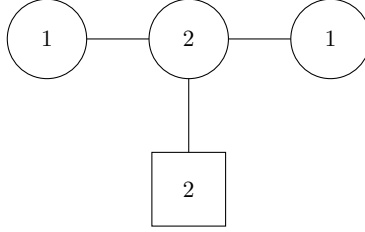

Figure 19: A quiver for a rectangular \mathcal{W} -algebra

Following the recipe in section 5.1, we have the ingredients for boundary VOA of the H-twisted $T_{[1,1,1,1]}^{[2,2]}[\text{SU}(4)]$ theory:

$$X_{1,\alpha}, Y_1^\alpha, X_2^\alpha, Y_{2,\alpha}, I_a^\alpha, J_a^\alpha, \quad (\alpha, a = 1, 2), \quad \chi_i, \psi_i, \quad (i = 0, 1, 2, 3). \quad (9.7)$$

with the gauge and the flavor indices α and a respectively.

Moment map relations

$$\mu_1 = X_{1,\alpha} Y_1^\alpha + (\chi_0 \psi_0 - \chi_1 \psi_1), \quad (9.8)$$

$$(\mu_2)^\alpha_\beta = X_2^\alpha Y_{2,\beta} - Y_1^\alpha X_{1,\beta} + \delta^\alpha_\beta (\chi_1 \psi_1 - \chi_2 \psi_2) + I_a^\alpha J_\beta^a, \quad (9.9)$$

$$\mu_3 = -Y_{2,\alpha} X_2^\alpha + (\chi_2 \psi_2 - \chi_3 \psi_3). \quad (9.10)$$

We can write down the following set of bosonic operators which are classically gauge invariant

$$\left\{ J_a^\alpha I_b^\alpha, J_\alpha^a Y_1^\alpha X_{1,\beta} I_b^\beta, J_\alpha^a X_2^\alpha Y_{2,\beta} I_b^\beta, J_\alpha^a X_2^\alpha Y_\beta Y_1^\beta X_{1,\gamma} I_b^\gamma \right\}. \quad (9.11)$$

Following the strategy for the general n , one may choose the bosonic operators corresponding to paths on the quiver that begin at the framing node and turn left at the rank-2 gauge node before returning to the starting point, namely the operators $J_\alpha^a I_b^\alpha$ and $J_\alpha^a X_2^\alpha Y_{2,\beta} I_b^\beta$.

BRST cohomology The bosonic generators for the BRST cohomology are:

- (1) Stress-energy operator $T = T_{\beta\gamma} + T_{\psi\chi} + T_{bc}$.
- (2) U(1) current: $J_F = \sum_{i=0}^3 \chi_i \psi_i$.
- (3) Extension of Kac-Moody currents: $(G^{(1)})^a_b, (G^{(2)})^a_b$.

From all the possible paths, the extension of Kac-Moody currents are chosen as

$$(G^{(1)})^a_b = J_\alpha^a I_b^\alpha + \frac{1}{2} \delta_b^a (\chi_0 \psi_0 + \chi_1 \psi_1 - \chi_2 \psi_2 - \chi_3 \psi_3), \quad (9.12)$$

$$(G^{(2)})^a_b = -(J_\alpha^a X_2^\alpha)_{(-1)} Y_{2,\beta} I_b^\beta + \rho (G^{(1)})^a_b - (\rho^2 + \partial\rho) \delta_b^a, \quad (9.13)$$

where $\rho = (3b_3 - b_2 - b_1 - b_0)/4$. The free bosons b_0, \dots, b_3 are introduced such that $b_i(z)b_j(w) \sim \delta_{ij}/(z-w)^2$, and b_i is related to the free fermions by $b_i = \chi_i \psi_i$.

We will come back to this example in section 12.2. We will see, in particular, that the two generators $G^{(1)}$ and $G^{(2)}$, after a suitable combination with the current J_F , will be mapped the strong generators of the rectangular \mathcal{W} -algebra $\mathcal{W}^{-3}(\mathfrak{gl}_4, [2^2])$.

We remark now that the VOA of the H-twisted $T_{[1,1,1,1]}^{[2,2]}[\text{SU}(4)]$ theory can also be obtained by the quiver reduction of the $T_{[1,1,1,1]}^{[2,1,1]}[\text{SU}(4)]$ theory, up to gauging of a U(1) framing, by specializing the discussion in section 12.3.

10 Localization of quiver vertex algebra

In section 8 and section 9, we have discussed the homomorphism from affine W-algebras into our VOAs. The practical computations, however, become rather involved as we consider more complicated quivers, and it is clearly desirable to have a systematic procedure for analyzing the VOAs associated with general linear quivers.

Fortunately, there indeed exists such a systematic procedure, which we will discuss in detail in the coming three sections. One of the motivations comes from the by-now-familiar motto that the VOA is a chiralization of the Higgs branch. On the geometry side, while the geometry of the Higgs branch is complicated in itself, one can always choose a local patch to simplify the geometry dramatically. There is a vertex algebra counterpart of this statement, in the form of the localizations of the quiver vertex algebras.

In this section, we sketch the \hbar -adic vertex algebra and its sheaf version, define the \hbar -adic BRST cohomology and its sheaf version, and state the main result (vanishing theorem and injectivity theorem), which will be proven in the companion paper [16].

The quiver vertex algebra $\mathcal{V}(Q, \mathbf{v}, \mathbf{w})$ can be thought as a vertex algebra analog of the extended quiver variety $\widetilde{\mathcal{M}}^0(Q, \mathbf{v}, \mathbf{w})$ (3.10), which is defined as the affine quotient

$$\widetilde{\mathcal{M}}^0(Q, \mathbf{v}, \mathbf{w}) := \widetilde{\mu}^{-1}(0) // \text{GL}(\mathbf{v}),$$

where $\mathrm{GL}(\mathbf{v}) = \prod_{i \in Q_0} \mathrm{GL}(\mathbf{v}_i)$ is the complexified gauge group (3.6), and $\tilde{\mu} : T^*\mathrm{Rep}(Q, \mathbf{v}, \mathbf{w}) \times \mathbb{C}^{Q_0} \rightarrow \mathfrak{gl}(\mathbf{v})^*$ is the extended moment map:

$$\tilde{\mu}((X, Y, I, J) \in T^*\mathrm{Rep}(Q, \mathbf{v}, \mathbf{w}), h \in \mathbb{C}^{Q_0}) = \left(\sum_{a:j \rightarrow i} X_a Y_a - \sum_{b:i \rightarrow j} Y_b X_b + I_i J_i + h_i \right)_{i \in Q_0} .$$

Suppose that $U \subset T^*\mathrm{Rep}(Q, \mathbf{v}, \mathbf{w}) \times \mathbb{C}^{Q_0}$ is a $\mathrm{GL}(\mathbf{v})$ -invariant open subset, then there is a natural map between varieties

$$(\tilde{\mu}^{-1}(0) \cap U) // \mathrm{GL}(\mathbf{v}) \rightarrow \widetilde{\mathcal{M}}^0(Q, \mathbf{v}, \mathbf{w}) .$$

A distinguished choice of such U is the stable locus, which consists of those (X, Y, I, J, z) such that the actions of X, Y on the image of I generate all gauge node vector spaces. Denote by $\tilde{\mu}^{-1}(0)^{\mathrm{st}}$ the intersection between $\tilde{\mu}^{-1}(0)$ and the stable locus, then the extended Nakajima quiver variety $\widetilde{\mathcal{M}}(Q, \mathbf{v}, \mathbf{w})$ is defined as the quotient

$$\widetilde{\mathcal{M}}(Q, \mathbf{v}, \mathbf{w}) := \tilde{\mu}^{-1}(0)^{\mathrm{st}} // \mathrm{GL}(\mathbf{v}) ,$$

and it has a natural projection $\pi : \widetilde{\mathcal{M}}(Q, \mathbf{v}, \mathbf{w}) \rightarrow \widetilde{\mathcal{M}}^0(Q, \mathbf{v}, \mathbf{w})$. By the geometric invariant theory, π is a projective morphism. When the moment map μ is flat¹², the projection π induces an isomorphism between global sections of structure sheaf, i.e.

$$\mathbb{C}[\widetilde{\mathcal{M}}^0(Q, \mathbf{v}, \mathbf{w})] \cong \Gamma(\widetilde{\mathcal{M}}(Q, \mathbf{v}, \mathbf{w}), \mathcal{O}_{\widetilde{\mathcal{M}}(Q, \mathbf{v}, \mathbf{w})}) .$$

The variety $\widetilde{\mathcal{M}}(Q, \mathbf{v}, \mathbf{w})$ is smooth, and the quotient map $q : \tilde{\mu}^{-1}(0)^{\mathrm{st}} \rightarrow \widetilde{\mathcal{M}}(Q, \mathbf{v}, \mathbf{w})$ is a principal $\mathrm{GL}(\mathbf{v})$ -bundle, whereas $\widetilde{\mathcal{M}}^0(Q, \mathbf{v}, \mathbf{w})$ is singular in general and the action of $\mathrm{GL}(\mathbf{v})$ on $\tilde{\mu}^{-1}(0)$ is always non-free, this makes $\widetilde{\mathcal{M}}(Q, \mathbf{v}, \mathbf{w})$ a better geometric object to study than $\widetilde{\mathcal{M}}^0(Q, \mathbf{v}, \mathbf{w})$.

For simplicity we will abbreviate $\widetilde{\mathcal{M}}(Q, \mathbf{v}, \mathbf{w})$ (resp. $\widetilde{\mathcal{M}}^0(Q, \mathbf{v}, \mathbf{w})$) to $\widetilde{\mathcal{M}}$ (resp. $\widetilde{\mathcal{M}}^0$).

Such a construction has a vertex algebra analog. To properly state it, we need to make sense of sheafification of vertex algebra. In the classical world, i.e. in a commutative algebra, this is captured by the notion of localization. For quantized operators, we need to be careful about in what sense we localize. For example the Weyl algebra $D(\mathbb{C}^2) := \mathbb{C}\langle x, y \rangle / ([x, y] - 1)$ can be localized just for the variable x , or just for the variable y . Namely, we can consider $f(x)g(x, y)$ where $f(x)$ is a rational function of x and $g(x, y)$ is a polynomial in x, y , then the commutator $[f_1(x)g_1(x, y), f_2(x)g_2(x, y)]$ is well-defined, in this sense the Weyl algebra can be localized with respect to x . Similarly, it can be localized with respect to y . If we attempt to localize with respect to both x and y , however, then we immediately run into a problem: the commutator $[x^{-1}, y^{-1}]$ does not make sense. To cure this issue, one can introduce an \hbar -adic version of the Weyl algebra $D(\mathbb{C}^2)_{\hbar} := \mathbb{C}[[\hbar]]\langle x, y \rangle / ([x, y] - \hbar)$, where we treat \hbar as a formal variable, then it makes sense to define the \star -multiplication as

$$F(x, y) \star G(x, y) := m \circ e^{\frac{\hbar}{2} \partial_x \wedge \partial_y} (F(x, y) \otimes G(x, y)) ,$$

¹²In fact, the moment map μ is flat if and only if π induces an isomorphism between global sections of the structure sheaf.

where F, G are arbitrary rational functions in x, y , and m is the usual multiplication for rational functions. The RHS is treated as a power series in \hbar . The \star product allows us to define a sheaf $\mathcal{D}_{\mathbb{C}^2, \hbar}$ of non-commutative algebras on \mathbb{C}^2 such that $D(\mathbb{C}^2)_\hbar = \Gamma(\mathbb{C}, \mathcal{D}_{\mathbb{C}^2, \hbar})$.

The lesson we learn from the example of Weyl algebra is that localization might involve infinite sums, which can be made sense of by allowing formal power series with the aid of formal variables. For vertex algebras, a notion of \hbar -adic vertex algebra was introduced in [52]. The formal definition is as follows. An \hbar -adic vertex algebra is a tuple $(V, |0\rangle, \partial, Y(-, z))$ such that V is a flat $\mathbb{C}[[\hbar]]$ -module complete in \hbar topology, and $Y(-, z) : V \rightarrow \text{End}_{\mathbb{C}[[\hbar]]}(V)[[z^\pm]]$ is a $\mathbb{C}[[\hbar]]$ -linear map such that

1. $a_{(n)}$ is continuous with respect to the \hbar -adic topology, for all $a \in V, n \in \mathbb{Z}$.
2. $(V/\hbar^N V, |0\rangle, \partial, Y(-, z))$ is a vertex algebra for all $N \in \mathbb{Z}_{\geq 1}$.

An example of \hbar -adic vertex algebra is a $\beta\gamma$ -system:

$$\beta(z)\gamma(w) \sim \frac{\hbar}{z-w}.$$

In this example, the underlying vector space (vacuum module) is

$$D^{\text{ch}}(\mathbb{C}^2)_\hbar := \mathbb{C}[[\hbar]][[\beta_{(-n)}, \gamma_{(-n)} \mid n \in \mathbb{Z}_{\geq 1}]]|0\rangle.$$

Note that $D^{\text{ch}}(\mathbb{C}^2)/(\hbar)$ is a commutative vertex algebra, in fact a vertex Poisson algebra, which is isomorphic to the coordinate ring on the jet bundle $J_\infty \mathbb{C}^2$ endowed with the natural vertex Poisson algebra structure induced by the Poisson structure on $\mathbb{C}^2 = T^*\mathbb{C}$.

We define a sheaf of \hbar -adic vertex algebra $\mathcal{D}_{\mathbb{C}^2, \hbar}^{\text{ch}}$ on \mathbb{C}^2 by

$$\mathcal{D}_{\mathbb{C}^2, \hbar}^{\text{ch}}(U_f) := \mathbb{C}[J_\infty U_f][[\hbar]]$$

where f is a polynomial in β, γ , and $U_f \subset \mathbb{C}^2$ is the open subset of nonzero locus of f . The \hbar -adic vertex algebra structure on the the vector space $\mathbb{C}[J_\infty U_f][[\hbar]]$ is defined using Wick's contraction formula:

$$A(z)B(w) \sim: e^{\frac{\hbar}{z-w}\partial_\beta \wedge \partial_\gamma} (A(z) \otimes B(w)) :$$

where $A, B \in \mathbb{C}[\partial^n \beta, \partial^n \gamma \mid n \in \mathbb{Z}_{\geq 0}][[f^{-1}]]$, and $::$ is the normal-ordered product. For example let $f = \beta\gamma$, then take $A = \beta^{-1}$ and $B = \gamma^{-1}$, the OPE reads:

$$\beta^{-1}(z)\gamma^{-1}(w) \sim \sum_{n=1}^{\infty} n! \hbar^n \frac{\beta^{-n-1}(z)\gamma^{-n-1}(w)}{(z-w)^n}.$$

The above example naturally generalizes to multiple pairs of $\beta\gamma$'s, i.e. we have

$$D^{\text{ch}}(T^*\mathbb{C}^m)_\hbar = D^{\text{ch}}(T^*\mathbb{C})_\hbar^{\otimes m}$$

for all $m \in \mathbb{Z}_{\geq 1}$. The choice of coordinate system on \mathbb{C}^m does not affect the \hbar -adic vertex algebra structure on $D^{\text{ch}}(T^*\mathbb{C}^m)_\hbar$, so we will simply write it as $D^{\text{ch}}(T^*V)_\hbar$, where V is

an m -dimensional vector space. We can define the localization of $D^{\text{ch}}(T^*V)_{\hbar}$ using Wick's contraction formula, and therefore get a sheaf of \hbar -adic vertex algebras on T^*V , denoted by $\mathcal{D}_{T^*V, \hbar}^{\text{ch}}$; $\mathcal{D}_{T^*V, \hbar}^{\text{ch}}$ is called the sheaf of chiral differential operators (CDO) on T^*V .

We can also sheafify the more general $\beta\gamma\text{bc}$ system, i.e. the \hbar -adic vertex superalgebra $D^{\text{ch}}(T^*(V \oplus \Pi S))_{\hbar}$, where V and S are vectors spaces and ΠS is the odd vector space associated to S . We only localize the bosonic variables, i.e. only the $\beta\gamma$ part is allowed to take the inverse. Then we get a sheaf of \hbar -adic vertex superalgebras $\mathcal{D}_{T^*(V \oplus \Pi S), \hbar}^{\text{ch}}$ on the variety T^*V .

Another example is the \hbar -adic Heisenberg algebra and its localization. Let $W = \bigoplus_{i=1}^m \mathbb{C} \cdot a^i$ be a vector space, endowed with a symmetric inner product (\cdot, \cdot) , then we define \hbar -adic vertex algebra

$$\mathcal{H}(W, (\cdot, \cdot))_{\hbar} := \mathbb{C}[[\hbar]][a_{(-n)}^1, \dots, a_{(-n)}^m \mid n \in \mathbb{Z}_{\geq 1}] | 0 \rangle,$$

whose \hbar -adic vertex algebra structure is given by the OPE

$$a^i(z)a^j(w) \sim \frac{\hbar^2(a^i, a^j)}{(z-w)^2}.$$

Since the Heisenberg algebra also has the Wick contraction formula, we can define its localization similarly to the localization of $\beta\gamma$ system. Namely for a polynomial $f \in \mathbb{C}[a^1, \dots, a^m]$, and $A, B \in \mathbb{C}[\partial^n a^1, \dots, \partial^n a^m \mid n \in \mathbb{Z}_{\geq 0}][[f^{-1}]]$, the OPE reads

$$A(z)B(w) \sim: e^{\frac{\hbar^2(a^i, a^j)}{(z-w)^2} \partial_{a^i} \otimes \partial_{a^j}} (A(z) \otimes B(w)):$$

where $::$ is the normal-ordered product. For example let $f = a^1 a^2$, then take $A = a^1$ and $B = a^2$, the OPE reads:

$$(a^1)^{-1}(z)(a^2)^{-1}(w) \sim \sum_{n=1}^{\infty} n! \hbar^{2n} (a^1, a^2)^n \frac{(a^1)^{-n-1}(z)(a^2)^{-n-1}(w)}{(z-w)^{2n}}.$$

We define a sheaf $\mathcal{H}_{W, \hbar}^{(\cdot, \cdot)}$ by

$$\mathcal{H}_{W, \hbar}^{(\cdot, \cdot)}(U_f) := \mathbb{C}[J_{\infty} U_f][[\hbar]],$$

endowed with the aforementioned \hbar -adic vertex algebra structure.

Now coming back to our quiver setting, we define a sheaf of \hbar -adic vertex superalgebras on the prequotient $\mathfrak{R} := T^*\text{Rep}(Q, \mathbf{v}, \mathbf{w}) \times \mathbb{C}^{Q_0}$, denoted by $\mathcal{D}_{\mathfrak{R}, \hbar}^{\text{ch}}$, by the following

$$\mathcal{D}_{\mathfrak{R}, \hbar}^{\text{ch}} := \mathcal{D}_{T^*\text{Rep}(Q, \mathbf{v}, \mathbf{w} | \mathbf{d}), \hbar}^{\text{ch}} \widehat{\boxtimes}_{\mathbb{C}^{Q_0}, \hbar} \mathcal{H}_{\mathbb{C}^{Q_0}, \hbar}^{(\cdot, \cdot)_Q}, \quad (10.1)$$

where $\mathbf{d} = \mathbf{w} - \mathbf{C}\mathbf{v}$, and $(\cdot, \cdot)_Q$ is the Cartan inner product on \mathbb{C}^{Q_0} :

$$(h_i, h_j)_Q := 2\delta_{ij} - \#(a : i \rightarrow j \in Q_1) - \#(a : j \rightarrow i \in Q_1). \quad (10.2)$$

$\mathcal{D}_{\mathfrak{R}, \hbar}^{\text{ch}}$ is the sheafified version of $\mathcal{V}^{\sharp}(Q, \mathbf{v}, \mathbf{w})$, namely the \hbar -adic completion $\mathcal{V}^{\sharp}(Q, \mathbf{v}, \mathbf{w})_{\hbar}$ is isomorphic to the global section $\Gamma(\mathfrak{R}, \mathcal{D}_{\mathfrak{R}, \hbar}^{\text{ch}})$.

10.1 Sheaf of BRST cohomologies

In this subsection we construct the sheaf of BRST cohomologies of $\mathcal{D}_{\mathfrak{R}, \hbar}^{\text{ch}}$ on $\widetilde{\mathcal{M}}$, following [17] and [53].

First of all, let us define \hbar -adic BRST reduction. Let \mathfrak{g} be a reductive Lie algebra and κ be a \mathfrak{g} -invariant symmetric inner form on \mathfrak{g} , then the \hbar -adic current algebra $V^{\kappa}(\mathfrak{g})_{\hbar}$ is the $\mathbb{C}[[\hbar]]$ -module

$$\mathbb{C}[J_{\infty} \mathfrak{g}][[\hbar]] := \mathbb{C}[[\hbar]][E_{(-n)}^{\alpha} \mid n \in \mathbb{Z}_{\geq 1}, E^{\alpha} \in \text{a basis of } \mathfrak{g} \mid 0]$$

endowed with OPE

$$E^{\alpha}(z)E^{\beta}(w) \sim \frac{\hbar^2 \kappa^{\alpha, \beta}}{(z-w)^2} + \frac{\hbar f_{\gamma}^{\alpha \beta} E^{\gamma}(w)}{z-w},$$

where $\kappa^{\alpha, \beta} = \kappa(E^{\alpha}, E^{\beta})$ is the matrix element of the inner form κ , and $f^{\alpha \beta}_{\gamma}$ is the structure constant of \mathfrak{g} (so that $f^{\alpha \beta}_{\gamma} E^{\gamma} = [E^{\alpha}, E^{\beta}]$).

Denote by $\kappa_{\mathfrak{g}}$ the Killing form on \mathfrak{g} . Suppose that V is an \hbar -adic vertex superalgebra such that there exists an \hbar -adic vertex superalgebra map

$$J_V : V^{-\kappa_{\mathfrak{g}}}(\mathfrak{g})_{\hbar} \rightarrow V,$$

then we define \hbar -adic vertex superalgebra

$$\widetilde{C}(\mathfrak{g}, V)_{\hbar} := V \otimes \mathcal{V}_{\text{bc}}(\mathfrak{g})_{\hbar}, \quad (10.3)$$

where $\mathcal{V}_{\text{bc}}(\mathfrak{g})_{\hbar}$ is the \hbar -adic **bc** system of \mathfrak{g} , i.e. chiral differential operators $D^{\text{ch}}(\text{PIT}^* \mathfrak{g})_{\hbar}$ of the odd symplectic vector space $\text{PIT}^* \mathfrak{g}$. Note that $\mathcal{V}_{\text{bc}}(\mathfrak{g})_{\hbar}$ admits an \hbar -adic vertex superalgebra map

$$J_{\text{bc}} : V^{\kappa_{\mathfrak{g}}}(\mathfrak{g})_{\hbar} \rightarrow \mathcal{V}_{\text{bc}}(\mathfrak{g})_{\hbar}, \quad J_{\text{bc}}(E^{\alpha}) = f^{\alpha \beta}_{\gamma} \mathbf{b}^{\gamma} \mathbf{c}_{\beta}.$$

$\mathcal{V}_{\text{bc}}(\mathfrak{g})_{\hbar}$ is graded by ghost numbers, i.e. $\deg \mathbf{c} = +1, \deg \mathbf{b} = -1$, so the image of J is contained in the degree zero piece $\mathcal{V}_{\text{bc}}^0(\mathfrak{g})_{\hbar}$. Consider the ghost number 1 element

$$\mathcal{J} := \mathbf{c}_{\alpha} \left(J_V(E^{\alpha}) + \frac{1}{2} J_{\text{bc}}(E^{\alpha}) \right) \in \widetilde{C}^1(\mathfrak{g}, V)_{\hbar}. \quad (10.4)$$

The operator $\mathcal{Q}_{\hbar} := \frac{1}{\hbar} \mathcal{J}_{(0)}$ acts on $\widetilde{C}(\mathfrak{g}, V)_{\hbar}$, and it squares to zero $\mathcal{Q}_{\hbar}^2 = 0$, therefore $(\widetilde{C}(\mathfrak{g}, V)_{\hbar}, \mathcal{Q}_{\hbar})$ is a chain complex of \hbar -adic vertex superalgebra, which is graded by ghost numbers. We call it the \hbar -adic BRST complex.

Note that the linear map

$$E^{\alpha} \mapsto J(E^{\alpha}) := \mathcal{Q}_{\hbar}(\mathbf{b}^{\alpha}) = J_V(E^{\alpha}) + J_{\text{bc}}(E^{\alpha}) \quad (10.5)$$

is an \hbar -adic vertex superalgebra chain complex map

$$J : (V^0(\mathfrak{g})_{\hbar}, 0) \rightarrow (\widetilde{C}(\mathfrak{g}, V)_{\hbar}, \mathcal{Q}_{\hbar}),$$

where the LHS is endowed with trivial differential. In particular the Lie algebra \mathfrak{g} acts on the complex $(\widetilde{C}(\mathfrak{g}, V)_{\hbar}, \mathcal{Q}_{\hbar})$ by $E^{\alpha} \mapsto \frac{1}{\hbar} J(E^{\alpha})_{(0)}$.

The relative \hbar -adic BRST complex is defined to be the subspace

$$C(\mathfrak{g}, V)_{\hbar} := \{v \in \widetilde{C}(\mathfrak{g}, V)_{\hbar} \mid J(E^{\alpha})_{(0)}v = \mathfrak{b}_{(0)}^{\alpha}v = 0, \forall \alpha\}, \quad (10.6)$$

which is a sub-complex because $[J(E^{\alpha})_{(0)}, \mathcal{Q}_{\hbar}] = 0$ and $[\mathfrak{b}_{(0)}^{\alpha}, \mathcal{Q}_{\hbar}] = J(E^{\alpha})_{(0)}$. We define the relative \hbar -adic BRST cohomology to be

$$H_{\hbar\text{BRST}}^{\infty/2+\bullet}(\mathfrak{g}, V) := H^{\bullet}(C(\mathfrak{g}, V)_{\hbar}, \mathcal{Q}_{\hbar}). \quad (10.7)$$

This is a \mathbb{Z} -graded \hbar -adic vertex superalgebra.

Now we come back to our quiver setting. According to our previous discussion in section 5.2, the chiral extended moment map $\widetilde{\mu}_{\text{ch}}$ is an \hbar -adic vertex superalgebra map from the current algebra $V^{-\kappa_{\mathfrak{gl}(\mathbf{v})}}(\mathfrak{gl}(\mathbf{v}))_{\hbar}$ to $\mathcal{V}^{\sharp}(Q, \mathbf{v}, \mathbf{w})_{\hbar}$. We define a presheaf of \mathbb{Z} -graded \hbar -adic vertex superalgebras on $\widetilde{\mathcal{M}}$ by assigning any open subset $U \subset \widetilde{\mathcal{M}}$ to the relative \hbar -adic BRST cohomology:

$$U \mapsto H_{\hbar\text{BRST}}^{\infty/2+\bullet}(\mathfrak{gl}(\mathbf{v}), \mathcal{D}_{\mathfrak{R}, \hbar}^{\text{ch}}(\widetilde{U})). \quad (10.8)$$

Here \widetilde{U} is an open subset of \mathfrak{R} such that $\widetilde{U} \cap \widetilde{\mu}^{-1}(0) = q^{-1}(U)$ where $q^{-1}(U)$ is the preimage of U under the quotient map $q : \widetilde{\mu}^{-1}(0)^{\text{st}} \rightarrow \widetilde{\mathcal{M}}$. Note that

- \widetilde{U} always exists, and the largest such choice is $\widetilde{U}_{\text{max}} = \mathfrak{R} \setminus (\widetilde{\mu}^{-1}(0) \setminus q^{-1}(U))$,
- if U is affine then \widetilde{U} can be chosen such that it is also affine,
- $H_{\hbar\text{BRST}}^{\infty/2+\bullet}(\mathfrak{gl}(\mathbf{v}), \mathcal{D}_{\mathfrak{R}, \hbar}^{\text{ch}}(\widetilde{U}))$ does not depend on the choice of \widetilde{U} , because a generalization of [17, Lemma 4.13] holds, i.e. if $D \subset \mathfrak{R}$ is an open subset such that $D \cap \mu^{-1}(0) = \emptyset$ then $H_{\hbar\text{BRST}}^{\infty/2+\bullet}(\mathfrak{gl}(\mathbf{v}), \mathcal{D}_{\mathfrak{R}, \hbar}^{\text{ch}}(D)) = 0$, see the companion paper [16] for more details.

The sheaf of \mathbb{Z} -graded \hbar -adic vertex superalgebras on $\widetilde{\mathcal{M}}$ associated to the presheaf $U \mapsto H_{\hbar\text{BRST}}^{\infty/2+\bullet}(\mathfrak{gl}(\mathbf{v}), \mathcal{D}_{\mathfrak{R}, \hbar}^{\text{ch}}(\widetilde{U}))$ is denoted by $\mathcal{H}_{\hbar\text{BRST}}^{\infty/2+\bullet}(\mathfrak{gl}(\mathbf{v}), \mathcal{D}_{\mathfrak{R}, \hbar}^{\text{ch}})$, and denote its cohomological degree zero piece by

$$\mathcal{D}_{\widetilde{\mathcal{M}}, \hbar}^{\text{ch}} := \mathcal{H}_{\hbar\text{BRST}}^{\infty/2+0}(\mathfrak{gl}(\mathbf{v}), \mathcal{D}_{\mathfrak{R}, \hbar}^{\text{ch}}). \quad (10.9)$$

We note that if $U \subset \widetilde{\mathcal{M}}$ is an open affine subset, then

$$\mathcal{D}_{\widetilde{\mathcal{M}}, \hbar}^{\text{ch}}(U) = H_{\hbar\text{BRST}}^{\infty/2+0}(\mathfrak{gl}(\mathbf{v}), \mathcal{D}_{\mathfrak{R}, \hbar}^{\text{ch}}(\widetilde{U})). \quad (10.10)$$

The argument in [17, Section 4] naturally generalizes to our setting, and we have the following.

Theorem 10.1. *The BRST cohomology sheaf $\mathcal{H}_{\hbar\text{BRST}}^{\infty/2+n}(\mathfrak{gl}(\mathbf{v}), \mathcal{D}_{\mathfrak{R}, \hbar}^{\text{ch}})$ vanishes for $n \neq 0$. Moreover, there is an isomorphism between sheaves of vertex Poisson superalgebras*

$$\mathcal{D}_{\widetilde{\mathcal{M}}, \hbar}^{\text{ch}} / \hbar \mathcal{D}_{\widetilde{\mathcal{M}}, \hbar}^{\text{ch}} \cong \mathcal{O}_{J_{\infty} \widetilde{\mathcal{M}}(Q, \mathbf{v}, \mathbf{w} | \mathbf{d})}, \quad (10.11)$$

where $\mathbf{d} := \mathbf{w} - \mathbf{C}\mathbf{v}$ and $\widetilde{\mathcal{M}}(Q, \mathbf{v}, \mathbf{w} | \mathbf{d})$ is the extended quiver super variety.

10.2 Vertex superalgebra of global sections

Let \mathbb{S} be an one-dimensional torus that acts on \mathfrak{X} by assigning the following weights to coordinates

$$\text{wt}(X_{(-n)}) = \text{wt}(Y_{(-n)}) = \text{wt}(I_{(-n)}) = \text{wt}(J_{(-n)}) = n, \quad \text{wt}(h_{(-n)}) = n + 1. \quad (10.12)$$

We extend the \mathbb{S} -action to $\tilde{C}(\mathfrak{gl}(\mathbf{v}), \mathcal{V}^\sharp(Q, \mathbf{v}, \mathbf{w}))$ by assigning the following weights

$$\text{wt}(\mathbf{b}_{(-n)}) = n + 1, \quad \text{wt}(\mathbf{c}_{(-n)}) = n - 1, \quad \text{wt}(\hbar) = 1, \quad (10.13)$$

then \mathcal{Q}_\hbar has zero weight, so $(\tilde{C}(\mathfrak{gl}(\mathbf{v}), \mathcal{V}^\sharp(Q, \mathbf{v}, \mathbf{w})), \mathcal{Q}_\hbar)$ is an \mathbb{S} -equivariant complex. Moreover, the relative BRST complex $(C(\mathfrak{gl}(\mathbf{v}), \mathcal{V}^\sharp(Q, \mathbf{v}, \mathbf{w})), \mathcal{Q}_\hbar)$ is an \mathbb{S} -equivariant sub-complex.

Since $\tilde{\mathcal{M}}$ has an \mathbb{S} -equivariant ample line (tensor product of tautological line bundles), there exists an \mathbb{S} -equivariant closed embedding $\tilde{\mathcal{M}} \hookrightarrow \tilde{\mathcal{M}}^0 \times \mathbb{P}(L)$ where L is an \mathbb{S} -module. So we can find an open cover $\tilde{\mathcal{M}} = \bigcup_{i=1}^n U_i$ such that each U_i is affine and \mathbb{S} -invariant. Set $\tilde{U}_{i,\max} = \mathfrak{X} \setminus (\tilde{\mu}^{-1}(0) \setminus q^{-1}(U_i))$, then $\tilde{U}_{i,\max}$ is the largest among those open subsets of \mathfrak{X} whose intersection with $\tilde{\mu}^{-1}(0)$ equals to $q^{-1}(U)$. It follows that $\tilde{U}_{i,\max}$ is also \mathbb{S} -invariant, therefore $\mathcal{D}_{\tilde{\mathcal{M}},\hbar}^{\text{ch}}(U_i) = H_{\hbar\text{BRST}}^{\infty/2+0}(\mathfrak{gl}(\mathbf{v}), \mathcal{D}_{\mathfrak{X},\hbar}^{\text{ch}}(\tilde{U}_{i,\max}))$ is a complete \mathbb{S} -module. Similarly $\mathcal{D}_{\tilde{\mathcal{M}},\hbar}^{\text{ch}}(U_i \cap U_j)$ is a complete \mathbb{S} -module. Then it follows that $\mathcal{D}_{\tilde{\mathcal{M}},\hbar}^{\text{ch}}(\tilde{\mathcal{M}}) = \ker\left(\bigoplus_i \mathcal{D}_{\tilde{\mathcal{M}},\hbar}^{\text{ch}}(U_i) \rightarrow \bigoplus_{i,j} \mathcal{D}_{\tilde{\mathcal{M}},\hbar}^{\text{ch}}(U_i \cap U_j)\right)$ is a complete \mathbb{S} -module.

Since the weights of $\mathcal{D}_{\tilde{\mathcal{M}},\hbar}^{\text{ch}}(\tilde{\mathcal{M}})$ are bounded below¹³, we have

$$\mathcal{D}_{\tilde{\mathcal{M}},\hbar}^{\text{ch}}(\tilde{\mathcal{M}}) = \prod_{m \geq -M}' \mathcal{D}_{\tilde{\mathcal{M}},\hbar}^{\text{ch}}(\tilde{\mathcal{M}})_m,$$

where $\mathcal{D}_{\tilde{\mathcal{M}},\hbar}^{\text{ch}}(\tilde{\mathcal{M}})_m$ is the weight m subspace¹⁴, and \prod' means the subspace of the product space consisting of elements $(x_i)_{i=-M}^\infty$ such that there exists N and $x_n \in \hbar^{n-N} \mathcal{D}_{\tilde{\mathcal{M}},\hbar}^{\text{ch}}(\tilde{\mathcal{M}})_N$ for all $n > N$. Consider the subspace of \mathbb{S} -finite elements

$$\mathcal{D}_{\tilde{\mathcal{M}},\hbar}^{\text{ch}}(\tilde{\mathcal{M}})_{\mathbb{S}\text{-fin}} := \bigoplus_{m \geq 0} \mathcal{D}_{\tilde{\mathcal{M}},\hbar}^{\text{ch}}(\tilde{\mathcal{M}})_m, \quad (10.14)$$

¹³This can be shown as follows. Since $\hbar^p \mathcal{D}_{\tilde{\mathcal{M}},\hbar}^{\text{ch}} / \hbar^{p+1} \mathcal{D}_{\tilde{\mathcal{M}},\hbar}^{\text{ch}} \cong \hbar^p \mathcal{O}_{J_\infty \tilde{\mathcal{M}}(Q, \mathbf{v}, \mathbf{w}|\mathbf{d})}$, it is enough to show that weights of $\mathcal{O}_{J_\infty \tilde{\mathcal{M}}(Q, \mathbf{v}, \mathbf{w}|\mathbf{d})}(\tilde{\mathcal{M}})$ are bounded below. Since the action of \mathbb{S} on $\tilde{\mathcal{M}}^0$ is repelling with unique fixed point 0, it follows that the fixed point set $\tilde{\mathcal{M}}^\mathbb{S}$ is contained in the central fiber $\pi^{-1}(0)$ of the projection $\pi : \tilde{\mathcal{M}} \rightarrow \tilde{\mathcal{M}}^0$. $\pi^{-1}(0)$ is proper, so there must be a connected component $F \subset \tilde{\mathcal{M}}^\mathbb{S}$ such that normal weights are all repelling. Let $U \subset \tilde{\mathcal{M}}$ be the repelling locus of F , then $\mathcal{O}_{J_\infty \tilde{\mathcal{M}}(Q, \mathbf{v}, \mathbf{w}|\mathbf{d})}(\tilde{\mathcal{M}}) \subset \mathcal{O}_{J_\infty \tilde{\mathcal{M}}(Q, \mathbf{v}, \mathbf{w}|\mathbf{d})}(U)$. The limit $x \mapsto \lim_{t \rightarrow \infty} \sigma(t) \cdot x$ gives a map $\text{lim} : U \rightarrow F$, which realizes U as an \mathbb{S} -equivariant affine bundle over F . It follows that there is a filtration on $\mathcal{O}_{J_\infty \tilde{\mathcal{M}}(Q, \mathbf{v}, \mathbf{w}|\mathbf{d})}(U)$ such that its associated graded is an \mathbb{S} -equivariant subspace of $\Gamma(F, S^\bullet(\mathcal{N}_{F/J_\infty \tilde{\mathcal{M}}(Q, \mathbf{v}, \mathbf{w}|\mathbf{d})}^\vee))$, where $\mathcal{N}_{F/J_\infty \tilde{\mathcal{M}}(Q, \mathbf{v}, \mathbf{w}|\mathbf{d})}$ is the normal bundle of F in $J_\infty \tilde{\mathcal{M}}(Q, \mathbf{v}, \mathbf{w}|\mathbf{d})$. Since there could be only finitely many normal directions of F which have positive weights, and moreover all such weight spaces are odd by our choice of F , it follows that weights in $\Gamma(F, S^\bullet(\mathcal{N}_{F/J_\infty \tilde{\mathcal{M}}(Q, \mathbf{v}, \mathbf{w}|\mathbf{d})}^\vee))$ are bounded below.

¹⁴The argument in the previous footnote shows that if $(Q, \mathbf{v}, \mathbf{w})$ is balanced, then $\mathcal{D}_{\tilde{\mathcal{M}},\hbar}^{\text{ch}}(\tilde{\mathcal{M}})$ is non-negatively graded, and $\mathcal{D}_{\tilde{\mathcal{M}},\hbar}^{\text{ch}}(\tilde{\mathcal{M}})_0 = \mathbb{C}|0$.

which is a $\mathbb{C}[\hbar]$ -module. Moreover the OPE preserves the \mathbb{S} -weight, and every OPE must depend on \hbar in a polynomial way since $\text{wt}(\hbar) = 1$ and weights of $\mathcal{D}_{\widetilde{\mathcal{M}},\hbar}^{\text{ch}}(\widetilde{\mathcal{M}})$ are bounded below. Therefore $\mathcal{D}_{\widetilde{\mathcal{M}},\hbar}^{\text{ch}}(\widetilde{\mathcal{M}})_{\mathbb{S}\text{-fin}}$ is a vertex superalgebra over the base ring $\mathbb{C}[\hbar]$.

Denote by $\text{D}^{\text{ch}}(\widetilde{\mathcal{M}})$ the $\hbar = 1$ specialization of the \mathbb{S} -finite part:

$$\text{D}^{\text{ch}}(\widetilde{\mathcal{M}}) := \mathcal{D}_{\widetilde{\mathcal{M}},\hbar}^{\text{ch}}(\widetilde{\mathcal{M}})_{\mathbb{S}\text{-fin}}/(\hbar - 1). \quad (10.15)$$

We claim that there exists a natural vertex superalgebra map

$$\mathcal{V}(Q, \mathbf{v}, \mathbf{w}) \rightarrow \text{D}^{\text{ch}}(\widetilde{\mathcal{M}}). \quad (10.16)$$

In fact, we consider the \mathbb{S} -finite part of the relative \hbar -adic BRST complex:

$$C(\mathfrak{gl}(\mathbf{v}), \mathcal{V}^{\sharp}(Q, \mathbf{v}, \mathbf{w}))[\hbar] := C(\mathfrak{gl}(\mathbf{v}), \mathcal{V}^{\sharp}(Q, \mathbf{v}, \mathbf{w}))_{\hbar, \mathbb{S}\text{-fin}},$$

then \mathcal{Q}_\hbar has \mathbb{S} -weight zero and thus stabilizes $C(\mathfrak{gl}(\mathbf{v}), \mathcal{V}^{\sharp}(Q, \mathbf{v}, \mathbf{w}))[\hbar]$, which makes it a cochain complex of $\mathbb{C}[\hbar]$ -vertex superalgebras. We also note that the $\hbar = 1$ specialization gives the ordinary relative BRST complex:

$$(C(\mathfrak{gl}(\mathbf{v}), \mathcal{V}^{\sharp}(Q, \mathbf{v}, \mathbf{w}))[\hbar], \mathcal{Q}_\hbar)/(\hbar - 1) \cong (C(\mathfrak{gl}(\mathbf{v}), \mathcal{V}^{\sharp}(Q, \mathbf{v}, \mathbf{w})), \mathcal{Q}).$$

$C(\mathfrak{gl}(\mathbf{v}), \mathcal{V}^{\sharp}(Q, \mathbf{v}, \mathbf{w}))[\hbar]$ is sub-complex of $C(\mathfrak{gl}(\mathbf{v}), \mathcal{V}^{\sharp}(Q, \mathbf{v}, \mathbf{w}))_\hbar$, and the latter admits a natural chain complex map to $C(\mathfrak{gl}(\mathbf{v}), \mathcal{D}_{\mathfrak{R},\hbar}^{\text{ch}}(\widetilde{U}))_\hbar$ for every open subset $U \subset \widetilde{\mathcal{M}}$, whence we obtain a $\mathbb{C}[\hbar]$ -module map $H^0(C(\mathfrak{gl}(\mathbf{v}), \mathcal{V}^{\sharp}(Q, \mathbf{v}, \mathbf{w}))[\hbar], \mathcal{Q}_\hbar) \rightarrow \mathcal{D}_{\widetilde{\mathcal{M}},\hbar}^{\text{ch}}(\widetilde{\mathcal{M}})$, whose image is contained in the \mathbb{S} -finite part. This map is compatible with taking OPE, thus we have a map between $\mathbb{C}[\hbar]$ -vertex superalgebras $H^0(C(\mathfrak{gl}(\mathbf{v}), \mathcal{V}^{\sharp}(Q, \mathbf{v}, \mathbf{w}))[\hbar], \mathcal{Q}_\hbar) \rightarrow \mathcal{D}_{\widetilde{\mathcal{M}},\hbar}^{\text{ch}}(\widetilde{\mathcal{M}})_{\mathbb{S}\text{-fin}}$. Specializing to $\hbar = 1$ gives the desired vertex superalgebra map (10.16).

In the companion paper [16], we will prove the following result.

Theorem 10.2. *Let Q be a quiver and choose the gauge and framing dimensions \mathbf{v}, \mathbf{w} such that $\mathbf{w} - \mathbf{C}\mathbf{v} \in \mathbb{Z}_{\geq 0}^{Q_0}$. Assume moreover that one of the following conditions holds:*

- Q is totally negative, i.e. $\mathbf{C}_{ij} < 0$ for every pair $i, j \in Q_0$,
- Q is a Dynkin quiver, and $\sum_{i \in Q_0} (\mathbf{v}_i - 1) \leq 2$,
- Q is the A_1 quiver,
- Q is the Jordan quiver, and $\mathbf{w}_i \geq \mathbf{v}_i$,

then we have

1. $H_{\text{BRST}}^{\infty/2+n}(\mathfrak{gl}(\mathbf{v}), \mathcal{V}^{\sharp}(Q, \mathbf{v}, \mathbf{w}))$ vanishes for $n < 0$,
2. the map $\mathcal{V}(Q, \mathbf{v}, \mathbf{w}) \rightarrow \text{D}^{\text{ch}}(\widetilde{\mathcal{M}})$ in (10.16) is injective.

10.3 Associated variety

Recall that we have a canonical filtration (7.1) $F^\bullet V$ for every vertex algebra V . This construction naturally extends to a sheaf \mathcal{D} of \hbar -adic vertex algebras. Namely, we define the subsheaf $F^p \mathcal{D}$ to be the sheafification of the sub-presheaf

$$U \mapsto F^p(\mathcal{D}(U)) ,$$

where $F^p(\mathcal{D}(U))$ is defined the same way as (7.1). This allows us to define the C_2 sheaf

$$\mathcal{R}(\mathcal{D}) := F^0 \mathcal{D} / F^1 \mathcal{D} . \quad (10.17)$$

Now let us go back to the quiver vertex algebra case $\mathcal{D} = \mathcal{D}_{\mathcal{M}, \hbar}^{\text{ch}}$. Then we have

$$\mathcal{R}(\mathcal{D}_{\mathcal{M}, \hbar}^{\text{ch}}) / \hbar \mathcal{R}(\mathcal{D}_{\mathcal{M}, \hbar}^{\text{ch}}) \cong \mathcal{D}_{\mathcal{M}, \hbar}^{\text{ch}} / (\hbar \mathcal{D}_{\mathcal{M}, \hbar}^{\text{ch}} + F^2 \mathcal{D}_{\mathcal{M}, \hbar}^{\text{ch}}) \cong \mathcal{R}(\mathcal{O}_{J_\infty \widetilde{\mathcal{M}}(Q, \mathbf{v}, \mathbf{w} | \mathbf{d})}) \cong \mathcal{O}_{\widetilde{\mathcal{M}}(Q, \mathbf{v}, \mathbf{w} | \mathbf{d})} ,$$

which induces an isomorphism

$$\mathcal{R}(\mathcal{D}_{\mathcal{M}, \hbar}^{\text{ch}}) \cong \mathcal{O}_{\widetilde{\mathcal{M}}(Q, \mathbf{v}, \mathbf{w} | \mathbf{d})}[[\hbar]] . \quad (10.18)$$

We have an obvious inclusion

$$F^1(\mathcal{D}_{\mathcal{M}, \hbar}^{\text{ch}}(\widetilde{\mathcal{M}})) \subset F^1(\mathcal{D}_{\mathcal{M}, \hbar}^{\text{ch}})(\widetilde{\mathcal{M}}) ,$$

thus we get the following natural maps between \hbar -adic Poisson algebras:

$$\mathcal{R}(\mathcal{D}_{\mathcal{M}, \hbar}^{\text{ch}}(\widetilde{\mathcal{M}})) \rightarrow \mathcal{D}_{\mathcal{M}, \hbar}^{\text{ch}}(\widetilde{\mathcal{M}}) / F^1(\mathcal{D}_{\mathcal{M}, \hbar}^{\text{ch}})(\widetilde{\mathcal{M}}) \hookrightarrow \mathcal{R}(\mathcal{D}_{\mathcal{M}, \hbar}^{\text{ch}})(\widetilde{\mathcal{M}}) \cong \mathcal{O}_{\widetilde{\mathcal{M}}(Q, \mathbf{v}, \mathbf{w} | \mathbf{d})}(\widetilde{\mathcal{M}})[[\hbar]] ,$$

where the first map is surjective and the second map is injective. Restricting to \mathbb{S} -finite part and specializing to $\hbar = 1$, we get a map between Poisson algebras:

$$\mathcal{R}(\mathcal{D}^{\text{ch}}(\widetilde{\mathcal{M}})) \longrightarrow \mathcal{O}_{\widetilde{\mathcal{M}}(Q, \mathbf{v}, \mathbf{w} | \mathbf{d})}(\widetilde{\mathcal{M}}) . \quad (10.19)$$

Conjecture 10.1. *The map (10.19) is an isomorphism.*

Proposition 1. *Suppose that Γ is a vertex algebra map from a bosonic vertex algebra \mathcal{W} to $\mathcal{D}^{\text{ch}}(\widetilde{\mathcal{M}})$. Assume moreover that*

1. \mathcal{W} has a PBW basis¹⁵,
2. after reducing to C_2 algebra, the induced map $\mathcal{R}(\mathcal{W}) \rightarrow \mathcal{O}_{\widetilde{\mathcal{M}}}(\widetilde{\mathcal{M}})$ is injective.

Then Γ is injective.

¹⁵By definition, \mathcal{W} has a PBW basis if and only if $\text{gr}_F \mathcal{W} = J_\infty \mathcal{R}(\mathcal{W})$ and $\mathcal{R}(\mathcal{W})$ is a finitely generated polynomial ring.

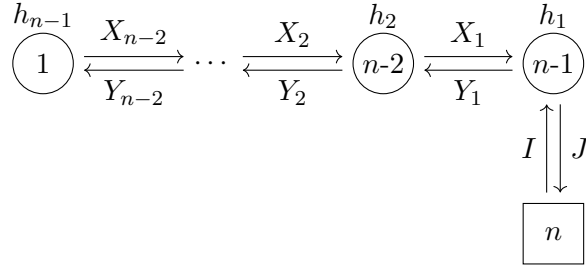

Figure 20: The $T[\mathrm{SU}(n)]$ quiver.

Proof. By the definition, $\mathrm{gr}_F \mathcal{W} = J_\infty \mathcal{R}(\mathcal{W})$ and $\mathcal{R}(\mathcal{W})$ is a finitely generated polynomial ring. In particular the associated variety $X(\mathcal{W}) = \mathrm{Spec} \mathcal{R}(\mathcal{W})$ is an affine space. It follows from the injectivity of $\mathcal{R}(\mathcal{W}) \rightarrow \mathcal{O}_{\widetilde{\mathcal{M}}}(\widetilde{\mathcal{M}})$ that the induced morphism $f : \widetilde{\mathcal{M}} \rightarrow X(\mathcal{W})$ is dominant. By generic smoothness, there exist open subsets $U \subset \widetilde{\mathcal{M}}, U' \subset X(\mathcal{W})$ such that the $f|_U : U \rightarrow U'$ is smooth, thus $J_\infty f|_{J_\infty U} : J_\infty U \rightarrow J_\infty U'$ is a flat morphism. According to [54, Lemma 4.3.7], $J_\infty f|_{J_\infty U}$ is a dominant morphism. $J_\infty \mathcal{R}(\mathcal{W})$ is an integral domain because $\mathcal{R}(\mathcal{W})$ is a polynomial ring, then it follows that the induced map between jets $J_\infty \mathcal{R}(\mathcal{W}) \rightarrow \mathbb{C}[J_\infty \widetilde{\mathcal{M}}]$ is injective. We note that $J_\infty \mathcal{R}(\mathcal{W}) \rightarrow \mathbb{C}[J_\infty \widetilde{\mathcal{M}}]$ factors through $\mathrm{gr}_F \mathrm{D}^{\mathrm{ch}}(\widetilde{\mathcal{M}})$, therefore the induced map between associated graded algebra $\mathrm{gr}_F(\Gamma) : \mathrm{gr}_F \mathcal{W} \rightarrow \mathrm{gr}_F \mathrm{D}^{\mathrm{ch}}(\widetilde{\mathcal{M}})$ is injective. This implies that Γ is injective. \square

A typical situation is that $\Gamma : \mathcal{W} \rightarrow \mathrm{D}^{\mathrm{ch}}(\widetilde{\mathcal{M}})$ maps the strong generators of \mathcal{W} to path elements in $\mathcal{O}_{\widetilde{\mathcal{M}}}(\widetilde{\mathcal{M}})$, after reducing to the C_2 algebra. For example in the $T[\mathrm{SU}(n)]$ quiver in Fig. 20 we have a vertex algebra map $\Gamma : V^{-n+1}(\mathfrak{sl}_n) \rightarrow \mathcal{V}(Q)$ such that

$$\Gamma(E_j^i) = J_k^i I_j^k - \frac{\delta_j^i}{n} J_k^l I_l^k. \quad (10.20)$$

It is well-known that for any level $k \in \mathbb{C}$, the current algebra $V^k(\mathfrak{g})$ has a PBW basis, and its C_2 algebra is $\mathbb{C}[\mathfrak{g}^*]$ [45, Example 4.9]. In our case, the map $\varphi : \widetilde{\mathcal{M}} \rightarrow \mathfrak{sl}_n^*$ induced from Γ is given by

$$\varphi(x, y, \alpha, \beta) = \beta\alpha - \frac{\mathrm{Tr}(\beta\alpha)}{n} \mathrm{id}. \quad (10.21)$$

Consider the map $p : \widetilde{\mathcal{M}} \rightarrow \mathrm{End}(\mathbb{C}^n)$ such that $p(x, y, \alpha, \beta) = \beta\alpha$, then it is easy to see that the image of p is the determinantal variety $\{A \in \mathrm{End}(\mathbb{C}^n) \mid \det(A) = 0\}$. Since $\varphi = \mathfrak{Z} \circ p$, where $\mathfrak{Z} : \mathrm{End}(\mathbb{C}^n) \rightarrow \mathfrak{sl}_n^*$ maps a matrix A to its traceless part $A - \frac{\mathrm{Tr}(A)}{n} \mathrm{id}$, we see that φ is surjective because every traceless matrix B equals to $\mathfrak{Z}(B - \lambda \cdot \mathrm{id})$ where λ is an eigenvalue of B . It follows that $\mathcal{R}(V^{-n+1}(\mathfrak{sl}_n)) \rightarrow \mathbb{C}[\widetilde{\mathcal{M}}]$ is injective, whence $\Gamma : V^{-n+1}(\mathfrak{sl}_n) \rightarrow \mathrm{D}^{\mathrm{ch}}(\widetilde{\mathcal{M}})$ is injective by Proposition 1.

11 Quiver reduction

In this section, we develop a tool to study quiver vertex superalgebras inductively by reducing a quiver to another quiver with fewer nodes. This will enable us to obtain free-field realizations for quiver VOAs associated with a very general class of quiver gauge theories.

We begin with an observation on the geometry side. Let Q be a quiver, and choose gauge dimension vector \mathbf{v} and framing dimension vector \mathbf{w} such that $\mathbf{w} - \mathbf{C}\mathbf{v} \in \mathbb{Z}_{\geq 0}^{Q_0}$. Assume moreover that there exists a node $i \in Q_0$ such that $\mathbf{w}_i = \mathbf{v}_i$, and consider the open locus $\mathcal{U} \subset \widetilde{\mathcal{M}}(Q, \mathbf{v}, \mathbf{w})$ where the framing map $I_i : \mathbb{C}^{\mathbf{w}_i} \rightarrow V_i$ is an isomorphism. On the locus \mathcal{U} the isomorphism $\mathbb{C}^{\mathbf{w}_i} \cong V_i$ effectively removes the gauge node, and replaces it by a framing vector space of dimension \mathbf{w}_i , and the quiver data are updated accordingly:

$$X_a \mapsto \begin{cases} X_a, & \text{if } a \text{ is not connected to } i \\ I_i^{-1} X_a, & \text{if } a : j \rightarrow i \text{ where } j \neq i \\ X_a I_i, & \text{if } a : i \rightarrow j \text{ where } j \neq i \\ I_i^{-1} X_a I_i, & \text{if } a : i \rightarrow i \end{cases}, \quad Y_a \mapsto \begin{cases} Y_a, & \text{if } a \text{ is not connected to } i \\ I_i^{-1} Y_a, & \text{if } a : i \rightarrow j \text{ where } j \neq i \\ Y_a I_i, & \text{if } a : j \rightarrow i \text{ where } j \neq i \\ I_i^{-1} Y_a I_i, & \text{if } a : i \rightarrow i \end{cases}.$$

The extended moment map equation at the node i determines the J_i by

$$J_i = -I_i^{-1} z_i + \sum_{a:i \rightarrow j} I_i^{-1} Y_a X_a - \sum_{b:j \rightarrow i} I_i^{-1} X_b Y_b,$$

so J_i can be removed from the quiver data. Therefore we have an isomorphism

$$\mathcal{U}_i \cong \widetilde{\mathcal{M}}(Q', \mathbf{v}', \mathbf{w}') \times T^* \text{End}(\mathbb{C}^{\mathbf{v}_i})^{\oplus \mathbf{g}_i} \times \mathbb{C},$$

where Q' is the sub-quiver of Q obtained by deleting the node i , and \mathbf{g}_i is the number of edge loops at the node i in the quiver Q , and

$$\mathbf{v}'_j = \mathbf{v}_j, \quad \mathbf{w}'_j = \mathbf{w}_j - C_{ij} \mathbf{v}_i.$$

It is easy to see that

$$\mathbf{w}'_j - \sum_{l \in Q'_0} C'_{j,l} \mathbf{v}'_l = \mathbf{w}_j - \sum_{l \in Q_0} C_{j,l} \mathbf{v}_l, \quad \forall j \in Q'_0,$$

in particular $\mathbf{w}' - C' \mathbf{v}' \in \mathbb{Z}_{\geq 0}^{Q'_0}$, where C' is the Cartan matrix for the new quiver Q' .

We can slightly generalize the above argument to the situation when there exists a node $i \in Q_0$ such that $\mathbf{w}_i \geq \mathbf{v}_i$. In this case we split the framing vector space into $\mathbb{C}^{\mathbf{w}_i} = \mathbb{C}^{\mathbf{v}_i} \oplus \mathbb{C}^{\mathbf{w}_i - \mathbf{v}_i}$, and consider the open locus $\mathcal{U}_i \subset \widetilde{\mathcal{M}}(Q, \mathbf{v}, \mathbf{w})$ where the framing map $I_i : \mathbb{C}^{\mathbf{v}_i} \rightarrow V_i$ is an isomorphism. Then we have a natural isomorphism

$$\mathcal{U}_i \cong \widetilde{\mathcal{M}}(Q', \mathbf{v}', \mathbf{w}') \times T^* \text{End}(\mathbb{C}^{\mathbf{v}_i})^{\oplus \mathbf{g}_i} \times T^* \text{Hom}(\mathbb{C}^{\mathbf{v}_i}, \mathbb{C}^{\mathbf{w}_i - \mathbf{v}_i}) \times \mathbb{C},$$

where Q' is the sub-quiver of Q obtained by deleting the node i , and \mathbf{g}_i is the number of edge loops at the node i in the quiver Q , and

$$\mathbf{v}'_j = \mathbf{v}_j, \quad \mathbf{w}'_j = \mathbf{w}_j - C_{ij} \mathbf{v}_i.$$

In this case we also have $\mathbf{w}'_j - \sum_{l \in Q'_0} C'_{j,l} \mathbf{v}'_l = \mathbf{w}_j - \sum_{l \in Q_0} C_{j,l} \mathbf{v}_l$, $\forall j \in Q'_0$, in particular $\mathbf{w}' - C' \mathbf{v}' \in \mathbb{Z}_{\geq 0}^{Q'_0}$.

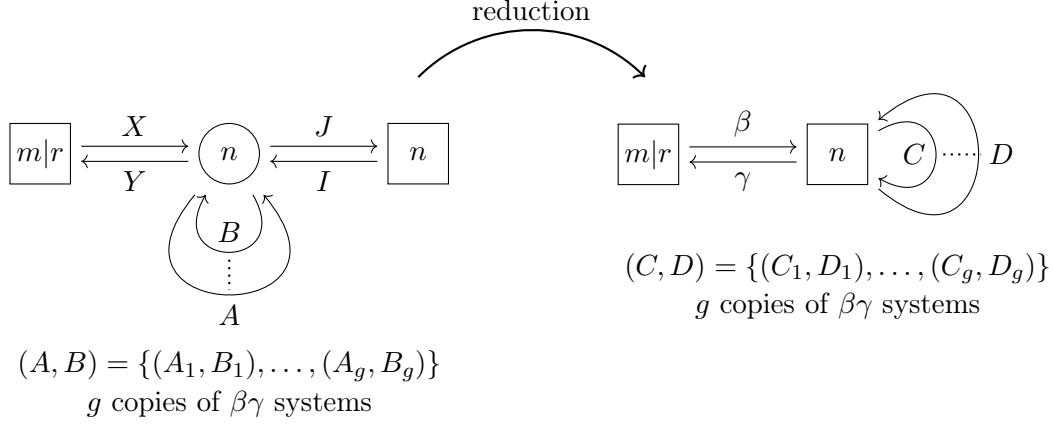

Figure 21: A reduction procedure for the quiver, explained locally around the middle vertex. Here we have $m - r = (1 - 2g)n$.

11.1 The building block

We start the vertex algebra analog of the aforementioned geometry observation by looking into the basic building block in the above construction. Namely we pick a node $i \in Q_0$ for which the reduction will be performed and then re-arrange the neighboring nodes of i into the LHS of Fig. 21.

We will show in the following that the relative BRST reduction of the gauge node on a certain localization of the LHS will produce the RHS of Fig. 21.

Denote the $\beta\gamma\mathbf{bc}$ -Heisenberg system on the LHS (before BRST reduction) by $D^{\text{ch}}(\mathfrak{A})$. The nontrivial OPEs are

$$\begin{aligned}
 X_j^b(z)Y_a^i(w) &\sim \frac{\delta_a^b \delta_j^i}{z-w}, & I_\nu^b(z)J_a^\mu(w) &\sim \frac{\delta_a^b \delta_\nu^\mu}{z-w}, \\
 A_{s,b}^a(z)B_{t,d}^c(w) &\sim \frac{\delta_a^c \delta_b^d \delta_{s,t}}{z-w}, & h(z)h(w) &\sim \frac{2-2\mathbf{g}}{(z-w)^2}.
 \end{aligned}$$

Here (X, Y) contain both $\beta\gamma$ systems and \mathbf{bc} systems, and they are distinguished by the OPE

$$Y_a^i(z)X_j^b(w) \sim (-1)^{1+|i|} \frac{\delta_a^b \delta_j^i}{z-w}$$

where $|i|$ is the parity of i , which equals to 0 if $1 \leq i \leq m$, and it equals to 1 if $m < i \leq m+r$. The chiral extended moment map reads:

$$(\tilde{\mu}_{\text{ch}})_b^a = -Y_b^i X_i^a - I_\rho^a J_b^\rho - A_c^a B_b^c + B_d^a A_b^d - h\delta_b^a. \quad (11.1)$$

Let us localize the vertex algebra $D^{\text{ch}}(\mathfrak{A})$ by allowing I to be invertible, i.e. we add $\det(I)^{-1}$ to the vertex algebra¹⁶, and denote the resulting vertex algebra by $D^{\text{ch}}(\mathfrak{A})[I^{-1}]$. Then

$$D^{\text{ch}}(\mathfrak{A})[I^{-1}] \cong \mathbb{C}[\det(I)_{(-1)}^{-1}, X_{(-n)}, Y_{(-n)}, I_{(-n)}, J_{(-n)}, A_{(-n)}, B_{(-n)}, h_{(-n)} \mid n \in \mathbb{Z}_{\geq 1}]|0\rangle.$$

¹⁶ $\det(I)$ is defined as the normal order product $\epsilon_{a_1 a_2 \dots a_n} : I_1^{a_1} I_2^{a_2} \dots I_n^{a_n} :$.

Define

$$\beta := I^{-1}X, \quad \gamma := YI, \quad C := I^{-1}AI, \quad D := I^{-1}BI, \quad (11.2)$$

where we contract indices when multiplying matrix-valued operators. We also define an element

$$\hat{\alpha} := h + \frac{2-2\mathfrak{g}}{(1-2\mathfrak{g})n} (\text{Tr}(YX) - \text{Tr}(\gamma\beta)). \quad (11.3)$$

We can also rewrite $\hat{\alpha}$ as

$$\hat{\alpha} = h + (2-2\mathfrak{g})\text{Tr}(I^{-1}\partial I). \quad (11.4)$$

Thus $\hat{\alpha}$ is a Heisenberg field of level $2-2\mathfrak{g}$. When I is invertible, we can use $(\beta, \gamma, C, D, \hat{\alpha})$ together with $\tilde{\mu}_{\text{ch}}$ to represent (X, Y, I, J, A, B, h) , and vice versa. Therefore we have an isomorphism

$$D^{\text{ch}}(\mathfrak{R})[I^{-1}] \cong \mathbb{C}[\beta_{(-n)}, \gamma_{(-n)}, C_{(-n)}, D_{(-n)}, \hat{\alpha}_{(-n)} \mid n \in \mathbb{Z}_{\geq 1}] \otimes \mathbb{C}[\det(I)_{(-1)}^{-1}, I_{(-n)}, \tilde{\mu}_{\text{ch},(-n)} \mid n \in \mathbb{Z}_{\geq 1} \mid 0]. \quad (11.5)$$

We notice that $\mathbb{C}[\beta_{(-n)}, \gamma_{(-n)}, C_{(-n)}, D_{(-n)}, \hat{\alpha}_{(-n)} \mid n \in \mathbb{Z}_{\geq 1} \mid 0]$ is exactly the $\beta\gamma\text{bc}$ -Heisenberg system on the RHS of Fig. 21, and we denote it by $D^{\text{ch}}(\mathfrak{R}')$. We note that $D^{\text{ch}}(\mathfrak{R}')$ commutes with $\mathbb{C}[\det(I)_{(-1)}^{-1}, I_{(-n)}, \tilde{\mu}_{\text{ch},(-n)} \mid n \in \mathbb{Z}_{\geq 1} \mid 0]$, and the classical limit of the latter is the coordinate ring of $J_{\infty}T^*\text{GL}_n$. Therefore we have

$$H_{\text{BRST}}^{\infty/2+i}(\mathfrak{gl}_n, D^{\text{ch}}(\mathfrak{R})[I^{-1}]) = \begin{cases} D^{\text{ch}}(\mathfrak{R}'), & i = 0, \\ 0, & i \neq 0. \end{cases} \quad (11.6)$$

The natural embedding $D^{\text{ch}}(\mathfrak{R}) \hookrightarrow D^{\text{ch}}(\mathfrak{R})[I^{-1}]$ of vertex superalgebras induces a natural map between relative BRST complexes: $(C(\mathfrak{gl}_n, D^{\text{ch}}(\mathfrak{R})), \mathcal{Q}) \rightarrow (C(\mathfrak{gl}_n, D^{\text{ch}}(\mathfrak{R})[I^{-1}]), \mathcal{Q})$, and taking degree zero cohomology we get a vertex superalgebra map

$$\nu : H_{\text{BRST}}^{\infty/2+0}(\mathfrak{gl}_n, D^{\text{ch}}(\mathfrak{R})) \rightarrow D^{\text{ch}}(\mathfrak{R}').$$

Let $f(x_1, y_1; \dots; x_{\mathfrak{g}}, y_{\mathfrak{g}})$ be a monomial in $2\mathfrak{g}$ variables $x_1, y_1, \dots, x_{\mathfrak{g}}, y_{\mathfrak{g}}$ such that each pair (x_i, y_i) can not appear in f simultaneously. For example $x_1x_2y_1$ is not allowed. Then it easy to see that $Yf(A_1, B_1; \dots; A_{\mathfrak{g}}, B_{\mathfrak{g}})I$, $Jf(A_1, B_1; \dots; A_{\mathfrak{g}}, B_{\mathfrak{g}})X$, $\text{Tr}(f(A_1, B_1; \dots; A_{\mathfrak{g}}, B_{\mathfrak{g}}))$, and $\text{Tr}(A_iB_i)$ are BRST closed, so they represent cohomology classes in $H_{\text{BRST}}^{\infty/2+0}(\mathfrak{gl}_n, D^{\text{ch}}(\mathfrak{R}))$. Then we have the following.

Lemma 11.1.

$$\nu(Yf(A_1, B_1; \dots; A_{\mathfrak{g}}, B_{\mathfrak{g}})I) = \gamma f(C_1, D_1; \dots; C_{\mathfrak{g}}, D_{\mathfrak{g}}), \quad (11.7)$$

$$\nu(Jf(A_1, B_1; \dots; A_{\mathfrak{g}}, B_{\mathfrak{g}})X) = Mf(C_1, D_1; \dots; C_{\mathfrak{g}}, D_{\mathfrak{g}})\beta, \quad (11.8)$$

$$\nu(\text{Tr}(f(A_1, B_1; \dots; A_{\mathfrak{g}}, B_{\mathfrak{g}}))) = \text{Tr}(f(C_1, D_1; \dots; C_{\mathfrak{g}}, D_{\mathfrak{g}})), \quad (11.9)$$

$$\nu(\text{Tr}(A_iB_i)) = \text{Tr}(C_iD_i), \quad (11.10)$$

where $M_b^a := -\gamma_b^i \beta_i^a - C_c^a D_b^c + D_a^c C_b^d - \hat{\alpha} \delta_b^a$, and multiplications are understood as normal ordered products of matrix-valued operators. Furthermore, we have the following map of BRST-closed elements

$$\begin{aligned} \nu \left(\left(Y_b^i X_j^a - \frac{\delta_j^i}{(1-2\mathfrak{g})n} Y_b^k X_k^a \right) f(A_1, B_1; \dots; A_{\mathfrak{g}}, B_{\mathfrak{g}})_a^b \right) \\ = \left(\gamma_b^i \beta_j^a - \frac{\delta_j^i}{(1-2\mathfrak{g})n} \gamma_b^k \beta_k^a \right) f(C_1, D_1; \dots; C_{\mathfrak{g}}, D_{\mathfrak{g}})_a^b, \end{aligned} \quad (11.11)$$

$$\nu \left(JI - \frac{\text{Tr}(JI)}{n} \text{id} \right) = -\beta\gamma + \frac{\text{Tr}(\beta\gamma)}{n} \text{id} - CD + DC, \quad (11.12)$$

$$\nu \left(\frac{1}{1-2\mathfrak{g}} \text{Tr}(YX) - \text{Tr}(JI) \right) = n\hat{\alpha} + \frac{2-2\mathfrak{g}}{1-2\mathfrak{g}} \text{Tr}(\beta\gamma). \quad (11.13)$$

Proof. The equations (11.7), (11.9), (11.10), (11.11) are straightforward to derive. Then equation (11.13) follows from the trace of the moment map $\text{Tr}(\tilde{\mu}_{\text{ch}})$, which is zero in the BRST cohomology. To derive (11.12), let us consider the operator

$$\mathcal{O}_\sigma^\rho := -(\tilde{\mu}_{\text{ch}})_{b,(-1)}^a (I^{-1})_{a,(-1)}^\rho I_\sigma^b.$$

Since for every pair of fixed ρ, σ the operator $(I^{-1})_{a,(-1)}^\rho I_\sigma^b$ transforms in the adjoint representation with respect to the action of $\tilde{\mu}_{\text{ch}}$, then according to appendix B.1, \mathcal{O}_σ^ρ vanishes in the BRST cohomology. On the other hand we can expand \mathcal{O}_σ^ρ as follows:

$$\begin{aligned} \mathcal{O}_\sigma^\rho &= (I^{-1})_a^\rho Y_b^i X_i^a I_\sigma^b + (I^{-1}ABI - I^{-1}BAI)_\sigma^\rho + (JI)_\sigma^\rho - I_{\tau,(-2)}^a J_{b,(0)}^\tau (I^{-1})_{a,(-1)}^\rho I_\sigma^b + h\delta_\sigma^\rho \\ &= \gamma_\sigma^i \beta_i^\rho + (CD - DC + JI)_\sigma^\rho + h\delta_\sigma^\rho + (1-2\mathfrak{g})\text{Tr}(I^{-1}\partial I)\delta_\sigma^\rho. \end{aligned}$$

Using the equation $\mathcal{O} - \frac{\text{Tr}(\mathcal{O})}{n} \text{id} \equiv 0$ in the BRST cohomology, we find (11.12). We note that (11.12) implies that

$$M = \nu \left(JI - \frac{1}{(1-2\mathfrak{g})n} \text{Tr}(YX) \text{id} \right) + \frac{1}{(1-2\mathfrak{g})n} \text{Tr}(\gamma\beta) = JI - \text{Tr}(I^{-1}\partial I) \text{id}.$$

Thus the RHS of (11.8) equals to

$$(JI - \text{Tr}(I^{-1}\partial I) \text{id})_{(-1)} I^{-1} f(A_1, B_1; \dots; A_{\mathfrak{g}}, B_{\mathfrak{g}}) X,$$

which equals to LHS of (11.8). \square

The stress-energy operator T_{total} is the sum of stress-energy operators for the $\beta\gamma\text{bc}$ systems formed by (X, Y, I, J, A, B) , the Heisenberg field h , and the bc ghost system. Namely

$$\begin{aligned} T_{\text{total}} &= \frac{1}{2} \text{Tr}(\partial Y X - Y \partial X) + \frac{1}{2} \text{Tr}(\partial J I - J \partial I) + \frac{1}{2} \text{Tr}(\partial B A - B \partial A) \\ &\quad + \frac{1}{4-4\mathfrak{g}} h^2 - \text{Tr}(\text{b}\partial\text{c}). \end{aligned}$$

We note that when $\mathfrak{g} = 1$, the above formula does not make sense, and we need to remove the Heisenberg field h from the formula, since h is commutative.

From our previous discussion in section 6.3, the total stress-energy operator T_{total} is BRST closed, thus it represents an element in $H_{\text{BRST}}^{\infty/2+0}(\mathfrak{gl}_n, D^{\text{ch}}(\mathfrak{R}))$.

Lemma 11.2. *Under the reduction map ν ,*

$$\nu(T_{\text{total}}) = -\text{Tr}(\gamma\partial\beta) + \frac{1}{2}\text{Tr}(\partial DC - C\partial D) + \begin{cases} \frac{1}{4-4\mathfrak{g}}\dot{\alpha}^2 - \frac{n}{2}\partial\dot{\alpha}, & \mathfrak{g} \neq 1 \\ 0, & \mathfrak{g} = 1 \end{cases}. \quad (11.14)$$

Proof. To prove (11.14), we notice that β, γ, C, D are primary fields with respect to T_{total} with dimensions $0, 1, 1/2, 1/2$ respectively; and we have OPE

$$T_{\text{total}}(z)\dot{\alpha}(w) \sim \frac{(2-2\mathfrak{g})n}{(z-w)^3} + \frac{\dot{\alpha}}{(z-w)^2} + \frac{\partial\dot{\alpha}}{z-w}.$$

This implies that $\nu(T_{\text{total}}) - (T_{\beta\gamma} + T_{CD} + T_{\dot{\alpha}})$ commutes with $\beta, \gamma, C, D, \dot{\alpha}$. Since the center of $D^{\text{ch}}(\mathfrak{R}')$ is spanned by the vacuum, we must have $\nu(T_{\text{total}}) = T_{\beta\gamma} + T_{CD} + T_{\dot{\alpha}} + \lambda|0\rangle$ for some $\lambda \in \mathbb{C}$. On the other hand, under the grading on $C(\mathfrak{gl}_n, D^{\text{ch}}(\mathfrak{R}'))$ induced by $L_{0,\text{total}} = \oint zT_{\text{total}}(z)dz$, both T_{total} and $T_{\beta\gamma} + T_{CD} + T_{\dot{\alpha}}$ are of degree 2, whereas $\deg|0\rangle = 0$, thus $\lambda = 0$ and (11.14) is proven. \square

We note that the special case when $m = n = 1, r = \mathfrak{g} = 0$, the quiver reduction leads to the Wakimoto realization of $V^{-1}(\mathfrak{sl}_2)$. Indeed, the assignment of strong generators

$$e \mapsto YI, \quad h \mapsto YX - JI, \quad f \mapsto JX, \quad (11.15)$$

gives a vertex algebra map $\sigma : V^{-1}(\mathfrak{sl}_2) \rightarrow H_{\text{BRST}}^{\infty/2+0}(\mathfrak{gl}_n, D^{\text{ch}}(\mathfrak{R}'))$. Let \mathcal{H}^k be the Heisenberg algebra associated to the one dimensional vector space \mathbb{C} with inner form $(x, y) = kxy$, then $D^{\text{ch}}(\mathfrak{R}') \cong D^{\text{ch}}(T^*\mathbb{C}) \otimes \mathcal{H}^2$. The composition $\nu \circ \sigma : V^{-1}(\mathfrak{sl}_2) \rightarrow D^{\text{ch}}(\mathfrak{R}') = D^{\text{ch}}(T^*\mathbb{C}) \otimes \mathcal{H}^2$ maps the strong generators as follows

$$\nu \circ \sigma(e) = \gamma, \quad \nu \circ \sigma(h) = 2\gamma\beta + \dot{\alpha}, \quad \nu \circ \sigma(f) = -\beta^2\gamma + \partial\beta - \dot{\alpha}\beta. \quad (11.16)$$

$\nu \circ \sigma$ agrees with the Wakimoto realization of $V^{-1}(\mathfrak{sl}_2)$.

11.2 Reduction for vertex (super)algebras associated to quivers

Consider a quiver Q with gauge dimension \mathbf{v} and framing dimension \mathbf{w} such that $\mathbf{d} := \mathbf{w} - \mathbf{C}\mathbf{v} \in \mathbb{Z}_{\geq 0}^{Q_0}$. Suppose that there is a node $i \in Q_0$ such that $\mathbf{w}_i \geq \mathbf{v}_i$, then we decompose the framing vector space into $\mathbb{C}^{\mathbf{w}_i} = \mathbb{C}^{\mathbf{v}_i} \oplus \mathbb{C}^{\mathbf{w}_i - \mathbf{v}_i}$. Without loss of generality, we assume that i is a sink, i.e. there is no arrow in Q_1 going out from i , then we recognize the neighborhood of the node i as the situation in the previous subsection, see Fig. 22.

The new quiver Q' on the RHS of Fig. 22 is the sub-quiver of Q obtained by deleting the node i , and $\mathbf{v}'_j = \mathbf{v}_j, \mathbf{w}'_j = \mathbf{w}_j - \mathbf{C}_{ij}\mathbf{v}_i$.

The $\beta\gamma\text{bc}$ system on the LHS (resp. RHS) of Fig. 22 is denoted by $\mathcal{V}^\sharp(Q, \mathbf{v}, \mathbf{w})$ (resp. $\mathcal{V}^\sharp(Q', \mathbf{v}', \mathbf{w}')$). Moreover, if we add the inverse of I into $\mathcal{V}^\sharp(Q, \mathbf{v}, \mathbf{w})$, then according to (11.6) we have

$$\begin{aligned} H_{\text{BRST}}^{\infty/2+0}(\mathfrak{gl}(\mathbf{v}_i), \mathcal{V}^\sharp(Q, \mathbf{v}, \mathbf{w})[I^{-1}]) &= \left(\mathcal{V}^\sharp(Q', \mathbf{v}', \mathbf{w}') \rtimes \mathcal{H}^{\frac{\mathbf{w}_i - \mathbf{d}_i}{\mathbf{v}_i}} \right) \otimes \\ &\otimes D^{\text{ch}}(T^*\text{End}(\mathbb{C}^{\mathbf{v}_i})^{\oplus \mathfrak{g}_i}) \otimes D^{\text{ch}}(T^*\text{Hom}(\mathbb{C}^{\mathbf{w}_i - \mathbf{v}_i | \mathbf{d}_i}, \mathbb{C}^{\mathbf{v}_i})), \end{aligned} \quad (11.17)$$

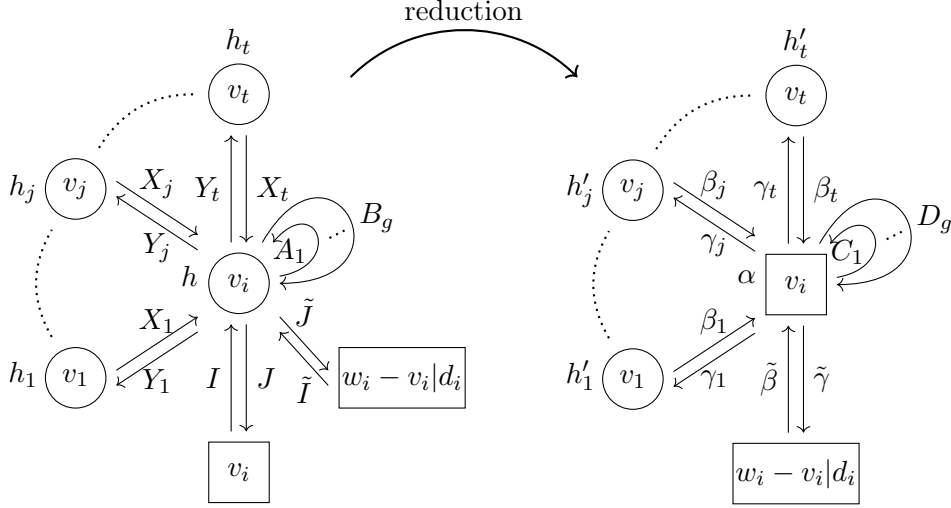

Figure 22: A general reduction procedure for a quiver diagram.

and $H_{\text{BRST}}^{\infty/2+n}(\mathfrak{gl}(\mathbf{v}_i), \mathcal{V}^\sharp(Q, \mathbf{v}, \mathbf{w})[I^{-1}]) = 0$ for $n \neq 0$. The fields on the RHS of (11.17) are given by

$$\begin{aligned} \mathcal{V}^\sharp(Q', \mathbf{v}', \mathbf{w}') &\ni \left\{ \beta_j = I^{-1}X_j, \gamma_j = Y_j I, h'_j = h_j - \frac{1}{\mathbf{v}_j} \text{Tr}(Y_j X_j) + \frac{1}{\mathbf{v}_j} \text{Tr}(\gamma_j \beta_j) \right\}, \\ \mathcal{H}^{\frac{\mathbf{w}_i - \mathbf{d}_i}{\mathbf{v}_i}} &\ni \left\{ \alpha = h_i + (2 - 2\mathbf{g}_i) \text{Tr}(I^{-1} \partial I) + \frac{1}{\mathbf{v}_i} \sum_{j \rightarrow i \in Q_1} \text{Tr}(\gamma_j \beta_j) \right\}, \\ D^{\text{ch}}(T^* \text{End}(\mathbb{C}^{\mathbf{v}_i})^{\oplus \mathbf{g}_i}) &\ni \{ C = I^{-1} A I, D = I^{-1} B I \}, \\ D^{\text{ch}}(T^* \text{Hom}(\mathbb{C}^{\mathbf{w}_i - \mathbf{v}_i | \mathbf{d}_i}, \mathbb{C}^{\mathbf{v}_i})) &\ni \{ \tilde{\beta} = I^{-1} \tilde{I}, \tilde{\gamma} = \tilde{J} I \}. \end{aligned} \quad (11.18)$$

The semi-direct product in (11.17) means that the Heisenberg algebra $\mathcal{H}^{\frac{\mathbf{w}_i - \mathbf{d}_i}{\mathbf{v}_i}}$ acts on $\mathcal{V}^\sharp(Q', \mathbf{v}', \mathbf{w}')$. The action is given by the following OPEs

$$\alpha(z) h'_j(w) \sim \frac{C_{i,j}}{(z-w)^2}, \quad \alpha(z) \beta_j(w) \sim \frac{-\mathbf{v}_i^{-1} \beta_j(w)}{z-w}, \quad \alpha(z) \gamma_j(w) \sim \frac{\mathbf{v}_i^{-1} \gamma_j(w)}{z-w}.$$

From now on, we denote $D^{\text{ch}}(T^* \text{End}(\mathbb{C}^{\mathbf{v}_i})^{\oplus \mathbf{g}_i}) \otimes D^{\text{ch}}(T^* \text{Hom}(\mathbb{C}^{\mathbf{w}_i - \mathbf{v}_i | \mathbf{d}_i}, \mathbb{C}^{\mathbf{v}_i}))$ by $D^{\text{ch}}(\mathcal{E}_i)$.

The current algebra $V^{-2\mathbf{v}_j}(\mathfrak{gl}(\mathbf{v}_j))$ corresponding to the node $j \neq i$ is automatically BRST-closed with respect to the $\mathfrak{gl}(\mathbf{v}_i)$ -cohomology, so there is a natural vertex algebra map

$$\begin{aligned} \tilde{\mu}'_{\text{ch},j} &: V^{-2\mathbf{v}_j}(\mathfrak{gl}(\mathbf{v}_j)) \rightarrow \mathcal{V}^\sharp(Q', \mathbf{v}', \mathbf{w}'), \\ \tilde{\mu}'_{\text{ch},j}(E_b^a) &= (Y_j)_c^a (X_j)_b^c - h_j \delta_b^a + \sum \text{terms which are not neighboring to node } i \\ &= (\gamma_j)_c^a (\beta_j)_b^c - h'_j \delta_b^a + \sum \text{terms which are not neighboring to node } i. \end{aligned}$$

So we see that $\tilde{\mu}'_{\text{ch},j}$ agrees with the extended chiral moment map corresponding to the node j in the new quiver Q' . Moreover, $\tilde{\mu}'_{\text{ch},j}$ commutes with the action of $\mathcal{H}^{\frac{\mathbf{w}_i - \mathbf{d}_i}{\mathbf{v}_i}}$, in fact our

choice of the Heisenberg field α instead of $\hat{\alpha}$ is precisely of this reason. It follows that there is a canonical isomorphism

$$H_{\text{BRST}}^{\infty/2+\bullet} \left(\bigoplus_{j \neq i} \mathfrak{gl}(\mathbf{v}_j), H_{\text{BRST}}^{\infty/2+0}(\mathfrak{gl}(\mathbf{v}_i), \mathcal{V}^\sharp(Q, \mathbf{v}, \mathbf{w})[I^{-1}]) \right) \cong \left(H_{\text{BRST}}^{\infty/2+\bullet}(\mathfrak{gl}(\mathbf{v}'), \mathcal{V}^\sharp(Q', \mathbf{v}', \mathbf{w}')) \rtimes \mathcal{H}^{\frac{\mathbf{w}_i - \mathbf{d}_i}{\mathbf{v}_i}} \right) \otimes D^{\text{ch}}(\mathcal{E}_i).$$

Consider the relative BRST complex $(C(\mathfrak{gl}(\mathbf{v}), \mathcal{V}^\sharp(Q, \mathbf{v}, \mathbf{w})[I^{-1}]), \mathcal{Q})$, and we decompose the BRST differential

$$\mathcal{Q} = \mathcal{Q}^i + \hat{\mathcal{Q}}^i$$

into the differential \mathcal{Q}^i corresponding to node i and the differential $\hat{\mathcal{Q}}^i = \sum_{j \neq i} \mathcal{Q}^j$ corresponding to nodes other than i . \mathcal{Q}^i anti-commutes with $\hat{\mathcal{Q}}^i$, then we have a spectral sequence with second page

$$E_2^{p,q} = H^q(H^p(C(\mathfrak{gl}(\mathbf{v}), \mathcal{V}^\sharp(Q, \mathbf{v}, \mathbf{w})[I^{-1}]), \mathcal{Q}^i), \hat{\mathcal{Q}}^i).$$

According to our previous discussion in (11.6), we have

$$H^0(C(\mathfrak{gl}(\mathbf{v}), \mathcal{V}^\sharp(Q, \mathbf{v}, \mathbf{w})[I^{-1}]), \mathcal{Q}^i) \cong \left(C(\mathfrak{gl}(\mathbf{v}'), \mathcal{V}^\sharp(Q', \mathbf{v}', \mathbf{w}')) \rtimes \mathcal{H}^{\frac{\mathbf{w}_i - \mathbf{d}_i}{\mathbf{v}_i}} \right) \otimes D^{\text{ch}}(\mathcal{E}_i),$$

and $H^p(C(\mathfrak{gl}(\mathbf{v}), \mathcal{V}^\sharp(Q, \mathbf{v}, \mathbf{w})[I^{-1}]), \mathcal{Q}^i)$ vanishes for $p \neq 0$. It follows that $E^{p,q}$ degenerates at the second page, and it converges to $H^{p+q}(C(\mathfrak{gl}(\mathbf{v}), \mathcal{V}^\sharp(Q, \mathbf{v}, \mathbf{w})[I^{-1}]), \mathcal{Q})$. Thus we have an isomorphism

$$H_{\text{BRST}}^{\infty/2+\bullet}(\mathfrak{gl}(\mathbf{v}), \mathcal{V}^\sharp(Q, \mathbf{v}, \mathbf{w})[I^{-1}]) \cong \left(H_{\text{BRST}}^{\infty/2+\bullet}(\mathfrak{gl}(\mathbf{v}'), \mathcal{V}^\sharp(Q', \mathbf{v}', \mathbf{w}')) \rtimes \mathcal{H}^{\frac{\mathbf{w}_i - \mathbf{d}_i}{\mathbf{v}_i}} \right) \otimes D^{\text{ch}}(\mathcal{E}_i). \quad (11.19)$$

The natural vertex superalgebra map $\mathcal{V}^\sharp(Q, \mathbf{v}, \mathbf{w}) \rightarrow \mathcal{V}^\sharp(Q, \mathbf{v}, \mathbf{w})[I^{-1}]$ induces a vertex superalgebra map between zeroth BRST cohomologies:

$$\nu_i : \mathcal{V}(Q, \mathbf{v}, \mathbf{w}) \rightarrow \mathcal{V}(Q', \mathbf{v}', \mathbf{w}') \rtimes \mathcal{H}^{\frac{\mathbf{w}_i - \mathbf{d}_i}{\mathbf{v}_i}} \otimes D^{\text{ch}}(\mathcal{E}_i). \quad (11.20)$$

We call ν_i the quiver reduction map at the node i .

The above construction naturally generalizes to sheaves of \hbar -adic vertex superalgebras. Let $\mathcal{U}_i \subset \widetilde{\mathcal{M}}(Q, \mathbf{v}, \mathbf{w})$ be the open subset on which the map I in the LHS of Fig. 22 is an isomorphism, then we have an isomorphism

$$\mathcal{U}_i \cong \widetilde{\mathcal{M}}(Q', \mathbf{v}', \mathbf{w}') \times \mathbb{C} \times \mathcal{E}_i, \quad (11.21)$$

where $\mathcal{E}_i = T^*\text{End}(\mathbb{C}^{\mathbf{v}_i})^{\oplus \mathbf{g}_i} \times T^*\text{Hom}(\mathbb{C}^{\mathbf{v}_i}, \mathbb{C}^{\mathbf{w}_i - \mathbf{v}_i | \mathbf{d}_i})$.

Lemma 11.3. *The restriction of $\mathcal{D}_{\mathcal{M}(Q, \mathbf{v}, \mathbf{w}), \hbar}^{\text{ch}}$ to \mathcal{U}_i is naturally isomorphic to*

$$\mathcal{D}_{\widetilde{\mathcal{M}}(Q', \mathbf{v}', \mathbf{w}'), \hbar}^{\text{ch}} \times \mathcal{H}_{\mathbb{C}, \hbar}^{\frac{\mathbf{w}_i - \mathbf{d}_i}{\mathbf{v}_i}} \boxtimes \mathcal{D}_{\mathcal{E}_i, \hbar}^{\text{ch}}.$$

Proof. Denote by \mathcal{R}_i the open subset of $T^*\text{Rep}(Q, \mathbf{v}, \mathbf{w}) \times \mathbb{C}^{\mathcal{Q}_0}$ on which the map I in the LHS of Fig. 22 is an isomorphism. \mathcal{R}_i is affine because it is the nonzero set of a single function $\det(I)$. The action of $\text{GL}(\mathbf{v}_i)$ on \mathcal{R}_i is free and there is an isomorphism

$$\mathcal{R}_i \cap \widetilde{\mu}_i^{-1}(0) // \text{GL}(\mathbf{v}_i) \cong T^*\text{Rep}(Q', \mathbf{v}', \mathbf{w}') \times \mathbb{C}^{\mathcal{Q}'_0} \times \mathbb{C} \times \mathcal{E}_i,$$

where $\widetilde{\mu}_i$ is the extended moment map associated to the node i . Denote by $q_i : \mathcal{R}_i \cap \widetilde{\mu}_i^{-1}(0) \rightarrow T^*\text{Rep}(Q', \mathbf{v}', \mathbf{w}') \times \mathbb{C}^{\mathcal{Q}'_0} \times \mathbb{C} \times \mathcal{E}_i$ the quotient map.

Denote by $\widetilde{\mu}' : T^*\text{Rep}(Q', \mathbf{v}', \mathbf{w}') \times \mathbb{C}^{\mathcal{Q}'_0} \rightarrow \mathfrak{gl}(\mathbf{v}')^*$ the extended moment map for Q' , and denote by $q' : \widetilde{\mu}'^{-1}(0)^{\text{st}} \times \mathbb{C} \times \mathcal{E}_i \rightarrow \widetilde{\mathcal{M}}(Q', \mathbf{v}', \mathbf{w}') \times \mathbb{C} \times \mathcal{E}_i$ the quotient map.

Now we take an arbitrary affine open subset $U \subset \mathcal{U}_i$ and choose an affine open subset $\widetilde{U}' \subset T^*\text{Rep}(Q', \mathbf{v}', \mathbf{w}') \times \mathbb{C}^{\mathcal{Q}'_0} \times \mathbb{C} \times \mathcal{E}_i$ such that $\widetilde{U}' \cap (\widetilde{\mu}'^{-1}(0) \times \mathbb{C} \times \mathcal{E}_i) = q'^{-1}(U)$. Then we choose an affine open subset $\widetilde{U} \subset \mathcal{R}_i$ such that $\widetilde{U} \cap \widetilde{\mu}_i^{-1}(0) = q_i^{-1}(\widetilde{U}')$.

According to (10.10), we have

$$\mathcal{D}_{\mathcal{M}(Q, \mathbf{v}, \mathbf{w}), \hbar}^{\text{ch}}(U) = H_{\hbar\text{BRST}}^{\infty/2+0}(\mathfrak{gl}(\mathbf{v}), \mathcal{D}_{\mathfrak{R}, \hbar}^{\text{ch}}(\widetilde{U})).$$

Consider the decomposition $\mathcal{Q}_\hbar = \mathcal{Q}_\hbar^i + \mathcal{Q}_\hbar^{\hat{i}}$ into differential \mathcal{Q}_\hbar^i corresponding to the node i and differential $\mathcal{Q}_\hbar^{\hat{i}} = \sum_{j \neq i} \mathcal{Q}_\hbar^j$ corresponding to nodes other than i . \mathcal{Q}_\hbar^i anti-commutes with $\mathcal{Q}_\hbar^{\hat{i}}$, then we have a spectral sequence with second page

$$E_2^{p,q} = H^q(H^p(C(\mathfrak{gl}(\mathbf{v}), \mathcal{D}_{\mathfrak{R}, \hbar}^{\text{ch}}(\widetilde{U})), \mathcal{Q}_\hbar^i), \mathcal{Q}_\hbar^{\hat{i}}).$$

According to our previous discussion in (11.6), we have

$$H^0(C(\mathfrak{gl}(\mathbf{v}), \mathcal{D}_{\mathfrak{R}, \hbar}^{\text{ch}}(\widetilde{U})), \mathcal{Q}_\hbar^i) \cong C \left(\mathfrak{gl}(\mathbf{v}'), \left(\mathcal{D}_{\mathfrak{R}', \hbar}^{\text{ch}} \times \mathcal{H}_{\mathbb{C}, \hbar}^{\frac{\mathbf{w}_i - \mathbf{d}_i}{\mathbf{v}_i}} \boxtimes \mathcal{D}_{\mathcal{E}_i, \hbar}^{\text{ch}} \right) (\widetilde{U}') \right)_\hbar,$$

and $H^p(C(\mathfrak{gl}(\mathbf{v}), \mathcal{D}_{\mathfrak{R}, \hbar}^{\text{ch}}(\widetilde{U})), \mathcal{Q}_\hbar^i)$ vanishes for $p \neq 0$. It follows that the spectral sequence $E^{p,q}$ degenerates at the second page, and it converges to

$$H^{p+q}(C(\mathfrak{gl}(\mathbf{v}), \mathcal{D}_{\mathfrak{R}, \hbar}^{\text{ch}}(\widetilde{U})), \mathcal{Q}_\hbar) = H_{\hbar\text{BRST}}^{\infty/2+p+q}(\mathfrak{gl}(\mathbf{v}), \mathcal{D}_{\mathfrak{R}, \hbar}^{\text{ch}}(\widetilde{U})).$$

On the other hand,

$$\begin{aligned} E_2^{0,0} &= H_{\hbar\text{BRST}}^{\infty/2+0} \left(\mathfrak{gl}(\mathbf{v}'), \left(\mathcal{D}_{\mathfrak{R}', \hbar}^{\text{ch}} \times \mathcal{H}_{\mathbb{C}, \hbar}^{\frac{\mathbf{w}_i - \mathbf{d}_i}{\mathbf{v}_i}} \boxtimes \mathcal{D}_{\mathcal{E}_i, \hbar}^{\text{ch}} \right) (\widetilde{U}') \right) \\ &= \mathcal{D}_{\widetilde{\mathcal{M}}(Q', \mathbf{v}', \mathbf{w}'), \hbar}^{\text{ch}} \times \mathcal{H}_{\mathbb{C}, \hbar}^{\frac{\mathbf{w}_i - \mathbf{d}_i}{\mathbf{v}_i}} \boxtimes \mathcal{D}_{\mathcal{E}_i, \hbar}^{\text{ch}}(U), \end{aligned}$$

and $E_2^{p,q}$ vanishes for $(p, q) \neq (0, 0)$. Thus we have isomorphism between \hbar -adic vertex superalgebras:

$$\mathcal{D}_{\widetilde{\mathcal{M}}(Q, \mathbf{v}, \mathbf{w}), \hbar}^{\text{ch}}(U) \cong \mathcal{D}_{\widetilde{\mathcal{M}}(Q', \mathbf{v}', \mathbf{w}'), \hbar}^{\text{ch}} \times \mathcal{H}_{\mathbb{C}, \hbar}^{\frac{\mathbf{w}_i - \mathbf{d}_i}{\mathbf{v}_i}} \boxtimes \mathcal{D}_{\mathcal{E}_i, \hbar}^{\text{ch}}(U).$$

By construction such isomorphism is compatible with restriction to smaller affine open subsets, thus we get an isomorphism between sheaves of \hbar -adic vertex superalgebras:

$$\mathcal{D}_{\widetilde{\mathcal{M}}(Q, \mathbf{v}, \mathbf{w}), \hbar}^{\text{ch}}|_{\mathcal{U}_i} \cong \mathcal{D}_{\widetilde{\mathcal{M}}(Q', \mathbf{v}', \mathbf{w}'), \hbar}^{\text{ch}} \times \mathcal{H}_{\mathbb{C}, \hbar}^{\frac{\mathbf{w}_i - \mathbf{d}_i}{\mathbf{v}_i}} \boxtimes \mathcal{D}_{\mathcal{E}_i, \hbar}^{\text{ch}}.$$

This finishes the proof of the lemma. \square

The restriction to \mathcal{U}_i gives rise to an injective map between \hbar -adic vertex superalgebras:

$$\mathcal{D}_{\widetilde{\mathcal{M}}(Q, \mathbf{v}, \mathbf{w}), \hbar}^{\text{ch}}(\widetilde{\mathcal{M}}(Q, \mathbf{v}, \mathbf{w})) \hookrightarrow \mathcal{D}_{\widetilde{\mathcal{M}}(Q, \mathbf{v}, \mathbf{w}), \hbar}^{\text{ch}}(\mathcal{U}_i), \quad (11.22)$$

and the RHS is isomorphic to $\mathcal{D}_{\widetilde{\mathcal{M}}(Q', \mathbf{v}', \mathbf{w}'), \hbar}^{\text{ch}}(\widetilde{\mathcal{M}}(Q', \mathbf{v}', \mathbf{w}')) \times \mathcal{H}_{\hbar}^{\frac{\mathbf{w}_i - \mathbf{d}_i}{\mathbf{v}_i}} \otimes D^{\text{ch}}(\mathcal{E}_i)_{\hbar}$ by the Lemma 11.3.

We note that the \mathbb{S} -action on the sheaf $\mathcal{D}_{\widetilde{\mathcal{M}}(Q', \mathbf{v}', \mathbf{w}'), \hbar}^{\text{ch}} \times \mathcal{H}_{\mathbb{C}, \hbar}^{\frac{\mathbf{w}_i - \mathbf{d}_i}{\mathbf{v}_i}} \boxtimes \mathcal{D}_{\mathcal{E}_i, \hbar}^{\text{ch}}$ is given by the weights assignment

$$\text{wt}(X_{(-n)}) = \text{wt}(Y_{(-n)}) = \text{wt}(I_{s, (-n)}) = \text{wt}(J_{s, (-n)}) = n, \quad \text{wt}(h'_{(-n)}) = n + 1, \quad (11.23)$$

for those nodes $s \in Q'_0$ which are not connected to the node i in the original quiver Q , and

$$\text{wt}(\widetilde{I}_{(-n)}) = \text{wt}(\beta_{j, (-n)}) = n - 1, \quad \text{wt}(\widetilde{J}_{(-n)}) = \text{wt}(\gamma_{j, (-n)}) = n + 1, \quad (11.24)$$

for those nodes $j \in Q'_0$ which are connected to the node i in the original quiver Q , and

$$\text{wt}(\alpha_{(-n)}) = n + 1, \quad \text{wt}(C_{(-n)}) = \text{wt}(D_{(-n)}) = n, \quad (11.25)$$

and the weights assignment (10.13) to the bc ghosts and \hbar . Although the \mathbb{S} -action on $\mathcal{D}_{\widetilde{\mathcal{M}}(Q', \mathbf{v}', \mathbf{w}'), \hbar}^{\text{ch}}(\widetilde{\mathcal{M}}(Q', \mathbf{v}', \mathbf{w}'))$ is not the same as the one defined in section 10.2, the next lemma asserts that these two actions have the same finite-weights part.

Lemma 11.4. *Let \mathbb{S}' be a one-dimensional torus, and define \mathbb{S}' action on $\mathcal{D}_{\widetilde{\mathcal{M}}(Q', \mathbf{v}', \mathbf{w}'), \hbar}^{\text{ch}}$ by weights assignment (11.23) and $\text{wt}(\beta_{j, (-n)}) = \text{wt}(\gamma_{j, (-n)}) = n$. Then we have*

$$\mathcal{D}_{\widetilde{\mathcal{M}}(Q', \mathbf{v}', \mathbf{w}'), \hbar}^{\text{ch}}(\widetilde{\mathcal{M}}(Q', \mathbf{v}', \mathbf{w}'))_{\mathbb{S}\text{-fin}} = \mathcal{D}_{\widetilde{\mathcal{M}}(Q', \mathbf{v}', \mathbf{w}'), \hbar}^{\text{ch}}(\widetilde{\mathcal{M}}(Q', \mathbf{v}', \mathbf{w}'))_{\mathbb{S}'\text{-fin}}. \quad (11.26)$$

Proof. Let $\mathcal{D}_{\widetilde{\mathcal{M}}(Q', \mathbf{v}', \mathbf{w}'), \hbar}^{\text{ch}}(\widetilde{\mathcal{M}}(Q', \mathbf{v}', \mathbf{w}'))_m$ be the \mathbb{S} -degree m eigenspace. Since the \mathbb{S} -action commutes with the \mathbb{S}' -action, we have

$$\mathcal{D}_{\widetilde{\mathcal{M}}(Q', \mathbf{v}', \mathbf{w}'), \hbar}^{\text{ch}}(\widetilde{\mathcal{M}}(Q', \mathbf{v}', \mathbf{w}'))_m = \prod_{n \geq -M}' \mathcal{D}_{\widetilde{\mathcal{M}}(Q', \mathbf{v}', \mathbf{w}'), \hbar}^{\text{ch}}(\widetilde{\mathcal{M}}(Q', \mathbf{v}', \mathbf{w}'))_{m, n},$$

where the subscript m, n denotes \mathbb{S} -degree m \mathbb{S}' -degree n eigenspace. The restricted product \prod' means the subspace of the product space consisting of elements $(x_i)_{i=-M}^{\infty}$ such that there exists N and $x_n \in \hbar^{n-N} \mathcal{D}_{\widetilde{\mathcal{M}}(Q', \mathbf{v}', \mathbf{w}'), \hbar}^{\text{ch}}(\widetilde{\mathcal{M}}(Q', \mathbf{v}', \mathbf{w}'))_{N+m-n, N}$ for all $n > N$. Since \mathbb{S} -degrees are bounded from below, x_n vanishes for sufficiently large n , thus we have

$$\mathcal{D}_{\widetilde{\mathcal{M}}(Q', \mathbf{v}', \mathbf{w}'), \hbar}^{\text{ch}}(\widetilde{\mathcal{M}}(Q', \mathbf{v}', \mathbf{w}'))_m = \bigoplus_{n \geq -M} \mathcal{D}_{\widetilde{\mathcal{M}}(Q', \mathbf{v}', \mathbf{w}'), \hbar}^{\text{ch}}(\widetilde{\mathcal{M}}(Q', \mathbf{v}', \mathbf{w}'))_{m, n}.$$

It follows that $\mathcal{D}_{\widetilde{\mathcal{M}}(Q', \mathbf{v}', \mathbf{w}'), \hbar}^{\text{ch}}(\widetilde{\mathcal{M}}(Q', \mathbf{v}', \mathbf{w}'))_{\mathbb{S}\text{-fin}} \subseteq \mathcal{D}_{\widetilde{\mathcal{M}}(Q', \mathbf{v}', \mathbf{w}'), \hbar}^{\text{ch}}(\widetilde{\mathcal{M}}(Q', \mathbf{v}', \mathbf{w}'))_{\mathbb{S}'\text{-fin}}$. Exchange the role of \mathbb{S} and \mathbb{S}' in the above argument, and we have the reverse inclusion, this finishes the proof. \square

By the definition,

$$\text{D}^{\text{ch}}(\widetilde{\mathcal{M}}(Q', \mathbf{v}', \mathbf{w}')) = \mathcal{D}_{\widetilde{\mathcal{M}}(Q', \mathbf{v}', \mathbf{w}'), \hbar}^{\text{ch}}(\widetilde{\mathcal{M}}(Q', \mathbf{v}', \mathbf{w}'))_{\mathbb{S}'\text{-fin}} / (\hbar - 1).$$

According to the Lemma 11.4, we can also take the \mathbb{S} -finite part in the above definition. We take the \mathbb{S} -finite parts of the two sides of the inclusion (11.22) and set $\hbar = 1$, then we get an embedding of vertex superalgebras:

$$\nu_i : \text{D}^{\text{ch}}(\widetilde{\mathcal{M}}(Q, \mathbf{v}, \mathbf{w})) \hookrightarrow \text{D}^{\text{ch}}(\widetilde{\mathcal{M}}(Q', \mathbf{v}', \mathbf{w}')) \rtimes \mathcal{H}^{\frac{\mathbf{w}_i - \mathbf{d}_i}{\mathbf{v}_i}} \otimes D^{\text{ch}}(\mathcal{E}_i). \quad (11.27)$$

(11.20) and (11.27) are compatible, namely the following diagram commutes:

$$\begin{array}{ccc} \mathcal{V}(Q, \mathbf{v}, \mathbf{w}) & \xrightarrow{\nu_i} & \mathcal{V}(Q', \mathbf{v}', \mathbf{w}') \rtimes \mathcal{H}^{\frac{\mathbf{w}_i - \mathbf{d}_i}{\mathbf{v}_i}} \otimes D^{\text{ch}}(\mathcal{E}_i) \\ \downarrow \iota & & \downarrow \iota' \\ \text{D}^{\text{ch}}(\widetilde{\mathcal{M}}(Q, \mathbf{v}, \mathbf{w})) & \xrightarrow{\nu_i} & \text{D}^{\text{ch}}(\widetilde{\mathcal{M}}(Q', \mathbf{v}', \mathbf{w}')) \rtimes \mathcal{H}^{\frac{\mathbf{w}_i - \mathbf{d}_i}{\mathbf{v}_i}} \otimes D^{\text{ch}}(\mathcal{E}_i) \end{array} \quad (11.28)$$

where the vertical arrows are the maps in (10.16).

Remark 11.1. The Heisenberg field α in (11.18) is chosen such that it commutes with the extended chiral moment maps for the new quiver Q' . The drawback of such a choice is that α acts on $\mathcal{V}^{\sharp}(Q', \mathbf{v}', \mathbf{w}')$ nontrivially, so we get a semi-direct product instead of a direct product between $\mathcal{V}^{\sharp}(Q', \mathbf{v}', \mathbf{w}')$ and $\mathcal{H}^{\frac{\mathbf{w}_i - \mathbf{d}_i}{\mathbf{v}_i}}$. However, if Q' satisfies certain conditions which will be specified below, then we can deform α using fields in $\mathcal{V}^{\sharp}(Q', \mathbf{v}', \mathbf{w}')$ such that the deformation is still a Heisenberg field and it acts on $\mathcal{V}^{\sharp}(Q', \mathbf{v}', \mathbf{w}')$ trivially.

Let \mathbf{C}' be the Cartan matrix of Q' . Suppose that there exists $\zeta \in \mathbb{C}^{Q'_0}$ such that

$$(\mathbf{C}'\zeta)_j = \mathbf{C}_{i,j}, \quad \forall j \in Q'_0,$$

then we define

$$\bar{\alpha} := \alpha - \frac{1}{\mathbf{v}_i} \sum_{j \rightarrow i \in Q_1} \text{Tr}(\gamma_j \beta_j) - \sum_{j \in Q'_0} \zeta_j h'_j. \quad (11.29)$$

Now it is straightforward to see that OPEs between $\bar{\alpha}$ and strong generators of $\mathcal{V}^{\sharp}(Q', \mathbf{v}', \mathbf{w}')$ are regular, thus $\bar{\alpha}$ acts on the latter trivially. The level of $\bar{\alpha}$ equals to $2 - 2\mathbf{g}_i - \sum_{j \in Q'_0} \mathbf{C}_{i,j} \zeta_j$.

For example, if Q' is a disjoint union of Dynkin quivers, then \mathbf{C}' is invertible, thus the existence (and uniqueness) of ζ is guaranteed, namely we take $\zeta_j = \sum_{k \in Q'_0} (\mathbf{C}'^{-1})_{j,k} \mathbf{C}_{i,k}$. In this case the level of $\bar{\alpha}$ is $\det(\mathbf{C}) / \det(\mathbf{C}')$.

11.3 Generalization

In our previous discussion of quiver reductions, we needed the condition that $\mathbf{w}_i \geq \mathbf{v}_i$. In this section, we generalize it to the following situation.

Let Q be a quiver and let $i \in Q_0$ be a node. Without loss of generality let us assume that i is a sink. Choose gauge and framing dimensions \mathbf{v}, \mathbf{w} such that $\mathbf{w} - \mathbf{C}\mathbf{v} \in \mathbb{Z}_{\geq 0}^{Q_0}$. Assume moreover that there exists a set of nodes $\mathcal{N} \subset Q_0 \setminus \{i\}$ such that $C_{ij} \neq 0, \forall j \in \mathcal{N}$, and $\sum_{j \in \mathcal{N}} \mathbf{v}_j \leq \mathbf{v}_i$, and $\mathbf{w}_i + \sum_{j \in \mathcal{N}} \mathbf{v}_j \geq \mathbf{v}_i$. Let us split the framing vector space into

$$\mathbb{C}^{\mathbf{w}_i} = \mathbb{C}^{\mathbf{w}_{i,1}} \oplus \mathbb{C}^{\mathbf{w}_{i,2}}, \quad \text{where} \quad \mathbf{w}_{i,1} = \mathbf{w}_i - \mathbf{v}_i + \sum_{j \in \mathcal{N}} \mathbf{v}_j,$$

and fix a choice of $a_j \in$ the set of arrows from j to i , then consider the open locus $\mathcal{U} \subset \widetilde{\mathcal{M}}(Q, \mathbf{v}, \mathbf{w})$ on which the linear map

$$\mathcal{I} := (I|_{\mathbb{C}^{\mathbf{w}_{i,2}}, (X_{a_j})_{j \in \mathcal{N}}}) : \mathbb{C}^{\mathbf{w}_{i,2}} \oplus \bigoplus_{j \in \mathcal{N}} V_j \longrightarrow V_i \text{ is an isomorphism.}$$

An argument similar to the beginning of this section shows that

$$\mathcal{U} \cong \widetilde{\mathcal{M}}(Q', \mathbf{v}', \mathbf{w}') \times \mathbb{C} \times T^*\text{End}(\mathbb{C}^{\mathbf{w}_{i,2}})^{\oplus \mathbf{g}_i} \times T^*\text{Hom}(\mathbb{C}^{\mathbf{w}_{i,1}}, \mathbb{C}^{\mathbf{w}_{i,2}}), \quad (11.30)$$

where Q' is the quiver whose set of nodes is $Q'_0 = Q_0 \setminus \{i\}$, and the Cartan matrix C' for Q' is

$$C'_{j,l} = \begin{cases} C_{j,l}, & j \notin \mathcal{N}, l \notin \mathcal{N}, \\ C_{j,l} + C_{j,i}, & j \notin \mathcal{N}, l \in \mathcal{N}, \\ C_{j,l} + C_{i,l}, & j \in \mathcal{N}, l \notin \mathcal{N}, \\ C_{j,l} + C_{i,l} + C_{j,i} + C_{i,i}, & j, l \in \mathcal{N}. \end{cases} \quad (11.31)$$

The gauge and framing dimension vectors are determined by

$$\mathbf{v}'_j = \mathbf{v}_j, \quad \mathbf{w}'_j = \begin{cases} \mathbf{w}_j - C_{j,i} \mathbf{w}_{i,2}, & j \notin \mathcal{N}, \\ \mathbf{w}_j + \mathbf{w}_i - C_{j,i} \mathbf{w}_{i,2} - C_{i,i} \mathbf{w}_{i,2}, & j \in \mathcal{N}. \end{cases} \quad (11.32)$$

It is easy to see that

$$(\mathbf{w}' - C'\mathbf{v}')_j = \begin{cases} (\mathbf{w} - \mathbf{C}\mathbf{v})_j, & j \notin \mathcal{N}, \\ (\mathbf{w} - \mathbf{C}\mathbf{v})_j + (\mathbf{w} - \mathbf{C}\mathbf{v})_i, & j \in \mathcal{N}. \end{cases}$$

In particular $\mathbf{w}' - C'\mathbf{v}' \in \mathbb{Z}_{\geq 0}^{Q'_0}$.

Using the analysis in the section 11.1, we obtain the following generalization of previous results in the section 11.2.

(1) There exists a natural map of vertex superalgebras:

$$\nu : \mathcal{V}(Q, \mathbf{v}, \mathbf{w}) \rightarrow \mathcal{V}(Q', \mathbf{v}', \mathbf{w}') \rtimes \mathcal{H}^\lambda \otimes D^{\text{ch}}(\mathcal{E}). \quad (11.33)$$

where \mathcal{H}^λ is the Heisenberg algebra of certain level λ , and $D^{\text{ch}}(\mathcal{E})$ is the $\beta\gamma\text{bc}$ system on $\mathcal{E} = T^*\text{End}(\mathbb{C}^{\mathbf{w}_{i,2}})^{\oplus \mathbf{g}_i} \times T^*\text{Hom}(\mathbb{C}^{\mathbf{w}_{i,1}}, \mathbb{C}^{\mathbf{w}_{i,2}})$. We also have generalization of (11.18), for simplicity we only list the Heisenberg fields as follows

$$h'_j = \begin{cases} h_j + C_{i,j} \text{Tr}(\mathcal{I}^{-1} \partial \mathcal{I}), & j \notin \mathcal{N}, \\ h_j + h_i + (C_{i,j} + C_{i,i}) \text{Tr}(\mathcal{I}^{-1} \partial \mathcal{I}), & j \in \mathcal{N}, \end{cases} \quad (11.34)$$

$$\alpha = h_i + C_{i,i} \text{Tr}(\mathcal{I}^{-1} \partial \mathcal{I}) + \text{linear comb. of } \text{Tr}(\beta_j \gamma_j), \text{Tr}(I'_j J'_j), \text{Tr}(X'_a Y'_a). \quad (11.35)$$

(2) There exists an embedding of vertex superalgebras:

$$\nu : D^{\text{ch}}(\widetilde{\mathcal{M}}(Q, \mathbf{v}, \mathbf{w})) \hookrightarrow D^{\text{ch}}(\widetilde{\mathcal{M}}(Q', \mathbf{v}', \mathbf{w}')) \rtimes \mathcal{H}^\lambda \otimes D^{\text{ch}}(\mathcal{E}). \quad (11.36)$$

(11.33) and (11.36) are compatible, namely the following diagram commutes:

$$\begin{array}{ccc} \mathcal{V}(Q, \mathbf{v}, \mathbf{w}) & \xrightarrow{\nu} & \mathcal{V}(Q', \mathbf{v}', \mathbf{w}') \rtimes \mathcal{H}^\lambda \otimes D^{\text{ch}}(\mathcal{E}) \\ \downarrow \iota & & \downarrow \iota' \\ D^{\text{ch}}(\widetilde{\mathcal{M}}(Q, \mathbf{v}, \mathbf{w})) & \xrightarrow{\nu} & D^{\text{ch}}(\widetilde{\mathcal{M}}(Q', \mathbf{v}', \mathbf{w}')) \rtimes \mathcal{H}^\lambda \otimes D^{\text{ch}}(\mathcal{E}) \end{array} \quad (11.37)$$

where the vertical arrows are the maps in (10.16).

Remark 11.2. The Heisenberg field α in (11.35) is chosen such that it commutes with the extended chiral moment maps for the new quiver Q' . The drawback of such choice is that α acts on $\mathcal{V}(Q', \mathbf{v}', \mathbf{w}')$ nontrivially, so we get a semi-direct product instead of a direct product between $\mathcal{V}(Q', \mathbf{v}', \mathbf{w}')$ and \mathcal{H}^λ . This drawback can be cured in the same way as in Remark 11.1.

Let C' be the Cartan matrix of Q' . Suppose that there exists $\zeta \in \mathbb{C}^{Q'_0}$ such that

$$\forall j \in Q'_0, \quad (C' \zeta)_j = \begin{cases} C_{i,j}, & j \notin \mathcal{N}, \\ C_{i,j} + C_{i,i}, & j \in \mathcal{N}, \end{cases}$$

then we define

$$\bar{\alpha} := h_i + C_{i,i} \text{Tr}(\mathcal{I}^{-1} \partial \mathcal{I}) - \sum_{j \in Q'_0} \zeta_j h'_j. \quad (11.38)$$

Now it is straightforward to see that $\bar{\alpha}$ commutes with $\mathcal{V}^\sharp(Q', \mathbf{v}', \mathbf{w}')$, so we get a direct product between $\mathcal{V}(Q', \mathbf{v}', \mathbf{w}')$ and a Heisenberg algebra. The level of $\bar{\alpha}$ equals to

$$2 - 2\mathbf{g}_i - (2 - 2\mathbf{g}_i) \sum_{j \in \mathcal{N}} \zeta_j - \sum_{j \in Q'_0} C_{i,j} \zeta_j.$$

For example, if Q' is a disjoint union of Dynkin quivers, then C' is invertible, thus the existence (and uniqueness) of ζ is guaranteed, namely we take

$$\zeta_j = \sum_{k \in Q'_0} (C'^{-1})_{j,k} C_{i,k} + (2 - 2g_i) \sum_{k \in \mathcal{N}} (C'^{-1})_{j,k}.$$

In this case the level of $\bar{\alpha}$ is $\det(C)/\det(C')$.

The following lemma tells us that every good linear quiver contains a node for which the quiver reduction can be performed.

Lemma 11.5. *Let Q be a finite type A quiver whose Cartan matrix is denoted by C , and choose gauge dimension \mathbf{v} and framing dimension \mathbf{w} such that $\mathbf{w} - C\mathbf{v} \in \mathbb{Z}_{\geq 0}^{Q_0}$, then there exists a node $i \in Q_0$ such that one of the following condition holds*

1. $\mathbf{w}_i \geq \mathbf{v}_i$,
2. $\mathbf{w}_i < \mathbf{v}_i$ and there exists $j \in \{i+1, i-1\}$ such that $\mathbf{v}_j \leq \mathbf{v}_i$ and $\mathbf{w}_i + \mathbf{v}_j \geq \mathbf{v}_i$.

Proof. Suppose that the condition 1 fails for all nodes, i.e. $\mathbf{w}_i < \mathbf{v}_i$ for all $i \in Q_0$, then we claim that the condition 2 holds for at least one node. Let us take $i \in Q_0$ with maximal \mathbf{v}_i , i.e. $\mathbf{v}_i \geq \mathbf{v}_k$ for all $k \in Q_0$. Choose $j \in \{i-1, i+1\}$, then $\mathbf{v}_j \leq \mathbf{v}_i$ by our choice of i , and we must have $\mathbf{w}_i + \mathbf{v}_j \geq \mathbf{v}_i$, otherwise we would have $\mathbf{w}_i + \mathbf{v}_{i-1} + \mathbf{v}_{i+1} < 2\mathbf{v}_i$ which contradicts with the assumption that $\mathbf{w} - C\mathbf{v} \in \mathbb{Z}_{\geq 0}^{Q_0}$. This finishes the proof. \square

The Lemma 11.5 implies that for a good linear quiver Q , we can always perform a quiver reduction to reduce it to a quiver Q' with one less nodes. Moreover, our quiver reduction algorithm asserts that Q' is either a good linear quiver or a disjoint union of two good linear quivers, so we can repeat the quiver reduction algorithm for Q' , using Lemma 11.5 again. Starting from Q , we recursively reduce it, and we end up with a tensor product of $\beta\gamma\mathbf{bc}$ system and some Heisenberg algebra. We summarize it in the following proposition.

Theorem 11.1. *Let Q be a finite type A quiver whose Cartan matrix is denoted by C , and choose gauge dimension \mathbf{v} and framing dimension \mathbf{w} such that $\mathbf{w} - C\mathbf{v} \in \mathbb{Z}_{\geq 0}^{Q_0}$, then there exists an embedding of vertex superalgebras:*

$$\Theta : D^{\text{ch}}(\widetilde{\mathcal{M}}(Q, \mathbf{v}, \mathbf{w})) \hookrightarrow D^{\text{ch}}(T^*\mathbb{C}^n |^m) \otimes \bigotimes_{i \in Q_0} \mathcal{H}^{\lambda_i}, \quad (11.39)$$

where $n = \mathbf{v} \cdot (\mathbf{w} - \frac{1}{2}C\mathbf{v})$, and $m = \mathbf{v} \cdot \mathbf{d} = \mathbf{v} \cdot (\mathbf{w} - C\mathbf{v})$.

In other words, we get a free-field realization of $D^{\text{ch}}(\widetilde{\mathcal{M}}(Q, \mathbf{v}, \mathbf{w}))$ via recursively applying quiver reductions.

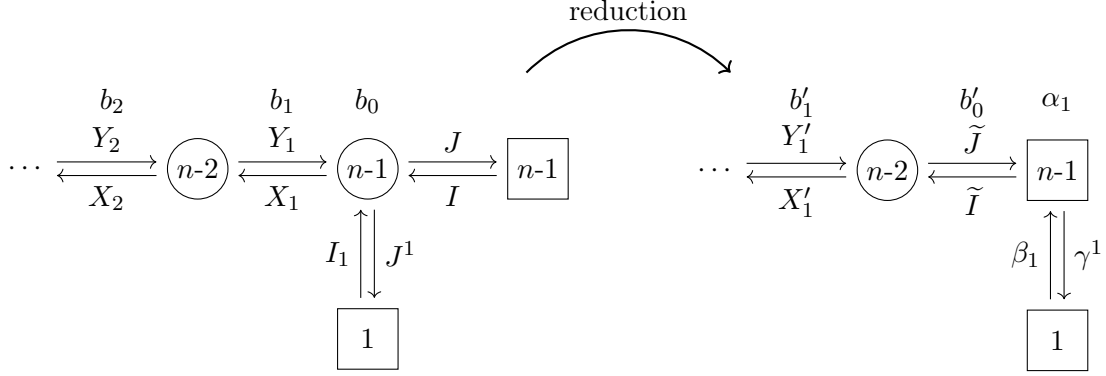

Figure 23: Reduction procedure of the quiver, as applied to the rightmost node of the $T[\text{SU}(n)]$ quiver.

12 Examples of quiver reductions

12.1 Example: $T[\text{SU}(n)]$ quiver

We revisit the $T[\text{SU}(n)]$ quiver in this section. According to our previous discussions in section 10.3, there exists a vertex algebra embedding $V^{-n+1}(\mathfrak{sl}_n) \hookrightarrow \text{D}^{\text{ch}}(\widetilde{\mathcal{M}}(Q))$ determined by the map on strong generators (10.20). Composing with the embedding (11.39) we get a free-field realization $V^{-n+1}(\mathfrak{sl}_n) \hookrightarrow D^{\text{ch}}(T^*\mathbb{C}^{n(n-1)/2}) \otimes \bigotimes_{i=1}^{n-1} \mathcal{H}^{\lambda_i}$. We will show in this section that this is exactly the Wakimoto realization of $V^{-n+1}(\mathfrak{sl}_n)$ [55, 56].

It turns out that it will be more convenient to work with \mathfrak{gl}_n instead of \mathfrak{sl}_n . Accordingly we add one Heisenberg field J_B of level n to $\text{D}^{\text{ch}}(\widetilde{\mathcal{M}}(Q))$, or equivalently we take n copies of independent level 1 Heisenberg algebras b_0, \dots, b_{n-1} , and set $h_i := b_i - b_{i-1}$ and $J_B = b_0 + \dots + b_{n-1}$. Then there exists a vertex subalgebra $V^{-n+1}(\mathfrak{gl}_n) \subset \text{D}^{\text{ch}}(\widetilde{\mathcal{M}}(Q)) \otimes J_B$ which is strongly generated by ¹⁷

$$E_j^i := J_k^i I_j^k - b_0 \delta_j^i, \quad 1 \leq i, j \leq n.$$

The quiver reduction is depicted as follows. According to our reduction algorithm, we have

$$\tilde{I} = X_1 I, \quad \tilde{J} = I^{-1} Y_1, \quad \beta_1 = I^{-1} I_1, \quad \gamma^1 = J^1 I, \quad (12.1)$$

and

$$\alpha_1 = b_0 - \text{Tr}(I^{-1} \partial I), \quad b'_i = \begin{cases} b_{i+1}, & i > 0, \\ b_1 + \text{Tr}(I^{-1} \partial I), & i = 0. \end{cases} \quad (12.2)$$

The quiver reduction gives a vertex algebra embedding

$$\nu : \text{D}^{\text{ch}}(\widetilde{\mathcal{M}}(Q)) \otimes J_B \hookrightarrow \text{D}^{\text{ch}}(\widetilde{\mathcal{M}}(Q')) \otimes J'_B \otimes D^{\text{ch}}(T^*\mathbb{C}^{n-1}) \otimes \alpha_1,$$

¹⁷Here our convention for $V^\lambda(\mathfrak{gl}_n)$ is that $E_b^a(z)E_d^c(w) \sim \frac{\lambda \delta_b^a \delta_c^d + \delta_b^a \delta_d^c}{(z-w)^2} + \text{lower order term}$.

where $J'_B = \sum_{i=0}^{n-2} b'_i$ is a level $n-1$ Heisenberg algebra, $D^{\text{ch}}(T^*\mathbb{C}^{n-1})$ is a $\beta\gamma$ system which is strongly generated by β_1^i, γ_i^1 for $i = 2, \dots, n$, and α_1 is a level 1 Heisenberg algebra. There is a vertex subalgebra $V^{-n+2}(\mathfrak{gl}_{n-1}) \subset D^{\text{ch}}(\widetilde{\mathcal{M}}(Q')) \otimes J'_B$, strongly generated by

$$\widetilde{E}_j^i := \widetilde{J}_k^i \widetilde{I}_j^k - b'_0 \delta_j^i, \quad 2 \leq i, j \leq n. \quad (12.3)$$

Now we compute the image of E_j^i after reduction:

$$\begin{aligned} \nu(E_1^1) &= \sum_{i=2}^n \gamma_i^1 \beta_1^i - \alpha_1, \\ \nu(E_i^1) &= \gamma_i^1, \quad 1 < i \leq n, \\ \nu(E_1^i) &= \sum_{k=2}^n \widetilde{E}_k^i \beta_1^k + \alpha_1 \beta_1^i - \sum_{l=2}^n (\beta_1^i \gamma_l^1)_{(-1)} \beta_1^l, \quad 1 < i \leq n, \\ \nu(E_j^i) &= \widetilde{E}_j^i - \beta_1^i \gamma_j^1, \quad 1 < i, j \leq n. \end{aligned} \quad (12.4)$$

In particular, we find that the reduction ν maps $V^{-n+1}(\mathfrak{gl}_n)$ into $V^{-n+2}(\mathfrak{gl}_{n-1}) \otimes D^{\text{ch}}(T^*\mathbb{C}^{n-1}) \otimes \alpha_1$. This enables us to use the induction on n , and end up with getting the following explicit form of a free-field realization of $V^{-n+1}(\mathfrak{gl}_n)$.

Proposition 2. *There exists an embedding of vertex algebras*

$$V^{-n+1}(\mathfrak{gl}_n) \hookrightarrow D^{\text{ch}}(T^*\mathbb{C}^{n(n-1)/2}) \otimes (\mathcal{H}^1)^{\otimes n},$$

such that

$$\begin{aligned} E_j^i &\mapsto \gamma_j^i - \sum_{l=1}^{i-1} \beta_l^i \gamma_j^l, \quad 1 \leq i < j \leq n, \\ E_i^i &\mapsto \sum_{k=i+1}^n \gamma_k^i \beta_i^k - \sum_{l=1}^{i-1} \beta_l^i \gamma_i^l - \alpha_i, \quad 1 \leq i \leq n, \\ E_{i-1}^i &\mapsto \sum_{k=i+1}^n \gamma_k^i \beta_i^k \beta_{i-1}^i - \sum_{k=i}^n \gamma_k^{i-1} \beta_{i-1}^k \beta_{i-1}^i + (\alpha_{i-1} - \alpha_i) \beta_{i-1}^i \\ &\quad + \sum_{k=i+1}^n \gamma_k^i \beta_{i-1}^k - \sum_{l=1}^{i-2} \beta_l^i \gamma_{i-1}^l + (n-i) \partial \beta_{i-1}^i. \end{aligned} \quad (12.5)$$

Here β_i^j, γ_j^i , $1 \leq i < j \leq n$ strongly generates $D^{\text{ch}}(T^*\mathbb{C}^{n(n-1)/2})$ with nontrivial OPEs $\beta_j^i(z) \gamma_l^k(w) \sim \frac{\delta_l^i \delta_j^k}{z-w}$, and $\alpha_1, \dots, \alpha_n$ are n copies of independent level 1 Heisenberg algebras.

If we define

$$E_i := E_{i+1}^i, \quad H_i := E_i^i - E_{i+1}^{i+1}, \quad F_i := E_i^{i+1}, \quad 1 \leq i \leq n-1,$$

and in addition set

$$\begin{aligned} \gamma^{i,j} &:= \beta_i^j, \quad \beta^{i,j} := \gamma_j^i, \quad 1 \leq i < j \leq n, \\ \sqrt{-1} \partial \phi_k &:= \alpha_k, \quad 1 \leq k \leq n, \end{aligned}$$

then (12.5) gives rise to the explicit formula of the Wakimoto realization for $V^{-n+1}(\mathfrak{sl}_n)$ in [56, Proposition 3.2].

The stress-energy operators $T = T_{\beta\gamma} + T_b + T_{bc}$ is BRST closed, where $T_{\beta\gamma}$ and T_{bc} are defined in the same way as in the (5.14), and T_b is defined by

$$T_b := \frac{1}{2} \sum_{i=0}^{n-1} b_i^2 . \quad (12.6)$$

T gives rises to a stress-energy operator of $D^{\text{ch}}(\widetilde{\mathcal{M}}(Q)) \otimes J_B$. We claim that T is inside the vertex subalgebra $V^{-n+1}(\mathfrak{gl}_n)$, in fact T agrees with the Sugawara operator:

$$T = \frac{1}{2} \text{Tr}(E^2) . \quad (12.7)$$

To see this, we compute the image of the both sides of (12.7) under the reduction map ν . Using (12.4), we have

$$\frac{1}{2} \nu(\text{Tr}(E^2)) = \frac{1}{2} \text{Tr}(\widetilde{E}^2) + \frac{1}{2} \partial \text{Tr}(\widetilde{E}) + \frac{1}{2} \alpha_1^2 + \frac{n-1}{2} \partial \alpha_1 - \text{Tr}(\partial \beta_1 \cdot \gamma^1) .$$

Using (11.14), we have

$$\nu(T) = \widetilde{T} + \frac{1}{2} \partial \text{Tr}(\widetilde{E}) + \frac{1}{2} \alpha_1^2 + \frac{n-1}{2} \partial \alpha_1 - \text{Tr}(\partial \beta_1 \cdot \gamma^1) ,$$

where \widetilde{T} is the stress energy operator for $D^{\text{ch}}(\widetilde{\mathcal{M}}(Q')) \otimes J'_B$. When $n = 2$, then it follows from the above computation that $\nu(T - \frac{1}{2} \text{Tr}(E^2)) = 0$. Since ν is injective, we have $T = \frac{1}{2} \text{Tr}(E^2)$ in this case. For general n , we use induction on n and obtain $\nu(T - \frac{1}{2} \text{Tr}(E^2)) = 0$, thus we have $T = \frac{1}{2} \text{Tr}(E^2)$ in general.

12.2 Example: $T_{[1^4]}^{[2^2]}[\text{SU}(4)]$ quiver

Now we turn back to the example of the $T_{[1^4]}^{[2^2]}[\text{SU}(4)]$ quiver introduced in section 9, and apply the quiver reduction with respect to the middle gauge node, see Fig. 24.

According to our reduction algorithm, we have

$$\beta_1 = X_1 I , \quad \beta_2 = I^{-1} X_2 , \quad \gamma_1 = I^{-1} Y_1 , \quad \gamma_2 = Y_2 I , \quad (12.8)$$

and

$$\begin{aligned} h'_1 &= h_1 + Y_1 X_1 - \gamma_1 \beta_1 = h_1 - \text{Tr}(I^{-1} \partial I) , \\ h'_3 &= h_3 - X_2 Y_2 + \beta_2 \gamma_2 = h_3 - \text{Tr}(I^{-1} \partial I) , \\ \alpha &= h_2 + 2 \text{Tr}(I^{-1} \partial I) , \\ \bar{\alpha} &= \alpha + \frac{h'_1 + h'_3}{2} . \end{aligned} \quad (12.9)$$

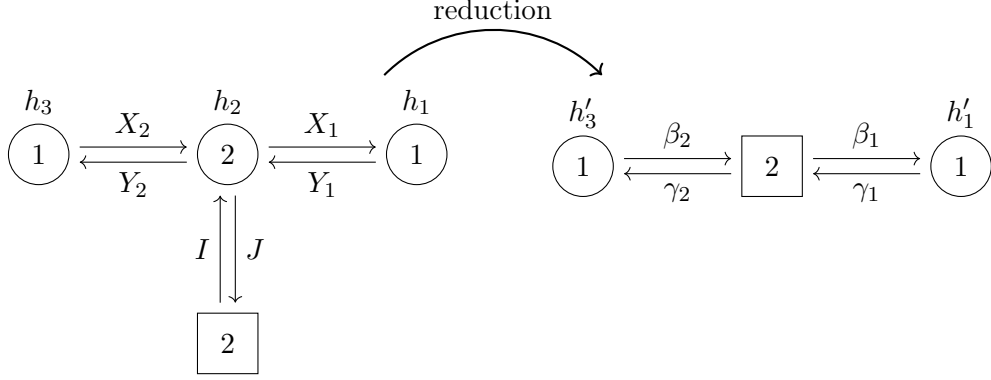

Figure 24: Reduction procedure of the quiver, as applied to the middle node of the $T_{[1^4]}^{[2^2]}[\text{SU}(4)]$ quiver.

After reduction, we get a tensor product of two copies of $T[\text{SU}(2)]$ quiver VOA together with one copy of the Heisenberg field $\bar{\alpha}$ of level 1. We note that there is a vertex subalgebra $V^{-1}(\mathfrak{sl}_2) \otimes V^{-1}(\mathfrak{sl}_2) \subset \mathcal{V}(Q')$ strongly generated by matrix-valued operators

$$J^{[1]} = \gamma_1 \beta_1 + \frac{h'_1}{2} \text{id}, \quad J^{[2]} = -\beta_2 \gamma_2 + \frac{h'_3}{2} \text{id}. \quad (12.10)$$

To match with our setting in the linear quiver VOA, we introduce free bosons b_0, \dots, b_3 such that $b_i(z)b_j(w) \sim \frac{\delta_{ij}}{(z-w)^2}$ and set $h_i = b_i - b_{i-1}$. We note that b_i is related to the free fermions by $b_i = \chi_i \psi_i$. The field $J_B = \sum_{i=0}^3 b_i$ commutes with h_1, h_2, h_3 . Then we can re-arrange the fields $J^{[1]}, J^{[2]}, \bar{\alpha}, J_B$ into the following

$$E^{[1]} = J^{[1]} - \left(\frac{1}{4} J_B + \frac{1}{2} \bar{\alpha} \right) \text{id}, \quad E^{[2]} = J^{[2]} - \left(\frac{1}{4} J_B - \frac{1}{2} \bar{\alpha} \right) \text{id}, \quad (12.11)$$

which strongly generates a vertex subalgebra $V^{-1}(\mathfrak{gl}_2) \otimes V^{-1}(\mathfrak{gl}_2) \subset \mathcal{V}(Q') \otimes \bar{\alpha} \otimes J_B$.

Now consider the following 2×2 matrix-valued operators before reduction:

$$\begin{aligned} G^{(1)} &= JI + \frac{h_1 + 2h_2 + h_3}{2} \text{id}, \\ G^{(2)} &= -(JX_2)_{(-1)}(Y_2I) + \rho G^{(1)} - (\rho^2 + \partial\rho) \cdot \text{id}, \end{aligned} \quad (12.12)$$

where $\rho = \frac{3h_3 + 2h_2 + h_1}{4}$. We note that $G^{(1)}, G^{(2)}$ are BRST closed. Let us compute their images after reduction:

$$\nu(G^{(1)}) = -\beta_2 \gamma_2 + \gamma_1 \beta_1 + \frac{h'_1 + h'_3}{2} \text{id} = J^{[1]} + J^{[2]},$$

and

$$\nu(G^{(2)}) = ((\beta_2 \gamma_2 - \gamma_1 \beta_1)_{(-1)} \beta_2)_{(-1)} \gamma_2 + (\alpha \beta_2)_{(-1)} \gamma_2 + \nu(\rho) \nu(G^{(1)}) - (\nu(\rho)^2 + \partial \nu(\rho)) \cdot \text{id},$$

where $\nu(\rho) = \frac{3h'_3 + 2\alpha + h'_4}{4}$. We can expand the first two terms in the above expression of $\nu(G^{(2)})$ as follows:

$$\begin{aligned}
& ((\beta_2\gamma_2 - \gamma_1\beta_1)_{(-1)}\beta_2)_{(-1)}\gamma_2 + (\alpha\beta_2)_{(-1)}\gamma_2 \\
&= -\gamma_1\beta_1\beta_2\gamma_2 - \partial(\gamma_1\beta_1) + \alpha\beta_2\gamma_2 + \partial\alpha \cdot \text{id} + ((\beta_2\gamma_2)_{(-1)}\beta_2)_{(-1)}\gamma_2 \\
&= -\gamma_1\beta_1\beta_2\gamma_2 - \partial(\gamma_1\beta_1) + \alpha\beta_2\gamma_2 + \partial\alpha \cdot \text{id} + (\gamma_2\beta_2)_{(-1)}(\beta_2\gamma_2) + \partial(\gamma_2\beta_2) \cdot \text{id} \\
&= -\gamma_1\beta_1\beta_2\gamma_2 - \partial(\gamma_1\beta_1) + (h'_3 + \alpha)\beta_2\gamma_2 + \partial(h'_3 + \alpha) \cdot \text{id} ,
\end{aligned}$$

where in the last line we have imposed the moment map relation $\gamma_2\beta_2 \equiv h'_3$. Plug the above expression back to $\nu(G^{(2)})$ and we get

$$\begin{aligned}
\nu(G^{(2)}) &= -\gamma_1\beta_1\beta_2\gamma_2 - \partial(\gamma_1\beta_1) + (h'_3 + \alpha)\beta_2\gamma_2 + \nu(\rho)\nu(G^{(1)}) \\
&\quad - (\nu(\rho)^2 + \partial(\nu(\rho) - h'_3 - \alpha)) \cdot \text{id} \\
&= \left(J^{[1]} - \frac{\bar{\alpha}}{2}\text{id}\right) \left(J^{[2]} + \frac{\bar{\alpha}}{2}\text{id}\right) - \partial \left(J^{[1]} - \frac{\bar{\alpha}}{2}\text{id}\right) .
\end{aligned}$$

Let us re-organize the fields $G^{(1)}, G^{(2)}, J_B$ in the following way:

$$\begin{aligned}
W^{(1)} &= G^{(1)} - \frac{J_B}{2}\text{id} , \\
W^{(2)} &= G^{(2)} - \frac{1}{4}J_B G^{(1)} + \left(\frac{J_B^2}{16} + \frac{\partial J_B}{4}\right) \cdot \text{id} ,
\end{aligned} \tag{12.13}$$

then we get

$$\nu(W^{(1)}) = E^{[1]} + E^{[2]} , \quad \nu(W^{(2)}) = E^{[1]}E^{[2]} - \partial E^{[1]} . \tag{12.14}$$

The equation (12.14) can be equivalently presented as the matrix-valued Miura operator:

$$\partial_z^2 + \partial_z \cdot \nu(W^{(1)}) + \nu(W^{(2)}) = (\partial_z + E^{[1]})(\partial_z + E^{[2]}) . \tag{12.15}$$

Therefore according to [57], $\nu(W^{(1)}), \nu(W^{(2)})$ strongly generate the rectangular \mathcal{W} -algebra $\mathcal{W}^{-3}(\mathfrak{gl}_4, [2^2])$ as a vertex subalgebra of $V^{-1}(\mathfrak{gl}_2) \otimes V^{-1}(\mathfrak{gl}_2)$.

We note that the $T_{[1^4]}^{[2^2]}[\text{SU}(4)]$ quiver satisfies the technical assumption in Theorem 10.2, then it follows from the theorem that the map $\iota : \mathcal{V}(Q) \rightarrow \text{D}^{\text{ch}}(\widetilde{\mathcal{M}}(Q))$ is injective, whence $W^{(1)}, W^{(2)}$ strongly generate the rectangular \mathcal{W} -algebra $\mathcal{W}^{-3}(\mathfrak{gl}_4, [2^2])$ as a vertex subalgebra of $\mathcal{V}(Q) \otimes J_B$. We also note that $\iota' : \mathcal{V}(Q') \rightarrow \text{D}^{\text{ch}}(\widetilde{\mathcal{M}}(Q'))$ is injective because the $T[\text{SU}(2)]$ quiver also satisfies the technical assumption in Theorem 10.2. We summarize our conclusion in the following commutative diagram

$$\begin{array}{ccc}
\mathcal{W}^{-3}(\mathfrak{gl}_4, [2^2]) & \xleftarrow{\text{Miura map}} & V^{-1}(\mathfrak{gl}_2) \otimes V^{-1}(\mathfrak{gl}_2) \\
\downarrow & & \downarrow \\
\mathcal{V}(Q) \otimes J_B & \xleftarrow{\text{reduction}} & \mathcal{V}(Q') \otimes \bar{\alpha} \otimes J_B \\
\downarrow \iota & & \downarrow \iota' \\
\text{D}^{\text{ch}}(\widetilde{\mathcal{M}}(Q)) \otimes J_B & \xleftarrow{\text{reduction}} & \text{D}^{\text{ch}}(\widetilde{\mathcal{M}}(Q')) \otimes \bar{\alpha} \otimes J_B
\end{array} \tag{12.16}$$

where all arrows are embeddings of vertex algebras.

The stress-energy operators $T = T_{\beta\gamma} + T_h + T_{\text{bc}} + T_{J_B}$ is BRST closed, where $T_{\beta\gamma}$, T_h , and T_{bc} are defined in the same way as in the (5.14), and $T_{J_B} = \frac{1}{8}J_B^2$. T gives rise to a stress-energy operator of $\mathcal{V}(Q) \otimes J_B$. We claim that T is inside the vertex subalgebra $\mathcal{W}^{-3}(\mathfrak{gl}_4, [2^2])$, and it can be written in terms of $W^{(1)}, W^{(2)}$ as

$$T = \frac{1}{2}\text{Tr}((W^{(1)})^2) - \text{Tr}(W^{(2)}) - \frac{1}{2}\text{Tr}(\partial W^{(1)}) . \quad (12.17)$$

To see this, we compute the image of T under the reduction map ν . By (11.14) we have

$$\begin{aligned} \nu(T) &= T_{Q'} + \frac{1}{2}\partial\text{Tr}(\gamma_1\beta_1) - \frac{1}{2}\partial\text{Tr}(\beta_2\gamma_2) - \partial\alpha + \frac{1}{8}J_B^2 + \frac{1}{2}\bar{\alpha}^2 \\ &= T_{Q'} - \partial\bar{\alpha} + \frac{1}{8}J_B^2 + \frac{1}{2}\bar{\alpha}^2 , \end{aligned}$$

where $T_{Q'}$ is the stress energy operator (5.14) for the quiver Q' . Using (12.7) and the injectivity of $\nu' : \mathcal{V}(Q') \rightarrow \text{D}^{\text{ch}}(\widetilde{\mathcal{M}}(Q'))$, we see that $T_{Q'}$ equals to the Sugawara operator of $V^{-1}(\mathfrak{sl}_2) \otimes V^{-1}(\mathfrak{sl}_2)$, i.e.

$$T_{Q'} = \frac{1}{2}\text{Tr}((J^{[1]})^2) + \frac{1}{2}\text{Tr}((J^{[2]})^2) .$$

Thus we find

$$\begin{aligned} \nu(T) &= \frac{1}{2}\text{Tr}((E^{[1]})^2) + \frac{1}{2}\text{Tr}((E^{[2]})^2) + \frac{1}{2}\text{Tr}(\partial E^{[1]}) - \frac{1}{2}\text{Tr}(\partial E^{[2]}) \\ &= \nu\left(\frac{1}{2}\text{Tr}((W^{(1)})^2) - \text{Tr}(W^{(2)}) - \frac{1}{2}\text{Tr}(\partial W^{(1)})\right) . \end{aligned}$$

By the injectivity of ν , we obtain (12.17). We make two remarks:

1. T in (12.17) is exactly the stress-energy operator of $\mathcal{W}^{-3}(\mathfrak{gl}_4, [2^2])$ in [58, (3.19)];
2. T equals to $T_{\text{KRW}} + \frac{1}{8}J_B^2$ where T_{KRW} is Kac-Roan-Wakimoto's stress-energy operator of $\mathcal{W}^{-3}(\mathfrak{sl}_4, [2^2])$ in [43, (2.5)], because T is the unique stress-energy operator of $\mathcal{W}^{-3}(\mathfrak{gl}_4, [2^2])$ such that $W^{(1)}$ is primary of weight 1 and $W^{(2)}$ has conformal weight 2 with respect to T [58, Section 3.4], and $T_{\text{KRW}} + \frac{1}{8}J_B^2$ also satisfies these properties.

We make a final remark that if we perform the following automorphism on $\mathcal{V}(Q) \otimes J_B$:

$$(X_b^a, Y_d^c) \mapsto (Y_a^b, -X_c^d) , \quad (I_i^a, J_b^j) \mapsto (J_a^i, -I_j^b) , \quad h_i \mapsto -h_i , \quad J_B \mapsto -J_B ,$$

then $W^{(1)}$ and $W^{(2)}$ transforms accordingly:

$$(W^{(1)})_j^i \mapsto -(W^{(1)})_i^j , \quad (W^{(2)})_j^i \mapsto (W^{(2)})_i^j - (\partial W^{(1)})_i^j .$$

The above automorphism on the rectangular \mathcal{W} -algebra $\mathcal{W}^{-3}(\mathfrak{gl}_4, [2^2])$ is equivalent to the one induced from the automorphism of Miura operators

$$(\partial_z + E^{[1]})_l^i (\partial_z + E^{[2]})_j^l \mapsto (\partial_z - E^{[2]})_i^l (\partial_z - E^{[1]})_l^j .$$

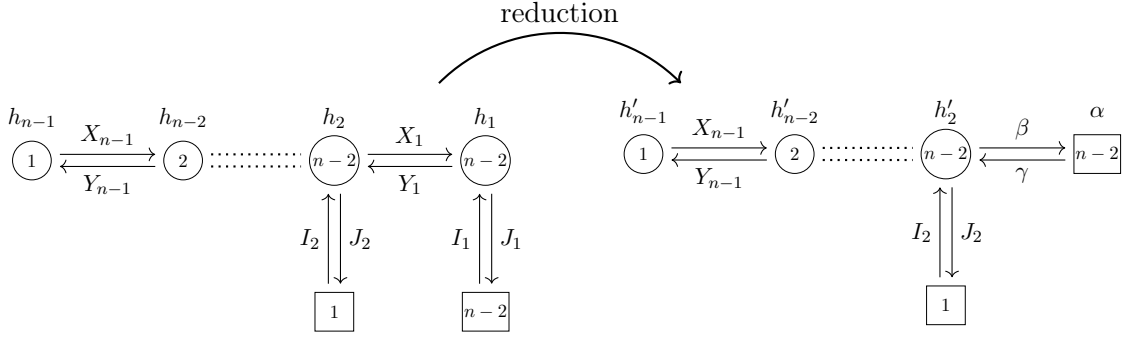

Figure 25: Reduction procedure of the quiver, as applied to the second node of the $T_{[1^n]}^{[2,1^{n-2}]}[\text{SU}(n)]$ quiver.

12.3 Example: $T_{[1^n]}^{[2,1^{n-2}]}[\text{SU}(n)]$ quiver

In this subsection we apply the quiver reduction to the rightmost node of the $T_{[1^n]}^{[2,1^{n-2}]}[\text{SU}(n)]$ quiver introduced in section 8, see the Fig. 25.

According to our reduction algorithm, we have

$$\beta = I^{-1}X_1, \quad \gamma = \bar{Y}_1 I, \quad (12.18)$$

and

$$\alpha = h_1 + 2\text{Tr}(I^{-1}\partial I), \quad h'_2 = h_2 + \frac{h_1 - \alpha}{2} = h_2 - \text{Tr}(I^{-1}\partial I), \quad h'_j = h_j, \quad j > 2. \quad (12.19)$$

The modified Heisenberg field (11.38) reads:

$$\bar{\alpha} = \alpha + \sum_{j=1}^{n-2} \frac{j h'_{n-j}}{n-1}. \quad (12.20)$$

After reduction, we get a tensor product of $T[\text{SU}(n-1)]$ quiver VOA together with one copy of Heisenberg field $\bar{\alpha}$ of level $\frac{n}{n-1}$. We note that there is a vertex subalgebra $V^{-n+2}(\mathfrak{sl}_{n-1}) \subset \mathcal{V}(Q')$ strongly generated by operators

$$J_j^i = \begin{cases} -(\beta\gamma)_j^i + \sum_{\ell=1}^{n-2} \frac{\ell h'_{n-\ell}}{n-1} \delta_j^i, & 1 \leq i, j \leq n-2, \\ -(J_2\gamma)_j, & i = n-1, 1 \leq j \leq n-2, \\ (\beta I_2)^i, & 1 \leq i \leq n-2, j = n-1, \\ J_2 I_2 + \sum_{\ell=1}^{n-2} \frac{\ell h'_{n-\ell}}{n-1}, & i = j = n-1. \end{cases} \quad (12.21)$$

To match with our setting in the linear quiver VOA, we introduce free bosons b_0, \dots, b_{n-1} such that $b_i(z)b_j(w) \sim \frac{\delta_{ij}}{(z-w)^2}$ and set $h_i = b_i - b_{i-1}$. We note that b_i is related to the free fermions by $b_i = \chi_i \psi_i$. The field $J_B = \sum_{i=0}^{n-1} b_i$ commutes with h_1, \dots, h_{n-1} . We re-arrange the fields $J_j^i, \bar{\alpha}, J_B$ into the following

$$E_j^i = J_j^i - \frac{\bar{\alpha} + J_B}{n} \delta_j^i, \quad \tilde{\alpha} = \frac{n-1}{n} \bar{\alpha} - \frac{1}{n} J_B, \quad (12.22)$$

then E commutes with $\tilde{\alpha}$ and they generate a vertex subalgebra $V^{-n+2}(\mathfrak{gl}_{n-1}) \otimes \mathcal{H}^1 \subset \mathcal{V}(Q') \otimes \bar{\alpha} \otimes J_B$.

Now consider the following operators before reduction:

$$\begin{aligned}
(G^{(1,1)})_j^i &= -(J_1 I_1)_j^i + b_0 \delta_j^i, \\
(G^{(1,2)})^i &= -(J_1 X_1 I_2)^i, \\
(G^{(2,1)})_i &= (J_2 Y_1 I_1)_i, \\
G_1^{(2,2)} &= J_B - \text{Tr}(G^{(1,1)}), \\
G_2^{(2,2)} &= g^{(2,2)} - S + \frac{b_0 + b_1}{4}(b_0 + b_1 - 2J_2 I_2) - (n-2)\text{Tr}(I_2 \partial J_2),
\end{aligned} \tag{12.23}$$

where $1 \leq i, j \leq n-2$. $g^{(2,2)}$ and S are the following fields:

$$\begin{aligned}
g^{(2,2)} &:= (I_2 J_2)_b^a \left((Y_1 X_1)_a^b + \frac{h_1}{2} \delta_b^a \right), \\
S &:= \text{Tr}(X_1 \partial Y_1) - \text{Tr}(J_1 \partial I_1) + \frac{h_1^2}{4} - \text{Tr}(\mathbf{b}_1 \partial \mathbf{c}_1),
\end{aligned} \tag{12.24}$$

where $\mathbf{b}_1, \mathbf{c}_1$ are the bc ghosts of the rightmost node. We note that S is a stress-energy operator corresponding to the neighboring fields of the rightmost gauge node. It is easy to see that $G^{(1,1)}$, $G^{(1,2)}$, $G^{(2,1)}$, and $G_1^{(2,2)}$ are BRST closed. It is true, but not obvious, that $G_2^{(2,2)}$ is also BRST closed. Nevertheless, it is easy to see that $G_2^{(2,2)}$ is BRST closed with respect to the rightmost gauge node. We will show that $G_2^{(2,2)}$ is also BRST closed with respect to all gauge nodes using the quiver reduction.

Let us compute their images after reduction.

$$\begin{aligned}
\nu((G^{(1,1)})_j^i) &= -\nu \left((J_1 I_1)_j^i + \sum_{\ell=1}^{n-1} \frac{\ell h_{n-\ell}}{n} \delta_j^i \right) + \frac{J_B}{n} \delta_j^i \\
&= (\beta \gamma)_j^i - \left(\sum_{\ell=1}^{n-2} \frac{\ell h'_{n-\ell}}{n} - \frac{\alpha + J_B}{n} \right) \delta_j^i \\
&= -E_j^i. \\
\nu((G^{(2,1)})_i) &= (J_2 \gamma)_i = -E_i^{n-1}, \\
\nu((G^{(1,2)})^i) &= (\beta \gamma)_{j,(-1)}^i (\beta I_2)^j + \alpha (\beta I_2)^i = \tilde{\alpha} E_{n-1}^i - \sum_{\ell=1}^{n-2} E_{\ell,(-1)}^i E_{n-1}^\ell. \\
\nu(G_1^{(2,2)}) &= J_B + \sum_{i=1}^{n-2} E_i^i = -E_{n-1}^{n-1} - \tilde{\alpha}.
\end{aligned} \tag{12.25}$$

The hard one is $\nu(G_2^{(2,2)})$, and let us compute $\nu(g^{(2,2)})$ first:

$$\begin{aligned}
\nu(g^{(2,2)}) &= (I_2 J_2)_b^a \left((\gamma\beta)_a^b + \frac{\alpha}{2} \delta_b^a \right) = J_2 \gamma \beta I_2 + \frac{\alpha}{2} J_2 I_2 \\
&= (J_2 \gamma)_{i,(-1)} (\beta I_2)^i + \frac{\alpha}{2} J_2 I_2 + (n-2) \text{Tr}(I_2 \partial J_2) + \text{Tr}(\beta \partial \gamma) \\
&= - \sum_{\ell=1}^{n-2} E_{\ell,(-1)}^{n-1} E_{n-1}^\ell + \left(\tilde{\alpha} + \frac{b_0 + b_1}{2} \right) J_2 I_2 + (n-2) \text{Tr}(I_2 \partial J_2) + \text{Tr}(\beta \partial \gamma) \\
&= \tilde{\alpha} E_{n-1}^{n-1} - \sum_{\ell=1}^{n-2} E_{\ell,(-1)}^{n-1} E_{n-1}^\ell + \frac{\alpha^2}{4} + \text{Tr}(\beta \partial \gamma) \\
&\quad + \frac{b_0 + b_1}{2} I_2 J_2 + (n-2) \text{Tr}(I_2 \partial J_2) - \frac{(b_0 + b_1)^2}{4}.
\end{aligned}$$

According to (11.14), we have

$$\nu(S) = \frac{\alpha^2}{4} + \text{Tr}(\beta \partial \gamma).$$

Together we get

$$\nu(G_2^{(2,2)}) = \tilde{\alpha} E_{n-1}^{n-1} - \sum_{\ell=1}^{n-2} E_{\ell,(-1)}^{n-1} E_{n-1}^\ell. \quad (12.26)$$

In particular, we see that $\nu(G_2^{(2,2)})$ is BRST closed. This implies that $G_2^{(2,2)}$ becomes BRST closed after localizing $\det(I_1)$. Since localization induces an injective map between relative BRST complexes, hence $G_2^{(2,2)}$ is BRST closed.

According to [50, Appendix A], the BRST cohomology classes $\nu(G^{(1,1)})$, $\nu(G^{(1,2)})$, $\nu(G^{(2,1)})$, $\nu(G_1^{(2,2)})$, $\nu(G_2^{(2,2)})$ strongly generate a vertex subalgebra

$$\mathcal{W}^{-n+1}(\mathfrak{gl}_n, f_{\min}) \subset V^{-n+2}(\mathfrak{gl}_{n-1}) \otimes \mathcal{H}^1 \subset \mathcal{V}(Q') \otimes \bar{\alpha} \otimes J_B.$$

The map is given by

$$\begin{aligned}
\nu((G^{(1,1)})_j^i) &\mapsto W_{j,i}^{(1)}, & \nu((G^{(2,1)})_j) &\mapsto W_{j,n-1}^{(1)}, & \nu(G_1^{(2,2)}) &\mapsto W_{n-1,n-1}^{(1)}, \\
\nu((G^{(1,2)})^i) &\mapsto W_{n-1,i}^{(2)}, & \nu(G_2^{(2,2)}) &\mapsto W_{n-1,n-1}^{(2)}.
\end{aligned} \quad (12.27)$$

Since the quiver reduction map (11.27) for the vertex algebra of the global section is injective, we see that the BRST cohomology classes $G^{(1,1)}$, $G^{(1,2)}$, $G^{(2,1)}$, $G_1^{(2,2)}$, $G_2^{(2,2)}$ strongly generate a vertex subalgebra in $D^{\text{ch}}(\widetilde{\mathcal{M}}(Q)) \otimes J_B$ which is isomorphic to $\mathcal{W}^{-n+1}(\mathfrak{gl}_n, f_{\min})$. We summarize it in the following commutative diagram:

$$\begin{array}{ccc}
\mathcal{W}^{-n+1}(\mathfrak{gl}_n, f_{\min}) & \xrightarrow{\text{Miura map}} & V^{-n+2}(\mathfrak{gl}_{n-1}) \otimes \mathcal{H}^1 \\
\downarrow & & \downarrow \\
D^{\text{ch}}(\widetilde{\mathcal{M}}(Q)) \otimes J_B & \xrightarrow{\text{reduction}} & D^{\text{ch}}(\widetilde{\mathcal{M}}(Q')) \otimes \bar{\alpha} \otimes J_B
\end{array} \quad (12.28)$$

We also note that the $T_{[1^4]}^{[2,1^2]}[\mathrm{SU}(4)]$ quiver satisfies the technical assumption in the Theorem 10.2, then it follows from the theorem that the map $\iota : \mathcal{V}(Q) \rightarrow \mathrm{D}^{\mathrm{ch}}(\widetilde{\mathcal{M}}(Q))$ is injective, whence $W^{(1)}, W^{(2)}$ strongly generate the minimal nilpotent \mathcal{W} -algebra $\mathcal{W}^{-3}(\mathfrak{gl}_4, [2, 1^2])$ as a vertex subalgebra of $\mathcal{V}(Q) \otimes J_B$. Thus we also have the commutative diagram

$$\begin{array}{ccc} \mathcal{W}^{-3}(\mathfrak{gl}_4, [2, 1^2]) & \xleftarrow{\text{Miura map}} & V^{-2}(\mathfrak{gl}_3) \otimes \mathcal{H}^1 \\ \downarrow & & \downarrow \\ \mathcal{V}(Q) \otimes J_B & \xleftarrow{\text{reduction}} & \mathcal{V}(Q') \otimes \bar{\alpha} \otimes J_B \end{array} \quad (12.29)$$

The stress-energy operator $T = T_{\beta\gamma} + T_h + T_{\mathrm{bc}} + T_{J_B}$ is BRST closed, where $T_{\beta\gamma}, T_h$, and T_{bc} are defined in the same way as in the (5.14), and $T_{J_B} = \frac{1}{2n}J_B^2$. T gives rise to a stress-energy operator of $\mathrm{D}^{\mathrm{ch}}(\widetilde{\mathcal{M}}(Q)) \otimes J_B$. We claim that T is inside the vertex subalgebra $\mathcal{W}^{-n+1}(\mathfrak{gl}_n, f_{\min})$, and it can be written in terms of $W^{(1)}, W^{(2)}$ as

$$T = -W_{n-1, n-1}^{(2)} + \frac{1}{2}(W_{n-1, n-1}^{(1)})^2 + \frac{n-2}{2}\partial W_{n-1, n-1}^{(1)} + \frac{1}{2}\sum_{i,j=1}^{n-2} W_{i,j}^{(1)}W_{j,i}^{(1)}. \quad (12.30)$$

To see this, we compute the image of T under the reduction map ν . By (11.14) we have

$$\nu(T) = T_{Q'} - \frac{1}{2}\partial\mathrm{Tr}(\beta\gamma) - \frac{n-2}{2}\partial\alpha + \frac{1}{2(n-1)}(J_B + \tilde{\alpha})^2 + \frac{1}{2}\tilde{\alpha}^2,$$

where $T_{Q'}$ is the stress energy operator (5.14) for the quiver Q' . Using (12.7), we have

$$\begin{aligned} \nu(T) &= \frac{1}{2}\sum_{i,j=1}^{n-1} E_j^i E_i^j + \frac{1}{2}\sum_{i=1}^{n-2} \partial E_i^i - \frac{n-2}{2}\partial\tilde{\alpha} + \frac{1}{2}\tilde{\alpha}^2 \\ &= -W_{n-1, n-1}^{(2)} + \frac{1}{2}(W_{n-1, n-1}^{(1)})^2 + \frac{n-2}{2}\partial W_{n-1, n-1}^{(1)} + \frac{1}{2}\sum_{i,j=1}^{n-2} W_{i,j}^{(1)}W_{j,i}^{(1)}. \end{aligned}$$

Therefore the claim is proven. We note that T agrees with $T_{\mathrm{KRW}} + \frac{1}{2n}J_B^2$, where T_{KRW} is Kac-Roan-Wakimoto's stress-energy operator of $\mathcal{W}^{-n+1}(\mathfrak{sl}_n, f_{\min})$ in [43, (2.5)], because there is a unique¹⁸ stress-energy operator of $\mathcal{W}^{-n+1}(\mathfrak{gl}_n, f_{\min})$ such that $W_{i,j}^{(1)}$ for $1 \leq i, j \leq n-2$ and $W_{n-1, n-1}^{(1)}$ are primary of weight 1, and $W_{i, n-1}^{(1)}$ and $W_{n-1, i}^{(2)}$ for $1 \leq i \leq n-2$ are primary of weight 3/2, with respect to such stress-energy operator. Both T and $T_{\mathrm{KRW}} + \frac{1}{2n}J_B^2$ satisfy such properties, thus

$$T = T_{\mathrm{KRW}} + \frac{1}{2n}J_B^2. \quad (12.31)$$

¹⁸Uniqueness follows from the fact that $W^{(1)}$ and $W_{n-1, i}^{(2)}$ for $1 \leq i \leq n-2$ generate the whole $\mathcal{W}^{-n+1}(\mathfrak{gl}_n, f_{\min})$, cf. (8.8). In fact, if T_1 and T_2 are two stress-energy operators such that $W^{(1)}$ and $W_{n-1, i}^{(2)}$ for $1 \leq i \leq n-2$ are primary and their weights under the T_1 and T_2 are equal, then $T_1 - T_2$ commutes with $W^{(1)}$ and $W_{n-1, i}^{(2)}$ for $1 \leq i \leq n-2$, whence it commutes with $\mathcal{W}^{-n+1}(\mathfrak{gl}_n, f_{\min})$. According to Lemma E.1, we must have $T_1 = T_2$.

In section 9.2, we mentioned that $T_{[1^4]}^{[2,2]}[\text{SU}(4)]$ can be obtained from the quiver reduction of $T_{[1^4]}^{[2,1,1]}[\text{SU}(4)]$. As in Fig. 26, one can notice $T_{[1^4]}^{[2,1,1]}[\text{SU}(4)]$ after the quiver reduction provides a slightly different outcome compared to the quiver reduction of $T_{[1^4]}^{[2,2]}[\text{SU}(4)]$. More precisely, $V^{-1}(\mathfrak{gl}_2) \otimes D^{\text{ch}}(T^*\mathbb{C}^2) \otimes (\mathcal{H}^1)^{\otimes 2}$ and $V^{-1}(\mathfrak{gl}_2) \otimes V^{-1}(\mathfrak{gl}_2)$, and the former contains the latter. Further application of Miura map, following Proposition 2, yield $D^{\text{ch}}(T^*\mathbb{C}^3) \otimes (\mathcal{H}^1)^{\otimes 4}$ and $D^{\text{ch}}(T^*\mathbb{C}^2) \otimes (\mathcal{H}^1)^{\otimes 4}$. The gauging of $\text{U}(1)$ reduces the complex dimension of the associated super vector space $D^{\text{ch}}(T^*\mathbb{C}^3) \rightarrow D^{\text{ch}}(T^*\mathbb{C}^2)$.

We make a final remark that our choice of generators (12.23) is related to the previous ones in (8.14) by the automorphism $(X_b^a, Y_c^d) \mapsto (Y_a^b, -X_c^d)$, $(I_i^a, J_j^b) \mapsto (J_a^i, -I_b^j)$.

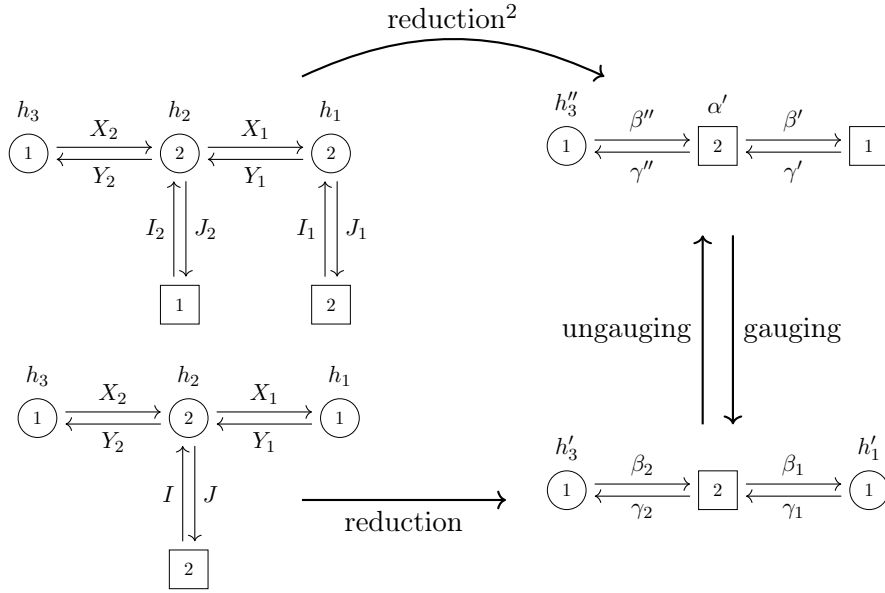

Figure 26: Subtle difference of quiver reduction of $T_{[1^4]}^{[2,1^2]}[\text{SU}(4)]$ quiver and $T_{[1^4]}^{[2,2]}[\text{SU}(4)]$ quiver.

12.4 Example: $T_{[1^n]}^{[n-1,1]}[\text{SU}(n)]$ quiver

In this subsection we recap the $T_{[1^n]}^{[n-1,1]}[\text{SU}(n)]$ quiver which was previously studied by Kuwabara [53]. According to the result in [53, 10.1], $D^{\text{ch}}(\widetilde{\mathcal{M}}(Q)) \otimes J_B$ contains a vertex subalgebra which is isomorphic to $\mathcal{W}^{-n+1}(\mathfrak{gl}_n, f_{\text{sub}})$ and is generated by

$$E = J_{n-1}X_{n-2} \cdots X_1 I_1, \quad F = J_1 Y_1 \cdots Y_{n-2} I_{n-1}, \quad J_B = \sum_{i=0}^{n-1} b_i, \quad \mathring{H} = J_1 I_1 - b_0. \quad (12.32)$$

Here f_{sub} denotes a sub-regular nilpotent element in \mathfrak{gl}_n . We note that the $T_{[1^n]}^{[n-1,1]}[\text{SU}(n)]$ quiver satisfies the technical assumption in the Theorem 10.2, then it follows from the

theorem that the map $\iota : \mathcal{V}(Q) \rightarrow \text{D}^{\text{ch}}(\widetilde{\mathcal{M}}(Q))$ is injective. Since the strong generators (12.32) are inside the image of ι , so we see that $\mathcal{W}^{-n+1}(\mathfrak{gl}_n, f_{\text{sub}})$ is a vertex subalgebra of $\mathcal{V}(Q) \otimes J_B$.

Let us re-derive Kuwabara's result using the quiver reduction. The quiver reduction at the first node induces an injective vertex algebra map

$$\nu : \mathcal{V}(Q) \otimes J_B \hookrightarrow \mathcal{V}(Q') \otimes J'_B \otimes b'_0,$$

where

$$J'_B = \sum_{i=1}^{n-1} b'_i, \quad b'_j = \begin{cases} b_0 - I_1^{-1} \partial I_1, & j = 0 \\ b_1 + I_1^{-1} \partial I_1, & j = 1 \\ b_j, & j > 1 \end{cases}. \quad (12.33)$$

After reduction, we write down the analog of operators E, F, \mathring{H} in $\mathcal{V}(Q') \otimes J'_B$:

$$E' = J'_{n-1} X'_{n-2} \cdots X'_2 I'_2, \quad F' = J'_2 Y'_2 \cdots Y'_{n-2} I'_{n-1}, \quad \mathring{H}' = J'_2 I'_2 - b'_1.$$

The quiver reduction algorithm gives

$$\nu(E) = E', \quad \nu(F) = \mathring{H}' F' + b'_0 F', \quad \nu(\mathring{H}) = \mathring{H}', \quad \nu(J_B) = J'_B + b'_0. \quad (12.34)$$

Comparing with [59, 7.3], we claim that the following map

$$E_{\text{there}} = E_{\text{here}}, \quad F_{\text{there}} = F_{\text{here}}, \quad Z = J_B, \quad H = \mathring{H} - \frac{1}{n} J_B, \quad (12.35)$$

gives rise to an isomorphism between the vertex subalgebra generated by (12.32) and $\mathcal{W}^{-n+1}(\mathfrak{gl}_n, f_{\text{sub}})$. When $n = 2$, the map ν gives the Wakimoto realization of $V^{-1}(\mathfrak{gl}_2)$, in this case the sub-regular nilpotent element is zero, so we get $V^{-1}(\mathfrak{gl}_2) = \mathcal{W}^{-1}(\mathfrak{gl}_2, f_{\text{sub}})$, and (12.35) gives the isomorphism. When $n > 2$, we use the induction on n , and notice that (12.34) agrees with the formula [59, (7.4)-(7.7)] of the parabolic induction map

$$\Delta : \mathcal{W}^{-n+1}(\mathfrak{gl}_n, f_{\text{sub}}) \hookrightarrow \mathcal{W}^{-n+2}(\mathfrak{gl}_{n-1}, f_{\text{sub}}) \otimes \mathcal{H}^1,$$

by taking $N_1 = n - 1$, $N_2 = 1$, and identifying $W_1 = b'_0$. This proves our claim. The above argument also shows that the quiver reduction map is compatible with parabolic induction, i.e. the following diagram commutes:

$$\begin{array}{ccc} \mathcal{W}^{-n+1}(\mathfrak{gl}_n, f_{\text{sub}}) & \xleftarrow{\Delta} & \mathcal{W}^{-n+2}(\mathfrak{gl}_{n-1}, f_{\text{sub}}) \otimes \mathcal{H}^1 \\ \downarrow & & \downarrow \\ \mathcal{V}(Q) \otimes J_B & \xleftarrow{\text{reduction}} & \mathcal{V}(Q') \otimes J'_B \otimes b'_0 \end{array} \quad (12.36)$$

$T = T_{\beta\gamma} + T_h + T_{\text{bc}} + T_{J_B}$ is BRST closed, where $T_{\beta\gamma}$, T_h , and T_{bc} are defined in the same way as in the (5.14), and $T_{J_B} = \frac{1}{2n} J_B^2$.

It is shown in [60, Theorem 6.9] that when $k + n \neq 0$, $\mathcal{W}^k(\mathfrak{sl}_n, f_{\text{sub}})$ is isomorphic to Feigin-Semikhatov's $\mathcal{W}_n^{(2)}$ algebra of level k , which is defined in [61]. Note that in our setting, $\mathcal{W}^{-n+1}(\mathfrak{sl}_n, f_{\text{sub}})$ is generated by E , F , and $H = \mathring{H} - \frac{1}{n}J_B$. It is shown in [61] that when $k + n \neq 0$, $\mathcal{W}_n^{(2)}$ has a stress-energy operators T_{FS} such that E , F , and H are primary of weights $n/2$, $n/2$, and 1, with respect to T_{FS} . In fact, T_{FS} is the unique stress-energy operator which has such property¹⁹. Similarly $T_{\text{FS}} + \frac{1}{2n}J_B^2$ is the unique stress-energy operator of $\mathcal{W}^{-n+1}(\mathfrak{sl}_n, f_{\text{sub}})$ such that E , F , Z and \mathring{H} are primary of weights $n/2$, $n/2$, 1 and 1 with respect to it. It is easy to see that T also satisfy the aforementioned properties, thus we have

$$T = T_{\text{FS}} + \frac{1}{2n}J_B^2. \quad (12.37)$$

Lemma 12.1. *For all k such that $k + n \neq 0$, Kac-Roan-Wakimoto's stress-energy operator T_{KRW} of $\mathcal{W}^k(\mathfrak{sl}_n, f_{\text{sub}})$ in [43, (2.5)] is identified with Feigin-Semikhatov's stress-energy operator T_{FS} along the isomorphism $\mathcal{W}^k(\mathfrak{sl}_n, f_{\text{sub}}) \cong \mathcal{W}_n^{(2)}$ in [60, Theorem 6.9].*

Proof. When $n = 2$ this is obvious because both T_{KRW} and T_{FS} are equal to the Sugawara operator in $V^k(\mathfrak{sl}_2)$. So let us assume $n \geq 3$. We recall that the grading induced by T_{KRW} on $\mathcal{W}^k(\mathfrak{sl}_n, f_{\text{sub}})$ is the one induced from the grading of x from an \mathfrak{sl}_2 triple (e, x, f_{sub}) . Namely, let us choose

$$f_{\text{sub}} = e_2^3 + \cdots + e_{n-1}^n, \quad x = \frac{n-2}{2}e_2 + \frac{n-4}{2}e_3 + \cdots + \frac{-n+2}{2}e_n,$$

where e_j^i is the ij -elementary matrix, then we get decomposition $\mathfrak{sl}_n = \bigoplus_{j \in \frac{1}{2}\mathbb{Z}} \mathfrak{g}_j$ where \mathfrak{g}_j is the subspace of \mathfrak{sl}_n such that $\text{ad}(x)$ acts with eigenvalue j . T_{KRW} is constructed such that the field $a(z)$ for $a \in \mathfrak{g}_j$ has conformal weight $1 - j$, cf. the remark after [44, (2.3)]. Now according to [59, 7.3], we have

$$E(z) = e_2^1(z), \quad F(z) =: (\hat{\partial} + (e_1^1 - e_n^n)(z))(\hat{\partial} + (e_1^1 - e_{n-1}^{n-1})(z)) \cdots (\hat{\partial} + (e_1^1 - e_3^3)(z))e_1^2(z) :$$

where $\hat{\partial} = (k + n - 1)\partial_z$. Under the conformal grading of T_{KRW} , the conformal weight of E is $1 + \frac{n-2}{2} = n/2$, and the conformal weight of F is $(n-2) + 1 - \frac{n-2}{2} = n/2$. On the other hand, both E and F are primary fields of conformal weight $n/2$ with respect to T_{FS} . Since E and F generates $\mathcal{W}_n^{(2)}$, we conclude that T_{KRW} and T_{FS} induces the same conformal grading on $\mathcal{W}^k(\mathfrak{sl}_n, f_{\text{sub}})$ when $k + n \neq 0$.

According to [44, Theorem 4.1], the degree one part of $\mathcal{W}^k(\mathfrak{sl}_n, f_{\text{sub}})$ is one dimensional, which is spanned by H . Using [44, Theorem 2.1(b)], we see that H is a primary field with respect to T_{KRW} ; according to [61], H is also a primary field with respect to T_{FS} . Note that $H(z)H(w) \sim \frac{\ell_n(k)}{(z-w)^2}$, $\ell_n(k) = \frac{n-1}{n}k + n - 2$. Then Lemma E.2 implies that $T_{\text{KRW}} = T_{\text{FS}}$ when $\ell_n(k) \neq 0$. When $\ell_n(k) = 0$, we notice that all OPE coefficients depend on k algebraically, thus the fact that $T_{\text{KRW}} - T_{\text{FS}}$ is in the center of $\mathcal{W}^k(\mathfrak{sl}_n, f_{\text{sub}})$ for generic k implies that $T_{\text{KRW}} - T_{\text{FS}}$ is in the center of $\mathcal{W}^k(\mathfrak{sl}_n, f_{\text{sub}})$ for all k such that $k \neq -n$, in particular this holds when $\ell_n(k) = 0$. Thus $T_{\text{KRW}} = T_{\text{FS}}$ by Lemma E.1. \square

¹⁹To see the uniqueness, assume that T' is another stress-energy operator such that E , F , and H are primary of weights $n/2$, $n/2$, and 1, with respect to T' , then $T_{\text{FS}} - T'$ commutes with E , F , and H , therefore it commutes with the whole $\mathcal{W}_n^{(2)}$ algebra. According to Lemma E.1, we must have $T_{\text{FS}} = T'$.

It follows from Lemma 12.1 and (12.37) that

$$T = T_{\text{KRW}} + \frac{1}{2n} J_B^2 . \quad (12.38)$$

12.5 Expectation in the case of $T_{[1^n]}^\sigma[\text{SU}(n)]$ quiver

Motivated by the examples studied in the previous sections, we make the following conjecture.

Conjecture 12.1. *Let $(Q, \mathbf{v}, \mathbf{w})$ be a $T_{[1^n]}^\sigma[\text{SU}(n)]$ quiver, then there exists an embedding of vertex algebras:*

$$\Gamma : \mathcal{W}^{-n+1}(\mathfrak{gl}_n, \sigma) \hookrightarrow \text{D}^{\text{ch}}(\widetilde{\mathcal{M}}(Q, \mathbf{v}, \mathbf{w})) \otimes \mathcal{H}^n , \quad (12.39)$$

where \mathcal{H}^n is a Heisenberg algebra of level n , denoted by J_B . Moreover Γ maps the stress-energy operators $T = T_{\text{KRW}} + T_{\mathcal{H}}$ to the one defined on the quiver side (6.5), where T_{KRW} is Kac-Roan-Wakimoto's stress-energy operator for $\mathcal{W}^{-n+1}(\mathfrak{sl}_n, \sigma)$ in [43, (2.5)], and $T_{\mathcal{H}} = \frac{1}{2n} J_B^2$.

The Nakajima quiver variety $\mathcal{M}(Q, \mathbf{v}, \mathbf{w})$ is an example of conical symplectic resolution, and $\widetilde{\mathcal{M}}(Q, \mathbf{v}, \mathbf{w})$ is a family of Poisson deformation of $\mathcal{M}(Q, \mathbf{v}, \mathbf{w})$. It is shown by Namikawa in [62, 63] that for every conical symplectic resolution $\pi : X \rightarrow Y$, one can associate

1. a family of universal Poisson deformation $\mathcal{X} \rightarrow \mathbb{B}_X = H^2(X, \mathbb{C})$,
2. a family of universal Poisson deformation $\mathcal{Y} \rightarrow \mathbb{B}_Y = H^2(X, \mathbb{C})/\mathbb{W}$,
3. a map between universal Poisson deformations: $\pi : \mathcal{X} \rightarrow \mathcal{Y}$ which is compatible with quotient map $\mathbb{B}_X \rightarrow \mathbb{B}_Y$, i.e. the diagram commutes

$$\begin{array}{ccc} \mathcal{X} & \longrightarrow & \mathbb{B}_X \\ \pi \downarrow & & \downarrow / \mathbb{W} \\ \mathcal{Y} & \longrightarrow & \mathbb{B}_Y \end{array} \quad (12.40)$$

Here \mathbb{W} is a finite group with a linear action on \mathbb{B}_X . \mathbb{W} is called the Namikawa-Weyl group. It is known that $\mathbb{C}[\mathcal{Y}] = \mathbb{C}[\mathcal{X}]^{\mathbb{W}}$. Denoting by \mathbb{S} the one dimensional torus with the conical action on $\pi : X \rightarrow Y$, then the \mathbb{S} -action extends naturally to every space in the diagram (12.40) such that all maps are equivariant. We note that \mathbb{S} acts on \mathbb{B}_X with weight 2.

Moreover, it is also known from the work of Losev that the Namikawa-Weyl group acts on the universal quantization as well [64]. Namely there is a sheaf of \hbar -adic associative $\mathbb{C}[\mathbb{B}_X]$ -algebras $\mathcal{D}_{\mathcal{X}, \hbar}$ on \mathcal{X} such that $\mathcal{D}_{\mathcal{X}, \hbar}/\hbar \mathcal{D}_{\mathcal{X}, \hbar} \cong \mathcal{O}_{\mathcal{X}}$, together with an action \mathbb{W} on $\mathcal{D}_{\mathcal{X}, \hbar}$ which satisfies the following properties:

1. The induced \mathbb{W} -action on $\mathcal{O}_{\mathcal{X}}$ agrees with the one constructed by Namikawa.
2. The \mathbb{S} -action naturally extends to $\mathcal{D}_{\mathcal{X}, \hbar}$ such that $\deg \hbar = 1$. Set

$$\text{D}(\mathcal{X}) := \mathcal{D}_{\mathcal{X}, \hbar}(\mathcal{X})_{\mathbb{S}\text{-fin}}/(\hbar - 1) ,$$

then every quantization of Y is isomorphic to $\text{D}(\mathcal{X})_\lambda := \text{D}(\mathcal{X})/(\mathfrak{m}_\lambda \text{D}(\mathcal{X}))$ for some $\lambda \in \mathbb{B}_X$, where \mathfrak{m}_λ is the maximal ideal of $\mathbb{C}[\mathbb{B}_X]$ corresponding to λ .

3. $D(\mathcal{X})_\lambda \cong D(\mathcal{X})_{\lambda'}$ if and only if $\lambda' \in \mathbb{W}\lambda$.

The Namikawa-Weyl group \mathbb{W} of the Nakajima quiver variety \mathcal{M} corresponding to the $T_{[1n]}^\sigma[\mathrm{SU}(n)]$ quiver is \mathfrak{S}_n [65]. There is a linear map $\mathbb{C}^{Q_0} \rightarrow H^2(\mathcal{M}, \mathbb{C})$ by the universal property. Precisely, this map is given by sending the base vector of i^{th} node to $c_1(\mathcal{Y}_i)$, where \mathcal{Y}_i is the i^{th} tautological bundle on \mathcal{M} . It is not hard to see that this map is an isomorphism²⁰. It follows that $\widetilde{\mathcal{M}}$ is the universal Poisson deformation of \mathcal{M} . According to [67, Theorem 5.3.3], there is an embedding of finite \mathcal{W} -algebra $\mathcal{W}(\mathfrak{sl}_n, \sigma)$ into $D(\widetilde{\mathcal{M}})$, moreover the image coincides with $D(\widetilde{\mathcal{M}})^\mathbb{W}$.

Conjecture 12.2. *Let $(Q, \mathbf{v}, \mathbf{w})$ be a $T_{[1n]}^\sigma[\mathrm{SU}(n)]$ quiver, then the Namikawa-Weyl group $\mathbb{W} = \mathfrak{S}_n$ acts on $D^{\mathrm{ch}}(\widetilde{\mathcal{M}}(Q, \mathbf{v}, \mathbf{w}))$ by a vertex algebra automorphism, such that the orbifold subalgebra $D^{\mathrm{ch}}(\widetilde{\mathcal{M}}(Q, \mathbf{v}, \mathbf{w}))^\mathbb{W} \otimes \mathcal{H}^n$ is the image of the embedding Γ in Conjecture 12.1.*

Finally, the embedding Γ should be compatible with Miura maps of affine \mathcal{W} -algebras in the following sense. For a partition $\sigma = [l^{w_1}, \dots, 1^{w_l}]$, one can associate a sequence $q_1 \geq \dots \geq q_l > 0$ as follows

$$q_i = \sum_{j=i}^l w_j .$$

We note that $n = q_1 + \dots + q_l$. There exists an embedding of vertex algebras called *Miura map* [44]:

$$\Xi : \mathcal{W}^k(\mathfrak{gl}_n, \sigma) \hookrightarrow \bigotimes_{i=1}^l V^{k_i}(\mathfrak{gl}(q_i)) , \quad \text{where } k_i = k + n - q_i .$$

There is a Wakimoto realization for each component

$$\Omega_i : V^{k_i}(\mathfrak{gl}(q_i)) \hookrightarrow D^{\mathrm{ch}}(T^*\mathbb{C}^{q_i(q_i-1)/2}) \otimes \mathcal{H}(\mathbb{C}^{q_i}, \kappa_i) ,$$

where κ_i is the inner form on $\mathbb{C}^{q_i} = \bigoplus_{s=1}^{q_i} \mathbb{C} \cdot a_s$ such that $\kappa_i(a_s, a_t) = (k_i + q_i)\delta_{s,t}$. Composing the Miura map with Wakimoto realizations, we get an embedding

$$\Omega \circ \Xi : \mathcal{W}^k(\mathfrak{gl}_n, \sigma) \hookrightarrow D^{\mathrm{ch}}\left(T^*\mathbb{C}^{\sum_{i=1}^l q_i(q_i-1)/2}\right) \otimes \mathcal{H}(\mathbb{C}^n, \kappa) , \quad (12.41)$$

where κ is the inner form on $\mathbb{C}^n = \bigoplus_{s=1}^n \mathbb{C} \cdot a_s$ such that $\kappa(a_s, a_t) = (k + n)\delta_{s,t}$. We note that

$$\sum_{i=1}^l \frac{q_i(q_i-1)}{2} = \frac{1}{2} \dim \mathcal{M}(Q, \mathbf{v}, \mathbf{w}) = \mathbf{v} \cdot \left(\mathbf{w} - \frac{1}{2}\mathbf{C}\mathbf{v}\right) . \quad (12.42)$$

²⁰By the Kirwan surjectivity [66], this map is surjective. On the other hand, in view of the proof of [65, Lemma 5.1], there is only one codimension 2 symplectic leaf in \mathcal{M}^0 , and its transverse slice is an A_{n-1} singularity whose preimage in \mathcal{M} is the minimal resolution of A_{n-1} singularity, such that $c_1(\mathcal{Y}_i)[\mathbb{P}_j^1] = \delta_{i,j}$, where \mathbb{P}_j^1 is the j^{th} copy of \mathbb{P}^1 in the central fiber of resolution of A_{n-1} singularity. This implies that $\mathbb{C}^{Q_0} \rightarrow H^2(\mathcal{M}, \mathbb{C})$ is injective. Therefore it is an isomorphism.

In our case, where $k = -n + 1$, so the Heisenberg factor in (12.41) is the tensor product of n copies of level 1 Heisenberg algebras \mathcal{H}^1 , so we can rewrite (12.41) into

$$\Omega \circ \Xi : \mathcal{W}^{-n+1}(\mathfrak{gl}_n, \sigma) \hookrightarrow D^{\text{ch}} \left(T^* \mathbb{C}^{\mathbf{v} \cdot (\mathbf{w} - \frac{1}{2} \mathbf{C} \mathbf{v})} \right) \otimes \bigotimes_{i=1}^n \mathcal{H}^1. \quad (12.43)$$

On the other hand, assuming Conjecture 12.1, then composing the embedding Γ in (12.39) with the free-field realization (11.39), we also get a vertex algebra embedding:

$$\Theta \circ \Gamma : \mathcal{W}^{-n+1}(\mathfrak{gl}_n, \sigma) \hookrightarrow D^{\text{ch}} \left(T^* \mathbb{C}^{\mathbf{v} \cdot (\mathbf{w} - \frac{1}{2} \mathbf{C} \mathbf{v})} \right) \otimes \bigotimes_{i=1}^n \mathcal{H}^{\lambda_i}. \quad (12.44)$$

Conjecture 12.3. *Assuming Conjecture 12.1, then $\Omega \circ \Xi$ agrees with $\Theta \circ \Gamma$, up to an isomorphism between right hand sides of (12.43) and (12.44).*

13 Comparison with 4d $\mathcal{N} = 2$ VOAs

The 3d $\mathcal{N} = 4$ balanced linear quiver gauge theories considered in this paper can be obtained as a dimensional reduction of 4d $\mathcal{N} = 2$ quiver gauge theories. When the quiver is balanced, the resulting 4d $\mathcal{N} = 2$ quiver gauge theory is superconformal, and the work of [28, 68, 69] associated a VOA with the 4d theory. It is therefore a natural question to ask if there are any relations between the two VOAs. Indeed, the 3d and 4d theories have the same Higgs branches, and it is natural to conjecture that the two VOAs share the same associated varieties.

There are, however, important differences between the two. In 4d, the VOA is defined by taking cohomologies with respect to a nilpotent supercharge, which involves a generator of the superconformal charge. For this reason, we need to impose superconformality of the 4d theory, and this leads to the balanced condition on the quiver. The gauge groups of the quivers are taken to be SU gauge groups.

In 3d, in contrast, the gauge groups at the quiver vertices are taken to be U instead of SU from 4d; this is because the U(1) part has non-trivial dynamics in 3d. Moreover, the VOA is defined even for non-balanced quivers, as we have seen above. However, we have to include extra fermionic matter to cancel the anomalies on the 2d boundary. As we have seen in the discussion above, the presence of such fermionic modes for 3d VOAs play a crucial roles in the formulation of our VOAs; for example, some of our currents are not BRST-invariant without such fermionic modes.

In order to make a comparison between 3d and 4d VOAs, let us assume that Q is a balanced quiver, and for simplicity we also assume that the Cartan matrix \mathbf{C} is invertible. One can then associate three VOAs to Q :

1. $\mathcal{V}(Q)$: the BRST reduction of $\beta\gamma$ system \otimes Heisenberg fields $\{h_i, i \in Q_0\}$.
2. $\mathcal{V}_\partial(Q)$: boundary H-twisted VOA of 3d $\mathcal{N} = 4$ gauge theory associated to Q . We use the canonical choice of free fermions in (5.4) to cancel the SU anomalies, and the definition of $\mathcal{V}_\partial(Q)$ involves a choice of another set of free fermions that cancel U(1) anomalies.

3. $\mathcal{V}_{4d}(Q)$: the VOA of the 4d $\mathcal{N} = 2$ gauge theory associated to Q with gauge group $\prod_{i \in Q_0} \mathrm{SU}(\mathbf{v}_i)$. By definition $\mathcal{V}_{4d}(Q) = H_{\mathrm{BRST}}^{\infty/2+0}(\mathfrak{sl}(\mathbf{v}), \beta\gamma)$.

The remaining $(\mathbb{C}^\times)^{Q_0}$ -symmetry gives a weight decomposition on $\mathcal{V}_{4d}(Q)$:

$$\mathcal{V}_{4d}(Q) \cong \bigoplus_{\lambda \in \mathbb{Z}^{Q_0}} \mathcal{V}_{4d}(Q)_\lambda,$$

where $\mathcal{V}_{4d}(Q)_\lambda$ is the weight λ eigenspace. Now consider the following module of $\mathcal{V}(Q)$:

$$\mathcal{V}_\lambda(Q) = H_{\mathrm{BRST}}^{\infty/2+0}(\mathfrak{gl}(\mathbf{v}), \beta\gamma \otimes \mathcal{H}_\lambda),$$

\mathcal{H}_λ is the Verma module of the Heisenberg algebra $\mathcal{H} = \{h_i, i \in Q_0\}$ generated from a vector $|\lambda\rangle$ such that $h_{i,(0)}|\lambda\rangle = \lambda_i|\lambda\rangle$. $\mathcal{V}(Q)$, $\mathcal{V}_\partial(Q)$, and $\mathcal{V}_{4d}(Q)$ are related by the followings:

- (1) There is a vertex algebra map $\mathcal{V}(Q) \rightarrow \mathcal{V}_{4d}(Q)_0$, and there are $\mathcal{V}(Q)$ -module maps $\mathcal{V}_\lambda(Q) \rightarrow \mathcal{V}_{4d}(Q)_{-\lambda}$. To see this map, one can consider the vertex algebra extension $\mathcal{H} \subset \mathcal{H} \times \mathbb{C}[J_\infty(\mathbb{C}^\times)^{Q_0}]$, where

$$\mathbb{C}[J_\infty(\mathbb{C}^\times)^{Q_0}] = \mathbb{C}[A_{i,(-1)}^{-1}, A_{i,(-n)} \mid i \in Q_0, n \in \mathbb{Z}_{\geq 1}]|0\rangle$$

is the function ring on the ∞ -jet bundle of the central tori $(\mathbb{C}^\times)^{Q_0} \subset \mathrm{GL}(\mathbf{v})$, regarded as a commutative vertex algebra, and \mathcal{H} acts on $\mathbb{C}[J_\infty(\mathbb{C}^\times)^{Q_0}]$ via OPEs

$$h_i(z)(A_j)^n(w) \sim \frac{n\delta_{i,j}(A_j)^n(w)}{z-w}, \quad \forall n \in \mathbb{Z}. \quad (13.1)$$

Then we have a spectral sequence $E^{p,q}$ with second page

$$E_2^{p,q} = H_{\mathrm{BRST}}^{\infty/2+q}(\mathfrak{sl}(\mathbf{v}), H_{\mathrm{BRST}}^{\infty/2+p}(\mathfrak{gl}(1)^{Q_0}, \beta\gamma \otimes \mathcal{H} \times \mathbb{C}[J_\infty(\mathbb{C}^\times)^{Q_0}])). \quad (13.2)$$

Notice that the semidirect product $(\tilde{\mu}_{\mathrm{ch}}(\mathfrak{gl}(1)^{Q_0}) \times \mathbb{C}[J_\infty(\mathbb{C}^\times)^{Q_0}])$ between the current of $\mathfrak{gl}(1)^{Q_0}$ and its module $\mathbb{C}[J_\infty(\mathbb{C}^\times)^{Q_0}]$ is a quantization of the ∞ -jet bundle of $T^*(\mathbb{C}^\times)^{Q_0}$; then we have ²¹

$$H_{\mathrm{BRST}}^{\infty/2+p}(\mathfrak{gl}(1)^{Q_0}, \beta\gamma \otimes \mathcal{H} \times \mathbb{C}[J_\infty(\mathbb{C}^\times)^{Q_0}]) \cong \begin{cases} \beta\gamma, & q = 0 \\ 0, & q \neq 0. \end{cases}$$

Therefore $E^{p,q}$ collapse at the second page and converges to $H_{\mathrm{BRST}}^{\infty/2+p+q}(\mathfrak{gl}(\mathbf{v}), \beta\gamma \otimes \mathcal{H} \times \mathbb{C}[J_\infty(\mathbb{C}^\times)^{Q_0}])$, thus we get an isomorphism:

$$H_{\mathrm{BRST}}^{\infty/2+\bullet}(\mathfrak{gl}(\mathbf{v}), \beta\gamma \otimes \mathcal{H} \times \mathbb{C}[J_\infty(\mathbb{C}^\times)^{Q_0}]) \cong H_{\mathrm{BRST}}^{\infty/2+\bullet}(\mathfrak{sl}(\mathbf{v}), \beta\gamma).$$

²¹Consider $\varepsilon : \beta\gamma \hookrightarrow \beta\gamma \otimes \mathcal{H} \times \mathbb{C}[J_\infty(\mathbb{C}^\times)^{Q_0}]$, $\varepsilon(x_\lambda) = \exp\left(-\sum_{i \in Q_0} \sum_{n=1}^{\infty} \mu_{\mathrm{ch},i,(n)} A_{i,(-n-1)} A_{i,(-1)}^{-1}\right) (x_\lambda \otimes |-\lambda\rangle)$, where μ_{ch} is the non-extended chiral moment map, and x_λ belongs to the weight λ piece of $\beta\gamma$, and $|-\lambda\rangle = \prod_{i \in Q_0} A_{i,(-1)}^{-\lambda_i} |0\rangle$. ε is a vertex algebra map, an intuitive way to see this is that ε can be regarded as the restriction of the vertex algebra ‘‘automorphism’’ $\exp\left(-\sum_{i \in Q_0} : \mu_{\mathrm{ch},i} \log A_i :_{(0)}\right)$ of $\beta\gamma \otimes \mathcal{H} \times \mathbb{C}[J_\infty(\mathbb{C}^\times)^{Q_0}]$ to $\beta\gamma$. Then $\beta\gamma \otimes \mathcal{H} \times \mathbb{C}[J_\infty(\mathbb{C}^\times)^{Q_0}] = \varepsilon(\beta\gamma) \otimes \tilde{\mu}_{\mathrm{ch}} \times \mathbb{C}[J_\infty(\mathbb{C}^\times)^{Q_0}]$, thus $H_{\mathrm{BRST}}^{\infty/2+p}(\mathfrak{gl}(1)^{Q_0}, \beta\gamma \otimes \mathcal{H} \times \mathbb{C}[J_\infty(\mathbb{C}^\times)^{Q_0}]) \cong \beta\gamma \otimes H_{\mathrm{BRST}}^{\infty/2+p}(\mathfrak{gl}(1)^{Q_0}, \tilde{\mu}_{\mathrm{ch}} \times \mathbb{C}[J_\infty(\mathbb{C}^\times)^{Q_0}])$, which is isomorphic to $\beta\gamma$ when $p = 0$ and zero otherwise.

Composing with the vertex algebra map $\mathcal{H} \rightarrow \mathcal{H} \times \mathbb{C}[J_\infty(\mathbb{C}^\times)^{Q_0}]$ the module map $\mathcal{H}_\lambda \rightarrow \mathcal{H} \times \mathbb{C}[J_\infty(\mathbb{C}^\times)^{Q_0}]_\lambda$, we get the desired maps between BRST reductions:

$$\mathcal{V}(Q) \rightarrow \mathcal{V}_{4d}(Q)_0, \quad \mathcal{V}_\lambda(Q) \rightarrow \mathcal{V}_{4d}(Q)_{-\lambda}. \quad (13.3)$$

Since we assume that the Cartan matrix \mathbf{C} is invertible, $\mathcal{V}(Q)$ becomes a VOA and we can talk about its character. To make an explicit comparison between characters, we add the nonzero cohomology degrees, i.e. with bc ghosts included, and consider the characters $\chi_{\mathcal{V}^\bullet}(q) := \text{Tr}_{\mathcal{V}^\bullet}(-1)^F q^{L_0 - c/24}$. Then the characters of $\mathcal{V}_\lambda^\bullet(Q)$ and $\mathcal{V}_{4d}^\bullet(Q)$ are related by

$$\chi_{\mathcal{V}_\lambda^\bullet(Q)}(q) = \eta(q)^{|Q_0|} \chi_{\mathcal{V}_{4d}^\bullet(Q)_{-\lambda}}(q).$$

(2) There is an isomorphism

$$\mathcal{V}_\partial(Q) \cong \bigoplus_{\lambda \in \mathbb{Z}^r} \mathcal{V}_{\sigma(\lambda)}(Q) \otimes \mathcal{H}_{\sigma^\perp(\lambda)}^\perp,$$

where r is the number of pairs of $\chi\psi$ fermions and $\sigma : \mathbb{Z}^r \rightarrow \mathbb{C}^{Q_0}$ is the map of charges which is induced from the choice of anomaly cancellation map $\{h_i\}_{i \in Q_0} = \mathcal{H} \rightarrow (\mathcal{H}^1)^{\otimes r} = \{\chi_j \psi_j\}_{j=1, \dots, r}$. \mathcal{H}^\perp is the Heisenberg algebra strongly generated by the subspace of $\bigoplus_{j=1}^r \mathbb{C} \cdot \chi_j \psi_j$ perpendicular to the image of \mathcal{H} , and $\sigma^\perp : \mathbb{Z}^r \rightarrow \mathbb{C}^{r-|Q_0|}$ is the induced map for charges.

14 Discussions

In this paper we have studied VOAs arising from non-Abelian quiver gauge theories, regarded as “chiralizations” of extended quiver varieties. In particular, by localization of quiver vertex algebras, we developed a systematic algorithm for the reduction of general quiver diagrams which produces a free field realization of the associated VOAs. While some of the mathematical points raised here will be discussed in our companion paper [16], there are still many open questions left for future research. Let us comment here on some of them.

So far, we have concentrated on the H-twisted VOAs of 3d quiver gauge theories. It would nevertheless be interesting to establish a systematic construction of C-twisted VOAs and to then verify the mirror symmetry for the resulting VOAs (which exchanges ρ and σ for the $T_\rho^\sigma[\text{SU}(N)]$ theories).

Another natural direction is to consider 3d $\mathcal{N} = 4$ SQFTs with more general Lagrangians. Examples include quiver gauge theories with non-linear quivers, quiver gauge theories with more general gauge groups, such as $T[G]$ theories, or gauge theories with Chern-Simons terms. In relation to this point, there have been recent discussions [12, 70–73] of rational VOAs associated with “rank 0” theories [12, 74–77], whose Coulomb and Higgs branches both have dimension 0, and it would be nice to connect our discussion here more directly to the rational VOAs discussed in these references.

While in this paper we defined boundary VOAs from the data of quiver gauge theories, it would be interesting to similarly study VOAs with other infinite-dimensional algebras associated with quivers, such as (shifted) quiver Yangians [78–80] and quiver W-algebras [81].

We have seen a close parallel between the geometry of the Higgs branch and the algebra of the VOA, and indeed some information of the latter can be recovered from the former. We expect, however, that some subtle details of the VOA, such as the detailed coefficients of the OPE of the generators, are not readily recovered from the Higgs branch. This suggests that the VOA contains more information than the Higgs branch. It would be interesting to clarify on this point.

Acknowledgments

We would like to thank Toshiro Kuwabara, Hiraku Nakajima, Shigenori Nakatsuka, and Satoshi Nawata for stimulating discussions, and Davide Gaiotto for comments on our manuscript. MS was supported in part by National Research Foundation (NRF) of Korea grant NRF-2022R1A6A3A03053466 and by the Shuimu Scholar program of Tsinghua University. MY was supported in part by the JSPS Grant-in-Aid for Scientific Research (No. 19H00689, 19K03820, 20H05860, 23H01168), and by JST, Japan (PRESTO Grant No. JPMJPR225A, Moonshot R&D Grant No. JPMJMS2061).

A Glossary

- G : gauge group
- M : a symplectic representation specifying the matter content
- R : a symplectic representation for Fermi multiplets needed for gauge anomaly cancellations on the boundary
- $\mathcal{V}_\partial = \mathcal{V}_\partial[G, M, R]$: H-twisted boundary VOA for 3d $\mathcal{N} = 4$ theory
- $\mathcal{V}_\partial^\sharp = \mathcal{V}_\partial^\sharp[M, R]$: VOA before BRST reduction (so that $\mathcal{V} = \mathcal{V}^\sharp // G$)
- $\mathcal{V} = \mathcal{V}(Q, \mathbf{v}, \mathbf{w})$: vertex algebra associated to quiver data $(Q, \mathbf{v}, \mathbf{w})$
- $\mathcal{V}^\sharp = \mathcal{V}^\sharp(Q, \mathbf{v}, \mathbf{w})$: vertex algebra associated to quiver data $(Q, \mathbf{v}, \mathbf{w})$ before BRST reduction
- $D^{\text{ch}}(M)$: $\beta\gamma\text{bc}$ system associated to a symplectic super vector space M
- \mathcal{H}^k : Heisenberg algebra of level k , i.e. the OPE is $h(z)h(w) \sim k/(z-w)^2$.
- k_c : critical level for a simple Lie algebra \mathfrak{g} , which equals to $-\mathfrak{h}_{\mathfrak{g}}^\vee$
- \mathcal{Q} : BRST charge (BRST differential)
- \mathcal{J} : BRST current

- $\tilde{C}(\mathfrak{g}, V)$: BRST complex associated to a vertex algebra V with a $\widehat{\mathfrak{g}}$ -symmetry at the level $k_V = 2k_c$
- $C(\mathfrak{g}, V)$: relative BRST complex associated to $\tilde{C}(\mathfrak{g}, V)$
- $H_{\text{BRST}}^{\infty/2+\bullet}(\mathfrak{g}, V)$: relative BRST cohomology associated to a vertex algebra V with a $\widehat{\mathfrak{g}}$ -symmetry at the level $k_V = 2k_c$
- $\mathcal{M} = \mathcal{M}(Q, \mathbf{v}, \mathbf{w})$: Nakajima quiver variety associated to a quiver Q with gauge dimension \mathbf{v} and framing dimension \mathbf{w}
- $\mathcal{M}^0 = \mathcal{M}^0(Q, \mathbf{v}, \mathbf{w})$: affine quiver variety associated to a quiver Q with gauge dimension \mathbf{v} and framing dimension \mathbf{w}
- $\widetilde{\mathcal{M}} = \widetilde{\mathcal{M}}(Q, \mathbf{v}, \mathbf{w})$: extended Nakajima quiver variety associated to a quiver Q with gauge dimension \mathbf{v} and framing dimension \mathbf{w}
- $\widetilde{\mathcal{M}}^0 = \widetilde{\mathcal{M}}^0(Q, \mathbf{v}, \mathbf{w})$: extended affine quiver variety associated to a quiver Q with gauge dimension \mathbf{v} and framing dimension \mathbf{w}
- $J_\infty X$: ∞ -jet scheme of a variety X
- $\mathbb{C}[X]$: the global ring of functions on a variety X
- $\mathcal{R}(V)$: Zhu's C_2 algebra for a vertex algebra V

B BRST reduction

In this appendix we recall the mathematical construction of the BRST reduction.

Let \mathfrak{g} be a reductive Lie algebra and κ be a \mathfrak{g} -invariant symmetric inner form on \mathfrak{g} , then the current algebra $V^\kappa(\mathfrak{g})$, as a vector space, is isomorphic to

$$\mathbb{C}[J_\infty \mathfrak{g}] = \mathbb{C}[E_{(-n)}^\alpha \mid n \in \mathbb{Z}_{\geq 1}, E^\alpha \in \text{a basis of } \mathfrak{g}]|0\rangle$$

endowed with OPE

$$E^\alpha(z)E^\beta(w) \sim \frac{\kappa^{\alpha,\beta}}{(z-w)^2} + \frac{f_\gamma^{\alpha\beta} E^\gamma(w)}{z-w},$$

where $\kappa^{\alpha,\beta} = \kappa(E^\alpha, E^\beta)$ is the matrix element of the inner form κ , and $f_\gamma^{\alpha\beta} E^\gamma = [E^\alpha, E^\beta]$ is the structure constant of \mathfrak{g} .

Denote by $\kappa_{\mathfrak{g}}$ the killing form on \mathfrak{g} . Suppose that V is a vertex superalgebra such that there exists a vertex superalgebra map

$$J_V : V^{-\kappa_{\mathfrak{g}}}(\mathfrak{g}) \rightarrow V.$$

Then we define vertex superalgebra

$$\tilde{C}(\mathfrak{g}, V) := V \otimes \mathcal{V}_{\text{bc}}(\mathfrak{g}), \tag{B.1}$$

where $\mathcal{V}_{bc}(\mathfrak{g})$ is the bc system of \mathfrak{g} , i.e. chiral differential operators $D^{\text{ch}}(\Pi T^*\mathfrak{g})$ of the odd symplectic vector space $\Pi T^*\mathfrak{g}$. Note that $\mathcal{V}_{bc}(\mathfrak{g})$ admits a vertex superalgebra map

$$J_{bc} : V^{\kappa_{\mathfrak{g}}}(\mathfrak{g}) \rightarrow \mathcal{V}_{bc}(\mathfrak{g}), \quad J_{bc}(E^\alpha) = f^{\alpha\beta} c_\beta b^\alpha.$$

$\mathcal{V}_{bc}(\mathfrak{g})$ is graded by ghost numbers, i.e. $\deg c = +1, \deg b = -1$, so the image of J is contained in the degree zero piece $\mathcal{V}_{bc}^0(\mathfrak{g})$. Consider the ghost number 1 element

$$\mathcal{J} := c_\alpha \left(J_V(E^\alpha) + \frac{1}{2} J_{bc}(E^\alpha) \right) \in \tilde{C}^1(\mathfrak{g}, V). \quad (\text{B.2})$$

The operator $\mathcal{Q} := \mathcal{J}_{(0)}$ acts on $\tilde{C}(\mathfrak{g}, V)$, and it squares to zero $\mathcal{Q}^2 = 0$, therefore $(\tilde{C}(\mathfrak{g}, V), \mathcal{Q})$ is a chain complex of vertex superalgebra, which is graded by ghost numbers. We call it the BRST complex.

Note that the linear map

$$E^\alpha \mapsto J(E^\alpha) := \mathcal{Q}(b^\alpha) = J_V(E^\alpha) + J_{bc}(E^\alpha), \quad (\text{B.3})$$

is a vertex superalgebra chain complex map

$$J : (V^0(\mathfrak{g}), 0) \rightarrow (\tilde{C}(\mathfrak{g}, V), \mathcal{Q})$$

where the LHS is endowed with trivial differential. In particular the Lie algebra \mathfrak{g} acts on the complex $(\tilde{C}(\mathfrak{g}, V), \mathcal{Q})$ by $E^\alpha \mapsto J(E^\alpha)_{(0)}$.

The relative BRST complex is defined to be the subspace

$$C(\mathfrak{g}, V) := \{v \in \tilde{C}(\mathfrak{g}, V) \mid J(E^\alpha)_{(0)}v = b_{(0)}^\alpha v = 0, \forall \alpha\}, \quad (\text{B.4})$$

which is a sub-complex because $[J(E^\alpha)_{(0)}, \mathcal{Q}] = 0$ and $[b_{(0)}^\alpha, \mathcal{Q}] = J(E^\alpha)_{(0)}$. We define the relative BRST cohomology to be

$$H_{\text{BRST}}^{\infty/2+\bullet}(\mathfrak{g}, V) := H^\bullet(C(\mathfrak{g}, V), \mathcal{Q}). \quad (\text{B.5})$$

This is a \mathbb{Z} -graded vertex superalgebra.

B.1 Some BRST exact elements

For the sake of computation in the main contents of this paper, we present some BRST exact elements, i.e. $x \in C(\mathfrak{g}, V)$ such that $x = \mathcal{Q}(y)$ for some $y \in C(\mathfrak{g}, V)$. The first obvious one is $J(E^\alpha)$ in (B.3).

Next, let us assume that $X \in \mathfrak{g}$ is an element in the center of \mathfrak{g} , then we take the corresponding ghost field $X_\alpha b^\alpha$ and take its BRST variation:

$$\mathcal{Q}(X_\alpha b^\alpha) = J_V(X). \quad (\text{B.6})$$

Thus $J_V(X)$ is BRST exact. For example in the quiver setting, for every gauge node $i \in Q_0$, the operator $\text{Tr}(\tilde{\mu}_{\text{ch},i})$ is BRST exact.

Next, let us consider a multiplet $\{\mathcal{O}_\alpha \in V\}_{\alpha=1, \dots, \dim \mathfrak{g}}$ living in adjoint representation of the currents of \mathfrak{g} , i.e.

$$J_V(E^\alpha)(z)\mathcal{O}_\beta(w) \sim \frac{f^{\alpha\gamma}_\beta \mathcal{O}_\gamma(w)}{z-w}, \quad (\text{B.7})$$

then we have

$$\mathcal{Q}(\mathcal{O}_\alpha \mathbf{b}^\alpha) =: J_V(E^\alpha)\mathcal{O}_\alpha : \quad (\text{B.8})$$

Thus : $J_V(E^\alpha)\mathcal{O}_\alpha$: is BRST exact, or equivalently : $\mathcal{O}_\alpha J_V(E^\alpha)$: is BRST exact.

Furthermore, we can consider a multiplet $\{\mathcal{S}_\alpha \in V\}_{\alpha=1, \dots, \dim \mathfrak{g}}$ living in adjoint representation of the currents of \mathfrak{g} with anomalies, i.e.

$$J_V(E^\alpha)(z)\mathcal{S}_\beta(w) \sim \frac{\lambda \delta_\beta^\alpha}{(z-w)^2} + \frac{f^{\alpha\gamma}_\beta \mathcal{S}_\gamma(w)}{z-w}, \quad \lambda \in \mathbb{C}, \quad (\text{B.9})$$

then we have

$$\mathcal{Q}(\mathcal{S}_\alpha \mathbf{b}^\alpha) =: J_V(E^\alpha)\mathcal{S}_\alpha : -\lambda : \mathbf{b}^\alpha \partial \mathbf{c}_\alpha : \quad (\text{B.10})$$

Thus : $J_V(E^\alpha)\mathcal{S}_\alpha$: equals to $\lambda : \mathbf{b}^\alpha \partial \mathbf{c}_\alpha$: modulo a BRST exact term.

C Proof of (6.24)

To verify (6.24), let us write down the explicit form of each term on the right-hand-side of (6.23) in terms of the partition $((N-1)^{w_{N-1}} \dots i^{w_i} \dots 1^{w_1})$ as follows (note $\mathfrak{h}^\vee = -N$ for $\text{SU}(N)$):

$$\frac{k \dim \mathfrak{g}}{k + \mathfrak{h}^\vee} = -(N-1)(N^2 - 1), \quad (\text{C.1})$$

$$(x|x) = \sum_{i=1}^{N-1} w_i \frac{i^3 - i}{12}, \quad (\text{C.2})$$

$$\begin{aligned} \sum_{\alpha \in S_+} (12m_\alpha^2 - 12m_\alpha + 2) &= \sum_{\substack{i>j \\ i-j \text{ even}}} \left(w_i w_j \times \sum_{\substack{k \in [i-j, i+j] \\ k \equiv 0 \pmod{2}}} (k^3 - 2k) \right) \\ + \sum_{\substack{i>j \\ i-j \text{ odd}}} \left(w_i w_j \times \sum_{\substack{k \in [i-j, i+j] \\ k \equiv 1 \pmod{2}}} (k^3 - 2k - 1) \right) &+ \sum_{i=1}^{N-1} \left(w_i^2 \times \sum_{\substack{k \in [0, 2i] \\ k \equiv 0 \pmod{2}}} \frac{k^3 - 2k}{2} \right), \end{aligned} \quad (\text{C.3})$$

$$\dim \mathfrak{g}_{1/2} = \sum_{\substack{i>j \\ i-j \text{ odd}}} 2j w_i w_j. \quad (\text{C.4})$$

Plug (C.1)-(C.4) into (6.23), and use the identity $N = \sum_{i=1}^{N-1} iw_i$, and then we compute that

$$\begin{aligned} \text{RHS of (6.24)} &= -N^3 + \sum_{i=1}^{N-1} (w_i(2i - i^3) + w_i^2(2i^3 - i)) \\ &\quad + \sum_{i>j}^{N-1} w_i w_j (j^3 + 3i^2 j - 2j) . \end{aligned} \tag{C.5}$$

On the other hand, we can use (4.16) to rewrite (6.7) in terms of w_i . After doing some gymnastics we arrive at the equation

$$\text{LHS of (6.24)} = \text{RHS of (C.5)} . \tag{C.6}$$

Thus (6.24) holds.

D Minimal generators in terms of paths

We have seen in section 6.3 that we can restrict to operators of the form (6.20) when searching for generators of the VOAs considered in this paper which are associated to paths on linear quivers and which are classically gauge invariant. For the A-type quiver in Fig. 16, this means that there are effectively four types of paths and corresponding operators to consider: i) paths which begin and end at the node w_1 and loop around the node $v_{\ell+1}$ for all $\ell \in \{0, 1, \dots, k-2\}$, following the notation in Fig. 5, which translate to operators

$$J_1 X_1 X_2 \cdots X_\ell Y_\ell \cdots Y_2 Y_1 I_1 , \tag{D.1}$$

ii) operators associated to paths which begin at the node w_1 , loop around a node $v_{\ell+1}$ with $\ell \geq 1$ and end at w_2

$$J_2 X_2 \cdots X_\ell Y_\ell \cdots Y_2 Y_1 I_1 , \tag{D.2}$$

iii) operators associated to paths which begin and end at the node w_2 , looping around $v_{\ell+1}$ for all $\ell \geq 1$

$$J_2 X_2 \cdots X_\ell Y_\ell \cdots Y_2 I_2 , \tag{D.3}$$

and iv) operators associated to paths which begin at the node w_2 , loop around $v_{\ell+1}$ for all $\ell \geq 1$ and end at node w_1

$$J_1 X_1 X_2 \cdots X_\ell Y_\ell \cdots Y_2 I_2 . \tag{D.4}$$

We demonstrate now that for the A-type quiver depicted in Fig. 16, it is sufficient to consider the operators defined in (8.5) as generators for the corresponding H-twisted VOA which are associated to paths. Note that setting $\ell = 0$ in (D.1) reduces this to $J_1 I_1$, which enters the definition of the BRST current $G^{(1,1)}$ in (8.5), while $\ell = 1$ in (D.2) gives precisely $G^{(2,1)}$. Using the moment map relations $\hat{\mu}^{(i)a}_b = 0$ from (8.6), it is possible to reduce all of the bosonic currents associated to the paths of type i)-vi) to linear combinations of products of the BRST-invariant currents (8.5) and fermion bilinears of the form $\chi_\ell \psi_\ell$. Starting for example with the type i) current (D.1) and using the ℓ^{th} -moment map relation to replace

the inner-most product $X_\ell Y_\ell$ with $Y_{\ell-1} X_{\ell-1}$ and the fermion bilinears $\chi_{\ell-1} \psi_{\ell-1} - \chi_\ell \psi_\ell$ reduces this to²²

$$\begin{aligned} (J_1 X_1 X_2 \cdots (X_\ell)_b^a (Y_\ell)_c^b \cdots Y_2 Y_1 I_1)^i_j = \\ (J_1 X_1 X_2 \cdots (X_{\ell-1})_a^e (Y_{\ell-1})_b^a (X_{\ell-1})_c^b (Y_{\ell-1})_d^c \cdots Y_2 Y_1 I_1)^i_j \\ - (J_1 X_1 X_2 \cdots (X_{\ell-1})_a^e (Y_{\ell-1})_d^a \cdots Y_2 Y_1 I_1)^i_j (\chi_{\ell-1} \psi_{\ell-1} - \chi_\ell \psi_\ell) . \end{aligned} \quad (\text{D.5})$$

The path corresponding to the second line encircles the node v_ℓ and loops once around the segment connecting this to $v_{\ell-1}$, whereas that corresponding to the third line is of type i), but shorter than the initial path. Repeating the procedure for the pairs $X_{\ell-1} Y_{\ell-1}$ and continuing recursively will further reduce equation (D.5) to

$$\begin{aligned} (J_1 X_1 X_2 \cdots (X_\ell)_b^a (Y_\ell)_c^b \cdots Y_2 Y_1 I_1)^i_j = (J_1 X_1 (X_2 Y_2)^{\ell-1} Y_1 I_1)^i_j \\ + (J_1 X_1 (X_2 Y_2)^{\ell-2} Y_1 I_1)^i_j (-(\ell-2)\chi_2 \psi_2 + \chi_3 \psi_3 + \cdots + \chi_\ell \psi_\ell) \\ + (J_1 X_1 (X_2 Y_2)^{\ell-3} Y_1 I_1)^i_j ((\ell-1)(\chi_2 \psi_2 - \chi_3 \psi_3)^2 + \mathcal{O}(\text{fermion bilinears})^2) \\ + \cdots + (J_1 X_1 X_2 Y_2 Y_1 I_1)^i_j (\mathcal{O}(\text{fermion bilinears})^{\ell-1}) . \end{aligned} \quad (\text{D.6})$$

Examining now the generic terms $J_1 X_1 (X_2 Y_2)^n Y_1 I_1$, the 2^{nd} moment map relation will replace $X_2 Y_2$ with $Y_1 X_1 - I_2 J_2$ and the fermion contribution $\chi_1 \psi_1 - \chi_2 \psi_2$, thus leading to linear combinations of products

$$J_1 X_1 (Y_1 X_1)^{k_1} (I_2 J_2)^{l_1} (Y_1 X_1)^{k_2} (I_2 J_2)^{l_2} \cdots (Y_1 X_1)^{k_r} (I_2 J_2)^{l_r} Y_1 I_1 (\chi_1 \psi_1 - \chi_2 \psi_2)^m \quad (\text{D.7})$$

where the k_\bullet , l_\bullet and m exponents sum to n . The 1^{st} moment map relation then replaces all products $X_1 Y_1$ with $I_1 J_1$ and $\chi_0 \psi_0 - \chi_1 \psi_1$ and thereby generates combinations of bosonic fields of the form

$$(J_1 I_1)^{p_1} J_1 X_1 I_2 (J_2 I_2)^{p_2} J_2 Y_1 I_1 (J_2 I_2)^{p_3} J_2 \cdots J_2 Y_1 I_1 \quad (\text{D.8})$$

or

$$(J_1 I_1)^{p_1} J_1 X_1 I_2 (J_2 I_2)^{p_2} J_2 Y_1 I_1 (J_2 I_2)^{p_3} J_2 \cdots J_1 X_1 Y_1 I_1 . \quad (\text{D.9})$$

In the latter case it is necessary to use 1^{st} moment map to replace the final remaining product $X_1 Y_1$, but apart from that, the combinations of bosonic fields that appear are precisely

$$J_1 I_1 , \quad J_1 X_1 I_2 , \quad J_2 Y_1 I_1 , \quad (\text{D.10})$$

which enter the BRST-invariant currents (8.5), and the $U(1)$ -valued current $J_2 I_2$. Considering together the traces of the moment map relations at all of the gauge nodes allows to express $J_2 I_2$ in terms of $\text{Tr}(J_1 I_1)$, showing that it is not an additional independent current.

²²The order of index contractions is shown only for the inner-most products to keep notation light. This carries through to the following equations.

When restricting the quiver depicted in Fig. 16 to have only three gauge nodes, the most simple example of its type, one can also track the fermion bilinear contributions explicitly

$$(J_1 X_1 Y_1 I_1)^i_j = -(G^{(1,1)} G^{(1,1)})^i_j + (G^{(1,1)})^i_j (\chi_0 \psi_0 + \chi_1 \psi_1) - \delta^i_j \chi_0 \psi_0 \chi_1 \psi_1 \quad (\text{D.11})$$

$$\begin{aligned} (J_1 X_1 X_2 Y_2 Y_1 I_1)^i_j &= -(G^{(1,2)} G^{(2,1)})^i_j + ((G^{(1,1)})^3)^i_j + ((G^{(1,1)})^2)^i_j (1 - \chi_0 \psi_0 - \chi_1 \psi_1) \\ &\quad + (G^{(1,1)})^i_j (-(\chi_0 \psi_0)^2 + (\chi_0 \psi_0 - \chi_1 \psi_1)^2 - 4\chi_0 \psi_0 \chi_1 \psi_1 - \chi_0 \psi_0 + \chi_1 \psi_1) \\ &\quad + \delta^i_j \chi_0 \psi_0 (\chi_1 \psi_1 - (\chi_1 \psi_1)^2) . \end{aligned} \quad (\text{D.12})$$

The currents (D.2)-(D.3) of type ii), iii) and iv) are treated analogously to the type i) examples (D.1). The only variation arises when examining the generic terms $J_2(X_2 Y_2)^n Y_1 I_1$, $J_2(X_2 Y_2)^n I_2$ and $J_1 X_1 (X_2 Y_2)^n I_2$, which replace $J_1 X_1 (X_2 Y_2)^n Y_1 I_1$, that led to expressions of the form (D.7). In the type ii) case, the counterpart to (D.8)-(D.9) is

$$J_2 Y_1 I_1 (J_1 I_1)^{p_1} J_1 X_1 I_2 (J_2 I_2)^{l_1} J_2 \cdots J_2 Y_1 I_1 \text{ or } J_2 Y_1 I_1 (J_1 I_1)^{p_1} J_1 X_1 I_2 (J_2 I_2)^{l_1} J_2 \cdots J_1 X_1 Y_1 I_1,$$

for type iii), this becomes

$$J_2 Y_1 I_1 (J_1 I_1)^{p_1} J_1 X_1 I_2 (J_2 I_2)^{l_1} J_2 \cdots J_2 I_2 \text{ or } J_2 Y_1 I_1 (J_1 I_1)^{p_1} J_1 X_1 I_2 (J_2 I_2)^{l_1} J_2 \cdots J_1 X_1 I_2 ,$$

and for type iv),

$$(J_1 I_1)^{p_1} J_1 X_1 I_2 (J_2 I_2)^{l_1} J_2 \cdots J_2 I_2 \text{ or } (J_1 I_1)^{p_1} J_1 X_1 I_2 (J_2 I_2)^{l_1} J_2 \cdots J_1 X_1 I_2 .$$

The basic combinations of bosonic fields that appear are still only those listed in (D.10). In the simple example where the quiver has only three gauge nodes, we thus find

$$(J_2 X_2 Y_2 Y_1 I_1)^1_j = -(G^{(2,1)} G^{(1,1)})^1_j + (G^{(2,1)})^1_j (\chi_2 \psi_2 - J_2 I_2) . \quad (\text{D.13})$$

It follows that generic operators associated to paths of the type (6.20) on the quiver diagram in Fig. 16 are generated by those listed in (D.10) using the moment map relations (8.6) and accounting for fermion bilinear- $\chi\psi$ contributions

- $J_1 I_1$ is the simplest form of (D.1) and enters the definition of $G^{(1,1)}$ (8.16),
- $J_2 Y_1 I_1$ is the simplest form of (D.2) and enters the definition of $G^{(2,1)}$ (8.16),
- $J_1 X_1 I_2$ is the simplest form of (D.4) and enters the definition of $G^{(1,2)}$ (8.16),

with all other operators (D.1)-(D.4) generated from these by relations of the form (D.11), (D.12) and (D.13).

E Criteria for two Virasoro operators coincide

Lemma E.1. *Suppose that T_1 and T_2 are two Virasoro elements in a vertex algebra V , i.e. $T_i, i = 1, 2$ satisfy the OPE*

$$T_i(z)T_i(w) \sim \frac{c_i/2}{(z-w)^4} + \frac{2T_i(w)}{(z-w)^2} + \frac{\partial T_i(w)}{z-w}, \quad c_i \in \mathbb{C}.$$

Assume that $T_1 - T_2$ is in the center of V , then $T_1 = T_2$.

Proof. Since $T_1 - T_2$ is in the center of V , we have $(T_1(z) - T_2(z))T_2(w) \sim 0$, which implies that

$$T_1(z)T_2(w) \sim \frac{c_2/2}{(z-w)^4} + \frac{2T_2(w)}{(z-w)^2} + \frac{\partial T_2(w)}{z-w}.$$

In particular $T_{1,(1)}T_2 = 2T_2$. Then Borcherds identity implies that $T_{2,(1)}T_1 = 2T_2$. However, if we swap $1 \leftrightarrow 2$, we get $T_{2,(1)}T_1 = 2T_1$, thus we must have $T_1 = T_2$. \square

Lemma E.2. *Let $V = \bigoplus_{\Delta \geq 0} V_\Delta$ be a graded vertex algebra (assume $V_0 = \mathbb{C} \cdot |0\rangle$), and assume that the following symmetric pairing $V_1 \otimes V_1 \rightarrow \mathbb{C}$ is non-degenerate:*

$$a \otimes b \mapsto a_{(1)}b.$$

Suppose that T_1 and T_2 are two stress-energy operators in V such that both of them are compatible with the grading, i.e. L_0 of the T_1 and T_2 agree and equal to the grading operator on V . Assume moreover that V_1 is primary with respect to both T_1 and T_2 , then $T_1 = T_2$.

Proof. Since T_1 and T_2 are compatible with the grading, we have $T_1, T_2 \in V_2$. Since T_1 is a stress-energy operator, we have

$$T_1(z)T_2(w) \sim \frac{\lambda}{(z-w)^4} + \frac{a(w)}{(z-w)^3} + \frac{2T_2(w)}{(z-w)^2} + \frac{\partial T_2(w)}{z-w}, \quad \lambda \in \mathbb{C}, a \in V_1.$$

Since T_2 is a stress-energy operator, we have

$$T_2(z)T_1(w) \sim \frac{\lambda'}{(z-w)^4} + \frac{b(w)}{(z-w)^3} + \frac{2T_1(w)}{(z-w)^2} + \frac{\partial T_1(w)}{z-w}, \quad \lambda' \in \mathbb{C}, b \in V_1.$$

Using the Borcherds identity we find $\lambda = \lambda'$, and $a = -b$, and $T_1 = T_2 + \frac{1}{2}\partial a$. Now pick an arbitrary $d \in V_1$, it is primary of weight 1 with respect to both T_1 and T_2 , thus $(T_1(z) - T_2(z))d(w) \sim 0$. On the other hand,

$$(T_1(z) - T_2(z))d(w) = \frac{1}{2}\partial a(z)d(w) \sim \frac{-a_{(1)}d}{(z-w)^3} + \text{lower order poles},$$

thus we must have $a_{(1)}d = 0$ for all $d \in V_1$. It follows from assumption on the nondegeneracy of the pairing $a \otimes d \mapsto a_{(1)}d$ that $a = 0$, whence $T_1 = T_2$. \square

References

- [1] I. Frenkel, J. Lepowsky and A. Meurman, *Vertex operator algebras and the Monster*, vol. 134 of *Pure and Applied Mathematics*. Academic Press, Inc., Boston, MA, 1988.
- [2] V. Kac, *Vertex algebras for beginners*, vol. 10 of *University Lecture Series*. American Mathematical Society, Providence, RI, second ed., 1998.
- [3] E. Frenkel and D. Ben-Zvi, *Vertex algebras and algebraic curves*, vol. 88 of *Mathematical Surveys and Monographs*. American Mathematical Society, Providence, RI, 2001.
- [4] G. W. Moore and N. Seiberg, *Classical and Quantum Conformal Field Theory*, *Commun. Math. Phys.* **123** (1989) 177.

- [5] S. Elitzur, G. W. Moore, A. Schwimmer and N. Seiberg, *Remarks on the Canonical Quantization of the Chern-Simons-Witten Theory*, *Nucl. Phys. B* **326** (1989) 108–134.
- [6] E. Witten, *Quantum Field Theory and the Jones Polynomial*, *Commun. Math. Phys.* **121** (1989) 351–399.
- [7] E. Witten, *Topological Quantum Field Theory*, *Commun. Math. Phys.* **117** (1988) 353.
- [8] K. Costello and D. Gaiotto, *Vertex Operator Algebras and 3d $\mathcal{N} = 4$ gauge theories*, *JHEP* **05** (2019) 018 [[1804.06460](#)].
- [9] D. Gaiotto, *Twisted compactifications of 3d $\mathcal{N} = 4$ theories and conformal blocks*, *JHEP* **02** (2019) 061 [[1611.01528](#)].
- [10] K. Costello, T. Creutzig and D. Gaiotto, *Higgs and Coulomb branches from vertex operator algebras*, *JHEP* **03** (2019) 066 [[1811.03958](#)].
- [11] T. Creutzig, T. Dimofte, N. Garner and N. Geer, *A QFT for non-semisimple TQFT*, [2112.01559](#).
- [12] D. Gang, S. Kim, K. Lee, M. Shim and M. Yamazaki, *Non-unitary TQFTs from 3D $\mathcal{N} = 4$ rank 0 SCFTs*, *JHEP* **08** (2021) 158 [[2103.09283](#)].
- [13] N. Garner, *Twisted Formalism for 3d $\mathcal{N} = 4$ Theories*, [2204.02997](#).
- [14] N. Garner, *Vertex operator algebras and topologically twisted Chern-Simons-matter theories*, *JHEP* **08** (2023) 025 [[2204.02991](#)].
- [15] Y. Yoshida, *Fermionic extensions of W -algebras via 3d $\mathcal{N} = 4$ gauge theories with a boundary*, [2304.03270](#).
- [16] I. Coman, M. Shim, M. Yamazaki and Y. Zhou. *To Appear*.
- [17] T. Arakawa, T. Kuwabara and S. Möller, *Hilbert Schemes of Points in the Plane and Quasi-Lisse Vertex Algebras with $\mathcal{N} = 4$ Symmetry*, *arXiv preprint arXiv:2309.17308* (2023).
- [18] K. A. Intriligator and N. Seiberg, *Mirror symmetry in three-dimensional gauge theories*, *Phys. Lett. B* **387** (1996) 513–519 [[hep-th/9607207](#)].
- [19] M. Blau and G. Thompson, *Aspects of $N(T) \geq 2$ topological gauge theories and D-branes*, *Nucl. Phys. B* **492** (1997) 545–590 [[hep-th/9612143](#)].
- [20] L. Rozansky and E. Witten, *HyperKähler geometry and invariants of three manifolds*, *Selecta Math.* **3** (1997) 401–458 [[hep-th/9612216](#)].
- [21] C. Closset, T. T. Dumitrescu, G. Festuccia and Z. Komargodski, *Supersymmetric Field Theories on Three-Manifolds*, *JHEP* **05** (2013) 017 [[1212.3388](#)].
- [22] M. Aganagic, K. Costello, J. McNamara and C. Vafa, *Topological Chern-Simons/Matter Theories*, [1706.09977](#).
- [23] K. Costello, T. Dimofte and D. Gaiotto, *Boundary Chiral Algebras and Holomorphic Twists*, *Commun. Math. Phys.* **399** (2023), no. 2 1203–1290 [[2005.00083](#)].
- [24] C. Klare, A. Tomasiello and A. Zaffaroni, *Supersymmetry on Curved Spaces and Holography*, *JHEP* **08** (2012) 061 [[1205.1062](#)].
- [25] D. Gaiotto and M. Rapčák, *Vertex Algebras at the Corner*, *JHEP* **01** (2019) 160 [[1703.00982](#)].

- [26] P. Goddard, D. I. Olive and G. Waterson, *Superalgebras, Symplectic Bosons and the Sugawara Construction*, *Commun. Math. Phys.* **112** (1987) 591.
- [27] D. Karabali and H. J. Schnitzer, *BRST Quantization of the Gauged WZW Action and Coset Conformal Field Theories*, *Nucl. Phys. B* **329** (1990) 649–666.
- [28] C. Beem, M. Lemos, P. Liendo, W. Peelaers, L. Rastelli and B. C. van Rees, *Infinite Chiral Symmetry in Four Dimensions*, *Commun. Math. Phys.* **336** (2015), no. 3 1359–1433 [[1312.5344](#)].
- [29] B. L. Feigin, *Semi-infinite homology of Lie, Kac-Moody and Virasoro algebras*, *Uspekhi Mat. Nauk* **39** (1984), no. 2(236) 195–196.
- [30] D. Gaiotto and E. Witten, *S-Duality of Boundary Conditions In $N=4$ Super Yang-Mills Theory*, *Adv. Theor. Math. Phys.* **13** (2009), no. 3 721–896 [[0807.3720](#)].
- [31] H. Nakajima, *Instantons on ALE spaces, quiver varieties, and Kac-Moody algebras*, *Duke Math. J.* **76** (1994), no. 2 365–416.
- [32] H. Nakajima, *Quiver varieties and Kac-Moody algebras*, *Duke Math. J.* **91** (1998), no. 3 515–560.
- [33] T. Nishioka, Y. Tachikawa and M. Yamazaki, *3d Partition Function as Overlap of Wavefunctions*, *JHEP* **08** (2011) 003 [[1105.4390](#)].
- [34] A. Hanany and E. Witten, *Type IIB superstrings, BPS monopoles, and three-dimensional gauge dynamics*, *Nucl. Phys. B* **492** (1997) 152–190 [[hep-th/9611230](#)].
- [35] I. Mirković and M. Vybornov, *Quiver varieties and Beilinson-Drinfeld Grassmannians of type A*, [0712.4160](#).
- [36] A. Braverman, M. Finkelberg and H. Nakajima, *Coulomb branches of 3d $\mathcal{N} = 4$ quiver gauge theories and slices in the affine Grassmannian (with appendices by Alexander Braverman, Michael Finkelberg, Joel Kamnitzer, Ryosuke Kodera, Hiraku Nakajima, Ben Webster, and Alex Weekes)*, *Adv. Theor. Math. Phys.* **23** (2019) 75–166 [[1604.03625](#)].
- [37] A. Braverman, M. Finkelberg and H. Nakajima, *Ring objects in the equivariant derived Satake category arising from Coulomb branches (with an appendix by Gus Lonergan)*, [1706.02112](#).
- [38] I. Mirkovic and M. Vybornov, *Comparison of quiver varieties, loop Grassmannians and nilpotent cones in type A*, *arXiv e-prints* (May, 2019) arXiv:1905.01810 [[1905.01810](#)].
- [39] G. Lusztig, *On quiver varieties*, *Adv. Math.* **136** (1998), no. 1 141–182.
- [40] A. Maffei, *Quiver varieties of type A*, *Comment. Math. Helv.* **80** (2005), no. 1 1–27.
- [41] Y. Yoshida and K. Sugiyama, *Localization of three-dimensional $\mathcal{N} = 2$ supersymmetric theories on $S^1 \times D^2$* , *PTEP* **2020** (2020), no. 11 113B02 [[1409.6713](#)].
- [42] T. Dimofte, D. Gaiotto and N. M. Paquette, *Dual boundary conditions in 3d SCFT's*, *JHEP* **05** (2018) 060 [[1712.07654](#)].
- [43] V. Kac, S.-S. Roan and M. Wakimoto, *Quantum Reduction for Affine Superalgebras*, *Communications in Mathematical Physics* **241** (2003) 307–342.
- [44] V. Kac and M. Wakimoto, *Quantum reduction and representation theory of superconformal algebras*, *Advances in Mathematics* **185** (2004), no. 2 400–458.

- [45] T. Arakawa, *Introduction to W -algebras and their representation theory*, *Perspectives in Lie theory* (2017) 179–250.
- [46] M. Dedushenko, *From VOAs to short star products in SCFT*, *Commun. Math. Phys.* **384** (2021), no. 1 245–277 [[1911.05741](#)].
- [47] M. Ashwinkumar, J.-i. Sakamoto and M. Yamazaki, *Dualities and Discretizations of Integrable Quantum Field Theories from 4d Chern-Simons Theory*, [2309.14412](#).
- [48] T. Arakawa, *A remark on the C_2 -cofiniteness condition on vertex algebras*, *Math. Z.* **270** (2012), no. 1-2 559–575.
- [49] C. Beem and L. Rastelli, *Vertex operator algebras, Higgs branches, and modular differential equations*, *JHEP* **08** (2018) 114 [[1707.07679](#)].
- [50] M. Ueda, *An example of homomorphisms from the quay’s affine yangians to non-rectangular w -algebras*, [2211.14968](#).
- [51] K. Thielemans, *An Algorithmic approach to operator product expansions, W algebras and W strings*. PhD thesis, Leuven U., 1994. [hep-th/9506159](#).
- [52] H. Li, *Vertex algebras and vertex Poisson algebras*, *Communications in Contemporary Mathematics* **6** (2004), no. 01 61–110.
- [53] T. Kuwabara, *Vertex algebras associated with hypertoric varieties*, [1706.02203](#).
- [54] Q. Liu, *Algebraic geometry and arithmetic curves*, vol. 6. Oxford Graduate Texts in Mathe, 2002.
- [55] B. Feigin and E. Frenkel, *Affine Kac-Moody algebras and semi-infinite flag manifolds*, *Communications in mathematical physics* **128** (1990) 161–189.
- [56] P. Bouwknegt, J. McCarthy and K. Pilch, *Quantum group structure in the Fock space resolutions of representations*, *Communications in Mathematical Physics* **131** (1990), no. 1 125–155.
- [57] T. Arakawa and A. Molev, *Explicit generators in rectangular affine W -algebras of type A* , *Letters in Mathematical Physics* **107** (2017), no. 1 47–59.
- [58] L. Eberhardt and T. Procházka, *The matrix-extended $\mathcal{W}_{1+\infty}$ algebra*, *Journal of High Energy Physics* **2019** (2019), no. 12 1–35.
- [59] N. Genra, *Screening operators and parabolic inductions for affine W -algebras*, *Advances in Mathematics* **369** (2020) 107179.
- [60] N. Genra, *Screening operators for W -algebras*, *Selecta Mathematica* **23** (2017), no. 3 2157–2202.
- [61] B. Feigin and A. Semikhatov, $\mathcal{W}_n^{(2)}$ algebras, *Nuclear Physics B* **698** (2004), no. 3 409–449.
- [62] Y. Namikawa, *Poisson deformations of affine symplectic varieties*, *Duke Math. J.* **156** (2011), no. 1 51–85.
- [63] Y. Namikawa, *Poisson deformations of affine symplectic varieties, II*, *Kyoto Journal of Mathematics* **50** (2010), no. 4 727.
- [64] I. Losev, *Deformations of symplectic singularities and Orbit method for semisimple Lie algebras*, *arXiv preprint arXiv:1605.00592* (2016).
- [65] K. McGerty and T. Nevins, *Springer theory for symplectic Galois groups*, *arXiv preprint arXiv:1904.10497* (2019).

- [66] K. McGerty and T. Nevins, *Kirwan surjectivity for quiver varieties*, *Inventiones mathematicae* **212** (2018) 161–187.
- [67] I. Losev, *Isomorphisms of quantizations via quantization of resolutions*, *Advances in Mathematics* **231** (2012), no. 3-4 1216–1270.
- [68] C. Beem, L. Rastelli and B. C. van Rees, *\mathcal{W} symmetry in six dimensions*, *JHEP* **05** (2015) 017 [[1404.1079](#)].
- [69] C. Beem, W. Peelaers, L. Rastelli and B. C. van Rees, *Chiral algebras of class S* , *JHEP* **05** (2015) 020 [[1408.6522](#)].
- [70] D. Gang and D. Kim, *Generalized non-unitary Haagerup-Izumi modular data from 3D S -fold SCFTs*, *JHEP* **03** (2023) 185 [[2211.13561](#)].
- [71] D. Gang, H. Kim and S. Stubbs, *Three-Dimensional Topological Field Theories and Non-Unitary Minimal Models*, [2310.09080](#).
- [72] D. Gang, D. Kim and S. Lee, *A non-unitary bulk-boundary correspondence: Non-unitary Haagerup RCFTs from S -fold SCFTs*, [2310.14877](#).
- [73] A. E. V. Ferrari, N. Garner and H. Kim, *Boundary vertex algebras for 3d $\mathcal{N} = 4$ rank-0 SCFTs*, [2311.05087](#).
- [74] Y. Terashima and M. Yamazaki, *$SL(2, R)$ Chern-Simons, Liouville, and Gauge Theory on Duality Walls*, *JHEP* **08** (2011) 135 [[1103.5748](#)].
- [75] D. Gang, N. Kim, M. Romo and M. Yamazaki, *Aspects of Defects in 3d-3d Correspondence*, *JHEP* **10** (2016) 062 [[1510.05011](#)].
- [76] D. Gang and M. Yamazaki, *Three-dimensional gauge theories with supersymmetry enhancement*, *Phys. Rev. D* **98** (2018), no. 12 121701 [[1806.07714](#)].
- [77] B. Assel and A. Tomasiello, *Holographic duals of 3d S -fold CFTs*, *JHEP* **06** (2018) 019 [[1804.06419](#)].
- [78] W. Li and M. Yamazaki, *Quiver Yangian from Crystal Melting*, *JHEP* **11** (2020) 035 [[2003.08909](#)].
- [79] D. Galakhov and M. Yamazaki, *Quiver Yangian and Supersymmetric Quantum Mechanics*, *Commun. Math. Phys.* **396** (2022), no. 2 713–785 [[2008.07006](#)].
- [80] D. Galakhov, W. Li and M. Yamazaki, *Shifted quiver Yangians and representations from BPS crystals*, *JHEP* **08** (2021) 146 [[2106.01230](#)].
- [81] T. Kimura and V. Pestun, *Quiver W -algebras*, *Lett. Math. Phys.* **108** (2018), no. 6 1351–1381 [[1512.08533](#)].