

# The bridge number of satellite knots, links, and spatial graphs in the 3-sphere and lens spaces

Scott A. Taylor, Maggy Tomova

January 4, 2024

## Abstract

Let  $T$  be a satellite knot, link, or spatial graph in a 3-manifold  $M$  that is either  $S^3$  or a lens space. Let  $b_0$  and  $b_1$  denote genus 0 and genus 1 bridge number, respectively. Suppose that  $T$  has a companion knot  $K$  and wrapping number  $\omega$  with respect to  $K$ . When  $K$  is not a torus knot, we show that  $b_1(T) \geq \omega b_1(K)$ . There are previously known counter-examples if  $K$  is a torus knot. Along the way, we generalize and give a new proof of Schubert's result that  $b_0(T) \geq \omega b_0(K)$ . We also prove versions of the theorem applicable to when  $T$  is a "lensed satellite" or when there is a torus separating components of  $T$ .

## Contents

<b>1</b>	<b>Introduction</b>	<b>3</b>
1.1	Comparisons and Consequences . . . . .	4
1.2	Overview of the methods . . . . .	5
1.3	Acknowledgements . . . . .	9
<b>2</b>	<b>Notation and Definitions</b>	<b>9</b>
2.1	Weights . . . . .	10
2.2	Sums . . . . .	11
2.3	Satellites and Lensed Satellites . . . . .	13
<b>3</b>	<b>Multiple bridge surfaces and their invariants</b>	<b>13</b>
3.1	Compressionbodies . . . . .	13
3.2	Multiple bridge surfaces . . . . .	15
3.3	Invariants . . . . .	17
3.4	Lower bounds on net weight . . . . .	17
3.5	Net weight and net genus one multiple bridge surfaces . . . . .	20
<b>4</b>	<b>Thinning</b>	<b>22</b>
4.1	Weak reduction and consolidation . . . . .	22

4.2 Amalgamation . . . . .	27
<b>5 Simple Cases</b>	<b>28</b>
<b>6 Crushing</b>	<b>31</b>
<b>7 Annuli in VPCs</b>	<b>37</b>
<b>8 <math>Q</math>-thinning and Subsurface Amalgamation</b>	<b>39</b>
8.1 $Q$ -thinning . . . . .	39
8.2 Subsurface Amalgamation . . . . .	40
<b>9 Matched Pairs</b>	<b>44</b>
<b>10 Eliminating Matched Pairs</b>	<b>46</b>
<b>11 Tubes and Spools</b>	<b>51</b>
<b>12 Concluding Arguments for <math>S^3</math> and Lens Spaces</b>	<b>57</b>

# 1 Introduction

In the mid-1950s, Horst Schubert introduced two ideas which turned out to have lasting impact in knot theory: satellite knots [35] and (genus 0) bridge number  $\mathfrak{b}_0$  [36]. Satellite knots are those knots which are tied in the shape of other knots; we define them in Section 2.3. Bridge number is an invariant for knots and links in the 3-sphere  $S^3$ . Bridge number has several equivalent definitions. Generalizing slightly to consider not just knots and links but also spatial graphs  $T \subset S^3$ , for the purposes of this paper, we define it as follows.

**Definition 1.1.** Suppose  $T \subset S^3$  is a spatial graph (possibly a knot or link). A **bridge sphere** for  $T$  is a (tame) 2-sphere  $H \subset S^3$  transverse to  $T$  and dividing  $T$  into two acyclic subgraphs each isotopic relative to its endpoints into  $H$ . (See Figure 1 for an example.) The **genus zero bridge number**  $\mathfrak{b}_0(T)$  of a spatial graph (possibly a knot or link)  $T$  in  $S^3$  is the minimum of  $|H \cap T|/2$  over all bridge spheres  $H$  for  $T$ .

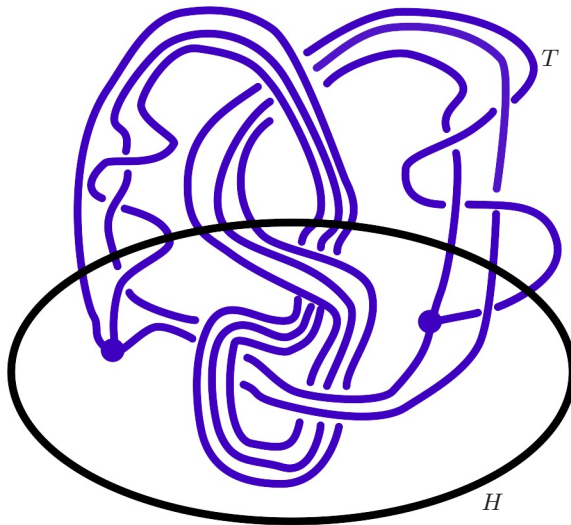

Figure 1: The black ellipse represents a sphere  $H \subset S^3$  dividing the spatial graph  $T$  into two acyclic graphs, each parallel into  $H$ . Such a sphere is a bridge sphere. In this example, the spatial graph is a satellite graph with companion a figure-eight knot  $K$ .  $T$  has wrapping number 2 with respect to  $K$ .

Schubert famously showed:

**Theorem** (Schubert). *For a knot  $T \subset S^3$ :*

- (Additivity Theorem) *If  $T = T_0 \# T_1$  is **composite**, then  $\mathfrak{b}_0(T) = \mathfrak{b}_0(T_0) + \mathfrak{b}_0(T_1) - 1$ , and*
- (Satellite Theorem) *If  $T$  is a satellite knot with companion  $K$  and wrapping number  $\omega$  with respect to that companion, then  $\mathfrak{b}_0(T) \geq \omega \mathfrak{b}_0(K)$ .*

Subsequently,  $\mathfrak{b}_0$  has been connected to numerous topological, geometric, combinatorial, and algebraic knot invariants [1, 4, 5, 7, 11, 23, 25, 27, 30, 50]. Schultens has written a brief surveys [40, 41] on bridge number and satellite knots. She also has particularly elegant proofs [38, 39] of Schubert's results. Her work provided some of the intuition for our methods.

To what extent do Schubert's results hold for knots in other 3-manifolds? The most natural next class of 3-manifolds to consider are the lens spaces, introduced by Tietze in 1908 [18]. They are the 3-manifolds having genus 1 Heegaard splittings (although, as is common, we exclude  $S^3$  and  $S^1 \times S^2$ ). In 1992, Doll [10]

introduced the higher genus bridge numbers  $\mathfrak{b}_g$ . Knots  $K$  in  $S^3$  or a lens space with  $\mathfrak{b}_1(K) = 1$  in particular, have attracted significant interest [2, 3, 9, 12, 13, 15, 19]. Doll himself proved a version of Schubert’s Additivity Theorem that applies to lens spaces, however he discovered certain complications. In Section 5, we state and prove the most natural version of this theorem for lens spaces.

Primarily, however, we are concerned with extending Schubert’s Satellite Theorem to *genus one* bridge number  $\mathfrak{b}_1$  for knots, links, and spatial graphs in  $S^3$  and lens spaces (other than  $S^1 \times S^2$ ). In addition to establishing an inequality for traditional satellite knots (those contained in a solid torus), we can also establish an inequality for “lensed satellite knots” (those contained in the connected sum of a solid torus and a lens space).

We prove

**Theorem 1.2** (Main Theorem). *Suppose that  $M \neq S^1 \times S^2$  is either  $S^3$  or a lens space, and that  $T \subset M$  is a satellite knot, link, or spatial graph with companion knot  $K$ , which we assume to be not an unknot, torus knot or core loop, and wrapping number  $\omega$  with respect to  $K$ . Then*

$$\mathfrak{b}_1(T) \geq \omega \mathfrak{b}_1(K).$$

*If  $T$  is instead a lensed satellite, then  $\mathfrak{b}_1(T) \geq \omega(\mathfrak{b}_1(K) - 1)$ .*

The possibility that the companion knot  $K$  is a torus knot cannot be dropped; there are satellite knots  $T$  in  $S^3$  with  $\mathfrak{b}_1(T) = 1$  [17, 20]. For such knots, Morimoto and Sakuma [26] showed that the companion knot  $K$  is a torus knot. See [29] for further discussion.

Our proof is split into two portions; a good portion of each applies much more widely than just in the context of the Main Theorem. In particular, in Corollary 6.12, we give a new proof of Schubert’s Satellite Theorem for  $\mathfrak{b}_0$ , one that applies to spatial graphs, as well as to links with essential tori in their exteriors. (We note, however, that extending Schubert’s Satellite Theorem, to toroidal links requires some care. See Example 2.7 below.) Once the machinery is developed, our proof is significantly less involved than Schulten’s (already very nice) proof. One additional feature of our work is that the proofs are algorithmic in nature and can likely be translated into *bona fide* algorithms for positioning a companion torus nicely with respect to a knot in minimal bridge position.

Finally, we remark that in [42], we introduced an invariant we called *net extent*. It provides a lower bound on bridge number (with regard to any genus) and has very nice additivity properties. We make some minor modifications to its definition in this paper and use its additivity properties to create new techniques for studying the relationship of essential surfaces to bridge surfaces.

## 1.1 Comparisons and Consequences

The **Main Theorem** provides an interesting contrast to a theorem of Baker [2] who shows that “small genus knots in lens spaces have small bridge number”. For Baker, “small genus” means that the (generalized) Seifert genus of the knot  $T$  is at most  $(s + 1)/4$ , where  $s$  is order of the element of the fundamental group of the lens space represented by the knot. Baker shows that a small genus knot has  $\mathfrak{b}_1(T) \leq 1$ . The Whitehead double  $T$  of a knot  $K$  is a particular type of satellite knot with companion  $K$ . All Whitehead doubles have Seifert genus equal to 1, are homotopically trivial, and have wrapping number  $\omega = 2$ . Our theorem shows that  $\mathfrak{b}_1(T) \geq 2\mathfrak{b}_1(K)$ .

For any  $g$ , it is the case that  $\mathfrak{b}_g(K) = 0$  if and only if  $g$  is at least the Heegaard genus of the exterior of  $K$ . Suppose that  $T$  is a satellite knot with companion  $K$  and wrapping number  $\omega$ . If  $\mathfrak{b}_g(T) \geq \omega \mathfrak{b}_g(K)$  for  $g = g(S^3 \setminus T)$ , one would conclude that the tunnel number  $t(T)$  (which is one less than the Heegaard genus of the knot exterior) of  $T$  is at least  $t(K)$ . Schirmer [34] showed that this is true when the wrapping number is 1; that is, for composite knots. Wang and Zou [48] showed that the tunnel number of a cable knot is

at least the tunnel number of its companion. Li [24] has shown that  $t(T)$  is at least that of its pattern; however, it seems to be an open problem whether or not it is at least that of the companion  $K$ . Our work points towards some of the difficulties of proving this and the existence of counter-examples to Schubert's inequality when  $g = 1$  perhaps indicates some skepticism is in order.

Eudave-Muñoz studied incompressible surfaces  $Q$  in the the complement of knots  $T \subset S^3$  with  $\mathfrak{b}_1(T) = 2$  [14]. Although most of his work concerns the situation when  $Q$  is a genus 2 surface, he does address the situation when  $Q$  is a torus as well. Our work recovers the following:

**Corollary 1.3** (Eudave-Muñoz). *Suppose that  $T \subset S^3$  is a satellite knot with companion  $K$  and wrapping number  $\omega \geq 2$ . If  $\mathfrak{b}_1(T) = 2$ , then  $\omega = 2$  and  $\mathfrak{b}_1(K) = 1$ , that is  $K$  is a  $(1,1)$  knot.*

*Proof.* By our [Main Theorem](#),  $2 = \mathfrak{b}_1(T) \geq \omega \mathfrak{b}_1(K) \geq 2\mathfrak{b}_1(K)$ . Thus,  $\mathfrak{b}_1(K) \leq 1$ . If  $\mathfrak{b}_1(K) = 0$ , then  $K$  is the unknot, contradicting the definition of satellite knot. Thus,  $\mathfrak{b}_1(K) = 1$  (and so is a  $(1,1)$ -knot) and  $\omega = 2$ .  $\square$

The next two corollaries of our [Main Theorem](#) are modelled on theorems of Schubert concerning genus 0 bridge number.

**Corollary 1.4.** *If  $K$  is a nontrivial, nontorus, noncore knot in  $S^3$  or a lens space, and if  $T$  is an  $n^{\text{th}}$  iterated, possibly twisted, Whitehead double of  $K$ , then  $\mathfrak{b}_1(T) = 2^n \mathfrak{b}_1(K)$ .*

*Proof.* Suppose that  $L$  is an  $n^{\text{th}}$  iterated, possibly twisted, Whitehead double of  $K$ . We can construct the exterior of  $L$  by gluing the exterior of  $K$  to  $n$  copies of the exterior of the Whitehead link. As the Whitehead link is hyperbolic [46], its exterior is anannular. Thus, as the exterior of  $K$  is anannular, so is the exterior of any  $(n - 1)^{\text{st}}$  iterated twisted Whitehead double of  $K$ . The fact that  $\mathfrak{b}_1(L) \geq 2^n \mathfrak{b}_1(K)$  follows by induction from our [Main Theorem](#).

To show the other inequality, suppose that  $K'$  is a knot in minimal bridge position with respect to a Heegaard torus  $H$  such that  $\mathfrak{b}_1(K') \geq 1$  (i.e.  $K'$  is not a core of one of the solid tori on either side of  $H$ .) This is depicted in Figure 2. Let  $V$  be a regular neighborhood of  $K'$  and let  $V_0$  be a component of  $V \setminus H$ . Inside  $V_0$  place two clasped arcs as in the top left of Figure 2. Inside all other components of  $V \setminus H$  place two arcs as in the top right of Figure 2. Of course, arrange the endpoints of the arcs so that they glue up to be a knot. Twist around a component of  $\partial V \cap H$  as desired to create a twisted Whitehead double  $K''$ . It is straightforward to see that  $H$  is a bridge surface for  $K''$ . Hence,  $\mathfrak{b}_1(K'') \leq 2\mathfrak{b}_1(K')$ . Our result follows by induction on the number of iterates.  $\square$

The proof of the next corollary is similar and is left as an exercise.

**Corollary 1.5.** *Suppose that  $T$  is a  $(p, q)$  cable of a nontrivial, nontorus knot  $K$  in  $S^3$  or a lens space with  $q < p$ . Then*

$$\mathfrak{b}_1(T) = q\mathfrak{b}_1(K).$$

**Remark 1.6.** Using different methods, Zupan [52] determines  $\mathfrak{b}_g(T)$  for many iterated cables of torus knots.

## 1.2 Overview of the methods

We start by giving an overview of our approach, giving some indication of how the methods can be applied more widely.

In approaching the problem of determining lower bounds for  $\mathfrak{b}_g(T)$  for a satellite knot  $T$ , a natural approach is as follows: Put  $T$  into minimal bridge position with respect to a genus  $g$  Heegaard surface  $H$ . Without changing the fact that  $T$  is in minimal bridge position, perform an isotopy so that the solid torus  $V$  containing

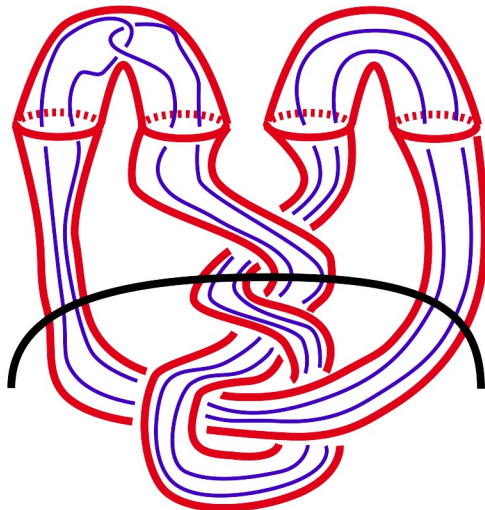

Figure 2: A schematic depiction of finding the bridge number of a Whitehead double. The companion knot is put in bridge position and then the Whitehead double is placed inside a regular neighborhood. Since it is easier to show, the figure in actuality depicts the example when the companion is a figure eight knot and the bridge surface (in black) is a sphere, but the principle is the same for when the bridge surface is a torus.

$T$  intersects the bridge surface  $H$  in a pairwise disjoint collection of discs. Using the fact that the bridge surface divides  $T$  into two trivial tangles, it is easily seen that it divides  $Q = \partial V$  into annuli having the property that any simple closed curve on  $Q$  intersecting each annulus in a spanning arc is a companion knot  $K$  for  $T$ . As each disc must intersect  $T$  at least  $\omega$  (the wrapping number) times,  $\mathfrak{b}_g(T) \geq \omega \mathfrak{b}_g(K)$ . (See, for example, [6, 52].) The tricky step is moving  $Q$  to the right position.

In her proof of Schubert’s theorem for  $\mathfrak{b}_0$ , Schultens studies the saddles on  $Q$  arising from a foliation on  $Q$  induced by a Heegaard sphere. She shows that  $T$  and  $Q$  can be isotoped so that inessential saddles can be canceled with center singularities. Once all inessential saddles have been eliminated, it is easy to construct a minimal bridge sphere  $H$  for  $T$  so that  $V \cap H$  consists of disjoint discs.

For our proof, rather than analyzing a foliation of  $Q$ , we analyze the bridge surface. In fact, we make significant use of a technique called thin position, where the given bridge surface  $H$  is decomposed into the union of thick and thin surfaces. This technique applies to higher genus bridge surfaces as well. The union of these thick surfaces  $\mathcal{H}^+$  and thin surfaces  $\mathcal{H}^-$  is a “multiple bridge surface”  $\mathcal{H}$ . These are generalizations of bridge surfaces and are a knot-theoretic version of Scharlemann and Thompson’s *generalized Heegaard surfaces*. We define them in Section 3. There is a partial order on these multiple bridge surfaces and the minimal elements in the partial order have very nice properties; in particular, in [44] we showed that the thin surfaces exhibit a prime decomposition for the pair  $(M, T)$ . In [42], we used this to define new additive invariants for knots, links, and spatial graphs. In [45], we used it to study tunnel numbers of genus two spatial graphs and in [43], Taylor used it to study equivariant Heegaard genus.

As we discuss in Section 4.2, a multiple bridge surface  $\mathcal{H}$ , when we ignore  $T$ , can be amalgamated to a Heegaard surface  $H$  of genus  $g$ . We also call  $g$  the *net genus* of  $\mathcal{H}$ . In the case when  $T$  is a knot and  $g \in \{0, 1\}$ , the amalgamation can be done so that  $H$  is a genus  $g$  bridge surface for  $M$ . If  $g \geq 2$ , this may not be possible. If  $g = 0$  and  $\partial M = \emptyset$ ,  $M$  is necessarily  $S^3$ ; when  $g = 1$  and  $\partial M = \emptyset$ ,  $M$  is necessarily  $S^3$  or a lens space. This is one reason (but not the only one) why our [Main Theorem](#) concerns  $\mathfrak{b}_0$  and  $\mathfrak{b}_1$ , rather than  $\mathfrak{b}_g$  for  $g \geq 2$ .

We also define the *net weight* of a multiple bridge surface  $\mathcal{H}$  to be  $\text{net } w(\mathcal{H}) = |\mathcal{H}^+ \cap T| - |\mathcal{H}^- \cap T|$ . When  $\mathcal{H}$

is a bridge surface (i.e. has a single thick surface and no thin surfaces), net  $w(\mathcal{H})$  is equal to twice its bridge number. We can turn net weight into a knot invariant net  $w_g(T)$  by minimizing over all multiple bridge surfaces for  $T$  of net genus  $g$ . Details concerning both the net genus and the net weight are given in Section 3.3.

As we explain in Section 4, for any  $g \geq 0$ , we find a “locally thin” multiple bridge surface  $\mathcal{H}$  of net genus  $g$  and net weight net  $w(\mathcal{H}) = 2\mathfrak{b}_g(\mathcal{H})$ . Such surfaces have a number of very nice properties, including the fact that (in most cases) they can be isotoped so that the intersection with  $\mathcal{H}$  of *any* given “c-essential” surface  $Q$  transverse to  $T$  will consist of simple closed curves essential on both surfaces. When  $Q$  is a torus (the main subject of this paper), either  $Q$  is disjoint from  $\mathcal{H}$  or  $Q \setminus \mathcal{H}$  is the union of annuli. As discussed above, if these annuli all have ends that bound disjoint discs in  $\mathcal{H}$ , then it is possible to derive an inequality between the net weight of  $\mathcal{H}$  with respect to  $T$  and the net weight of  $\mathcal{H}$  with respect to any simple closed curve  $K$  on  $Q$  intersecting the boundaries of those discs exactly once each (for example, the companion knot). However, there is no *a priori* reason that  $Q$  should be positioned in such a way and for  $g \geq 1$  it seems extremely difficult, potentially impossible, to ensure that it can be done without the addition of unreasonable assumptions on  $T$  or  $K$ . We proceed instead as follows.

Our proof is divided into three parts. For simplicity, in this overview, we will assume that  $Q$  is an essential separating torus in  $M$  containing  $T$  to one side  $V$ , which is a solid torus with core  $K$ , although throughout the paper we do allow  $Q$  to separate components of  $T$  and some of our arguments allow  $Q$  to be of higher genus or have punctures. First (Section 5), we address various “reducible” situations: when there is a sphere intersecting  $T$  in two or fewer points and separating  $T$  into two nontrivial pieces. Dealing with these cases separately allows for the main arguments to be somewhat less involved. This includes the situation when the wrapping number  $\omega = 1$ , for in that case the torus  $Q$  is not c-essential; it can be compressed to an essential twice-punctured sphere. In particular, if  $\omega = 1$ , then Schubert’s Satellite Theorem follows from his Additivity Theorem. We use this observation as starting point for our work.

In the second part of our discussion (Section 6), we show that by passing from knots to spatial graphs we do not need to arrange for *all* components of  $Q \cap \mathcal{H}$  to bound disjoint discs in  $V \cap \mathcal{H}$ . It is (nearly) enough to find a *single* annulus component of  $Q \setminus \mathcal{H}$  whose ends bound disjoint discs and which, in the absence of  $T$ , has a compressing disc (necessarily in  $V$ ) disjoint from the rest of  $Q$ . We call such an annulus a *crushable handle*. When there is a crushable handle  $A$ , we convert  $T$  into a spatial graph  $\widehat{T}$  as in Figure 7 by crushing the portion of  $T$  inside the annulus to a single edge. We weight that edge  $e$  according to the wrapping number  $\omega$ . The torus  $Q$  then compresses to a twice-punctured annulus  $\widehat{Q}$  and the graph  $\widehat{T}$  is the connected sum of a certain graph with a companion knot  $K$ . The knot  $K$  is, in effect, the edge  $e$  and so it has weight  $\omega$ . In previous work [44], we showed that a multiple bridge surface for a composite spatial graph can be thinned to a multiple bridge surface realizing a prime decomposition (technically, an *efficient decomposition*) for the spatial graph. In Section 4, we repurpose those techniques, taking into account the edge weights and making a few other minor adjustments. The locally thin multiple bridge surface  $\mathcal{H}$  then realizes the graph  $\widehat{T}$  as a connected sum  $K \# T_1$  where  $K$  has weight  $\omega$ , so all of its punctures are counted with that weight. A relatively brief, but somewhat intricate argument, allows us to drop the  $T_1$  factor without increasing net weight, arriving at the inequality:

$$\mathfrak{b}_g(T) \geq \omega \text{net } w_g(K)/2.$$

(See Theorem 6.9 for the full statement.) This is enough to reprove Schubert’s Additivity Theorem. We do that in Corollary 6.12.

The third step, which occupies the remainder of the paper, is devoted to finding a crushable handle. The annuli of  $Q \setminus \mathcal{H}$  are all either bridge annuli (annuli having both ends on the same thick surface) or vertical annuli (annuli having one end on a thick surface and one end on a thin surface). The bridge annuli are all  $\partial$ -compressible in  $(M, T) \setminus \mathcal{H}$  and we sort them into two disjoint types: curved and nested according to the side on which a  $\partial$ -compressing disc lies. A curved annulus and a nested annulus form a *matched pair* if they are separated in  $Q$  only by vertical annuli. Inspired by Schulten’s work where bridge positions are rearranged in order to cancel handles on  $Q$ , we use techniques stemming from Heegaard splitting theory to show that

in many cases we can cancel matched pairs. When  $g = 1$ , we can cancel enough matched pairs to show that either there is a crushable handle, or  $Q$  takes a very particular form, implying that the companion knot  $K$  is a torus knot.

Below is the overall structure of the paper. Much of our work applies in far greater generality than to satellite graphs in lens spaces, so we introduce hypotheses only as needed. Readers well versed in thin position techniques, could easily skim Sections 3 and 4.

1. Section 2 establishes notation and definitions, some classical and some new.
2. Section 3 summarizes previous work concerning “multiple bridge surfaces”  $\mathcal{H}$  and defines some invariants for them. These are surfaces that are the union of “thin surfaces”  $\mathcal{H}^-$  and “thick surfaces”  $\mathcal{H}^+$ . For most of this section, we assume only that  $(M, T)$  is *standard*; the definition is given in Convention 2.1.
3. Section 4 explains the process of thinning a bridge surface to create a multiple bridge surface. Thinning is a partial order on the set of multiple bridge surfaces; minimal elements are said to be “locally thin.” We establish some lower bounds on the invariants and elucidate the structure of these surfaces when our 3-manifold is either  $S^3$  or a lens space and the “net genus” of these surfaces is 0 or 1. We show that in most cases, a locally thin multiple bridge surface can be made to intersect a c-essential surface in curves that are essential in both surfaces. Also important is Section 4.2, which shows how a multiple bridge surface can sometimes be *amalgamated* back into a bridge surface.  
For most of this section, we assume only that  $(M, T)$  is *standard*.
4. Section 5 discusses some trivial cases which serve as a model of our general approach and are used later to eliminate certain annoyances. We give new proofs of Schubert’s and Doll’s Additivity Theorems, as well as our Main Theorem in the case when  $\omega = 1$ . For most of this section, we assume only that  $(M, T)$  is *standard*.
5. In Section 6 we explain the operation of crushing a handle and prove the properties of objects after crushing. We prove that if there is a crushable handle, then the conclusion of the [Main Theorem](#) holds. We use this to give a new proof of Schubert’s Satellite Theorem (for genus zero bridge number). In this section, we assume that  $(M, T)$  is standard and irreducible and that  $Q \subset (M, T)$  is a c-essential separating torus. The remainder of the paper is devoted to finding a crushable handle.
6. Annuli and how they are embedded in various 3-manifolds play a very important role in our work. We give some definitions and basic properties of annuli in Section 7. In this section, we assume only that  $(M, T)$  is standard.
7. In Section 8 we adapt the operations of thinning and amalgamation to a setting where only certain parts of surfaces are considered. The goal is to ensure that thinning and amalgamation work nicely with respect to  $Q$ . We assume only that  $(M, T)$  is standard and that  $Q$  is c-essential and separating; it need not be a torus.
8. Section 9 considers two types of annulus components of  $Q \setminus \mathcal{H}$ , called “curved” and “nested”. A curved annulus and a nested annulus separated in  $Q$  by vertical annuli are said to be a “matched pair.” This section develops some basic properties of matched pairs. We assume that  $(M, T)$  is standard. Although, in principle, the techniques can be applied to any closed, non-separating c-essential surface  $Q$ , most of our results require additional hypotheses on  $Q$ , for instance requiring it to be an unpunctured torus or four-punctured sphere.
9. Section 10 defines the notion of a *cancellable* matched pair. This is similar in spirit to how certain handles can be cancelled in handle theory. This section uses the results of the previous two sections to show how a sequence of amalgamations and thinning operations can be used to eliminate a cancellable



matched pair. We assume that  $(M, T)$  is standard and irreducible and that  $Q$  is a c-essential separating torus or four-punctured sphere.

10. Section 11 considers the structure that  $Q$  can take when there are no matched pairs. In particular, we consider certain annuli known as *tubes* and define a certain surface, called a *spool*, whose existence causes spiraling in  $Q$ . Throughout we assume that  $(M, T)$  is standard and that every closed surface in  $M$  is separating.  $Q$  can be any c-essential separating surface.
11. Section 12 contains the concluding arguments for the [Main Theorem](#). Throughout we assume that  $(M, T)$  is standard and irreducible, that  $M$  is  $S^3$  or a lens space, and that  $Q$  is a c-essential torus. We also consider only multiple bridge surfaces  $\mathcal{H}$  with *net genus* equal to 1. We assume that  $Q$  does not contain a cancellable matched pair (which we can do by the results in Section 10) and show that it does not contain any matched pair. The results of Section 11 allow us to either find a crushable handle or discover that the companion knot  $K$  is a torus knot. We conclude by giving the proof of the [Main Theorem](#) when  $\omega \geq 2$ ; the case when  $\omega = 1$  already having been done in Section 5.

### 1.3 Acknowledgements

Taylor is partially supported by a Colby College Research Grant and NSF Grant DMS-2104022. Tomova is partially supported by NSF Grant DMS-2104026. We are grateful to Ken Baker for several very useful conversations over the course of this project.

## 2 Notation and Definitions

All surfaces and 3-manifolds we consider are compact and orientable. Throughout this paper,  $(M, T)$  will denote a pair where  $M$  is a 3-manifold and  $T \subset M$  is a properly embedded finite graph. The graph  $T$  may be disconnected and may have components that are closed loops. In particular,  $T$  may contain components that are knots or itself be a knot or a link. We adopt the following convention throughout the paper:

**Convention 2.1.**  *$M$  is a compact, connected, orientable, 3-manifold without spherical boundary components and  $T \subset M$  is a properly embedded finite graph without vertices of degree 2. We insist that every sphere in  $M$  is separating. We call  $(M, T)$  a **standard** (3-manifold, graph) pair. For a standard 3-manifold graph pair  $(M, T)$ , we let  $(\hat{M}, \hat{T})$  denote the result of removing a regular neighborhood of each vertex of  $T$  having degree at least 3 from both  $M$  and  $T$ ; i.e. we convert vertices into spherical boundary components.  $M$  is a **lens space** if it has Heegaard genus 1 and is not  $S^1 \times S^2$  or  $S^3$ .*

To justify the convention, observe that if  $S \subset \partial M$  is a sphere that does not contain exactly one endpoint of  $T$ , we may attach a 3-ball to  $S$  containing a  $\partial$ -parallel graph that is the cone on the points  $|S \cap T|$  and thereby convert  $S$  into a vertex of the graph. In the case when  $|S \cap T| = 2$ , we are attaching a 3-ball containing a single unknotted arc. Conversely, if  $v$  is a vertex of the graph that has degree at least 2, we may remove a regular neighborhood of  $v$ , thereby converting  $v$  into a spherical boundary component. Finally, if  $v$  is a vertex of  $T$  of degree 2, we may merge the endpoints of the edges incident to  $v$  and thereby absorb  $v$  into an edge or loop of the graph.

We will use  $\eta()$  to denote a regular open neighborhood. If  $X$  is a space, we let  $Y \sqsubset X$  mean that  $Y$  is a (path) component of  $X$ . The Heegaard genus of a 3-manifold  $M$  is denoted  $g(M)$ .

If  $S$  is surface in  $M$ , we write  $S \subset (M, T)$  to mean that  $S$  is a submanifold of  $M$  and is transverse to  $T$ , possibly a component of  $\partial M$ . We call the points  $S \cap T$  **punctures** on  $S$ . All isotopies of a surface  $S \subset (M, T)$  are transverse to  $T$ . An **end** of an annulus  $A$  is a component of  $\partial A$ . The genus of  $S$  is denoted  $g(S)$  and its Euler characteristic is  $\chi(S)$ . The genus of a disconnected surface is the sum of the genera of its components.

If  $S \subset (M, T)$  is a surface, we let  $(M, T) \setminus S = (M \setminus \eta(S), T \setminus \eta(S))$  be the result of removing an open regular neighborhood of  $S$  from both  $M$  and  $T$ . Since  $S$  and  $M$  are orientable,  $(M, T) \setminus S$  inherits two copies of  $S$  in its boundary; these are the **scars** corresponding to  $S$ . If  $S \subset (M, T)$  is the union of pairwise disjoint spheres, none of which intersects  $T$  exactly once, we can cap off each of the scars in  $(M, T) \setminus S$  corresponding to  $S$  with 3-balls containing  $\partial$ -parallel spatial graphs each of which is the cone on the points of intersection between a component of  $S$  and  $T$ . We denote the result by  $(M, T)|_S$  and say that we have **surgered**  $(M, T)$  along  $S$ . Similarly, if  $D \subset (M, T)$  is a disc, we say that  $(M, T)|_D = (M, T) \setminus \eta(D)$  is the result of  **$\partial$ -reducing**  $(M, T)$  along  $D$ . If  $S \subset (M, T)$  and if  $D$  is a disc with  $\partial D \subset S$ , then the surface  $S|_D$  obtained by pasting in parallel copies of  $D$  to the scars of  $\partial D$  in  $S \setminus \eta(\partial D)$  is the result of **compressing**  $S$  along  $D$ . We will usually apply this construction when  $|D \cap T| \in \{0, 1\}$ .

A simple closed curve  $\gamma \subset S$  disjoint from  $T \cap S$  is **essential** if it does not bound a disc or a once-punctured disc in  $S$ . Suppose that  $D \subset (M, T)$  is an embedded disc with  $\partial D \subset S$  disjoint from  $S \cap T$  and the interior of  $D$  is disjoint from  $S$ . Assume also that  $|D \cap T| \leq 1$ . If  $\partial D$  is essential in  $S$ , we say that  $D$  is a **compressing disc** if  $|D \cap T| = 0$  and a **cut disc** if  $|D \cap T| = 1$ . If  $\partial D$  is inessential, but  $D$  is not parallel to a disc in  $S$  by an isotopy transverse to  $T$ , then  $D$  is a **semi-compressing disc** if  $|D \cap T| = 0$  and a **semi-cut disc** if  $|D \cap T| = 1$ . An **sc-disc** is any of these four types of discs.

If  $S \subset (M, T)$  has no compressing discs, it is **incompressible**, if it has no c-discs, it is **c-incompressible**. If  $S$  is incompressible;  $S \setminus \eta(T)$  is not  $\partial$ -parallel in  $M \setminus \eta(T)$ ; and  $S$  is not a 2-sphere bounding a 3-ball disjoint from  $T$ , then  $S$  is **essential**. If  $S$  is essential and is also c-incompressible, then it is **c-essential**. If  $S$  admits c-discs  $D_1$  and  $D_2$  on opposite sides with disjoint boundaries, then  $S$  is **c-weakly reducible**, otherwise it is **c-strongly irreducible**.

We say that  $(M, T)$  is **0-irreducible** if every sphere in  $M \setminus T$  bounds a 3-ball in  $M \setminus T$ . We say it is **1-irreducible** if there is no sphere in  $M$  intersecting an edge of  $T$  exactly once and **2-irreducible** if there is no essential twice-punctured sphere in  $(M, T)$ . We say that  $(M, T)$  is **irreducible** if it is 0-irreducible and 1-irreducible. (This terminology is modelled on terminology from Heegaard splittings.)

**Convention 2.2.** *For much of the paper (though not its entirety),  $Q \subset (M, T)$  will be a separating surface with one component  $V$  of  $M \setminus Q$  designated as the inside of  $Q$  and the other the outside. If  $X \subset Q$  and if  $P$  is a submanifold (of any dimension) of  $M$  such that there is a nonempty neighborhood of  $X \cap P$  in  $P$  that is on the inside (resp. outside) of  $Q$ , then  $P$  is **inside** (resp. **outside**)  $X$ . For example, if  $S \subset (M, T)$  is a surface and a loop  $\gamma \sqsubset S \cap Q$  separates  $S$  into two subsurfaces  $S_1$  and  $S_2$ , then one of  $S_1$  and  $S_2$  is inside  $\gamma$  and the other is outside  $\gamma$  although both may contain other intersections with  $Q$ .*

## 2.1 Weights

We will have occasion to consider graphs  $T$  with weighted edges.

**Definition 2.3.** A positive integer-valued function on the edges and loops of  $T$  is a **weight system** on  $T$ . A spatial graph  $T$  is a **weighted spatial graph** if we have some weight system in mind.

**Convention 2.4.** *The weights on  $T$  play no topological role, they are only important for the arithmetic. In our various calculations, we will need to pass back and forth between considering each edge and loop to have weight 1 and considering the possibility that some edge or loop has weight greater than 1. For clarity, we will use boldface to emphasize that the weights are playing a role. That is,  $T$  means that each edge or loop has weight 1 or (equivalently) that the weights are irrelevant; while  $\mathbf{T}$  means that some weight is greater than one or that the weights matter.*

**Definition 2.5.** Suppose  $\mathbf{T}$  is a weighted spatial graph. If  $p$  is in the interior of an edge or loop of  $T$ , we let  $w(p) = w(p; \mathbf{T})$  denote the weight of the edge containing it. If  $S \subset (M, T)$  is a surface, the **weight** of  $S$  is  $w(S) = w(S; \mathbf{T}) = \sum_{p \in S \cap T} w(p)$ . If  $v$  is a vertex of  $T$ , we let  $w(v) = w(v; \mathbf{T})$  be the weight of a sphere that

is the boundary of a regular neighborhood of  $v$  in  $M$ . Note that converting a vertex to a spherical boundary component or vice-versa does not change its weight.

By taking weights into account, we can adapt “bridge number” to apply to weighted spatial graphs. (See Definition 3.6 below for the precise definition of bridge surface when  $g \geq 1$ .)

**Definition 2.6.** Suppose that  $T$  is a weighted spatial graph in a 3-manifold  $M$ . For  $g \geq g(M)$ , the **genus  $g$  bridge number** of  $T$  is  $\mathfrak{b}_g(T) = \min w(H; T)$  where the minimum is over all genus  $g$  bridge surfaces  $H$  for  $(M, T)$ .

**Example 2.7.** Suppose that  $T$  is a satellite knot in  $S^3$  having companion knot  $K$  and with wrapping number  $\omega \geq 1$  with respect to  $K$ . Give  $K$  the weight  $\omega$ . Then the conclusion of Schubert’s satellite theorem can be phrased as

$$\mathfrak{b}_0(T) \geq \mathfrak{b}_0(K).$$

If  $T$  is a link in  $S^3$  such  $S^3 \setminus T$  contains an essential unpunctured torus  $Q$ , and if  $V$  denotes a side to which  $Q$  compresses, we can form a “weighted companion”  $L = (T \setminus V) \cup K$  where  $K$  is the core of  $V$  and is weighted by the wrapping number  $\omega$  of  $T \cap V$  in  $V$ . It is likely that when  $Q$  is incompressible into  $S^3 \setminus V$ , then Schulten’s proof [35] of Schubert’s theorem can be adapted to show that

$$\mathfrak{b}_0(T) \geq \mathfrak{b}_0(L).$$

In any event, we prove the result in Corollary 6.12, below.

Here is an example to show that we cannot drop the hypothesis that  $Q$  is incompressible in the complement of  $V$ . Let  $\lambda$  be a Hopf link in  $S^3$  in minimal bridge position with respect to a sphere  $H \subset S^3$ . Let  $U$  be a regular neighborhood of one component  $\lambda_U$  of  $\lambda$  and let  $\lambda_V = \lambda \setminus \lambda_U$ . Let  $U_0 \subset U_1 \subset U$  be solid tori with  $\partial U_0$ , and  $\partial U_1$  parallel to each other and to  $\partial U$ . Also choose them so that  $|U_i \cap H| = 2$ , for  $i = 0, 1$ . Let  $T_i \subset \partial U_i$  be a  $(p_i, q_i)$ -torus knot which wraps  $p_i$ -times longitudinally around  $U_i$  and  $q_i$  times meridionally. (This means that there is a compressing disc for  $\partial U_i$  in  $U_i$  whose boundary intersects  $T_i$   $p_i$  times transversally.) Choose the parameters so that  $1 < p_i < q_i$  and  $p_i$  and  $q_i$  are relatively prime, for  $i = 0, 1$ . Let  $T = T_0 \cup T_1$ . Note that  $|H \cap T|/2 = p_0 + p_1$  and that  $H$  is a bridge sphere for  $T$ . Since  $\mathfrak{b}_0(T_i) = p_i$ , we have  $\mathfrak{b}_0(T) = p_0 + p_1$ . Let  $V$  be the exterior of  $U_0$ , so that  $T_1 \subset V$  and  $T_0 \cap V = \emptyset$ . Note that the wrapping number of  $T_1$  in  $V$  is equal to  $q_1$ . Let  $L = T_0 \cup K$  where  $K$  is a core loop for  $V$  having weight  $q_1$ . We might as well take  $K = \lambda_V$ . In which case,  $H$  is a bridge sphere for  $L$  intersecting  $K$  twice and  $T_0$  a total of  $2p_0$  times. Consequently,  $\mathfrak{b}_0(L) = p_0 + q_1$ . Thus,  $\mathfrak{b}_0(T) < \mathfrak{b}_0(L)$ , contrary to what we might expect from a naive restatement of Schubert’s Satellite Theorem for links.

**Remark 2.8.** Observe that if  $S|_D$  is obtained by compressing a surface  $S \subset (M, T)$  along a disc  $D$ , then  $-\chi(S|_D) = -\chi(S) - 2$  and  $w(S|_D) = w(S) + 2w(D)$ , where  $\chi$  is Euler characteristic.

## 2.2 Sums

Let  $\mathbb{S}(k)$  be the (3-manifold, graph) pair that is the suspension of a  $k$ -punctured  $S^2$ . Thus,  $\mathbb{S}(0) = (S^3, \emptyset)$  and  $\mathbb{S}(2) = (S^3, \text{unknot})$ . Given standard (3-manifold, graph) pairs  $(M_i, T_i)$  for  $i = 1, 2$  and  $k \in \{0, 2, 3\}$  we can form a sum  $(M_1, T_1) \#_k (M_2, T_2)$  by taking the connected sum of  $M_1$  and  $M_2$  along points in  $M_i$  of degree  $k$  in  $T_i$ . When  $k = 0$ , the sum is performed at points disjoint from  $T_1$  and  $T_2$  and is called a **distant sum**. When  $k = 2$ , the sum is performed at points interior to edges or loops of  $T_1$  and  $T_2$  and is called a **connected sum**. When  $k = 3$  the sum is performed at trivalent vertices of  $T_1$  and  $T_2$  and is called a **trivalent vertex sum**. If  $T_1$  and  $T_2$  have weights and  $k = 2, 3$ , we insist that edges of the same weight are joined under the sum. The pair  $\mathbb{S}(k)$  is an identity element for  $\#_k$ . It is possible to make corresponding definitions when  $k \geq 4$ , but the sums are not as well-behaved [49]. The image of the boundary of a regular neighborhood of the summing points is a **summing sphere** in  $(M, T)$ . Conversely, if there is a separating

unpunctured or twice- or thrice-punctured separating sphere  $S \subset (M, T)$ , we can realize  $(M, T)$  as the sum of two other (3-manifold, graph) pairs whose union is  $(M, T)|_S$ .

**Definition 2.9.** Assume that  $(M, T)$  is standard and 1-irreducible. Suppose that  $S \subset (M, T)$  is the union of pairwise disjoint spheres, each intersecting  $T$  at most thrice (recalling that none can intersect it exactly once). If  $(M, T)|_S$  contains no essential sphere with three or fewer punctures but if for every proper subset of components  $S' \subset S$  the surgered pair  $(M, T)|_{S'}$  does contain an essential sphere with three or fewer punctures, we call  $S$  an **efficient summing system**.

**Remark 2.10.** This terminology is drawn from [28]. In [43, Theorem 2.4] it is extended to the case when  $M$  contains nonseparating spheres, but we will not need it. Additionally, in this paper we do not need to consider thrice-punctured spheres, however we anticipate future work that will make use of them and little effort is expended by their inclusion here. We omit a proof of the following theorem; see [28, 43] for the essential ideas, albeit in a slightly different setting.

**Theorem 2.11.** *Suppose that  $(M, T)$  is standard and 1-irreducible. Suppose that  $S, S'$  are efficient summing systems. Then  $(S, T \cap S)$  and  $(S', T \cap S')$  are homeomorphic as are  $(M, T)|_S$  and  $(M, T)|_{S'}$ . Furthermore, if  $\mathbf{T}$  is weighted and does not contain an essential twice-punctured sphere with punctures of distinct weights, then the homeomorphisms also preserve weights.*

Note the theorem does not claim that  $S$  and  $S'$  are isotopic in  $(M, T)$ .

**Remark 2.12.** Of particular importance to us are sums of the form  $(M, T) = (M_0, T_0) \#_2 (M_1, T_1)$  where  $T_0$  is a knot. For such sums, there is a “swallow-follow torus” obtained by tubing the summing sphere to itself along the arc that is the remnant of  $T_0$  in  $T$ . The torus “follows” a portion of  $T_0$  and “swallows”  $T_1$ . Conversely, if there exists an essential, unpunctured separating torus  $Q \subset (M, T)$  such that  $Q$  is cut-compressible into a side  $V \sqsubset M \setminus Q$ , then  $(M, T) = (M_0, T_0) \#_2 (M_1, T_1)$ . The arc of  $T$  intersecting the cut-disc is converted into a knot component of either  $T_0$  or  $T_1$ . If it is  $T_0$ , say, the other components of  $T_0$  are exactly the components of  $T \setminus V$ .

Finally, if  $(M, T)$  is a standard pair, a **cut edge** for  $T$  is an edge of  $T$  intersecting a once-punctured sphere  $S \subset (M, T)$  exactly once. If  $(M_0, T_0)$  and  $(M_1, T_1)$  are standard pairs and if  $e$  is any edge joining  $T_0$  to  $T_1$  in  $(M_0, T_0) \#_0 (M_1, T_1)$  and intersecting a summing sphere for the distant sum exactly once, we say that  $(M, T_0 \cup T_1 \cup e) = (M_0, T_0) \#_e (M_1, T_1)$  is a **cut edge sum**.

**Lemma 2.13.** *Suppose that  $(M_0, T_0)$  and  $(M_1, T_1)$  are standard pairs and that for  $i = 0, 1$ ,  $e_i$  is an edge such that  $(M, T'_i) = (M_0, T_0) \#_{e_i} (M_1, T_1)$  is a cut edge sum. If  $e_0$  and  $e_1$  have identical endpoints then there is an isotopy of  $T'_0$  to  $T'_1$  taking  $e_0$  to  $e_1$  and preserving the factors of the sum (although the factors may move during the isotopy).*

*Proof.* For simplicity, in this proof, we drop the requirement that any degree one vertices of  $T$  lie in  $\partial M$ . For  $i = 0, 1$ , let  $S_i \subset (M, T)$  be a sphere intersecting  $T'_i$  in a single point  $p_i \in e_i$ . For  $j = 0, 1$ , consider the (non-standard) pairs  $(\widehat{M}_0, \widehat{T}_{0j})$  and  $(\widehat{M}_1, \widehat{T}_{1j})$  obtained from  $(M, T'_j) \setminus S_j$  by collapsing the remnants of  $S_j$  to vertices  $v_{0j}$ , and  $v_{1j}$  of degree 1 where  $\widehat{T}_{ij}$  contains both  $v_{ij}$  and  $T_i$  for  $i = 0, 1$ . Each edge  $e_j$  restricts to edges  $e_{0j}$  and  $e_{1j}$  in  $(\widehat{M}_0, \widehat{T}_{0j})$  and  $(\widehat{M}_1, \widehat{T}_{1j})$  respectively. Note that each of  $e_{00}$  and  $e_{01}$  have an endpoint (namely  $v_{01}$  and  $v_{11}$  respectively) of degree 1 and not contained in  $\partial M$ . There is, therefore an isotopy fixing  $T_0$  that takes  $e_{00}$  to  $e_{01}$ . Considering  $(\widehat{M}_1, \widehat{T}_{10})$  to lie in a neighborhood of  $v_{01}$ , this is an isotopy taking  $(M, T'_0)$  to a graph  $(M, T'')$  which coincides with  $(M, T'_1)$  on the side of  $S$  containing  $T'_j$ . Furthermore, the isotopy takes  $T_1$  to itself and takes  $e_{10}$  to itself. A similar argument on the other side of  $S$  produces an isotopy taking  $e_{10}$  to  $e_{11}$ ,  $T_0$  to  $T_0$ ,  $T_1$  to  $T_1$ , and  $e_{01}$  to  $e_{01}$ . The composition of these isotopies is the isotopy we desire.  $\square$

## 2.3 Satellites and Lensed Satellites

**Definition 2.14.** Suppose that  $(V, T_V)$  is a standard pair with  $T_V$  a weighted spatial graph and  $(\partial V) \setminus T_V$  compressible in  $V$  (but not necessarily in  $V \setminus T_V$ ). The **weighted wrapping number** of  $(V, T_V)$  is the minimum of  $w(D)$  over all essential discs  $D \subset (V, T_V)$ . If all edge weights are 1, this is the **wrapping number** of  $(V, T_V)$ .

Suppose that  $Q \subset (M, T)$  is an essential separating unpunctured torus such that  $Q$  compresses to a side  $V \sqsubset M \setminus Q$ . By a standard homology argument, all compressing discs for  $Q$  in  $V$  have the same slope on  $Q$ . Let  $K \subset Q$  be a simple closed curve on  $Q$  intersecting exactly once the boundary of some compressing disc for  $Q$  in  $V$ . (All such choices are isotopic in  $V$ .) Then we call  $L = (T \cap V^c) \cup K$  a **companion** for  $T$  with respect to  $V$ . Assign  $K$  the weight which is the wrapping number  $\omega$  of  $(V, T \cap V)$  and assign each edge and loop of  $L \setminus K$  weight 1. In this case  $\mathbf{L} = (T \cap V^c) \cup \mathbf{K}$  is the **weighted companion** for  $T$  with respect to  $V$ .

If  $V$  is a solid torus such that  $Q$  is incompressible into  $M \setminus V$  and if  $T \subset V$ , then  $T$  is a **satellite**. If  $V$  is the connected sum of a solid torus and a lens space, if  $Q$  is incompressible into  $M \setminus V$ , and if  $T \subset V$ , then  $T$  is a **lensed satellite**.

**Remark 2.15.** A particular satellite  $T$  can have different companion knots and tori, each with their own wrapping number.

## 3 Multiple bridge surfaces and their invariants

We decompose standard pairs  $(M, T)$  into pieces that are particularly easy to understand. The surfaces used in the decomposition will be our “multiple bridge surfaces.”

### 3.1 Compressionbodies

We define a vertex-punctured compressionbody (henceforth, VPC) which can be thought of as a blending of the usual notions of a compressionbody, a trivial tangle, and the notion of “core loop” of a handlebody. See Figure 3. This definition can be traced back to [47] and is closely related to that of *orbifold handlebodies* [51]. The terminology is perhaps a little unfortunate, but we find it useful to distinguish our definition from others in the literature.

**Definition 3.1.** Let  $(C, T)$  be a (not necessarily standard) (3-manifold, graph) pair with  $\partial_+ C \sqsubset \partial C$  and  $\partial_- C = \partial C \setminus \partial_+ C$ . We say that  $(C, T)$  is a **product compressionbody** if  $C$  is homeomorphic to  $\partial_+ C \times I$  by a homeomorphism taking  $T$  to  $\{\text{points}\} \times I$ . It is a **punctured product compressionbody** if it is the result of removing a regular neighborhood of a finite collection of points from the interior of a product compressionbody. It is a **trivial ball compressionbody** if  $(C, T)$  is pairwise homeomorphic to  $(B, \tau)$  where  $B$  is a 3-ball, thought of as the cone on  $\partial_+ C$  and  $\tau$  is the cone on finitely many points in  $\partial B$ . If  $n = 0$ , this means that  $T = \emptyset$  and if  $n = 2$ , then  $T$  is a  $\partial$ -parallel arc. When  $n \geq 3$ , then after puncturing the vertex the trivial ball compressionbody becomes a product compressionbody. A **punctured trivial ball compressionbody** is the result of removing an open neighborhood of a finite number of non-vertex points from a trivial ball compressionbody. The pair  $(C, T)$  is a **trivial compressionbody** if it is a product compressionbody or a trivial ball compressionbody.

More generally,  $(C, T)$  is a **v(ertex) p(unctured)-compressionbody** (henceforth, **VPC**) if  $C$  is connected and if there exists a collection of discs  $\Delta \subset (C, T)$  such that:

1. each disc  $D \sqsubset \Delta$  is an sc-disc for  $\partial_+ C$ , and

2.  $(C, T)|_\Delta$  is the disjoint union of trivial compressionbodies.

The collection  $\Delta$  is called a **complete collection** of sc-discs for  $(C, T)$ . An arc component of  $\mathring{T}$  which has both endpoints on  $\partial_- \mathring{C}$  is called a **ghost arc**; an arc component with both endpoints on  $\partial_+ C$  is a **bridge arc**; an arc component with one end on  $\partial_+ C$  and one end on  $\partial_- \mathring{C}$  is a **vertical arc**; and a loop component of  $T$  disjoint from  $\partial C$  is a **core loop**. Each component of  $\mathring{T}$  is a ghost arc, bridge arc, vertical arc, or core loop. We call an edge or loop of  $T$  a ghost arc, bridge arc, vertical arc, or core loop depending on the type of its image in  $\mathring{T}$ . For a VPC  $(C, T_C)$  we define the **ghost arc graph**  $\Gamma$  as follows. The vertices of  $\Gamma$  are the vertices of  $T_C$  and the components of  $\partial_- C$ . The edges are the ghost arcs of  $T_C$ .

**Remark 3.2.** Suppose  $(C, T)$  is a punctured product compressionbody obtained from a product compressionbody  $(\widehat{C}, \widehat{T})$  by removing a regular neighborhood of a finite collection of points from the interior of  $\widehat{C}$ . Setting  $\partial_+ C = \partial_+ \widehat{C}$  and letting  $\partial_- C$  be the union of  $\partial_- \widehat{C}$  with the boundaries of the regular neighborhoods of the points that were removed, we see that  $(C, T)$  is a compressionbody. Each component of  $\partial_- C \setminus \partial_- \widehat{C}$  is either an unpunctured sphere or a twice-punctured sphere. We also say that  $(C, T)$  is a punctured product compressionbody **between**  $\partial_+ C$  and  $\partial_- \widehat{C}$ .

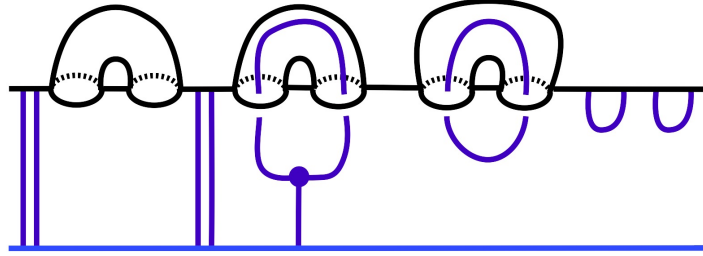

Figure 3: An example of a VPC with (from left to right) four vertical arcs, two ghost arcs, one core loop, and two bridge arcs. In this example, the positive boundary (black) has genus three more than the genus of the negative boundary (blue), each of which is depicted schematically as a horizontal line. One of the ghost arcs joins a vertex to itself and the other joins the vertex to the negative boundary. In this example, the ghost arc graph has two vertices: one is the negative boundary surface and the other is the vertex  $v$  of the graph. The ghost arc graph has two edges (the ghost arcs).

**Lemma 3.3.** *If  $\partial_+ C$  is a sphere, then all components of  $\partial_- C$  are spheres and the ghost arc graph  $\Gamma$  is acyclic. Similarly, if  $g(\partial_+ C) = g(\partial_- C)$ , then  $\Gamma$  is also acyclic.*

*Proof.* Each ghost arc is dual to a compression, so if  $\Gamma$  had a cycle  $g(\partial_+ C) \geq g(\partial_- C) + 1$ . Also, the union of spheres results from compressing a sphere, so if  $\partial_+ C$  is a sphere, so is each component of  $\partial_- C$ .  $\square$

We also need the following:

**Lemma 3.4.** *Suppose that  $(C, T_C)$  is a VPC such that no component of  $\partial_- C$  is a once-punctured sphere. If  $F \sqsubset \partial_- C$  admits an sc-disc  $D$ , then  $D$  is either a semi-compressing disc or a semi-cut disc. Let  $E \subset F$  be a zero or once-punctured disc with boundary  $\partial D$ . If  $D$  is a semi-compressing disc, then there exists an unpunctured sphere component of  $\partial_- C$  in one of the components of  $C \setminus (D \cup E)$ . If  $D$  is a semi-cut disc, then there exists an unpunctured or twice-punctured sphere component of  $\partial_- C$  in one of the components of  $C \setminus (D \cup E)$ .*

*Proof.* Let  $\Delta$  be a complete set of sc-discs for  $\partial_+ C$ , chosen to intersect  $D$  minimally. If  $\Delta \cap D = \emptyset$ , then  $D$  lies in a product VPC component of  $(C, T_C)|_\Delta$ . The disc  $D$  must then be parallel into  $F$ , a contradiction.

Thus there exists  $\zeta \sqsubset \Delta \cap D$ . Choose  $\zeta$  to be innermost in  $D$ . Let  $D' \subset D$  be the innermost disc it bounds. Then  $D'$  lies in a component  $(C', T')$  of  $(C, T_C)|_\Delta$  and  $\partial D' \subset \partial_+ C'$ . Thus,  $\partial D'$  bounds a disc  $E' \subset \partial_+ C'$ . Furthermore,  $E'$  must be contained in a scar of the surgery along  $\Delta$ . Since we minimized  $|\Delta \cap D|$ , the sphere  $E' \cup D'$  neither bounds a 3-ball nor a (3-ball, trivial arc). Thus,  $E' \cup D'$  is parallel in  $(C', T')$  to a component of  $\partial_- C' \subset \partial_- C$ . The result follows.  $\square$

Finally, we observe the following. We leave the proof to the reader, though it is nearly identical to the proofs in [44, Section 3.1].

**Lemma 3.5.** *Suppose  $(C, T_C)$  is a VPC. Then:*

1.  $(C, T_C)$  is 0-irreducible if and only if  $\partial_- C$  contains no unpunctured spheres.
2.  $(C, T_C)$  is 1-irreducible if and only if  $\partial_- C$  contains no once-punctured spheres.
3.  $(C, T_C)$  is irreducible and 2-irreducible if and only if  $\partial_- C$  contains no spheres with two or fewer punctures.
4. If  $(C, T_C)$  contains no sc-disc for  $\partial_+ C$ , it is a trivial ball compressionbody or a product compressionbody.
5. If  $(C, T_C)$  contains an sc-disc for  $\partial_+ C$  but no c-disc, it is a punctured product compressionbody with  $|\partial_- C| \geq 2$  or a punctured trivial ball compressionbody with  $|\partial_- C| \geq 1$ .
6. If  $\partial_- C$  contains no spheres with two or fewer punctures, then every sc-disc for  $\partial_+ C$  is a c-disc and  $\partial_- C$  does not admit an sc-disc in  $(C, T_C)$ .

## 3.2 Multiple bridge surfaces

Multiple v.p.-bridge surfaces were first introduced in [44] where their properties are developed in detail. They are adaptations of earlier constructions by Gabai [16], Scharlemann-Thompson [32, 33], Hayashi-Shimokawa [21], and others. We introduce only the relevant definitions and results here and refer the reader interested in more details to [44].

**Definition 3.6.** A **multiple bridge surface** for  $(M, T)$  is a closed (possibly disconnected) surface  $\mathcal{H} \subset (M, T)$  such that:

- $\mathcal{H}$  is the disjoint union of  $\mathcal{H}^-$  and  $\mathcal{H}^+$ , each of which is the union of components of  $\mathcal{H}$ ;
- $(M, T) \setminus \mathcal{H}$  is the union of embedded VPCs  $(C_i, T_i)$  with  $\mathcal{H}^- \cup \partial M = \bigcup \partial_- C_i$  and  $\mathcal{H}^+ = \bigcup \partial_+ C_i$ ;
- Each component of  $\mathcal{H}$  is adjacent to two distinct VPCs.

The components of  $\mathcal{H}^-$  are called **thin surfaces** and the components of  $\mathcal{H}^+$  are called **thick surfaces**. If  $T = \emptyset$ , then  $\mathcal{H}$  is also called a **multiple (or generalized) Heegaard surface** for  $M$ .

A connected multiple bridge surface is simply a **bridge surface**. A bridge surface for  $(M, \emptyset)$  is a Heegaard surface. The **genus  $g$  bridge number**  $\mathfrak{b}_g(T)$  of  $T$  is the minimum of  $|H \cap T|/2$  over all bridge surfaces of genus  $g$ .

**Remark 3.7.** For a knot or link  $T$ ,  $\mathfrak{b}_g(T)$  is a nonnegative integer. For a spatial graph it may be a half integer. It is a standard result, and easily proven, that if  $g \geq \mathfrak{g}(M)$  (where  $\mathfrak{g}(M)$  is the Heegaard genus of  $M$ ), then  $\mathfrak{b}_g(T)$  is defined. Our definition of  $\mathfrak{b}_g$  differs from that in [10], primarily in that we allow ghost arcs and core loops in our compressionbodies. Thus, for example, if  $K \subset S^3$  is the unknot,  $\mathfrak{b}_1(K) = 0$ , although  $\mathfrak{b}_0(K) = 1$ .

Given a genus  $g$  bridge surface  $H$  for  $(M, T)$ , if there is an arc component of  $T \setminus H$ , we can attach a tube along it to obtain a genus  $g + 1$  bridge surface  $H'$  for  $K$  with  $|H \cap K| = |H' \cap K| + 2$ . Thus,  $\mathfrak{b}_g(K) \geq \mathfrak{b}_{g+1}(K) + 1$ , if  $K$  is a link with  $\mathfrak{b}_g(K) \geq 1$ . If there is no such arc, we can still attach a tube to  $H$ , but one that is disjoint from  $K$ , to obtain a genus  $g + 1$  for  $K$ , showing that  $\mathfrak{b}_g(T) \geq \mathfrak{b}_{g+1}(T)$  in all situations.

Suppose that  $\mathcal{H}$  is a multiple bridge surface for  $(M, T)$  and suppose that each component of  $\mathcal{H}$  is given a transverse orientation so that for every component  $(C, T_C)$  of  $(M, T) \setminus \mathcal{H}$  if the transverse orientation of  $\partial_+ C$  points into (respectively, out of)  $C$ , then the transverse orientations of all components of  $\partial_- C \cap \mathcal{H}^-$  point out of (respectively, into)  $C$ . With these orientations, the edges of the dual graph to  $\mathcal{H}$  in  $M$  inherit an orientation, making the dual graph into a digraph, called the **dual digraph**. (This is a version of the *fork complexes* of [31].)

The multiple bridge surface  $\mathcal{H}$  is an **oriented acyclic** multiple bridge surface if the dual digraph is acyclic. (This is easily seen to be equivalent to the definition of “oriented” in [44].) The underlying undirected graph may have cycles; we require it to be acyclic as a *directed* graph. We let  $\overrightarrow{vp\mathbb{H}}(M, T)$  denote the set of oriented acyclic multiple v.p.-bridge surfaces of  $(M, T)$  up to isotopy transverse to  $T$ .

In the dual digraph to  $\mathcal{H} \in \overrightarrow{vp\mathbb{H}}(M, T)$ , each edge corresponds to a component  $\mathcal{H}$  and each vertex to a VPC of  $(M, T) \setminus \mathcal{H}$ . If  $x, y$  are edges or vertices (or their corresponding surfaces or VPCs) we say that  $y$  is **above**  $x$  if there is an edge path in the dual digraph from  $x$  to  $y$  that is consistent with the orientations. If there is an edge path from  $x$  to  $y$  that is always inconsistent with the orientations, then  $y$  is **below**  $x$ . Two VPCs are **adjacent** if they share a component of  $\mathcal{H}$ . Two components of  $\mathcal{H}$  are **adjacent** if they lie in the same VPC and a VPC and a component of  $\mathcal{H}$  are **adjacent** if the surface is a boundary component of the VPC.

**Definition 3.8.** Recall that for  $\mathcal{H} \in \overrightarrow{vp\mathbb{H}}(M, T)$ , the dual digraph is acyclic. A VPC  $(C, T_C) \sqsubset (M, T) \setminus \mathcal{H}$  is an **outermost** VPC with some property if there is no nontrivial directed path in the dual digraph from the VPC  $(C, T_C)$  with that property to another VPC with that property. Similarly, a VPC  $(C, T_C)$  is an **innermost** VPC with some property if there is no nontrivial directed path from some other VPC with the property to  $(C, T_C)$ .

For example, we can refer to the outermost VPC intersecting  $T$ . If we don't specify a property, then the outermost VPCs correspond to sinks in the dual digraph to  $\mathcal{H}$  and the innermost VPCs correspond to sources in the dual digraph.

**Definition 3.9.** Suppose that  $\mathcal{H} \in \overrightarrow{vp\mathbb{H}}(M, T)$  and that  $Q \subset (M, T)$  is a surface. We say that  $\mathcal{H}$  is **adapted** to  $Q$  if for each component  $Q_0 \sqsubset Q$ , either  $Q_0 \subset \mathcal{H}^-$  or all of the following hold:

1.  $\mathcal{H}$  is transverse to  $Q_0$
2.  $\mathcal{H} \cap Q_0 \neq \emptyset$
3. each component of  $Q_0 \cap \mathcal{H}$  is essential in each of  $Q_0$  and  $\mathcal{H}$ , and
4. no component of  $Q_0 \setminus \mathcal{H}$  with boundary is parallel to a subsurface of  $\mathcal{H}$  by a proper isotopy keeping  $Q_0$  transverse to  $T$ .

Note that unless  $Q_0 \subset \mathcal{H}^-$ , since  $\mathcal{H}$  is closed, the intersection  $Q \cap \mathcal{H}$  consists of simple closed curves.

We let  $\mathbb{H}(Q)$  be those elements of  $\overrightarrow{vp\mathbb{H}}(M, T)$  that are adapted to  $Q$ . We consider multiple bridge surfaces in  $\mathbb{H}(Q)$  that differ by an isotopy relative to  $Q$  and transverse to  $T$  to be equivalent. This means that surfaces equivalent in  $\mathbb{H}(Q)$  are also equivalent in  $\overrightarrow{vp\mathbb{H}}(M, T)$ , but not necessarily vice-versa.



### 3.3 Invariants

Let  $(M, T)$  be a standard pair with  $T$  weighted and  $S \subset (M, T)$  a surface. For  $m \in \mathbb{N}$ , we define

$$\begin{aligned} x(S) &= x(S; \mathbf{T}) &= (-\chi(S) + w(S; \mathbf{T}))/2 \\ x_m(S) &= x_m(S; \mathbf{T}) &= (-m\chi(S) + w(S; \mathbf{T}))/2 \end{aligned}$$

As in Definition 2.5, for a vertex  $v$  of  $T$ , we define  $x(v)$  and  $x_m(v)$  to be equal to  $x(S)$  and  $x_m(S)$  where  $S$  is the sphere that is the boundary of a regular neighborhood of  $v$ .

For a multiple bridge surface  $\mathcal{H}$ , define:

$$\begin{aligned} \text{net } \chi(\mathcal{H}) &= -\chi(\mathcal{H}^+) + \chi(\mathcal{H}^-) \\ \text{net } g(\mathcal{H}) &= g(\mathcal{H}^+) - g(\mathcal{H}^-) + |\mathcal{H}^-| - |\mathcal{H}^+| + 1 \\ \text{net } w(\mathcal{H}) &= \text{net } w(\mathcal{H}; \mathbf{T}) = w(\mathcal{H}^+) - w(\mathcal{H}^-) \\ \text{net } x(\mathcal{H}) &= \text{net } x(\mathcal{H}; \mathbf{T}) = x(\mathcal{H}^+) - x(\mathcal{H}^-) \\ \text{net } x_m(\mathcal{H}) &= \text{net } x_m(\mathcal{H}; \mathbf{T}) = x_m(\mathcal{H}^+) - x_m(\mathcal{H}^-) \end{aligned}$$

We call  $\text{net } g$  the **net genus**. In its definition, recall that the genus of a disconnected surface is the sum of the genera of its components. The quantity  $|\mathcal{H}^-| - |\mathcal{H}^+| + 1$  is equal to the genus of the dual digraph to  $\mathcal{H}$ . That is, the genus of a handlebody having the dual digraph as its spine. Several of our results are nicer to state with regard to genus, but easier to prove using euler characteristic.

**Remark 3.10.** Note that:

$$\text{net } x_m(\mathcal{H}) = m \text{net } \chi(\mathcal{H})/2 + \text{net } w(\mathcal{H})/2$$

**Definition 3.11.** For a pair  $(M, T)$  with  $T$  weighted and  $g \geq g(M)$  define

$$\text{net } w_g(\mathbf{T}) = \min \text{net } w(\mathcal{H})$$

where the minimum is taken over all  $\mathcal{H} \in \overrightarrow{vp\mathbb{H}}(M, T)$  with  $\text{net } g(\mathcal{H}) = g$ .

**Remark 3.12.** Lemma 3.15 shows that the minimum in Definition 3.11 exists.

If  $H$  is a bridge surface for  $(M, T)$ , then  $\text{net } g(H) = g(H)$ . Consequently,  $\mathfrak{b}_g(T) \geq \text{net } w_g(M, T)/2$ . Conversely, it turns out that if  $\text{net } g(\mathcal{H}) = g$  and  $\text{net } \chi(\mathcal{H}) = x$ , then  $\mathcal{H}$  can be “amalgamated” (Section 4.2) to a Heegaard surface for  $M$  of genus  $g$  with  $x = 2g - 2$ . If this amalgamation can always be done in a way so that the result is a bridge surface for  $(M, T)$ , then  $\mathfrak{b}_g(M, T) = \text{net } w_g(M, T)/2$ . However, this may not be possible. Here is an example.

Let  $K_1$  and  $K_2$  be knots in  $S^3$ , each of tunnel number  $t$  (so their exteriors have Heegaard genus  $t + 1$ ). Let  $T = K_1 \# K_2$ . Let  $\mathcal{H} \in \overrightarrow{vp\mathbb{H}}(S^3, T)$  have two thick surfaces, each of genus  $t + 1$  that are disjoint from  $T$  and a single thin surface which is the summing sphere. Note that  $\text{net } g(\mathcal{H}) = 2t + 2$ . Then  $\text{net } w(\mathcal{H})/2 = -1$  but  $b_{2t+2}(T) \geq 0$ .

### 3.4 Lower bounds on net weight

For the purposes of attaining bounds, it also useful to adapt the definitions to VPCs. For a VPC  $(C, T_C) \sqsubset (M, T) \setminus \mathcal{H}$  with  $T_C$  weighted, let  $U$  be the (possibly empty) union of some vertices of  $T$ . We define

$$\delta_m(C, \mathbf{T}_C) = x_m(\partial_+ C) - x_m(\partial_- \mathring{C} \setminus U) - x(U).$$

Although we omit  $U$  from the notation of  $\delta_m$ , it does affect the result. We think of  $U$  as the collection of vertices we wish to consider as “unweighted.”

**Lemma 3.13.** *Assume that  $(M, T)$  is standard, that  $T$  is weighted, and that if  $v \in U$ , then  $v$  is incident only to edges of weight 1. Let  $(C, T_C) \sqsubset (M, T) \setminus \mathcal{H}$ . Suppose that  $\delta_m(C, \mathbf{T}_C) < 0$  and that  $m$  is at least the maximal weight of any edge or loop in  $\mathbf{T}$ . Then,  $C$  is a 3-ball and  $T_C$  contains only vertices in  $U$ .*

*Proof.* Assume  $\delta_m(C, \mathbf{T}_C) < 0$ . Let  $\Delta$  be a complete collection of sc-discs for  $(C, T_C)$ . We prove the result by induction on  $|\Delta|$ . If  $|\Delta| = 0$ , then  $(C, T_C)$  is a trivial VPC and, as we explain, it is easy to verify that the result holds. For if  $(C, T_C)$  is a trivial product compressionbody, then  $x_m(\partial_+ C) = x_m(\partial_- C)$ , so  $\delta_m(C, \mathbf{T}_C) = 0$ . Suppose  $(C, T_C)$  is a trivial ball compressionbody. The graph  $T_C$  has at most one vertex  $v$ . If  $v$  does not exist or is in  $U$ , the conclusion holds. If  $v \notin U$ , then  $\delta_m(C, \mathbf{T}_C) = -m + w(\partial_+ C)/2 + (m - w(v))/2 = 0$ .

We now proceed to the inductive step. Let  $D$  be an sc-disc of weight  $p$  in  $\Delta$  and let  $(C', T'_C) = (C, T_C)|_D$ . We have:

$$0 > \delta_m(C, \mathbf{T}_C) = m - p + \delta(C', \mathbf{T}'_C) \geq \delta_m(C', \mathbf{T}'_C)$$

By the inductive hypothesis, at least one component of  $(C', T'_C)$  is a 3-ball whose intersection with  $T'_C$  contains only vertices in  $U$ .

If  $(C', T'_C)$  is itself such a 3-ball, then  $C$  is a solid torus. Suppose such is the case. If  $T'_C$  is empty or a bridge arc, then  $T_C$  is either empty or a core loop for  $C$ , in which case  $\delta_m(C, \mathbf{T}_C) = 0$ , a contradiction. Suppose, therefore, that  $T_C$  contains vertices; by the inductive hypothesis, they all belong to  $U$ . Thus,

$$\delta_m(C, \mathbf{T}_C) = w(\partial_+ C)/2 - x(U) = w(\partial_+ C)/2 + |U| - w(U; T)/2.$$

The weight of each vertex in  $U$  is its degree, so

$$\delta_m(C, \mathbf{T}_C) = w(\partial_+ C)/2 + \sum_{v \in U} (2 - \deg(v))/2.$$

If there is a ghost arc in  $T_C$  with distinct endpoints, we can contract it without changing  $\delta_m(C, \mathbf{T}_C)$ . By the definition of VPC, we may, therefore, assume that  $T_C$  has at most one ghost arc and all other arcs are vertical. The ghost arc, if it exists, has its endpoints at the same vertex of  $T_C$ . An easy calculation shows that  $\delta_m(C, \mathbf{T}_C) \geq 0$ . Thus, we may assume that  $(C', T'_C)$  is the union of two VPCs:  $(C_1, T_1)$  and  $(C_2, T_2)$ . Each of them has a complete collection of sc-discs containing fewer discs than  $\Delta$ .

Without loss of generality, assume that  $(C_1, T_1)$  is a 3-ball and that  $T_1$  has only vertices in  $U$ . We desire to show that this is also true for  $(C_2, T_2)$ . As in the previous paragraph, if  $T_1$  or  $T_2$  has a ghost arc edge with both ends in  $U$ , we may contract it without changing  $\delta_m$ . As  $C_1$  is a 3-ball, this means we may assume that  $T_1$  contains at most one vertex; if it does, the vertex is in  $U$ .

As  $T_1$  contains no ghost arcs (as we have contracted them), each arc of  $T_1$  is a vertical arc or bridge arc. The bridge arcs contribute their weight to  $w(\partial_+ C_1; \mathbf{T}_1)$ . Since each vertex of  $U$  is incident only to edges of weight 1, each vertical arc in  $T_1$  contributes 0 to  $w(\partial_+ C_1; \mathbf{T}_1)/2 - w(\partial_- C_1; T_1)$ . Thus,

$$\delta_m(C_1, \mathbf{T}_1) = -m + |U \cap T_1| + b$$

where  $b$  is the total weight of all the bridge arcs in  $\mathbf{T}_1$ . Consequently,

$$\begin{aligned} 0 &> \delta_m(C, \mathbf{T}_C) \\ &= m - p + \delta_m(C_1, \mathbf{T}_1) + \delta_m(C_2, \mathbf{T}_2) \\ &= m - p - m + |U| + b + \delta_m(C_2, \mathbf{T}_2) \\ &= -p + |U| + b + \delta_m(C_2, \mathbf{T}_2) \end{aligned}$$

If  $p \geq 1$ , then some arc of  $T_1$  is incident to the scar from  $D$ . If that arc is a vertical arc, then  $p = 1$  and  $|U| \geq 1$ . If that arc is a bridge arc, then  $b \geq p$ . Thus, in either case,  $-p + |U| + b \geq 0$ . Thus,  $\delta_m(C_2, \mathbf{T}_2) < 0$ .

We may, therefore, also apply the inductive hypothesis to  $(C_2, T_2)$ . Reconstructing  $(C, T_C)$ , we see that the result also holds for  $(C, T_C)$ .  $\square$

**Lemma 3.14.** *Suppose that  $\mathcal{H}$  is a multiple bridge surface for a standard weighted  $(M, T)$ . Let  $U$  be a subset of  $V(T)$ , the vertices of  $T$ . Then*

$$2 \operatorname{net} x_m(\mathcal{H}) - x_m(\partial M) - x_m(V(T) \setminus U) - x(U) = \sum_{(C, T_C)} \delta_m(C, \mathbf{T}_C)$$

*Proof.* This is a version of [42, Corollary 4.8]. It follows from the fact that each component of  $\mathcal{H}$  is incident to two VPCs.  $\square$

The next corollary uses a similar counting argument to show that  $\operatorname{net} w_g(\mathbf{T})$  is well-defined, although as we observed above, it can be negative. A more sophisticated version of this argument is employed in the proof of Theorem 6.9 below where we need to show that in certain important situations,  $\operatorname{net} w(\mathcal{H})$  is non-negative.

**Corollary 3.15.** *If  $(M, \mathbf{T})$  is standard and  $g \geq g(M)$ , then  $\operatorname{net} w_g(\mathbf{T})$  exists and is bounded below by a constant depending only on  $(M, \mathbf{T})$  and  $g$ .*

*Proof.* Let  $\mu$  be the maximal weight of an edge of  $\mathbf{T}$ . Let  $\mathcal{H} \in \overrightarrow{\operatorname{vpH}}(M, T)$  have  $\operatorname{net} g(\mathcal{H}) = g$ . Consider a VPC  $(C, \mathbf{T}_C) \subset (M, \hat{T}) \setminus \mathcal{H}$ . Let  $n(C, T_C)$  be the number of ghost arcs in  $T_C$  (equivalently  $\hat{T}_C$ ). As each  $\partial$ -reduction along an sc-disc reduces  $\delta_1(C, \emptyset)$  by 2 and decreases the number of ghost arcs by at most 1,

$$-\chi(\partial_+ C) + \chi(\partial_- C) \geq 2n(C, T_C)$$

Thus, as bridge arcs contribute positively to  $w(\partial_+ C) - w(\partial_- C)$  and vertical arcs contribute equally to  $w(\partial_+ C)$  and  $w(\partial_- C)$ , and each end of a ghost arc contributes to  $w(\partial_- C)$  and not at all to  $w(\partial_+ C)$ , we have

$$\begin{aligned} \mu(-\chi(\partial_+ C) + \chi(\partial_- C)) + w(\partial_+ C; \mathbf{T}) - w(\partial_- C; \mathbf{T}) &\geq \\ 2\mu n(C, T_C) - 2\mu n(C, T_C) &\geq 0. \end{aligned}$$

Summing over all components  $(C, T_C)$  of  $(M, T) \setminus \mathcal{H}$ , we have:

$$\begin{aligned} 2\mu \operatorname{net} \chi(\mathcal{H}) + \mu \chi(\partial M) + 2 \operatorname{net} w(\mathcal{H}) + w(\partial M) &\geq \\ \sum (\mu(-\chi(\partial_+ C) + \chi(\partial_- C)) + w(\partial_+ C; \mathbf{T}) - w(\partial_- C; \mathbf{T})) &\geq 0 \end{aligned}$$

Consequently,

$$\operatorname{net} w(\mathcal{H}; \mathbf{T}) \geq -\mu(2g - 2) - \mu \chi(\partial M)/2 - w(\partial M; \mathbf{T})/2$$

The right-hand side is independent of  $\mathcal{H}$ . As  $\operatorname{net} w(\mathcal{H})$  is always an integer or half-integer,  $\min \operatorname{net} w(\mathcal{H}; \mathbf{T})$  exists and is bounded below.  $\square$

Our last corollary is another lower bound that will be useful later on. For brevity, we omit the arithmetic which is simpler than that of the previous lemma.

**Lemma 3.16.** *Suppose that  $(M, T)$  is a (not necessarily standard) pair and that  $\partial M$  is nonempty and connected. Then if  $\mathcal{H} \in \overrightarrow{\operatorname{vpH}}(M, T)$ ,  $x(\partial M) \leq \operatorname{net} x(\mathcal{H})$ .*

*Proof.* Observe that each VPC  $(C, T_C)$  of  $(M, T) \setminus \mathcal{H}$  is either above or below its positive boundary  $\partial_+ C$ . Call it an **upper** VPC in the former case and a **lower** VPC in the second case. Without loss of generality, assume that the VPC containing  $\partial M$  is a lower VPC. Each thick and thin surface in  $\mathcal{H}$  is contained in exactly one lower VPC. Thus, summing over  $(C, T_C) \subset (M, T) \setminus \mathcal{H}$ , we have

$$\operatorname{net} x(\mathcal{H}) - x(\partial M) = \sum \delta_1(\hat{C}, \hat{T}_C).$$

It is straightforward to verify that each  $\delta_1(C, T_C) \geq 0$ . The result follows.  $\square$

### 3.5 Net weight and net genus one multiple bridge surfaces

We investigate the multiple bridge surfaces of  $S^3$  and lens spaces.

**Lemma 3.17.** *Suppose that  $\mathcal{H} \in \overrightarrow{vp\mathbb{H}}(M, T)$  with  $(M, T)$  standard and irreducible and with  $M$  having a genus 1 Heegaard surface. Suppose that  $g(M) \leq \text{net } g(\mathcal{H}) = g \leq 1$ . Then, every component of  $\mathcal{H}$  is a sphere or torus. (There is a torus if and only if  $g = 1$ .) Furthermore, no sphere separates the collection of tori. Ignoring the spheres, all tori are parallel and each is a Heegaard torus for  $M$ .*

An example of such a multiple bridge surface (without  $T$ ) is shown in Figure 4.

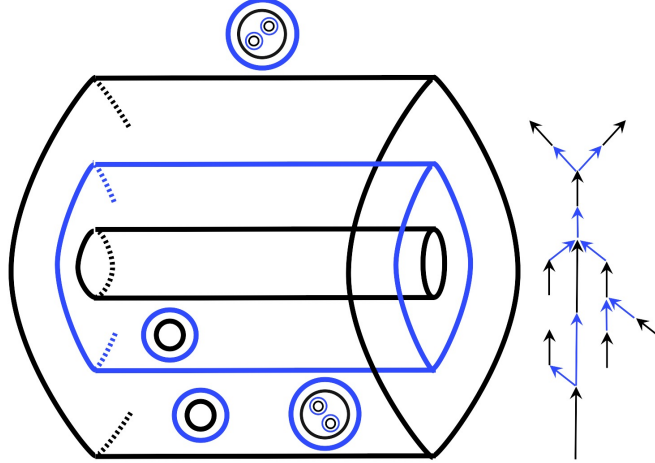

Figure 4: An example of a multiple bridge surface  $\mathcal{H}$  (the knot or spatial graph  $T$  is not shown) of net genus 1. The tori are depicted as annuli with a boundary identification implied. The thick surfaces are black and the thin surfaces blue. With correct choice of orientation, the dual digraph is shown to the right. The long arrows represent tori and the short arrows represent spheres.

*Proof.* It follows from the definition of net  $g$  and the fact that every closed surface in  $M$  is separating, that each component of  $\mathcal{H}$  is a sphere or torus and that dual digraph to  $\mathcal{H}$  is a tree. Furthermore, in  $M$ ,  $\mathcal{H}$  amalgamates to a Heegaard torus for  $M$ . It follows that no sphere component of  $\mathcal{H}^-$  separates two tori components of  $\mathcal{H}^+$ . Ignoring the sphere components of  $\mathcal{H}$ , all toroidal components are parallel. Thus, each toroidal component of  $\mathcal{H}$  is a Heegaard torus for  $M$ .

Consequently, there exist exactly two compressiobodies  $(C, T_C)$  and  $(D, T_D)$  of  $M \setminus \mathcal{H}$  with  $\partial_+ C$  and  $\partial_+ D$  tori and  $\partial_- C$  and  $\partial_- D$  the (possibly empty) union of spheres.  $\square$

**Corollary 3.18.** *Suppose that  $(M, T)$  is an irreducible standard pair with  $M$  either  $S^3$ , a lens space, solid torus, or  $T^2 \times I$ . Let  $g \geq g(M)$  be either 0 or 1. Then*

$$\text{net } w_g(T) \geq 0.$$

*Proof.* Let  $\mathcal{H} \in \overrightarrow{vp\mathbb{H}}(M, T)$  have  $\text{net } g(\mathcal{H}) = g$ . As we will explain in Section 4.1, if there is a VPC  $(C, T_C) \sqsubset (M, T) \setminus \mathcal{H}$  that is a trivial product VPC with  $\partial_+ C \sqsubset \mathcal{H}^+$  and  $\partial_- C \sqsubset \mathcal{H}^-$ , we may remove  $\partial_+ C$  and  $\partial_- C$  from  $\mathcal{H}$ , without affecting the fact that  $\mathcal{H} \in \overrightarrow{vp\mathbb{H}}(M, T)$  and without changing  $\text{net } g(\mathcal{H})$  or  $\text{net } w(\mathcal{H})$ . For simplicity, we may, therefore, assume that there is no such VPC.

We induct on  $|\mathcal{H}^+|$ . Suppose that  $|\mathcal{H}^+| = 1$ . In this case  $\mathcal{H}^- = \emptyset$  and so  $\text{net } w(\mathcal{H}) = |\mathcal{H} \cap T| \geq 0$ . If equality holds, then  $T$  is disjoint from  $\mathcal{H}$ . If  $T \neq \emptyset$ , this means that  $\mathcal{H}$  must be a torus and so  $T$  must be a core loop or Hopf link.

Suppose, therefore, that the result holds for bridge surfaces with up to  $n \geq 1$  thick surfaces and that  $|\mathcal{H}^+| \geq n + 1$ .

If  $F \sqsubset \mathcal{H}^-$  is an outermost or innermost thin surface bounding a submanifold  $W \sqsubset M \setminus F$  disjoint from  $\mathcal{H}^- \setminus F$ . Let  $H = \mathcal{H}^+ \cap W$ . Let  $\Gamma$  be the ghost arc graph for the VPC  $(X, T_X)$  bounded by  $C$  and  $H$ . One vertex of  $\Gamma$  is  $F$ ; all others are vertices of  $T$ , each of which has degree at least 3. Let  $b$  be the number of bridge arcs of  $T_X$ ;  $v_0$  the number of vertical arcs of  $T_X$  not incident to  $F$ ; and  $g_F$  the number of ghost arcs of  $T_X$  with an endpoint at  $F$ .

**Case 1:**  $\mathcal{H}^-$  does not contain a sphere.

By Lemma 3.17, all components of  $\mathcal{H}$  are tori. Let  $F$  be an innermost or outermost such  $F$  as above and consider  $W$  and  $H$  as above. If  $\mathcal{H}^- = F$ , then there are two possible choices for  $H$ . The ghost arc graph  $\Gamma$  is acyclic by Lemma 3.3. Each isolated vertex of  $\Gamma$  (other than  $F$ ) is incident to at least 3 vertical arcs and each leaf of  $\Gamma$  (other than  $F$ ) is incident to at least two vertical arcs. Note that

$$|H \cap T| - |F \cap T| = 2b + v_0 - g_F.$$

If  $F$  is an isolated vertex of  $\Gamma$ , then  $g_F = 0$  and either  $b \geq 1$  or  $v_0 \geq 3$ , as no component is a product compressionbody between a thick and thin surface. Thus,  $|H \cap T| - |F \cap T| \geq 2$ . If  $F$  is incident to at least two ghost arcs, then each subtree of  $\Gamma \setminus F$  contains a leaf (not equal to  $F$ ) incident to at least two vertical arcs. There are at least two such leaves, and so

$$|H \cap T| - |F \cap T| = 2b + v_0 - g_F \geq 2b + 2 \geq 2.$$

Finally, if  $F$  is a leaf of  $\Gamma$ , then there is at least one other leaf of  $\Gamma$  and so

$$|H \cap T| - |F \cap T| = 2b + v_0 - g_F \geq 2b + 1 \geq 1.$$

If  $|\mathcal{H}^-| \geq 2$ , we can find distinct tori  $F_1, F_2 \sqsubset \mathcal{H}^-$  such that one is innermost and the other outermost and they bound disjoint submanifolds  $W_1, W_2$  in  $M$  with interiors disjoint from  $M \setminus \mathcal{H}^-$ . Let  $H_1, H_2$  be the corresponding thick surfaces. Let  $\mathcal{H}'$  be the restriction of  $\mathcal{H}$  to  $M \setminus (W_1 \cup W_2)$ . Then

$$\text{net } w(\mathcal{H}) = \text{net } w(\mathcal{H}') + (|H_1 \cap T| - |F_1 \cap T|) + (|H_2 \cap T| - |F_2 \cap T|) \geq 2$$

where the last inequality follows from our previous calculations and the inductive hypothesis applied to  $\mathcal{H}'$ .

If  $|\mathcal{H}^-| = 1$ , there is a unique choice for  $F$  and there are tori  $H_1, H_2 \sqsubset \mathcal{H}^+$  on either side of  $F$ . Then

$$\text{net } w(\mathcal{H}) = (|H_1 \cap T| - |F \cap T|) + (|H_2 \cap T| - |F \cap T|) + |F \cap T| \geq 2$$

by the previous calculations. Thus, in all cases  $\text{net } w(\mathcal{H}) \geq 2$ .

**Case 2:**  $\mathcal{H}^-$  contains a sphere.

By Lemma 3.17, there exists an innermost or outermost sphere  $F \sqsubset \mathcal{H}^-$  such that the thick surface  $H$  (defined above) is a sphere. Again, the ghost arc graph  $\Gamma$  is acyclic. An identical calculation to that above shows that

$$|H \cap T| - |F \cap T| \geq 1$$

and if equality holds, then  $b = 0$ ,  $F$  is a leaf of  $\Gamma$ , and there is a unique other vertex  $v$  of  $\Gamma$  with  $\deg(v) = 3$ . Let  $(M', T') \sqsubset (M, T)|_F$  be the component not containing  $\mathcal{H}$ . Let  $\mathcal{H}' = \mathcal{H} \cap M'$ . We have:

$$\text{net } w(\mathcal{H}) = \text{net } w(\mathcal{H}') + |H \cap T| - |F \cap T| \geq \text{net } w(\mathcal{H}') + 1 \geq 1.$$

The last inequality follows from the inductive hypothesis. □

## 4 Thinning

Suppose that  $(M, T)$  is standard and  $Q \subset (M, T)$ . The main goal of this section is to find  $\mathcal{H} \in \overrightarrow{vp\mathbb{H}}(M, T)$  such that  $\mathcal{H} \cap Q$  consists of loops that are essential in both surfaces. This is a standard application of “thin position” techniques, but there are some details special to our situation.

In [44], building on work of many authors (e.g. [16, 21, 32, 33]) we defined a partial order on  $\overrightarrow{vp\mathbb{H}}(M, T)$ . The partial order was defined using a certain, somewhat large, collection of moves on multiple bridge surfaces. In this paper, we restrict attention to only two moves. The corresponding partial order will be denoted  $\rightsquigarrow$ . In what follows we briefly revisit some of the earlier arguments in this new context; were it not for our need to consider weighted graphs, we could simply use the earlier partial order and appeal to results from [42, 44]; however, the simplifications we present here are likely to be useful in the future.

### 4.1 Weak reduction and consolidation

**Definition 4.1.** Suppose that  $\mathcal{H} \in \overrightarrow{vp\mathbb{H}}(M, T)$  and that some VPC  $(C, T_C) \sqsubset (M, T) \setminus \mathcal{H}$  is a punctured product compressionbody between  $H = \partial_+ C$  and  $F \sqsubset \partial_- C \cap \mathcal{H}^-$ . Then  $\mathcal{J} = \mathcal{H} \setminus (H \cup F)$  is obtained by **consolidating**  $\partial_+ C$  and  $\partial_- C$ .

**Lemma 4.2.** *If  $\mathcal{J}$  is obtained by consolidating  $\mathcal{H} \in \overrightarrow{vp\mathbb{H}}(M, T)$ , then  $\mathcal{J} \in \overrightarrow{vp\mathbb{H}}(M, T)$ .*

*Proof.* Let  $(C, T_C)$  be the punctured product compressionbody between the thick surface  $H$  and the thin surface  $F$  that are removed from  $\mathcal{H}$  when forming  $\mathcal{J}$ . If  $(C, T_C)$  is a product compressionbody (equivalently  $|\partial_- C| = 1$ ), the result follows immediately from [44, Lemma 5.5]. We briefly address the case when  $|\partial_- C| \geq 2$ .

As we noted in Remark 3.2, each component of  $P = \partial_- C \setminus F$  is a zero or twice-punctured sphere. Since  $(M, T)$  is standard, each such sphere is separating in  $M$ . Surger  $(M, T)$  along  $P$  to get  $(M, T)|_P$ . Let  $\mathcal{H}_P = \mathcal{H} \setminus P$ . In each component of  $(M, T)|_P$ ,  $\mathcal{H}_P$  is an acyclic oriented multiple bridge surface. Let  $(M_0, T_0)$  be the component containing  $H \cup F$  and let  $\mathcal{H}_0 = \mathcal{H} \cap (M_0, T_0)$ . Consolidating  $\mathcal{H}_0$  by removing  $H \cup F$  preserves the fact it is an oriented multiple bridge surface as they cobound a product compressionbody. Removing a regular neighborhood of a finite collection of points from the interior of a VPC preserves the fact it is a VPC. Reversing the surgery along  $P$ , we see that  $\mathcal{J} = \mathcal{H} \setminus (H \cup F)$  is an oriented acyclic multiple bridge surface.  $\square$

The following definition can be traced back to [8, 33].

**Definition 4.3.** Suppose that  $\mathcal{H} \in \overrightarrow{vp\mathbb{H}}(M, T)$  and that  $H \sqsubset \mathcal{H}^+$  is c-weakly reducible, with disjoint c-discs  $D_+$  and  $D_-$  on opposite sides of  $H$ . Let  $H_\pm$  be the result of compressing  $H$  using  $D_\pm$  respectively and let  $F$  be the result of compressing  $H$  using  $D_+ \cup D_-$ . Isotope these surfaces to be pairwise disjoint and so that  $F$  lies between  $H_+$  and  $H_-$ . Let  $\mathcal{J}$  be the result of removing  $H$  from  $\mathcal{H}$  and adding the components of  $H_+$  and  $H_-$  as thick surfaces and the components of  $F$  as a thin surface. See Figure 5. We say that  $\mathcal{J}$  is obtained from  $\mathcal{H}$  by **untelescoping**. We call  $D_- \cup D_+$  a **weak reducing pair**.

After untelescoping, there may be either one or two trivial product VPCs between components of  $H_- \cup H_+$  and components of  $F$ . The untelescoping, followed by consolidating those surfaces (if possible) is an **elementary thinning move on  $\mathcal{H}$** . Not all components of the thin surface  $F$  will be consolidated under an elementary thinning move. (See [44, Lemma 5.8].)

In [44] we showed that untelescoping and consolidating an oriented acyclic multiple bridge surface results in another oriented acyclic multiple bridge surface.

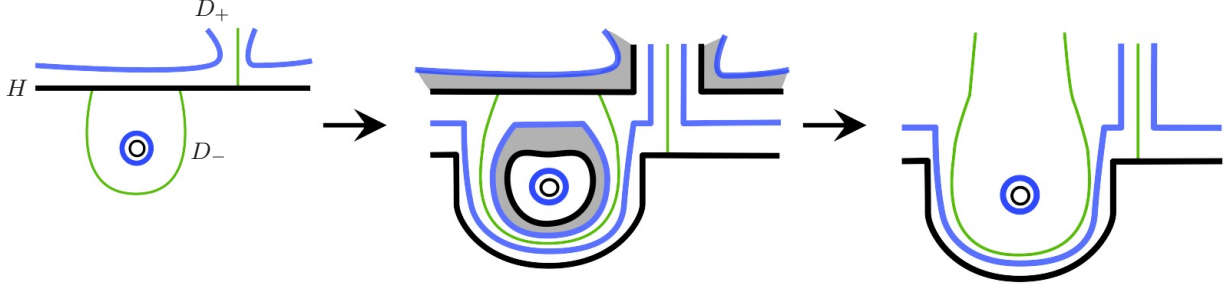

Figure 5: An example of an elementary thinning sequence. In the example the discs  $D_+$  and  $D_-$  are in green and are above and below the thick surface  $H$ .  $D_+$  is non-separating (consider the left and right sides of  $H$  to be identified) and  $D_-$  is separating. There are two thin surfaces depicted in blue, one above  $H$  and one below. One other thick surface is also shown in black. The graph  $T$  is not shown. After untelescoping, there is a product VPC between a new thin surface and a new thick surface and also a product VPC between an old thin surface and a new thick surface. These are depicted in grey. Note that  $\partial D_{\mp}$  can be extended to lie on  $H_{\pm}$ . After consolidating, these boundaries can be further extended, as necessary to lie on other thick surfaces.

**Definition 4.4.** We say that  $\mathcal{H}$  **uc-thins to** (or just **thins to**)  $\mathcal{J}$  and write  $\mathcal{H} \rightsquigarrow \mathcal{J}$  if  $\mathcal{J}$  can be obtained from  $\mathcal{H}$  by a (possibly empty) sequence of elementary thinning moves and consolidations.  $\mathcal{H}$  is **locally thin** if  $\mathcal{H} \rightsquigarrow \mathcal{J}$  implies  $\mathcal{J} = \mathcal{H}$ .

**Remark 4.5.** The relation  $\rightsquigarrow$  is a partial order on  $\overrightarrow{vp\mathbb{H}}(M, T)$ . In [44], we defined a similar partial order  $\rightarrow$  using not only consolidation (of thick and thin surfaces bounding product, rather than punctured product, compressionbodies) and untelescoping but also a variety of other moves, each somewhat analogous to the process of destabilization in the theory of Heegaard splittings. We also allowed untelescoping using semi-cut and semi-compressing discs. We proved that each of these moves decreases a certain complexity taking values in a well-ordered set and so any sequence of such moves must eventually terminate. In this paper, we will avoid using those additional moves and by allowing ourselves to consolidate punctured product compressionbodies, we can use a much simpler complexity and avoid having to use semi-cut and semi-compressing discs when untelescoping.

**Theorem 4.6.** *Suppose that  $(M, T)$  is standard and 1-irreducible and that  $T$  is weighted. Then the following hold:*

1. *There is no infinite sequence of elementary thinning moves and consolidations.*
2. *For every  $\mathcal{H} \in \overrightarrow{vp\mathbb{H}}(M, T)$ , there exists a locally thin  $\mathcal{J} \in \overrightarrow{vp\mathbb{H}}(M, T)$  such that  $\mathcal{H} \rightsquigarrow \mathcal{J}$ .*
3.  *$\text{net } \chi$ ,  $\text{net } w$ , and  $\text{net } x_m$  are each invariant under  $\rightsquigarrow$ .*

*Proof.* Conclusions (1) and (2) are similar to Sections 6.2.2 and 6.2.3 and Remark 6.15 of [44] and to [47]. However, we can handle things more simply here. Let  $c(\mathcal{H})$  be the finite sequence of non-negative integers whose entries are

$$2x_2(H) + 4 = -2\chi(H) + |H \cap T| + 2$$

for each thick surface  $H \sqsubset \mathcal{H}^+$ , arranged in non-increasing order. We compare these complexities lexicographically:  $c(\mathcal{H}) < c(\mathcal{J})$  if and only if there is some  $k$  such that either the first  $k$  entries of  $c(\mathcal{H})$  and  $c(\mathcal{J})$  coincide and the  $(k+1)$ st entry of  $c(\mathcal{H})$  is strictly smaller than the  $(k+1)$ st entry of  $\mathcal{J}$  or if  $c(\mathcal{H})$  has exactly  $k$  entries and they coincide with the first  $k$  entries of  $c(\mathcal{J})$  and  $c(\mathcal{J})$  has at least  $(k+1)$  entries. Note that these complexities are totally ordered. As with the complexity in [47], it is straightforward to show that

untelescoping using a pair of  $c$ -discs strictly decreases complexity. Consolidation removes a thick surface (and a thin surface) so it also strictly decreases complexity. As complexities are well-ordered, Conclusions (1) and (2) follow immediately.

For the proof of Conclusion (3), we show that neither consolidation nor untelescoping affect the invariants. Consolidation removes a single thick surface and a single thin surface. If  $(C, T_C)$  is a punctured product VPC with  $\partial C \subset \mathcal{H}$ , then  $x$ ,  $x_m$ ,  $-\chi$ , and  $w$  are the same for both  $\partial_+ C$  and the component of  $\partial_- C$  that we remove. Hence, consolidation does not change net  $\chi$ , net  $g$ , net  $w$ , net  $x_m$ , or net  $x$ .

We consider untelescoping. Adopt the notation of Definition 4.3. Let  $p_\pm = w(D_\pm)$ . We record the calculation for net  $x_m$  only; the others are similar, although the proof for net  $g$  requires considering the possibilities for how  $\partial D_+$  and  $\partial D_-$  separate  $H$ . Observe that (up to isotopy),  $H_\pm$  is obtained by compressing  $H$  by  $D_\pm$  and  $F$  is obtained by compressing  $H$  by  $D_+ \cup D_-$ .

Thus,

$$\begin{aligned} x_m(H_+) &= x_m(H) - m + p_+ \\ x_m(H_-) &= x_m(H) - m + p_- \\ x_m(F) &= x_m(H) - 2m + p_- + p_+ \end{aligned}$$

Thus,

$$x_m(H_+) + x_m(H_-) - x_m(F) = x_m(H).$$

□

**Theorem 4.7.** *Suppose that  $(M, T)$  is standard and 1-irreducible. If  $\mathcal{H} \in \overrightarrow{vp\mathbb{H}}(M, T)$  is locally thin, then the following hold:*

1. *Each component of  $\mathcal{H}^+$  is  $c$ -strongly irreducible in  $M \setminus \mathcal{H}^-$*
2. *Each component of  $\mathcal{H}^-$  is  $c$ -incompressible*
3. *If  $F \sqsubset \mathcal{H}^-$  is  $\partial$ -parallel in  $M \setminus T$ , then either  $F$  bounds a trivial ball compressionbody in  $(M, T)$  or there exists  $S \sqsubset \partial \dot{M}$  such that  $F$  and  $S$  cobound a trivial product compressionbody in  $(M, T)$ .*
4.  *$\mathcal{H}^-$  contains an efficient system of summing spheres for  $(M, T)$ .*
5. *Suppose  $(M, T)$  is irreducible and  $Q \subset (M, T)$  is a  $c$ -essential connected surface. If  $|Q \cap T| \neq \emptyset$ , assume that  $(M, T)$  is 2-irreducible. Then  $\mathcal{H}$  can be isotoped (transversally to  $T$ ) such that  $\mathcal{H}$  is adapted to  $Q$ .*

*Proof.* Conclusion (1) follows from the definition of “locally thin”. For Conclusion (2), assume that  $F \sqsubset \mathcal{H}^-$  is  $c$ -compressible via a  $c$ -disc  $D$ . Choose  $F$  and  $D$  so as to minimize  $|D \cap \mathcal{H}^-|$ . We claim that the interior of  $D$  is disjoint from  $\mathcal{H}^-$ . If not, choose an circle  $\zeta \subset D \cap \mathcal{H}^-$  that is innermost in  $D$ . If  $\zeta$  is essential in  $G \sqsubset \mathcal{H}^-$ , we may replace  $F$  with  $G$ , contradicting our initial choices. If  $\zeta$  is inessential in  $\mathcal{H}^-$ , we may surger  $D$  along the unpunctured or once-punctured disc in  $\mathcal{H}^-$  bounded by  $\zeta$  and again contradict our initial choices. Applying [44, Corollary 7.5] to the component of  $M \setminus \mathcal{H}^-$  containing  $D$  contradicts either Conclusion (1) or the fact that  $\mathcal{H}$  cannot be consolidated. Thus  $\mathcal{H}^-$  is  $c$ -incompressible. Hence, Conclusion (2) holds.

Suppose that  $F \sqsubset \mathcal{H}^-$  is  $\partial$ -parallel in  $M \setminus T$ . For simplicity, we may convert all vertices of  $T$  into spherical boundary-components. Then there exists the union of components  $S \subset \partial \dot{M}$  such that  $F \cup S$  bounds a submanifold  $W$  of  $\dot{M}$  and  $W \setminus \dot{T}$  is a product. In particular  $S \cup (\dot{T} \cap W)$  is connected. If  $S$  is disconnected, there must be an edge  $e$  of  $\dot{T} \cap W$  with one end on  $S_0 \sqsubset S$  and the other end on  $S \setminus S_0$ . The product structure on  $W \setminus \dot{T}$  implies that there is an annulus in  $\dot{M} \setminus \dot{T}$  with one end on  $F$  and the other on a meridian of  $e$ . This annulus caps off to a once-punctured disc  $D \subset W$  intersecting  $e$ . Compressing  $F$  along  $D$  creates two components, each  $\partial$ -parallel in  $W|_D$ . Since no component of  $\partial \dot{M}$  is a twice-punctured sphere,  $\partial D$  is essential in  $F$ . This contradicts the  $c$ -incompressibility of  $\mathcal{H}^-$ . Thus,  $S$  is connected. If  $S \neq \emptyset$ , a similar argument shows that every edge of  $\dot{T} \cap W$  must have one endpoint on  $S$  and one on  $F$ ; in particular  $\dot{T} \cap W$



consists of arcs vertical in the product structure. In which case,  $(W, \overset{\circ}{T} \cap W)$  is a product VPC, as claimed. If  $S = \emptyset$ , then  $W$  is a 3-ball and  $T \cap W$  is a single unknotted arc. This proves Conclusion (3).

Conclusion (4) is essentially the content of [44, Section 8] and is closely related to the content of [43, Corollary 4.8]. Although, the first of those references does not consider weights on the edges of  $T$  and the second is phrased for orbifolds, where the edge weights are handled differently, the argument is essentially the same. We will sketch the proof in our context momentarily, but first consider Conclusion (5).

Assume  $(M, T)$  is irreducible and that  $Q \subset (M, T)$  is c-essential. Isotope  $Q$  to intersect  $\mathcal{H}^-$  minimally. By Conclusion (3), we may assume that  $Q$  is disjoint from all components of  $\mathcal{H}^-$  that are  $\partial$ -parallel in  $M \setminus T$ . Suppose that  $\zeta \sqsubset Q \cap \mathcal{H}^-$  is inessential in  $\mathcal{H}^-$ . Without loss of generality, we may assume it is an innermost inessential loop in  $\mathcal{H}^-$ , bounding an unpunctured or once-punctured disc  $D \subset \mathcal{H}^-$ . Since  $Q$  is c-essential,  $\zeta$  is also inessential in  $Q$ . Since  $(M, T)$  does not contain a once-punctured sphere, the surface  $Q|_D$  is the union of a surface  $Q'$  and a zero or twice-punctured sphere  $P$ . At least one of the two is essential. It is easy to show that  $Q'$  remains c-incompressible, although it may be  $\partial$ -parallel. If  $P$  is inessential it either bounds a 3-ball disjoint from  $T$  or a 3-ball intersecting  $T$  in a trivial arc. Therefore, if  $P$  is inessential,  $Q$  and  $Q'$  are isotopic and we have contradicted our choice of  $Q$ . Such must be the case if  $D$  is unpunctured, as  $(M, T)$  is irreducible. If  $(M, T)$  does not contain any essential twice punctured sphere, then again  $P$  is inessential and  $Q$  and  $Q'$  are isotopic. In the setting of Conclusion (5), we have shown that all loops of  $Q \cap \mathcal{H}^-$  are essential in  $\mathcal{H}^-$ . In the setting of Conclusion (4), take  $Q$  to be an essential sphere with at most three punctures. We note that  $Q'$  and  $P$  each are spheres with at most 3 punctures. (Indeed, the number of punctures on each does not exceed the number of punctures on  $Q$ .) Since  $(M, T)$  is standard, at least one of these is essential.

Returning to the proof of Conclusion (5), suppose that  $\zeta \sqsubset Q \cap \mathcal{H}^-$  is inessential in  $Q$ . Without loss of generality, we may assume that  $\zeta$  is an innermost inessential loop in  $Q$ . Since  $\mathcal{H}^-$  is c-incompressible,  $\zeta$  must also be inessential in  $\mathcal{H}^-$ . However, we have already ruled out such loops. Thus, under the hypotheses of (4) we have produced an essential sphere with at most three punctures disjoint from  $\mathcal{H}^-$ . We continue to call the sphere  $Q$ . In the setting of Conclusion (5),  $Q \cap \mathcal{H}^-$  consists of loops essential in both  $Q$  and  $\mathcal{H}^-$ . A further isotopy of  $Q$  or  $\mathcal{H}^-$  eliminates any components of  $Q \setminus \mathcal{H}^-$  with boundary and which are isotopic to a subsurface of  $\mathcal{H}^-$ .

We now consider the intersections of each  $Q_0 \sqsubset Q \setminus \mathcal{H}^-$  with  $\mathcal{H}^+$ . Applying [44, Theorem 7.2] to  $Q_0$ , we see that, after an isotopy, either  $Q_0 \cap \mathcal{H}^+ = \emptyset$  or  $Q_0 \cap \mathcal{H}^+$  is nonempty and consists of loops that are essential in both surfaces. The latter case does not occur if  $Q = Q_0$  is a sphere with at most 3 punctures as  $Q$  does not contain any essential curves. In the context of Conclusion (5), this is what we seek.

Suppose, therefore, that  $Q_0 \cap \mathcal{H}^+ = \emptyset$ . Let  $(C, T_C) \sqsubset (M, T) \setminus \mathcal{H}$  be the VPC containing  $Q_0$ . Let  $\Delta$  be a complete set of sc-discs for  $\partial_+ C$ , chosen to intersect  $Q$  minimally. An argument nearly identical to the one concerned with  $Q \cap \mathcal{H}^-$  shows that either  $\partial_- C$  contains a zero or twice-punctured sphere or  $Q_0$  is isotopic to a component of  $\partial_- C$ . In the setting of Conclusion (5), we can continue to surger  $Q_0$  to make it disjoint from  $\Delta$ , eventually concluding that the resulting surface is isotopic to a component of  $\partial_- C$ . This concludes the proof of Conclusion (5).

For the remainder, suppose  $Q$  to be an essential sphere with three or fewer punctures. Assume  $Q$  is such a sphere, minimizing the number of possible punctures. The argument above produces an essential sphere component of  $\mathcal{H}^-$ , with at most the same number of punctures as  $Q$ . We may as well assume that  $Q \sqsubset \mathcal{H}^-$ . Let  $\mathcal{H}_1$  and  $\mathcal{H}_2$  be the restrictions of  $\mathcal{H}$  to each component of  $(M, T)|_Q$ . It is easy to check that they are locally thin. Thus, if  $(M, T)|_Q$  contains an essential sphere with three or fewer punctures, there is one in  $\mathcal{H}_1^-$  or  $\mathcal{H}_2^-$ . Continuing in this vein, we deduce that  $\mathcal{H}^-$  contains a collection of essential spheres  $S$ , each with three or fewer punctures, such that  $(M, T)|_S$  does not contain any such sphere. A subset of  $S$  is then an efficient summing system for  $(M, T)$ .  $\square$

**Corollary 4.8.** *Suppose that  $(M, T)$  is standard, irreducible, that  $Q \subset (M, T)$  is c-essential and that  $\mathcal{H} \in \overrightarrow{vp\mathbb{H}}(M, T)$ . Then the following hold:*

1. If  $Q$  is unpunctured and  $\mathcal{H}$  is locally thin, then  $\mathcal{H}$  can be isotoped to be adapted to  $Q$ .
2. If  $Q$  is punctured,  $(M, T)$  is 2-irreducible and  $\mathcal{H}$  is locally thin, then  $\mathcal{H}$  can be isotoped to be adapted to  $Q$ .
3. In both of the previous conclusions, we can replace the hypothesis that  $\mathcal{H}$  is locally thin with the hypothesis that every curve of  $\mathcal{H} \cap Q$  is essential in both  $\mathcal{H}$  and  $Q$ .

*Proof.* If  $\mathcal{H}$  is locally thin, by Theorem 4.7, we may assume that all curves of intersection between  $\mathcal{H}$  and  $Q$  are essential in both surfaces. Suppose that  $Q_0 \sqsubset Q \setminus \mathcal{H}$  is a component contained in  $(C, T_C) \sqsubset (M, T) \setminus \mathcal{H}$ . If  $Q_0$  is properly isotopic to a subsurface of  $\mathcal{H}$  via a proper isotopy keeping  $Q_0$  transverse to  $T$ , then we may isotope that thin or thick surface across  $Q_0$  reducing  $|Q \cap \mathcal{H}|$  and preserving the property that all curves of intersection are essential in both surfaces. Applying as many of these isotopies as needed shows that  $\mathcal{H}$  can be isotoped to be adapted to  $Q$ .  $\square$

We note the following fact. We do not use it until Section 10; it is used to ensure that certain complexity does not increase under certain kinds of thinning. See Figures 5 and 6.

**Lemma 4.9.** *Suppose that an elementary thinning move is applied to  $\mathcal{H}$  using discs  $D_{\pm}$ . Let  $\mathcal{J}$  be the resulting multiple bridge surface. Then each of  $D_{\pm}$  persists as an sc-disc for a thick surface of  $\mathcal{J}$ . Furthermore, suppose that  $\mathcal{K}$  is obtained by applying a sequence of elementary thinning moves and consolidations to  $\mathcal{J}$ , such that each untelescoping in the sequence uses  $D_-$  or  $D_+$  and no consolidations of  $\mathcal{K}$  are possible. Let  $\alpha$  be an oriented path in  $M$  transverse to  $\mathcal{H}$  such that if it intersects a component of  $\mathcal{H}$  it does so in a single point and with positive sign of intersection. If  $\alpha$  is disjoint from all the weak reducing pairs used in the creation of  $\mathcal{K}$ , then  $\alpha$  intersects at most one more thick surface of  $\mathcal{K}$  than  $\mathcal{H}$ .*

*Proof.* Let  $H \sqsubset \mathcal{H}^+$  be the thick surface containing  $\partial D_- \cup \partial D_+$ . Let  $H_{\pm} = H|_{D_{\pm}}$  be the new thick surfaces resulting from the untelescoping. Let  $F = H|_{D_- \cup D_+}$  be the new thin surfaces. As in the first step of Figure 5, it follows from the construction that  $\partial D_{\pm}$  can be extended to lie on  $H_{\mp}$ . Even if  $\partial D_{\pm}$  is inessential in  $H_{\mp}$ , the disc  $D_{\pm}$  is an sc-disc for  $H_{\mp}$ . Consequently, the components of  $H_{\mp}$  containing  $\partial D_{\pm}$  cannot be consolidated with components of  $F$ . As noted in Lemmas 5.7 and 5.8 of [44], a component of  $H_{\pm}$  can be consolidated with a component of  $F$  if and only if  $\partial D_{\pm}$  separates  $H$ . If the component  $H'$  of  $H_{\pm}$  containing  $\partial D_{\pm}$  can be consolidated with a component  $S \sqsubset \mathcal{H}^-$ , then we can extend  $\partial D_{\mp}$  through the product VPC bounded by  $H' \cup S$  to lie on  $S$ . Since  $S \sqsubset \mathcal{H}^-$ , the structure of the adjacent VPC, allows us to further extend  $\partial D_{\mp}$  to lie on  $\mathcal{H}^+ \setminus H$ .

Let  $\alpha$  be as in the statement of the lemma. The proof is by induction on the number of untelescopings used to generate  $\mathcal{K}$  from  $\mathcal{H}$ . Suppose, first, that a single untelescoping is used. In which case,  $\mathcal{K} = \mathcal{J}$ . As  $\alpha$  is disjoint from  $D_- \cup D_+$ , it intersects at most one component of each of  $H_- \cup H_+$ . Note that if  $\alpha$  intersects  $H$  then one of the following occurs:

1. the components of  $H_- \cup H_+$  intersecting  $\alpha$  persist into  $\mathcal{J}$  and  $|\alpha \cap \mathcal{J}^+| = |\alpha \cap \mathcal{H}^+| + 1$
2. one of the components of  $H_- \cup H_+$  intersecting  $\alpha$  is consolidated and the other persists into  $\mathcal{J}$ , in which case  $|\alpha \cap \mathcal{J}^+| = |\alpha \cap \mathcal{H}^+|$ .
3. both components of  $H_- \cup H_+$  intersecting  $\alpha$  are consolidated and  $|\alpha \cap \mathcal{J}^+| = |\alpha \cap \mathcal{H}^+| - 1$ .

Suppose there are exactly two untelescopings.  $\mathcal{K}$  is obtained from  $\mathcal{J}$  by untelescoping a thick surface which is above or below a component of  $F$  using a weak reducing pair containing  $D_-$  or  $D_+$  respectively. Without loss of generality, suppose it is a surface above a component of  $F$ . If it is a component of  $H_+$ , then as  $F$  is isotopic in  $(M, T)$  to components of  $(H_+)|_{D_-}$ , those components of  $(H_+)|_{D_-}$  are consolidated. It follows that  $|\alpha \cap \mathcal{K}^+| = |\alpha \cap \mathcal{J}| = |\alpha \cap \mathcal{J}^+|$ . If, on the other hand, in the creation of  $\mathcal{J}$ ,  $H_+$  is

consolidated, then we are in Case (2) or (3) above. The untelescoping of the component of  $\mathcal{J}^+$  (which is also a component of  $\mathcal{H}^+$ ) containing  $\partial D_-$  may create two additional thick surfaces intersecting  $\alpha$ . Consequently,  $|\alpha \cap \mathcal{K}^+| \leq |\alpha \cap \mathcal{J}^+| + 1 \leq |\alpha \cap \mathcal{H}^+| + 1$ . Call the  $+1$  that arises in this argument, the **positive error term**.

When there are more untelescoping, the argument proceeds in the same way: if  $\partial D_-$  remains on one of the surfaces resulting from an untelescoping, that surface, after compressing along  $D_-$  will consolidate with the new thin surface. Whereas, if  $\partial D_-$  is moved to a new component of  $\mathcal{H}^+$ , we must have consolidated one of the thick surfaces created by the untelescoping with a component of  $\mathcal{H}^-$ . Consequently, the positive error terms do not accumulate. See Figure 6.  $\square$

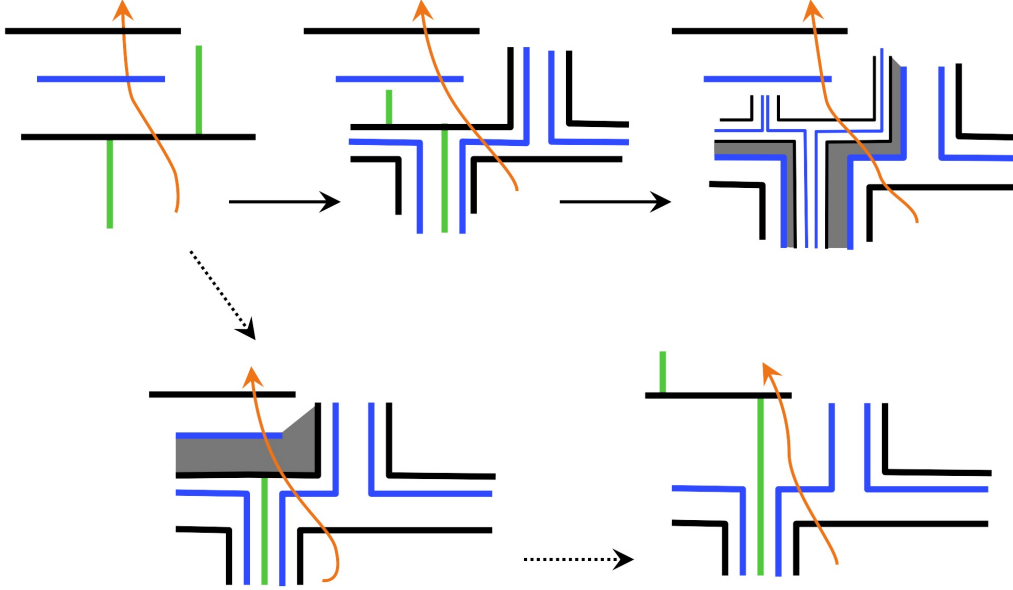

Figure 6: In the top left we show a multiple bridge surface  $\mathcal{H}$  with two thick surfaces and one thin surface. We also show in orange a path  $\alpha$  consistent with the orientations of  $\mathcal{H}$  (not shown) and a weak reducing pair of discs (in green) with boundary on a thick surface  $H$ . Following the solid arrows we untelescope  $H$  and then find a weak reducing pair for  $H_+$ ; one of the pair is  $D_-$ . Untelescoping  $H_+$  we discover that one of the new thick surfaces intersecting  $\alpha$  is parallel to a thin surface intersecting  $\alpha$ . After consolidating, we see that  $|\alpha \cap \mathcal{K}^+| = |\alpha \cap \mathcal{H}^+| + 1$ . Following the dashed black arrows, we see the case when the component of  $H_+$  intersecting  $\alpha$  is parallel to a component of  $\mathcal{H}^-$ . Consolidating those surfaces and then untelescoping another thick surface using a weak reducing pair containing  $D_-$  we see that  $|\alpha \cap \mathcal{K}^+| = |\alpha \cap \mathcal{H}^+| + 1$ . There are of course other choices for  $\alpha$ , but for each if we keep track of the consolidations, we see that Lemma 4.9 holds.

## 4.2 Amalgamation

As we can see from the definition of untelescoping, thinning generally leads to the creation of a multiple bridge surface that has more components than the original multiple bridge surface did. Amalgamation (originally defined in [37]) is the inverse operation where we begin with a multiple bridge surface with many components and obtain a new multiple bridge surface that has fewer (but generally more complex) components. The presence of a knot, link, or spatial graph  $T$  makes this operation more subtle than in the case of a 3-manifold

without a graph and in fact the operation is not always allowed. The next lemma outlines the condition that needs to be met for amalgamation to result in a new multiple v.p. bridge surface.

**Lemma 4.10** ([43, Lemma 6.3]). *Suppose that  $\mathcal{H} \in \overrightarrow{\text{vp}\mathbb{H}}(M, T)$  and suppose  $w$  is a weight system for  $T$ . Let  $(C_i, T_i) \sqsubset (M, T) \setminus \mathcal{H}$  for  $i = 1, 2$  be VPCs such that  $F = \partial_- C_1 \cap \partial_- C_2 \neq \emptyset$ . Let  $H_i = \partial_+ C_i$ . Suppose there does not exist a ghost arc in  $C_1$  sharing an endpoint with a ghost arc in  $C_2$ . Then there exists a surface  $H \subset C_1 \cup C_2$  such that  $\mathcal{J} = H \cup (\mathcal{H} \setminus (H_1 \cup H_2 \cup F))$  is an oriented multiple bridge surface for  $(M, T)$  with  $H \sqsubset \mathcal{J}^+$ . Furthermore,  $\text{net } x$ ,  $\text{net } x_m$ ,  $\text{net } \chi$ ,  $\text{net } g$ , and  $\text{net } w$  are the same for  $\mathcal{H}$  as for  $\mathcal{J}$ .*

*Proof.* In [43] we show that  $H$  and  $\mathcal{J}$  exist. The equalities concerning the invariants follow from the construction or from the fact that  $\mathcal{J}$  thins back to  $\mathcal{H}$ .  $\square$

**Definition 4.11.** Using the notation of the previous lemma we say that  $H$  is obtained by **amalgamating**  $H_1$  and  $H_2$  across  $F$  and that  $\mathcal{J}$  is obtained by an amalgamation of  $\mathcal{H}$ .

The proof of the following is an easy exercise using Lemma 4.10. The version for  $g = 0$  can be found as [22, Theorem 2.11]. The proof for  $g = 1$  is nearly identical. There is no analogous result for  $g > 1$  or if  $L$  is a spatial graph that is not a link.

**Lemma 4.12.** *Suppose that  $(M, L)$  is a pair with  $M$  either  $S^3$  or a lens space and  $L$  a weighted link. If  $\mathcal{H} \in \overrightarrow{\text{vp}\mathbb{H}}(M, T)$  has  $g = \text{net } g(\mathcal{H}) \in \{0, 1\}$ , then  $\mathcal{H}$  amalgamates to a genus  $g$  bridge surface  $H$  for  $(M, L)$  with  $\text{net } w(\mathcal{H}) = w(H)$ . Consequently,  $\text{net } w_g(\mathbf{L})/2 = \mathbf{b}_g(\mathbf{L})$ .*

## 5 Simple Cases

As a prelude to the more involved work of most of the paper, in this section we dispense with several simple cases. At the conclusion of the section we give a new proof of Schubert's and Doll's additivity theorems, applicable in a much more general context. From there we prove the [Main Theorem](#) when  $\omega = 1$ ; that proof contains one of the key ideas used in the general proof.

We start with two results that allow us to reduce to considering only irreducible pairs. Lemma 5.1 is essentially due to Hayashi-Shimokawa [21].

**Lemma 5.1** (Distant Sums). *Suppose that for  $i = 0, 1$ , the pair  $(M_i, T_i)$  is standard with  $T_i$  weighted and suppose  $(M, T) = (M_0, T_0) \#_0 (M_1, T_1)$ . Then for any  $g \geq \mathbf{g}(M)$ , there exist  $g_0 \geq \mathbf{g}(M_0)$  and  $g_1 \geq \mathbf{g}(M_1)$  such that  $g_0 + g_1 = g$  and*

$$\mathbf{b}_g(M, \mathbf{T}) = \mathbf{b}_{g_0}(M_0, \mathbf{T}_0) + \mathbf{b}_{g_1}(M_1, \mathbf{T}_1)$$

,

*Proof.* Suppose  $g_i \geq \mathbf{g}(M_i)$  for  $i = 0, 1$  and  $g_0 + g_1 = g$ . Also for  $i = 0, 1$ , let  $H_i$  be a genus  $g_i \geq \mathbf{g}(M_i)$  bridge surface for  $(M_i, T_i)$  such that  $\mathbf{b}_{g_i}(\mathbf{T}_i) = w(H_i)/2$ . By performing the connected sum of  $(M_0, T_0)$  and  $(M_1, T_1)$  along points  $p_0 \in H_0 \setminus T_0$  and  $p_1 \in H_1 \setminus T_1$ , we can also form a Heegaard surface  $H = H_0 \# H_1$  for  $(M, T)$  with  $g = \mathbf{g}(H) = g_0 + g_1$  and  $w(H) = w(H_0) + w(H_1)$ . This Heegaard surface is also a bridge surface for  $(M, T)$ , so  $\mathbf{b}_g(\mathbf{T}) \leq \mathbf{b}_{g_0}(\mathbf{T}_0) + \mathbf{b}_{g_1}(\mathbf{T}_1)$ .

For the other inequality, let  $H$  be a genus  $g$  bridge surface for  $(M, T)$  such that  $\mathbf{b}_g(\mathbf{T}) = w(H)/2$ . By [21, Theorem 1.3], there exists a collection  $S \subset (M, T)$  of essential unpunctured spheres, each intersecting  $H$  in a single simple closed curve such that  $(M, T)|_S$  is irreducible. The collection  $S$  lies in an efficient summing system such that every other sphere in the system is twice or thrice-punctured. So up to homeomorphism, the collection  $S$  and the factors  $(M, T)|_S$  are unique by Lemma 2.11. In  $(M, T)|_S$ , we may cap  $H \setminus S$  off with discs to obtain bridge surfaces for each component of  $(M, T)|_S$ . As in the previous paragraph, for each

$i = 0, 1$ , we may reassemble the bridge surfaces for the factors of  $(M_i, T_i)$  to construct a bridge surface  $H_i$  for  $(M_i, T_i)$  of genus  $g_i$  such that  $g_0 + g_1 = g$ . Consequently,  $\mathfrak{b}_{g_0}(\mathbf{T}_0) + \mathfrak{b}_{g_1}(\mathbf{T}_1) \leq \mathfrak{b}_g(\mathbf{T})$ .  $\square$

The next lemma will allow us to assume 1-irreducibility throughout, since, as every sphere in  $M$  is separating, if  $(M, T)$  is not 1-irreducible, then it is the result of an edge sum.

**Lemma 5.2** (Cut edge sums). *Suppose that  $(M, T) = (M_0, T_0) \#_e (M_1, T_1)$  is a standard pair. Then for any  $g \geq g(M)$ , there exist  $g_0 \geq g(M_0)$  and  $g_1 \geq g(M_1)$  such that  $g_0 + g_1 = g$  and*

$$\mathfrak{b}_g(M, \mathbf{T}) = \mathfrak{b}_{g_0}(M_0, \mathbf{T}_0) + \mathfrak{b}_{g_1}(M_1, \mathbf{T}_1).$$

*Proof.* Any edge of  $T$  intersecting a sphere in  $M$  exactly once transversally is a cut edge for  $T$ . Let  $E = \{e_1, \dots, e_n\}$  be the set of cut edges intersecting once-punctured spheres  $S \subset (M, T)$  exactly once each. For each  $i$ , let  $p_{\pm}(i)$  be the endpoints of  $e_i$ . Note that  $(M, T \setminus E)$  is 1-irreducible and that it can be formed by iterated distant sums with the spheres  $S$  as summing spheres. For  $j = 0, \dots, n$  let  $(M'_j, T'_j)$  be the factors corresponding to summing along  $S$ .

Let  $H'_j$  be a bridge surface for  $(M'_j, T'_j)$  with  $g(H'_j) = g_j$ ,  $\sum_j g_j = g$ , and  $\mathfrak{b}_{g_j}(\mathbf{T}'_j) = w(H'_j)/2$ . As in Lemma 5.1, we may sum the  $H'_j$  to get a bridge surface  $H$  for  $(M, T \setminus E)$  with  $g(H) = g$  and  $w(H) = \sum w(\mathbf{T}'_j)$ . Lemma 5.1 tells us that  $w(H)/2 = \mathfrak{b}_g(\mathbf{T} \setminus E)$ .

We take a closer look at the construction. The points  $p_{\pm}(i)$  lie on the graphs  $T'_j$ , with  $p_-(i)$  and  $p_+(i)$  on different graphs. A small isotopy ensures that no  $p_{\pm}(i)$  lies in any  $H'_j$ . Thus, each  $p_{\pm}(i)$  is either above or below the surface  $H'_j$  with  $T'_j$  containing  $p_{\pm}(i)$ . Since all the summing spheres are separating, the dual graph to  $S$  in  $M$  is a tree. Choosing a root for that tree and working outward, we may reverse orientations on the  $H'_j$  as needed so that either all  $p_{\pm}(i)$  lie above the  $H'_j$  with  $p_{\pm}(i) \in T'_j$  or all lie below. Without loss of generality, assume that all lie above. Thus, in  $T \setminus E$ , all  $p_{\pm}(i)$  lie above the surface  $H$ . We may then insert edges  $e'_i$  joining  $p_-(i)$  to  $p_+(i)$  such that each  $e'_i$  is disjoint from  $H$  and intersects  $S$  exactly once and so that  $H \in \overrightarrow{vp\mathbb{H}}(M, T')$  where  $T' = (T \setminus E) \cup \bigcup_i e'_i$ . By Lemma 2.13,  $T'$  and  $T$  are isotopic. Thus,  $H \in \overrightarrow{vp\mathbb{H}}(M, T)$  and  $\mathfrak{b}_g(\mathbf{T}) \leq \mathfrak{b}_g(\mathbf{T} \setminus E)$ . For the other inequality, note that if  $H$  is a bridge surface for  $(M, \mathbf{T})$  then it is also a bridge surface for  $(M, \mathbf{T} \setminus E)$ . Thus,  $\mathfrak{b}_g(\mathbf{T}) = \mathfrak{b}_g(\mathbf{T} \setminus E)$ . The stated equality follows from induction on the number of cut edges.  $\square$

We now prove Schubert's and Doll's Additivity Theorems<sup>1</sup> [10]. This is similar to the work in [42]. We include it both for completeness and because it encapsulates the central philosophy of our arguments. We take the opportunity to generalize the classical theorems. We could generalize further to the situation when  $T_0$  and  $T_1$  are not links; however, the statements become less clean as one has to take into account ghost arcs and it does not seem possible to give a clean statement that specifies in all cases exactly how  $\mathfrak{b}_0(\mathbf{T})$  relates to  $\mathfrak{b}_0(\mathbf{T}_1)$  and  $\mathfrak{b}_0(\mathbf{T}_2)$  (for example).

**Additivity Theorem.** *Suppose that  $(M_0, T_0)$  and  $(M_1, T_1)$  are weighted standard pairs with  $M_0 = S^3$  and  $M_1$  either  $S^3$  or a lens space. Assume that there is no twice-punctured sphere in either  $(M_i, T_i)$  with punctures of different weights. Suppose  $(M, T) = (M_0, T_0) \#_2 (M_1, T_1)$ , with the sum respecting the weights. Let  $u$  be the weight of the edges where the sum is performed. If both  $T_0$  and  $T_1$  are links, then*

1. If  $M_2 = S^3$ ,  $\mathfrak{b}_0(\mathbf{T}) = \mathfrak{b}_0(\mathbf{T}_0) + \mathfrak{b}_0(\mathbf{T}_1) - u$ , and
2. There exist  $g_0, g_1 \in \{0, 1\}$  with  $g_0 + g_1 = 1$ , and so that  $\mathfrak{b}_1(\mathbf{T}) = \mathfrak{b}_{g_0}(\mathbf{T}_0) + \mathfrak{b}_{g_1}(\mathbf{T}_1) - u$ . Furthermore, if  $M_1 \neq S^3$ , then  $g_1 = 1$ .

---

<sup>1</sup>We note that in [10, Section 6], Doll claims to give a counter-example to the theorem when  $g = 1$  and  $K_2$  is either link in  $S^3$  of two components or a knot in a lens space. However, both these counter-examples rely on considering the core loop  $\lambda$  of a genus 1 Heegaard splitting to have  $\mathfrak{b}_1(\lambda) = 1$ . Taking  $\mathfrak{b}_1(\lambda) = 0$ , as we do, breaks the counterexample.

*Proof.* Note that  $(M, T)$  is irreducible if and only if both  $(M_0, T_0)$  and  $(M_1, T_1)$  are. From Theorems 5.1 and 5.2, we may assume that all three pairs are irreducible. Also note that no twice-punctured sphere in  $(M, T)$  has punctures of distinct weights.

We start by showing “ $\leq$ ” in both inequalities. For  $i \in \{1, 2\}$ , let  $H_i$  be a bridge surface for  $(M_i, \mathbf{T}_i)$  such that  $g(H_i) = g_i$  and  $w(H_i)/2 = \mathfrak{b}_{g_i}(\mathbf{T}_i)$ . Assume that  $g_0 + g_1 = g \in \{0, 1\}$ . Let  $p_0 \in T_0$  and  $p_1 \in T_1$  be the points where the sum is performed. Without loss of generality, we may assume that  $p_i \notin H_i$ . Form  $(M, T) = (M_1, T_1) \#_2 (M_2, T_2)$  by performing a connected sum at  $p_1$  and  $p_2$ . Let  $S \subset (M, T)$  be the summing sphere. Assign an orientation to  $S$  consistent with that on  $H_1$  and, if needed, reverse the orientation on  $H_2$  so that  $\mathcal{H} = H_1 \cup H_2 \cup S \in \overrightarrow{vp\mathbb{H}}(M, T)$  with  $\mathcal{H}^+ = H_1 \cup H_2$  and  $\mathcal{H}^- = S$ . Observe that  $\text{net } g(\mathcal{H}) = g_1 + g_2 = g$  and  $\text{net } w(\mathcal{H}) = 2\mathfrak{b}_{g_0}(\mathbf{T}_1) + 2\mathfrak{b}_{g_1}(\mathbf{T}_2) - 2u$ . As  $T$  is a link, by Lemma 4.10,  $\mathfrak{b}_g(\mathbf{T}) \leq \mathfrak{b}_{g_0}(\mathbf{T}_1) + \mathfrak{b}_{g_1}(\mathbf{T}_2) - u$ .

For the other inequalities, suppose  $g(M) \leq g \in \{0, 1\}$ . By Theorem 4.6, there exists locally thin  $\mathcal{H} \in \overrightarrow{vp\mathbb{H}}(M, T)$  such that  $\text{net } g(\mathcal{H}) = g$  and  $\text{net } w(\mathcal{H})/2 = \mathfrak{b}_g(\mathbf{T})$ . By Proposition 4.7,  $\mathcal{H}$  contains an efficient summing system  $S$  for  $(M, T)$ . Discard from  $S$  all thrice-punctured spheres. By Lemma 2.11,  $(M, T)|_S = (M'_1, T'_1) \cup \cdots \cup (M'_n, T'_n)$  is the disjoint union of all the factors of  $(M_0, T_0)$  and  $(M_1, T_1)$ . Each  $(M'_i, T'_i)$  is irreducible and is without an essential twice-punctured sphere. Some of these factors maybe copies of  $(S^3, \text{unknot})$ , and one may be  $(M_1, \emptyset)$ . By Theorem 2.11, each of these factors is a factor of either  $(M_0, T_0)$  or  $(M_1, T_1)$ . Let  $h$  be the homeomorphism taking  $S$  to the union of summing spheres for  $(M_0, T_0)$  with summing spheres for  $(M_1, T_1)$  with a summing sphere separating  $(M_0, T_0)$  from  $(M_1, T_1)$ . Let  $n_0$  and  $n_1$  be the number of factors of  $(M_0, T_0)$  and  $(M_1, T_1)$  respectively. Assume that for  $i \leq n_0$ , each  $(M'_i, K'_i)$  is a factor of  $(M_0, T_0)$ .

Let  $\mathcal{H}'_i$  be the restriction of  $\mathcal{H}$  to  $(M'_i, T'_i)$  and  $g'_i = \text{net } g(\mathcal{H}'_i)$  and  $w'_i = \text{net } w(\mathcal{H}'_i)$ . We have  $g = g'_1 + \cdots + g'_n$  and  $\text{net } w(\mathcal{H}) = -w(S) + w'_1 + \cdots + w'_n$ . By Lemma 4.12, each  $w'_i/2 \geq \mathfrak{b}_{g'_i}(\mathbf{T}'_i)$ . For  $j = 0, 1$ , let  $S_j \subset S$  the spheres taken into  $(M_j, T_j)$  by the homeomorphism  $h$ . Hence,

$$\begin{aligned} \mathfrak{b}_g(K) &\geq -w(S)/2 + \sum_{i=1}^n \mathfrak{b}_{g'_i}(\mathbf{T}'_i) \\ &= -u - w(S_0)/2 + \sum_{i=1}^{n_0} \mathfrak{b}_{g'_i}(\mathbf{T}'_i) - w(S_1)/2 + \sum_{i=n_0+1}^n \mathfrak{b}_{g'_i}(\mathbf{T}'_i) \\ &\geq -u + \mathfrak{b}_{g_1}(\mathbf{T}_0) + \mathfrak{b}_{g_2}(\mathbf{T}_1). \end{aligned}$$

The final inequality is obtained by recombining the factors of  $(M_0, T_0)$  and  $(M_1, T_1)$  and applying the results of the first paragraph of the proof. We define  $g_1 = g'_1 + \cdots + g'_{n_1}$  and  $g_2 = g'_{n_1+1} + \cdots + g'_n$ .

Since we have proved both inequalities, the proof of the lemma is complete.  $\square$

**Corollary 5.3** (Main Theorem for  $\omega = 1$ ). *Suppose that  $(M, T)$  is a standard pair with  $M$  either  $S^3$  or a lens space. Suppose that there exists an essential unpunctured torus  $Q \subset (M, T)$  which is compressible into a side  $V \sqsubset M \setminus Q$  and that  $T \setminus V$  is a link. Suppose that the weighted wrapping number of  $T \cap V$  in  $V$  is  $\omega = 1$  and that  $\mathbf{L}$  is a weighted companion with respect to  $V$  (albeit, all weights are equal to 1). Then for  $g \in \{0, 1\}$ , we have*

$$\mathfrak{b}_g(T) \geq \mathfrak{b}_g(\mathbf{L}) - \delta.$$

where  $\delta = 0$  if  $V$  is a solid torus and  $\delta = 1$  if  $V$  is a lensed solid torus.

*Proof.* Use a cut disc  $D$  for  $Q$  in  $V$  to compress  $Q$  into  $V$ , obtaining an essential-twice-punctured sphere  $Q'$ . The weight of  $D$  is equal to 1. The sphere  $Q'$  realizes  $(M, T) = (M_0, T_0) \#_2 (M_1, T_1)$  where  $T_1$  contains  $(T \cap V) \setminus \eta(D)$ . The proof is now similar to that of the Additivity Theorem. By Theorems 5.1 and 5.2, we may assume that  $(M, T)$  is irreducible. Note that  $T_0$  coincides with  $\mathbf{L}$  outside of the arc used in the surgery creating  $(M, T)|_{Q'}$ .

Let  $\mathcal{H} \in \overrightarrow{vp\mathbb{H}}(M, T)$  be such that  $\text{net } g(\mathcal{H}) = g$  and  $\text{net } w(\mathcal{H}) = \text{net } w_g(T)$ . By definition,  $\text{net } w_g(T) \leq \mathfrak{b}_g(T)$ . By Proposition 4.7,  $\mathcal{H}^-$  contains an efficient summing system for  $(M, T)$ . Discard from  $S$  all thrice-punctured

spheres. As in the proof of the [Additivity Theorem](#), we see that there exist  $g_0 \geq g(M_0)$  and  $g_1 \geq g(M_1)$  such that  $g_0 + g_1 = g$  and:

$$\mathfrak{b}_g(T) \geq \text{net } w_g(T)/2 \geq \text{net } w_{g_0}(T_0)/2 + \text{net } w_{g_1}(T_1)/2 - 1.$$

Since  $T_0$  is a link, by [Lemma 4.12](#),  $\text{net } w_{g_0}(T_0)/2 = \mathfrak{b}_{g_0}(T_0)$ .

By [Corollary 3.18](#),  $\text{net } w_{g_1}(T_1) \geq 0$ . If  $g_1 = 0$ , then  $\text{net } w_{g_1}(T_1) \geq 1$ . However, as  $(M_1, T_1)$  is 1-irreducible (or by the properties of bridge spheres), we must actually have  $\text{net } w_0(T_1) \geq 2$ . In which case,  $\mathfrak{b}_g(T) \geq \mathfrak{b}_{g_0}(T_0)$ . Suppose that  $g_1 = 1$ . If  $M_2$  is a lens space, then  $T$  is a lensed satellite and we have the desired inequality. If  $M_2 = S^3$ , then  $M = S^3$ . We have

$$\mathfrak{b}_1(T) \geq \mathfrak{b}_0(L) - 1.$$

However, as we pointed out in [Remark 3.7](#), since  $L$  cannot be isotoped to be disjoint from a bridge sphere for  $S^3$  and since all the weights are equal to 1.  $\mathfrak{b}_0(L) \geq \mathfrak{b}_1(L) + 1$ . In which case,  $\mathfrak{b}_1(T) \geq \mathfrak{b}_1(L)$  as desired.  $\square$

## 6 Crushing

Throughout this section we make the following assumption.

**Assumption 6.1.** *Assume that  $(M, T)$  is standard and irreducible, that  $Q \subset (M, T)$  is a  $c$ -essential torus, and that  $\mathcal{H} \in \mathbb{H}(Q)$ .*

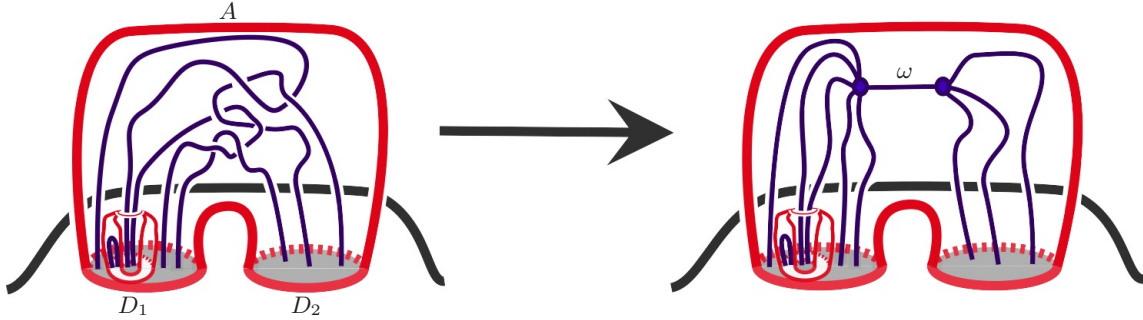

Figure 7: On the left, the outer annulus is a crushable handle. On the right, we show the result of crushing  $T$  using that crushable handle.

**Definition 6.2.** See [Figure 7](#) for a depiction. Suppose that  $\mathcal{H}$  is a multiple bridge surface for  $(M, T)$  and that  $A \sqsubset Q \setminus \mathcal{H}$  is a bridge annulus and that the ends of  $A$  bound disjoint discs  $D_1$  and  $D_2$  in  $\mathcal{H}^+$ . Then  $A$  is a **crushable handle**, if, for each  $i = 1, 2$ , whenever a component  $A'$  of  $Q \setminus \mathcal{H}$  in the same VPC as  $A$  has one end in  $D_i$ , then both ends of  $A'$  lie in  $D_i$  and they do not bound disjoint discs in  $D_i$ .

**Lemma 6.3.** *Suppose that  $A \sqsubset Q \setminus \mathcal{H}$  is a crushable handle with ends bounding disjoint discs  $D_1, D_2 \subset \mathcal{H}^+$ . Then there exists a disc  $D$  on the same side of  $A$  as  $D_1 \cup D_2$ , with  $\partial D$  an essential loop in  $A$ , and with the interior of  $D$  disjoint from  $Q$ .*

We call the disc  $D$  in the conclusion of [Lemma 6.3](#) a **crushing disc** for  $A$ .

*Proof.* Let  $(C, T_C)$  be the VPC containing  $A$ . Suppose that  $D \subset (C, T_C)$  is a disc with interior disjoint from  $A$ , on the same side of  $A$  as the discs  $D_1$  and  $D_2$  and with  $\partial D \subset A$  parallel to each of  $\partial D_1$  and  $\partial D_2$ , but

disjoint from  $\partial C$ . Observe that a pushoff of  $D_1$  or  $D_2$  is such a disc. Choose such a disc  $D$  that intersects  $T$  minimally and, out of all such, minimizes  $|D \cap Q|$ ; such a disc may well intersect  $T$  more than either  $D_1$  or  $D_2$ . We claim that the interior of  $D$  is disjoint from  $Q$ .

Suppose to the contrary that  $D$  intersects some component  $A'' \sqsubset Q \cap C$ . One end of  $A''$  must lie in either  $D_1$  or  $D_2$ . Suppose, it is  $D_1$ . By definition, the other end of  $A''$  also lies in  $D_1$  and one end of  $A''$  bounds a disc in  $D_1$  containing the other end. An innermost disc argument shows that  $D \cap A''$  consists of curves that are essential in  $A''$ . Each component of  $A'' \setminus D$  is either an annulus with ends on  $D$  or an annulus with one end on  $D$  and one end also an end of  $A''$ . There must be a component  $A''_0 \sqsubset A'' \setminus D$  with ends on  $D$  and with one end bounding a disc in  $D$  containing the other end. An annulus swap converts  $D$  to a disc that intersects  $Q$  fewer times and intersects  $T$  no more times than does  $D$ . This contradicts our choice of  $D$ .  $\square$

**Lemma 6.4.** *Let  $B \subset V$  be the submanifold of  $M$  with boundary the sphere  $A \cup D_0 \cup D_1$  and which is inside  $A$ . Let  $(C, T_C)$  be the VPC containing  $A$ . Then each component of  $\partial_- C$  contained in  $B$  is a sphere belonging to  $\mathcal{H}^-$ .*

*Proof.* The annulus  $A$   $\partial$ -compresses to a disc  $D$  such that  $\partial D$  bounds a disc  $E \subset \partial_+ C$ .  $\partial$ -reducing  $(C, T_C)$  along  $E$  produces two VPCs, one of which has spherical boundary containing  $E$ . Its negative boundary is exactly  $\partial_- C \cap B$ . By Lemma 3.3, it is the union of spheres.  $\square$

**Construction 6.5.** *Use the preceding notation and see Figure 7 for a depiction. Let  $\widehat{M}$  be the result of surgering  $M$  along the components of  $\partial_- C \cap B$ ; each of those components belongs to  $\mathcal{H}^-$ . Discard from  $\widehat{M}$  those components not containing  $A$ . Let  $\widehat{B}, \widehat{V}$  be the surgery applied to  $B, V$  respectively. Let  $\widehat{\mathcal{H}}$  be the result of discarding from  $\mathcal{H}$  all components completely contained in  $B$ . Let  $\Pi$  be the path component of  $\widehat{B} \setminus Q$  containing the interior of the crushing disc  $D$  from Lemma 6.3.*

*Let  $\widehat{T}$  be the graph constructed as follows. Outside of  $\Pi$ ,  $\widehat{T}$  coincides with  $T$ . Inside  $\Pi$ , the graph  $\widehat{T}$  is defined to be a tree  $\tau$  with exactly two internal vertices  $V(\tau)$  and with leaves equal to  $T \cap (D_1 \cup D_2) \cap \Pi$ . There is exactly one edge having endpoints  $V(\tau)$ , and  $\tau$  is isotopic, relative to its endpoints and in the complement of  $T \setminus \Pi$ , into  $D_1 \cup D_2 \cup A$ , with  $e$  going to a spanning arc of  $A$ . We give  $e$  weight  $\omega$ , where  $\omega$  is the wrapping number of  $T \cap V$  in  $V$ . We call  $e$  the **newly crushed edge**.*

*We say that  $(\widehat{M}, \widehat{V}, \widehat{T}, \widehat{\mathcal{H}})$  is obtained from  $(M, V, T, \mathcal{H})$  by **crushing along handle  $A$** .*

**Remark 6.6.** Observe that the crushing disc becomes a cut-disc. Figure 8 shows the result of compressing along that disc.

**Remark 6.7.** By the definition of crushable handle, there are disc components of  $D_1 \setminus Q$  and  $D_2 \setminus Q$  which lie in  $\Pi$ . These discs are compressing discs for  $Q$  in  $V$  and thus intersect  $T$  at least  $\omega$  times each. Thus, each of the endpoints of  $e$  has degree at least  $\omega + 1$ .

**Lemma 6.8.** *Suppose that  $(\widehat{M}, \widehat{V}, \widehat{T}, \widehat{\mathcal{H}})$  is obtained from  $(M, V, T, \mathcal{H})$  by crushing along a handle. Then the following hold:*

1.  $\widehat{\mathcal{H}} \in \overline{vp\mathbb{H}}(\widehat{M}, \widehat{T})$
2.  $\text{net } x_\omega(\widehat{\mathcal{H}}; \widehat{T}) = (\omega - 1) \text{net } \chi(\widehat{\mathcal{H}})/2 + \text{net } x(\widehat{\mathcal{H}}; T)$ .
3.  $Q$  is an essential unpunctured torus in  $(\widehat{M}, \widehat{T})$  and the weighted wrapping number of  $\widehat{T} \cap \widehat{V}$  in  $\widehat{V}$  is equal to  $\omega$ . Furthermore, there is a cut compressing disc in  $\widehat{V}$  for  $Q$  intersecting the newly weighted edge.
4.  $(\widehat{M}, \widehat{T})$  is irreducible and no essential twice-punctured sphere in  $(\widehat{M}, \widehat{T})$  has punctures of different weights.



*Proof.* Throughout we use the notation of Construction 6.5.

We first show Claim (1). Let  $(C, T_C)$  be the VPC containing the handle  $A$ . As we remarked in Lemma 6.4, components of  $\partial_- C$  contained completely interior to  $B$  are spheres, so surgering  $(M, T)$  along those spheres and discarding the pairs that don't contain  $Q$  does not change the fact that we have a multiple bridge surface. Consequently, we may assume that  $B$  is a 3-ball and no component of  $\partial_- C$  is interior to  $B$ . Each component of  $Q \cap B$  (other than  $A$ ) is an annulus with both ends in  $D_0$  or with both ends in  $D_1$ . Each separates  $C$ . Let  $T'_C = T_C \setminus \Pi$  and note that  $(C, T'_C)$  is a VPC and that the crushing disc  $D$  is an unpunctured disc. Let  $D'_0$  and  $D'_1$  be the two unpunctured discs that result from compressing  $A$  along  $D$  in  $(C, T'_C)$ . We may, therefore, choose a complete set of sc-discs  $\Delta$  for  $(C, T'_C)$  that are disjoint from  $A \cup D$  and which contain  $D'_0, D'_1$ . It remains a complete set of discs for  $(C, T'_C \cup (\tau \setminus e))$ , since each component of  $\tau \setminus e$  is isotopic into  $D_0$  or  $D_1$ . Putting in the edge  $e$  turns  $D'_0$  and  $D'_1$  into cut discs, but preserves the fact that  $\Delta$  is a complete set of discs. Consequently,  $(C, \widehat{T} \cap C)$  is a VPC. It follows that  $\widehat{\mathcal{H}} \in \overline{vp}\mathbb{H}(\widehat{M}, \widehat{T})$ .

We now show Claim (2). Since  $\partial_+ C \cap T = \partial_+ C \cap \widehat{T}$  and those points all have weight equal to 1, we need only compare the effect of the crushing on components of  $\mathcal{H}$  completely internal to  $B$ . It suffices to consider the case when there is a single component  $F \sqsubset \mathcal{H}^- \cap B$ . (If there are more, simply iterate the following calculations.) Recall that  $F$  is a punctured sphere, which must separate  $M$ . The sphere  $F$  bounds a submanifold  $W_F \subset B$ . Let  $\mathcal{H}_F$  be those components of  $\mathcal{H}$  interior to  $W_F$ . Since (in the absence of  $T$ )  $\mathcal{H}_F$  amalgamates to a Heegaard splitting for  $W_F$ ,  $\text{net } \chi(\mathcal{H}_F) \geq x(F)$ . Thus,  $\text{net } \chi(\widehat{\mathcal{H}}) \leq \text{net } \chi(\mathcal{H})$ . By Theorem 3.16,  $x(F) \leq \text{net } x(\mathcal{H}_F)$ . Thus,

$$\text{net } x(\widehat{\mathcal{H}}; \widehat{T}) = \text{net } x(\mathcal{H}; T) - (\text{net } x(\mathcal{H}_F) - x(F)) \leq \text{net } x(\mathcal{H}; T).$$

The newly weighted edge  $e$  of  $\widehat{T}$  is disjoint from  $\widehat{\mathcal{H}}$ ; it does not contribute anything to  $\text{net } x_\omega(\widehat{\mathcal{H}}; \widehat{T})$ . Consequently,

$$\begin{aligned} \text{net } x_\omega(\widehat{\mathcal{H}}; \widehat{T}) &= (\omega - 1) \text{net } \chi(\widehat{\mathcal{H}})/2 + \text{net } x(\widehat{\mathcal{H}}; \widehat{T}) \\ &\leq (\omega - 1) \text{net } \chi(\mathcal{H})/2 + \text{net } x(\mathcal{H}; T), \end{aligned}$$

as desired.

We prove Claim (3). Since, by Lemma 6.3, there is a cut-disc for  $Q$  with boundary equal to  $\partial D$  and intersecting the edge  $e$ , the weighted wrapping number is at most  $\omega$ . Suppose that there exists a properly embedded disc  $E$  in  $V$  with essential boundary in  $Q$  and of weight strictly less than  $\omega$ . Then  $E \cap e = \emptyset$ . The disc  $E$  can then be properly isotoped to be disjoint from  $\Pi$ . That is, it is a compressing disc for  $Q$  in  $V$ . But this implies the wrapping number for  $T \cap V$  in  $V$  would be strictly less than  $\omega$ , a contradiction. Thus, the weighted wrapping number of  $\widehat{T} \cap \widehat{V}$  in  $\widehat{V}$  is exactly  $\omega$ .

Finally, we prove Claim (4). Suppose that  $P \subset (\widehat{M}, \widehat{T})$  is an essential sphere which is unpunctured, once-punctured, or twice-punctured with punctures of different weights. In the latter case, one puncture on  $P$  lies in  $\widehat{T} \setminus e$  and the other in  $e$ . We can reconstruct  $(M, T)$  from  $(\widehat{M}, \widehat{T})$ , by removing a regular neighborhood of  $e$  and re-inserting pieces of  $T$ ,  $M$ , and  $\mathcal{H}$ . By doing so, we see that  $P$  gives rise to a an essential sphere, or a compressing disc for  $Q$  in  $(M, T)$  or a cut-disc for  $Q$  in  $(M, T)$ . All contradict our initial assumptions.  $\square$

The next theorem contains the essence of the proof of the [Main Theorem](#) in the case when we can find a crushable handle.

**Theorem 6.9** (Handle-Crushing Theorem). *Assume that:*

- $(M, T)$  is standard and irreducible,  $Q \subset (M, T)$  is a  $c$ -essential torus,  $\mathcal{H} \in \mathbb{H}(Q)$  with  $g = \text{net } g(\mathcal{H})$
- there is a crushable handle  $A \sqsubset Q \setminus \mathcal{H}$  with crushing disc  $D$  on side  $V$  of  $Q$ , and  $\mathbf{L}$  is a weighted companion for  $T$  relative to  $V$ ,
- $(\widehat{M}, \widehat{V}, \widehat{T}, \widehat{\mathcal{H}})$  be obtained by crushing  $(M, V, T, \mathcal{H})$  using  $A$ .

- $M_1$  is obtained by  $\partial$ -reducing  $\widehat{V}$  along  $D$ .
- $M_0$  be the manifold obtained from the complement of  $\widehat{V}$  by attaching a 2-handle to  $Q$  along  $\partial D$ .

Then there exist integers  $g_0, g_1$  such that:

1.  $g_0 + g_1 = g$ ,
2.  $g_0 \geq g(M_0)$  and  $g_1 \geq g(M_1)$ , and
3. We have:

$$\text{net } w(\mathcal{H}; T)/2 \geq \text{net } w_{g_0}(M_0; \mathbf{L})/2 - \omega g_1$$

*Proof.* See Figure 8 for a depiction of the notation in this paragraph. Let  $\widehat{Q}$  be the twice-punctured summing sphere obtained by cut-compressing  $Q$  in  $(\widehat{M}, \widehat{T})$  using the crushing disc  $D$  for  $A$ . Note that  $x_\omega(\widehat{Q}) = 0$  and  $\omega \geq 2$ . The sphere  $\widehat{Q}$  defines a connected sum decomposition  $(\widehat{M}, \widehat{T}) = (M_0, T_0) \#_2 (M_1, T_1)$ . Choose the notation so that  $M_1$  is the result of capping off the 3-manifold obtained by  $\partial$ -reducing  $\widehat{V}$  using  $D$  with a 3-ball. Then  $T_0$  is easily seen to be isotopic to a weighted companion  $\mathbf{L} = (T \setminus V) \cup \mathbf{K}$  for  $T$  with respect to  $V$ . It has weight  $\omega$  on the newly crushed edge  $e$  and weight equal to 1 elsewhere. The graph  $T_1$  contains two vertices  $v_\pm$  that were not vertices of  $T$  and one edge  $e'$  that does not belong to  $T$  and which has  $v_\pm$  as its endpoints. The edge  $e'$  is the union of the subarcs  $e \setminus N(D)$  with an arc in the 3-ball used to cap off the boundary of  $V|_D$ . The edge  $e'$  also has weight  $\omega$ , and all other edges of  $T_1$  have weight equal to 1. If  $\text{net } g(\widehat{\mathcal{H}}) < g$ , stabilize some component of  $\widehat{\mathcal{H}}^+$  enough times so that  $\text{net } g(\widehat{\mathcal{H}}) = g$ .

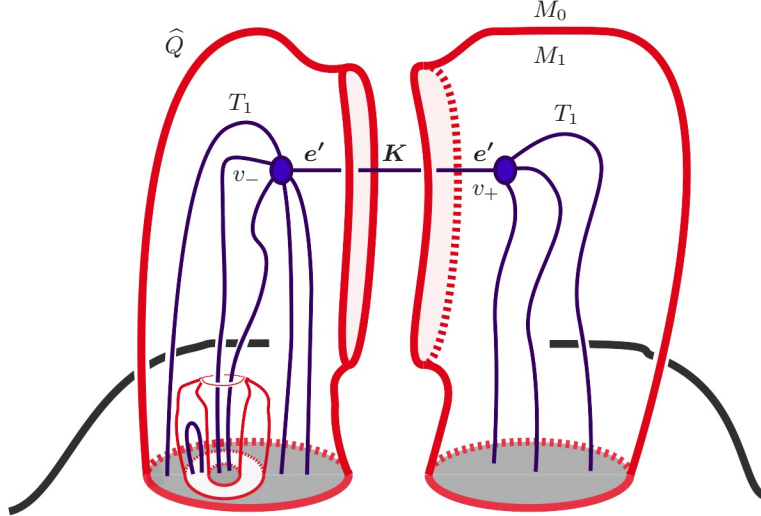

Figure 8: We depict the notation used in the proof of [The Handle-Crushing Theorem](#). The pairs  $(M_0, T_0)$  and  $(M_1, T_1)$  are obtained by surgering along sphere  $\widehat{Q}$ , with the labels chosen as indicated. In  $T_1$ , the edge  $e'$  includes the two arcs of  $\widehat{T}$  labeled as  $e'$ , as well as an arc in the 3-ball used in surgering along  $\widehat{Q}$ ; all three have weight  $\omega$ . The knot  $\mathbf{K}$  has weight  $\omega$  and is the union of the arc labelled as  $\mathbf{K}$  with an arc in the 3-ball used in the surgery along  $\widehat{Q}$ , also having weight  $\omega$ .

We follow the proof of the [Additivity Theorem](#), abbreviating the arguments that are repetitions.

By [Theorem 4.6](#),  $\widehat{\mathcal{H}}$  thins to a locally thin  $\mathcal{J} \in \overline{vp}\mathbb{H}(\widehat{M}, \widehat{T})$ . By [Theorem 4.7](#), since  $\widehat{Q} \subset (\widehat{M}, \widehat{T})$  is an essential twice-punctured sphere, there is a nonempty efficient summing system  $S$  contained in  $\mathcal{J}^-$ . By the

irreducibility of  $(\widehat{M}, \widehat{T})$ ,  $S$  is the union of twice and thrice-punctured spheres. Discard the thrice-punctured spheres. As  $(\widehat{M}, \widehat{T})$  does not contain a twice-punctured sphere with punctures of different weights (Lemma 6.8), by Theorem 2.11, both  $(\widehat{M}, \widehat{T})|_S$  and  $S$  are unique up to homeomorphism. Thus, from the components of  $(\widehat{M}, \widehat{T})|_S$  we can reconstruct  $(M_0, T_0)$  and  $(M_1, T_1)$ . From the components of  $\mathcal{J}$  in  $(\widehat{M}, \widehat{T})|_S$  and the (new) summing spheres, we can construct  $\mathcal{J}_i \in \overline{vp\mathbb{H}}(M_i, T_i)$  (for  $i = 0, 1$ ). Let  $g_i = \text{net } g(\mathcal{J}_i)$ . This construction can be accomplished so that, letting  $\chi_i = \text{net } \chi(\mathcal{J}_i)$ , we have  $\chi_0 + \chi_1 + 2 = \text{net } \chi(\mathcal{J}) = \text{net } \chi(\mathcal{H})$ ,  $g = g_0 + g_1$ , and

$$\text{net } x_\omega(\mathcal{J}_0) + \text{net } x_\omega(\mathcal{J}_1) = \text{net } x_\omega(\mathcal{J}) \quad (\dagger)$$

as  $x_\omega(\widehat{Q}) = 0$ .

We claim that  $\text{net } x_m(\mathcal{J}_1; \mathbf{T}_1) \geq 0$ . Recall that  $e'$  is the unique edge of  $\mathbf{T}_1$  of weight  $\omega$ .

To make the arithmetic easier, we begin by collapsing certain submanifolds to vertices. Let  $P \subset \mathcal{J}_1^-$  be the union of spheres disjoint from  $e'$ . Then  $(M_1, T_1)|_P$  has a unique component containing  $e'$ . We discard all other components. As in the proof of Lemma 6.8, this does not increase  $\text{net } x(\mathcal{J}_1)$  or  $\text{net } \chi(\mathcal{J}_1)$ ; for the purposes of the arithmetic that follows, the discarded components do not matter. For simplicity, therefore, assume that  $P = \emptyset$ . Let  $U$  be the union of all vertices of  $T_1$  that are also vertices of  $T$ . (If, in fact,  $P$  were nonempty, we would also include into  $U$  all the new vertices of  $T$  introduced by the aforementioned surgery.) Observe that all vertices of  $U$  are adjacent only to edges of weight 1.

Let  $V = v_- \cup v_+$  (the endpoints of  $e'$ ). Note that

$$x_\omega(v_\pm) = 2(-\omega + |D_\pm \cap T|/2 + \omega) \geq 0.$$

Thus, by Lemma 3.14,

$$2 \text{net } x_\omega(\mathcal{J}; \widehat{\mathbf{T}}_1) = x(U) + x_\omega(V) + \sum_{(C, T_C)} \delta_\omega(C, T_C) \quad (*)$$

where the sum is over all VPCs  $(C, T_C) \sqsubset (M_1, T_1) \setminus \mathcal{J}_1$ . The quantities  $x(U)$  and  $x_\omega(V)$  are non-negative. We desire to show that the sum is also. This is where we use the fact that we weighted  $e$  by  $\omega$ , the wrapping number, rather than, say, the number of times the crushing disc intersects  $T$ .

We proceed by contradiction. Suppose the sum in  $(*)$  is negative, then there exists a VPC  $(C_2, \tau_2)$  with  $\delta_\omega(C_2, \tau_2) < 0$ . We will establish a contradiction similarly to the proof of Lemma 3.18. Let  $(C_1, \tau_1)$  be the other VPC such that  $\partial_+ C_1 = \partial_+ C_2 = H \subset \mathcal{J}_1^+$ .

By Lemma 3.13,  $(C_2, \tau_2)$  is a 3-ball and all vertices of  $\tau_2$  lie in  $U$ . Also, every edge of  $\tau_2$  has weight 1. Since  $H$  is a sphere,  $\partial_- C_1$  is the union of spheres; consequently,  $\partial_- C_1 \subset \mathcal{H}^-$ , as  $(M_1, T_1)$  is standard. Each component of  $\partial_- C_1$  intersects  $e'$ , since  $P = \emptyset$  (alternatively, since the spheres in  $P$  were collapsed to vertices). Since every puncture on  $H$  lies in  $\tau_2$  and since all edges of  $\tau_2$  have weight 1, it must be the case that each subarc of  $e'$  in  $\tau_1$  is a ghost arc.

Let  $\Gamma$  be the ghost arc graph for  $(C_1, \tau_1)$ ; its edges are the ghost arcs of  $\tau_1$  and its vertices are the vertices of  $\tau_1$  together with the components of  $\partial_- C_1$ . Since  $H$  is a sphere,  $\Gamma$  is acyclic. We just showed that  $\Gamma$  has at least one edge of weight  $\omega$ .

See Figure 9 for a depiction of the notation used in the next two claims. Let  $\lambda$  be a leaf of the subgraph  $\Gamma(\omega)$  of  $\Gamma$  induced by edges of weight  $\omega$ . Let  $e_\lambda$  be the sole edge of weight  $\omega$  incident to  $\lambda$ .

**Case 1:** The vertex  $\lambda$  lies in  $V$ .

By Remark 6.7,  $\lambda$  is incident in  $\tau_1$  to at least  $\omega$  edges of weight 1. Other than  $e_\lambda$ , if  $f$  is a ghost arc incident to  $\lambda$ , the subtree of  $\Gamma \setminus \lambda$  containing  $f$ , contains edges of weight 1 and vertices in  $U$ . Other than  $\lambda$ , each leaf of that subtree is incident to at least two vertical arcs. Consequently,  $\lambda$  produces at least  $\omega$  punctures in  $H$ .

**Case 2:**  $\lambda$  is a component of  $\partial_- C$ .

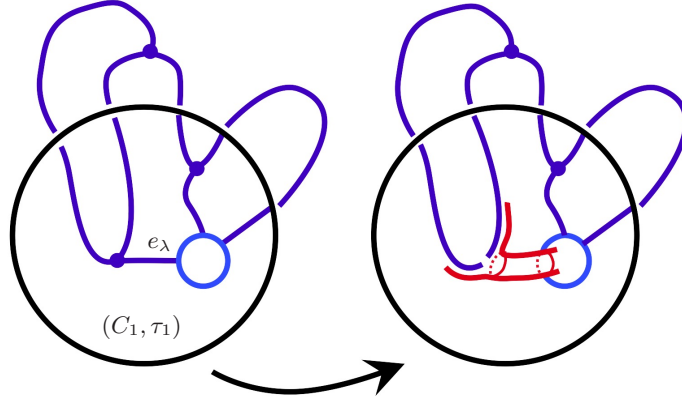

Figure 9: We depict the situation in Cases 1 and 2 of the proof of Theorem 6.9. For Case 1, consider  $\lambda$  to be the vertex on the left and for Case 2, consider  $\lambda$  to be the thin sphere on the right in  $(C_1, T_1)$ . The arrow shows how when we recover  $(M, T)$ , the thin sphere on the right becomes a punctured disc in  $V$  with boundary on  $Q$ .

Since it is a sphere in  $(M_1, T_1)$  intersecting  $e'$  exactly once and as we can recover  $\eta(\partial D) \subset A$  from a regular neighborhood of  $e$ , the sphere  $\lambda$  restricts to a punctured disc in  $\widehat{V}$ . Since  $\omega$  is the wrapping number of  $T \cap V$  in  $V$ , the sphere  $\lambda$  must again contain the end points of at least  $\omega$  edges of  $\tau_1$  of weight 1. As in Case 1, this implies that  $\lambda$  again contributes at least  $\omega$  punctures to  $H$ .

Since  $\Gamma(\omega)$  has at least two leaves and since  $\Gamma$  is acyclic,  $H$  has at least  $2\omega$  punctures. However, this implies that  $\delta_\omega(C_2, \tau_2) \geq 0$ , contrary to our initial choice. As desired, we conclude that

$$\text{net } x_\omega(\mathcal{J}_1; \mathbf{T}_1) \geq 0. \quad (\ddagger)$$

Thus,

$$\begin{aligned} \omega\chi/2 + \text{net } w(\widehat{\mathcal{H}}; T)/2 &= (\text{Lemma 6.8 and Remark 3.10}) \\ \text{net } x_\omega(\widehat{\mathcal{H}}; \widehat{\mathbf{T}}) &= (\text{Theorem 4.6.3}) \\ \text{net } x_\omega(\mathcal{J}; \mathbf{T}) &= (\ddagger) \\ \text{net } x_\omega(\mathcal{J}_0; \mathbf{T}_0) + \text{net } x_\omega(\mathcal{J}_1; \mathbf{T}_1) &\geq (\ddagger) \\ \text{net } x_\omega(\mathcal{J}_0; \mathbf{T}_0) &= (\text{Theorem 4.6.3}) \\ \omega\chi_0/2 + \text{net } w(\mathcal{J}_0; \mathbf{T}_0)/2 & \end{aligned}$$

Recalling that  $\chi_0 + \chi_1 + 2 = \chi$ , produces

$$\text{net } w(\widehat{\mathcal{H}}; T)/2 \geq -\omega(\chi_1 + 2)/2 + \text{net } w(\mathcal{J}_0; \mathbf{T}_0)/2$$

Hence,

$$\text{net } w(\mathcal{H}; T)/2 \geq -\omega g_1 + \text{net } w_{g_0}(M_0; \mathbf{L})/2.$$

□

Although we can use the [Handle-Crushing Theorem](#) to study bridge number for any  $g$ , in the interests of space we restrict attention to the cases when  $g = 0, 1$ , as the ability to amalgamate gives us the strongest conclusions.

**Corollary 6.10.** *Suppose that the hypotheses of the Handle Crushing Theorem hold, that  $g \in \{0, 1\}$ , and  $\text{net } w(\mathcal{H}) \leq 2\mathfrak{b}_g(T)$ . Also suppose that  $T \cap V^c$  is a (possibly empty) link. Then*

$$\mathfrak{b}_g(T) \geq \mathfrak{b}_g(\mathbf{L}) - \omega\delta$$

where both sides are computed in  $M$  and  $\delta = 0$  if  $V$  is a solid torus and  $\delta = 1$  if  $V$  is a lensed solid torus.

*Proof.* Recall that  $g_0 + g_1 = 1$ , so  $\{g_0, g_1\} = \{0, 1\}$ . By Lemma 4.12,  $\text{net } w_{g_0}(\mathbf{L})/2 = \mathfrak{b}_{g_0}(\mathbf{L})$ . Thus, by Theorem 6.9,  $\mathfrak{b}_g(T) \geq \mathfrak{b}_{g_0}(\mathbf{L}) - \omega g_1$ . Finally, observe that  $g_1 = 1$  if and only if  $V$  is a lensed solid torus.  $\square$

The remainder of this section is devoted to giving our new proof of Schubert's Theorem for satellite knots. We phrase it for spatial graphs, in the interest of adding some spice.

**Lemma 6.11.** *Suppose that  $\mathcal{H} \in \mathbb{H}(Q)$  and that  $(C, T_C) \sqsubset (M, T) \setminus \mathcal{H}$  is an innermost or outermost VPC intersecting  $Q$ . Suppose that a component of  $Q \cap C$  is a bridge annulus with ends bounding disjoint discs in  $\partial_+ C$ . Then there is a crushable handle in  $C$ .*

*Proof.* Let  $A_0 \sqsubset Q \cap C$  be a bridge annulus with ends bounding disjoint discs  $D_1, D_2$  in  $\partial_+ C$ . As  $Q$  is a torus, each component  $A \sqsubset Q \cap C$  is an annulus. By our choice of  $C$ , no such annulus is vertical. If  $D_1, D_2$  are disjoint from  $Q$  in their interiors, then  $A_0$  is a crushable handle. Otherwise, we may choose  $A \sqsubset Q \cap C$  to have the property that its ends bound disjoint discs  $D'_1, D'_2$  in  $D_1 \cup D_2$  and that its ends are innermost with that property. (That is, no component of  $Q \cap C$  with ends in the interior of  $D'_1 \cup D'_2$  has ends that bound disjoint discs in  $D'_1 \cup D'_2$ .) Possibly,  $A = A_0$ . As no component of  $Q \cap C$  is vertical,  $A$  is a crushable handle.  $\square$

**Corollary 6.12** (Schubert's Satellite Theorem). *Suppose that  $T \subset S^3$  is a spatial graph and that  $Q \subset (S^3, T)$  is an essential unpunctured torus compressible to a unique side  $V \sqsubset S^3 \setminus Q$ . Suppose that  $T \setminus V$  is a (possibly empty) link and that the wrapping number of  $T \cap V$  in  $V$  is  $\omega \geq 1$ . Then*

$$\mathfrak{b}_0(T) \geq \mathfrak{b}_0(\mathbf{L}) \geq \omega \mathfrak{b}_0(K).$$

where  $\mathbf{L} = (T \setminus V) \cup \mathbf{K}$  is a weighted companion for  $T$  with respect to  $V$  and  $\mathbf{K}$  is the core loop of  $V$  weighted by the wrapping number  $\omega$ .

*Proof.* If  $\omega = 1$ , then this is Corollary 5.3. Thus, we may assume that  $\omega \geq 2$ . By Theorems 5.1 and 2.13, we may assume that  $(M, T)$  is irreducible.

Let  $H$  be a minimal bridge surface for  $T$ . By Lemma 4.6 and Corollary 4.8, there exists  $\mathcal{H} \in \mathbb{H}(Q)$  such that  $\text{net } g(\mathcal{H}) = 0$  and  $\text{net } w(\mathcal{H}) \leq 2\mathfrak{b}_0(T)$ . Each component of  $\mathcal{H}$  is a sphere, so some outermost or innermost VPC intersecting  $Q$  is a 3-ball. Every component of  $Q$  in that VPC is an annulus whose ends bound disjoint discs in its positive boundary. By Lemma 6.11, there is a crushable handle. By Corollary 6.10,

$$\mathfrak{b}_0(T) \geq \text{net } w_0(\mathbf{L})/2.$$

The result follows from the observation that discarding components of a link cannot increase bridge number.  $\square$

## 7 Annuli in VPCs

The remainder of the paper is devoted to the search for crushable handles. Much of our work applies beyond considering satellite tori in  $S^3$  or lens spaces. As long as it does not overly complicate the exposition, we

work as generally as possible. In particular  $Q$  need not be a torus and  $M$  need not be  $S^3$  or a lens space, though we do always assume  $(M, T)$  is standard.

Annuli inside VPCs will play an important role in our discussions. We begin with some basic results about such annuli.

**Definition 7.1.** If  $(C, T_C)$  is a VPC and  $A \subset (C, T_C)$  is a  $c$ -essential annulus disjoint from  $T_C$ , then  $A$  is **bridge** if  $\partial A \subset \partial_+ C$  and **vertical** if one component of  $\partial A$  is in each of  $\partial_{\pm} C$ .

We use the following lemma often and without comment.

**Lemma 7.2.** *Suppose  $(C, T_C)$  is a VPC such that no component of  $\partial_- C$  is an unpunctured  $S^2$ . If  $A \subset (C, T_C)$  is an unpunctured  $c$ -essential annulus, then  $A$  is bridge or vertical.*

*Proof.* An innermost disc argument shows that if  $\partial A \subset \partial_- C$ , then  $A$  is disjoint from a complete set of sc-discs for  $(C, T_C)$ . It thus lies in a trivial product compressionbody and must be  $\partial$ -parallel.  $\square$

**Definition 7.3.** Suppose that  $A \subset (C, T_C)$  is an unpunctured bridge or vertical annulus in a VPC. Assume that  $\partial_- C$  contains no unpunctured spheres. Let  $H = \partial_+ C$  and let  $F \sqsubset \partial_- C$  contain a component of  $\partial A$ , if  $A$  is vertical. Observe that if an end of  $A$  is nonseparating in  $F$  then its end in  $H$  is also nonseparating in  $H$ . Harnessing Lemma 7.2, we denote all the possibilities for  $A$  (and depict them in Figure 10), as follows:

1. (Type BNN) A bridge annulus with both ends nonseparating in  $H$ .
2. (Type VNN) A vertical annulus with both ends nonseparating in  $H \cup F$ .
3. (Type VSS) A vertical annulus with both ends separating in  $H \cup F$ .
4. (Type VNS) A vertical annulus with one end nonseparating in  $H$  and one end separating in  $F$ .
5. (Type BSS) A bridge annulus with both ends separating in  $H$ .
6. (Type BNS) A bridge annulus with one end separating and the other nonseparating in  $H$ .

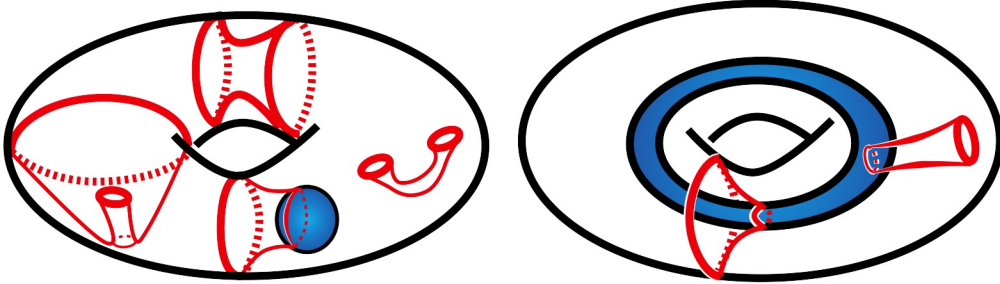

Figure 10: The six types of annuli are shown in red.

**Lemma 7.4.** *Suppose that  $(C, T_C)$  is a VPC such that  $\partial_- C$  has no unpunctured spheres, and let  $\mathcal{A} \subset (C, T_C)$  be a collection of disjoint  $c$ -essential unpunctured annuli and twice-punctured discs. If  $\Delta$  is a collection of discs chosen to intersect  $\mathcal{A}$  minimally, then:*

1.  $\Delta$  is disjoint from each vertical annulus in  $\mathcal{A} \cap C$ .
2. Each bridge annulus  $A$  in  $\mathcal{A} \cap C$  has intersection with  $\Delta$  consisting of a possibly empty collection of arcs (no loops) each of which is a spanning arc in the annulus.

3. If  $D$  is a twice-punctured disc then  $\Delta \cap D$  is the union of properly embedded arcs, each separating the punctures in  $D$ .

*Proof.* This is another straightforward innermost disc/outermost arc argument.  $\square$

We use the following lemma to find sc-discs disjoint from  $Q$ .

**Lemma 7.5.** *Suppose that  $(C, T_C)$  is a VPC with no unpunctured sphere in  $\partial_- C$  and let  $\mathcal{A} \subset (C, T_C)$  be a collection of disjoint  $c$ -essential unpunctured annuli and twice-punctured discs. Let  $A \subset \mathcal{A}$  be the union of vertical annuli and assume that the ends of  $A$  separate  $\partial_+ C$  into two distinct subsurfaces  $X$  and  $Y$ . Suppose that there is an sc-disc  $D$  for  $\partial_+ C$  with  $\partial D \subset X$ . Then there exists an sc-disc with boundary in  $X$  and which is also disjoint from  $\mathcal{A}$ .*

*Proof.* An innermost disc argument shows that we may assume that  $D \cap A = \emptyset$  and that  $D \cap \mathcal{A}$  consists of arcs essential in the components of  $\mathcal{A}$  containing them. If  $D$  is disjoint from  $\mathcal{A}$ , then we are done, so suppose that  $D \cap \mathcal{A} \neq \emptyset$ . Let  $\alpha$  be an arc of  $D \cap \mathcal{A}$  bounding a sub-disc  $E \subset D$  not containing a puncture of  $D$  (if such exists) and which has interior disjoint from  $\mathcal{A}$ . Let  $A'$  be the component of  $\mathcal{A}$  containing  $\alpha$ . Observe that  $\partial A' \subset X$ . Boundary compress  $A'$  using  $E$ . By our choice of  $E$ , we obtain one or two once-punctured or unpunctured discs with boundary in  $\partial_+ C$ . At least one of them must be essential and a small isotopy makes it disjoint from  $\mathcal{A}$ .  $\square$

## 8 $Q$ -thinning and Subsurface Amalgamation

This section adapts the notions of thinning and amalgamation so that they interact nicely with a surface  $Q$ .

**Assumption 8.1.** *Throughout this section, suppose that  $Q \subset (M, T)$  is a  $c$ -essential, orientable properly embedded surface and that  $(M, T)$  is irreducible. If  $Q$  has punctures, also assume that  $(M, T)$  is 2-irreducible. The graph  $T$  may be weighted, although we will not make use of weights (other than 1) in the remainder of the paper.*

**Definition 8.2.** A  $Q$ -disc for a surface  $F \subset (M, T)$  is a  $c$ -disc for  $F$  that is disjoint from  $Q$ .

### 8.1 $Q$ -thinning

**Definition 8.3.** Suppose that  $Q \subset (M, T)$  and  $\mathcal{H} \in \mathbb{H}(Q)$ . An **elementary thinning sequence relative to  $Q$**  (henceforth  **$Q$ -sequence**) on  $\mathcal{H}$  consists of the following in any order:

- an elementary thinning sequence on  $\mathcal{H}$  using  $c$ -discs  $D_\uparrow$  and  $D_\downarrow$  that are disjoint from  $Q$ ;
- consolidating adjacent thick and thin surfaces bounding a punctured product VPC in  $(M, T) \setminus \mathcal{H}$ ;
- an isotopy of  $\mathcal{H}$  to remove all components of  $Q \setminus \mathcal{H}$  with boundary that are parallel to subsurfaces of  $\mathcal{H}$ .

Observe that the resulting multiple bridge surface lies in  $\mathbb{H}(Q)$ .

The next lemma follows immediately from Theorem 4.6.

**Lemma 8.4.** *For any  $\mathcal{H} \in \mathbb{H}(Q)$ , there is no infinite sequence of  $Q$ -sequences.*

**Definition 8.5.** If  $\mathcal{H} \in \mathbb{H}(Q)$  cannot be thinned using  $Q$ -thinning moves, then  $\mathcal{H}$  is  $Q$ -**locally thin**. On the other hand, it is  $Q$ -**weakly reducible** if there are disjoint  $Q$ -discs with boundaries on the same thick surface but on opposite sides.

**Lemma 8.6.** *Suppose that  $\mathcal{H} \in \mathbb{H}(Q)$ , with  $Q$  an unpunctured torus or annulus, or four-punctured sphere. Assume also that for each component  $H \subset \mathcal{H}^+$  and each component  $Q_0 \subset Q \setminus H$  with  $\partial Q_0 \subset H$  and  $\partial Q_0 \neq \emptyset$ , there is no isotopy of  $Q_0$  to a subsurface of  $H$ . Then for every  $H \sqsubset \mathcal{H}^+$ , if  $H$  has an  $c$ -disc on a particular side, it has a  $Q$ -disc on that side. Furthermore, if  $(C, T_C)$  is a VPC without a  $Q$ -disc for  $\partial_+ C$ , then  $(C, T_C)$  is a punctured product compressionbody or a punctured trivial ball compressionbody and each component of  $Q \cap C$  is a vertical annulus with one end in  $\partial M \cap \partial_- C$ .*

*Proof.* Suppose that  $(C, T_C) \sqsubset (M, T) \setminus \mathcal{H}$ , that  $H = \partial_+ C$ . Note, with our hypotheses on  $Q$ , each component of  $Q \cap (C, T_C)$  is an unpunctured annulus or a twice-punctured disc. A twice-punctured disc component of  $Q \cap (C, T_C)$  must have its boundary on  $H$ , as otherwise it could either be isotoped out of  $(C, T_C)$  or be  $\partial$ -compressed to create a  $c$ -disc for  $\partial_- C$  in  $(C, T_C)$ , which is not possible.

Recall from Lemma 3.5, that if  $H$  does not have a  $c$ -disc in  $(C, T_C)$ , then  $(C, T_C)$  is either a punctured product between  $H$  and a component of  $\partial M$  or is a punctured trivial ball VPC. In either case, by Assumption 8.1, any unpunctured sphere in  $\partial_- C$  bounds a 3-ball in  $M$  and, if  $Q$  has punctures, every twice punctured sphere in  $\partial_- C$  bounds a trivial ball compressionbody in  $M$ . Consequently, any component of  $Q \cap C$  disjoint from  $\partial M$  can be isotoped out of  $M$ , a contradiction. We conclude that if  $H$  does not have a  $c$ -disc in  $(C, T_C)$ , then every component of  $Q \cap (C, T_C)$  is a vertical annulus with one end on  $\partial M \cap \partial_- C$ .

Suppose, therefore, that  $(C, T_C)$  contains a  $c$ -disc. Choose one such  $D$  which intersects  $Q \cap C$  minimally. If  $D \cap Q = \emptyset$  it is a  $Q$ -disc. Assume, therefore, that it intersects  $Q$ . It is disjoint from all vertical annuli of  $Q \cap (C, T_C)$  and each component of  $Q \cap D$  is an arc. Let  $\zeta$  be an outermost such arc, bounding an unpunctured outermost disc  $E \subset D$ . A  $\partial$ -compression using  $E$  of the component of  $Q \cap C$  containing  $\zeta$  produces a  $Q$ -disc, or else we could again isotope that component of  $Q \cap C$  out of  $C$ , contradicting our hypothesis.  $\square$

**Remark 8.7.** Observe that if  $\mathcal{H} \in \mathbb{H}(Q)$  is  $Q$ -locally thin, it may or not be locally thin. However, if  $\mathcal{H} \in \mathbb{H}(Q)$  is locally thin, then it can be isotoped to be  $Q$ -locally thin.

## 8.2 Subsurface Amalgamation

In [37], Schubert's theorem is proven by keeping track of the structure of maxima and minima through certain isotopies of tangles arising from the interaction between the companion torus and a height function. Some of these isotopies are shown in Figure 11. In what follows, we develop a version of those isotopies that is phrased in terms of multiple bridge surfaces. Since our focus is on the structure of discs and annuli in compressionbodies, there is hope of an algorithmic implementation of our approach.

In this subsection, we define a new way of combining certain thick surfaces into a new thick surface. Throughout, unless otherwise specified, we assume only:

**Assumption 8.8.** *Assume  $Q \subset (M, T)$  is a separating surface with  $V \sqsubset M \setminus Q$  designated as the "inside" and the other component designated as the outside.*

**Definition 8.9.** Suppose that  $\mathcal{H} \in \mathbb{H}(Q)$ . A **long annulus**  $\mathcal{A}$  is the union of unpunctured annular components of  $Q \setminus \mathcal{H}$  such that they can be indexed as:

$$\mathcal{A} = A_0 \cup A_1 \cup \cdots \cup A_n \cup A_{n+1}$$

with  $A_i \cap A_{i+1}$  a curve  $\gamma_{i+1} \sqsubset Q \cap \mathcal{H}$  for all  $i \in \{0, \dots, n\}$ . We let  $\gamma_0 = \partial A_0 \setminus \gamma_1$  and  $\gamma_{n+2} = \partial A_{n+1} \setminus \gamma_{n+1}$ . A long annulus is **vertical** if all of its annuli are vertical.



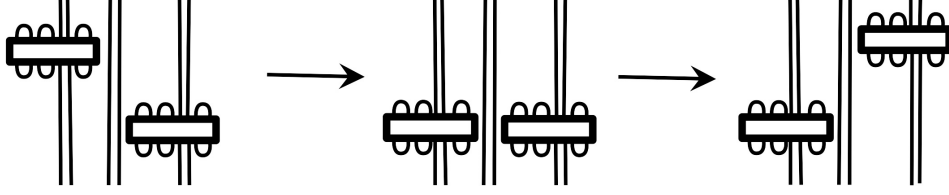

Figure 11: The boxes represent arbitrary braids. Some isotopies of tangles that rearrange the order of maxima and minima but preserve the total number of maxima. Subsequently we develop moves on multiple bridge surfaces corresponding to these isotopies. Our moves are defined via amalgamation and untelescoping and thus are appropriate even in the absence of a height function. Compare to Figures 12, 13, and 14 in order.

**Remark 8.10.** Throughout the rest of the paper we will consider long annuli in numerous contexts. We will always adopt the notation convention (or a small variation) of Definition 8.9 with regard to the numbering of the annuli and the curves of intersection with  $\mathcal{H}$ . In most cases,  $\gamma_0 \neq \gamma_{n+2}$ .

**Definition 8.11.** Consider VPCs  $(C_1, T_1), (C_2, T_2) \subset (M, T) \setminus \mathcal{H}$  such that there is a component  $F_2 \subset \partial_- C_1 \cap \partial_- C_2$ . Let  $H_1 = \partial_+ C_1$  and  $H_3 = \partial_+ C_2$ . An **insulating set**  $\mathcal{A}$  is the union of vertical long annuli  $\mathcal{A}_1, \dots, \mathcal{A}_m \subset Q \cap (C_1 \cup C_2)$ , such that for  $i = 1, 3$   $\mathcal{A} \cap H_i$  separates  $H_i$  and each component of  $H_i \setminus \mathcal{A}$  is on the same side (inside or outside) of each component of  $\mathcal{A} \cap H_i$  to which it is adjacent and similarly for the components of  $F \setminus \mathcal{A}$ . In particular,  $\mathcal{A} \cap H_i$  separates  $H_i$  and  $\mathcal{A} \cap F$  separates  $F$ . Observe that this means that in each of  $H_1, H_3$ , and  $F$ , we can refer to the inside or outside of  $\mathcal{A}$ . See Figure 12. In this paper, our insulating sets will have at most two components.

An **extended insulating set** is a collection of vertical long annuli  $\mathcal{A} \subset Q$  whose intersection with any pair of VPCs that are adjacent along a thin surface intersecting  $\mathcal{A}$ , is an insulating set.

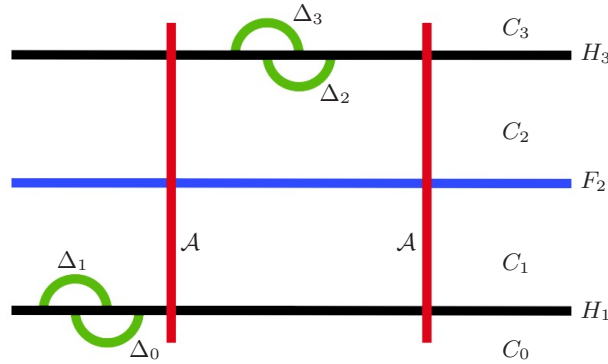

Figure 12: Depiction of an insulating set and the discs  $\Delta_i$  in the definition of mergable.

Let  $(C_0, T_0)$  and  $(C_3, T_3)$  be the components of  $(M, T) \setminus \mathcal{H}$  on the opposite sides of  $H_1$  and  $H_3$  from  $(C_1, T_1)$  and  $(C_2, T_2)$  respectively. Let  $\Delta_i \subset (C_i, T_i)$  be a complete set of sc-discs chosen to intersect  $Q$  minimally. We say that  $\Delta_j$  and  $\Delta_k$  are **on opposite sides** of an insulating set  $\mathcal{A}$  if  $\partial\Delta_j$  is on the inside of  $\mathcal{A}$  while  $\partial\Delta_k$  is on the outside, or vice-versa. Otherwise, we say that they are **on the same side**.

As in Figure 12, we say that  $H_1$  and  $H_3$  are **mergable** via an insulating set  $\mathcal{A}$  if the following conditions hold:

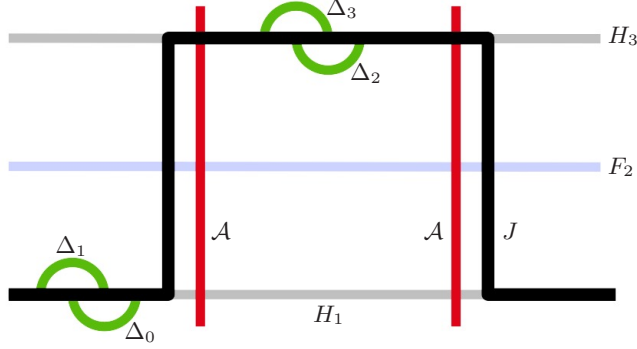

Figure 13: Depiction of subsurface amalgamation, continued from previous figure.

(M1)  $\Delta_1$  and  $\Delta_2$  are on opposite sides of  $\mathcal{A}$

(M2) There is a  $Q$ -disc  $D_0$  for  $H_1$  in  $(C_0, T_0)$ , with  $\partial D_0$  contained completely on the same side of  $\mathcal{A}$  as  $\Delta_2$ .

(M3) There is a  $Q$ -disc  $D_3$  for  $H_3$  in  $(C_3, T_3)$ , with  $\partial D_3$  contained completely on the same side of  $\mathcal{A}$  as  $\Delta_2$ .

Assuming (M1), (M2), (M3) hold we can create a new thick surface  $J$  as follows. Let  $\Delta_0, \Delta_3$  be complete set of discs for  $(C_0, T_0)$  and  $(C_3, T_3)$  respectively which contain  $D_0$  and  $D_3$  and, subject to that, intersect  $Q$  minimally. Without loss of generality, we may assume that  $\Delta_2$  lies on the inside of  $\mathcal{A}$ . Let  $\mathcal{A}'$  be a parallel copy of the annuli  $\mathcal{A}$  pushed slightly to the outside of  $\mathcal{A}$ . Let  $X_1 \subset H_1 \subset \mathcal{A}'$  be the component not containing  $\partial \Delta_1$ . Let  $Y_1$  be the other component. Let  $X_3 \subset H_3 \setminus \mathcal{A}'$  be the component containing  $\partial \Delta_2$ . Let  $Y_3$  be the other component. Let  $J = Y_1 \cup \mathcal{A}' \cup X_3$ . Let

$$\mathcal{J} = (\mathcal{H} \setminus (H_1 \cup F_2 \cup H_3)) \cup J.$$

We say that  $\mathcal{J}$  is obtained by **subsurface amalgamation** of  $\mathcal{H}$ . Refer to Figure 13. We now show that  $\mathcal{J} \in \mathbb{H}(Q)$ .

**Lemma 8.12.** *If  $\mathcal{H} \in \mathbb{H}(Q)$ , then  $\mathcal{J} \in \mathbb{H}(Q)$ . Furthermore, net  $x_m$ , net  $w$ , net  $g$ , and net  $\chi$  are the same for  $\mathcal{H}$  and  $\mathcal{J}$ .*

*Proof.* Without loss of generality, we may assume that  $\Delta_2$  is on the inside of  $\mathcal{A}$ . This assumption is used only to make a choice of how the annuli  $\mathcal{A}$  intersect  $\mathcal{J}$  and for ease of exposition. By our minimality assumption on  $|\Delta_i \cap Q|$ , the discs  $\Delta_1$  and  $\Delta_2$  are disjoint from  $\mathcal{A}$ . The situation is symmetric, so we show that the component  $(E, T_E)$  of  $(M, T) \setminus \mathcal{J}$  with  $J \subset \partial E$  and containing  $D_3$  is a VPC.

Compress  $J$  using  $\Delta_1$  to create a surface  $J'$  containing the scars  $\delta_1$  from the compressions. Since  $\Delta_1$  is on the outside of  $\mathcal{A}$ , the components of  $J' \setminus \mathcal{A}$  are either spheres bounding trivial VPCs or are parallel to the outside subsurface  $H'_3$  of  $H_3 \setminus \mathcal{A}$ . Extend  $\partial \Delta_3 \cap H'_3$  through the product structure to lie on  $J'$  but missing the surgery scars. This converts  $\Delta_3$  into a collection of sc-discs  $\Delta'_3$  for  $J'$ . Undoing the compressions, makes  $\Delta_1 \cup \Delta'_3$  into a collection of sc-discs for  $J$ . Using them to compress  $J$ , produces the trivial VPCs from the compression of the outside subsurface of  $H_1$  using  $\Delta_1$  and components isotopic to the trivial VPCs obtained by compressing  $H_3$  using  $\Delta_3$ . Consequently,  $(E, T_E)$  is a VPC.

By construction, each component of  $Q \cap \mathcal{J}$  is essential in both surfaces, since all such components correspond to components of  $Q \cap \mathcal{H}$ . If some component of  $Q \setminus \mathcal{J}$  were parallel to a subsurface of  $\mathcal{J}$ , it would contain a component of  $Q \setminus \mathcal{H}$  that was parallel to a subsurface of  $\mathcal{H}$ , contrary to hypothesis. Thus,  $\mathcal{J} \in \mathbb{H}(Q)$ .

The second claim follows easily from considering the Euler characteristics and weights of the subsurfaces involved and using the fact that  $\mathcal{A}$  is the union of annuli.  $\square$

We can then go one step further, and, in effect, swap the original thick surfaces  $H_1$  and  $H_3$ . See Figure 14.

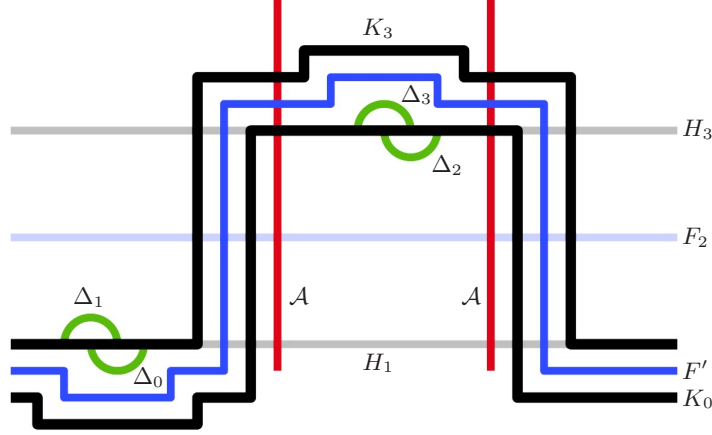

Figure 14: Interchanging two  $Q$ -adjacent thick surfaces. We will assume  $\Delta_1$  and  $\Delta_0$  are outside  $Q$ .

**Definition 8.13.** Let  $\mathcal{H}, H_1, H_3, F, D_0, D_3$  be as above. Suppose that  $H_1$  and  $H_3$  are mergable via an insulating set  $\mathcal{A}$  and let  $J$  be the thick surface that results from subsurface amalgamation. Let  $\mathcal{K}$  be the result of an elementary thinning move on  $J$  using the discs  $D_0$  and  $D_3$  (from conditions (M2) and (M3)). Let  $K_1$  and  $K_3$  be the new thick surfaces and  $F'$  the new thin surface, so that  $K_1$  is on the same side of  $F'$  as  $H_1$  is of  $F_2$ . We say that  $\mathcal{K} = \mathcal{K}_0$  is obtained from  $\mathcal{H}$  by a **preliminary interchange** of the thick levels  $H_1$  and  $H_3$ .

Recall from Lemma 4.9 that sc-discs persist through elementary thinning sequences. (See Figures 5 and 6.) In particular, if  $K_0$  admits a  $Q$ -disc  $D'_0$  on the same side as  $D_0$ , and on the opposite side of  $\mathcal{A}$  from  $D_3$ , then we may again weakly reduce using  $D_3 \cup D'_0$  to obtain  $\mathcal{K}_1$ . As in Lemma 4.9, which we will rely on, there will be consolidations that occur when we keep using the same disc for untelescoping.

We may perform a similar weak reduction and consolidation if  $K_3$  has an sc-disk  $D'_3$  on the same side of both  $\mathcal{A}$  and  $K_3$  as  $D_3$  and disjoint from  $Q$ . We may in this way construct a sequence:

$$\mathcal{K}_0, \mathcal{K}_1, \dots, \mathcal{K}_n$$

such that the following hold:

1.  $\mathcal{K}_{i+1}$  is obtained from  $\mathcal{K}_i$  by a  $Q$ -move. The untelescoping is done using a pair of discs originally corresponding to an sc-disk for  $K_3$  lying above  $K_3$  and an sc-disk for  $K_1$  lying below  $K_1$ . For  $i < n-1$ , the isotopy to eliminate parallel components of  $Q \setminus \mathcal{K}_{i+1}$  only eliminates components of  $Q \setminus \mathcal{K}_{i+1}$  that do not share a boundary component with  $\mathcal{A}$ .
2. Any path from one VPC to another that is disjoint from the  $Q$ -discs and intersects  $\mathcal{K}$  with consistent orientations will intersect  $\mathcal{K}_i^+$  at most the same number of times it intersects  $\mathcal{K}^+$ . (Lemma 4.9)
3. Either  $\mathcal{K}_n$  is  $Q$ -locally thin or after the untelescoping and consolidation of  $\mathcal{K}_{n-1}$  some component of  $Q \setminus \mathcal{K}_n$  sharing a boundary component with  $\partial\mathcal{A}$  is parallel to a subsurface of  $\mathcal{K}_n$ . The completion of the  $Q$ -move eliminates all such components.

**Definition 8.14.** If  $\mathcal{K}_n$  is as described above, we say that  $\mathcal{K}_n$  is obtained from  $\mathcal{H}$  by **interchanging** the thick surfaces  $H_i$  and  $H_{i+1}$ .

**Lemma 8.15.** *Suppose  $\mathcal{H} \in \mathbb{H}(Q)$  and that  $\mathcal{K}$  is obtained by interchanging thick surfaces, as above. Then the following hold:*

1. *net  $\chi$ , net  $x_m$ , net  $w$ , net  $g$  are the same for  $\mathcal{H}$  as for  $\mathcal{K}$ ,*
2. *No adjacent thick and thin surfaces of  $\mathcal{K}$  cobound a punctured product compressionbody,*
3. *Either  $\mathcal{K}$  is  $Q$ -locally thin or at the final step of the interchange, a  $Q$ -move eliminated one or more bridge annuli sharing an end with  $\partial A$ .*

*Proof.* By construction the surfaces  $K_3$ ,  $K_0$ , and  $F$  are obtained by compressing  $J \sqsubset \mathcal{J}^+$  along  $Q$ -discs. Thus, each component of  $\mathcal{K} \cap Q$  is essential in  $Q$ . Since  $Q$  is  $c$ -essential, each component is also essential in  $\mathcal{K}$ . Since we explicitly eliminated all parallelisms between subsurfaces of  $Q$  and  $\mathcal{K}$ , we have  $\mathcal{K} \in \mathbb{H}(Q)$ .

Each compression along a disc on the positive side or negative side of  $J$ , contributes the same amount to both  $\chi(K_i)$  and  $\chi(F')$  and to  $x(K_i)$  and  $x(F')$  for  $i = 0$  or  $i = 3$ . Eliminating parallel copies of  $\mathcal{K}^+$  and  $\mathcal{K}^-$  does not change net  $\chi$  or net  $x$ . Thus, (2) follows from Lemma 8.12.

We recall from Lemma 4.9 how the discs used in an untelescoping operation persist to the new thick surfaces. The sequence terminates when we lose the ability to keep using  $\mathcal{A}$  as an extended insulating set. Hence, (3) holds.  $\square$

## 9 Matched Pairs

We now turn to the task of trying to arrange that  $Q$  sits nicely with respect to a multiple bridge surface.

**Assumption 9.1.** *The pair  $(M, T)$  is irreducible and standard, the surface  $Q \subset (M, T)$  is  $c$ -essential and separating. The component  $V \sqsubset M \setminus Q$  is the **inside** of  $Q$ . We have  $\mathcal{H} \in \mathbb{H}(Q)$ . If  $Q$  is punctured, also assume that  $(M, T)$  is 2-irreducible.*

**Definition 9.2.** Every bridge annulus  $A \sqsubset Q \setminus \mathcal{H}$  has a boundary compressing disk  $E$  in the VPC containing it. If near the arc  $\partial E \cap Q$  the disk is contained inside  $A$ , we will call the annulus **nested**. If a bridge annulus is not nested, we call it **curved**. See Figure 15. All curved annuli  $A$  have a  $\partial$ -compressing disc  $E$  such that  $E$  is outside  $A$ ; but it is also possible for a nested annulus to have such a  $\partial$ -compressing disc. However, by definition of “curved,” no annulus is both curved and nested.

Anticipating future work, we extend the definition also to twice-punctured discs:

**Definition 9.3.** Every twice-punctured disc  $D \sqsubset Q \setminus \mathcal{H}$  has a boundary compressing disk  $E$  in the VPC containing it. If near the arc  $\partial E \cap D$  the disk is contained inside  $D$ , we will call the disc **nested**. If  $D$  is not nested, we call it **curved**.

**Lemma 9.4.** *Suppose that  $\mathcal{H} \in \mathbb{H}(Q)$  and that  $Q$  is an unpunctured torus or annulus or a four-times punctured sphere. Suppose that  $A \sqsubset Q \setminus \mathcal{H}$  is a bridge annulus or twice-punctured disc contained in a VPC  $(C, T_C) \sqsubset (M, T) \setminus \mathcal{H}$ . If  $A$  is a curved (resp. nested), then there is a  $Q$ -compressing disk in  $(C, T_C)$  for  $\partial_+ C$  outside (resp. inside) of  $A$ .*

If  $\partial A$  does not separate the component of  $\mathcal{H}^+$  containing it, then the disc may be both inside and outside  $A$ , in which case it may or may not be helpful in what follows, depending on the specific circumstances.

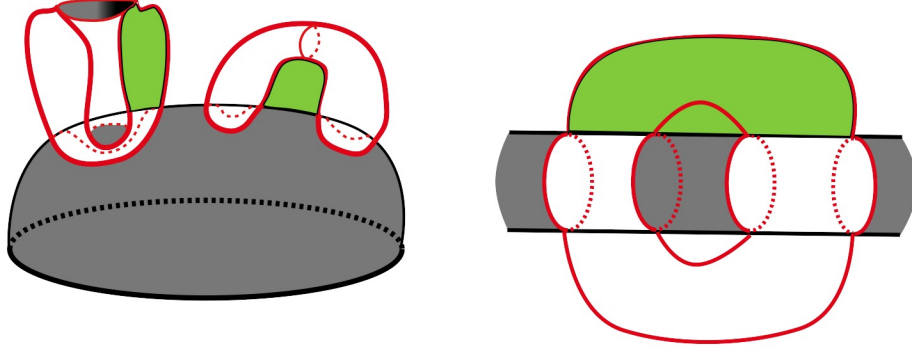

Figure 15: On both the left and the right we depict a nested annulus and a curved annulus. Which is which depends on whether the portion of the thick surface shaded gray is inside the ends of the annuli or outside the ends of the annuli. For each annulus, we depict a  $\partial$ -compressing disc in green. The statement that one of each pair of annuli is curved does require the assumption that there is no  $\partial$ -compressing disc on the side opposite the  $\partial$ -compression shown. Assuming that the curves of intersection between  $Q$  and  $\mathcal{H}$  in the example on the left are separating in  $\mathcal{H}$ , both examples of matched pairs are cancellable in the sense of Definition 10.2 below.

*Proof.* The proof is very similar to that of Lemma 8.6; simply use a  $\partial$ -compressing disc for  $A$  on the appropriate side in place of the disc  $D$ .  $\square$

**Definition 9.5.** A **matched pair**  $(A, A')$  consists of a curved annulus or twice-punctured disc  $A$  and a nested annulus or twice-punctured disc  $A'$  such that there is a long vertical annulus  $A_1 \cup \dots \cup A_n$  with  $\gamma_1$  an end of  $A$  and  $\gamma_{n+1}$  an end of  $A'$ . We call

$$\mathcal{A} = \underbrace{A_0}_{A} \cup A_1 \cup \dots \cup A_n \cup \underbrace{A_{n+1}}_{A'}$$

a **matching sequence**. Its **length**  $\ell(\mathcal{A})$  is equal to  $n$ . We call  $A_1 \cup \dots \cup A_n$  the **vertical part** of the matching sequence.

See Figure 16 for two examples of matched pairs.

**Notation 9.6.** For matching sequences, we will always adopt the notation of Definition 8.9 and insist that  $A = A_0$  is curved and  $A' = A_{n+1}$  is nested. We also let  $(C_i, T_i)$  be the VPC containing  $A_i$ . If  $(A, A')$  is matched pair then for each odd  $i$ ,  $\gamma_i$  lies in a thick surface  $H_i$ . Also for each even  $i$  such that  $0 < i < n + 2$ , the curve  $\gamma_i$  lies in a thin surface  $F_i$ .

**Lemma 9.7.** Suppose that  $\mathcal{H} \in \mathbb{H}(Q)$  and that  $(A, A')$  is a matched pair. The following hold:

1. The length of any matching sequence is always even.
2. Given a matching sequence  $\mathcal{A}$  for  $(A, A')$ , each component of  $\mathcal{H}$  is either disjoint from the vertical part of  $\mathcal{A}$  or intersects it in a single simple closed curve.
3. If all components of  $\mathcal{H}$  are separating, then any two matching sequences for  $(A, A')$  have the same length.
4. If a matching sequence has length 0 and if  $Q$  is an unpunctured or once-punctured torus or four-punctured sphere and if  $\partial A \cup \partial A'$  separates  $\mathcal{H}$ , then  $\mathcal{H}$  is  $Q$ -weakly reducible.

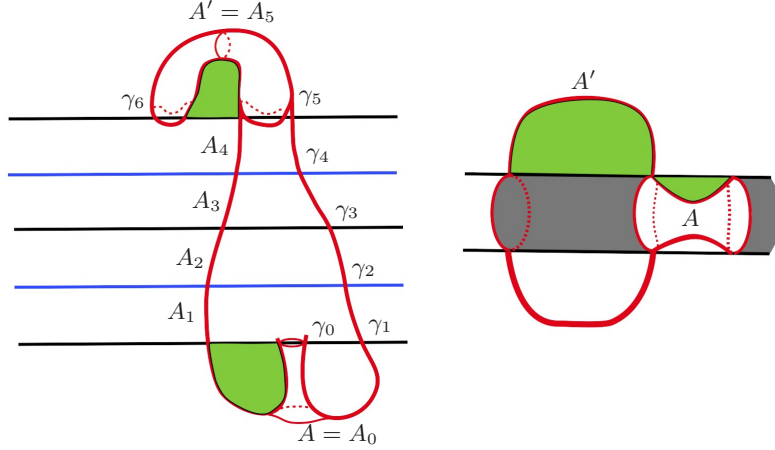

Figure 16: Two examples of matched pairs. The example on the left has a matching sequence of length 4 and the one on the right's matching sequence has length zero. Boundary-compression discs for the matched pair are shown in green. To satisfy the definition of matched pair, assume that none of the bridge annuli have a boundary-compressing disc on the opposite side from the one indicated, although that requirement can be relaxed for the nested annuli. Thick surfaces are in black and thin surfaces in blue.

*Proof.* To see that the length of a matching sequence is always even, recall that every annulus of  $Q \setminus \mathcal{H}$  incident to a thin surface is always vertical, while nested and curved annuli have their boundaries on thick surfaces. There must, therefore, be an even number of vertical annuli in a matching sequence, making the length even.

Consider a matching sequence for  $(A, A')$ . Choose an oriented spanning arc  $\alpha \subset A_1 \cup \dots \cup A_n$  that is also a spanning arc for each  $A_i$ . As each annulus  $A_i$  for  $i = 1, \dots, n - 1$ , is vertical, either the orientation of  $\alpha$  coincides with the transverse orientation for each component of  $\mathcal{H}$  it passes through or is opposite that orientation. By the definition of  $\overrightarrow{vp\mathbb{H}}(M, T)$ , this arc cannot pass through any component of  $\mathcal{H}$  more than once. If all components of  $\mathcal{H}$  are separating, then any two matching sequences for  $(A, A')$  pass through the same thin surfaces and so have the same length.

Finally, suppose that a matching sequence has length zero and that  $Q$  is a separating unpunctured or once-punctured torus or four-punctured sphere. Let  $V$  be a submanifold bounded by  $Q$  and consider it to be on the inside of  $Q$ . Let  $H \sqsubset \mathcal{H}^+$  contain  $\partial A \cup \partial A'$ . Since  $A$  is curved, by Lemma 9.4 there is a  $Q$ -disc for  $H$  outside  $\partial A$ . Similarly, there is a  $Q$ -disc for  $H$  inside  $\partial A'$ . If  $\partial A \cup \partial A'$  separates  $H$ , these discs are disjoint and so  $\mathcal{H}$  is  $Q$ -weakly reducible.  $\square$

## 10 Eliminating Matched Pairs

**Assumption 10.1.** For the entirety of this section, assume that  $Q \subset (M, T)$  is a  $c$ -essential unpunctured torus or annulus or four-punctured sphere, separating  $M$  and bounding a submanifold  $V$  which is the *inside* of  $Q$ .

**Definition 10.2.** A matched pair  $(A, A')$  is **cancellable** if one of the following holds:

1.  $A, A'$  are both BSS annuli and all other annuli in a matching sequence are VSS.
2. One of  $A, A'$  is BNS and the other is BSS and all other annuli in a matching sequence are VSS

- Both of  $A, A'$  are BNN annuli and, in addition to the matching sequence  $\mathcal{A}$  for  $(A, A')$  there is another long vertical annulus  $\mathcal{B}$ , disjoint from the interior of  $\mathcal{A}$ , with one end at  $A$  or  $A'$  and with  $\mathcal{A} \cup \mathcal{B}$  separating each thick and thin surface it intersects. Additionally, whichever of  $A$  or  $A'$  is not incident to  $\mathcal{B}$  has the property that it admits a bridge disc  $E$  on the the appropriate side whose arc of intersection  $\epsilon$  with  $\mathcal{H}^+$  can be isotoped to have interior disjoint from  $\mathcal{B} \cup (A \cup A')$ . (“Appropriate side” means on the inside if the annulus is nested and on the outside if it is curved.)

The matched pairs in Figure 16 are cancellable as is the matched pair on the left of Figure 17; however the matched pair on the right of Figure 17 is not cancellable. The example on the right of Figure 16 shows a cancellable matched pair satisfying (3) and of zero length.

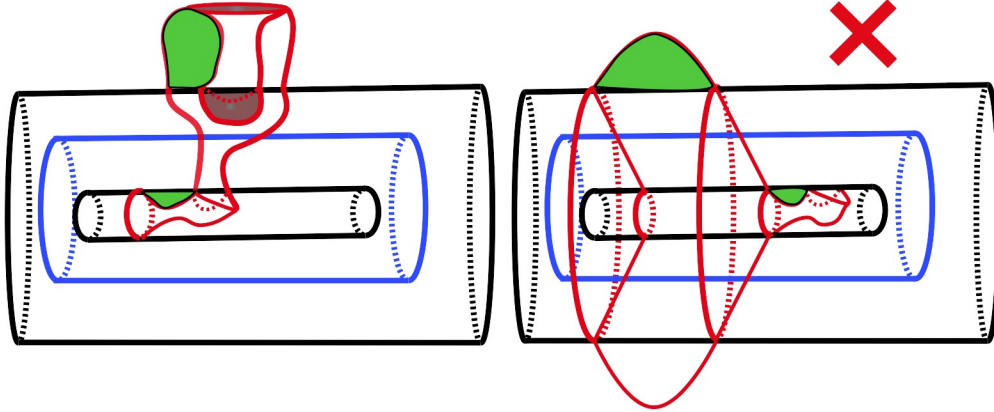

Figure 17: On the left is an example of a cancellable matched pair where one annulus in the pair is a BNS and the other is a BSS. On the right is an example of a matched pair that is not cancellable: one of the pair is a BNN and the other is a BNS. The examples of matched pairs in Figure 16 are also cancellable.

The purpose of this section is to prove Proposition 10.8, which guarantees that we can eliminate all cancellable matched pairs.

**Definition 10.3.** Let  $N(\mathcal{H})$  denote the number of matched pairs in  $Q$ .

**Lemma 10.4.** Suppose that  $\mathcal{H} \in \mathbb{H}(Q)$  and suppose that  $\mathcal{H}$   $Q$ -thins to  $\mathcal{J}$ , then  $N(\mathcal{J}) \leq N(\mathcal{H})$ .

*Proof.* Without loss of generality we may assume that we obtain  $\mathcal{J}$  from  $\mathcal{H}$  by untelescoping a thick surface  $H$ , consolidating (if possible) newly created thin and thick surfaces, then (if possible) consolidating some of the newly created thick surfaces with previously existing thin surfaces to create  $\mathcal{J}'$ , followed by an isotopy to remove components of  $Q \setminus \mathcal{J}'$  that are parallel to a subsurface of  $\mathcal{J}'$ , arriving at  $\mathcal{J}$ .

We start by showing that the number of bridge annuli does not increase. On  $Q$ , label each loop of  $Q \cap \mathcal{H}$  with the component of  $\mathcal{H}$  on which it lies. On  $Q$ , the untelescoping takes each loop labelled  $H$  and replaces it with three parallel loops; two are labelled by new thick surfaces and they are separated by a loop labelled with a new thin surface. See Figure 18 for a depiction. After untelescoping, the bridge annuli are in natural bijection with the bridge annuli before untelescoping. Consolidation removes adjacent loops one labelled by a thick surface and the other by a thin surface. Thus, again bridge annuli after the consolidations are in bijection with the bridge annuli before the consolidations. Finally, an isotopy eliminating a  $\partial$ -parallel bridge annulus removes two adjacent loops labelled with the same thick surface and, possibly, two adjacent loops labelled with the same thin surface. Once again, we see that we do not create additional bridge annuli.

We now explain the finer result that neither the number of curved nor the number of nested annuli increases. Let  $D_{\uparrow}$  and  $D_{\downarrow}$  be the discs used in the untelescoping. Let  $\mathcal{H}'$  be obtained from  $\mathcal{H}$  by the untelescoping,

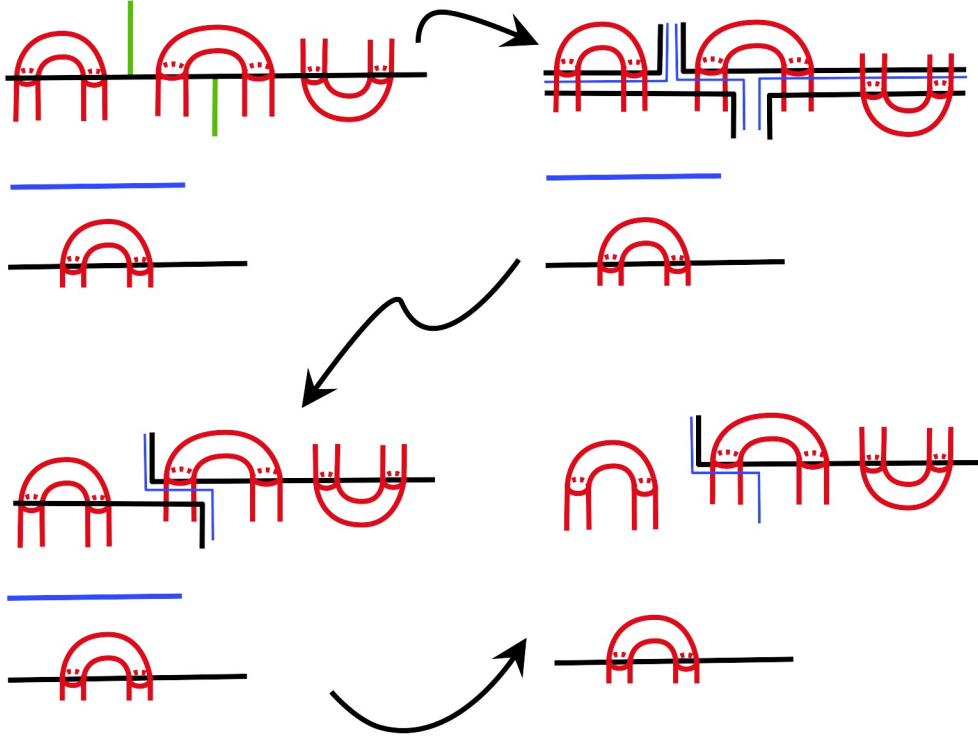

Figure 18: The top arrow shows a  $Q$ -weak reduction; the middle arrow shows the consolidation of new thin surfaces with new thick surfaces, and the bottom arrow shows the consolidation of a new thick surface and an old thin surface. Throughout we show bits of the surface  $Q$ .

so that  $\mathcal{J}'$  is obtained from  $\mathcal{H}'$  by consolidations. Consider a bridge disk  $E$  for  $A \sqsubset Q \setminus \mathcal{J}$ . Reversing the isotopies that create  $\mathcal{J}$  from  $\mathcal{J}'$ , introduces intersections between  $E$  and  $\mathcal{J}'$ . Since the components of  $\mathcal{J}' \cap Q$  are essential in both surfaces, we may assume that  $E \cap \mathcal{J}'$  consists of arcs. Reversing the consolidations may also introduce arcs of intersection between  $E$  and  $\mathcal{J}$ . The bridge annulus  $A'$  of  $Q \setminus \mathcal{H}'$  corresponding to  $A \sqsubset Q \setminus \mathcal{J}$  has a  $\partial$ -compressing disc  $E'$  that is a subdisc of  $E$ . Consequently,  $E$  lies outside  $A$  if and only if  $E'$  lies outside  $A'$ . We reconstruct  $\mathcal{H}$  from  $\mathcal{H}'$  by adding tubes to thick surfaces of  $\mathcal{H}'$  that are either dual to  $D_\uparrow$  or dual to  $D_\downarrow$  and then discarding the other components created by the untelescoping. These tubes are disjoint from  $Q$ , and so as a component of  $Q \setminus \mathcal{H}$ ,  $A'$  is nested if and only if  $A$  is nested. Consequently, as we pass from  $\mathcal{H}$  to  $\mathcal{J}$ , neither the number of curved or nested annuli increases nor does the number of matched pairs.  $\square$

We revisit the process of interchanging surfaces and prove a result which enables to control  $Q$ -complexity.

**Definition 10.5.** Suppose that  $\mathcal{H} \in \mathbb{H}(Q)$  is  $Q$ -locally thin and that there is a matched pair  $(A, A')$  with matching sequence

$$\mathcal{A} : \underbrace{A_0, \dots, A_n}_A, \underbrace{A_{n+1}}_{A'}.$$

Suppose that there is an extended insulating set  $\overline{A}$  containing the vertical part of  $\mathcal{A}$ . Recall that the curve  $\gamma_i$  lies on a thick surface  $H_i$  if  $i$  is odd and a thin surface  $F_i$  if  $i$  is even (and not 0 or  $n+2$ ). If  $H_i$  has a complete set of sc-discs  $\Delta_1, \Delta_2$  on either side that are both disjoint from  $\overline{A}$  and have boundaries lying inside (resp. outside)  $\overline{A}$  we say that  $H_i$  is **mostly inside** (resp. **mostly outside**) relative to  $\overline{A}$ .



**Remark 10.6.** The most natural setup is when the extended insulating set  $\overline{\mathcal{A}}$  equals the vertical part of  $\mathcal{A}$ . However, we want to be able to eliminate cancellable matched pairs that satisfy the third condition of Definition 10.2. To do that, we will need to allow  $\overline{\mathcal{A}}$  to contain two disjoint vertical annuli; one of them is the vertical part of  $\mathcal{A}$ . That vertical annulus necessarily has both ends on the matched pair; the other component of  $\overline{\mathcal{A}}$ , will also have one of its ends at the matched pair.

**Proposition 10.7.** *Suppose that  $\mathcal{H}$  is  $Q$ -locally thin, that  $(A, A')$  is a matched pair with a matching sequence  $\mathcal{A}$  of length at least 2. Suppose that for some odd  $i$ ,  $H_i$  and  $H_{i+2}$  are mergeable using an insulating set  $\overline{\mathcal{A}}$  containing  $A_i \cup A_{i+1}$ . Let  $\mathcal{J}$  be obtained by interchanging them along  $\overline{\mathcal{A}}$ . Then:*

1.  $N(\mathcal{J}) \leq N(\mathcal{H})$
2. if  $N(\mathcal{J}) = N(\mathcal{H})$ , then  $(A, A')$  persists as a matched pair for  $\mathcal{J}$  and  $\ell(A, A')$  has not increased.
3. if  $(A, A')$  was cancellable and  $\overline{\mathcal{A}}$  contains the union of the vertical annuli in Definition 10.2, this remains true after the interchange.

Furthermore, if the final step of interchanging  $H_i$  and  $H_{i+2}$  involves a  $Q$ -move that isotopes thick and thin surfaces across  $A$  or  $A'$ , then there is a further sequence of  $Q$ -moves applied to  $\mathcal{J}$  so that  $\mathcal{J}$  becomes  $Q$ -locally thin, and (1)-(3) continue to hold, and additionally:

4. if  $N(\mathcal{J}) = N(\mathcal{H})$ , then  $\ell(A, A')$  has strictly decreased.

*Proof.* According to Definition 8.14, interchanging  $H_i$  and  $H_{i+2}$  means that there is a sequence  $\mathcal{K}_0, \dots, \mathcal{K}_m$  with  $\mathcal{K}_0$  obtained from  $\mathcal{H}$  by a preliminary interchange of  $H_i$  and  $H_{i+1}$  and with  $\mathcal{K}_{j+1}$  obtained from  $\mathcal{K}_j$  by one of:

1. a  $Q$ -weak reduction, or
2. by an isotopy to remove one or more components of  $Q \setminus \mathcal{K}_j$  that is parallel to a subsurface of  $\mathcal{K}_j$ .

Without loss of generality, we assume that  $\mathcal{K}_{j+1}$  is obtained from  $\mathcal{K}_j$  by a  $Q$ -weak reduction if  $j$  is odd and an isotopy if  $j$  is even. For convenience, we split the analysis into two cases.

**Case 1:**  $\ell(A, A') \geq 4$  and neither  $H_i$  nor  $H_{i+2}$  are incident to  $A$  or  $A'$

In this case  $H_i$  and  $H_{i+2}$  are incident to components, necessarily vertical annuli, of  $\overline{\mathcal{A}}$  on both sides. By Definition 8.14, part (3), the result of the interchange is  $Q$ -locally thin and the annuli  $A$  and  $A'$  are unaffected by the interchange. By Lemma 4.9, as we are repeatedly using the  $Q$ -discs on either side of  $\overline{\mathcal{A}}$  to perform the weak reduction, none of the  $Q$ -weak reductions increase  $\ell(A, A')$ . By Lemma 10.4, none of the  $Q$ -moves increase the number of nested annuli. Conclusions (1) - (3) follow from Lemma 4.9 and the fact that  $Q$ -discs are disjoint from vertical annuli and the vertical annuli in the insulating set separate the surfaces intersecting them.

**Case 2:**  $\ell(A, A') \geq 2$  and one, or both of  $H_i$  or  $H_{i+1}$  is incident to  $A$  or  $A'$ .

As in Lemma 10.4, the annulus  $A$  persists as a curved annulus and  $A'$  persists as a nested annulus up until the final  $Q$ -move in the sequence  $(\mathcal{K}_i)$ . In this case, the final  $Q$ -move in the sequence  $(\mathcal{K}_i)$  consists of isotoping a thick surface  $\mathcal{K}_n(1)$ , as well as the adjacent thin surface  $F_2$  across  $A$  or  $A'$ . As in Lemma 10.4, we preserve the existence of a matched pair corresponding to  $(A, A')$ ; however, one or both of the annuli in this matched pair may be  $\partial$ -parallel. In any case, we have strictly decreased  $\ell(A, A')$ , as in Figure 19 and 20. As in Case 1, (1) - (3) hold. If one or both of  $A, A'$  is now  $\partial$ -parallel, we may isotope the thick surface across it. This causes the curved annulus  $A$  to combine with the nested annulus  $A'$ , eliminating the matched pair  $(A, A')$  without creating any new matched pairs.  $\square$

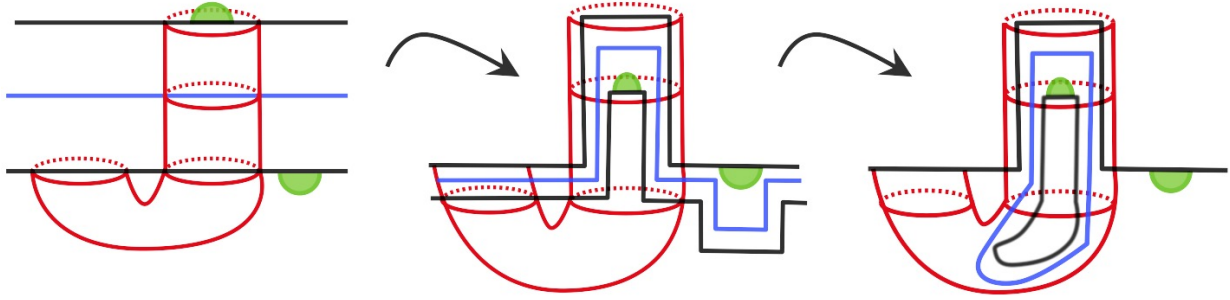

Figure 19: This depicts the interchange when one of the thick surfaces is incident to  $A$  or  $A'$  and eventually one of  $A$  or  $A'$  (but not both) becomes  $\partial$ -parallel. At the first arrow we perform the preliminary interchange and at the second arrow isotope the thick surface to remove the  $\partial$ -parallelism. Observe that the length of the matched pair decreases. The figure depicts the case when  $\bar{A}$  consists of only annuli in the matching sequence; when  $\bar{A}$  contains other annuli the picture is not much different.

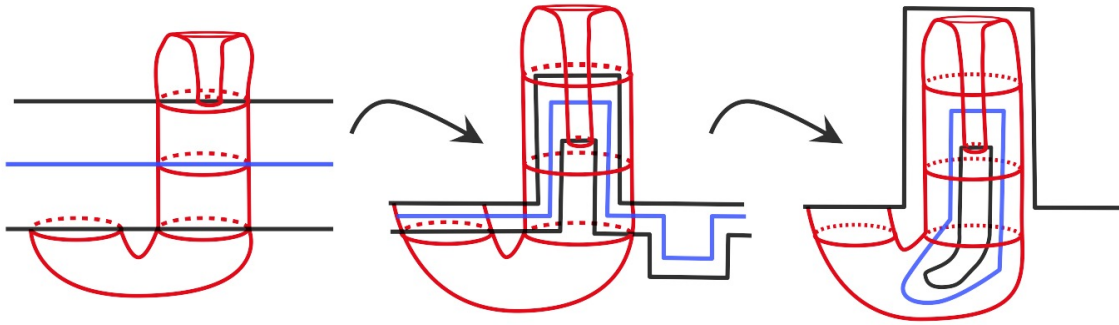

Figure 20: This depicts the interchange when  $\ell(A, A') = 2$  and when both  $A$  and  $A'$  eventually become  $\partial$ -parallel. In this case, the curved annulus and the nested annulus cancel.

**Proposition 10.8.** *Suppose  $\mathcal{J} \in \mathbb{H}(Q)$ . Then there exists  $\mathcal{H} \in \mathbb{H}(Q)$  with:*

- $\text{net } w(\mathcal{J}) = \text{net } w(\mathcal{H})$  and  $\text{net } g(\mathcal{J}) = \text{net } g(\mathcal{H})$
- $N(\mathcal{H}) \leq N(\mathcal{J})$
- *there is no cancellable matched pair in  $Q$  with respect to  $\mathcal{H}$ .*

*Proof.* Choose  $\mathcal{H}$  so that:

1.  $\text{net } g(\mathcal{H}) = \text{net } g(\mathcal{J})$  and  $\text{net } x_m(\mathcal{H}) = \text{net } x_m(\mathcal{J})$
2.  $\mathcal{H}$  is  $Q$ -locally thin
3. Subject to all of the above  $N(\mathcal{H}) \leq N(\mathcal{J})$  is minimal
4. Subject to all of the above, we have minimized the minimal length of a cancellable matched pair with respect to  $\mathcal{H}$ .

We must show that there is no cancellable matched pair for  $Q$  with respect to  $\mathcal{H}$ . Suppose, for a contradiction, that there is a cancellable matched pair  $(A, A')$ . Choose it so that  $\ell(A, A')$  is minimal among all such and let  $\mathcal{A}$  be a matching sequence.

Suppose first that  $\ell(A, A') \geq 2$ . We recall from Definition 10.2 that there are three types of matched pairs. We will find an extended insulating set in each case. If all annuli in  $\mathcal{A} \setminus (A \cup A')$  are VSS, then  $\mathcal{A} \setminus (A \cup A')$  is an insulating set, since each component of  $\overline{\mathcal{A}} = (\mathcal{A} \setminus (A \cup A'))$  is connected, and each of its intersections with  $\mathcal{H}$  separates  $\mathcal{H}$ . Hence, in the first two cases we have our insulating set. In the third case, the  $\overline{\mathcal{A}} = (\mathcal{A} \setminus (A \cup A')) \cup \mathcal{B}$  is our insulating set, where  $\mathcal{B}$  is as in Definition 10.2. To see  $\overline{\mathcal{A}}$  is an extended insulating set, suppose that  $S \subset \mathcal{H}$  intersects  $\overline{\mathcal{A}}$ . By hypothesis,  $\overline{\mathcal{A}}$  separates  $S$ . Since  $\mathcal{B}$  shares an end with  $A$  or  $A'$ , each component of  $S \setminus \overline{\mathcal{A}}$  lies on the same side of  $\mathcal{A}$  as it does  $\mathcal{B}$ .

Let  $H_1, \dots, H_n$  be the thick surfaces incident to  $\overline{\mathcal{A}}$ . They are indexed by odd numbers and are in order along  $\overline{\mathcal{A}}$  from  $H_0$  which is incident to  $A$  to  $H_n$  which is incident to  $A'$ . For expositional convenience, suppose that  $H_0$  is below  $H_n$ . (This can always be attained by reversing the orientation of  $\mathcal{H}$ . Alternatively, in what follows one may replace “lower” with “raise”, etc.).

Since  $A$  is curved, it has a bridge disc outside  $A$ . By the definition of cancellable matched pair, there is such a bridge disc that is disjoint from  $\overline{\mathcal{A}}$  and, therefore, lies outside  $\overline{\mathcal{A}}$ . By Lemma 7.5, there is a  $Q$ -disc for  $H_0$  on the same side of  $H_0$  and which has boundary lying outside  $\partial\overline{\mathcal{A}}$ . Since  $\mathcal{H}$  is  $Q$ -locally thin each thick surface that intersects  $\overline{\mathcal{A}}$  is  $Q$ -strongly irreducible. Thus,  $H_0$  is mostly outside  $\overline{\mathcal{A}}$ . Similarly,  $H_n$  is mostly inside  $\overline{\mathcal{A}}$ . Each thick surface intersecting  $\overline{\mathcal{A}}$  is either mostly inside or mostly outside  $\overline{\mathcal{A}}$ . Suppose there is one such  $H_i$  with  $i \neq n$  that is mostly inside  $\overline{\mathcal{A}}$ . Choosing  $i$  to be the smallest such index, we may then interchange  $H_i$  with the  $H_j$  below it as they are mergeable. This lowers the lowest thick surface that is mostly inside  $\overline{\mathcal{A}}$ , until (after renumbering)  $H_2$  is mostly inside  $\overline{\mathcal{A}}$ . Similarly, if there was an  $i \neq 0$  such that  $H_i$  is mostly outside  $\overline{\mathcal{A}}$ , we may use interchanges to raise the highest such  $H_i$  until, after renumbering,  $H_{n-2}$  is mostly outside  $\overline{\mathcal{A}}$ . Proposition 10.7 guarantees that these interchanges do not alter the fact that  $(A, A')$  is a cancellable matched pair. They also do not increase  $N(\mathcal{H})$  or  $\ell(A, A')$ . Another application of Proposition 10.7 shows that if  $H_2$  is mostly inside  $\overline{\mathcal{A}}$  and  $n \neq 2$ , interchanging  $H_2$  with  $H_0$  will reduce  $\ell(A, A')$  while preserving the fact that  $(A, A')$  is a cancellable matched pair and  $N(\mathcal{H})$  is minimal. This contradicts our choice of  $\mathcal{H}$  and  $(A, A')$ . We similarly encounter a contradiction, if  $n \neq 2$  and  $H_{n-2}$  is mostly outside  $\overline{\mathcal{A}}$ . On the other hand, if  $n = 2$ , interchanging  $H_0$  and  $H_2 = H_n$  results in the elimination of the matched pair  $(A, A')$  as in Proposition 10.7. We conclude that  $\ell(A, A') = 0$ . However, this implies the thick surface  $H$  incident to  $A$  and  $A'$  is  $Q$ -weakly reducible. To see this, observe that, by the definition of cancellable matched pair,  $A$  and  $A'$  have  $\partial$ -compressing discs  $D, D'$  (respectively) with the interior of the arcs  $\partial D \cap H$  and  $\partial D' \cap H$  contained in disjoint components of  $H \setminus \partial(A \cup A')$ . Lemma 7.5 then guarantees that there are disjoint  $Q$ -discs for  $H$  on opposite sides. However, this contradicts the fact that  $\mathcal{H}$  is  $Q$ -thin.  $\square$

## 11 Tubes and Spools

The purpose of this section is to investigate the structure of  $Q$  with respect to  $\mathcal{H}$  if there are no cancellable matched pairs. We will discover that since long annuli in  $Q$  cannot spiral infinitely, they will generally take certain very constrained configurations. Key to this is a certain surface constructed as the union of a subsurface of a thick surface and a long annulus called a *spool*. The existence of a spool will (in the case when  $Q$  is a torus) imply infinite spiraling. The non-existence of a spool will force the ends of long annuli to behave in certain way which, in the next section, with additional hypotheses, will imply the existence of a crushable handle.

**Assumption 11.1.** *Throughout this section we assume that  $(M, T)$  is a standard (3-manifold, graph) pair such that every closed surface in  $M$  separates  $M$ . Assume  $Q \subset M$  is a  $c$ -essential closed separating surface with one component  $V \subset M \setminus Q$  designated as the “inside”. Let  $\mathcal{H} \in \mathbb{H}(Q)$ .*

**Definition 11.2.** Suppose that  $H \sqsubset \mathcal{H}^+$  and that  $\mathcal{A} \sqsubset Q \setminus H$  is a long annulus containing a bridge annulus. It is **curved** if all of the bridge annuli it contains are curved and **nested** if the all the bridge annuli it contains are nested.

**Lemma 11.3.** Suppose that  $H \sqsubset \mathcal{H}^+$  and that  $\mathcal{A} \sqsubset Q \setminus H$  is a long annulus that does not contain a matched pair. Let its ends be  $\alpha$  and  $\beta$ . Let  $\Sigma$  be the (possibly empty) union of components of  $Q \setminus (H \cup \mathcal{A})$  all on the same side of  $H$  as  $\mathcal{A}$  and such that each component of  $H \setminus \Sigma$  is on the same side of each component of  $\Sigma$ . Let  $P$  be the union of the components of  $H \setminus \Sigma$  that are on the same side of  $\Sigma$  as  $\mathcal{A}$ . The surface  $S = P \cup \Sigma$  is a closed orientable surface in  $M$  bounding a submanifold  $W$  containing  $\mathcal{A}$ . Let  $\mathcal{J} = \mathcal{H} \cap W$ . (The components of  $\mathcal{J}$  may have boundary.) Suppose that every component of  $\mathcal{A} \cap \mathcal{J}$  is separating in the component of  $\mathcal{J}$  containing it.

If  $\mathcal{A}$  is curved (resp. nested) then  $\beta$  is contained in the component of  $H \setminus (\Sigma \cup \alpha)$  that is outside (resp. inside)  $\alpha$ .

*Proof.* Without loss of generality, assume that  $\mathcal{A}$  is curved. By Assumption 11.1,  $S$  separates  $M$ . Starting from  $\alpha$ , label the curves of  $\mathcal{A} \cap \mathcal{J}$  as

$$\alpha = \gamma_0, \gamma_1, \dots, \gamma_{n+2} = \beta$$

as usual. By hypothesis, each  $\gamma_i$  is separating in the component of  $\mathcal{J}$  containing it. Let  $i$  be the first index such that  $A_i$  is a bridge annulus; it is curved with boundary in  $J \sqsubset \mathcal{J}$ . Thus,  $\gamma_{i+1}$  lies in the component of  $J \setminus \gamma_i$  that is outside  $\gamma_i$ . Since there is a path in  $A_0 \cup \dots \cup A_i$  from  $\gamma_{i+1}$  to  $\alpha$ , this implies that if  $J \subset H$ , then  $\gamma_{i+1}$  is also outside  $\alpha$ . Suppose  $J \not\subset H$ . The annulus  $A_{i+1}$  is either vertical or bridge. If it is vertical, consider the annuli  $A_{i+1}, A_{i+2}, \dots, A_{i+k}$  such that either  $\gamma_{i+k+1} = \beta$  or  $A_{i+k+1}$  is bridge. Then  $\gamma_{i+1+j}$  lies in the same component  $J_j \sqsubset \mathcal{J}$  as  $\gamma_{i-j}$  for each  $1 \leq j \leq i+k+1$ . There is a path in  $A_0 \cup \dots \cup A_i \cup \dots \cup A_{i+k}$  from  $\gamma_{i+k+1}$  to  $\gamma_0$ . Thus, if  $\gamma_{i+k+1} = \beta$ , the result holds. If  $A_{i+1}$  is bridge, it is curved. In this case,  $\gamma_{i+2}$  lies in the subsurface of  $\mathcal{J} \setminus \gamma_{i+1}$  with boundary component  $\gamma_{i+1}$  and is outside  $\gamma_{i+1}$ . Since either  $\gamma_i = \alpha$  or  $A_{i-1}$  is vertical, it cannot lie in the subsurface that is inside  $\gamma_i$ . Thus, it lies in the subsurface that is outside  $\gamma_i$ . Continuing in this vein, we eventually see that  $\beta$  lies in the subsurface of  $H \setminus (\Sigma \cup \alpha)$  that is outside  $\alpha$ .  $\square$

**Definition 11.4.** Suppose  $\mathcal{A} = A_0 \cup A_1 \cup \dots \cup A_{n+1}$  is a long annulus such that each  $A_i$  is a VSS or BSS,  $\mathcal{A}$  does not contain a matched pair, and  $\mathcal{A}$  does contain at least one BSS.

A connected subsurface  $F_i \subset \mathcal{H}$  with boundary  $\gamma_i$  is a **filling surface** if it is inside  $\gamma_i$  when  $\mathcal{A}$  is curved and outside  $\gamma_i$  when  $\mathcal{A}$  is nested.  $\mathcal{A}$  is a **tube** if its filling surfaces are pairwise disjoint. See Figure 21 for an example.

**Lemma 11.5** (Tube Lemma). Suppose that  $\mathcal{A}$  is a long annulus that is a component of  $Q \setminus H$  for some  $H \sqsubset \mathcal{H}^+$  and which has the property that each annulus in  $\mathcal{A}$  is a BSS or VSS. Assume that  $\mathcal{A}$  contains a curved (resp. nested) annulus and that the ends of  $\mathcal{A}$  bound disjoint subsurfaces  $F_0, F_{n+1}$  of  $H$  both inside (resp. outside) the ends of  $\mathcal{A}$ . Then  $\mathcal{A}$  is a tube.

*Proof.* This follows quickly from Lemma 11.3 by induction on the number of components of  $\mathcal{A} \cap \mathcal{H}$ . When applying the Lemma, use  $\Sigma = \emptyset$ . Note that the requirement that  $\mathcal{A}$  is a component of  $Q \setminus H$  prevents the situation depicted in Figure 21.  $\square$

We now set about establishing criteria which will tell us when the surface  $Q$  winds around another surface called a *spool*. See Figure 22 for depictions of two spools.

**Definition 11.6.** A **spool** is a closed orientable surface  $P$  that is the union of a long annulus  $\mathcal{A} = A_0 \cup \dots \cup A_{n+1}$  with a surface  $S$  such that:

1.  $S$  is a connected subsurface of some  $H \sqsubset \mathcal{H}^+$  and  $\partial S = \partial \mathcal{A}$

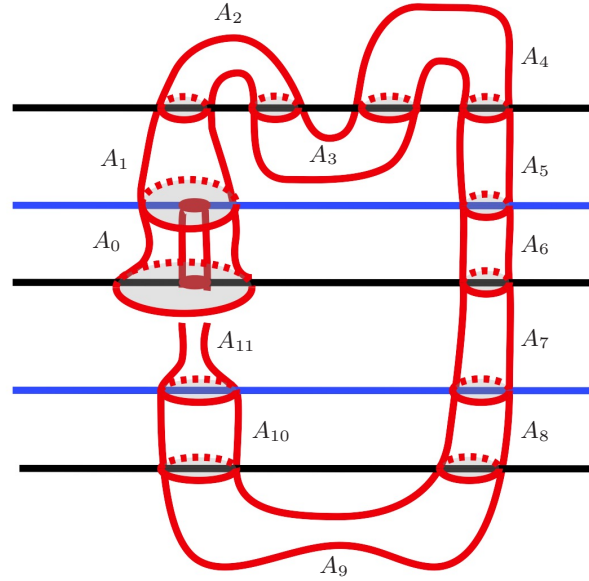

Figure 21: The long annulus  $A_0 \cup \dots \cup A_{10}$  is a tube while the long annulus  $A_0 \cup \dots \cup A_{11}$  is not a tube. The filling surfaces are shaded; the filling surface  $F_{12}$  is inside the filling surface  $F_0$ .

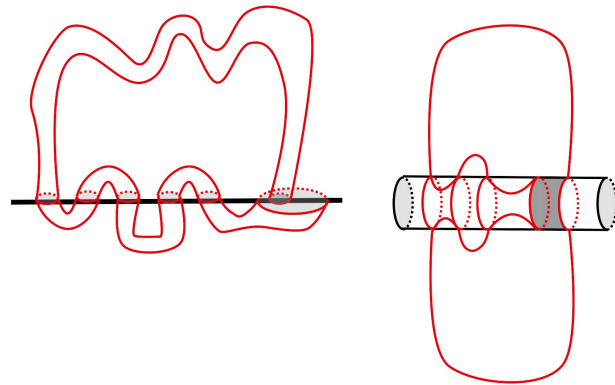

Figure 22: Two spools

2.  $\mathcal{A}$  does not contain a matched pair
3. There exists  $1 \leq k < n + 1$  such that the long annulus  $\mathcal{A}' = A_0 \cup \dots \cup A_k$  is a component of  $Q \setminus H$ .
4. If  $\mathcal{A}'$  is curved (resp. nested) then  $\partial\mathcal{A}' = \gamma_0 \cup \gamma_{k+1}$  is the boundary of a subsurface  $F \subset H$  which is outside (resp. inside) the ends of  $\mathcal{A}'$ .
5. Each curve  $\gamma_i$  for  $k + 1 \leq i \leq n + 1$  is separating in  $F$  and  $S$  has interior disjoint from  $F$ .

By Assumption 11.1, the spool  $P$  separates  $M$ . If  $\mathcal{A}$  is curved, we let  $W \sqsubset M \setminus Q$  be the component that is outside  $\mathcal{A}$ . If  $\mathcal{A}$  is nested, we let  $W \sqsubset M \setminus Q$  be the component that is inside  $\mathcal{A}$ . We call  $W$  the **spool room**.

The next lemma shows that in many cases if there is a spool, then  $Q$  winds around it, similarly to what is depicted in Figure 23.

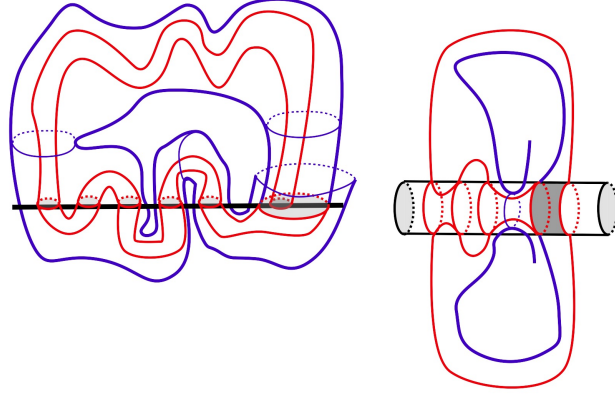

Figure 23: The annulus  $\mathcal{B}$  (the blue and red annulus) is the continuation of the annulus  $\mathcal{A}$  (the red annulus).

**Lemma 11.7** (Spool Lemma). *Suppose that  $P$  is spool as in Definition 11.6, with  $W$  the spool room. Let  $\mathcal{B}$  be the maximal long annulus  $A_0 \cup \dots$  containing  $\mathcal{A}$  and having an end at  $\gamma_0$  such that:*

1.  $\mathcal{B}$  does not contain a matched pair
2. Each curve of  $(\mathcal{B} \setminus \mathcal{A}) \cap \mathcal{H} \cap W$  is separating in the component of  $\mathcal{H} \cap W$  that contains it.

Then  $\mathcal{B}$  lies entirely in  $W$ . Furthermore, if  $A$  is the component of  $Q \setminus (\mathcal{B} \cup H)$  sharing the end  $\partial\mathcal{B} \setminus \gamma_0$  with  $\mathcal{B}$ , one of the following occurs:

1. Either  $A$  is not an annulus or  $\mathcal{B} \cup A$  contains a matched pair.
2.  $A$  contains a curve that is nonseparating in the component of  $\mathcal{J}$  containing it.

*Proof.* The spool consists of a long annulus  $\mathcal{A} \subset Q$  and a subsurface  $S \subset H \sqsubset \mathcal{H}^+$ . We write:

$$\mathcal{A} = \underbrace{A_0 \cup A_1 \cup \dots \cup A_k}_{\mathcal{A}'} \cup A_{k+1} \cup \dots \cup A_{n+1}.$$

We also have the (possibly empty) long annulus  $\mathcal{B}$  which we can express as:

$$\mathcal{B} = \underbrace{A_0 \cup \dots \cup A_{n+1}}_{\mathcal{A}} \cup A_{n+2} \cup \dots \cup A_m.$$

Without loss of generality, we may assume that  $\mathcal{A}'$  is curved, so that each bridge annulus in  $\mathcal{B}$  is curved (as  $\mathcal{B}$  does not contain a matched pair).

Recall that the ends of  $A_i$  are  $\gamma_i$  and  $\gamma_{i+1}$ . We are concerned with those  $\gamma_i$  that lie on  $H$ . To that end, traversing the long annulus  $\mathcal{B}$  beginning at  $\gamma_0$ , label the intersections  $\mathcal{B} \cap H$  as

$$\underbrace{\alpha_0}_{=\gamma_0}, \underbrace{\alpha_1}_{=\gamma_{k+1}}, \alpha_2, \dots, \alpha_p$$

See Figure 24 for an example. By the definition of  $\mathcal{B}$ , each  $\alpha_i$  for  $i \geq 2$  lies in the subsurface  $F$  and separates  $F$ . If  $\alpha_i$  does not separate the components of  $\partial F = \alpha_0 \cup \alpha_1$ , let  $\Phi_i \subset F$  be the subsurface with boundary  $\alpha_i$ ; it must lie inside  $\alpha_i$ . If  $\alpha_i$  separates  $\partial F$ , let  $\Phi_i \subset F$  be the subsurface bounded by  $\alpha_i$  and  $\gamma_0$ .

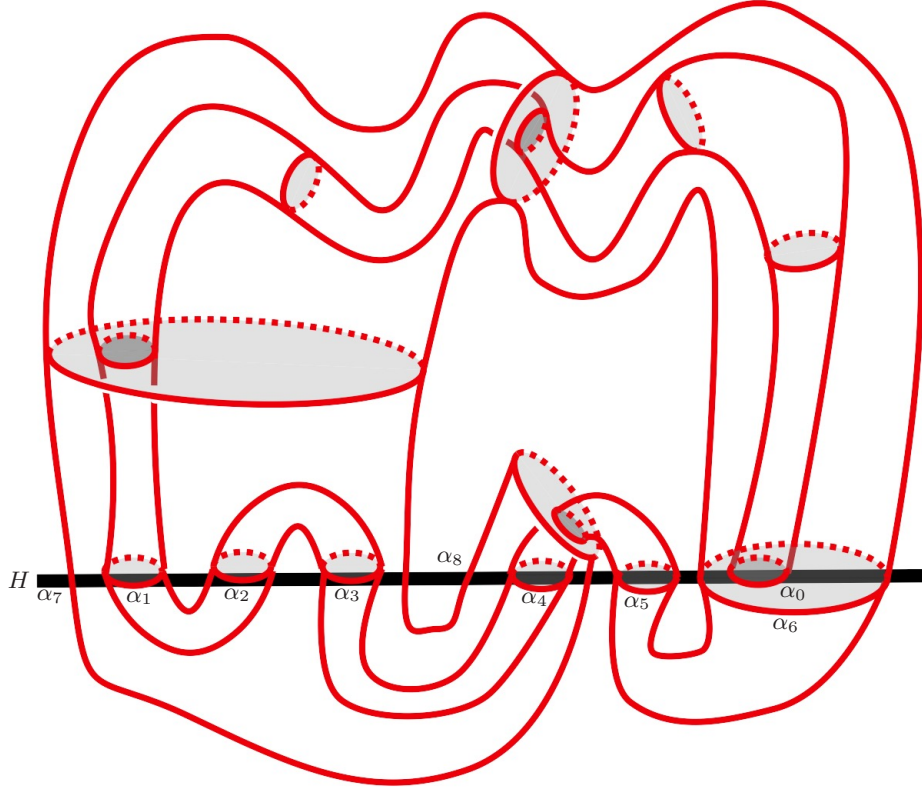

Figure 24: The curves  $\alpha_i$  on  $\mathcal{B}$ . The only component of  $\mathcal{H}$  that is shown is  $H$ .

Assume that Conclusion (1) does not hold; that is,  $A$  is an annulus with one end at  $\alpha_p$  and the other a curve in  $H$  and  $\mathcal{B} \cup A$  does not contain a matched pair. In particular,  $A$  is a curved long annulus.

Number the components of  $\mathcal{B} \setminus H$  as

$$\mathcal{B}' = \mathcal{B}_0, \mathcal{B}_1, \dots, \mathcal{B}_{p-1}$$

Observe that they alternate which side of  $H$  they lie on and that  $\partial \mathcal{B}_i = \alpha_i \cup \alpha_{i+1}$ . Also, each  $\mathcal{B}_i$  is curved. Let  $n_0 = 0$ ,  $n_1 = 1$ , and let  $n_2$  be the index such that  $\alpha_{n_2} = \gamma_{n+2}$ . We prove the result by induction on  $p$ . The Base Case and Inductive Step are nearly identical.

**Base Case:**  $\mathcal{B} \setminus \mathcal{A}$  is empty (i.e.  $p = n + 2$ .)

In this case,  $A$  has one end at  $\alpha_{n_2}$ . By assumption, its other end (call it  $\alpha_{n_3}$ ) lies in  $H$ . Since  $A$  is disjoint from  $\mathcal{A} = \mathcal{B}$  and since the spool surface  $S = \mathcal{A} \cup P$  separates  $M$ , the curve  $\alpha_{n_3}$  lies in  $F$ . We need to show it does not lie in  $P$ . Suppose, to the contrary, that it does lie in  $P$ . Observe that  $P$  is inside  $\alpha_{n_2}$ .

The surface  $F \cup \mathcal{A}'$  separates  $M$  and bounds a submanifold  $W'$  containing  $\mathcal{A}$ . Let  $\mathcal{J}' = \mathcal{H} \cap W'$ . Either Conclusion (2) holds or  $A \cap \mathcal{J}'$  separates the component of  $\mathcal{J}'$  containing it. In which case, by Lemma 11.3,  $A$  cannot have an end in the interior of  $P$ , but this contradicts the maximality of  $\mathcal{B}$ .

**Inductive Step:** Assume that  $p > n + 2$ .

Apply the argument of the Base case to  $\mathcal{A}_{n_2}$  in place of  $A$ . We conclude that  $\alpha_{n_3} = \partial \mathcal{A}_{n_2} \setminus \alpha_{n_2}$  lies in  $F \setminus \Phi_{n_2}$ . We then repeat the argument, applying it to  $\mathcal{A}_{n_3}$  and conclude that its end  $\alpha_{n_4} = \partial \mathcal{A}_{n_3} \setminus \alpha_{n_3}$  lies in  $F \setminus \Phi_{n_3}$ . Continuing in this vein, we conclude that  $\mathcal{B}$  lies entirely in  $W$ . The choice of  $\mathcal{B}$  to be maximal

then ensures that Conclusion (1) or (2) holds.  $\square$

**Definition 11.8.** A **tower** is a long annulus  $\mathcal{T} \sqsubset Q \setminus H$  with both ends on some thick surface  $H$  and which is the union of VNN annuli and exactly one BNN annulus.

Figure 25 depicts a torus  $Q$  that is the union of two towers and some tubes.

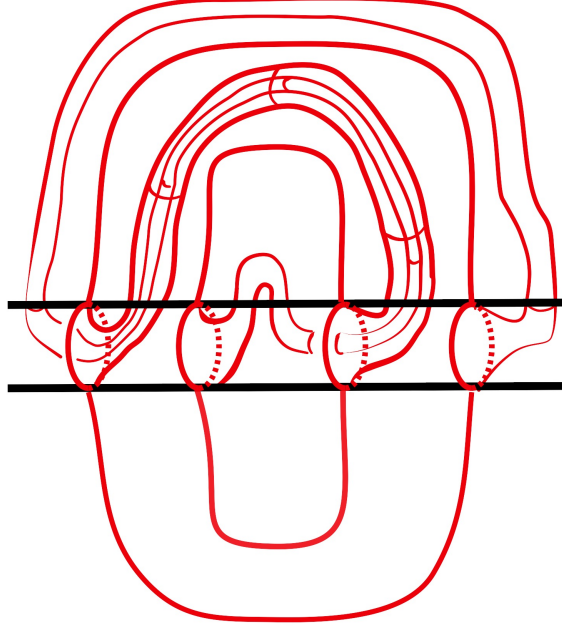

Figure 25: A torus  $Q$  that is the union of two towers, some tubes, and two BNS annuli. Note the existence of matched pairs that are not cancellable matched pairs. The graph  $T$  is not shown, so it is not obvious that  $H$  is weakly reducible. This configuration is what led us to the idea of crushable handles. The horizontal black lines together depict a single thick torus.

**Lemma 11.9.** *Suppose that  $\mathcal{H} \in \mathbb{H}(Q)$ , that  $H' \sqsubset \mathcal{H}^+$ , and that  $\mathcal{T}$  is a long annulus that is the union of VNN and BNN annuli, is a component of  $Q \setminus H'$ , and does not contain a matched pair. Then if every component of  $\mathcal{H}^+$  intersecting  $\mathcal{T}$  is a torus, then  $\mathcal{T}$  is a tower.*

*Proof.* Suppose, to the contrary, that  $\mathcal{T}$  is not a tower. It must, therefore, contain at least two bridge annuli. Without loss of generality, assume that they are curved.

Let  $\beta \sqsubset \mathcal{T} \cap \mathcal{H}$  be the initial end of the second bridge annulus  $A_{k+1}$  (determined by counting starting at either end of  $\mathcal{T}$ ). Let  $\alpha \sqsubset \mathcal{T} \cap \mathcal{H}$  be the loop occurring as the first encounter of  $\mathcal{T}$  with the surface  $H \sqsubset \mathcal{H}^+$  containing the ends of the second bridge annulus. Let  $\mathcal{A}' = A_0 \cup \dots \cup A_k$  be the initial  $k+1$  annuli of  $\mathcal{T}$  and let  $\mathcal{A} = A_0 \cup \dots \cup A_k \cup A_{k+1}$ .

Since  $\mathcal{A}$  is a component of  $Q \setminus H'$ , note that  $H \neq H'$ . Also note that since every component of  $\mathcal{H}^+$  intersecting  $\mathcal{T}$  is a torus, every component of  $\mathcal{H}^-$  intersecting  $\mathcal{T}$  is either a sphere or a torus. However, each annulus of  $\mathcal{T} \setminus \mathcal{H}$  is a VNN or BNN and so each component of  $\mathcal{H}^-$  intersecting  $\mathcal{T}$  is also a torus. Let  $F \sqsubset H \setminus \partial \mathcal{A}'$  be the annulus that is outside  $\partial \mathcal{A}'$ . Let  $S \sqsubset H \setminus \partial \mathcal{A}$  be the annulus contained in  $F$ . Then  $P = \mathcal{A} \cup S$  is a spool. Let  $W$  be the spool room; note that  $H'$  is not contained in  $W$ . Let  $\mathcal{B}$  be the maximal long annulus in  $Q$  containing  $\mathcal{A}$ , having  $\alpha$  as an end, not containing a matched pair, and with each component of



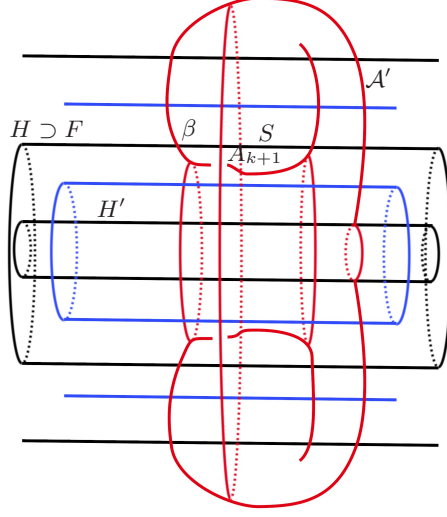

Figure 26: A long enough annulus containing BNN annuli that intersects tori is either a tower or creates a spool. The black and blue lines represent thick and thin tori.

$(\mathcal{B} \setminus \mathcal{A}) \cap \mathcal{H} \cap W$  separating the component of  $\mathcal{H} \cap W$  containing it. If such exists, let  $A \sqsubset Q \setminus (H \cup \mathcal{B})$ . We claim that  $A$  does not exist.

Consider a curve  $\gamma$  of  $\mathcal{B} \cap H'$  that is not an end of  $\mathcal{A}$ . The [Spool Lemma](#) shows that  $\gamma$  lies in  $F \setminus S$ . The bridge annulus  $A_{k+1}$  separates the VPC  $(C, T_C)$  containing it. Let  $A' \sqsubset Q \cap C$  have  $\gamma$  as an end. Observe that  $A' \subset \mathcal{T}$ , as  $H \neq H'$ . Consequently,  $A'$  is an annulus. It cannot be a vertical annulus in  $(C, T_C)$ , as  $\gamma$  separates the ends of  $A_{k+1}$ . It cannot be nested as  $\mathcal{T}$  does not contain a matched pair. It follows that the end of  $\mathcal{B}$  that is not  $\alpha$  lies on a component of  $\mathcal{H} \cap W$ . As  $\mathcal{T}$  is disjoint from all sphere components of  $\mathcal{H}$ , and as if  $(X, T_X)$  is a VPC with  $\partial_+ X$  a torus and  $\partial_- X$  containing a torus, then  $X = T^2 \times I$ , the end  $\partial \mathcal{B} \setminus \alpha$  lies in an annulus component of  $\mathcal{H} \cap W$  and separates the ends of  $W$ . The first annulus of  $A$  must therefore lie in  $\mathcal{T}$  and cannot have an end lying in a torus component of  $\mathcal{H} \cap W$ . This contradicts the maximality of  $\mathcal{B}$ . Consequently,  $A$  cannot exist. Hence, we have both that the end  $\partial \mathcal{B} \setminus \alpha$  lies in  $F \setminus S$  and that  $\mathcal{B} = \mathcal{T}$ . This is a contradiction as the ends of  $\mathcal{T}$  lie on  $H'$ .  $\square$

## 12 Concluding Arguments for $S^3$ and Lens Spaces

**Assumption 12.1.**  $(M, T)$  is standard, irreducible and 1-irreducible.  $M$  is either  $S^3$  or a lens space and  $Q$  is an essential unpunctured torus. Assume that  $\mathcal{H} \in \mathbb{H}(Q)$  is  $Q$ -locally thin, has  $\text{net } g(\mathcal{H}) = 1$  and  $\text{net } w(\mathcal{H}) \leq \mathfrak{b}_1(T)$ . Also assume that there is no cancellable matched pair.

**Lemma 12.2.** If a VPC  $(X, T_X) \sqsubset (M, T) \setminus \mathcal{H}$  contains a component of  $Q \cap (X, T_X)$  with one end nonseparating in  $\partial_+ X$  and the other end separating a component of  $\partial C$ , then  $(X, T_X)$  is either the innermost or outermost VPC with  $\partial_+ X$  a torus.

*Proof.* Recall from Lemma 3.17 that  $\mathcal{H}$  is the union of spheres and tori and all tori in  $\mathcal{H}$  are parallel, once sphere components are ignored. Consequently if some component of  $\mathcal{H}$  is a torus, there exist exactly two compressionbodies  $(C, T_C)$  and  $(D, T_D)$  of  $M \setminus \mathcal{H}$  with  $\partial_+ C$  and  $\partial_+ D$  tori and  $\partial_- C$  and  $\partial_- D$  the (possibly empty) union of spheres. Suppose  $(X, T_X)$  is a compressionbody containing a component  $A \sqsubset Q \cap X$  that has one end nonseparating in  $\partial_+ X$  and has the other end separating in  $\partial X$ . Cap off the separating end and,

after a small isotopy, arrive at an essential disc in  $X$  with nonseparating boundary. Thus,  $(X, T_X)$  must be either  $(C, T_C)$  or  $(D, T_D)$ .  $\square$

**Convention 12.3.** *Henceforth,  $(X, T_X)$  and  $(Y, T_Y)$  will be the innermost and outermost (respectively) VPCs with toroidal positive boundary.*

**Lemma 12.4.** *If both  $X$  and  $Y$  contain BNS or VNS annuli, then there does not exist a long annulus with each intersection with  $\mathcal{H}$  nonseparating in  $\mathcal{H}$  and with one end on  $\partial_+ X$  and one end on  $\partial_+ Y$ .*

*Proof.* If there were such an annulus, we could cap off the separating ends of the BNS and VNS annuli with discs and see that  $M = S^1 \times S^2$ , a contradiction.  $\square$

**Corollary 12.5.** *There is no matched pair  $(A, A')$  with any of the following properties:*

1.  $A$  and  $A'$  are BSS
2. One of  $A, A'$  is BNS and the other is BSS
3.  $A$  and  $A'$  are BNN

*Proof.* In each case, we will show that  $(A, A')$  is cancellable, and thereby contradict Assumption 12.1. Let  $\mathcal{A}$  be a matching sequence for  $(A, A')$ . Without loss of generality, we may assume that  $(A, A')$  is the matched pair of one of the given types of shortest length.

Suppose that  $A, A'$  are both BSS. If  $\mathcal{A}$  contained a VNN or VNS, it must contain at least two VNS. Since  $\mathcal{A} \setminus (A \cup A')$  is vertical, this contradicts Lemma 12.4. Thus, each annulus in  $\mathcal{A} \setminus (A \cup A')$  is a VSS. Consequently,  $(A, A')$  is cancellable, a contradiction.

If one of  $A, A'$  is BNS and the other is BSS, each annulus of  $\mathcal{A} \setminus (A \cup A')$  is VSS, as in the previous case. Consequently,  $(A, A')$  is again cancellable, a contradiction.

Finally, suppose that  $A, A'$  are both BNN. As in the first case, if  $\mathcal{A}$  contained a VSS or VNS, we would contradict Lemma 3.17 or 12.4. Thus,  $\mathcal{A} \setminus (A \cup A')$  entirely consists of VNN annuli. By Lemma 12.4, at most one of  $A$  or  $A'$  is contained in  $X \cup Y$ .

If  $\ell(A, A') = 0$ , let  $H \sqsubset \mathcal{H}^+$  contain  $\partial D \cup \partial D'$ . We note that  $\partial(A \cup A')$  separates  $H$  into three subsurfaces and if  $D, D'$  are  $\partial$ -compressing discs for  $A, A'$  respectively, the arcs  $\partial D \cap H$  and  $\partial D' \cap H$  lie in distinct subsurfaces. This means that  $(A, A')$  is cancellable, a contradiction.

Assume, therefore, that  $\ell(A, A') \geq 2$ . This implies that  $\partial_+ X \neq \partial_+ Y$ . Suppose, for the moment, that one of  $A$  or  $A'$  is contained in  $X \cup Y$ . Without loss of generality, suppose it is  $A$ . Let  $H$  be the thick surface containing  $\partial A$ . (We have  $H = \partial_+ X$  or  $H = \partial_+ Y$ .) Let  $A''$  be the annulus sharing an end with  $A$  and not lying in  $\mathcal{A}$ . We claim that  $A''$  is vertical (and thus a VNN). If it were bridge, it must be a BNN. Since  $A$  is curved,  $A''$  cannot be nested for then we contradict our choice of  $(A, A')$  to minimize length. However, we will see it cannot be curved either. Let  $S \sqsubset H \setminus \partial(A \cup A'')$  be the annulus that is outside a component of  $\partial A$  and inside a component of  $\partial A''$ . Then  $A \cup S \cup A''$  is a spool. Let  $\mathcal{B}$  be the spooling annulus as in the statement of the Spool Lemma. The end of  $\mathcal{B}$  not on the spool must be non-separating in  $H$ . To see this, let  $W$  be the submanifold bounded by the spool and containing  $\mathcal{B}$ . Note that the spool is a torus and that each curve of  $\partial A$  bounds a disc to the complement of  $W$ . If the end of  $\mathcal{B}$  not on the spool separated  $H$ , each curve of  $\partial A$  would bound a surface in both  $W$  and its complement. This contradicts the fact that each closed surface in  $M$  separates  $M$ . Thus, by the maximality of  $\mathcal{B}$ , the end of  $\mathcal{B}$  not on the spool is an end of a BNS or VNS. However the fact that  $A$  is a BNN obstructs this. Thus,  $A''$  is a VNN. The case when  $A'$  is contained in  $X \cup Y$  is nearly identical.

Let  $\mathcal{B}'$  be a maximal vertical long annulus having sharing an end with  $\mathcal{A}$ . If one of  $A$  or  $A'$  is contained in  $X$  or  $Y$ , choose  $\mathcal{B}'$  to contain  $A''$  as above. If such is the case, then the other end of  $\mathcal{B}'$  is not contained  $\partial_+ X \cup \partial_+ Y$ .

A similar appeal<sup>2</sup> to the [Spool Lemma](#), shows that number of annuli in  $\mathcal{B}'$  must be at least the number of annuli in  $\mathcal{A} \setminus (A \cup A')$ . Let  $\mathcal{B} \subset \mathcal{B}'$  contain  $A''$  and have  $\ell(A, A')$  annuli. It follows, that  $\mathcal{B} \cup (\mathcal{A} \setminus (A \cup A'))$  is an extended insulating set. Thus,  $(A, A')$  is a cancellable matched pair, a contradiction.  $\square$

**Corollary 12.6.** *If  $Q$  intersects a sphere component of  $\mathcal{H}$ , then  $Q$  has a crushable handle.*

*Proof.* If  $Q$  intersects a sphere component of  $\mathcal{H}$ , then there is an innermost or outermost VPC  $(C, T_C)$  with  $\partial_+ C$  a sphere intersecting  $Q$ . The result follows as in Lemma [6.11](#).  $\square$

Let  $(X, T_X)$  and  $(Y, T_Y)$  be the VPCs with  $\partial_+ X$  and  $\partial_+ Y$  tori and  $\partial_- X$  and  $\partial_- Y$  either empty or spheres. (These are the innermost and outermost VPCs with positive boundary a torus.)

**Definition 12.7.** A tower is **maximal** if its ends are not incident to VNNs.

**Lemma 12.8.** *Suppose that some component of  $Q \cap \mathcal{H}$  is nonseparating in the component of  $\mathcal{H}$  containing it. Then each component of  $Q \setminus (X \cup Y)$  containing such a curve is a tower either with ends on  $\partial_+ X$  or with ends on  $\partial_+ Y$ . Furthermore, one of the following occurs:*

1.  $Q$  is the union of two towers, each with ends on  $\partial_+ X$  or each with ends on  $\partial_+ Y$ , or
2. Each tower with ends on  $\partial_+ X$  or with ends on  $\partial_+ Y$  and not in  $X$  or  $Y$  respectively, has its ends incident to BNS annuli lying in  $X$  or  $Y$  respectively.

*Proof.* As we traverse  $Q$  examining the components of  $Q \cap \mathcal{H}$ , we may label each component as either S or N depending on whether or not it separates the component of  $\mathcal{H}$  containing it. If no component is labelled N, the result is vacuous, so assume there is at least one N. Each component of  $Q \setminus \mathcal{H}$  which has one end labeled N and one labeled S is a BNS that lies in either  $X$  or  $Y$ . Furthermore, by Lemma [3.17](#), no long annulus that is the union of VNNs has ends at both  $\partial_+ X$  and  $\partial_+ Y$ . Consequently each component of  $Q \setminus \partial_+ X$  that is disjoint from the interior of  $X$  and has one end labelled N and on  $\partial_+ X$  also has its other end labelled N and on  $\partial_+ X$ . The analogous statement holds for  $Y$ .

Let  $H = \partial_+ X$ . By Lemma [11.9](#), each component  $\mathcal{T} \subset Q \setminus H$  with at least one end non-separating on  $H$  must be a tower. Similarly for  $H = \partial_+ Y$ . Suppose that  $\mathcal{T}$  is one such tower. Without loss of generality, we may assume its ends are non-separating curves on  $\partial_+ X$  and that it is curved. Let  $F \subset \partial_+ X \setminus \partial \mathcal{T}$  be the annulus that is outside  $\partial \mathcal{T}$ . Let  $R$  be a component of  $Q \cap \partial_+ X$  incident to an end of  $\mathcal{T}$ . Since  $Q$  is disjoint from sphere components of  $\mathcal{H}$ ,  $R$  is a BNN or BNS.

Suppose that  $R$  is a BNN. If  $\partial R = \partial \mathcal{T}$ , then Conclusion (1) holds. So assume that an end  $\gamma$  is not an end of  $\mathcal{T}$ . If  $\gamma \subset F$ , let  $S \subset F$  be the annulus between  $\gamma$  and the end of  $\mathcal{T}$  not shared with  $R$ . In this case  $\mathcal{T} \cup R \cup S$  is a spool. Let  $\mathcal{B}$  be the maximal annulus containing  $\mathcal{T} \cup R$ , having  $\partial \mathcal{T} \setminus R$  as an end, and which is the union of VNN and BNN annuli. Observe that  $\mathcal{B}$  does not contain a matched pair since if it did it would contain a cancellable matched pair by Lemma [12.5](#), contradiction. Furthermore,  $\mathcal{B}$  is contained in the spool room  $W$  and so each component of  $\mathcal{H}^+$  that intersects it is an annulus with ends on  $\mathcal{T}$ . Thus, each component of  $\mathcal{B} \cap \mathcal{H}^+ \cap W$  separates the component of  $\mathcal{H}^+ \cap W$  that it intersects. By the [Spool Lemma](#),  $\mathcal{B}$  has an end in the interior of  $F \setminus S$ . Such an end  $\gamma'$  must be incident to a BNS, however this is impossible since  $\gamma'$  separates the ends of the annulus  $R$ . Thus, we encounter a contradiction. The situation when  $\gamma$  does not lie in  $F$  is similar, except that we reverse the roles of  $\mathcal{T}$  and  $R$  when defining the spool. We conclude that if Conclusion (1) does not hold each long annulus that is the maximal union of VNN and BNN annuli is a tower disjoint from the interior of  $X \cup Y$  and either has its ends on  $\partial_+ X$  or has its ends on  $\partial_+ Y$ . These ends can only be incident to BNS annuli in  $X \cup Y$  since  $Q$  is disjoint from the sphere components of  $\mathcal{H}$ .  $\square$

<sup>2</sup>We elaborate on this argument in the proof of Lemma [12.8](#) below.

**Definition 12.9.** Suppose  $\mathcal{T}$  is a tower with ends on  $\partial_+X$  or  $\partial_+Y$ . If  $\mathcal{T}$  is curved (resp. nested), the annulus component of  $\partial_+X \setminus \partial\mathcal{T}$  or  $\partial_+Y \setminus \partial\mathcal{T}$  is the **shadow annulus** for  $\mathcal{T}$  if it is outside  $\mathcal{T}$  (resp. inside  $\mathcal{T}$ ).

The **height**  $h(\mathcal{T})$  of  $\mathcal{T}$  is  $h(\mathcal{T}) = |\mathcal{T} \cap \mathcal{H}^+|/2$ . It is the number of components of  $\mathcal{H}^+$  it intersects.

**Lemma 12.10.** *Suppose that  $\mathcal{T}_1$  and  $\mathcal{T}_2$  are two towers, each with ends on  $\partial_+X$  or each with ends on  $\partial_+Y$  and not lying in  $X$  or  $Y$  respectively. Then either the shadow annulus for  $\mathcal{T}_1$  is contained in the shadow annulus for  $\mathcal{T}_2$  or the shadow annulus for  $\mathcal{T}_2$  is contained in the shadow annulus for  $\mathcal{T}_1$ .*

*Proof.* Without loss of generality, assume that  $\mathcal{T}_1$  and  $\mathcal{T}_2$  have their ends on  $\partial_+X$  and that they do not lie in  $X$ . Let  $\alpha_i$  be the shadow annulus for  $\mathcal{T}_i$  with  $i = 1, 2$ . Suppose, to establish a contradiction, that  $\alpha_1 \not\subset \alpha_2$  and  $\alpha_2 \not\subset \alpha_1$ . Since  $\alpha_i \cup \mathcal{T}_i$  is a separating surface, this implies that  $\alpha_1 \cap \alpha_2 = \emptyset$ . Recall from Lemma 7.5 that both  $\alpha_1$  and  $\alpha_2$  contain the boundaries of  $Q$ -discs for the VPC  $(C, T_C) \neq (X, T_X)$  having  $\partial_+C = \partial_+X$ . Let  $D \subset (X, T_X)$  be an  $c$ -disc for  $\partial_+X$ . We may find such that is disjoint from  $Q$ . In which case,  $\partial D$  is disjoint from either  $\alpha_1$  or  $\alpha_2$ . This contradicts the  $Q$ -c-strong irreducibility of  $\partial_+X$ . Thus, either  $\alpha_1 \subset \alpha_2$  or  $\alpha_2 \subset \alpha_1$ .  $\square$

**Lemma 12.11.** *Unless  $Q$  has a crushable handle, no component of  $Q \setminus \mathcal{H}$  is a BSS with ends bounding disjoint discs in  $\mathcal{H}^+$ .*

*Proof.* Suppose that  $A$  is a BSS with ends bounding disjoint discs  $D_1, D_2$  in  $\mathcal{H}^+$ . Consider all the components of  $Q \setminus \mathcal{H}$  in the same VPC as  $A$  and with at least one end in  $D_1 \cup D_2$ . By replacing  $A$  with an innermost such annulus, we may assume that no such annulus has ends bounding disjoint discs in  $D_1 \cup D_2$ . Since  $Q$  is disjoint from spheres in  $\mathcal{H}$  (Lemma 12.6), no annulus with an end in  $D_1 \cup D_2$  is vertical. Consequently,  $A$  is crushable.  $\square$

**Lemma 12.12.** *If some component of  $Q \cap \mathcal{H}$  is nonseparating in  $\mathcal{H}$ , then either  $Q$  is the union of two towers or  $Q$  has a crushable handle.*

*Proof.* Suppose that  $Q \cap \mathcal{H}$  contains a curve that does not separate  $\mathcal{H}$ . Thus, each component of  $Q \setminus (X \cup Y)$  containing such a curve is a tower with ends on  $\partial_+X$  or  $\partial_+Y$  by Lemma 12.8. If  $Q$  is not the union of two towers, then the ends of a tower lying on  $\partial_+X$  (resp.  $\partial_+Y$ ) but not in  $X$  (resp.  $Y$ ) are incident to BNS annuli in  $X$  (resp.  $Y$ ). There is at least one such tower. Without loss of generality, we may suppose there is a tower with ends on  $\partial_+X$  and not contained in  $X$ . By Lemma 12.10, the shadow annuli for all such towers form a nested sequence of annuli in  $\partial_+X$ , each one properly contained in the next.

Let  $\mathcal{T}$  be a tower with innermost shadow annulus  $\alpha$ ; that is  $\alpha$  does not contain the ends of any other tower. Indeed, it does not contain any component of  $Q \cap \partial_+X$  that is nonseparating in  $\partial_+X$ . Let  $\beta = \partial_+X \setminus \alpha$  be the complementary annulus and let  $A_1$  and  $A_2$  be the BNS annuli incident to the ends of  $\mathcal{T}$ .

**Case 1:** The separating ends of  $A_1$  and  $A_2$  both lie in  $\beta$ .

Both  $A_1$  and  $A_2$  are  $\partial$ -compressible in  $(X, T_X)$ . Let  $D$  be a  $\partial$ -compressing disc for one of them chosen so as to intersect  $Q$  minimally among all such discs. Without loss of generality, suppose it is a  $\partial$ -compressing disc for  $A_1$ . If  $D \cap A_2 \neq \emptyset$ , an outermost arc of intersection would cut off a  $\partial$ -compressing disc for  $A_2$  intersecting  $Q$  fewer times than does  $D$ . Thus,  $D \cap A_2 = \emptyset$ . Since the interior of the arc  $D \cap \partial_+X$  is then disjoint from  $A_1 \cup A_2$ , it lies in  $\beta$ . After  $\partial$ -compressing  $A_1$  or another component of  $Q \cap X$  intersecting  $D$  using a (sub)disc of  $D$ , we construct an  $Q$ -disc for  $\partial_+X$  in  $(X, T_X)$  with boundary contained in  $\beta$ . But since the VPC on the opposite side of  $\partial_+X$  from  $X$  has an  $Q$ -disc with boundary contained in  $\alpha$ , we contradict the  $Q$ -strong irreducibility of  $\partial_+X$ . Thus, this case cannot occur.

**Case 2:** One or both of the separating ends of  $A_1$  and  $A_2$  lie in  $\alpha$ .

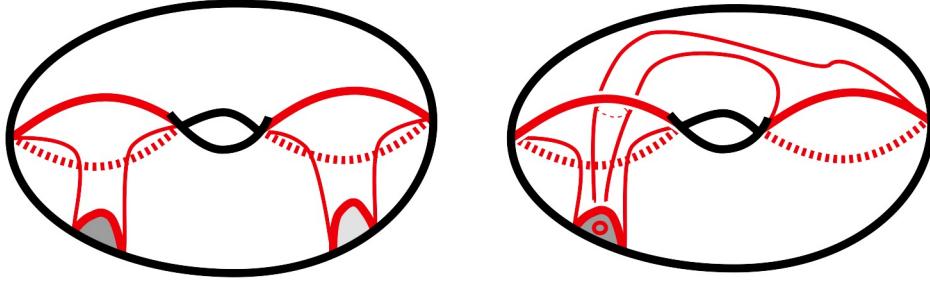

Figure 27: This figure shows the possible configurations in Case 2.

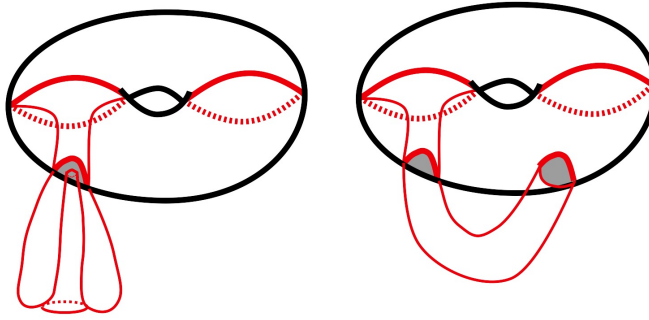

Figure 28: On the left we see that there will be a cancellable matched pair. On the right we see a crushable handle.

The separating end  $\partial_s A_i$  of  $A_i$  bounds a disc  $D_i$  in  $\partial_+ X$ . If both  $D_1$  and  $D_2$  are contained in  $\alpha$ , either they are disjoint or one is contained in the other, as in Figure 27. Choose the numbering so that  $D_1 \subset \alpha$  and if  $D_2 \subset \alpha$  then  $D_1 \not\subset D_2$ .

Let  $\mathcal{A}' \neq A_1$  be the component of  $Q \setminus \partial_+ X$  having the separating end  $\partial_s A_1$  of  $A_1$  as one of its ends. Note that  $\mathcal{A}'$  is the union of BSS and VSS annuli. Consequently, it does not contain a matched pair. Its ends are both separating and so it is a tube by the [Tube Lemma](#). If the end  $\partial \mathcal{A}' \setminus \partial_s A_1$  lies in  $D_1$ , then  $A_1 \cup \mathcal{A}'$  contains a cancellable matched pair as on the left side of Figure 28, a contradiction. If the end  $\partial \mathcal{A}' \setminus \partial_s A_1$  bounds a disc disjoint from  $D_1$ , then  $\mathcal{A}'$  contains a BSS having ends bounding disjoint discs. This means that  $Q$  contains a crushable handle by Lemma 12.11. Thus, we may assume that the end  $\partial \mathcal{A}' \setminus \partial_s A_1$  bounds a disc  $D'_1 \subset \alpha$  containing  $D_1$ . Observe that the end  $\partial \mathcal{A}' \setminus \partial_s A_1$  cannot be the end of a BNS since we chose  $\mathcal{T}$  to be innermost. It is, therefore, the end of a BSS in  $(X, T_X)$  (since any vertical annulus in  $(X, T_X)$  would have an end on a sphere component of  $\mathcal{H}^-$ ). The other end of that BSS bounds a disc  $D''_1$  contained in  $D'_1$  and containing  $D_1$ . Let  $\mathcal{A}$  be the union of  $\mathcal{A}'$  with that BSS. The surface  $\mathcal{A} \cup (D'_1 \setminus D_1)$  is a spool surface.

Let  $\mathcal{B}$  be the long annulus containing  $\mathcal{A}$  and sharing its initial end with  $\mathcal{A}$  and which is the maximal union of BSS and VSS. The proof of the [Spool Lemma](#) shows that the terminal end of  $\mathcal{B}$  lies in  $D'_1 \setminus D''_1$ . However, this is impossible, for the terminal end of  $\mathcal{B}$  must be the end of a BNS but  $\mathcal{T}$  is innermost. Thus, if Case 2 occurs,  $Q$  contains a crushable handle, as on the right of Figure 28.  $\square$

**Lemma 12.13.** *Suppose that no curve of  $Q \setminus \mathcal{H}$  is nonseparating in  $\mathcal{H}$  and that  $Q$  does not have a crushable handle. Then  $Q$  is the union of two bridge annuli  $A_1$  and  $A_2$ , with VSS annuli. Each end of each of  $A_1$  and  $A_2$  bounds a disc in  $\mathcal{H}$  and for each of them one of those discs contains the other.*

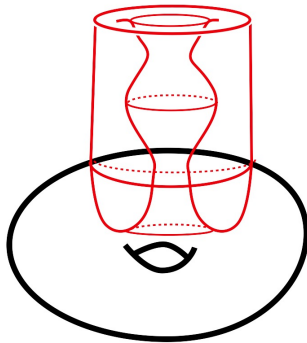

Figure 29: When all curves of  $Q \cap \mathcal{H}$  are separating in  $\mathcal{H}$  and there is no crushable handle,  $Q$  is the union of two BSS and some VSS.

The situation of Lemma 12.13 is depicted in Figure 29.

*Proof.* As in the proof of Lemma 12.12, this follows from the Spool Lemma and the absence of cancellable matched pairs.  $\square$

We now conclude the proof of the Main Theorem.

**Theorem 12.14.** *Suppose that  $T$  is a graph in a 3-manifold  $M$ , which is either  $S^3$  or a lens space. Suppose that  $Q \subset (M, T)$  is a  $c$ -essential unpunctured torus compressible to exactly one side  $V$  in  $M$  and that  $T \cap V^c$  is a link. Then for any weighted companion  $\mathbf{L} = (T \cap V^c) \cup \mathbf{K}$  for  $T$  with respect to  $V$ , either  $K$  is a torus knot or  $\mathbf{b}_1(T) \geq \mathbf{b}_1(\mathbf{L}) - \omega\delta$ , where  $\delta = 1$  if  $V$  is a lensed solid torus and  $\delta = 0$  otherwise.*

*Proof.* By Theorem 4.6, there exists  $\mathcal{H} \in \mathbb{H}(Q)$  such that  $\text{net } g(\mathcal{H}) = 1$  and  $\text{net } w(\mathcal{H})/2 \leq \mathbf{b}_1(T)$ . By Corollary 4.8, we may assume that  $\mathcal{H}$  is adapted to  $Q$ . If  $Q \sqsubset \mathcal{H}^-$ , then by Proposition 3.17, it is a Heegaard torus for  $M$  and compresses to both sides in  $M$ , contradicting our hypothesis.

By Proposition 10.8, we may assume there are no cancellable matched pairs. By Corollary 12.5,  $Q$  has no matched pairs  $(A, A')$  with both of  $A, A'$  BSS, or both BNN, or one BNS and the other BSS.

If  $Q \cap \mathcal{H}$  contains a curve that is non-separating on  $\mathcal{H}$ , then by Lemma 12.12, we may assume that either  $Q$  contains a crushable handle or  $Q$  is the union of two BNN annuli and VNN annuli. On the other hand, if all curves of  $Q \cap \mathcal{H}$  are separating in  $\mathcal{H}$ , then by Lemma 12.13, we may assume that either  $Q$  contains a crushable handle or  $Q$  is the union of two BSS annuli and VSS annuli. If  $Q$  contains a crushable handle, the theorem holds by Corollary 6.10. Thus, we have two possibilities to consider:

1.  $Q$  is the union of two BSS annuli and some number of VSS annuli
2.  $Q$  is the union of two BNN annuli and some number of VNN annuli

Let  $H \sqsubset \mathcal{H}^+$  be a thick surface intersecting  $Q$ . Let  $\mathcal{A}_1$  and  $\mathcal{A}_2$  be the components of  $Q \setminus H$ . Each of  $\mathcal{A}_1$  and  $\mathcal{A}_2$  is isotopic into  $H$  (ignoring  $T$ ). In both cases (1) and (2), they actually must be isotopic to each other, for otherwise  $Q$  is isotopic to  $H$ , contradicting the assumption that  $Q$  is compressible in  $M$  to a unique side. Using this parallelism, a spanning arc in  $\mathcal{A}_1$  traces out a compressing disc  $D$  for  $Q$  in  $M$ . In Case (1), an innermost disc in  $H$  with boundary a curve of  $Q \cap H$  is a compressing disc for  $Q$  in  $M$  on the opposite side from  $D$ . This again contradicts the assumption that  $Q$  compresses to a unique side in  $M$ . We are, therefore in Case (2). If the curves of  $H \cap Q$  bound a disc to one side of  $H$ , there is such a disc with

interior disjoint from  $Q$  and on the opposite side of  $Q$  from  $D$ . Again we contradict the assumption that  $Q$  compresses to a unique side. Thus, the curves of  $Q \cap H$  are torus knots in  $M$  and intersect  $D$  exactly once. Let one of them be called  $K$ ; it is a torus knot companion for  $Q$  relative to  $V$ .  $\square$

## References

- [1] Colin Adams and Todd Shaylor, *The projection stick index of knots*, J. Knot Theory Ramifications **18** (2009), no. 7, 889–899. MR2549474
- [2] Kenneth L. Baker, *Small genus knots in lens spaces have small bridge number*, Algebr. Geom. Topol. **6** (2006), 1519–1621. MR2253458
- [3] Kenneth L. Baker, Cameron Gordon, and John Luecke, *Bridge number and integral Dehn surgery*, Algebr. Geom. Topol. **16** (2016), no. 1, 1–40. MR3470696
- [4] R. Blair, A. Kjuchukova, R. Velazquez, and P. Villanueva, *Wirtinger systems of generators of knot groups*, Comm. Anal. Geom. **28** (2020), no. 2, 243–262. MR4101339
- [5] Ryan Blair, Marion Campisi, Scott A. Taylor, and Maggy Tomova, *Distortion and the bridge distance of knots*, J. Topol. **13** (2020), no. 2, 669–682. MR4092777
- [6] Ryan C. Blair, *Bridge number and Conway products*, Algebr. Geom. Topol. **10** (2010), no. 2, 789–823. MR2629764
- [7] Michel Boileau, Yeonhee Jang, and Richard Weidmann, *Meridional rank and bridge number for a class of links*, Pacific J. Math. **292** (2018), no. 1, 61–80. MR3708258
- [8] A. J. Casson and C. McA. Gordon, *Reducing Heegaard splittings*, Topology Appl. **27** (1987), no. 3, 275–283. MR918537
- [9] Alberto Cavicchioli and Toshio Saito, *On some classes of hyperbolic knots with the 3-sphere surgery*, Topology Appl. **159** (2012), no. 4, 1074–1084. MR2876714
- [10] H. Doll, *A generalized bridge number for links in 3-manifolds*, Math. Ann. **294** (1992), no. 4, 701–717. MR1190452
- [11] Richard Ehrenborg and Masahiro Hachimori, *Non-constructible complexes and the bridge index*, European J. Combin. **22** (2001), no. 4, 475–489. MR1829741
- [12] M. Eudave-Muñoz, F. Manjarrez-Gutiérrez, and E. Ramírez-Losada, *Classification of genus two knots which admit a  $(1, 1)$ -decomposition*, Topology Appl. **230** (2017), 468–489. MR3702785
- [13] Mario Eudave-Muñoz, *Incompressible surfaces and  $(1, 1)$ -knots*, J. Knot Theory Ramifications **15** (2006), no. 7, 935–948. MR2251034
- [14] ———, *Incompressible surfaces and  $(1, 2)$ -knots*, Workshop on Heegaard Splittings, 2007, pp. 35–87. MR2408243
- [15] Mario Eudave-Muñoz and Enrique Ramírez-Losada, *Meridional surfaces and  $(1, 1)$ -knots*, Trans. Amer. Math. Soc. **361** (2009), no. 2, 671–696. MR2452820
- [16] David Gabai, *Foliations and the topology of 3-manifolds. III*, J. Differential Geom. **26** (1987), no. 3, 479–536. MR910018
- [17] Hiroshi Goda, Chuichiro Hayashi, and Hyun-Jong Song, *A criterion for satellite 1-genus 1-bridge knots*, Proc. Amer. Math. Soc. **132** (2004), no. 11, 3449–3456. MR2073323
- [18] C. McA. Gordon, *3-dimensional topology up to 1960*, History of topology, 1999, pp. 449–489. MR1674921
- [19] Joshua Evan Greene, Sam Lewallen, and Faramarz Vafaei,  *$(1, 1)$   $L$ -space knots*, Compos. Math. **154** (2018), no. 5, 918–933. MR3798589
- [20] Chuichiro Hayashi, *Satellite knots in 1-genus 1-bridge positions*, Osaka J. Math. **36** (1999), no. 3, 711–729. MR1740829
- [21] Chuichiro Hayashi and Koya Shimokawa, *Thin position of a pair  $(3$ -manifold,  $1$ -submanifold)*, Pacific J. Math. **197** (2001), no. 2, 301–324. MR1815259
- [22] Qidong He and Scott A. Taylor, *Links, bridge number, and width trees*, J. Math. Soc. Japan (2022), available at [2005.12388](#).
- [23] Nicolaas H. Kuiper and William H. Meeks III, *The total curvature of a knotted torus*, J. Differential Geom. **26** (1987), no. 3, 371–384. MR910013
- [24] Tao Li, *Heegaard genus, degree-one maps, and amalgamation of 3-manifolds*, J. Topol. **15** (2022), no. 3, 1540–1579. MR4461853
- [25] J. W. Milnor, *On the total curvature of knots*, Ann. of Math. (2) **52** (1950), 248–257. MR37509
- [26] Kanji Morimoto and Makoto Sakuma, *On unknotting tunnels for knots*, Math. Ann. **289** (1991), no. 1, 143–167. MR1087243
- [27] Kunio Murasugi, *An estimate of the bridge index of links*, Kobe J. Math. **5** (1988), no. 1, 75–86. MR988581
- [28] Carlo Petronio, *Spherical splitting of 3-orbifolds*, Math. Proc. Cambridge Philos. Soc. **142** (2007), no. 2, 269–287. MR2314601

- [29] Toshio Saito, *Satellite (1, 1)-knots and meridionally incompressible surfaces*, Topology Appl. **149** (2005), no. 1-3, 33–56. MR2130857
- [30] Martin Scharlemann, *There are no unexpected tunnel number one knots of genus one*, Trans. Amer. Math. Soc. **356** (2004), no. 4, 1385–1442. MR2034312
- [31] Martin Scharlemann, Jennifer Schultens, and Toshio Saito, *Lecture notes on generalized Heegaard splittings*, World Scientific Publishing Co. Pte. Ltd., Hackensack, NJ, 2016. Three lectures on low-dimensional topology in Kyoto. MR3585907
- [32] Martin Scharlemann and Abigail Thompson, *Thin position and Heegaard splittings of the 3-sphere*, J. Differential Geom. **39** (1994), no. 2, 343–357. MR1267894
- [33] ———, *Thin position for 3-manifolds*, Geometric topology (Haifa, 1992), 1994, pp. 231–238. MR1282766
- [34] Trenton Schirmer, *A lower bound on tunnel number degeneration*, Algebr. Geom. Topol. **16** (2016), no. 3, 1279–1308. MR3523039
- [35] Horst Schubert, *Knoten und Vollringe*, Acta Math. **90** (1953), 131–286. MR72482
- [36] ———, *Über eine numerische Knoteninvariante*, Math. Z. **61** (1954), 245–288. MR72483
- [37] Jennifer Schultens, *The classification of Heegaard splittings for (compact orientable surface)  $\times S^1$* , Proc. London Math. Soc. (3) **67** (1993), no. 2, 425–448. MR1226608
- [38] ———, *Additivity of bridge numbers of knots*, Math. Proc. Cambridge Philos. Soc. **135** (2003), no. 3, 539–544. MR2018265
- [39] ———, *Bridge numbers of torus knots*, Math. Proc. Cambridge Philos. Soc. **143** (2007), no. 3, 621–625. MR2373962
- [40] ———, *The bridge number of a knot*, Encyclopedia of knot theory, 2021.
- [41] ———, *Satellite knots*, Encyclopedia of knot theory, 2021.
- [42] Scott Taylor and Maggy Tomova, *Additive invariants for knots, links and graphs in 3-manifolds*, Geom. Topol. **22** (2018), no. 6, 3235–3286. MR3858764
- [43] Scott A. Taylor, *Equivariant Heegaard genus of reducible 3-manifolds*, Math. Proc. Cambridge Philos. Soc. **175** (2023), no. 1, 51–87. MR4600195
- [44] Scott A. Taylor and Maggy Tomova, *Thin position for knots, links, and graphs in 3-manifolds*, Algebr. Geom. Topol. **18** (2018), no. 3, 1361–1409. MR3784008
- [45] ———, *Tunnel number and bridge number of composite genus 2 spatial graphs*, Pacific J. Math. **314** (2021), no. 2, 451–494. MR4337471
- [46] William Thurston, *Geometry and topology of 3-manifolds*, Lecture Notes.
- [47] Maggy Tomova, *Thin position for knots in a 3-manifold*, J. Lond. Math. Soc. (2) **80** (2009), no. 1, 85–98. MR2520379
- [48] Junhua Wang and Yanqing Zou, *On tunnel numbers of a cable knot and its companion*, Topology Appl. **282** (2020), 107319, 16. MR4122695
- [49] Keith Wolcott, *The knotting of theta curves and other graphs in  $S^3$* , Geometry and topology (Athens, Ga., 1985), 1987, pp. 325–346. MR873302
- [50] Yoshiyuki Yokota, *On quantum  $SU(2)$  invariants and generalized bridge numbers of knots*, Math. Proc. Cambridge Philos. Soc. **117** (1995), no. 3, 545–557. MR1317496
- [51] Bruno Zimmermann, *Genus actions of finite groups on 3-manifolds*, Michigan Math. J. **43** (1996), no. 3, 593–610. MR1420594
- [52] Alexander Zupan, *A lower bound on the width of satellite knots*, Topology Proc. **40** (2012), 179–188. MR2817298