

NEUTRON STARS AS A DENSE LIQUID DROP AT EQUILIBRIUM WITHIN THE EFFECTIVE SURFACE APPROXIMATION

A.G. Magner,^{1,2,*} S.P. Maydanyuk,^{1,3} A. Bonasera,²
H. Zheng,⁴ T. Depastas,² A.I. Levon,¹ and U.V. Grygoriev^{1,5}

¹*Institute for Nuclear Research, 03028 Kyiv, Ukraine*

²*Cyclotron Institute, Texas A&M University, College Station, Texas 77843, USA*

³*Wigner Research Center for Physics, Budapest 1121, Hungary*

⁴*School of Physics and Information Technology,*

Shaanxi Normal University, Xi'an 710119, China

⁵*University of Groningen, 9712 TS Groningen, Netherlands*

(Dated: March 5, 2024)

The macroscopic model for a neutron star (NS) as a liquid drop for the equilibrium at zero temperature, $T = 0$, is formulated for derivations of the equation of state (EoS) for the pressure $P = P(\rho)$, the particle number density ρ , and the NS mass M expressions in the leptodermic approximation $a/R \ll 1$, where a is the diffused NS effective surface (ES), and R is the effective NS radius. The macroscopic gravitation is taken into account in terms of the potential $\Phi(\rho)$ as a second order expansion in powers of $\rho - \bar{\rho}$, where $\bar{\rho}$ is the saturation density. The density distribution ρ across the NS ES in the normal direction to the ES was obtained analytically for a general form of the energy density $\mathcal{E}(\rho)$, in the leading order of the approximation $a/R \ll 1$ for both spherical and deformed ES shapes. For a spherically symmetric NS and its typical parameters such as a crust thickness, $a \sim 1$ km, effective radii, $R \sim 10$ km, and central particle-number density (saturation) value, $\bar{\rho} \sim 2 \cdot 0.16 \text{ fm}^{-3}$, we find the leading expression for the particle number density ρ . The surface NS mass correction M_S to the volume part, M_V , is found as $M_S \approx -(2a/R)M_V$. The analytical solution to the Tolman-Oppenheimer-Volkoff (TOV) equations for the pressure P at different typical experimentally known NS masses, $M = (1.4 - 2.0)M_\odot$, is in good agreement with the corresponding numerical results. As shown from their comparison with our EoS pressure, $P = P(\rho)$, we emphasize importance of its surface corrections P_S near the NS edge.

I. INTRODUCTION

R.C. Tolman suggested [1] first to study the simplest model for a neutron star (NS) considering it as a dense liquid-matter drop at its equilibrium under the gravitational, and other realistic forces; see also his book [2]. The Einstein equations have been reduced for the spherical symmetry case to the three independent equations for four unknown quantities, namely two quantities of the Schwarzschild metric, and the pressure P , and particle number density ρ . To get the complete system of equations he suggested also to derive independently the equation of state, $P = P(\rho)$. The EoS can be found from the condition of a static equilibrium for a liquid-matter drop under gravitational, and nuclear (and Coulomb) forces, which all should be taken into account by the simplified Einstein equations. Following Tolman's ideas, Oppenheimer and Volkoff [3] derived the simple equations by using the macroscopic properties [4, 5] of the system as a liquid drop at equilibrium. As shown in Ref. [2], one can derive the analytical solution for the pressure P as function of the radial coordinate. So far, the TOV equations [3] are considered with the equation of state, $P = P(\rho)$, which was derived independently of the macroscopic assumptions in the TOV derivation for calculations of the NS distributions of the density ρ . As a result, the pressure P can be calculated as function of the radial r coordinate. Then, the NS mass M was

calculated numerically as function of the NS radius R , $M = M(R)$, and found the maximal NS mass. See many applications of TOV equations, e.g., in Refs. [6–13]. Concerning the relation of the nuclear and neutron matter liquid models to NS properties, we should also mention the work [14] by Baym, Bethe, and Pethick with discussions of the liquid matter drop having a sharp decrease of the particle number density in a relatively small edge region considered as its surface. Clear specific definitions and complete updated results for the energy density with density gradient (surface) terms and for equations of state of infinite matter with many inter-particle forces in the non-relativistic and relativistic cases can be found in the recent review Ref. [13].

Taking Tolman's ideas, one can try first to extend the EoS to those for a dense macroscopic [4, 5] system of particles. In this system, the particle density ρ is function of the radial coordinate with exponentially decreasing behavior from an almost constant saturation value inside of the dense system to that through the NS effective surface (ES) in a relatively small crust range a ; see Fig. 1. The ES is defined as the points of spatial coordinates with maximum density gradients. To obtain the analytical solutions for the particle density and EoS, we use the leptodermic approximation [2–4, 12, 15–24], $a/R \ll 1$, where R is the (curvature) radius of the ES, first, in the non-relativistic limit. In this approximation, the gravitation forces can be taken into account through the potential Φ determined by the Poisson equation as function of the particle

* Email: magner@kinr.kiev.ua

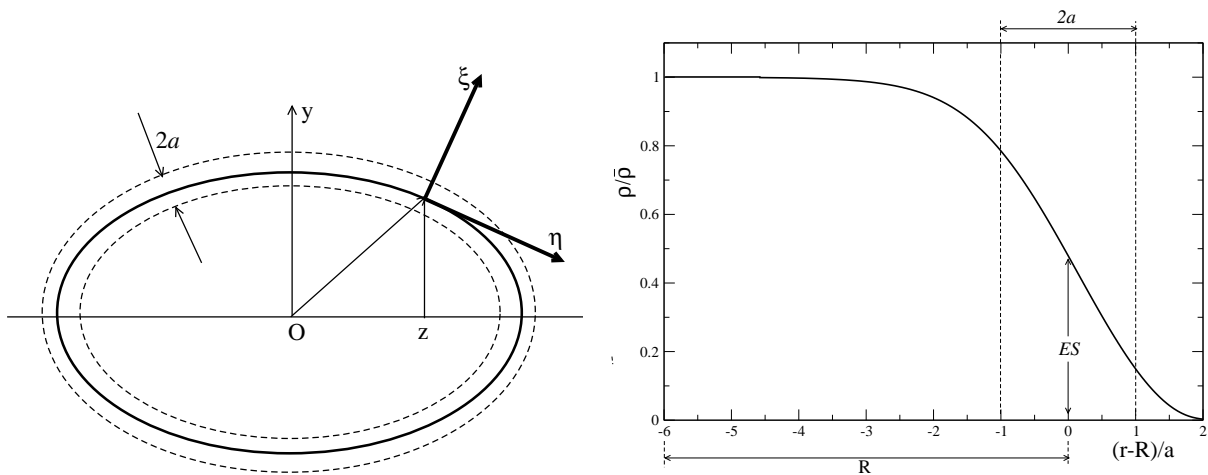

FIG. 1. Left: A qualitative plot for the deformed ES with the local coordinate system ξ, η , where ξ is the axis perpendicular, and η is that parallel to the ES. We show also a full diffuse surface thickness $2a$. Right: The particle number density ρ (using units of the saturation value of the density $\bar{\rho}$) in the perpendicular-to-ES direction as function of the radial coordinate r , and ES itself as an inflection point, also a surface thickness $2a$ and curvature radius R are shown.

density ρ (see, e.g., Refs. [2, 4]).

Within the leptodermic approximation, $a/R \ll 1$, simple and accurate solutions of many nuclear and liquid-drop problems involving the particle number density distributions were obtained by using the ES approximation (ESA) for nuclei [25–32]. The ESA exploits the property of saturation of the nuclear particle density ρ inside of the system, which is a characteristic feature of dense systems such as molecular systems¹, liquid drops, nuclei, and presumably, NSs. The realistic energy-density

¹ For the one-dimensional and more complicate dense molecular systems, van der Waals suggested the phe-

distribution is minimal at a certain saturation density of particles (nucleons or neutrons) corresponding approximately to the infinite matter [34]. As a result, relatively narrow edge region exists in finite nuclei or NS (crust) in which the density drops sharply from its almost central value to zero. We assume here that the part inside of the system far from the ES

nomenological capillary theory [33] which predicted the results for the particle number density ρ and surface tension coefficients σ . These results are similar to those obtained later in Refs. [25, 26]; see also comments below.

can be changed a little (saturation property of the dense system as hydrostatic liquid drop, nucleus or NS in the final evolution state).

The coordinate system related to the surface is defined in such a way that one of the spatial coordinates (ξ) is the distance from the given point to the ES; see Fig. 1, and Appendix A. This non-linear coordinate system is conveniently used in the region of nuclear and NS edge. They allow for an easy extraction of relatively large terms in the density distribution equations for the variation equilibrium condition. This condition means that the variation of the total energy E over the density ρ is zero under the constraints which fix some integrals of motion beyond the energy E by the Lagrange method. The Lagrange multipliers are determined by these constraints within the local energy-density theory, in particular, the extended Thomas-Fermi (ETF) approach from nuclear physics [35, 36]. Neglecting the other smaller-order perpendicular- and all parallel-to-ES contributions, the sum of such terms leads to a simple one-dimensional equation (in special local coordinates with the coordinate normal-to-surface ξ); see Fig. 1.

Such an equation mainly determines approximately the density distribution across the diffused surface layer of the relatively small order of the ratio of the diffuseness parameter a to the (mean curvature) ES radius R , $a/R \ll 1$ for sufficiently heavy systems. A small parameter, a/R , of the expansion within the ESA can be used for analytically solving the variational

problem for the minimum of the energy density functional per volume with constraints for a fixed particle number, and other integrals of motion, such as angular momentum, quadrupole deformation, etc. When this edge distribution of the density is known, the leading static and dynamic density distributions which correspond to diffused surface conditions can be easily constructed. To do so, one has to determine the dynamics of the effective surface which is coupled to the volume dynamics of the density by certain liquid-drop model (LDM) boundary conditions [28, 37, 38]. This ESA approach is based on the catastrophe theory for solving differential equations with a small parameter of the order of a/R as the coefficient in front of the high order derivatives in normal to the ES direction [39, 40]. A relatively large change of the density ρ on a small distance a with respect to the curvature radius R takes place for the liquid-matter drop (nuclei, water drops, neutron stars). Inside of such dense systems, the density ρ is changed a little around constant saturation density $\bar{\rho}$. Therefore, one obtains essential effects of the surface capillary pressure. Another important idea of Tolman is that we should consider as simpler as possible a neutron star as such a liquid drop at the static equilibrium under the stability condition, i.e., having a minimum of the energy density.

The accuracy of the ESA was checked in Ref. [29] for the case of nuclear physics by comparing the results with the existing nuclear theories like Hartree-Fock (HF) [41] and ETF

[35, 36], based on the Skyrme forces [7, 36, 41–48], but for the simplest case without spin-orbit and asymmetry terms of the energy density functional. The direct variational principle for finding numerically the parameters of the tested particle density functions in simple forms of the Woods-Saxon-like in Ref. [49] or their powers (Ref. [50]) were applied by using the realistic Skyrme energy functional [7, 47]. The main focus in Ref. [50] aimed to the surface corrections to the nuclear symmetry energy of spherical nuclei, see also recently published variational ETF approach [51, 52]. The extension of the ES approach to the nuclear isotopic symmetry and spin-orbit interaction has been done in Refs. [30–32]. The Swiatecki derivative terms of the symmetry energy for heavy nuclei [53–60] were taken into account within the ESA in Ref. [32]. The discussions of the progress in nuclear physics and astrophysics within the relativistic local density approach, can be found in reviews Refs. [13, 61]; see also Refs. [62–64].

In the present work, we extend the ES approximation of Refs. [29–32], to the spherical and deformed neutron stars. In Sect. II, we present the basic local energy-density formalism taking into account particle density gradients which are responsible for surface terms in finite macroscopic dense systems. The particle number density solutions inside of the nucleus are obtained analytically within the ESA expansion in small leptodermic parameter a/R at leading order in Sect. III. The leading density distributions for the density ρ at the lowest order in rel-

atively small diffuse surface-layer size, $a/R \ll 1$, are obtained analytically in Sect. IV. The surface energy in terms of the tension coefficients of van der Waals (vdW) macroscopic capillary theory [28, 37–39] is obtained analytically through Skyrme forces parameters in Sect. V. The surface correction to the NS mass was derived in Sect. VI. Equation of state, $P = P(\rho)$, for the system surface corrections, is derived through the ES at the same leading order in Sect. VII. The TOV approach is discussed in Sections VIII and IX. Our results are summarized in Sect. X. Some details of the mathematical textbook relations will be shown in Appendix A.

II. LOCAL ENERGY DENSITY FUNCTIONAL AND CONSTRAINTS

The total energy E for static problems can be written as

$$E = \int d\mathbf{r} \mathcal{E}[\rho(\mathbf{r})], \quad (1)$$

where $\mathcal{E}(\rho)$ is the energy density [29, 32],

$$\mathcal{E}(\rho) = \mathcal{A}(\rho) + \mathcal{B}(\rho) (\nabla\rho)^2. \quad (2)$$

Here, $\mathcal{A}(\rho)$ and $\mathcal{B}(\rho)$ are functions of the density ρ which are independent of its gradient. A non-gradient part $\mathcal{A}(\rho)$ of the energy density \mathcal{E} can be written as

$$\mathcal{A} = -b_V\rho + \varepsilon(\rho) + \frac{G}{4}\rho\Phi(\rho), \quad (3)$$

where b_V is the energy of separation of particle from the matter. We now use the condition for

a minimum of the energy per particle, \mathcal{W} , at a stable equilibrium,

$$\left(\frac{d\mathcal{W}}{d\rho}\right)_{\rho=\bar{\rho}} = 0, \quad \mathcal{W} = \frac{\mathcal{E}}{\rho}. \quad (4)$$

Near the saturation value, $\rho \rightarrow \bar{\rho}$, one has $\mathcal{W} = \mathcal{A}/\rho$. Therefore, there is no linear terms in expansion of \mathcal{A} , Eq. (3), over powers of the difference $\rho - \bar{\rho}$ near the saturation value. For instance, for $\varepsilon(\rho)$, one can write, generally speaking, for the considered dense system,

$$\varepsilon(\rho) = \frac{K}{18\bar{\rho}^2} \rho(\rho - \bar{\rho})^2, \quad (5)$$

where K is the part of the incompressibility modulus, e.g., due to the Skyrme nuclear interaction (for nuclear matter $K \sim 200$ MeV). In Eq. (3), $\Phi(\rho)$ is the main statistically averaged part of the gravitation potential.

As well known [2, 4], the Einstein equations of the General Relativity Theory (GRT) in the non-relativistic limit can be transformed to the continuity (Newtonian) equation for the gravitation potential Φ ,

$$\Delta_{\mathbf{r}}\Phi = 4\pi G\rho, \quad (6)$$

where $\Delta_{\mathbf{r}}$ is Laplacian over spatial coordinates \mathbf{r} (see Appendix A for ESA coordinates), and G is the gravitation constant, $G > 0$. It can be used for derivation of the gravitation potential Φ . We will use a more general but a simple statistical (macroscopic) approximation for the potential Φ in the form of expansion near the saturation density $\bar{\rho}$. Up to second order, one can take into account the statistically averaged

gravitation contribution to the incompressibility modulus K ,

$$\Phi = \Phi_0 + \Phi_1(\rho - \bar{\rho}) + (1/2)\Phi_2(\rho - \bar{\rho})^2, \quad (7)$$

where $\Phi_0 = \Phi(\bar{\rho})$, $\Phi_n = \partial^n \Phi(\bar{\rho}) / \partial \rho^n$ ($n=1,2$) are the derivatives of the gravitation potential $\Phi(\rho)$ at the saturation density $\bar{\rho}$. According to Eq. (3) for the nongradient part \mathcal{A} of the energy density \mathcal{E} , and the saturation condition (4), one finds for the constant Φ_1 of the expansion (7) of the gravitation potential $\Phi(\rho)$:

$$\Phi_1 = 0. \quad (8)$$

With this equation and the expansion (7), for $\mathcal{A}(\rho)$, Eq. (3), one obtains

$$\mathcal{A} = -\left(b_V - \frac{G}{4}\Phi_0\right)\rho + \varepsilon_G(\rho), \quad (9)$$

where $\varepsilon_G(\rho)$ is the energy density component $\varepsilon(\rho)$ modified by the gravitation field,

$$\begin{aligned} \varepsilon_G(\rho) &= \varepsilon(\rho) + \frac{G}{8}\Phi_2(\rho - \bar{\rho})^2 \\ &= \frac{K_G}{18\bar{\rho}^2} \rho(\rho - \bar{\rho})^2. \end{aligned} \quad (10)$$

Here, K_G is the total incompressibility modulus modified by the gravitation field ($K_G > 0$),

$$K_G = K + \frac{9}{4}G\bar{\rho}^2\Phi_2. \quad (11)$$

The coefficient $\mathcal{B}(\rho)$ in front of the gradient squared term in Eq. (2) is given by

$$\mathcal{B}(\rho) = \mathcal{C} + \mathcal{D}\rho + \frac{\Gamma}{\rho}. \quad (12)$$

These terms are associated with the nuclear Skyrme interaction. The first term is related to the interaction term which is a main reason of

the diffuse surface thickness for a non-rotating NS. The second term is from the spin-orbit term which is important, for instance, for the NS pulsars. The last term is a gradient correction to the kinetic energy (\hbar^2 correction of the nuclear kinetic energy in the ETF approach) [35, 36].

We should add the constraint for the variational procedure to get equations for the static equilibrium. For nonrotated one-component NS system we have to fix the particle number N ,

$$N = \int d\mathbf{r} \rho(\mathbf{r}) . \quad (13)$$

Therefore, introducing the chemical potential μ as the Lagrange multiplier, one obtains from Eqs. (1) and (2) the equation for the equilibrium,

$$\frac{\delta \mathcal{E}}{\delta \rho} \equiv \frac{\partial \mathcal{A}}{\partial \rho} - \frac{\partial \mathcal{B}}{\partial \rho} (\nabla \rho)^2 - 2\mathcal{B} \Delta \rho = \mu , \quad (14)$$

where $\mathcal{A}(\rho)$ and $\mathcal{B}(\rho)$ are given by Eqs. (9) and (12), respectively. Equation (13) determines the chemical potential μ in terms of the particle number N . For nuclear liquid drop, one has two equations related to the two constraints for the fixed neutron and proton numbers (Refs. [30–32]). They determine two (neutron and proton) chemical potentials. The Coulomb interaction can be taken into account for a proton part of the nucleus through the Coulomb potential; see Refs. [27, 30]. Concerning the neutron system of NS, the terms like $\propto \Delta \rho$ with constant of the proportionality are omitted because they do not affect the equilibrium density because of their disappearance from the variational equations for the total energy owing

to the well-known Ostragradsky-Gauss theorem. High-order derivative terms in the energy per particle \mathcal{E}/ρ (see Eq. (2) for \mathcal{E}), are neglected for simplicity in analogy of the GRT [2]. Equation (2) for \mathcal{E} overlaps most of the Skyrme forces [7, 47]. As function of a local particle density ρ , the $\mathcal{E}(\rho)$ corresponds to a saturation condition, Eq. (4). The most remarkable in this form is that the energy density $\mathcal{E}(\rho)$, Eq. (2), is a sum of the first three terms related to the incompressible constant, $-b_V$, and compressible energy part, $\propto (\rho - \bar{\rho})^2$, and gravitation terms, $\propto \Phi(\rho)$, Eqs. (7) and (8). In nuclear physics, one has, instead of the gravitation term, the Coulomb potential and symmetry energy terms, and similar surface-gradient terms. Within the nuclear ETF approach, the terms being proportional to Γ of the gradient part in (2) is from the \hbar^2 correction to the TF kinetic energy density [35], $\Gamma = \hbar^2/18m$, where m is the nucleon mass. In the gradient squared part, Eq. (12), the \mathcal{C} constant term is typical for the potential component of the Skyrme energy density functional and \mathcal{D} is the constant of the spin-orbit term [36] in the ETF model of nuclear physics. For a nucleus, the spin-orbit coefficient \mathcal{D} is given by

$$\mathcal{D} = -\frac{9m}{16\hbar^2} W_0^2, \quad (15)$$

where $W_0 = 100 - 130 \text{ MeV fm}^5$ is the nuclear spin-orbit constant; see Refs. [7, 36, 47]. The Coulomb part of the nuclear energy density (2) is considered similarly as suggested in Refs. [26, 27]. The meaning of all terms in the energy density (2) will be specified below.

For the spherical and deformed system of N particles, we may find the equilibrium particle density ρ from the variation problem for the energy functional (1) with respect to the variations of the density $\delta\rho$, which obey the constraints in the form:

$$N = \int d\mathbf{r} \rho(\mathbf{r}), \quad Q = \int d\mathbf{r} \rho(\mathbf{r}) q(\mathbf{r}). \quad (16)$$

The last constraint fixes a certain deformation parameter. The function $q(\mathbf{r})$, for instance, can be a multipole moment, or it can be chosen in such a way that Q determines the distance between the centers of masses of the two halves of the stretched nucleus for fission problems [65]. Thus, for the energy functional (1) and (2), and the constraints (16), one finds the same Lagrange variational equation (14) but μ would be equal to the sum of the chemical potential and $q\mu_Q$. $\mu \Rightarrow \mu + q\mu_Q$, Lagrange multipliers μ , and μ_Q correspond to the two constraints (16), μ is the chemical potential. Formally, we may consider the same equation (14) for spherical and deformed systems taking into account q in μ .

III. SOLUTIONS TO THE VARIATIONAL EQUATION IN THE SYSTEM VOLUME

In the system volume, the terms of Eq. (14) containing derivatives of ρ are small. These derivatives in a normal direction become large near the nuclear edge. For a rather wide class of deformed shapes of the dense finite system, as well as for the axially-symmetric, in particular,

spherical one, we may assume that the thickness a of a system edge is small as compared with its mean curvature radius R , considering a/R as a small parameter. In this respect, we define the effective surface (ES) as the points of maximum of the gradient of a particle density $\nabla\rho$, as shown in Fig. 1 by the arrow in the right panel. Locally near a point of the ES, one may introduce the local coordinate system ξ, η , where ξ is normal to the ES, and η presents two other orthogonal coordinates as shown in Fig. 1; see also Appendix A. In particular, for the spherical coordinates, η can be two spherical angle coordinates. See Appendix A, also for simple geometric relations for the non-linear ξ, η coordinates. It naturally appears the mean curvature H in terms of a small leptodermic parameter of the ES approximation, aH ; see Eq. (A6). For heavy enough nuclei near the spherical shape with the effective radius $R = r_0 A^{1/3}$, one has $aH = a/R \sim A^{-1/3} \ll 1$ because $a/r_0 \sim 1$ for realistic nuclear parameters, $r_0 = (4\pi\bar{\rho}/3)^{-1/3} \approx 1.14$ fm at the density of infinite nuclear matter, $\bar{\rho} = 0.16$ fm $^{-3}$, and the typical diffuseness parameter $a \approx 0.8$ fm, see below more precise definition for the diffuseness parameter through the decrement of decreasing of the exponential asymptotics of particle density. For NSs, it is well known that the typical surface diffuseness (the NS crust) $a \approx 1$ km, and the mean effective radius $R \approx 10 - 20$ km; see, e.g., Ref. [15]. Therefore, the ratio a/R can be also considered as a small parameter, and the leptodermic approximation, $a/R \ll 1$, can be used too.

The largest terms in Eq. (14) within the region of a sharp density descent are the second-order derivative of particle density ρ in the ξ direction, normal to the ES, $d^2\rho/d\xi^2$, and its derivative square, $(d\rho/d\xi)^2$, both of the relative order of $(R/a)^2$; see the expression for the Laplacian and gradient in ξ, η coordinates in Appendix A. The ES approach is based on expansion in the same small parameter aH (for a nucleus, $aH = a/R \sim 1/k_F R \sim A^{-1/3}$). This leptodermic approach is used in the liquid-drop and the extended Thomas-Fermi approach. Following Refs. [26, 28–32], we shall call this statistical² semiclassical ETF approach the ES approximation. We have to evaluate also the derivatives of the particle density and gravitation terms in the energy density $\mathcal{E}(\rho)$, Eq. (2), and Lagrange equation (14). For simplicity, the gravitation terms [see Eqs. (7) and (14)] are assumed to be of the same order as other non-gradient terms. This is in contrast to the Coulomb terms of the nuclear liquid drop, where the Coulomb corrections to a constant are assumed to be small as a/R . These corrections are of the relative order $\sim (e^2/\hbar c)(\hbar c/b_V r_0)(Z^2/A^{4/3})/2 \lesssim 0.2$ [27].

As function $\mathcal{E}(\rho)$ obeys the saturation property (4), in the system volume at $\xi \lesssim \xi_{vol}$ ($\xi < 0$ and $|\xi| \gg a$), where $\rho - \bar{\rho}$ is small asymptoti-

² The ETF is the statistical semiclassical approach because for convergence of the expansion in \hbar of the partition function we have first to average statistically it removing strong (e.g., shell) oscillations, and thus, get a smooth behavior of the partition function [49].

cally far from the ES, one can expand the non-gradient function \mathcal{A} of the energy density $\mathcal{E}(\rho)$, Eq. (2) up to second order including the compression term of the second order in powers of $\rho - \bar{\rho}$, $\mathcal{A} = \mathcal{A}_V$; see Eqs. (9), (10), and (5),

$$\mathcal{E}(\rho) \rightarrow \mathcal{A}_V = - \left(b_V - \frac{G}{4} \Phi_0 \right) \bar{\rho} + \frac{K_G}{18\bar{\rho}^2} \rho(\rho - \bar{\rho})^2. \quad (17)$$

The second order terms of expansion of the gravitation potential are included in the second term through a constant K_G [see Eq. (11)].

Introducing the dimensionless quantities for convenience to exclude the transformation of units,

$$y = \frac{\rho}{\bar{\rho}}, \quad x = \frac{\xi}{R}, \quad (18)$$

one can present Eq. (17) with the help of Eqs. (9), and (10) in the following way:

$$\varepsilon_G(\rho) \equiv \mathcal{A}_V(\rho) + \left(b_V - \frac{G}{4} \Phi_0 \right) \rho = \frac{K_G \bar{\rho}}{18} \epsilon(y), \quad (19)$$

where

$$\epsilon(y) = y(1 - y)^2. \quad (20)$$

The discarded terms are of the order of $(\rho - \bar{\rho})^3 \sim (a/R)^3$. Neglecting gradient terms in Eq. (14) in the system volume and using the approximation (7) and Eq. (8) for the gravitation potential Φ , for simplicity, up to quadratic terms over $\rho - \bar{\rho}$, one can reduce equation (14) as

$$\frac{\partial \varepsilon_G}{\partial \rho} \equiv \frac{K_G}{9} (\rho - \bar{\rho}) = \mu_1, \quad (21)$$

where μ_1 is an integration constant. Solving this equation with respect to the particle number

density ρ , one obtains

$$\rho = \bar{\rho} \left(1 + \frac{9\mu_1}{K_G} \right), \quad (22)$$

$$\mu_1 = \mu + b_V - \frac{G}{4}\Phi_0. \quad (23)$$

Therefore, μ_1 is the surface (capillary) correction to the leading component of the chemical potential μ [introduced above as the Lagrange multiplier, determined through the constraint (13)]. As seen from Eq. (22), one finds the relatively small surface correction, $9\mu_1/K_G \sim a/R$, to the saturation constant value $\bar{\rho}$; see Refs. [26–28, 30–32]. Therefore, μ_1 is also the capillary pressure correction, see also Ref. [39].

Notice that for the NS case we can not use the Fermi-liquid Landau statement of equivalence of the quasiparticle and particle densities, $\rho = k_F^3/(3\pi^2) = 3N/(4\pi R^3)$, where $R = r_0 N^{1/3}$ with $k_F r_0 \sim 1$ and have not, of course, $r_0 = 1.14$ fm of the nuclear physics.³ We should use experimental data for the mass M and many theoretical evaluations of the effective radius R for neutron stars to calculate the surface correction to the mass, Refs. [15, 24]. For other constants we need a relatively small thickness of the NS skin (crust) a .

The gravitation potential in this simplest ES approximation influences the particle density through the incompressibility K_G , Eq. (11). In these derivations, we used that the Lagrange

multiplier correction, μ_1 , is related to the chemical potential μ through Eq. (23). So, according to our definitions, this correction μ_1 , Eq. (23), is of the order of the small parameter $aH = a/R$.

IV. LEADING ORDER: DENSITY DISTRIBUTION THROUGH THE ES

In this section, we will analytically solve equation (14) for the distributions of the particle density ρ through the ES at leading order in small parameter a/R . Eq. (14) is a typical differential equation in the catastrophe theory. In such differential equations, a small coefficient (of the order of a/R in our case) appears in front of the highest order derivative. These terms become important because of the product of this small coefficient (of the order of a/R) and large (of the order of R/a and high) can be of zero order in this (a/R) parameter. At the leading order, we need to keep only leading terms in small parameter a/R in the Lagrange equation (14). These are the second order derivatives ρ'' , and first-order derivative squares $(\rho')^2$, over their ξ variable, according to Eqs. (A7) and (A4). $\rho' = \partial\rho/\partial\xi$. We may develop some iteration procedure to find the solutions with improved precision in a/R in terms of the solutions of the leading order.

Multiplying Eq. (14) by the derivative $\partial\rho/\partial\xi$, from Eqs. (14), (9), and (12) at leading order,

³ For nuclei, using $R = r_0 N^{1/3}$, where r_0 is the constant which determines a distance on which nucleons interact by a local nuclear interaction, one has $\bar{\rho}$ in the zero order approximation, $\bar{\rho} = 3/4\pi r_0^3$.

one obtains

$$\frac{d}{d\xi} \left[\left(\mathcal{C} + \mathcal{D}\rho + \frac{\Gamma}{4\rho} \right) \left(\frac{d\rho}{d\xi} \right)^2 - \varepsilon_G(\rho) \right] = 0, \quad (24)$$

where

$$\varepsilon_G(\rho) = \frac{\bar{\rho} K_G}{18} \epsilon(y), \quad (25)$$

and $\epsilon(y)$ is a given function of y , determined by Skyrme interaction. In particular, one can use a simple quadratic approximation (20). In equation (24), the term with the coefficient \mathcal{C} in parentheses in front of the derivative squared of the density ρ is the main term, e.g., as that related to the Skyrme interaction with respect to the spin-orbit term $\mathcal{D}\rho$ and, moreover, the gradient correction $\Gamma/(4\rho)$ to the kinetic energy of the system for nuclear physics. Let us first assume the same for the NS liquid drop. Therefore, a should be determined through the constant \mathcal{C} . Otherwise, we have to include the average of a whole coefficient in front of the derivative square term in Eq. (24).

With employing the boundary conditions $\rho \rightarrow 0$ and $\partial\rho/\partial\xi \rightarrow 0$ for $\xi \rightarrow \infty$, one can easily integrate equation (24). Finally, we come to a simple ordinary 1st order differential equation for ρ , depending only on the normal-to-ES coordinate ξ , at leading order in small parameter a/R , that is

$$\frac{d\rho}{d\xi} = -\sqrt{\frac{\varepsilon_G(\rho)}{\mathcal{C} + \mathcal{D}\rho + \Gamma/4\rho}}. \quad (26)$$

Introducing several dimensionless quantities,

$$y = \frac{\rho}{\bar{\rho}}, \quad x = \frac{\xi}{a}, \quad \epsilon = \frac{18\varepsilon_G}{K_G \bar{\rho}}, \quad (27)$$

and using

$$a = \sqrt{\frac{18\mathcal{C}\bar{\rho}}{K_G}}, \quad (28)$$

one can present Eq. (26) in the following dimensionless form:

$$\frac{dy}{dx} = -\sqrt{\frac{y\epsilon(y)}{y + \beta y^2 + \gamma}}, \quad (29)$$

where

$$\beta = \frac{\mathcal{D}\bar{\rho}}{\mathcal{C}}, \quad \gamma = \frac{\Gamma}{4\bar{\rho}\mathcal{C}}. \quad (30)$$

From the asymptotes of the explicit analytical expressions for the particle density $y(x)$ at large x , one may see a typical behavior, $y(x) \propto e^{-x}$, where $x = \xi/a$, that is a reason to call a , Eq. (28), as the diffuseness parameter. We shall also check that a has exactly the same meaning as introduced above in terms of the small parameter a/R . As noted above, in the derivation of Eq. (29) within leading order of the ES expansion, we reduced the second order differential equation (14) to the first order one by integration using the standard boundary conditions $y \rightarrow 0$ and $\partial y/\partial\xi \rightarrow 0$ and $y\epsilon(y) \rightarrow 0$ for the definition of the $\epsilon(y)$ asymptotes. Thus, all parameters of the energy density in Eq. (2) are reduced within this leading order ES approximation to the only two dimensionless constants; see Eq. (30). For nuclear physics,

$$\beta = -\frac{27W_0^2}{128\pi k_F r_0^6 \varepsilon_F \mathcal{A}}, \quad \gamma = \frac{\pi\varepsilon_F r_0^5}{27\mathcal{A} (k_F r_0)^2}, \quad (31)$$

where $\varepsilon_F = \hbar^2 k_F^2 / 2m \approx 37$ MeV is the Fermi energy for the Fermi momentum, $k_F = (3\pi^2 \bar{\rho}/2)^{1/3}$ (in units of \hbar). We are coming to the realistic nuclear data for the infinite-matter particle density, $\bar{\rho} = 0.16$ fm⁻³.

Single boundary condition which we need for the unique solution of the first order differential equation can be easily found within the leading ES approximation from the definition of the ES as the points of maximal values of the derivative, $\partial\rho/\partial\xi$ at $\xi = 0$, namely, $y''(0) = 0$ at $x = 0$. Differentiating equation (29) over x , one obtains the algebraic equation for the position of the ES, $y = y_0$ at $x = 0$,

$$(\gamma - \beta y^2)\epsilon(y_0) + y_0(y_0 + \beta y_0^2 + \gamma)\frac{d\epsilon(y_0)}{dy} = 0, \quad (32)$$

defined by function $\epsilon(y)$; see, e.g., Eq. (20). This function is given by the specific choice of the nucleon interaction which leads to the energy density (2), for example, known function for the Skyrme interaction.

For any function $\epsilon(y)$, Eq. (29) can be integrated, especially easy for the quadratic expression (20). The integration constant is determined by the boundary condition (32). The leading-order solution of Eq. (29) can be found explicitly in the inverse form:

$$x = - \int_{y_0}^y dw \sqrt{\frac{w + \beta w^2 + \gamma}{w\epsilon(w)}}. \quad (33)$$

For the expression (20), this integral can be calculated analytically in terms of the elementary functions for any parameters β and γ within the condition $a/R \ll 1$. Note that the solution (33) to equation (29) is considered at leading order in a small parameter a/R . This solution satisfies asymptotically the condition of its matching with the volume result, Eq. (22), of the same order at the point x corresponding $\xi \approx \xi_{vol}$ defined in Section III, $y \rightarrow 1$ exponentially for $x \rightarrow -\infty$.

Let us consider the examples of simple solutions $x = x(y)$, Eq. (33), of Eq. (29) with the boundary condition, Eq. (32), for the quadratic expression $\epsilon(y) = y(1 - y)^2$.

(i) For $\gamma = 0$ and $\beta = 0$, neglecting the gradient correction to the kinetic energy density [$\Gamma = 0$ in Eq.(12)], and spin-orbit [$\mathcal{D} = 0$ in Eq.(12)] terms, one finally obtains [29, 30]

$$y(x) = \tanh^2[(x - x_0)/2], \\ x < x_0 = 2\text{arctanh}(1/\sqrt{3}). \quad (34)$$

This solution is related to the gradient squared term due to the main Skyrme-interaction (or van der Waals molecular interaction) term [$\mathcal{C} \neq 0$ in Eq.(12)]. It is very asymmetric with respect to the ES value, $y_0 = y(0) = 1/3$; see Fig. 2.

(ii) Keeping only $\Gamma \neq 0$ term in Eq. (26), but neglecting gradient terms of the Skyrme ($\mathcal{C} = 0$) and spin-orbit ($\mathcal{D} = 0$) interaction, one obtains⁴ the Wilets solution [25], derived early for the semi-infinite system,

$$y(x) = \frac{1}{1 + e^x}. \quad (35)$$

This solution is symmetric with respect to the ES because of $y(0) = 1/2$. This Fermi-gas form of the solutions is used for the variational problems within the ETF model, in contrast to the dense liquid-drop solution (34), related to the Skyrme interaction; see Fig. 2.

⁴ Dimensionless equation in this case is $dy/dx = (y\epsilon(y))^{1/2}$ for $a = \Gamma[9/(8K_G)]^{1/2}$. Equation for the ES, $x = 0$, $\epsilon(y_0) + y_0 d\epsilon(y_0)/dy = 0$, has the solution $y_0 = 1/2$. Integrating analytically the equation for $y(x)$ in this case, one obtains the expression (35).

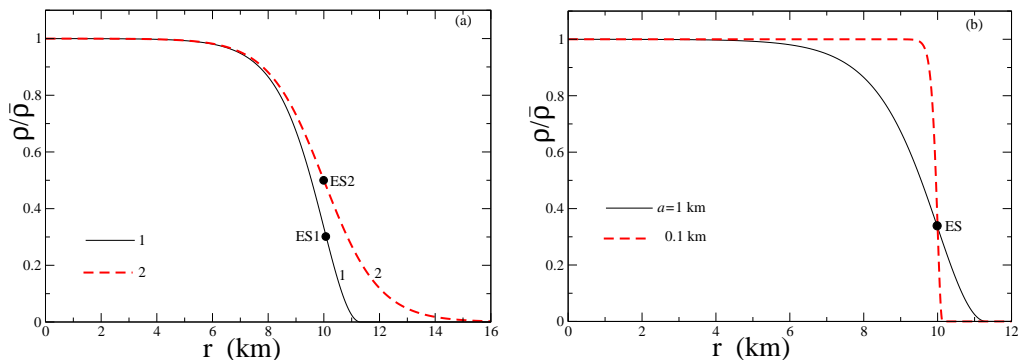

FIG. 2. Particle number density, ρ , in units of the saturation value, $\bar{\rho}$, as function of the radial variable r (in km) for the spherical neutron star in a simple compressed liquid-drop model at the stable equilibrium. (a): Solid line is related to the asymmetric solution, Eq. (34), for $\beta = \gamma = 0$ (line “1”), which is the leading approximation over a small leptodermic parameter, $a/R \ll 1$. The dashed line presents the same but for the Wilets symmetric solution, Eq. (35) (line “2”). Parameters, for example: the effective radius $R = 10$ km, diffuseness of the NS crust $a = 1$ km, and temperature $T = 0$. The dots ES1 and ES2 show the ES at the effective radius R for the solid, Eq. (34), and dashed, Eq. (35), lines, respectively. (b): The same as in Fig. 2 but for comparison of the solution Eq. (34) for $\beta = \gamma = 0$ (asymmetric solution, solid line), at the leading approximation over a small leptodermic parameter, $a = 1$ km with the same but for $a = 0.1$ km (dashed line).

Figure 2(a) shows the particle density, $\rho(r) =$ zero constants \mathcal{C} and \mathcal{D} in Eq. (12) for \mathcal{B} (only $\bar{\rho}y((r - R)/a)$, as function of the radial coordinate r for typical parameters, the thickness of the NS diffused layer (crust) $a = 1$ km, and the effective radius $R = 10$ km, in units of the saturation value $\bar{\rho}$. We compare the two dimensionless solutions for the main asymmetric particle density $\rho(r)/\bar{\rho}$. One of them (solid line) is related to the corresponding Skyrme (van der Waals) interaction “1”; see Eq. (34) for the universal dimensionless particle density of a dense liquid-drop, $y = \rho/\bar{\rho}$, as function of $x = (r - R)/a$. Another limit case corresponds to the symmetric Wilets solution based on Eq. (35) for

the gradient correction to the kinetic energy is taken into account, i.e. for a gas system). This solution “2” is often used for the variational version of this problem. These two curves are very different in the surface layer, especially outside of the system far away from the NS, and almost the same inside of the NS.

Figure 2(b) shows the radial dependence of the particle density $\rho(r)$ (in the same saturation value $\bar{\rho}$ units) for the case (i), Eq. (34) for $y = y(x)$ of the leading order, at $a = 1$ (solid line) and 0.1 km (dashed line). As seen from Fig. 2(b) and expected, the range of the expo-

nential decrease of $\rho(r)$ becomes much smaller. However, the surface effects on the local density $\rho(r)$ are still very important to get a continuous analytical behavior through the ES. Only after the integration over the normal-to-ES (radial in this example) variable $\xi = (r - R)/a$, the smallness factor, proportional to a/R , appears for this surface with respect to the volume contribution. Thus, for the NS total energy E , Eq. (36), and particle number N , Eq. (13) (important constraints for the calculation of the chemical potential μ), the surface correction is not (very) important, especially in the case of the diffuseness thickness $a = 0.1$ km (Sect. V). We may neglect such corrections. However, the influence of the NS surface becomes important for the local quantities as the particle density $\rho(r)$, Fig. 2, and therefore, pressure $P(r)$ through Eqs. (51) - (54), even if we neglect the small μ_1 correction [Eq. (23)] in the chemical potential μ (Sect. VII).

V. HIGH ORDER: THE SYSTEM ENERGY

First, let us derive the standard formula for the total energy E which is called the Weizsäcker mass formula in nuclear physics but with the analytical expression for its tension coefficient. According to the basic definitions, the total energy can be presented as

$$E = \int d\mathbf{r} \mathcal{E}[\rho(\mathbf{r})] \approx E_V + E_S, \quad (36)$$

where E_V is the volume part of the total energy,

$$E_V = - \left(b_V - \frac{G}{4} \Phi_0 \right) \int d\mathbf{r} = -b_V^G V, \quad (37)$$

where $b_V^G = b_V - G\Phi_0/4$. In Eq. (36), E_S is the surface part,

$$E_S \approx \sigma S, \quad (38)$$

where S is the surface area value, and σ is the tension coefficient. The leading expression for σ in our leptodermic expansion over small parameter a/R is given by⁵

$$\sigma = 2 \int_{-\infty}^{\infty} d\xi [\mathcal{C} + \mathcal{D}\rho + \Gamma/(4\rho)] \left(\frac{\partial\rho}{\partial\xi} \right)^2. \quad (39)$$

In these derivations, we present locally $d\mathbf{r}$ as integration of the system surface $Jd\eta$ with the Jacobian J (see Appendix A) and over the normal coordinate $d\xi$, $d\mathbf{r} = Jd\eta d\xi$. Then, we expand the integration limits of ξ to infinity $\pm\infty$ because $(\partial\rho/\partial\xi)^2$ has a sharp maximum at the ES, $\xi = 0$. Factor 2 appears because of Eq. (26) which leads to the approximate (at leading order in small parameter a/R) equivalence of the $[\varepsilon_G(\rho)]$ correction to the bulk $(b_V - G\Phi_0/4)\bar{\rho}$, and surface (gradient) parts of the total energy E . As we have square of density derivative over ξ in Eq. (39), one can use the equation (26) for the density ρ at the leading order. Equation (39) can be transformed to the expression with the dimensionless integral over y , that is a more convenient for calculations,

$$\sigma = \frac{a\bar{\rho}K_G}{9} \int_0^1 dy \sqrt{(y + \beta y^2 + \gamma)\epsilon(y)} \times \left(1 + \beta y + \frac{\gamma}{4y} \right) \left(\frac{dy}{dx} \right)^2. \quad (40)$$

⁵ Similar expressions as Eqs. (39) and (40) at $\mathcal{D} = \Gamma = 0$ was obtained early by van der Waals; see Ref. [33].

In these derivations we transform the variable ξ to ρ , $d\xi = (d\xi/d\rho)d\rho$, and use Eqs. (25), (26), and (28)-(30). For the approximation (20) to $\epsilon(y)$, the integral in Eq. (40) can be taken in terms of the elementary functions. The simplest analytical expression for the tension coefficient σ is obtained for $\beta = \gamma = 0$ [case (i)]. Using Eq. (34) for $y = y(x)$, one finally arrives at

$$\sigma = \frac{4a\bar{\rho}K_G}{135}. \quad (41)$$

Similarly, the expression for σ in the case (ii) can be derived too, $\sigma = a\bar{\rho}K_G\sqrt{\gamma}/36$. Thus, one obtains the explicitly analytical expressions for the tension coefficient σ as functions of the constants of the energy density \mathcal{E} , Eq. (2), e.g., Skyrme interaction constants, in good agreement with the van der Waals capillary theory [33].

Equation (36) is the two main (volume and surface) terms of the usual leptodermic expression for the total energy of the dense liquid drop. In nuclear physics, this expression, was obtained with including additional terms of the symmetry energy [with volume (and Swiatecki linear term) and surface (isovector) corrections] and curvature and Coulomb components (see, for instance, Refs. [31, 32] for the ESA).

VI. NS MASS SURFACE CORRECTION

Let us derive the NS mass M within our macroscopic ESA model,

$$M = m \int \rho d\mathbf{r}, \quad (42)$$

where m is the particle (nucleon, nucleus, or molecule) mass. Adding and subtracting $\bar{\rho}$ in the integrand of Eq. (42), one can re-write Eq. (42) identically in the following way:

$$M = M_V + m \int (\rho - \bar{\rho}) d\mathbf{r} \equiv M_V + M_S. \quad (43)$$

Here, the volume part of the NS mass is given by

$$M_V = m\bar{\rho} \int_V d\mathbf{r} = m\bar{\rho} V, \quad V = \frac{4\pi}{3}R^3, \quad (44)$$

and M_S is its surface component,

$$M_S = m \int (\rho - \bar{\rho}) d\mathbf{r} \approx mS \int (\rho - \bar{\rho}) d\xi. \quad (45)$$

The integral over the volume, $d\mathbf{r}$, is taken effectively over a small diffuseness region of the order of a , and S is the effective surface area. For a spherically symmetric ES, one has $S = 4\pi R^2$. Similarly, using for calculation of the integral in Eq. (45) over relatively small diffused edge by Eq. (29) in the local coordinate system as in the previous section, we transform the integration variable ξ to ρ , $d\xi = (d\xi/d\rho)d\rho$. The result in terms of the dimensionless density y is given by

$$M_S = -m\bar{\rho}aS \int_0^1 \frac{(1-y)\sqrt{y+\beta y^2+\gamma}}{\sqrt{\epsilon(y)}} dy, \quad (46)$$

where $\epsilon(y)$ can be parameterized by using a Skyrme interaction model but with NS parameters. For the simplified expression (20) for $\epsilon(y)$, the integral can be taken in terms of the elementary functions, and one obtains the corresponding simple analytical result. For the Skyrme case (i), $\beta = \gamma = 0$, Eq. (34), one finds from Eq. (43) finally the simple result in the case (i):

$$M = M_V \left(1 - \frac{2a}{R}\right), \quad (47)$$

where M_V , Eq. (44), is the volume part of the total NS mass M [see Eq. (43)], i.e., the mass M at $a = 0$. This quantity should be parameterized in terms of the experimental data because the particles in volume cannot be considered statistically independent, in contrast to much smaller surface contributions as in the quasi-particle Landau Fermi-liquids theory. For completeness, one also can present the surface mass correction in the Wilets case (ii), $\mathcal{C} = \mathcal{D} = 0$, Eq. (35),

$$M = M_V \left(1 - \frac{6a\sqrt{\gamma}}{R} \right), \quad (48)$$

where γ is the dimensionless constant of the gradient correction to the kinetic energy density; see Eq. (30).

Using Solar units, from Eqs. (47) and (48) for the cases (i) and (ii), one respectively obtains

$$\frac{M}{M_\odot} \approx \mathcal{M}_{\text{NS}} \left(\frac{R}{R_0} \right)^3 \left(1 - \frac{2a}{R} \right), \quad (49)$$

$$\frac{M}{M_\odot} \approx \mathcal{M}_{\text{NS}} \left(\frac{R}{R_0} \right)^3 \left(1 - \frac{6a\sqrt{\gamma}}{R} \right), \quad (50)$$

where the number coefficient \mathcal{M}_{NS} is the typical value for ratio of the volume NS star mass, $M_V^{(0)} = 4\pi m \bar{\rho} R_0^3$ at exemplary value of the radius R_0 , e.g., $R_0 = 10$ km, to the Solar mass, M_\odot ($M_\odot \approx 1.99 \cdot 10^{30}$ kg). In these derivations we multiplied and divided the expression for M/M_\odot , Eq. (47), by the same $M_V^{(0)}$, and used $M_V^{(0)}/M_\odot \equiv \mathcal{M}_{\text{NS}} \approx 1.4 - 2.0$, and $M_V/M_V^{(0)} = (R/R_0)^3$. In any units, one finds that $M \propto R^3(1-2a/R)$ for the case (i), Eq. (49). The surface correction to the mass of a dense (liquid-drop) system with any single kind particles (nucleons, nuclei, or molecules) is relatively

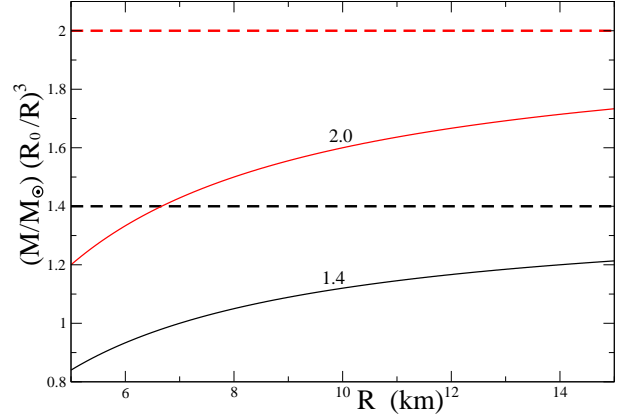

FIG. 3. The NS mass distributions $M(R)$, Eq. (49), multiplying by $(R_0/R)^3$ (to exclude the volume mass dependence $\propto R^3$) in Solar units M_\odot as function of the ES curvature radius R are shown (solid black and red lines) for typical parameters $a = 1$ km and $R_0 = 10$ km, and the NS masses, $\mathcal{M}_{\text{NS}} = 1.4$ and 2.0 , in units of M_\odot , respectively; see text. Dashed black and red lines are related to $a = 0$ are volume parts M_V . The difference between solid and dashed lines show the surface corrections.

small with respect to the total NS mass but sufficiently large in the absolute value. Assuming typically (very roughly) $a/R \sim 0.05 - 0.1$, the surface contribution to the mass M is of the order of 10-20%.

Figure 3 shows the mass distribution $M(R)$, Eq. (49), as function of the effective radius R for different ratios of the NS mass to the Solar mass by using only three physical parameters, the crust thickness a , exemplary ES radius R_0 , and ratio $M_V^{(0)}/M_\odot$, which are typical for the NS. As seen from Fig. 3, the surface effect is rather notable at $a = 1$ km (solid line)

with respect to the step-function density case, $a = 0$ km, (dashed lines). This effect is especially remarkable for smaller R , under the condition $a/R \ll 1$. Notice that we discuss here only the surface effect, and more realistic model calculations take into account the restrictions to the minimal and maximal mass values; see, e.g., Refs. [9, 10, 13, 15, 24].

VII. EQUATION OF STATE

The equation of state (EoS), $P = P(\rho)$, can be determined by using the energy density $\mathcal{E}(\rho)$, Eq. (2), [66]

$$P = \rho^2 \frac{\delta \mathcal{W}}{\delta \rho}, \quad (51)$$

where \mathcal{W} is the energy per particle which is a function of the particle number density ρ ; see Eqs. (4) for \mathcal{W} , and (2) for the energy density \mathcal{E} . According to the equation (14) for the equilibrium of the liquid-drop system, one obtains the pressure P in the form:

$$P = \mu\rho - \mathcal{E}(\rho) = \mu\rho - \mathcal{A}(\rho) - \mathcal{B}(\rho)(\nabla\rho)^2, \quad (52)$$

where μ is the chemical potential, and $\mathcal{E}(\rho)$ is the energy density, Eq. (2). The leading term of the pressure (52) can be presented as

$$P = \mu\rho - \mathcal{A}(\rho) - \mathcal{B}(\rho) \left(\frac{\partial\rho}{\partial\xi} \right)^2, \quad (53)$$

where $\partial\rho/\partial\xi$ is given by Eq. (26) in terms of the $\varepsilon_G(\rho)$, Eq. (25), $\mathcal{B}(\partial\rho/\partial\xi)^2 = \varepsilon_G(\rho)$. With Eq. (9), one finds

$$P = \mu_1\rho - \varepsilon_G(\rho) - \mathcal{B}(\rho) \left(\frac{\partial\rho}{\partial\xi} \right)^2, \quad (54)$$

where $\mu_1 = \mu + b_V - (G/4)\Phi_0$. For a leptodermic system, one can re-write this equation as

$$P = P_V + P_S, \quad (55)$$

where P_V is the volume part of the pressure P [see Eq. (17)]

$$P_V \equiv \mu\rho - \mathcal{A}(\rho) = \mu_1\rho - \varepsilon_G(\rho). \quad (56)$$

The second component, P_S , is the surface part,

$$P_S \equiv -\mathcal{B}(\rho) \left(\frac{\partial\rho}{\partial\xi} \right)^2 \approx -\varepsilon_G(\rho) \approx -\frac{\bar{\rho}K_G}{18}y(1-y)^2. \quad (57)$$

For the middle we used Eq. (26) for the particle number density ρ in the leading order approximation. Using Eqs. (25) and (20) for the quadratic approximation, one arrives at the last equation. Notice that the surface component, P_S , is concentrated near the effective surface, $r = R$, with the exponential decrease inside and outside of the mass system; see Fig. 4. According to Eqs. (56) and (57) for the quadratic approximation to $\varepsilon(y)/y$, Eq. (20), one has a macroscopic liquid-drop equilibrium condition at the ES, $(P_V + P_S)_{r=R} = 0$. Thus, the chemical potential μ_1 at the liquid-drop equilibrium equals $\mu_1\rho(R) = 2\varepsilon(\rho(R))$, i.e.,

$$\mu_1 = \frac{K_G}{9}(y_0 - 1)^2, \quad (58)$$

where y_0 is the value of the density $y(x)$ at the ES, $x = 0$, $y_0 = 1/3$ for the van der Waals (Skyrme model) case (i) and $y_0 = 1/2$ for the Wilets solution (ii). With Eq. (58), one finally obtains from Eqs. (55), (56), and (57),

$$P = \frac{K_G}{9} y [(y_0 - 1)^2 - (y - 1)^2] = P_V + P_S, \quad (59)$$

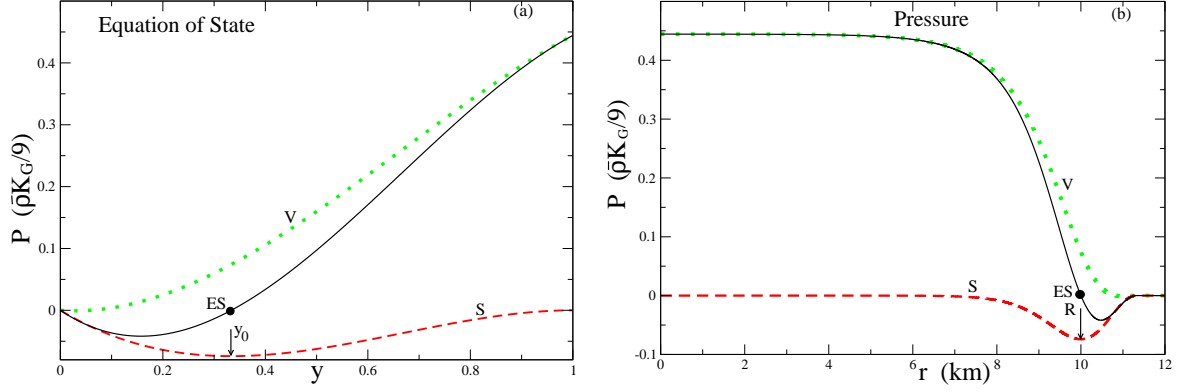

FIG. 4. Pressure P , Eq. (59), in units of $\bar{\rho}K_G/9$ through the NS diffuse surface as function of the density variable y (a) for the universal Equation of State, and the radial coordinate r (b) through the particle number density $\rho = \bar{\rho}y((r - R)/a)$, where $y(x)$ is given, e.g., by Eq. (34) (solid lines). Dashed (red) and dotted (green) lines show the surface (S) and volume (V) components. The crust thickness $a = 1.0$ km and the effective radius parameter $R = 10$ km are the same as in Fig. 2. The full dots and arrows present the ES for $y = y_0$ (a) and $r = R$ (b).

where

$$P_V = \frac{K_G}{9} y \left[(y_0 - 1)^2 - \frac{1}{2}(y - 1)^2 \right], \quad (60)$$

$$P_S = -\frac{K_G}{18} y(y - 1)^2. \quad (61)$$

Fig. 4 shows the pressure P as function of the dimensionless density y (a) and radial variable r (b) through the density, $y((r - R)/a)$, at leading order over the parameter a/R ; see Eq. (59) for the full pressure, Eq. (60) for the volume (P_V), and Eq. (61) for the surface (P_S) components of the pressure. As seen from Fig. 4 (a), all pressures, P , P_V and P_S , take zero value at $y = 0$. The surface pressure, P_S , takes zero value also asymptotically in the limit $y \rightarrow 1$, in contrast to the volume part, P_V (the total pressure P). The full circle shows the ES at $y = y_0 = 1/3$ for the (i) case. As expected, the volume pressure P_V is a monotonically increasing function of the

density y . In Fig. 4 (b), the pressure $P(\rho(r))$ (solid) has a typical leptodermic behavior with a relatively short thickness of the order of a , where the pressure decreases sharply from the almost constant, asymptotes inside of the system at $r \gtrsim R - a$, to zero. Again, the dashed red and dotted green lines show the surface (P_S) and volume (P_V) components, respectively. The sum of these components is the total pressure P with zero at the ES; see the full point (ES) and arrow which present the effective surface and radius R , respectively. As seen also from Fig. 4 (b), we obtain analytically a sharp minimum of the surface pressure, $P_S(r)$, near the effective surface ($r \approx R$) with its exponential decrease inside and outside of the ES to zero. As expected, in the Skyrme case (i), the pressure $P(r)$ is exponentially sharp decreasing function of r outside of

the system. Notice that, in contrast to this, the Wilts solution in the symmetric case (ii) for the particle density ρ , Eq. (35), leads to a large (also exponential) tail outside of the system as expected from Fig. 2 (a). For the parameters $R = 10$ km, and $a = 1$ km (see Figs. 4 and 3), one finds that the pressure $P(r)$ [Eq. (59)] disappears in the Skyrme case (i) at $r \gtrsim R + ax_0$ ($x_0 \approx 1.32$), that corresponds to about $r \gtrsim 11.3$ km, similarly as for the density $\rho(r)$, which is a very close distance from the ES. In accordance with Fig. 2 (b), this distance is decreased much for the pressure $P(r)$ in the case of the significantly small edge thickness $a = 0.1$ km to 10.7 km, which is somehow larger than for the particle number density.

VIII. TOLMAN-OPPENHEIMER-VOLKOFF APPROACH

The basic relations determining the mass-radius relation are the traditional TOV differential equations [1–3, 13]:

$$\begin{aligned} \frac{dP}{dr} &= -\frac{G(\mathcal{E}+P)(mc^2+4\pi r^3P)}{rc^2(rc^2-2Gm)}, \\ \frac{dm}{dr} &= \frac{4\pi r^2\mathcal{E}}{c^2}, \end{aligned} \quad (62)$$

where $m(r)$ is the gravitational mass interior to the radius r , \mathcal{E} is the energy density, e.g., Eq. (2). Boundary conditions for these equations are

$$m(r=0) = 0, \quad (dP/dr)_{r=0} = 0. \quad (63)$$

The integrations are terminated when $P = 0$, which defines the surface $r = R$. A specified

value of the central pressure $P_0 = P(r=0)$ determines the total mass $M = m(r=R)$. Note that the only EoS relation needed is the pressure density relation $P = P(\rho)$.

Taking approximately into account the step-function density, $\rho = \bar{\rho}$ for $r < R$ inside of the system, and $\rho = 0$ for $r > R$ outside of it, one can solve TOV equations (62) analytically. Our leading-order solution, Eq. (29), and examples, Eqs. (34) and (35), see Fig. 2. having a sharp transition from the saturation to zero value, largely agrees with above mentioned approximation at small leptodermic parameter $a/R \ll 1$, the better the smaller this parameter. Taking into account the first boundary condition in Eq. (63), the second equation in Eq. (62) can be integrated analytically,

$$m(r) = \frac{4\pi\mathcal{E}_0}{3c^2}r^3, \quad (64)$$

where

$$\mathcal{E}_0 = \mathcal{E}(\rho = \bar{\rho}), \quad (65)$$

which should be some constant, independent of r for the assumed coordinate dependence of the density $\rho(r)$ inside of the particle system. In particular, it can be taken approximately as shown in Eqs. (2), (9), and (25). Therefore, the total mass M in this approach is given by

$$M = m(R) = \frac{4\pi\mathcal{E}_0}{3c^2}R^3, \quad (66)$$

where R is the effective NS radius (r_1 in the notations of Tolman's book, Ref. [2]).

Substituting Eq. (64) into the first TOV Eq. (62), one can see that the variables P

and r are separated. Therefore, we analytically find the solution for $r \leq R \leq R_{\text{SM}}$ and $(P + \mathcal{E}_0/3)/(P + \mathcal{E}_0) > 0$:

$$P = \frac{\mathcal{E}_0}{3} \frac{3\zeta \sqrt{1 - r^2/R_{\text{SM}}^2} - 1}{1 - \zeta \sqrt{1 - r^2/R_{\text{SM}}^2}}, \quad (67)$$

where

$$\zeta = \left| \frac{P_0 + \mathcal{E}_0/3}{P_0 + \mathcal{E}_0} \right|, \quad (68)$$

and $P_0 \equiv P(\bar{\rho}) = P(r = 0)$. In Eq. (67), R_{SM} is the radius parameter of the Schwarzschild metric in the form:

$$ds^2 = -\frac{dr^2}{1 - r^2/R_{\text{SM}}^2} - r^2 d\theta^2 - r^2 \sin^2\theta d\phi^2 + \left[A_{\text{SM}} - B_{\text{SM}} \sqrt{1 - r^2/R_{\text{SM}}^2} \right]^2 dt^2, \quad (69)$$

where R_{SM} , A_{SM} , and B_{SM} are some constants; see Ref. [2]. Here and below we will use the subscript SM to relate the quantities to the Schwarzschild metric, Eq. (69). This metric is nonsingular at $r = 0$. It was derived from the original form, Refs. [2, 4], singular at $r = 0$, by using a transformation of coordinates; see, e.g., Ref. [2]. The radius R_{SM} is expressed in terms of \mathcal{E}_0 as

$$R_{\text{SM}} = \left(\frac{8\pi G \mathcal{E}_0}{3c^4} \right)^{-1/2}. \quad (70)$$

Notice that the solution (67) coincides, up to a constant related to units, with that presented in Tolman's book at $\zeta = B_{\text{SM}}/A_{\text{SM}} = 1/(2A_{\text{SM}})$ (see Ref. [2] and Eq. (70) for R_{SM}),

$$P = \frac{\mathcal{E}_0}{3} \frac{3B_{\text{SM}} \sqrt{1 - r^2/R_{\text{SM}}^2} - A_{\text{SM}}}{A_{\text{SM}} - B_{\text{SM}} \sqrt{1 - r^2/R_{\text{SM}}^2}}, \quad (71)$$

where

$$B_{\text{SM}} = 1/2, \quad A_{\text{SM}} = \frac{1}{2\zeta}. \quad (72)$$

We have to choose the sign plus on right of this equation for the positive expression of $(P +$

$\mathcal{E}_i/3)/(P + \mathcal{E}_i)$, because the minus, which is related to the opposite sign of the same expression, is not valid for the Schwarzschild metric, $A_{\text{SM}} > 0$. The cosmological constant is assumed to be zero, $\mathcal{E}_0 \propto R_{\text{SM}}^{-2}$, Eq. (70), ($G = c = 1$ in Tolman book). The constants, A_{SM} , B_{SM} , and R_{SM} are parameters of the transformed Schwarzschild metric, Eq. (69), for $A_{\text{SM}} > 0$,

$$A_{\text{SM}} = \frac{3}{2} \sqrt{1 - \frac{R^2}{R_{\text{SM}}^2}}, \quad B_{\text{SM}} = \frac{1}{2}. \quad (73)$$

Therefore, one obtains the relation of the parameters of the Schwarzschild metric, Eq. (69), to the initial condition $P = P_0$ at $r = 0$ through Eq. (68). Notice that according to Eq. (71) for the pressure $P(r)$, one has $P = 0$ at the boundary $r = R$ because of Eq. (73) for the constants A_{SM} and B_{SM} . Finally, one has the agreement of our result for the pressure, Eq. (67), with that of Ref. [2].

IX. DISCUSSIONS OF THE RESULTS

Figure 5 shows the contour plots for the pressure $P(r, A_{\text{SM}})$ [in units of $P(r = 0, A_{\text{SM}})$], as function of r (km) and parameter A_{SM} of the Schwarzschild metric (69); see Eq. (73). It is more convenient to use the finite dimensionless values of A_{SM} , $0 \leq A_{\text{SM}} \leq 1.5$, instead of dimensional R_{SM} for the fixed effective NS surface radius $R = 10$ km, $0 \leq r \leq R$. For a very rough estimate $\mathcal{E}_0 \sim c^2 \rho^{(0)}$, where the central mass density $\rho^{(0)} \approx M/(4\pi R^3/3) = \mathcal{M}_{\text{NS}} M_{\odot}/(4\pi R^3/3)$,

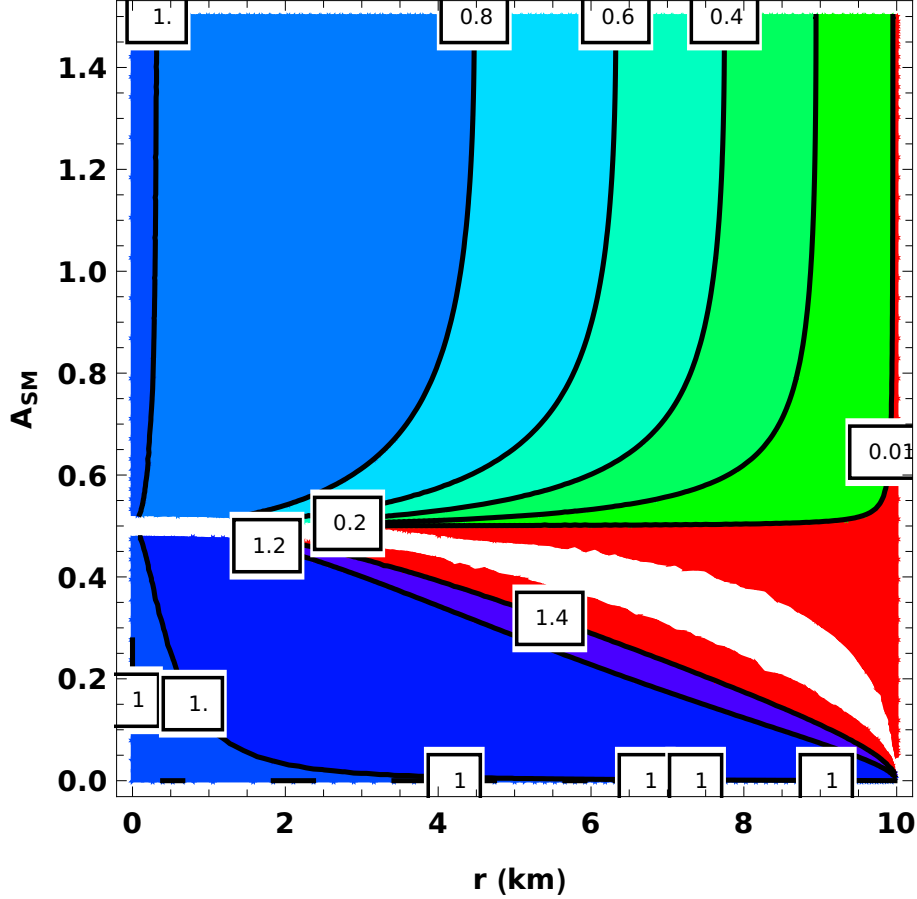

FIG. 5. Contour plots for the pressure $P(r)$, Eq. (71), in units of the central value, $P(r = 0)$, as function of the radial coordinate r and the dimensionless parameter A_{SM} of the Schwarzschild metric, Eq. (69). The numbers in squares show the values of this pressure. White color presents regions where we have indetermination, infinity by infinity, with the finite limit 1 at $r \rightarrow 0$. The red color shows negative values of the ratio $P(r)/P(r = 0)$ (a positive relative pressure, $P(r)/P(0)$). The value “0.00” displays the zero value in horizontal and vertical lines on right of plots. The effective NS radius $R = 10$ km is the same as in Figs. 2 and 4.

($M \approx M_V$) and M_\odot is the Solar mass, and $\mathcal{M}_{\text{NS}} = 1.4 - 2.0$ is approximately the ratio of the volume parts of the NS to Solar mass; see the comments to Eq. (49). Then, one finds significantly larger parameter R_{SM} than the effective radius R , $R_{\text{SM}} \approx 15.6 - 13.0$ km in this case,⁶

⁶ Notice that the Schwarzschild parameter R_{SM} differs essentially from the gravitational radius r_g , introduced

respectively. With these evaluations, one has respectively the constants $A_{\text{SM}} \approx 1.15 - 0.96$. For $M = \mathcal{M}_{\text{NS}}M_\odot \approx (1.4 - 2.0)M_\odot$, one finds the gravitation radius $r_g = 4.1 - 5.9$ km, that

by Schwarzschild, $r_g = 2GM/c^2 \leq R$ [4]. Indeed, R_{SM} is always larger than (or equals) the effective NS radius R .

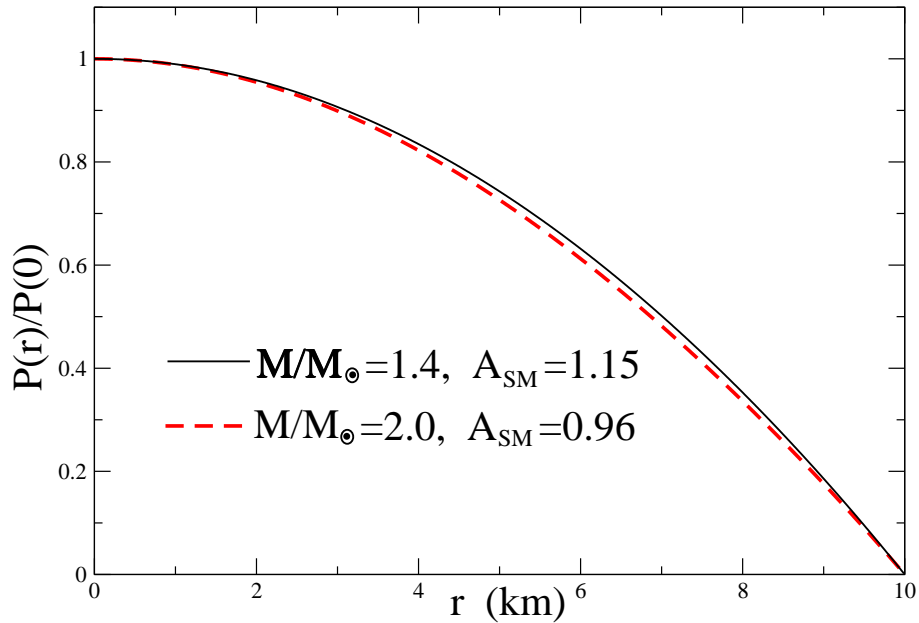

FIG. 6. The pressure $P(r)$, Eq. (71), in units of the central value, $P(r=0)$, as function of the radial coordinate r for the Schwarzschild metric in the form Eq. (69) at two values of the parameter A_{SM} , $A_{\text{SM}} = 1.15$ (solid line) and $A_{\text{SM}} \approx 0.96$ (dashed line) which correspond to the two limit common-accepted values for the NS masses, $M = 1.4M_{\odot}$ and $M = 2.0M_{\odot}$ ($R_{\text{SM}} \approx 13.0$ km and 15.6 km, respectively ; see text). The effective NS radius $R = 10$ km is the same as in Fig. 5.

is smaller than the effective radius $R = 10$ km. The maximum value of A_{SM} , $A_{\text{SM}} \approx 1.5$, corresponds to zero pressure $P(r)$.

Figure 6 shows the two cuts of the contour plots (Fig. 5) at the value, $A_{\text{SM}} \approx 1.15$ ($R_{\text{SM}} \approx 15.6$ km, solid black line), and the value, $A_{\text{SM}} = 0.96$ ($R_{\text{SM}} = 13.0$ km, dashed red line). The physical region, $\mathcal{M}_{\text{NS}} \approx 1.4 - 2.0$, common accepted for many model calculations consistent with experimental data for NS masses (see, e.g., Refs. [10, 15, 24]), is related to a small range in Fig. 6. These curves have the same starting value 1 and final value 0 for the ratio of pressures $P(r)/P(0)$. For more realistic values of R_{SM} , for instance, taking into account the gravitational

defect of mass [4] in the evaluations of the central energy density \mathcal{E}_0 , one may have different values of A_{SM} presented in Fig. 4. Thus, as seen from solid and dashed lines of Fig. 5 and assumed in the derivations of the TOV equations [2, 3], the pressure P turns, indeed, to zero at the boundary of the NS system, $r = R$.

Figure 7 shows the results obtained numerically by solving the TOV equations (62) for the pressure $P = P(r)$ (a) with the EoS, $P = P(\rho)$ (b), related to the Skyrme force KDE0v1 [68]; see also Refs. [10, 69]. For convenience, the radial coordinate r in (a) is presented in km units while the density variable ρ is done in nuclear units fm^{-3} . In both panels (a) and

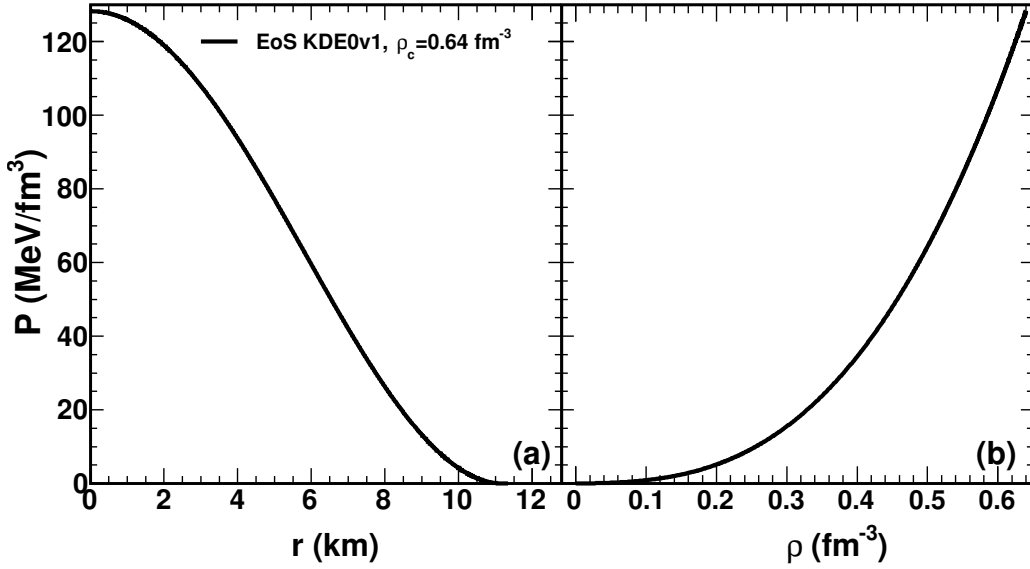

FIG. 7. Left (a): The pressure versus r of the NS with the Skyrme interaction KDE0v1 by solving TOV equations numerically. Right (b): The pressure versus the corresponding density of the NS. The central density $\rho_c = 0.64 \text{ fm}^{-3}$ and the mass of the NS is $1.62 M_\odot$.

(b), the same pressure P is displayed in nuclear units MeV/fm^3 . The pressure $P(r)$ decreases with increasing r while the EoS function of ρ , $P = P(\rho)$, has an opposite behavior. These numerical results are qualitatively in agreement with our volume components P_V shown in Fig. 4 inside of the NS.

The particle number density ρ is shown in Fig. 8 as function of the radial coordinate r (km) for different parameters. The masses $M/M_\odot = 1.62$ and 1.02 , larger than the Solar mass M_\odot correspond to different values of the central density $\rho_c = 0.64 \text{ fm}^{-3}$ (solid black) and 0.416 fm^{-3} (blue dashed-dotted curve), significantly larger than the nuclear matter value 0.16 fm^{-3} . All of them are related to the EoS KDE0v1 Skyrme force [68]; see also Refs. [10, 69]. The gravitation force effects are tested formally for decreasing

the gravitation constant G by factor 4 in the red dotted line in Fig. 8. The Woods-Saxon leptodermic fit is shown by the red dotted line in Fig. 9. The last situation is qualitatively close to our analytical results for the volume (V) contributions presented in Figs. 4-6. The main difference in Fig. 4 (b), as compared to the numerical results in Figs. 7-9, is the surface contribution (S) into EoS, $P = P(y)$ ($y = \rho/\bar{\rho}$); see Fig. 4 (a); and the pressure leptodermic correction $P_S(r)$, Eq. (61) [Fig. 4 (b)]. The shape of the total pressure behavior, $P = P(r)$, is more leptodermic in Fig. 4 than in that in Fig. 7(a). These results are in good agreement with the density shapes for the analytical results in Fig. 2 and numerical calculations in Fig. 9 as displayed by the red curve for the WS fit. The WS fit formula

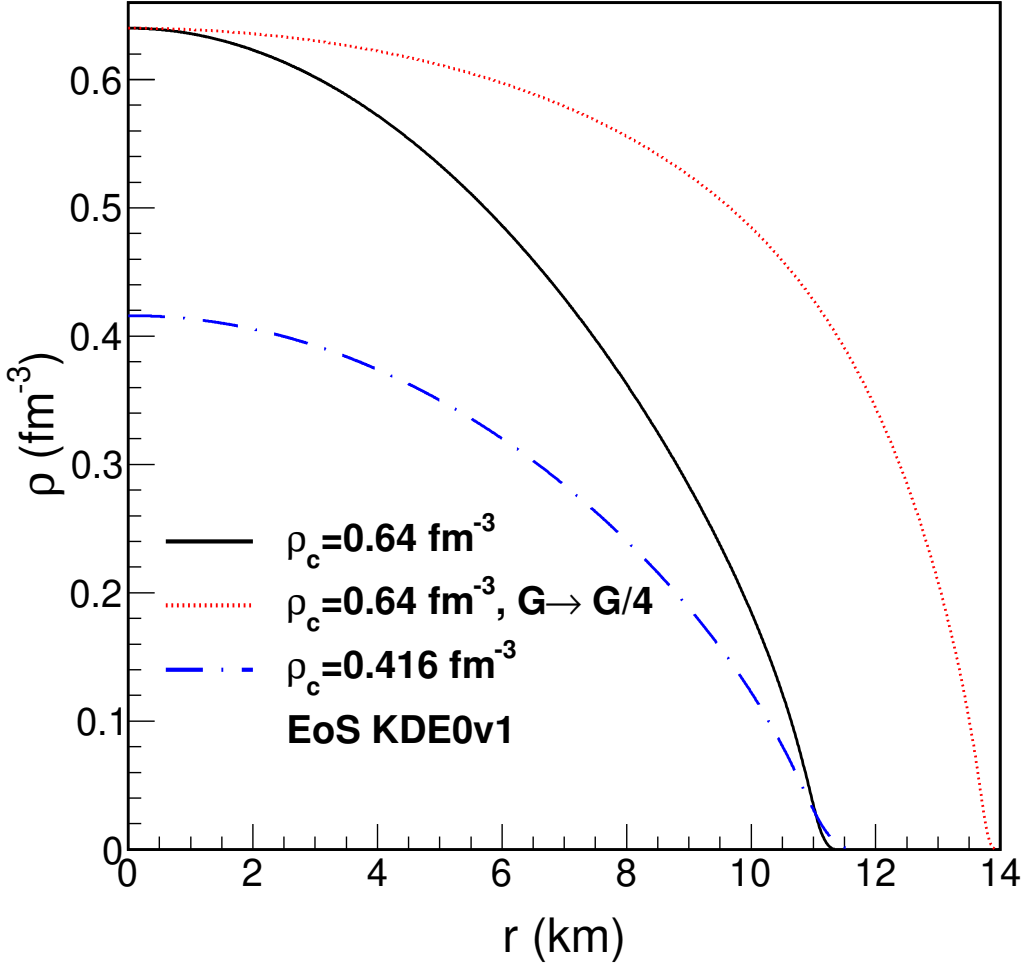

FIG. 8. The density profiles of the NS with the Skyrme interaction KDE0v1 by solving TOV equations numerically. The black solid line refers to the central density $\rho_c = 0.64 \text{ fm}^{-3}$ and the mass of the NS is $1.62 M_\odot$. The red dotted line refers to the central density $\rho_c = 0.64 \text{ fm}^{-3}$ with changing the gravitation constant G to $G/4$ and the mass of the NS is $4.0 M_\odot$. The blue dashed-dotted line refers to another central density $\rho_c = 0.416 \text{ fm}^{-3}$ and the mass of the NS is $1.02 M_\odot$.

is given by

$$\rho(r) = \frac{\rho_{\text{WS}}}{1 + \exp[(r - R_{\text{WS}})/a_{\text{WS}}]}, \quad (74)$$

where $\rho_{\text{WS}} = 0.16 \text{ fm}^{-3}$, $R_{\text{WS}} = 14.2786 \text{ km}$, and $a_{\text{WS}} = 0.7074 \text{ km}$. The results in Figs. 5 and 6 for the volume contributions of the pressure $P(r)$, obtained analytically from the TOV equations (62), are naturally similar to those shown in Fig. 7 (a). The surface contributions to the standard TOV equations (62) and the corre-

sponding solutions will be studied in the forthcoming work where we are going to take into account explicitly the ES corrections.

X. CONCLUSIONS

The effective surface approximation based on the leptodermic expansion over a small parameter - a ratio of the crust thickness a to the effec-

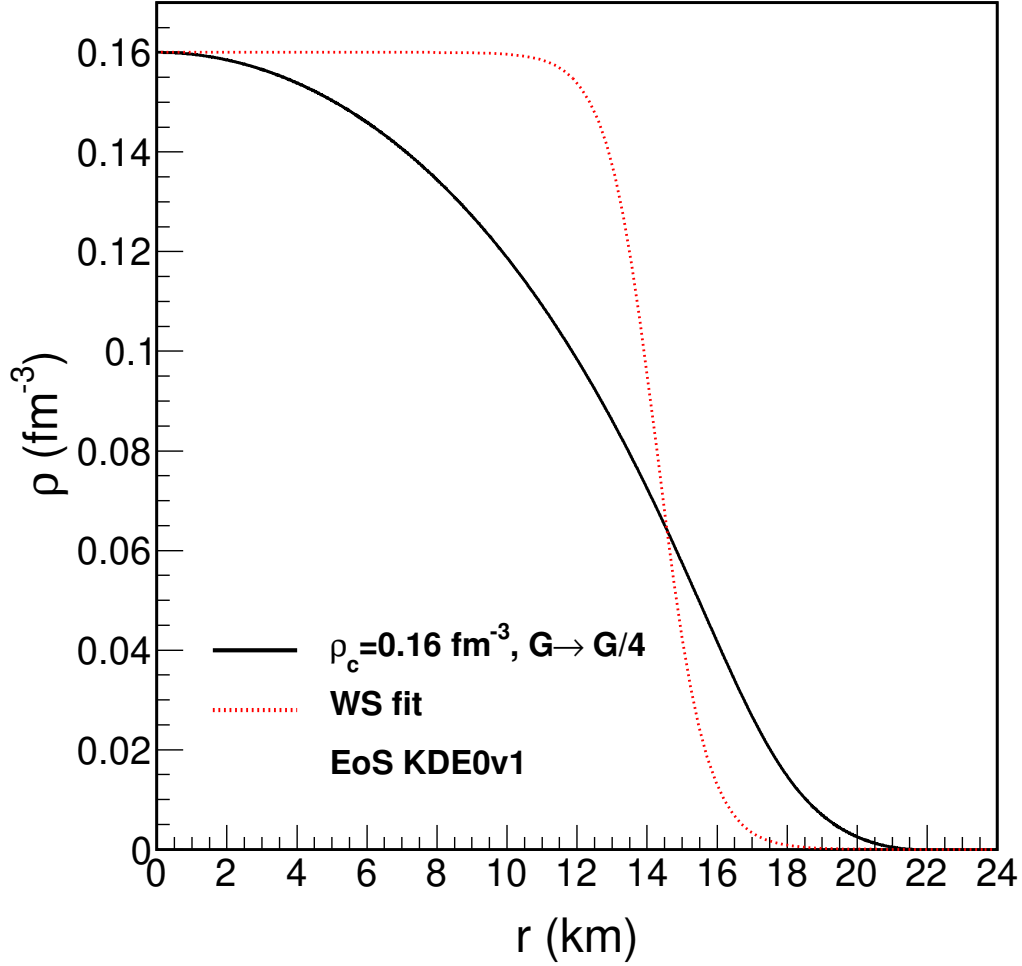

FIG. 9. The density profiles of the NS with the Skyrme interaction KDE0v1 by solving TOV equations numerically. The black solid line refers to the central density $\rho_c = 0.16 \text{ fm}^{-3}$ with changing the gravitation constant G to $G/4$ and keeping the mass of the NS to be $1.62 M_\odot$. The red dotted line is the WS fit, Eq. (74).

tive radius R of the system - is extended for the description of neutron star properties. Neutron star was considered as a dense liquid drop at the equilibrium. The gravitation potential $\Phi(\rho)$ was taken into account in the nearly Newtonian limit of the Einstein equations in the simplest form as an expansion over powers of differences $\rho - \bar{\rho}$, where $\bar{\rho}$ is the saturation density, up to second order. For a strong gravitation, one has its significant contribution to the incompressibility

modulus K_G . Taking into account the gradient terms of the energy density in a rather general form we analytically obtained the leading (over a small parameter $a/R \ll 1$) particle number density ρ as function of the normal-to-ES coordinate ξ of the orthogonal local nonlinear-coordinate system ξ, η, φ through the effective surface. This result is in a good agreement with the van der Waals phenomenological capillary theory. With the help of the local coordinate system ξ, η , one

finds the equation of state (EoS) for the pressure $P = P(\rho)$, and the NS surface mass correction M_S for a spherical and deformed NS in the leading ES approach. Adding a high order correction over a/R , one obtains also the NS energy as a sum of the volume and surface terms with the analytical expression for the surface tension coefficient, also in agreement with the van der Waals theory. We obtained the effective surface corrections to the pressure P of the EoS, which are significant near the ES. In the line of Tolman derivations, the TOV equations were solved analytically within the same approximations which were used in their derivations within the same ESA approach. Our results for the leading-order pressure are in good agreement with those of Tolman [2], and explicitly, are related to the initial condition for the pressure at zero radial coordinate. The volume contributions to the pressure in our analytical calculations are in good agreement with the numerical results obtained from the TOV equations with the EoS based on the Skyrme forces, in the case of leptodermic fit of the particle number density ρ to its WS behavior. From comparison of the analytical and numerical results for the pressure and density, one can conclude importance of the surface corrections near the effective surface.

As perspectives, one can generalize our analytical approach to take into account the gradient terms in the TOV equations, as well as to the heated (finite temperature) and many-component systems. It is especially interesting to extend this approach to take into account the

symmetry energy of the isotopically asymmetric finite systems. As this approach was formulated in the local nonlinear system of coordinates ξ, η, φ for deformed and superdeformed shapes of the surface, one can apply our method to the NS pulsars at large angular momenta.

ACKNOWLEDGMENTS

The authors greatly acknowledge C.A. Chin, V.Z. Goldberg, J. Holt, C.M. Ko, E.I. Koshchiy, J.B. Natowitz, A.I. Sanzhur, and G.V. Rogachev for many creative and useful discussions. A. Bonasera, T. Depastas, and A.G. Magner are partially supported by the US Department of Energy under Grant no. DE-FG03-93ER-40773.

Appendix A: Local coordinates near the effective surface

The axially symmetric shapes of the ES in cylindrical coordinates are assumed to be determined in terms of a certain profile function $y = Y(z)$ in the plane of the axis of symmetry by rotation around z axis. The ξ is defined in the text as the coordinate perpendicular to the ES. The other coordinate η can be chosen for example, as the z -coordinate of the point at the surface where the perpendicular to the ES from the given point \mathbf{r} crosses it. Thus, let us define new coordinates ξ, η , related to the cylindrical coordinates, as

$$\begin{aligned} y &= y(\xi, \eta) = Y(\eta) + \frac{\xi}{\mathcal{L}}, \\ z &= z(\xi, \eta) = \eta - \frac{\xi}{\mathcal{L}} \frac{\partial Y(\eta)}{\partial \eta}, \end{aligned} \quad (\text{A1})$$

where

$$\mathcal{L} = \left[1 + \left(\frac{\partial Y(\eta)}{\partial \eta} \right)^2 \right]^{1/2}. \quad (\text{A2})$$

The length and volume elements are given by

$$\begin{aligned} dl &= (g_\xi d\xi^2 + g_\eta d\eta^2 + g_\varphi d\varphi^2)^{1/2}, \\ dr &= \sqrt{g} d\xi d\eta d\varphi, \\ \sqrt{g} &= (R_1 + \xi)(1 + \xi/R_2) \end{aligned} \quad (\text{A3})$$

with the diagonal metric tensor,

$$\begin{aligned} g_\xi &= 1, & g_\eta &= \left(1 + \frac{\xi}{R_2}\right)^2 \mathcal{L}^2, \\ g_\varphi &= \left(1 + \frac{\xi}{\mathcal{L}}\right)^2 Y^2(\eta), \end{aligned} \quad (\text{A4})$$

R_1 and R_2 are two local curvature radii of the ES

$$R_1 = \mathcal{L}Y(\eta), \quad R_2 = -\frac{\mathcal{L}^3}{\partial^2 Y / \partial \eta^2}. \quad (\text{A5})$$

According to the right of Eq. (A3), the mean curvature writes

$$H = \frac{1}{2} \left(\frac{1}{R_1} + \frac{1}{R_2} \right) = \frac{1}{2} \left(\frac{\partial}{\partial \xi} \ln \sqrt{g} \right). \quad (\text{A6})$$

For the Laplace operator in new coordinates ξ, η , one finds

$$\Delta_{\xi\eta} = \frac{\partial^2}{\partial \xi^2} + \frac{\partial}{\partial \xi} (\ln \sqrt{g}) \frac{\partial}{\partial \xi} + \frac{1}{\sqrt{g}} \frac{\partial}{\partial \eta} \left(\frac{\sqrt{g}}{g_\eta} \frac{\partial}{\partial \eta} \right). \quad (\text{A7})$$

-
- [1] R.C. Tolman, Phys. Rev. **C55**, 364 (1939).
[2] R.C. Tolman, *Relativity, Thermodynamics, and Cosmology*, (Dover Publications, New York, 1987; Oxford, the University Press, 1934, 1946, 1949, 1987).
[3] J.R. Oppenheimer and G.M. Volkoff, Phys. Rev. **C55**, 374 (1939).
[4] L.D. Landau and E.M. Lifshitz, Theoretical Physics, v.2 *Field theory* (Butterworth-Heinemann, New York, 2003; FIZMATLIT, Moscow, 2003).
[5] L.D. Landau and E.M. Lifshitz, Theoretical Physics, v.6 *Fluid mechanics* (Pergamon Press, 1987, FIZMATLIT, Moscow, 2013).
[6] R.B. Wiringa, V. Fiks, A. Fabrocini, Phys. Rev. C **38**, 1010 (1988).
[7] E. Chabanat, P. Bonche, P. Haensel, J. Meyer, and R. Shaeffer, Nucl. Phys. A **627**, 710 (1997).
[8] I. Sagert, M. Hempel, C. Greiner, and J. Schaffner-Bielich, Eur. J. Phys. **27**, 577 (2006).
[9] Bao-An Li, Lie-Wen Chen, and Che Ming Ko, Phys. Rep., **464**, 113 (2008).
[10] G. Giuliani, H. Zheng, A. Bonasera, Prog. Part. Nucl. Phys. **76**, 116 (2014).
[11] R. Belverde, F. Cipoletta, C. Cherubini, S.M. de Carvalho, S. Filippi, R. Negreiros, J. P. Pereira, J.A. Rueda, and R. Ruffini, *Physics and Astrophysics of Neutron Stars*, The second ICRANet César Lattes Meeting, AIP Conf. Proc. 1693,030001-1-030001-19; doi:10.1063/1.4937184 (AIP Publishing LLC

- 978-0-7354-5/\$30.00), p.030001-1 (2015).
- [12] Y. Lim and J.W. Holt, *Eur.Phys. J. A* **55**, 209 (2019).
- [13] Boyang Sun, Saketh Bhattiprolu, and James M. Lattimer, *archiv:2311.00843v1*, 2023.
- [14] G. Baym, H. Bethe, and C.J. Pethick, *Nucl. Phys. A* **175**, 225 (1971).
- [15] P. Haensel, A.Y. Potehin, D.G. Yakovlev. *Astrophysics and space science library*, vol. 326, *Neutron Stars 1. Equation of State and Structure* (Springer, New York, 2007).
- [16] J.M. Lattimer, *J. Phys., Conf Ser.*, **2536**, 012009 (2023).
- [17] J.M. Lattimer and M. Prakash, *The astrophysical Journal*, **550**, 426 (2001).
- [18] C.J. Horowitz and J. Piekarewicz, *Phys. Rev. Lett.*, **86**, 5647 (2001).
- [19] C.J. Horowitz and J. Piekarewicz, *Phys. Rev. C*, **64**, 062802(R) (2001).
- [20] P.Haensel, *Neutron Star Crusts*, N. Copernicus Astronomical Center, Polish Academy of Sciences, Bartycka 18, PL-00-716 Warszawa, Poland, 2000.
- [21] Z. Arzoumanian, S. Bogdanov, J. Cordes, K. Gendreau, D. Lai, J. Lattimer, B. Link, A. Lommen, C. Miller, P. Ray, R. Rutledge, T. Strohmayer, C. Wilson-Hodge, and K. Wood, *arXiv:0902.3264*, 2009; <https://doi.org/10.48550/arXiv.0902.3264>.
- [22] A.F. Fantina, and F. Gulminelli, *J. Phys., Conf. Ser.* **2586**, 012112 (2023); [doi:10.1088/1742-6596/2586/1/012112](https://doi.org/10.1088/1742-6596/2586/1/012112).
- [23] H. Dinh, A.F. Fantina, and F. Gulminelli, *Eur. Phys. J. A* **59**, 292(2023), <https://doi.org/10.1140/epja/s10050-023-01199-x>.
- [24] S.L. Shapiro, S.A. Teukolsky, *Black holes, white dwarfs, and neutron stars: The physics of compact objects* (Wiley-VCH Verlag GmbH & Co.KGaA, Weinheim, 2004).
- [25] L. Willets, *Phys.Rev.* **101**, 1805 (1956); *Rev. Mod. Phys.* **30** 542 (1958).
- [26] V.M. Strutinsky, and A.S. Tyapin, *Exp. Theor. Phys. (USSR)* **18** 664 (1964).
- [27] A.S. Tyapin, *Sov. Journ. Nucl. Phys.* **11**, 401 (1970), **13**, 32 (1971), **14**, 50 (1972).
- [28] V.M. Strutinsky, A.G. Magner, and M. Brack, *Z. Phys. A* **319**, 205 (1984).
- [29] V.M. Strutinsky, A.G. Magner, and V. Yu. Denisov, *Z. Phys.*, **322** 149 (1985).
- [30] A.G. Magner, A.I. Sanzhur, and A.M. Gzhebinsky, *Int. J. Mod. Phys. E* **92**, 064311 (2009).
- [31] J.P. Blocki, A.G. Magner, P. Ring, and A.A. Vlasenko, *Phys. Rev. C* **87**, 044304 (2013).
- [32] J.P. Blocki, A.G. Magner, and P. Ring, *Phys. Rev. C* **92**,064311 (2015).
- [33] J.S. Rowlinson and B. Widom, *Molecular Theory of Capillarity* (Clarendon Press, Oxford, 1982).
- [34] H. Bethe, *Annu. Rev. Nucl. Sci.*, **21**, 93 (1971).
- [35] M. Brack and R. K. Bhaduri, *Semiclassical Physics* (Addison-Wesley, Reading MA) 1997; 2nd edition (Westview Press, Boulder) 2003.

- [36] M. Brack, G. Guet, H.-B. Hrakansson, Phys. Rep. **123** 275 (1985).
- [37] A. Bohr and B. Mottelson, *Nuclear structure* (W. A. Benjamin, New York, 1975), Vol. II.
- [38] A. G. Magner, V. M. Strutinsky, Z. Phys. A **324**, 633 (1985).
- [39] J.S. Rowlinson, Journ. Stat. Phys. **20**, 197 (1979).
- [40] A.N. Tikhonov, *Systems of differential equations containing a small parameter in front of the derivatives*, Mat. Sb. , 31 : 3 (1952) pp. 575-586 (In Russian).
- [41] D. Vautherin, D. Brink, Phys. Rev. C **5** 626 (1972).
- [42] T.H.R. Skyrme, Philos. Mag., **1** 8th ser., 1043 (1956).
- [43] R.C. Barrett, D.F. Jacson, *Nuclear sizes and structure* Oxford, Clarendon Press 1977.
- [44] P. Ring, P. Schuck, *The nuclear many-body problem*, Berlin, Heidelberg, New York, Springer-Verlag 1980.
- [45] J.P. Blaizot, Phys. Rep. **64** 172 (1980).
- [46] H. Krivine, J. Treiner, and O. Bohigas, Nucl. Phys. A, **336** 155, (1980).
- [47] E. Chabanat, P. Bonche, P.Haensel, J. Meyer, and R. Shaeffer, Nucl. Phys. A **635**, 231 (1998).
- [48] B. Gramaticos, A. Voros, Ann.Phys., **123**, 359 (1979); **129**, 153 (1980).
- [49] M. Brack and R. K. Bhaduri, *Semiclassical Physics. Frontiers in Physics* No. 96, 2nd ed. (Westview Press, Boulder CO, USA, 2003).
- [50] V.M. Kolomietz and A.I. Sanzhur, Eur. Phys. J. A **38**, 345–354 (2008).
- [51] V.M. Kolomietz, A.I. Sanzhur, and S. Shlomo, Phys. Rev. C **97**, 064302 (2018).
- [52] V.M. Kolomietz and S. Shlomo, Mean Field Theory, World Scientific, Singapore (2020).
- [53] W.D. Myers and W.J. Swiatecki, Ann. Phys. (NY) **55**, 395 (1969); **84**, 186 (1974).
- [54] W.D. Myers, W.J. Swiatecki, and C.S. Wang, Nucl.Phys. A **436**, 185 (1985).
- [55] P. Danielewicz and J. Lee, Int. J. Mod. Phys. E **18**, 892 (2009).
- [56] M. Centelles, X. Roca-Maza, X. Vinas, and M. Warda, Phys. Rev. Lett., **102**, 122502 (2009).
- [57] M. Warda, X. Vinas, X. Roca-Maza, and M. Centelles, Phys. Rev. C **80**, 024316 (2009); **81**, 054309 (2010); **82**, 054314 (2010); arXiv:0906.0932 [nucl-th] (2009).
- [58] X. Roca-Maza, M. Centelles, X. Vinas, and M. Warda, Phys. Rev. Lett. **106**, 252501 (2011).
- [59] X. Vinas, M. Centelles, X. Roca-Maza, and M. Warda, Eur. Phys. J. A **50**, 27 (2014).
- [60] J. Piekarewicz and M. Centelles, Phys. Rev. C **79**, 054311 (2009).
- [61] T. Niksic, D. Vretenar, and P. Ring, Prog. Part. Nucl. Phys., **66**, 519 (2011).
- [62] B.D. Reed, F.J. Fattoyev, C.J. Horowitz, and J. Piekarewicz, Phys. Rev. Lett. **126**, 172503 (2021).
- [63] N. Chamel and P. Haensel, Liv. Rev. Relativ. **11**, 10 (2008).

- [64] N. N. Shchechilin, N. Chamel, J. M. Pearson, Phys. Rev. C **108**, 025805 (2023).
- [65] V.M. Strutinsky, N.Ya. Ljashchenko, N.A. Popov, Nucl.Phys. **46** 171 (1963).
- [66] L.D. Landau and E.M. Lifshitz, *Statistical Physics*, Third Edition Part 1, Course of Theoretical Physics, v. 5 (Elsevier, N.Y., 2005).
- [67] G.S. Bisnovatiy-Kogan, Relativistic astrophysics and physical cosmology, (Moscow, Krasand, 2011, Russian).
- [68] B.K. Agrawal, S. Shlomo, and V.Kim Au, Phys. Rev. C **72**, 014310 (2005).
- [69] H. Zheng and A. Bonasera, Phys. Rev. C **83**, 057602 (2011).