

Singular twisted links and singular twisted virtual braids

KOMAL NEGI, MADETI PRABHAKAR

Abstract

The concepts of twisted knot theory and singular knot theory inspire the introduction of singular twisted knot theory. This study showcases similar findings for singular twisted links, including the Alexander theorem and the Markov theorem derived from knot theory. Moreover, in this paper we define singular twisted virtual braids and their monoid structure. Additionally, we provide both a monoid and a reduced monoid presentation for singular twisted virtual braids.

MSC2020: 57K10, 57K12, 57M15

Keywords. Singular twisted knots, singular twisted virtual braids.

1 Introduction

S. Kamada [7] proved that every oriented virtual link can be depicted as the closure of a virtual braid. Furthermore, it is established that two virtual braids have isotopic closures if and only if they are connected by virtual braid isotopy and a finite series of Markov moves, a widely recognized result. Similar theorems have been established by Kauffman and Lambropoulou [3, 4] through the use of L_v -equivalence. Moreover, C. Caprau et al. [1] extended the L_v -move approach to virtual singular braids, deriving the analogous L_v -move for virtual singular braids.

Recently, Kamada et al. [2] established Alexander and Markov's theorems for twisted virtual braids and twisted links [5, 6]. Furthermore, they verified that the collection of twisted virtual braids with n strands forms a group [8]. It will be interesting to see similar kind of results for singular twisted virtual braids.

This paper focuses on oriented singular twisted links and establishes Alexander and Markov-type theorems for this category of links. These theorems play an important role in understanding the structure of singular twisted knots and links. First, we define the singular twisted virtual braid monoid through generators and relations. This definition unveils that the singular twisted virtual braid monoid with n strands extends from the virtual singular braid monoid with n strands by a group, which is isomorphic to \mathbb{Z}_2^n .

Several braiding techniques can be employed to demonstrate the extension of the Alexander theorem to the category of singular twisted virtual braids. In our context, we adopt the braiding algorithm outlined in [1].

This article is organized as follows, in Section 2, we provide some preliminaries of singular twisted links and singular twisted virtual braids. Also, we stated the Alexander theorem for singular twisted links. In Section 3, we outline L_v -moves and present the Markov-type theorems for singular twisted links and singular twisted virtual braids. Moreover, we have established that number of Markov moves or L_v -moves can be reduced for singular twisted virtual braids. In Section 4, we provide a reduced presentation of the singular twisted virtual braid monoid.

2 Preliminaries

In this section we define singular twisted links in topological and combinatorial way. We also define singular twisted virtual braids. Moreover, we give Alexander theorem for singular twisted links.

2.1 Singular twisted link

Definition 2.1. A *singular twisted link* is an embedding of a 4-valent graph G in $S_g \times I$, where S_g is a surface of the genus g and I is the unit interval such that the thickened surface $S_g \times I$ is orientable.

Remark 2.2. A *singular twisted knot* is an embedding of a one component 4-valent graph G in $S_g \times I$.

There is also a combinatorial way to define singular twisted links. For that we need to define singular twisted link diagrams.

Definition 2.3. A singular twisted link diagram is a decorated immersion of finitely many disjoint copies of S^1 into \mathbb{R}^2 , with bars and finitely many transverse double points such as classical crossings, virtual crossings, and singular crossings.

Two singular twisted link diagrams are said to be equivalent(or ambient isotopic) if they are related by a sequence of Reidemeister moves shown in Figure 1.

Definition 2.4. A singular twisted link is the equivalence class of a singular twisted link diagram.

Example 2.5. Consider the two singular twisted link diagrams D_1 and D_2 as shown in Figure 2. D_2 can be obtained from D_1 by sequence of Reidemeister moves S4, S3, and T2, respectively.

As we know, classical knots have a nice connection with braids. A similar connection exists between virtual knots and virtual braids. Therefore, it is

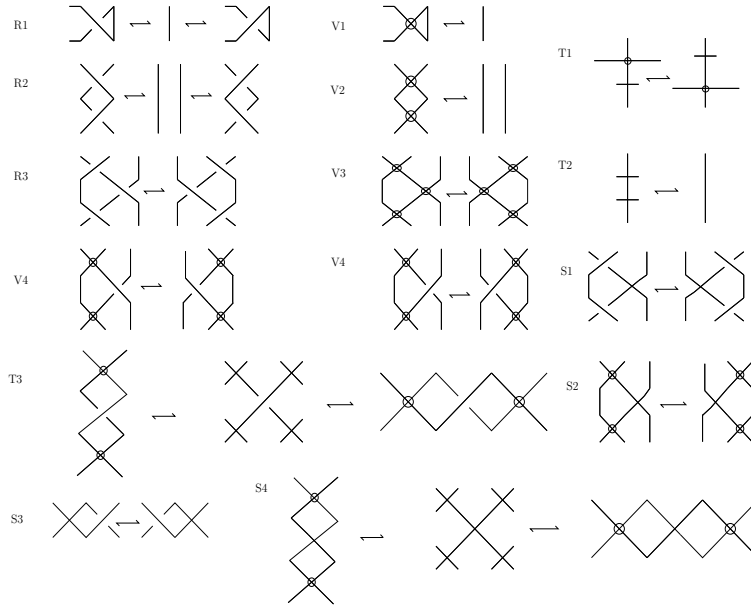

Figure 1: Reidemeister moves for singular twisted link diagrams

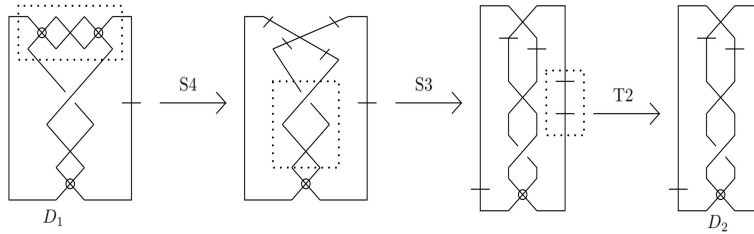

Figure 2: Singular twisted link diagrams

natural to ask: Does there exist any braid-like structure in this theory? In the next subsection, we define singular twisted virtual braids, and we demonstrate their connection to singular twisted links.

2.2 Singular twisted virtual braid

Definition 2.6. A *singular twisted virtual braid diagram* on n strands (or of degree n) is a union of n smooth or polygonal curves, which are called *strands*, in \mathbb{R}^2 connecting points $(i, 1)$ with points $(q_i, 0)$ ($i = 1, \dots, n$), where (q_1, \dots, q_n) is a permutation of the numbers $(1, \dots, n)$, such that these curves are monotonic with respect to the second coordinate and intersections of the curves are transverse double points equipped with information as a positive/negative/virtual/singular crossing and curves may have *bars* by which we mean short arcs intersecting the

curves transversely. See Figure 3, where the five crossings are negative, positive, virtual, singular and positive from the top.

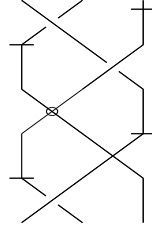

Figure 3: A singular twisted virtual braid on 3 strands

Definition 2.7. Two singular twisted virtual braid diagrams b and b' of degree n are *equivalent* if they are related by classical, virtual, twisted and singular braid moves shown in Figure 4,5,6, and 7, respectively.

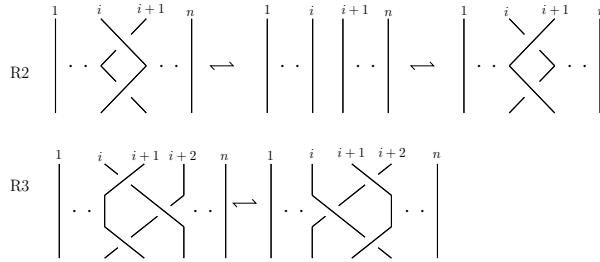

Figure 4: Classical braid moves

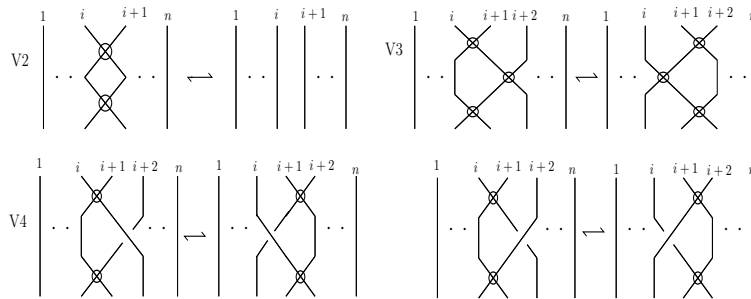

Figure 5: Virtual braid moves

Definition 2.8. A *singular twisted virtual braid* is an equivalence class of singular twisted virtual braid diagrams.

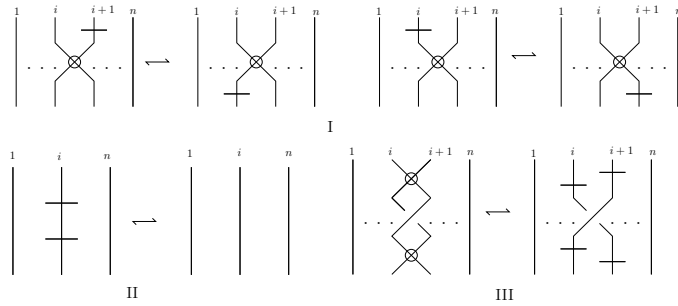

Figure 6: Twisted braid moves

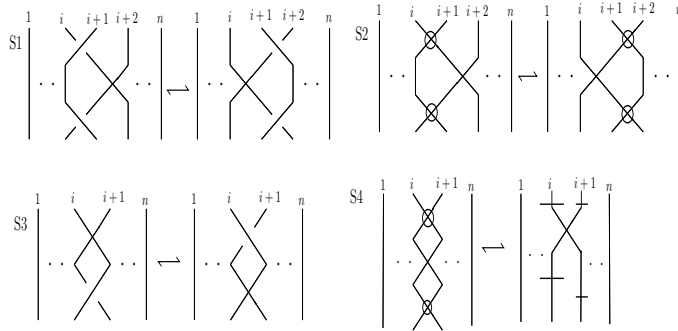

Figure 7: Singular braid moves

Similar to the case of singular braids and virtual singular braids, the set of singular twisted virtual braids forms a monoid, where the product is defined by the concatenation similar to the braid group. The set of isotopy classes of singular twisted virtual braid on n strands forms a monoid, which we denoted by $STVB_n$. Define $STVB_\infty = \bigcup_{n=1}^{\infty} STVB_n$.

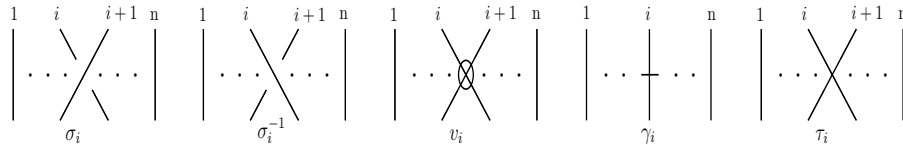

Figure 8: Generators of the monoid of singular twisted virtual braids

Theorem 2.9. *The monoid $STVB_n$ is generated by standard generators, $\sigma_i^{\pm 1}$, v_i ($i = 1, \dots, n - 1$), γ_i ($i = 1, \dots, n$), and τ_i ($i = 1, \dots, n - 1$) satisfy the*

following relations, where e denotes the identity element:

$$\begin{aligned} \sigma_i \sigma_j &= \sigma_j \sigma_i && \text{for } |i - j| > 1; && (1) \\ \sigma_i \sigma_{i+1} \sigma_i &= \sigma_{i+1} \sigma_i \sigma_{i+1} && \text{for } i = 1, \dots, n - 2; && (2) \\ v_i^2 &= e && \text{for } i = 1, \dots, n - 1; && (3) \\ v_i v_j &= v_j v_i && \text{for } |i - j| > 1; && (4) \\ v_i v_{i+1} v_i &= v_{i+1} v_i v_{i+1} && \text{for } i = 1, \dots, n - 2; && (5) \\ \sigma_i v_j &= v_j \sigma_i && \text{for } |i - j| > 1; && (6) \\ v_i \sigma_{i+1} v_i &= v_{i+1} \sigma_i v_{i+1} && \text{for } i = 1, \dots, n - 2; && (7) \\ \gamma_i^2 &= e && \text{for } i = 1, \dots, n; && (8) \\ \gamma_i \gamma_j &= \gamma_j \gamma_i && \text{for } i, j = 1, \dots, n; && (9) \\ \gamma_j v_i &= v_i \gamma_j && \text{for } j \neq i, i + 1; && (10) \\ \sigma_i \gamma_j &= \gamma_j \sigma_i && \text{for } j \neq i, i + 1; && (11) \\ \gamma_{i+1} v_i &= v_i \gamma_i && \text{for } i = 1, \dots, n - 1; && (12) \\ v_i \sigma_i v_i &= \gamma_{i+1} \gamma_i \sigma_i \gamma_i \gamma_{i+1} && \text{for } i = 1, \dots, n - 1; && (13) \\ \sigma_i \sigma_i^{-1} &= e && \text{for } i = 1, \dots, n - 1; && (14) \\ \tau_i \tau_j &= \tau_j \tau_i && \text{for } |i - j| > 1; && (15) \\ \sigma_i \tau_j &= \tau_j \sigma_i && \text{for } |i - j| > 1; && (16) \\ \sigma_i \tau_i &= \tau_i \sigma_i && \text{for } i = 1, \dots, n; && (17) \\ \sigma_i \sigma_{i+1} \tau_i &= \tau_{i+1} \sigma_i \sigma_{i+1} && \text{for } i = 1, \dots, n - 2; && (18) \\ \tau_i v_j &= v_j \tau_i && \text{for } |i - j| > 1; && (19) \\ v_i \tau_{i+1} v_i &= v_{i+1} \tau_i v_{i+1} && \text{for } i = 1, \dots, n - 2; && (20) \\ \tau_i \gamma_j &= \gamma_j \tau_i && \text{for } j \neq i, i + 1; && (21) \\ v_i \tau_i v_i &= \gamma_{i+1} \gamma_i \tau_i \gamma_i \gamma_{i+1} && \text{for } i = 1, \dots, n - 1. && (22) \end{aligned}$$

Remark 2.10. If we consider generators σ_i , v_i ($i = 1, \dots, n - 1$), and γ_i ($i = 1, \dots, n$) with the relations from (1) to (13), then this set forms a group called the twisted virtual braid group TVB_n [8].

As of now, it is evident that a singular twisted virtual braid can yield a singular twisted link through the closure operation. The query arises: can we generate a singular twisted virtual braid from a singular twisted link? The answer is yes, there exists an algorithm for this process.

The method to convert any diagram of a singular twisted link into the form of a singular twisted virtual braid's closure is same as the braiding algorithm outlined in [1], the only difference is the incorporation of bars on the strands. The given algorithm helps to establish a theorem concerning singular twisted links, analogous to the Alexander theorem for twisted virtual braids and twisted links [2].

Theorem 2.11. (Alexander type theorem for singular twisted links) *Every oriented singular twisted link can be represented as the closure of singular twisted*

virtual braid.

Corollary 2.12. *Every oriented twisted link can be represented as the closure of twisted virtual braid.*

We have observed that if two singular twisted virtual braids are equivalent, their corresponding closures are equivalent as singular twisted links. However, the converse is not necessarily true. It is possible for two non-equivalent singular twisted virtual braids to have equivalent closures. To establish this converse, we can introduce a new notion of equivalence between the singular twisted virtual braids, known as L_v -equivalence or Markov equivalence.

3 L_v -moves and Markov-type theorems for singular twisted virtual braids

In this section we show a theorem on braid presentation of singular twisted links which is analogous to the Markov theorem for twisted links. For this, we present the L_v -moves applicable to singular twisted virtual braids, whereas the literature already includes L_v moves for virtual braids and singular virtual braids. Furthermore, we have demonstrated the capability to decrease the number of L_v -moves required for singular twisted virtual braids.

All types of L_v -moves for singular twisted virtual braids are stated below:

A L_v -move of type 1, denoted by *ST1-move* contains two types of moves, the virtual and real L_v -move (denoted as VST1-move and RST1-move, respectively). These moves are illustrated in Figure 9.

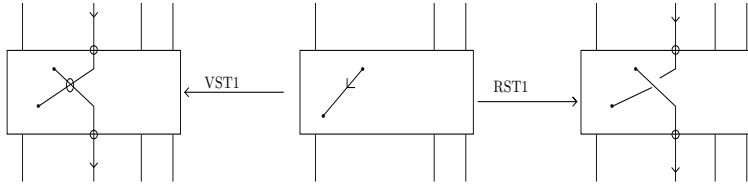

Figure 9: ST1-move: Virtual or real L_v -move

A L_v -move of type 2, denoted by *ST2-move* is a under threaded L_v -move shown in Figure 10. It contains two types of moves, the left ST2-move and the right ST2-move (denoted as LST2-move and RST2-move, respectively).

A L_v -move of type 3, denoted by *ST3-move* is a *rs*-threaded L_v -move. There are two types of them denoted as LST3 and RST3 shown in Figure 11.

A L_v -move of type 4, denoted by *ST4-move* is a conjugation move. There are three types of conjugation moves: Singular, real, and twist conjugation (denoted as SST4, RST4 and TST4-move, respectively) as shown in Figure 12a and Figure 12b.

Remark 3.1. In [4], it has been shown that virtual conjugation, basic L_v -moves, left rL_v - and vL_v -moves, over-threaded L_v -moves, and multi-threaded L_v -moves

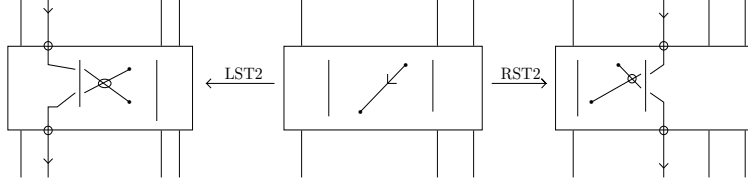

Figure 10: ST2-move: Left and Right under threaded L_v -move

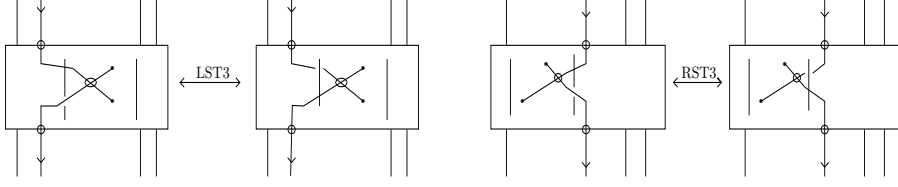

Figure 11: ST3-move: Left and Right rs -threaded L_v -move

can be derived from the L_v -equivalence for virtual braids(it encompasses real conjugation, right rL_v - and vL_v -moves, left and right under-threaded L_v -moves, and virtual braid isotopy). Consequently, these moves can also be derived from the ST1-ST4 L_v -moves, thus we do not require to write them in our L_v -move Markov-type theorem for singular twisted virtual braids.

Now we are ready to define new notion of equivalence for the singular twisted virtual braids.

Definition 3.2. Two twisted virtual braids are said to be twisted L_v -equivalent if they differ by twisted virtual braid isotopy and a finite sequence of L_v moves $ST1$ - $ST2$, $RST4$, and $TST4$.

Definition 3.3. Two singular twisted virtual braids are said to be L_v -equivalent if they differ by singular twisted virtual braid isotopy and a finite sequence of L_v moves $ST1$ - $ST4$.

Theorem 3.4. *Two singular twisted virtual braids have isotopic closures if and only if they are L_v -equivalent.*

Proof. If two singular twisted virtual braids are L_v -equivalent then they have isotopic closures. For the converse, we aim to demonstrate that two singular twisted virtual braids with isotopic closures are related by L_v -equivalence. To achieve this, our task is to validate that singular twisted link diagrams, which differ due to Reidemeister moves, correspond to closures of singular twisted virtual braids that are L_v -equivalent. Starting with Reidemeister moves R1, R2, R3, V1, V2, V3, V4 moves, these moves has been checked in [4] and S1, S2, S3 moves has been checked in [1], hence it is enough to validate T1, T2, T3, and S4 moves from Reidemeister moves for singular twisted links. These moves need to be considered with any given orientation of the strands. We explore all

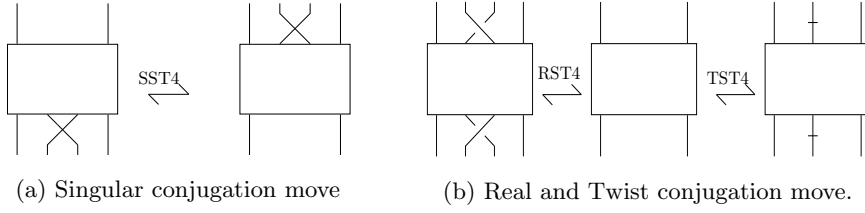

Figure 12: Different types of ST4-move

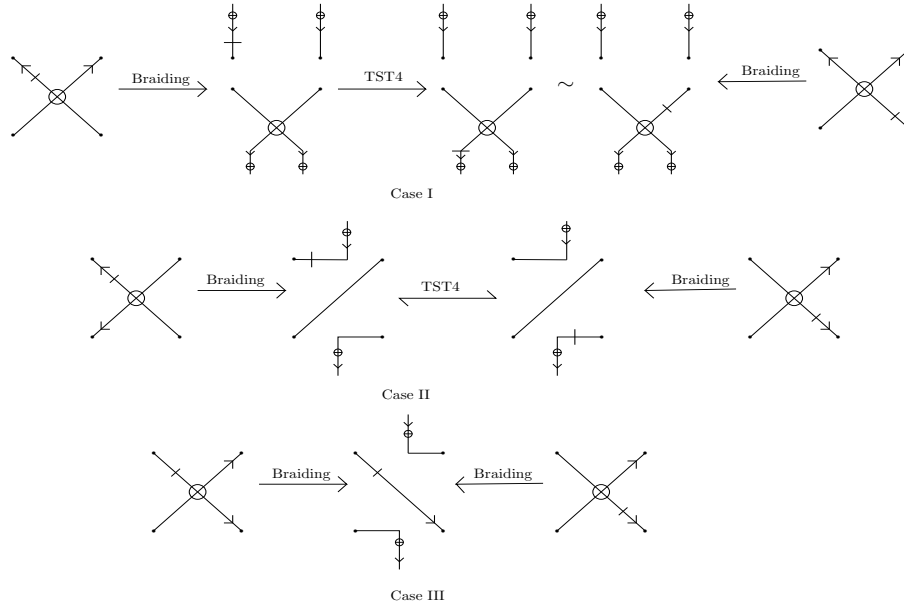

Figure 13: Different cases of T1 move

instances of each isotopy move. If both the strands are in downward direction, then they are related by braid isotopy and braid moves. If at least one strand is oriented upward, then we proceed as follow:

For T1 move and T2 move, all cases are illustrated pictorially in Figure 13 and Figure 14, respectively.

For T3 move, there are four cases. Case I, when both strands are in upward direction, we apply the braiding algorithm on the diagrams on both sides of the move (followed by braiding isotopy), the resulting diagrams are related by ST4-moves as shown in Figure 15. Case II, when one strand is upward and one strand is downward as shown in Figure 16, we apply the braiding algorithm on the diagrams on both sides of the move, the resulting diagrams are related by ST4-move and ST1-move. Case III is a different form of Case I as shown in Figure 17. Case IV is a different form of Case II illustrated in Figure 18. S4 move is same as T3 move.

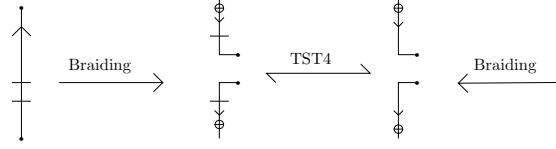

Figure 14: Braiding of T2 move

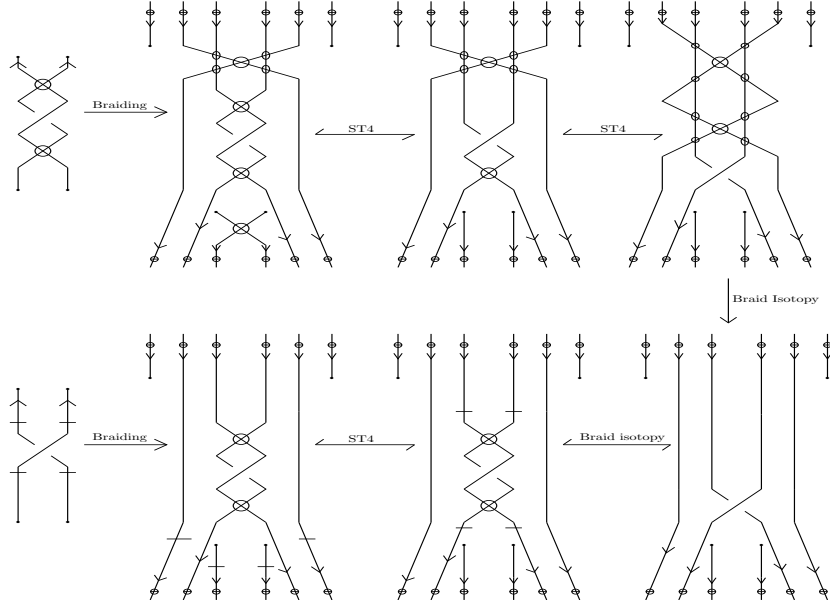

Figure 15: Case I of T3 move

□

Corollary 3.5. *Two twisted virtual braids have isotopic closures if and only if they are twisted L_v -equivalent.*

3.1 Algebraic Markov type theorem for singular twisted virtual braids

Consider a singular twisted virtual braid b of degree n . Define a monomorphism $\iota_s^t : STVB_n \rightarrow STVB_{n+s+t}$, where s and t are non-negative integers such that $\iota_s^t(b)$ is a singular twisted virtual braid of degree $n + s + t$ obtained from b by adding s trivial strands to the left and t trivial strands to the right.

Theorem 3.6. *Two singular twisted virtual braids have isotopic closures if and only if they differ by a finite sequence of braid relations in $STVB_\infty$ together with the following moves.*

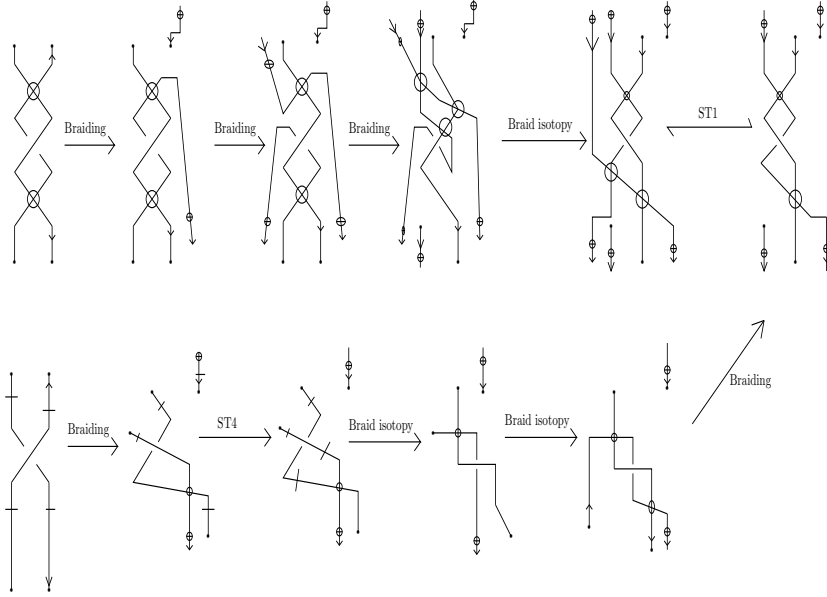

Figure 16: Case II of T3 move

- (i) *Real conjugation*: $\sigma_i^{\pm 1} \alpha \sim \alpha \sigma_i^{\pm 1}$; *virtual conjugation*: $v_i \alpha \sim \alpha v_i$; *singular conjugation*: $\tau_i \alpha \sim \alpha \tau_i$; and *twist conjugation*: $\gamma_i \alpha \sim \alpha \gamma_i$,
- (ii) *Right real and right virtual stabilization*: $\iota_0^1(\alpha) \sigma_n^{\pm 1} \sim \alpha \sim \iota_0^1(\alpha) v_n$,
- (iii) *Right algebraic under-threading*: $\alpha \sim \iota_0^1(\alpha) \sigma_n^{\pm 1} v_{n-1} \sigma_n^{\mp 1}$; and *left algebraic under-threading*: $\alpha \sim \iota_1^0(\alpha) \sigma_1^{\pm 1} v_2 \sigma_1^{\mp 1}$,
- (iv) *Right algebraic rs-threading*: $\iota_0^1(\alpha) \tau_n v_{n-1} \sigma_n^{\pm 1} \sim \iota_0^1(\alpha) \sigma_n^{\pm 1} v_{n-1} \tau_n$; and *left algebraic rs-threading*: $\iota_1^0(\alpha) \tau_1 v_2 \sigma_1^{\pm 1} \sim \iota_1^0(\alpha) \sigma_1^{\pm 1} v_2 \tau_1$.

To prove this theorem it is sufficient to show that each algebraic Markov move can be obtained from a finite sequence of L_v -moves, which has already been proved in [1] except for the twist conjugation. It is easy to observe that the twist conjugation is a part of the L_v -moves.

Corollary 3.7. *Two twisted virtual braids have isotopic closures if and only if they differ by a finite sequence of braid relations in TVB_∞ together with the following moves.*

- (i) *Real conjugation* : $\sigma_i^{\pm 1} \alpha \sim \alpha \sigma_i^{\pm 1}$; *virtual conjugation*: $v_i \alpha \sim \alpha v_i$; and *twist conjugation*: $\gamma_i \alpha \sim \alpha \gamma_i$,
- (ii) *Right real and right virtual stabilization*: $\iota_0^1(\alpha) \sigma_n^{\pm 1} \sim \alpha \sim \iota_0^1(\alpha) v_n$,
- (iii) *Right algebraic under-threading*: $\alpha \sim \iota_0^1(\alpha) \sigma_n^{\mp 1} v_{n-1} \sigma_n^{\pm 1}$ and *left algebraic under-threading*: $\alpha \sim \iota_1^0(\alpha) \sigma_1^{\pm 1} v_2 \sigma_1^{\mp 1}$.

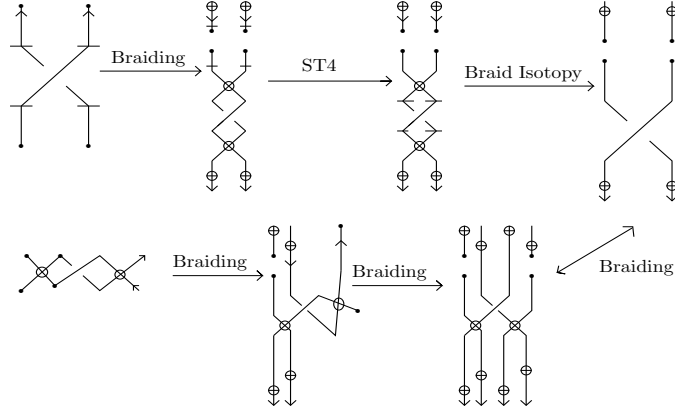

Figure 17: Case III of T3 move

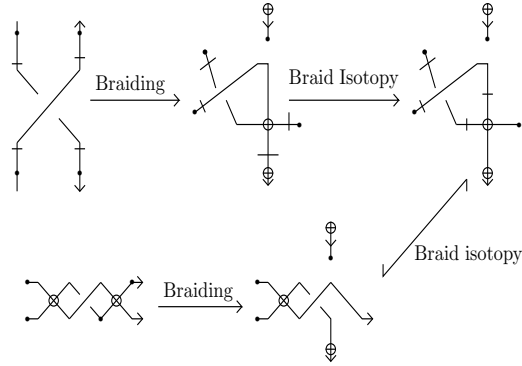

Figure 18: Case IV of T3 move

In the following subsection, we have demonstrated the potential to minimize the number of L_v -moves and algebraic moves in the context of singular twisted virtual braids.

3.2 On threading moves of singular twisted virtual braids

It turns out that if two singular twisted virtual braids are related by a left algebraic under-threading move (left algebraic rs -threading move) then they are related by a sequence of conjugation and a right algebraic under threading move (right algebraic rs -threading move). Similarly, if two singular twisted virtual braids are related by a LST2-move (LST3-move) then they are related by a ST4-move and a RST2-move (RST3-move). Thus we can remove left algebraic under threading move and left algebraic rs -threading move from the definition of Markov equivalence and also we can remove LST2-move and LST3-move from

the definition of L_v equivalence. Details are provided in the following theorems.

Theorem 3.8. *If two twisted virtual braids of degree n are related by a left algebraic under-threading move (left algebraic rs -threading move), then they are related by a sequence of conjugation and a right algebraic under-threading move (right algebraic rs -threading move).*

Proof. Consider a monoid isomorphism $f_n : STVB_n \rightarrow STVB_n$ determined by

$$\begin{aligned} \sigma_i &\mapsto \sigma_{n-i}, & \text{for } i = 1, \dots, n-1 \\ v_i &\mapsto v_{n-i}, & \text{for } i = 1, \dots, n-1 \\ \gamma_i &\mapsto \gamma_{n-i+1}, & \text{for } i = 1, \dots, n \\ \tau_i &\mapsto \tau_{n-i}, & \text{for } i = 1, \dots, n-1. \end{aligned}$$

Where, $f_n(b)$ a singular twisted virtual braid diagram obtained from the diagram b by applying the above correspondence to the expression in terms of the generators.

Let $b^* \in STVB_n$ such that

$$b^* = \prod_{i=1}^{n-1} (v_i v_{i-1} \dots v_1) \prod_{j=1}^n \gamma_j.$$

Define $F_n : STVB_n \rightarrow STVB_n$ such that

$$b \mapsto b^* b b^{*-1} \quad \text{for } b \in STVB_n.$$

It turns out to be a monoid isomorphism. It is easily seen that $b^{*2} = e$ and $F_n(b) = f_n(b)$ for $b \in STVB_n$. In particular b and $f_n(b)$ are related by conjugation.

It is observable that the map f_n , facilitating the transition from the left diagram to the right one (or vice-versa), is indeed a conjugation map F_n . We use this observation to support our assertion. Further elaboration is provided below:

Let α and b_2 be singular twisted virtual braid diagrams related by a left algebraic under-threading move. Suppose that

$$b_1 = \iota_1^0(\alpha) \quad \text{and} \quad b_2 = \alpha \sigma_1 v_2 \sigma_1^{-1}.$$

Then

$$f_{n+1}(b_1) = \iota_0^1(f_n(\alpha)) \quad \text{and} \quad f_{n+1}(b_2) = f_n(\alpha) \sigma_n v_{n-1} \sigma_n^{-1},$$

and hence $f_n(\alpha)$ and $f_{n+1}(b_2)$ are related by a right algebraic under threading move. Since b_1 is conjugate to $f_n(b_1)$ as elements of $STVB_n$ it implies α is conjugate to $f_n(\alpha)$. Also, b_2 is conjugate to $f_{n+1}(b_2)$. Hence, α and b_2 are related by a sequence of conjugation and right algebraic under-threading move.

Now, suppose b_3 and b_4 be singular twisted virtual braid diagrams related by a left algebraic rs -threading move. Suppose that

$$b_3 = \iota_1^0(\alpha) \tau_1 v_2 \sigma_1 \quad \text{and} \quad b_4 = \iota_1^0(\alpha) \sigma_1 v_2 \tau_1.$$

Then

$$f_{n+1}(b_3) = \iota_0^1(f_n(\alpha))\tau_n v_{n-1}\sigma_n \quad \text{and} \quad f_{n+1}(b_4) = \iota_0^1(f_n(\alpha))\sigma_n v_{n-1}\tau_n,$$

and hence $f_{n+1}(b_3)$ and $f_{n+1}(b_4)$ are related by a right algebraic rs -threading move. Therefore, b_3 and b_4 are related by a sequence of conjugation and right algebraic rs -threading move. \square

Theorem 3.9. *Two singular twisted virtual braids have isotopic closures if and only if they differ by a finite sequence of braid relations in $STVB_\infty$ together with the following moves.*

- *Real conjugation: $\sigma_i^{\pm 1}\alpha \sim \alpha\sigma_i^{\pm 1}$; virtual conjugation: $v_i\alpha \sim \alpha v_i$; singular conjugation: $\tau_i\alpha \sim \alpha\tau_i$; and twist conjugation: $\gamma_i\alpha \sim \alpha\gamma_i$,*
- *Right real and right virtual stabilization: $\alpha\sigma_n^{\pm 1} \sim \alpha \sim \alpha v_n$,*
- *Right algebraic under-threading: $\alpha \sim \alpha\sigma_n^{\mp 1}v_{n-1}\sigma_n^{\pm 1}$,*
- *Right algebraic rs -threading: $\alpha\tau_n v_{n-1}\sigma_n^{\pm 1} \sim \alpha\sigma_n^{\pm 1}v_{n-1}\tau_n$.*

Proof. Use Theorem 3.6 and Theorem 3.8. \square

Corollary 3.10. *Two twisted virtual braids have isotopic closures if and only if they differ by a finite sequence of braid relations in TVB_∞ together with the following moves.*

- (i) *Real conjugation: $\sigma_i^{\pm 1}\alpha \sim \alpha\sigma_i^{\pm 1}$; virtual conjugation: $v_i\alpha \sim \alpha v_i$; and twist conjugation: $\gamma_i\alpha \sim \alpha\gamma_i$,*
- (ii) *Right real and right virtual stabilization: $\alpha\sigma_n^{\pm 1} \sim \alpha \sim \alpha v_n$,*
- (iii) *Right algebraic under-threading: $\alpha \sim \alpha\sigma_n^{\mp 1}v_{n-1}\sigma_n^{\pm 1}$.*

Theorem 3.11. *If two singular twisted virtual braids of degree n are related by a LST2-move (LST3-move), then they are related by a sequence of ST4 and RST2-move (RST3-move).*

Proof. In Figure 19, pictorially we have shown that LST2-move can be achieved by RST2-move and ST4-move. Similarly, the LST3-move can be obtained by the RST3-move and ST4-move as shown in Figure 20.

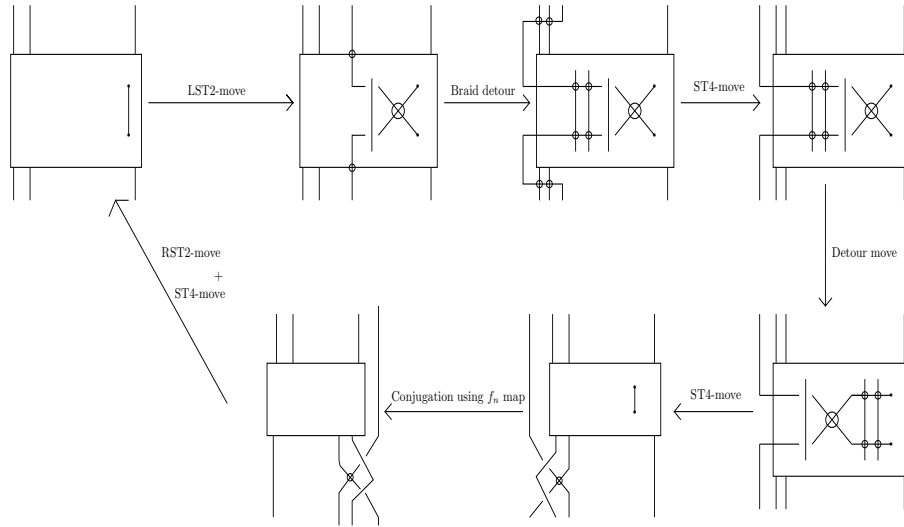

Figure 19: LST2-move using RST2-move and ST4-move

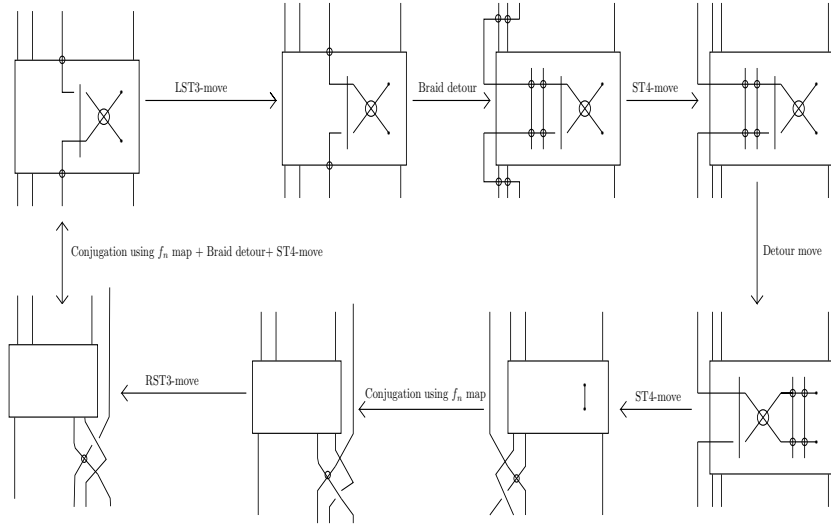

Figure 20: LST3-move using RST3-move and ST4-move

□

Theorem 3.12. *Two singular twisted virtual braids have isotopic closures if and only if they differ by sequence of $ST1$, $RST2$, $RST3$ and $ST4$ moves.*

Proof. Use Definition 3.3 and Theorem 3.11.

□

Corollary 3.13. *Two twisted virtual braids have isotopic closures if and only if they differ by sequence of $ST1$, $RST2$, $RST4$, and $TST4$ moves.*

4 Reduced presentation for singular twisted virtual braid monoid

In this section, we show that the presentation of the singular twisted virtual braid monoid $STVB_n$ given in Theorem 2.9 can be reduced to a presentation with less generators and less relations by rewriting σ_i ($i = 2, \dots, n-1$), τ_i ($i = 2, \dots, n-1$), and γ_i ($i = 2, \dots, n$) in terms of σ_1 , τ_1 , γ_1 and v_1, \dots, v_{n-1} as follows:

$$\sigma_i = (v_{i-1} \dots v_1)(v_i \dots v_2)\sigma_1(v_2 \dots v_i)(v_1 \dots v_{i-1}) \quad \text{for } i = 2, \dots, n-1, \quad (23)$$

$$\tau_i = (v_{i-1} \dots v_1)(v_i \dots v_2)\tau_1(v_2 \dots v_i)(v_1 \dots v_{i-1}) \quad \text{for } i = 2, \dots, n-1, \quad (24)$$

$$\gamma_i = (v_{i-1} \dots v_1)\gamma_1(v_1 \dots v_{i-1}) \quad \text{for } i = 2, \dots, n. \quad (25)$$

These can be seen geometrically from their diagrams shown in Figure 21.

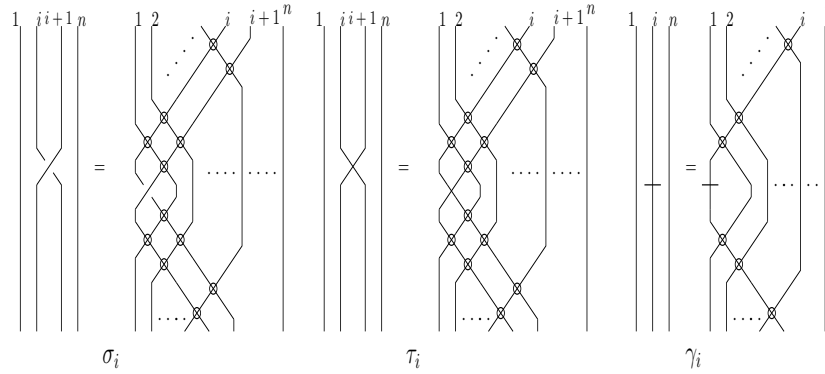

Figure 21: σ_i , τ_i , and γ_i

Many relations are already reduced in [1], [2], and [4].

Theorem 4.1. *The monoid $STVB_n$ has a presentation whose generators are $\sigma_1^{\pm 1}$, τ_1 , γ_1 , v_1, \dots, v_{n-1} and the defining relations are as follows:*

$$v_i^2 = e \quad \text{for } i = 1, \dots, n-1; \quad (26)$$

$$v_i v_j = v_j v_i \quad \text{for } |i-j| > 1; \quad (27)$$

$$v_i v_{i+1} v_i = v_{i+1} v_i v_{i+1} \quad \text{for } i = 1, \dots, n-2; \quad (28)$$

$$\sigma_1(v_2 v_3 v_1 v_2 \sigma_1 v_2 v_1 v_3 v_2) = (v_2 v_3 v_1 v_2 \sigma_1 v_2 v_1 v_3 v_2) \sigma_1, \quad (29)$$

$$(v_1 \sigma_1 v_1)(v_2 \sigma_1 v_2)(v_1 \sigma_1 v_1) = (v_2 \sigma_1 v_2)(v_1 \sigma_1 v_1)(v_2 \sigma_1 v_2), \quad (30)$$

$$\sigma_1 v_j = v_j \sigma_1 \quad \text{for } j = 3, \dots, n-1; \quad (31)$$

$$\gamma_1^2 = e, \quad (32)$$

$$\gamma_1 v_j = v_j \gamma_1 \quad \text{for } j = 2, \dots, n-1; \quad (33)$$

$$\gamma_1 v_1 \gamma_1 v_1 = v_1 \gamma_1 v_1 \gamma_1, \quad (34)$$

$$\gamma_1 v_1 v_2 \sigma_1 v_2 v_1 = v_1 v_2 \sigma_1 v_2 v_1 \gamma_1, \quad (35)$$

$$\gamma_1 v_1 \gamma_1 \sigma_1 \gamma_1 v_1 \gamma_1 = \sigma_1. \quad (36)$$

$$\sigma_1 \sigma_1^{-1} = e \quad (37)$$

$$\sigma_1 \tau_1 = \tau_1 \sigma_1 \quad (38)$$

$$\tau_1 v_i = v_i \tau_1 \quad \text{for } i = 3, \dots, n-1; \quad (39)$$

$$\tau(v_1 v_2 \sigma_1 v_2 v_1) \sigma_1 = (v_1 v_2 \sigma_1 v_2 v_1) \sigma_1 (v_1 v_2 \tau_1 v_2 v_1) \quad (40)$$

$$\tau_1(v_2 v_3 v_1 v_2 \sigma_1 v_2 v_1 v_3 v_2) = (v_2 v_3 v_1 v_2 \sigma_1 v_2 v_1 v_3 v_2) \tau_1 \quad (41)$$

$$\tau_1(v_2 v_3 v_1 v_2 \tau_1 v_2 v_1 v_3 v_2) = (v_2 v_3 v_1 v_2 \tau_1 v_2 v_1 v_3 v_2) \tau_1 \quad (42)$$

$$\gamma_1 v_1 v_2 \tau_1 v_2 v_1 = v_1 v_2 \tau_1 v_2 v_1 \gamma_1, \quad (43)$$

$$\gamma_1 v_1 \gamma_1 \tau_1 \gamma_1 v_1 \gamma_1 = \tau_1. \quad (44)$$

The following lemmas are sufficient for the proof of the Theorem 4.1.

Lemma 4.2. *The braid relation $\tau_i \gamma_j = \gamma_j \tau_i$ follow from the defining relations (24), and (25), the other relations, and the reduced relations $\gamma_1 v_1 v_2 \tau_1 v_2 v_1 = v_1 v_2 \tau_1 v_2 v_1 \gamma_1$ and $\gamma_1 v_j = v_j \gamma_1$, for $j \neq 1$.*

Proof. We can see that the relation (24) is equivalent to the relation

$$\tau_{i+1} = v_i v_{i+1} \tau_i v_{i+1} v_i, \quad \forall 1 \leq i \leq n-1.$$

First we show (21) when $j = 1$, i.e., $\tau_i \gamma_1 = \gamma_1 \tau_i$ for $i \neq 1$. We apply induction on i , with initial condition $i = 2$. Using the relation (24) and (43), the following relation follows:

$$\tau_2 \gamma_1 = \gamma_1 \tau_2 \quad (45)$$

Assuming $\tau_i \gamma_1 = \gamma_1 \tau_i$, we obtain $\tau_{i+1} \gamma_1 = \gamma_1 \tau_{i+1}$ as follows:

$$\begin{aligned}
\tau_{i+1} \gamma_1 &= \underline{v_i v_{i+1} \tau_i v_{i+1} v_i \gamma_1} && \text{(by (33))} \\
&= \underline{v_i v_{i+1} \tau_i v_{i+1} \gamma_1 v_i} && \text{(by (33))} \\
&= \underline{v_i v_{i+1} \tau_i \gamma_1 v_{i+1} v_i} && \text{(by (45))} \\
&= \underline{v_i v_{i+1} \gamma_1 \tau_i v_{i+1} v_i} && \text{(by (33))} \\
&= \underline{v_i \gamma_1 v_{i+1} \tau_i v_{i+1} v_i} && \text{(by (33))} \\
&= \underline{\gamma_1 v_i v_{i+1} \tau_i v_{i+1} v_i} && \text{(by (24))} \\
&= \gamma_1 \tau_{i+1}.
\end{aligned}$$

Hence,

$$\tau_i \gamma_1 = \gamma_1 \tau_i \quad \text{for } i \neq 1. \quad (46)$$

Now, we show relation (21): $\tau_i \gamma_j = \gamma_j \tau_i$ for $j \neq i, i+1$.

Case(i) Suppose $j \leq i-1$. Then

$$\begin{aligned}
\tau_i \gamma_j &= \underline{\tau_i (v_{j-1} \dots v_1) \gamma_1 (v_1 \dots v_{j-1})} && \text{(by (19))} \\
&= \underline{(v_{j-1} \dots v_1) \tau_i \gamma_1 (v_1 \dots v_{j-1})} && \text{(by (46))} \\
&= \underline{(v_{j-1} \dots v_1) \gamma_1 \tau_i (v_1 \dots v_{j-1})} && \text{(by (19))} \\
&= \underline{(v_{j-1} \dots v_1) \gamma_1 (v_1 \dots v_{j-1}) \tau_i} && \text{(by (25))} \\
&= \gamma_j \tau_i.
\end{aligned}$$

Case(ii) Suppose $j \geq i+2$. Then

$$\begin{aligned}
\tau_i \gamma_j &= \underline{\tau_i (v_{j-1} \dots v_1) \gamma_1 (v_1 \dots v_{j-1})} && \text{(by (19))} \\
&= \underline{(v_{j-1} \dots v_{i+2}) \tau_i (v_{i+1} \dots v_1) \gamma_1 (v_1 \dots v_{j-1})} && \text{(by (24))} \\
&= \underline{(v_{j-1} \dots v_{i+2}) v_{i+1} v_i \tau_{i+1} v_i v_{i+1} (v_{i+1} v_i v_{i-1} \dots v_1) \gamma_1 (v_1 \dots v_{j-1})} && \text{(by (26))} \\
&= \underline{(v_{j-1} \dots v_i) \tau_{i+1} (v_{i-1} \dots v_1) \gamma_1 (v_1 \dots v_{j-1})} && \text{(by (19))} \\
&= \underline{(v_{j-1} \dots v_i) (v_{i-1} \dots v_1) \tau_{i+1} \gamma_1 (v_1 \dots v_{j-1})} && \text{(by (46))} \\
&= \underline{(v_{j-1} \dots v_1) \gamma_1 \tau_{i+1} (v_1 \dots v_{j-1})} && \text{(by (19))} \\
&= \underline{(v_{j-1} \dots v_1) \gamma_1 (v_1 \dots v_{i-1}) \tau_{i+1} (v_i \dots v_{j-1})} && \text{(by (24))} \\
&= \underline{(v_{j-1} \dots v_1) \gamma_1 (v_1 \dots v_{i-1}) v_i v_{i+1} \tau_i v_{i+1} v_i (v_i v_{i+1} v_{i+2} \dots v_{j-1})} && \text{(by (26))} \\
&= \underline{(v_{j-1} \dots v_1) \gamma_1 (v_1 \dots v_{i+1}) \tau_i (v_{i+2} \dots v_{j-1})} && \text{(by (24))} \\
&= \underline{(v_{j-1} \dots v_1) \gamma_1 (v_1 \dots v_{i+1}) (v_{i+2} \dots v_{j-1}) \tau_i} && \text{(by (25))} \\
&= \gamma_j \tau_i.
\end{aligned}$$

□

Lemma 4.3. *The braid relation $v_i \sigma_i v_i = \gamma_{i+1} \gamma_i \tau_i \gamma_i \gamma_{i+1}$ follow from the defining relations (24) and (25), the virtual relations, and the reduced relations $\gamma_1 v_1 \gamma_1 \tau_1 \gamma_1 v_1 \gamma_1 = \tau_1$ and $\gamma_1 v_j = v_j \gamma_1$, for $j \neq 1$.*

Proof. For the proof we will use the following relation:

$$(v_1 \dots v_{i-1})v_i(v_{i-1} \dots v_1) = (v_i \dots v_2)v_1(v_2 \dots v_i) \quad (47)$$

$$\begin{aligned} \gamma_{i+1}\gamma_i\tau_i\gamma_i\gamma_{i+1} &= (v_i \dots v_1)\gamma_1(v_1 \dots v_i)(v_{i-1} \dots v_1)\gamma_1(v_1 \dots v_{i-1})(v_{i-1} \dots v_1)(v_i \dots v_2) \\ &\quad \tau_1(v_2 \dots v_i)(v_1 \dots v_{i-1})(v_{i-1} \dots v_1)\gamma_1(v_1 \dots v_{i-1})(v_i \dots v_1)\gamma_1(v_1 \dots v_i) \quad (\text{by (26)}) \\ &= (v_i \dots v_1)\gamma_1(v_1 \dots v_{i-1}v_iv_{i-1} \dots v_1)\gamma_1(v_i \dots v_2)\tau_1(v_2 \dots v_i)\gamma_1 \\ &\quad (v_1 \dots v_{i-1}v_iv_{i-1} \dots v_1)\gamma_1(v_1 \dots v_i) \quad (\text{by (47)}) \\ &= (v_i \dots v_1)\gamma_1(v_i \dots v_2v_1v_2 \dots v_i)\gamma_1(v_i \dots v_2)\tau_1(v_2 \dots v_i)\gamma_1 \\ &\quad (v_i \dots v_2v_1v_2 \dots v_i)\gamma_1(v_1 \dots v_i) \quad (\text{by (33)}) \\ &= (v_i \dots v_1)(v_i \dots v_2)\gamma_1v_1(v_2 \dots v_i)(v_i \dots v_2)\gamma_1\tau_1\gamma_1(v_2 \dots v_i)(v_i \dots v_2) \\ &\quad v_1\gamma_1(v_2 \dots v_i)(v_1 \dots v_i) \quad (\text{by (26)}) \\ &= (v_i \dots v_1)(v_i \dots v_2)\gamma_1v_1\gamma_1\tau_1\gamma_1v_1\gamma_1(v_2 \dots v_i)(v_1 \dots v_i) \quad (\text{by (43)}) \\ &= v_i(v_{i-1} \dots v_1)(v_i \dots v_2)\tau_1(v_2 \dots v_i)(v_1 \dots v_{i-1})v_i \quad (\text{by (24)}) \\ &= v_i\tau_iv_i. \end{aligned}$$

□

5 Concluding remarks

In this paper, we explore singular twisted virtual braids and the associated singular twisted virtual braid monoid. We establish theorems regarding singular twisted links such as the Alexander theorem and the Markov theorem. Additionally, we present a monoid presentation and a reduced monoid presentation for the singular twisted virtual braid monoid. As a potential direction for future research, developing invariants for both singular twisted virtual braids and singular twisted links would be of considerable interest.

Acknowledgements

The first author would like to thank the University Grants Commission(UGC), India, for Research Fellowship with NTA Ref.No.191620008047. The second author acknowledges the support given by the NBHM, Government of India under grant-in-aid with F.No.02011/2/20223NBHM(R.P.)/R&D II/970. This work was partially supported by the FIST program of the Department of Science and Technology, Government of India, Reference No. SR/FST/MS-I/2018/22(C).

References

- [1] C. Caprau, A. Pena, S. McGahan, *Virtual singular braids and links*, *Manuscripta Math.* **151** (2016), no. 1-2, 147–175.

- [2] K. Negi, M. Prabhakar, and S. Kamada, *Twisted virtual braids and twisted links*, arXiv:2302.13244v1.
- [3] L.H. Kauffman and S. Lambropoulou, Virtual braids. *Fund. Math.* **184** (2004), 159–186.
- [4] L.H. Kauffman, S. Lambropoulou, *Virtual braids and the L-move*, *J. Knot Theory Ramif.* **15**(2006), no. 6, 773–811.
- [5] M. O. Bourgoïn, Twisted link theory. *Algebr. Geom. Topol.* **8** (2008), no. 3, 1249–1279.
- [6] N. Kamada and S. Kamada, Virtual links which are equivalent as twisted links, *Proc. Amer. Math. Soc.* **148** (2020), no 5, 2273–2285.
- [7] S. Kamada, Braid presentation of virtual knots and welded knots. *Osaka J. Math.* **44** (2007), no. 2, 441–458.
- [8] V.G. Bardakov, T.A. Kozlovskaya, K. Negi, M. Prabhakar, *Twisted Virtual Braid Group*, arXiv:2310.04154v1.

Department of Mathematics, Indian Institute
of Technology Ropar, Punjab, India.

Email: komal.20maz0004@iitrpr.ac.in, prabhakar@iitrpr.ac.in