

CLONOIDS OF BOOLEAN FUNCTIONS WITH A MONOTONE OR DISCRIMINATOR SOURCE CLONE

ERKKO LEHTONEN

ABSTRACT. Extending Sparks’s theorem, we determine the cardinality of the lattice of (C_1, C_2) -clonoids of Boolean functions in the cases where the target clone C_2 is the clone of projections. Moreover, we explicitly describe the (C_1, C_2) -clonoids of Boolean functions in the cases where the source clone C_1 is one of the four clones of monotone functions or contains the discriminator function.

1. INTRODUCTION

Clones are a fundamental concept in universal algebra. A *clone* is a set of operations on a set A that contains all projections and is closed under composition. Clonoids are a generalization of clones. For fixed clones C_1 (the *source*) and C_2 (the *target*) on sets A and B , respectively, a (C_1, C_2) -*clonoid* is a set of functions of several arguments from A to B that is stable under right composition with C_1 and stable under left composition with C_2 .

Given a function $f: A^n \rightarrow B$, the functions obtained by composing f from the right by projections on B are called *minors* of f . In other words, the minors of f are those functions that are obtained from f by permutation of arguments, introduction or deletion of fictitious arguments, and identification of arguments. Classes of functions that are closed under formation of minors are called *minor-closed classes* or simply *minions*. Clones and clonoids are examples of minions. Minions arise naturally in universal algebra as sets of operations induced by terms of height 1 on an algebra. In the context of constraint satisfaction problems (CSPs), clones and minions have played a significant role in computational complexity analysis and classification (see the survey article by Barto et al. [2]).

Clones, clonoids, minors, and minions have been studied from various perspectives in the past decades. Although the terminology we use here is quite modern, these concepts have been present in the literature much earlier. To the best of the author’s knowledge, the term “clone” first appeared in the 1965 monograph of Cohn [4], who attributed it to Philip Hall, the term “clonoid” was introduced in the 2016 paper by Aichinger and Mayr [1], and “minion” was coined by Opršal around the year 2018 (see [2, Definition 2.20], [3]). As examples of earlier work in which these concepts appear under different names, we would like to highlight Post’s classification of clones on a two-element set [27], the paper of Rosenberg and Szendrei [28] where minors are called “polymers”, and descriptions of minions and (C_1, C_2) -clonoids as sets of polymorphisms of relation pairs, due to Pippenger [26] and Couceiro and Foldes [5, 7]. More recent studies on clonoids include the papers by Fioravanti [9, 10], Kreinecker [13], and Mayr and Wynne [25].

Our specific focus regarding clonoids is on systematically counting and enumerating all (C_1, C_2) -clonoids. An opportune starting point for our investigation was

DEPARTMENT OF MATHEMATICS, KHALIFA UNIVERSITY OF SCIENCE AND TECHNOLOGY, P.O. BOX 127788, ABU DHABI, UNITED ARAB EMIRATES

Date: June 28, 2024.

provided by the following remarkable result by Sparks about the cardinality of the lattice $\mathcal{L}_{(C_1, C_2)}$ of (C_1, C_2) -clonoids, in the cases where C_1 is the clone of projections on a finite set A , denoted by J_A , and C_2 is an arbitrary clone on $\{0, 1\}$.

Theorem 1.1 (Sparks [29, Theorem 1.3]). *Let A be a finite set with $|A| > 1$, and let $B = \{0, 1\}$. Let C be a clone on B . Then the following statements hold.*

- (i) $\mathcal{L}_{(J_A, C)}$ is finite if and only if C contains a near-unanimity operation.
- (ii) $\mathcal{L}_{(J_A, C)}$ is countably infinite if and only if C contains a Mal'cev operation but no majority operation.
- (iii) $\mathcal{L}_{(J_A, C)}$ has the cardinality of the continuum if and only if C contains neither a near-unanimity operation nor a Mal'cev operation.¹

In a series of earlier papers of the author's [8, 18, 19], statements (i) and (ii) of Theorem 1.1 were sharpened and the (C_1, C_2) -clonoids of Boolean functions were described in the cases where the clonoid lattice $\mathcal{L}_{(C_1, C_2)}$ is finite or countably infinite. The (C_1, C_2) -clonoids of Boolean functions were explicitly described in the cases where C_2 contains either a Mal'cev operation [8] or a majority operation [18], i.e., $C_2 \supseteq L_c$ or $C_2 \supseteq SM$, where L_c is the clone of idempotent linear functions, generated by the Mal'cev operation $x_1 + x_2 + x_3$, and SM is the clone of self-dual monotone functions, generated by the majority operation. As for the remaining clones C_1 containing a near-unanimity operations, a description was obtained in terms of ideals of the minorant-minor poset [19]. However, this description is not as explicit as those mentioned above, because the minorant-minor poset is not yet very well understood.

As for statement (iii) of Theorem 1.1, such an explicit description may be unattainable for uncountable clonoid lattices. Even so, the theorem could still be refined in such cases by classifying arbitrary pairs (C_1, C_2) of clones according to whether the clonoid lattice $\mathcal{L}_{(C_1, C_2)}$ is finite, countably infinite, or uncountable; note that in Theorem 1.1, the source clone is always the clone of projections. In this paper, we are going to take a few modest first steps towards this goal.

A starting point is provided by the following theorem that can be derived from results from a series earlier papers of the author's [15, 17, 20, 21, 24]; see Sections 4–7 for details. Note that this is somewhat orthogonal to Sparks's Theorem 1.1; while in Theorem 1.1 the source clone C_1 is always the clone of projections and the target clone C_2 is arbitrary, in the following theorem it is the target clone C_2 that is fixed as the clone of projections and the source clone C_1 is arbitrary.

Theorem 1.2. *Let C be a clone on $\{0, 1\}$, and let J be the clone of projections on $\{0, 1\}$. Then the following statements hold.*

- (i) $\mathcal{L}_{(C, J)}$ is finite if and only if C contains the discriminator function.²
- (ii) $\mathcal{L}_{(C, J)}$ is countably infinite if and only if $\langle \wedge, \vee \rangle \subseteq C \subseteq \langle \wedge, \vee, 0, 1 \rangle$.
- (iii) $\mathcal{L}_{(C, J)}$ has the cardinality of the continuum otherwise.

Proof. This puts together Theorems 5.2, 6.6, and 7.2. □

In this paper, we are going to sharpen statements (i) and (ii) of Theorem 1.2 and find explicit descriptions of the (C_1, C_2) -clonoids when C_1 contains the discriminator function or $\langle \wedge, \vee \rangle \subseteq C \subseteq \langle \wedge, \vee, 0, 1 \rangle$ and C_2 is an arbitrary clone on $\{0, 1\}$.

¹Recall that an operation $f: A^n \rightarrow A$ is a *near-unanimity operation* if it satisfies the identities $f(x, \dots, x, y, x, \dots, x) \approx x$, where the single y on the left side may be at any argument position. A ternary near-unanimity operation is called a *majority operation*. A *Mal'cev operation* is a ternary operation f satisfying $f(x, x, y) \approx f(y, x, x) \approx y$.

²The *discriminator function* on A is the ternary operation t defined by the rule $t(x, y, z) = z$ if $x = y$, and $t(x, y, z) = x$ otherwise.

The paper is organized as follows.

- Section 2: We recall basic notions and some known results from the theory of minors, minions, clones, and clonoids.
- Section 3: We define properties of Boolean functions and introduce notation for certain sets of Boolean functions that we need to present our results.
- Section 4: We review the author's earlier results on a notion called " C -minor", and we explain how such results can be translated to results about (C_1, C_2) -clonoids in cases where the target clone C_2 is the clone J of projections.
- Section 5: Making use of those earlier results on C -minors, we first consider (C_1, C_2) -clonoids in cases where the source clone C_1 does not contain the discriminator function and is not a clone of monotone functions. In such cases we have an uncountable infinitude of (C_1, J) -clonoids, and it might not be possible to explicitly describe them all. It remains out of the scope of the current paper to delve more deeply into this situation.
- Section 6: We describe the (C_1, C_2) -clonoids in cases where the source clone C_1 is a clone of monotone functions. Our key tool is the homomorphism order of k -posets.
- Section 7: We describe the (C_1, C_2) -clonoids in cases where the source clone C_1 contains the discriminator function.
- Section 8: We conclude the paper with a few remarks on directions for further research.

2. PRELIMINARIES

2.1. General. The set of natural numbers is $\mathbb{N} = \{0, 1, 2, \dots\}$, and the set of integers is $\mathbb{Z} = \{\dots, -2, -1, 0, 1, 2, \dots\}$. For $a, b \in \mathbb{Z}$, the *interval* from a to b is $[a, b] := \{n \in \mathbb{Z} \mid a \leq n \leq b\}$. Note that if $a > b$, then $[a, b] = \emptyset$. We also make use of the abbreviated notation $[n] := [1, n] = \{1, 2, \dots, n\}$.

We denote n -tuples by boldface letters and their components with the corresponding italic letters. For example, we may write $\mathbf{a} = (a_1, \dots, a_n)$.

2.2. Quasi-orders, partial orders, lattices, and closure systems. A reflexive and transitive binary relation \leq on a set Q is called a *quasi-order*, and the structure (Q, \leq) is called a *quasi-ordered set* or, briefly, a *qoset*. When there is no risk of confusion, we may refer to the structure (Q, \leq) simply as Q . An antisymmetric quasi-order is called a *partial order*. A structure (P, \leq) , where \leq is a partial order on P , is called a *partially ordered set* or, briefly, a *poset*.

Two elements a and b of a quasi-ordered set Q are *equivalent* if $a \leq b$ and $b \leq a$, and we write $a \equiv b$ to denote this fact. The relation \equiv is indeed an equivalence relation. The quasi-order \leq induces a partial order, also denoted by \leq , on the set Q/\equiv of \equiv -equivalence classes: $a/\equiv \leq b/\equiv$ if and only if $a \leq b$.

Let (Q, \leq) be a quasi-ordered set. A subset D of Q is called a *downset*, or an *initial segment*, if for all $d \in D$ and $q \in Q$, $q \leq d$ implies $q \in D$. For any subset S , the downset generated by S , denoted by $\downarrow S$, is the least downset that includes S , i.e., $\downarrow S = \{q \in Q \mid \exists s \in S \ q \leq s\}$. When S is a singleton $\{a\}$, we write simply $\downarrow a$ for $\downarrow \{a\}$. The notion of *upset* (or *final segment*) is defined dually, and the upset generated by S is denoted by $\uparrow S$.

For subsets $A, B \subseteq Q$, the *interval* between A and B is $[A, B] := \uparrow A \cap \downarrow B = \{x \in Q \mid \exists a \in A \exists b \in B \ (a \leq x \leq b)\}$. Again, if A or B is a singleton, we may simplify the notation and write, for example $[a, b]$ for $[\{a\}, \{b\}]$. Note that this is consistent with the notation for integer intervals introduced in Subsection 2.1; in that case we consider intervals in the poset of integers with their natural order.

An element a of a poset (P, \leq) is the *least element* of P if $a \leq x$ for all $x \in P$, and, dually, a is the *greatest element* of P if $x \leq a$ for all $x \in P$. An element $b \in P$ is an *upper bound* of a subset $S \subseteq P$ if $s \leq b$ for all $s \in S$, and b is a *lower bound* of S if $b \leq s$ for all $s \in S$. A poset P is called a *lattice* if every two-element subset $\{a, b\}$ of P has a least upper bound and a greatest lower bound (i.e., the set of upper bounds of $\{a, b\}$ has a least element and the set of lower bounds of $\{a, b\}$ has a greatest element). A lattice is *complete* if every one of its subsets has a least upper bound and a greatest lower bound.

A collection \mathcal{S} of subsets of a set A is called a *closure system* on A if $A \in \mathcal{S}$ and for all $\mathcal{T} \subseteq \mathcal{S}$, $\bigcap \mathcal{T} \in \mathcal{S}$. The subsets of A belonging to a closure system \mathcal{S} are called the *closed sets* of \mathcal{S} . A function $c: \mathcal{P}(A) \rightarrow \mathcal{P}(A)$ is called a *closure operator* on A if it is *extensive* ($X \subseteq c(X)$), *monotone* ($X \subseteq Y$ implies $c(X) \subseteq c(Y)$) and *idempotent* ($c(c(X)) = c(X)$). The sets of the form $c(X)$ for some $X \subseteq A$ are called the *closed sets* of c . We say that $c(X)$ is the *closure* of X and that X *generates* $c(X)$ or X is a *generating set* of $c(X)$. The closed sets of c form a closure system on A . Conversely, given a closure system \mathcal{S} on A , the mapping $c_{\mathcal{S}}: \mathcal{P}(A) \rightarrow \mathcal{P}(A)$, $c_{\mathcal{S}}(X) = \bigcap \{Y \in \mathcal{S} \mid X \subseteq Y\}$ is a closure operator whose closed sets are precisely the members of \mathcal{S} . A closure system, ordered by subset inclusion, constitutes a complete lattice.

2.3. Function class composition, minors, and minions. Let A and B be sets. A mapping of the form $f: A^n \rightarrow B$ for some $n \in \mathbb{N}_+$ is called a *function of several arguments* from A to B , or, briefly, a *function* from A to B . The number n is called the *arity* of f . When $A = B$, we call such a function an *operation* on A . We denote by $\mathcal{F}_{AB}^{(n)}$ the set of all n -ary functions from A to B , i.e., $\mathcal{F}_{AB} = B^{A^n}$, and we let $\mathcal{F}_{AB} := \bigcup_{n \in \mathbb{N}_+} \mathcal{F}_{AB}^{(n)}$ be the set of all finitary functions from A to B . Similarly, we denote by $\mathcal{O}_A^{(n)}$ the set of all n -ary operations on A , and we let $\mathcal{O}_A := \bigcup_{n \in \mathbb{N}_+} \mathcal{O}_A^{(n)}$. For any set $K \subseteq \mathcal{F}_{AB}$ and $n \in \mathbb{N}_+$, the *n -ary part* of K is $K^{(n)} := K \cap \mathcal{F}_{AB}^{(n)}$.

The i -th n -ary *projection* on A is the operation $\text{pr}_i^{(n)}: A^n \rightarrow A$ defined by $\text{pr}_i^{(n)}(a_1, \dots, a_n) = a_i$. We denote by J_A the set of all projections on A .

Let $f \in \mathcal{F}_{AB}^{(n)}$. The i -th argument is *essential* in f if there exist $a_1, \dots, a_n, a'_i \in A$ such that $f(a_1, \dots, a_{i-1}, a_i, a_{i+1}, \dots, a_n) \neq f(a_1, \dots, a_{i-1}, a'_i, a_{i+1}, \dots, a_n)$. An argument that is not essential is *fictitious*. The number of essential arguments in f is called the *essential arity* of f . We say that a set $F \subseteq \mathcal{F}_{AB}$ of functions is *essentially at most unary* if every member of F is essentially at most unary.

For $f \in \mathcal{F}_{BC}^{(n)}$ (the *outer function*) and $g_1, \dots, g_n \in \mathcal{F}_{AB}^{(m)}$ (the *inner functions*), the composition of f with g_1, \dots, g_n is the function $f(g_1, \dots, g_n) \in \mathcal{F}_{AC}^{(m)}$ defined by the rule $f(g_1, \dots, g_n)(\mathbf{a}) := f(g_1(\mathbf{a}), \dots, g_n(\mathbf{a}))$ for all $\mathbf{a} \in A^m$.

The concept of functional composition can be extended to sets of functions as follows. If $I \subseteq \mathcal{F}_{BC}$ and $J \subseteq \mathcal{F}_{AB}$, then the *composition* of I with J is

$$IJ := \{f(g_1, \dots, g_n) \mid m \in \mathbb{N}_+, n \in \mathbb{N}_+ f \in I^{(n)}, g_1, \dots, g_n \in J^{(m)}\}.$$

Function class composition allows us to define many useful concepts in a compact way. The first such definition is that of minors and minions. For $f \in \mathcal{F}_{AB}^{(m)}$ and $g \in \mathcal{F}_{AB}^{(n)}$, we say that f is a *minor* of g if $f \in \{g\}\text{J}_A$, or, equivalently, if there exists a map $\sigma: [n] \rightarrow [m]$ such that $f = g(\text{pr}_{\sigma(1)}^{(m)}, \dots, \text{pr}_{\sigma(n)}^{(m)})$. In other words, the minors of g are those functions that can be obtained from g by permutation of arguments, introduction or deletion of fictitious arguments, and identification of arguments. We say that a class $K \subseteq \mathcal{F}_{AB}$ is *minor-closed* or that it is a *minion* if $K\text{J}_A \subseteq K$.

Let us review some basic properties of function class composition. Function class composition is monotone, that is, if $I, I' \subseteq \mathcal{F}_{BC}$ and $J, J' \subseteq \mathcal{F}_{AB}$ satisfy $I \subseteq I'$ and

$J \subseteq J'$, then $IJ \subseteq I'J'$. Function class composition is not associative. Associativity nevertheless holds for triples satisfying special conditions.

Lemma 2.1 (Couceiro, Foldes [6, 7, Associativity Lemma]). *Let A, B, C , and D be arbitrary nonempty sets, and let $I \subseteq \mathcal{F}_{CD}$, $J \subseteq \mathcal{F}_{BC}$, $K \subseteq \mathcal{F}_{AB}$. Then the following statements hold.*

- (i) $(IJ)K \subseteq I(JK)$.
- (ii) *If J is minor-closed, then $(IJ)K = I(JK)$.*

Lemma 2.2 (Unary Associativity Lemma). *Let A, B, C , and D be arbitrary nonempty sets, and let $I \subseteq \mathcal{F}_{CD}$, $J \subseteq \mathcal{F}_{BC}$, $K \subseteq \mathcal{F}_{AB}$. If I is essentially at most unary and contains the unary minors of its members, then $(IJ)K = I(JK)$.*

Proof. By Lemma 2.1, $(IJ)K \subseteq I(JK)$, so it remains to show that $I(JK) \subseteq (IJ)K$. Let $f \in I(JK)$. Then $f = \varphi(\gamma_1, \dots, \gamma_n)$ for some $\varphi \in I$ and $\gamma_1, \dots, \gamma_n \in JK$. Because φ is essentially at most unary, $\varphi = \varphi' \circ \text{pr}_i^{(n)}$ for some $i \in [n]$ and for the unary minor $\varphi' := \varphi(\text{pr}_1^{(1)}, \dots, \text{pr}_1^{(1)})$ of φ ; note that $\varphi' \in I$ because I contains the unary minors of its members. Thus $f = (\varphi' \circ \text{pr}_i^{(n)})(\gamma_1, \dots, \gamma_n) = \varphi' \circ (\text{pr}_i^{(n)}(\gamma_1, \dots, \gamma_n)) = \varphi' \circ \gamma_i$. Because $\gamma_i \in JK$, we have $\gamma_i = \lambda(\kappa_1, \dots, \kappa_m)$ for some $\lambda \in J$ and $\kappa_1, \dots, \kappa_m \in K$, so

$$f = \varphi'(\lambda(\kappa_1, \dots, \kappa_m)) = (\varphi' \circ \lambda)(\kappa_1, \dots, \kappa_m) \in (IJ)K. \quad \square$$

Function class composition is right-distributive over arbitrary unions. Left-distributivity does not hold in general (not even for finite unions), but we would like to highlight a particular case where left-distributivity still holds.

Lemma 2.3. *Let A, B , and C be arbitrary nonempty sets.*

- (i) *Let $F_i \subseteq \mathcal{F}_{BC}$ ($i \in I$) and $G \subseteq \mathcal{F}_{AB}$. Then $(\bigcup_{i \in I} F_i)G = \bigcup_{i \in I} (F_i G)$.*
- (ii) *Let $F \subseteq \mathcal{F}_{BC}$ and $G_j \subseteq \mathcal{F}_{AB}$ ($j \in J$). If F is essentially at most unary, then $F(\bigcup_{j \in J} G_j) = \bigcup_{j \in J} (F G_j)$.*

Proof. (i) By the monotonicity of function class composition, we have $\bigcup_{i \in I} (F_i G) \subseteq \bigcup_{i \in I} ((\bigcup_{j \in I} F_j)G) = (\bigcup_{j \in I} F_j)G = (\bigcup_{i \in I} F_i)G$. In order to prove the converse inclusion, let $f \in (\bigcup_{i \in I} F_i)G$. Then $f = \varphi(\gamma_1, \dots, \gamma_n)$ for some $\varphi \in \bigcup_{i \in I} F_i$ and $\gamma_1, \dots, \gamma_n \in G$. Then $\varphi \in F_j$ for some $j \in I$, and it follows that $f \in F_j G$; thus $f \in \bigcup_{i \in I} (F_i G)$.

(ii) By the monotonicity of function class composition, we have $\bigcup_{i \in I} (F G_i) \subseteq \bigcup_{i \in I} (F(\bigcup_{j \in I} G_j)) = F(\bigcup_{j \in I} G_j) = F(\bigcup_{i \in I} G_i)$. In order to prove the converse inclusion, let $f \in F(\bigcup_{i \in I} G_i)$. Then $f = \varphi(\gamma_1, \dots, \gamma_n)$ for some $\varphi \in F$ and $\gamma_1, \dots, \gamma_n \in \bigcup_{i \in I} G_i$. Because φ is essentially at most unary, we have $\varphi = \varphi' \circ \text{pr}_j^{(n)}$ for some $j \in [n]$ and $\varphi' = \varphi(\text{pr}_1^{(1)}, \dots, \text{pr}_1^{(1)})$. Then

$$\begin{aligned} f &= \varphi(\gamma_1, \dots, \gamma_n) = (\varphi' \circ \text{pr}_j^{(n)})(\gamma_1, \dots, \gamma_n) = \varphi'(\text{pr}_j^{(n)}(\gamma_1, \dots, \gamma_n)) = \varphi'(\gamma_j) \\ &= \varphi'(\text{pr}_j^{(n)}(\gamma_j, \dots, \gamma_j)) = (\varphi' \circ \text{pr}_j^{(n)})(\gamma_j, \dots, \gamma_j) = \varphi(\gamma_j, \dots, \gamma_j) \in F G_k \end{aligned}$$

for some $k \in I$. Consequently, $f \in \bigcup_{i \in I} (F G_i)$. \square

2.4. Clones. A set of operations on A is a *clone* on A if it contains all projections and is closed under composition. In symbols, $C \subseteq \mathcal{O}_A$ is a *clone* on A if $J_A \subseteq C$ and $CC \subseteq C$.

The clones on A constitute a closure system on \mathcal{O}_A . For $F \subseteq \mathcal{O}_A$, we denote by $\langle F \rangle$ the clone generated by F , i.e., the smallest clone on A that includes F .

The main open problem in clone theory is to characterize all clones. The situation is entirely trivial on a one-element base set; there is just one such clone, the clone of

all operations. The clones on a two-element set are well known. There are countably infinitely many such clones, and they were characterized by Post [27]; see Section 3, Figure 3.2. It is known that on finite sets with at least three elements, there are an uncountably infinite of clones, but a complete description eludes us.

2.5. Clonoids. Let C_1 and C_2 be clones on sets A and B , respectively. A set $K \subseteq \mathcal{F}_{AB}$ is *stable under right composition* with C_1 if $KC_1 \subseteq K$, and K is *stable under left composition* with C_2 if $C_2K \subseteq K$. We say that K is (C_1, C_2) -*stable* or that K is a (C_1, C_2) -*clonoid* if K is stable under right composition with C_1 and stable under left composition with C_2 . We refer to C_1 and C_2 as the *source clone* and the *target clone* of K , respectively. We denote by $\mathcal{L}_{(C_1, C_2)}$ the set of all (C_1, C_2) -clonoids.

For fixed source and target clones C_1 and C_2 , the (C_1, C_2) -clonoids constitute a closure system on \mathcal{F}_{AB} . For $F \subseteq \mathcal{F}_{AB}$, we denote by $\langle F \rangle_{(C_1, C_2)}$ the (C_1, C_2) -clonoid generated by F , i.e., the smallest (C_1, C_2) -clonoid that includes F .

Lemma 2.4 ([18, Lemma 2.5]). *Let $F \subseteq \mathcal{F}_{AB}$, and let C_1 and C_2 be clones on A and B , respectively. Then $\langle F \rangle_{(C_1, C_2)} = C_2(FC_1)$.*

The monotonicity of function class composition gives the following relationship between clonoids when we have an inclusion between source clones and between target clones.

Lemma 2.5 ([8, Lemma 2.16]). *Let C_1 and C'_1 be clones on A and C_2 and C'_2 clones on B such that $C_1 \subseteq C'_1$ and $C_2 \subseteq C'_2$. Then every (C'_1, C'_2) -clonoid is a (C_1, C_2) -clonoid.*

Moreover, for every minion K , there are largest clones with which K is stable under left and right composition.

Lemma 2.6 ([18, Proposition 2.8]). *For any minion $K \subseteq \mathcal{F}_{AB}$, there exist clones C_A^K on A and C_B^K on B such that for all clones C_1 on A and C_2 on B , it holds that K is (C_1, C_2) -stable if and only if $C_1 \subseteq C_A^K$ and $C_2 \subseteq C_B^K$.*

The union of (C_1, C_2) -clonoids is not in general a (C_1, C_2) -clonoid. However, if the target clone is essentially at most unary, then $\mathcal{L}_{(C_1, C_2)}$ is closed under unions.

Lemma 2.7. *Let $F, G \subseteq \mathcal{F}_{AB}$, and let C_1 and C_2 be clones on A and B , respectively. If C_2 is essentially at most unary, then $\langle F \cup G \rangle_{(C_1, C_2)} = \langle F \rangle_{(C_1, C_2)} \cup \langle G \rangle_{(C_1, C_2)}$.*

Proof. By Lemma 2.4, we have

$$\begin{aligned} \langle F \cup G \rangle_{(C_1, C_2)} &= C_2((F \cup G)C_1) = C_2(FC_1 \cup GC_1) \\ &= C_2(FC_1) \cup C_2(GC_1) = \langle F \rangle_{(C_1, C_2)} \cup \langle G \rangle_{(C_1, C_2)}, \end{aligned}$$

where the second and the third equalities hold by Lemma 2.3, statements (i) and (ii), respectively. \square

In order to test stability under left or right composition with a clone, we only need to consider a generating set of that clone. For this, we need to use the binary composition operation $*$ on \mathcal{O}_A that is defined as follows. For $f \in \mathcal{O}_A^{(m)}$ and $g \in \mathcal{O}_A^{(n)}$, $f * g \in \mathcal{O}_A^{(m+n-1)}$ is defined by the rule

$$(f * g)(a_1, \dots, a_{m+n-1}) = f(g(a_1, \dots, a_n), a_{n+1}, \dots, a_{m+n-1}).$$

Lemma 2.8 ([8, Lemma 3.2]). *Let $F \subseteq \mathcal{O}_A$. Let C be a clone on A , and let G be a generating set of C . Then the following conditions are equivalent.*

- (i) $FC \subseteq F$.

- (ii) F is minor-closed and $f * g \in F$ whenever $f \in F$ and $g \in C$.
- (iii) F is minor-closed and $f * g \in F$ whenever $f \in F$ and $g \in G$.

Lemma 2.9 ([8, Lemma 3.3]). *Let $F \subseteq \mathcal{O}_A$. Let C be a clone on A , and let G be a generating set of C . Then the following conditions are equivalent.*

- (i) $CF \subseteq F$.
- (ii) $g(f_1, \dots, f_n) \in F$ whenever $g \in C^{(n)}$ and $f_1, \dots, f_n \in F^{(m)}$ for some $n, m \in \mathbb{N}$.
- (iii) $g(f_1, \dots, f_n) \in F$ whenever $g \in G^{(n)}$ and $f_1, \dots, f_n \in F^{(m)}$ for some $n, m \in \mathbb{N}$.

For $c \in B$, let C_c^{AB} be the set of all constant functions in \mathcal{F}_{AB} taking value c . For a subset $S \subseteq A$, let $C_S^c = \bigcup_{c \in S} C_c^{AB}$. If $A = B$, we write simply C_c^A and C_S^A for C_c^{AA} and C_S^{AA} , respectively, or we may simply omit the superscripts if the sets A and B are clear from the context.

Lemma 2.10. *Let C_1 and C_2 be clones on A and B , respectively, and let $S \subseteq B$. Assume that $C_2 \cup C_S^B$ is a clone on B .*

- (i) *If $F \subseteq \mathcal{F}_{AB}$ is a (C_1, C_2) -clonoid, then $F \cup C_S^{AB}$ is a $(C_1, C_2 \cup C_S^B)$ -clonoid.*
- (ii) *The nonempty $(C_1, C_2 \cup C_S^B)$ -clonoids are precisely the (C_1, C_2) -clonoids K satisfying $C_S^{AB} \subseteq K$.*

Proof. (i) Because F is a (C_1, C_2) -clonoid, we have $F = \langle (C_1, C_2) \rangle = C_2(FC_1)$. Note also that, because C_2 and $C_2 \cup C_S^B$ are assumed to be clones on B , it holds that

$$(1) \quad C_2(J_B \cup C_S^B) \subseteq (C_2 \cup C_S^B)(C_2 \cup C_S^B) \subseteq C_2 \cup C_S^B.$$

By applying Lemmata 2.1 and 2.3, we get

$$\begin{aligned} F \cup C_S^{AB} &\subseteq J_B((F \cup C_S^{AB})J_A) \subseteq (C_2 \cup C_S^B)((F \cup C_S^{AB})C_1) \\ &\stackrel{2.3}{=} C_2(FC_1 \cup C_S^{AB}C_1) \cup C_S^B((F \cup C_S^{AB})C_1) = C_2(FC_1 \cup C_S^{AB}) \cup C_S^{AB} \\ &= C_2(J_B(FC_1) \cup C_S^B(FC_1)) \cup C_S^{AB} \stackrel{2.3}{=} C_2((J_B \cup C_S^B)(FC_1)) \cup C_S^{AB} \\ &\stackrel{2.1}{=} (C_2(J_B \cup C_S^B))(FC_1) \cup C_S^{AB} \stackrel{(1)}{\subseteq} (C_2 \cup C_S^B)(FC_1) \cup C_S^{AB} \\ &\stackrel{2.3}{=} (C_2(FC_1) \cup C_S^B(FC_1)) \cup C_S^{AB} = (F \cup C_S^{AB}) \cup C_S^{AB} = F \cup C_S^{AB}. \end{aligned}$$

This shows that $(C_2 \cup C_S^B)((F \cup C_S^{AB})C_1) = F \cup C_S^{AB}$, i.e., $F \cup C_S^{AB}$ is a $(C_1, C_2 \cup C_S^B)$ -clonoid.

(ii) If K is a (C_1, C_2) -clonoid satisfying $C_S^{AB} \subseteq K$, then, by (i), $K \cup C_S^{AB} = K$ is a $(C_1, C_2 \cup C_S^B)$ -clonoid.

Assume now that K is a nonempty $(C_1, C_2 \cup C_S^B)$ -clonoid. Then

$$K \supseteq (C_2 \cup C_S^B)K = C_2K \cup C_S^B K = C_2K \cup C_S^{AB} = K \cup C_S^{AB} \supseteq K,$$

so $K = K \cup C_S^{AB}$, which is equivalent to $C_S^{AB} \subseteq K$. \square

3. CLASSES OF BOOLEAN FUNCTIONS

Operations on $\{0, 1\}$ are called *Boolean functions*. In this section, we are going to define properties of Boolean functions and introduce notation for the clones and other classes of Boolean functions that are relevant to our work.

We are going to make use of some well-known Boolean functions that are defined by the operation tables in Figure 3.1: the constant functions 0 and 1, identity id , negation \neg , conjunction \wedge , disjunction \vee , addition $+$, implication \rightarrow , biconditional \leftrightarrow , majority μ , triple sum $+_3$. We also need the function $\vee\wedge: \{0, 1\}^3 \rightarrow \{0, 1\}$,

x_1	0	1	id	\neg
0	0	1	0	1
1	0	1	1	0

x_1	x_2	\wedge	\vee	$+$	\rightarrow	\leftrightarrow
0	0	0	0	0	1	1
0	1	0	1	1	1	0
1	0	0	1	1	0	0
1	1	1	1	0	1	1

x_1	x_2	x_3	μ	$+_3$	\vee
0	0	0	0	0	0
0	0	1	0	1	0
0	1	0	0	1	0
0	1	1	1	0	1
1	0	0	0	1	1
1	0	1	1	0	1
1	1	1	1	1	1

FIGURE 3.1. Some Boolean functions, some of which well known.

$\vee(a_1, a_2, a_3) = a_1 \vee (a_2 \wedge a_3)$, as well as the *threshold functions* $\text{th}_k^n: \{0, 1\}^n \rightarrow \{0, 1\}$,

$$\text{th}_k^n(\mathbf{a}) = \begin{cases} 1, & \text{if } |\{i \mid a_i = 1\}| \geq k, \\ 0, & \text{otherwise.} \end{cases}$$

The set of all Boolean functions is denoted by Ω .

For any set $K \subseteq \Omega$ and $a, b \in \{0, 1\}$, we let

$$K_{a*} := \{f \in K \mid f(\mathbf{0}) = a\},$$

$$K_{*b} := \{f \in K \mid f(\mathbf{1}) = b\},$$

$$K_{ab} := K_{a*} \cap K_{*b}.$$

We introduce some shorthands:

$$\Omega_{=} := \{f \in \Omega \mid f(\mathbf{0}) = f(\mathbf{1})\} = \Omega_{00} \cup \Omega_{11},$$

$$\Omega_{\neq} := \{f \in \Omega \mid f(\mathbf{0}) \neq f(\mathbf{1})\} = \Omega_{01} \cup \Omega_{10},$$

$$\Omega_{\leq} := \{f \in \Omega \mid f(\mathbf{0}) \leq f(\mathbf{1})\} = \Omega_{00} \cup \Omega_{01} \cup \Omega_{11},$$

$$\Omega_{\geq} := \{f \in \Omega \mid f(\mathbf{0}) \geq f(\mathbf{1})\} = \Omega_{00} \cup \Omega_{10} \cup \Omega_{11},$$

$$\Omega_{\neq,00} := \Omega_{01} \cup \Omega_{10} \cup \Omega_{00},$$

$$\Omega_{\neq,11} := \Omega_{01} \cup \Omega_{10} \cup \Omega_{11}.$$

For $a \in \{0, 1\}$, we often write \bar{a} for $\neg(a)$, i.e., $\bar{0} = 1$ and $\bar{1} = 0$. We extend this to tuples: for $\mathbf{a} = (a_1, \dots, a_n) \in \{0, 1\}^n$, we write $\bar{\mathbf{a}}$ for $(\bar{a}_1, \dots, \bar{a}_n)$. For any $K \subseteq \Omega$, let $\bar{K} := \{\neg\}K = \{\neg(f) \mid f \in K\}$.

Let \mathbf{C} be the set of all constant functions, and for $a \in \{0, 1\}$, let \mathbf{C}_a be the set of all constant functions taking value a . Let \mathbf{J} be the set of all projections, and let

$$\mathbf{l}_0 := \mathbf{J} \cup \mathbf{C}_0, \quad \mathbf{l}_1 := \mathbf{J} \cup \mathbf{C}_1, \quad \mathbf{l} := \mathbf{J} \cup \mathbf{C}, \quad \mathbf{l}^* := \mathbf{J} \cup \bar{\mathbf{J}}, \quad \Omega(1) := \mathbf{l}^* \cup \mathbf{C}.$$

A Boolean function $f: \{0, 1\}^n \rightarrow \{0, 1\}$ is *monotone* if $f(\mathbf{a}) \leq f(\mathbf{b})$ whenever $\mathbf{a} \leq \mathbf{b}$. We denote by \mathbf{M} the set of all monotone functions.

We denote by \mathbf{L} the polynomial operations of the group $(\{0, 1\}, +)$, by \mathbf{V} the polynomial operations of the join-semilattice $(\{0, 1\}, \vee)$, and by $\mathbf{\Lambda}$ the polynomial operations of the meet-semilattice $(\{0, 1\}, \wedge)$.

The *dual* of a Boolean function $f: \{0, 1\}^n \rightarrow \{0, 1\}$ is $f^d: \{0, 1\}^n \rightarrow \{0, 1\}$ defined by $f^d(\mathbf{a}) = \neg(f(\neg(a_1), \dots, \neg(a_n)))$. The *dual* of a set $F \subseteq \Omega$ is $F^d := \{f^d \mid f \in F\}$. The dual of a clone is a clone. If K is a (C_1, C_2) -clonoid, then K^d is a (C_1^d, C_2^d) -clonoid.

A Boolean function $f: \{0, 1\}^n \rightarrow \{0, 1\}$ is *self-dual* if $f = f^d$, or, equivalently, if for all $\mathbf{a} \in \{0, 1\}^n$, $f(\mathbf{a}) \neq f(\bar{\mathbf{a}})$. We denote by \mathbf{S} the set of all self-dual functions. Let $\mathbf{SM} := \mathbf{S} \cap \mathbf{M}$, the set of all self-dual monotone functions, and let $\mathbf{LS} := \mathbf{L} \cap \mathbf{S}$, the set of all self-dual linear functions.

Let $f, g: \{0, 1\}^n \rightarrow \{0, 1\}$. If $f(\mathbf{a}) \leq g(\mathbf{a})$ for all $\mathbf{a} \in \{0, 1\}^n$, we say that f is a *minorant* of g or that g is a *majorant* of f . We denote by S^- the set of all minorants of self-dual functions and by S^+ the set of all majorants of self-dual functions.

A Boolean function $f: \{0, 1\}^n \rightarrow \{0, 1\}$ is *reflexive* if for all $\mathbf{a} \in \{0, 1\}^n$, $f(\mathbf{a}) = f(\bar{\mathbf{a}})$. We denote by R the set of all reflexive functions.

For $a \in \{0, 1\}$, a set $S \subseteq \{0, 1\}^n$ is *a-separating* if there is an index $i \in [n]$ such that for every $(a_1, \dots, a_n) \in S$ we have $a_i = a$. In other words, S is 0-separating if $\bigvee S \neq \mathbf{1}$, and S is 1-separating if $\bigwedge S \neq \mathbf{0}$. For $m \geq 2$, a function $f: \{0, 1\}^n \rightarrow \{0, 1\}$ is *a-separating of rank m* if every subset of $f^{-1}(a)$ of cardinality at most m is a-separating. A function f is *a-separating* if $f^{-1}(a)$ is a-separating. We denote by W^m and U^m the sets of 0- and 1-separating functions of rank m , respectively, and by W^∞ and U^∞ the sets of 0- and 1-separating functions, respectively. For $2 \leq m \leq \infty$, let $MW^m := M \cap W^m$ and $MU^m := M \cap U^m$.

The clones on $\{0, 1\}$ were described by Post [27]. The lattice of clones of Boolean functions, also known as *Post's lattice*, is presented in Figure 3.2. Many (but not all) of the classes of Boolean functions defined above are clones. In what follows, we make use of the following generating sets for some of the clones:

$$\begin{aligned} \langle 0 \rangle &= C_0, & \langle 1 \rangle &= C_1, & \langle 0, 1 \rangle &= C, & \langle \neg \rangle &= I^*, \\ \langle \vee \rangle &= V_{01}, & \langle \vee, 0 \rangle &= V_{0*}, & \langle \vee, 1 \rangle &= V_{*1}, & \langle \vee, 0, 1 \rangle &= V, \\ \langle \vee, \wedge \rangle &= M_{01}, & \langle \vee, \wedge, 0 \rangle &= M_{0*}, & \langle \vee, \wedge, 1 \rangle &= M_{*1}, & \langle \vee, \wedge, 0, 1 \rangle &= M, \\ \langle +_3 \rangle &= L_c, & \langle \rightarrow, \text{th}_2^4 \rangle &= W^3, & \langle \mu, \vee \rangle &= MW_{01}^2, & \langle \vee \rangle &= MW_{01}^\infty. \end{aligned}$$

We conclude this section with some auxiliary results.

Lemma 3.1. *For all $f \in \Omega$ and $g \in S^+$ of the same arity, we have $f \vee g \in S^+$.*

Proof. Let $\mathbf{a} \in \{0, 1\}^n$. Because $g \in S^+$, we have $g(\mathbf{a}) \vee g(\bar{\mathbf{a}}) = 1$. Then

$$\begin{aligned} (f \vee g)(\mathbf{a}) \vee (f \vee g)(\bar{\mathbf{a}}) &= (f(\mathbf{a}) \vee g(\mathbf{a})) \vee (f(\bar{\mathbf{a}}) \vee g(\bar{\mathbf{a}})) \\ &= (f(\mathbf{a}) \vee f(\bar{\mathbf{a}})) \vee (g(\mathbf{a}) \vee g(\bar{\mathbf{a}})) = (f(\mathbf{a}) \vee f(\bar{\mathbf{a}})) \vee 1 = 1, \end{aligned}$$

which shows that $f \vee g \in S^+$. \square

Lemma 3.2. *Let C be a clone on $\{0, 1\}$, and let K be a (C, J) -clonoid. Then the following statements hold.*

- (i) \bar{K} is a (C, J) -clonoid.
- (ii) $K \cup C_0$ is a (C, I_0) -clonoid.
- (iii) $K \cup C_1$ is a (C, I_1) -clonoid.
- (iv) $K \cup C$ is a (C, I) -clonoid.
- (v) $K \cup \bar{K}$ is a (C, I^*) -clonoid.
- (vi) $K \cup \bar{K} \cup C$ is a $(C, \Omega(1))$ -clonoid.

Proof. Because K is a (C, J) -clonoid, it holds that

$$(2) \quad K = J(KC) = KC.$$

(i) By making use of the Unary Associativity Lemma (Lemma 2.2), we get $\bar{K} = \{\neg\}K = \{\neg\}(KC) \stackrel{2,2}{=} (\{\neg\}K)C = \bar{K}C = J(\bar{K}C)$. Therefore, \bar{K} is a (C, J) -clonoid.

(ii) We have

$$\begin{aligned} I_0((K \cup C_0)C) &= (J \cup C_0)((K \cup C_0)C) \stackrel{2,3}{=} J((K \cup C_0)C) \cup \underbrace{C_0((K \cup C_0)C)}_{=C_0} \\ &= (K \cup C_0)C \cup C_0 \stackrel{2,3}{=} (KC \cup C_0C) \cup C_0 \stackrel{(2)}{=} (K \cup C_0) \cup C_0 = K \cup C_0. \end{aligned}$$

Therefore $K \cup C_0$ is a (C, I_0) -clonoid.

(iii) The proof is analogous to part (ii).

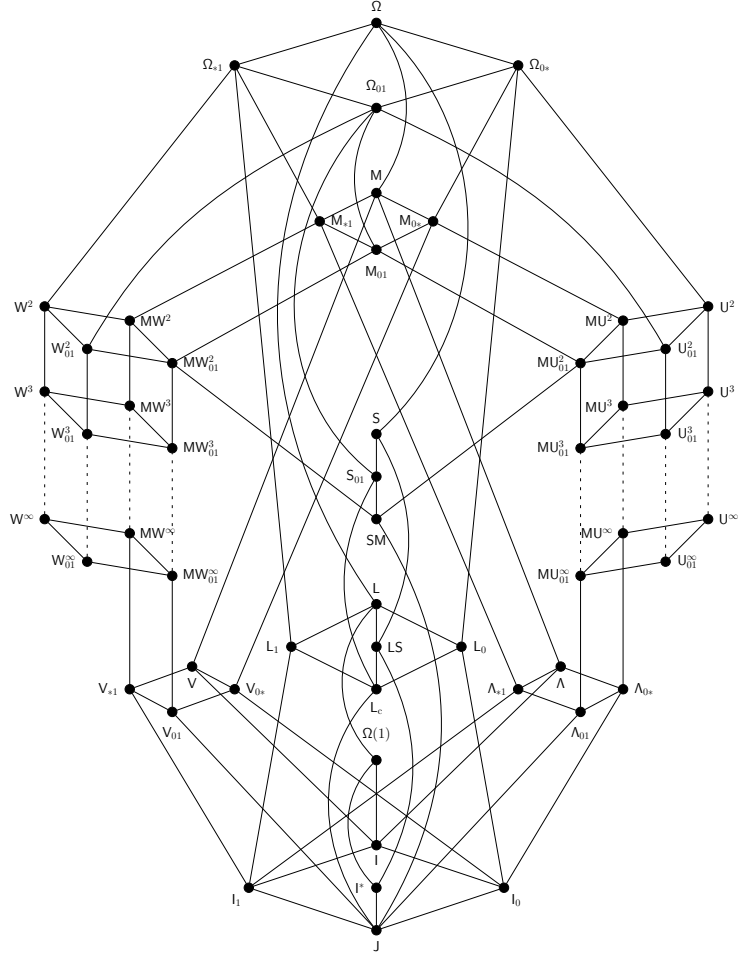

FIGURE 3.2. Post's lattice.

(iv) We have

$$\begin{aligned} I((K \cup C)C) &= (J \cup C)((K \cup C)C) \stackrel{2,3}{=} J((K \cup C)C) \cup C((K \cup C)C) \\ &= (K \cup C)C \cup C \stackrel{2,3}{=} (KC \cup CC) \cup C = (K \cup C) \cup C = K \cup C. \end{aligned}$$

Therefore $K \cup C$ is a (C, I) -clonoid.

(v) We have

$$\begin{aligned} I^*((K \cup \bar{K})C) &= (J \cup \bar{J})((K \cup \bar{K})C) = I((K \cup \bar{K})C) \cup \{\neg\}I((K \cup \bar{K})C) \\ &\stackrel{2,2}{=} I((K \cup \bar{K})C) \cup \{\neg\}I((K \cup \bar{K})C) = (KC \cup \bar{K}C) \cup \{\neg\}(KC \cup \bar{K}C) \\ &\stackrel{(i)}{=} (K \cup \bar{K}) \cup \{\neg\}(K \cup \bar{K}) = (K \cup \bar{K}) \cup (\bar{K} \cup \bar{\bar{K}}) = K \cup \bar{K}. \end{aligned}$$

Therefore $K \cup \bar{K}$ is a (C, I^*) -clonoid.

(vi) We have

$$\begin{aligned}
\Omega(1)((K \cup \overline{K} \cup C)C) &= (I^* \cup C)((K \cup \overline{K} \cup C)C) \\
&= I^*((K \cup \overline{K} \cup C)C) \cup C((K \cup \overline{K} \cup C)C) = I^*((K \cup \overline{K} \cup C)C) \cup C \\
&\stackrel{2,3}{=} I^*((K \cup \overline{K})C \cup CC) \cup C \stackrel{2,3}{=} I^*((K \cup \overline{K})C) \cup I^*(CC) \cup C \\
&\stackrel{(v)}{=} (K \cup \overline{K}) \cup I^*(CC) \cup C = (K \cup \overline{K}) \cup I^*C \cup C = (K \cup \overline{K}) \cup C \cup C \\
&= K \cup \overline{K} \cup C.
\end{aligned}$$

Therefore $K \cup \overline{K} \cup C$ is a $(C, \Omega(1))$ -clonoid. \square

Lemma 3.3. *Let C be a clone on $\{0, 1\}$. The (C, I^*) -clonoids are precisely the (C, J) -clonoids K satisfying $K = \overline{K}$.*

Proof. If K is a (C, J) -clonoid satisfying $K = \overline{K}$, then, by Lemma 3.2(v), $K \cup \overline{K} = K$ is a (C, I^*) -clonoid.

Assume now that K is a (C, I^*) -clonoid and hence a (C, J) -clonoid. Then $K \supseteq I^*K = K \cup \overline{K}$, from which it follows that $\overline{K} \subseteq K$. Taking outer negations on both side of this inclusion, we get $K = \overline{\overline{K}} \subseteq \overline{K}$. We conclude that $K = \overline{K}$. \square

4. REVIEW OF EARLIER RESULTS ON C -MINORS

In a series of earlier papers of the author's [14, 15, 16, 20, 21, 22, 23, 24], a notion called “ C -minor” was introduced and investigated. In our current terminology, this concept is defined as follows.

Definition 4.1. Let $f, g \in \mathcal{F}_{AB}$, and let C be a clone on A . We say that f is a C -minor of g , and we write $f \leq_C g$, if $f = g(h_1, \dots, h_m)$ for some $h_1, \dots, h_m \in C$, or, equivalently, if $f \in \{g\}C$. This condition is, in fact, equivalent to $f \in \langle g \rangle_{(C, J_B)}$, because $\{g\}C = J_B(\{g\}C) = \langle g \rangle_{(C, J_B)}$.

For a fixed clone C , the C -minor relation \leq_C is a quasi-order (a reflexive and transitive relation) on \mathcal{F}_{AB} . As for all quasi-orders, it induces an equivalence relation (f and g are C -equivalent, denoted $f \equiv_C g$, if $f \leq_C g$ and $g \leq_C f$) and a partial order on $\mathcal{F}_{AB}/\equiv_C$ ($f/\equiv_C \leq_C g/\equiv_C$ if and only if $f \leq_C g$).

The main focus of the earlier work was on describing the C -equivalence classes and the structure of the C -minor poset $(\mathcal{F}_{AB}/\equiv_C, \leq_C)$. What is relevant to the purposes of our current paper is the fact that such results translate immediately into results about (C, J_B) -clonoids.

Lemma 4.2. *Let C be a clone on A , and let $F \subseteq \mathcal{F}_{AB}$.*

- (i) F is a downset of the C -minor quasi-order if and only if $FC = F$.
- (ii) F is a (C, J_B) -clonoid if and only if F is a downset of the C -minor quasi-order $(\mathcal{F}_{AB}, \leq_C)$.
- (iii) F is a (C, J_B) -clonoid if and only if $F = \bigcup D$ for some downset D of the C -minor partial order $(\mathcal{F}_{AB}/\equiv_C, \leq_C)$.

Proof. (i) Assume F is a downset of $(\mathcal{F}_{AB}, \leq_C)$. The inclusion $F \subseteq FC$ is clear because C contains all projections and therefore for every $f \in F$ we have $f = f(\text{pr}_1^{(n)}, \dots, \text{pr}_n^{(n)}) \in FC$. In order to show $FC \subseteq F$, let $\varphi \in FC$. Then $\varphi = f(g_1, \dots, g_n)$ for some $f \in F$ and $g_1, \dots, g_n \in C$, i.e., $\varphi \leq_C f$. Because $f \in F$ and F is a downset of \leq_C , it follows that $\varphi \in F$.

Assume now that $FC = F$. Let $f \in F$, and assume $\varphi \leq_C f$. Then $\varphi \in \{f\}C \subseteq FC = F$, which shows that F is a downset of \leq_C .

(ii) The fact that F is a (C, J_B) -clonoid is equivalent to $F = \langle F \rangle_{(C, J_B)} = J_B(FC) = FC$. By part (i), this is equivalent to the fact that F is a downset of $(\mathcal{F}_{AB}, \leq_C)$.

(iii) This follows immediately from (ii) and from the way how the C -minor quasi-order \leq_C induces a partial order on $\mathcal{F}_{AB}/\equiv_C$. \square

In the subsequent sections, we are going to review the earlier results on C -minors of Boolean functions, and we translate them to results about (C, J) -clonoids. Furthermore, for those source clones C for which the number of (C, J) -clonoids is finite or countably infinite, we are also going to explicitly describe the (C, D) -clonoids, for each target clone D .

5. SOURCE CLONES GIVING RISE TO AN UNCOUNTABLE INFINITY OF CLONIDS

Let \mathcal{Q} be a class of partial orders. A poset P is *universal* for \mathcal{Q} if $P \in \mathcal{Q}$ and for every $Q \in \mathcal{Q}$, Q embeds into P .

Theorem 5.1 ([24, Theorems 3.1, 6.1]). *If C is a subclone of Λ , V , or L , then the C -minor partial order is universal for the class of countable posets with finite initial segments.*

Theorem 5.2 ([20, Theorems 12, 14]). *If C is a clone belonging to the interval $[\{\text{SM}, \text{MU}_{01}^\infty, \text{MW}_{01}^\infty\}, \{\text{U}^2, \text{W}^2\}]$, then the C -minor partial order is universal in the class of countable posets.*

Theorem 5.3. *If C is a subclone of Λ , V , L , U^2 , or W^2 , then there are an uncountable infinity of (C, J) -clonoids.*

Proof. If C is a subclone of Λ , V , L , U^2 , or W^2 , then, by Theorems 5.1 and 5.2, the C -minor partial order is universal for the class of countable posets with finite initial segments or for the class of all countable posets. Both classes of posets contain, in particular, a countably infinite antichain; therefore, the C -minor poset contains a countably infinite antichain A . Distinct subsets of A generate distinct downsets of $(\Omega/\equiv_C, \leq_C)$. Consequently, $(\Omega/\equiv_C, \leq_C)$ has uncountably many downsets, and hence, by Lemma 4.2, there are an uncountable infinity of (C, J) -clonoids. \square

It is out of the scope of the current paper to investigate in greater detail the (C_1, C_2) -clonoids in the cases where C_1 is a subclone of Λ , V , L , U^2 , or W^2 .

6. CLONIDS WITH A MONOTONE SOURCE CLONE

For the four clones C in the interval $[\text{M}_{01}, \text{M}]$ (the clones of monotone functions), the C -minor poset was described in earlier papers of the author's. The proof was, however, scattered across several papers ([15, Section 6], [20, Section 7], and Kosub and Wagner [12, Proposition 38]) and was, admittedly, somewhat implicit. For this reason, we are going to present a complete proof here. Our main tool is the homomorphism order of k -posets.

For $k \in \mathbb{N}$, a *partially ordered set labeled with k colours* (in short, a *k -poset*) is a structure $\mathbf{P} = (P, \leq, c)$, where (P, \leq) is a poset (the *underlying poset*) and $c: P \rightarrow [0, k-1]$ is a *labeling*. If (P, \leq) is a lattice or a chain, then we may speak of a *k -lattice* or a *k -chain*, respectively.

Let $\mathbf{P} = (P, \leq, c)$ and $\mathbf{P}' = (P', \leq', c')$ be k -posets. A mapping $h: P \rightarrow P'$ is a *homomorphism* of \mathbf{P} to \mathbf{P}' , if h preserves both the order and the labels, i.e., $h(x) \leq' h(y)$ whenever $x \leq y$, and $c = c' \circ h$. We write $h: \mathbf{P} \rightarrow \mathbf{P}'$ to denote that h is a homomorphism of \mathbf{P} to \mathbf{P}' , and we write $\mathbf{P} \rightarrow \mathbf{P}'$ to denote that there exists a homomorphism of \mathbf{P} to \mathbf{P}' . If $\mathbf{P} \rightarrow \mathbf{P}'$ and $\mathbf{P}' \rightarrow \mathbf{P}$, we say that \mathbf{P} and \mathbf{P}' are *homomorphically equivalent*. The existence of homomorphism relation

\rightarrow is a quasi-order on the class of all k -posets, and it induces a partial order on the homomorphical equivalence classes. In general, the homomorphism order of k -posets has a very rich structure; see [17] for further details. However, as we will see, the restriction of the homomorphism order to 2-lattices is very easy to describe.

If \mathbf{P} and \mathbf{P}' have least elements \perp and \perp' , respectively, then a homomorphism $h: \mathbf{P} \rightarrow \mathbf{P}'$ is \perp -preserving if $h(\perp) = \perp'$. We define \top -preserving homomorphisms analogously when \mathbf{P} and \mathbf{P}' have greatest elements \top and \top' . We call \perp -preserving, \top -preserving, and both \perp - and \top -preserving homomorphisms also \perp -homomorphisms, \top -homomorphisms, and $\perp\top$ -homomorphisms, respectively. The composition of (\perp -preserving, \top -preserving) homomorphisms is again a homomorphism of the same kind.

Let (A, \leq) be a poset. An operation $f: A^n \rightarrow A$ is *monotone* (*order-preserving*) with respect to \leq if $f(\mathbf{a}) \leq f(\mathbf{b})$ whenever $\mathbf{a} \leq' \mathbf{b}$ in $(A, \leq)^n = (A^n, \leq')$, where \leq' is the component-wise partial order induced by \leq , given by the rule $(a_1, \dots, a_n) \leq' (b_1, \dots, b_n)$ if and only if $a_i \leq b_i$ for all $i \in [n]$. Denote by M the set of all monotone functions with respect to \leq (the partial order is implicit in the notation and is understood from the context). If (A, \leq) has a least element \perp , then denote by M_\perp the set of all monotone functions f that are \perp -preserving, i.e., $f(\perp, \dots, \perp) = \perp$. Similarly, if (A, \leq) has a greatest element \top , then denote by M_\top the set of all \top -preserving monotone functions. If (A, \leq) has both a least element \perp and a greatest element \top , let $M_{\perp\top} := M_\perp \cap M_\top$. The sets M , M_\perp , M_\top , and $M_{\perp\top}$ are clones on A .

If $A = [0, k-1]$, we associate with any $f: A^n \rightarrow A$ the k -poset $P(f, \leq) := ((A, \leq)^n, f) = ((A^n, \leq'), f)$.

Proposition 6.1 ([15, Proposition 6.1]). *Let (A, \leq) be a poset.*

- (i) $f \leq_M g$ if and only if there is a homomorphism of $P(f, \leq)$ to $P(g, \leq)$.
- (ii) If (A, \leq) has a least element \perp , then $f \leq_{M_\perp} g$ if and only if there is a \perp -homomorphism of $P(f, \leq)$ to $P(g, \leq)$.
- (iii) If (A, \leq) has a greatest element \top , then $f \leq_{M_\top} g$ if and only if there is a \top -homomorphism of $P(f, \leq)$ to $P(g, \leq)$.
- (iv) If (A, \leq) has a least element \perp and a greatest element \top , then $f \leq_{M_{\perp\top}} g$ if and only if there is a $\perp\top$ -homomorphism of $P(f, \leq)$ to $P(g, \leq)$.

Proof. Let C be one of the clones M , M_\perp , M_\top , $M_{\perp\top}$. Assume first that $f \leq_C g$. Then $f = g(h_1, \dots, h_m)$ for some $h_1, \dots, h_m \in C$. Clearly, $h = (h_1, \dots, h_m)$ is an order-preserving map from $(A, \leq)^n$ to $(A, \leq)^m$ and $f = g \circ h$, so h is a homomorphism of $P(f, \leq)$ to $P(g, \leq)$. Moreover, if $C \subseteq M_\perp$, then $h(\perp, \dots, \perp) = (\perp, \dots, \perp)$, i.e., h is \perp -preserving; and if $C \subseteq M_\top$, then $h(\top, \dots, \top) = (\top, \dots, \top)$, i.e., h is \top -preserving.

Conversely, assume that there exists a homomorphism h of $P(f, \leq)$ to $P(g, \leq)$. Then $f = g \circ h$, and in $h = (h_1, \dots, h_m)$, each component function h_i is in M . Moreover, if h is \perp -preserving, then each h_i is in M_\perp ; and if h is \top -preserving, then each h_i is in M_\top . Therefore $f \leq_C g$. \square

A k -chain (A, \leq, c) with $A = \{a_0, a_1, a_2, \dots, a_d\}$, $a_0 < a_1 < a_2 < \dots < a_d$, is *alternating* if $c(a_i) \neq c(a_{i+1})$ for all $i \in [0, d-1]$. The number $d \in \mathbb{N}$ is the *length* of this chain.

Note that an alternating 2-chain is uniquely determined, up to isomorphism, by its length and the label $c(a_0)$ of its least element; we have $c(a_i) = c(a_0)$ if and only if $i \equiv 0 \pmod{2}$. Denote by C_a^k ($k \in \mathbb{N}$, $a \in \{0, 1\}$) the alternating 2-chain of length k in which the label of the least element is a .

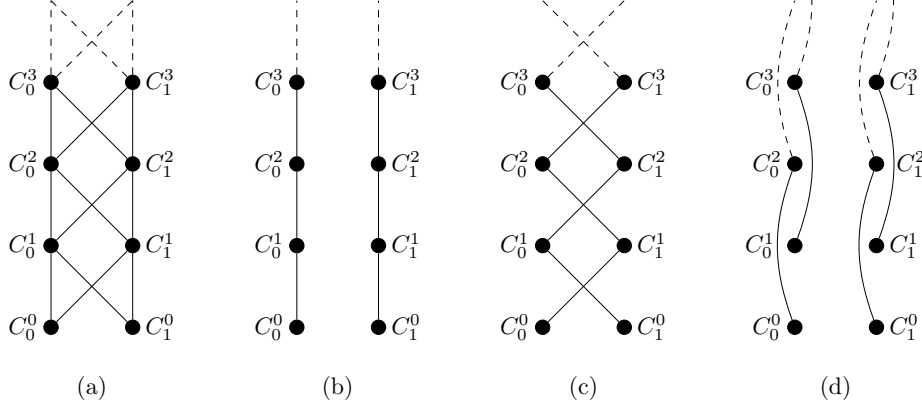

FIGURE 6.1. Homomorphism orders of 2-chains: (a) unrestricted, (b) \perp -preserving, (c) \top -preserving, and (d) \perp - and \top -preserving homomorphisms.

The homomorphism order of alternating 2-chains is very easy to describe, and so are the restrictions of the homomorphism order in which we confine ourselves to \perp -, \top -, or $\perp\top$ -homomorphisms; see also Figure 6.1.

Proposition 6.2.

- (i) *There exists a homomorphism of C_a^k to C_b^ℓ if and only if $k < \ell$ or $(k, a) = (\ell, b)$.*
- (ii) *There exists a \perp -homomorphism of C_a^k to C_b^ℓ if and only if $k \leq \ell$ and $a = b$.*
- (iii) *There exists a \top -homomorphism of C_a^k to C_b^ℓ if and only if $k \leq \ell$ and $a + k \equiv b + \ell \pmod{2}$.*
- (iv) *There exists a $\perp\top$ -homomorphism of C_a^k to C_b^ℓ if and only if $k \leq \ell$, $a = b$, and $k \equiv \ell \pmod{2}$.*

Proof. Straightforward verification. □

Let P be a k -poset with a least element \perp . The *alternation depth* of an element $x \in P$, denoted by $d_P(x)$, is the length of the longest alternating k -chain included in the interval from \perp to x . Note that if $a_0 < \dots < a_{d(x)}$ is such a longest alternating k -chain included in $[\perp, x]$, then $c(\perp) = c(a_0)$ and $c(x) = c(a_{d(x)})$; for, otherwise we could extend the chain into a longer alternating k -chain by adjoining \perp or x . Therefore, whenever we consider a longest alternating k -chain included in $[\perp, x]$, we may assume, if necessary, that it contains both \perp and x .

The following slightly generalizes an observation about 2-lattices made by Kosub and Wagner [11], [12, Proposition 38].

Proposition 6.3. *Every 2-poset with a least element (or with a greatest element) is homomorphically equivalent to its longest alternating 2-chain.*

Proof. Let (P, \leq, c) be a 2-poset with a least element \perp . (The proof for a 2-poset with a greatest element is similar.) It is clear that every 2-subposet of P (in particular, any longest alternating 2-chain) maps homomorphically to P , so we only need to show that there exists a homomorphism from P to a longest alternating chain in P .

Let $A = \{a_0, a_1, \dots, a_s\}$, $\perp = a_0 < a_1 < \dots < a_s$ be a longest alternating 2-chain in P . Now, define the map $h: P \rightarrow A$ as $h(x) = a_{d(x)}$ for all $x \in P$. We are going to show that h is a homomorphism. Firstly, if $x \leq y$ in P , then necessarily

$d(x) \leq d(y)$. (Every alternating 2-chain included in $[\perp, x]$ is also included in $[\perp, y]$.) Therefore $h(x) = a_{d(x)} \leq a_{d(y)} = h(y)$.

Secondly, observe that, for all $x \in P$, $c(x) = c(\perp)$ holds if and only if $d(x) \equiv 0 \pmod{2}$. The latter in turn holds if and only if $c(a_{d(x)}) = c(\perp)$ (because A is an alternating 2-chain). Therefore $c(h(x)) = c(a_{d(x)}) = c(x)$, so $c = c \circ h$. \square

We can now apply Propositions 6.1, 6.2, and 6.3 to describe the C -minor posets of Boolean functions, for $M_{01} \subseteq C \subseteq M$. Their downsets give us the (C, J) -clonoids.

For a Boolean function $f: \{0, 1\}^n \rightarrow \{0, 1\}$, define the *alternation depth* of $\mathbf{a} \in \{0, 1\}^n$, and denote it by $d_f(\mathbf{a})$, as $d_{P(f, \leq)}(\mathbf{a})$, i.e., the length of the longest alternating chain in the interval $[\mathbf{0}, \mathbf{a}]$ in $P(f, \leq)$. Furthermore, define the *alternation number* of $f: \{0, 1\}^n \rightarrow \{0, 1\}$, denoted $\text{Alt}(f)$, as the length of the longest alternating chain in $P(f, \leq)$, i.e., $\text{Alt}(f) = d_f(\mathbf{1})$. Denote by A^k the set of all Boolean functions with alternation number k and by $A^{\leq k}$ the set of all Boolean functions with alternation number at most k . We now obtain a description of the C -minor quasi-order for each clone C in the interval $[M_{01}, M]$.

Proposition 6.4. *Let $f, g \in \Omega$, and let $k := \text{Alt}(f)$, $\ell := \text{Alt}(g)$, $a := f(\mathbf{0})$, $b := g(\mathbf{0})$.*

- (i) $f \leq_M g$ if and only if $k < \ell$ or $(k, a) = (\ell, b)$.
- (ii) $f \leq_{M_{0*}} g$ if and only if $k \leq \ell$ and $a = b$.
- (iii) $f \leq_{M_{*1}} g$ if and only if $k \leq \ell$ and $a + k \equiv b + \ell \pmod{2}$.
- (iv) $f \leq_{M_{01}} g$ if and only if $k \leq \ell$, $a = b$, and $k \equiv \ell \pmod{2}$.

Proof. By Proposition 6.3, for every $f \in A_{a*}^k$ ($a \in \{0, 1\}$), the 2-poset $P(f, \leq)$ is homomorphically equivalent to C_a^k , and it is clear that they are even $\perp \top$ -homomorphically equivalent. The statements then follow immediately from Propositions 6.1 and 6.2. \square

As an immediate consequence of Proposition 6.4, we get that for each clone C in the interval $[M_{01}, M]$, the C -equivalence classes are precisely the sets of the form A_{a*}^k , for $k \in \mathbb{N}_+$ and $a \in \{0, 1\}$. Note that $A_{a*}^k = A_{ab}^k$ for the unique $b \in \{0, 1\}$ satisfying $a + k \equiv b \pmod{2}$. Moreover, the mapping $A_{a*}^k \mapsto C_a^k$ is an isomorphism between the C -minor poset $(\Omega / \equiv_C, \leq_C)$ and the corresponding homomorphism order (unrestricted, \perp -preserving, \top -preserving, $\perp \top$ -preserving) of alternating 2-chains (see Figure 6.1).

Lemma 6.5. *Let $k \in \mathbb{N}$ and $a, b \in \{0, 1\}$ such that $a + k \equiv b \pmod{2}$. Then the following statements hold.*

- (i) $A_{ab}^k M = A_{ab}^k \cup A^{\leq k-1}$ for $k \geq 1$; $A_{ab}^0 M = A_{ab}^0$.
- (ii) $A_{ab}^k M_{0*} = A_{a*}^{\leq k}$.
- (iii) $A_{ab}^k M_{*1} = A_{*b}^{\leq k}$.
- (iv) $A_{ab}^k M_{01} = A_{ab}^{\leq k}$.

Proof. Follows immediately from Proposition 6.4. \square

We are now ready to describe the (C, J) -clonoids for $C \in [M_{01}, M]$.

Theorem 6.6 (See Figure 6.2.).

- (i) *The (M, J) -clonoids are the sets $\emptyset, \Omega, A_{00}^0 = C_0, A_{11}^0 = C_1, A^{\leq k}, A_{0*}^{k+1} \cup A^{\leq k}$, and $A_{1*}^{k+1} \cup A^{\leq k}$ for $k \in \mathbb{N}$.*
- (ii) *The (M_{0*}, J) -clonoids are the sets of the form $A \cup B$, where*

$$A \in \{\emptyset, \Omega_{0*}\} \cup \{A_{0*}^{\leq k} \mid k \in \mathbb{N}\}, \quad B \in \{\emptyset, \Omega_{1*}\} \cup \{A_{1*}^{\leq k} \mid k \in \mathbb{N}\}.$$
- (iii) *The (M_{*1}, J) -clonoids are the sets of the form $A \cup B$, where*

$$A \in \{\emptyset, \Omega_{*0}\} \cup \{A_{*0}^{\leq k} \mid k \in \mathbb{N}\}, \quad B \in \{\emptyset, \Omega_{*1}\} \cup \{A_{*1}^{\leq k} \mid k \in \mathbb{N}\}.$$

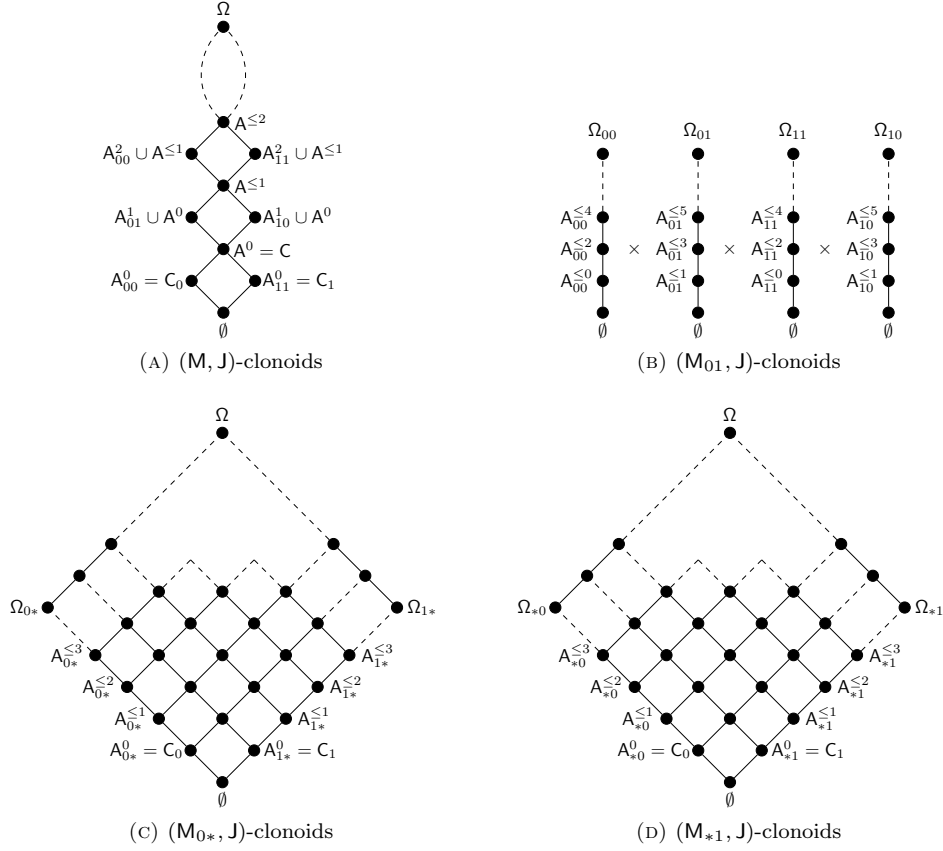
FIGURE 6.2. (C, J) -clonoids for $M_{01} \subseteq C \subseteq M$.

(iv) The (M_{01}, J) -clonoids are the sets of the form $A \cup B \cup C \cup D$, where

$$A \in \{\emptyset, \Omega_{00}\} \cup \{A_{00}^{\leq k} \mid k \in \mathbb{N}\}, \quad B \in \{\emptyset, \Omega_{01}\} \cup \{A_{01}^{\leq k} \mid k \in \mathbb{N}\},$$

$$C \in \{\emptyset, \Omega_{11}\} \cup \{A_{11}^{\leq k} \mid k \in \mathbb{N}\}, \quad D \in \{\emptyset, \Omega_{10}\} \cup \{A_{10}^{\leq k} \mid k \in \mathbb{N}\}.$$

Proof. For each clone C in the interval $[M_{01}, M]$, the (C, J) -clonoids are the downsets of the C -minor quasi-order. The latter can be easily determined from the Hasse diagrams of Figure 6.1, using the isomorphism $A_{a*}^k \mapsto C_a^k$ between the C -minor poset and the appropriate homomorphism order of alternating 2-chains. \square

With the help of Theorem 6.6, it is now possible to determine the (C_1, C_2) -clonoids for clones C_1 and C_2 such that $M_{01} \subseteq C_1$ and C_2 is arbitrary. By Lemma 2.5, such (C_1, C_2) -clonoids are (M_{01}, J) -clonoids; it is just a matter of identifying them among the (M_{01}, J) -clonoids that were determined above. We start with the cases where the target clone is essentially at most unary.

Proposition 6.7.

- (i) For clones $C_1 \in \{M, M_{0*}, M_{*1}, M_{01}\}$,
- the (C_1, l_0) -clonoids are \emptyset and those (C_1, J) -clonoids K with $C_0 = A_{00}^0 \subseteq K$,
 - the (C_1, l_1) -clonoids are \emptyset and those (C_1, J) -clonoids K with $C_1 = A_{11}^0 \subseteq K$,

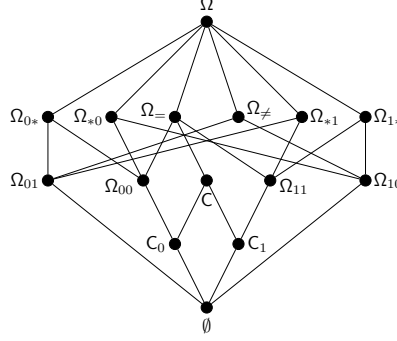
FIGURE 6.3. (M_{01}, L_c) -clonoids.

- the (C_1, l) -clonoids are \emptyset and those (C_1, j) -clonoids K with $C = A^0 \subseteq K$.
- (ii) For clones $C_1 \in \{M, M_{0*}, M_{*1}\}$ and $C_2 \in \{l^*, \Omega(1)\}$, the (C_1, C_2) -clonoids are the sets $\emptyset, \Omega, A^{\leq k}$, for $k \in \mathbb{N}$.
- (iii) The (M_{01}, l^*) -clonoids are the sets of the form $A \cup B$, where

$$A \in \{\emptyset, \Omega_{=}\} \cup \{A_{00}^{\leq k} \cup A_{11}^{\leq k} \mid k \in \mathbb{N}\},$$

$$B \in \{\emptyset, \Omega_{\neq}\} \cup \{A_{01}^{\leq k} \cup A_{10}^{\leq k} \mid k \in \mathbb{N}\}.$$
- (iv) The $(M_{01}, \Omega(1))$ -clonoids are \emptyset and the sets of the form $A \cup B$, where

$$A \in \{\Omega_{=}\} \cup \{A_{00}^{\leq k} \cup A_{11}^{\leq k} \mid k \in \mathbb{N}\},$$

$$B \in \{\emptyset, \Omega_{\neq}\} \cup \{A_{01}^{\leq k} \cup A_{10}^{\leq k} \mid k \in \mathbb{N}\}.$$
- (v) For clones $C_1 \in \{M, M_{0*}, M_{*1}, M_{01}\}$ and $C_2 \in \{j, l_0, l_1, l, l^*, \Omega(1)\}$, the clonoid lattice $\mathcal{L}_{(C_1, C_2)}$ is countably infinite.

Proof. This follows immediately from Theorem 6.6 and Lemmata 2.10 and 3.3. Clearly, the clonoid lattices $\mathcal{L}_{(C_1, C_2)}$ considered here are countably infinite. \square

The cases where the target clone includes L_c or SM have been described in earlier papers of the author's. We quote here only the results for the cases where the target clone is L_c or SM . The results for their superclones can be found in the earlier papers, and we simply refer the reader to those papers. The Hasse diagrams of $\mathcal{L}_{(M_{01}, L_c)}$ and $\mathcal{L}_{(M_{01}, SM)}$ are shown in Figures 6.3 and 6.4.

Proposition 6.8 ([8, Theorem 7.1, Table 3]). *There are precisely 15 (M_{01}, L_c) -clonoids, and they are the following: $\Omega, \Omega_{0*}, \Omega_{1*}, \Omega_{*0}, \Omega_{*1}, \Omega_{=}, \Omega_{\neq}, \Omega_{00}, \Omega_{01}, \Omega_{10}, \Omega_{11}, C, C_0, C_1, \emptyset$.*

Proposition 6.9 ([18, Theorem 5.1, Table 1]). *There are precisely 39 (M_{01}, SM) -clonoids, and they are the following: $\Omega, \Omega_{\leq}, \Omega_{\geq}, \Omega_{\neq, 00}, \Omega_{\neq, 11}, \Omega_{0*} \cup C_1, \Omega_{*0} \cup C_1, \Omega_{1*} \cup C_0, \Omega_{*1} \cup C_0, \Omega_{0*}, \Omega_{*0}, \Omega_{1*}, \Omega_{*1}, \Omega_{=}, \Omega_{\neq}, \Omega_{01} \cup C, \Omega_{10} \cup C, \Omega_{01} \cup C_0, \Omega_{10} \cup C_0, \Omega_{01} \cup C_1, \Omega_{10} \cup C_1, \Omega_{00} \cup C_1, \Omega_{11} \cup C_0, \Omega_{00}, \Omega_{11}, \Omega_{01}, \Omega_{10}, M, M_{0*}, M_{*1}, M_{01}, \overline{M}, \overline{M}_{*0}, \overline{M}_{1*}, \overline{M}_{10}, C, C_0, C_1, \emptyset$.*

It remains to consider the cases where the target clone includes V_{01} or Λ_{01} .

Definition 6.10. For $\mathbf{c} = c_0 c_1 c_2 \dots c_m \in \{0, 1\}^{\{0, \dots, m\}}$, let $\lambda_{\mathbf{c}}: \{0, 1\}^m \rightarrow \{0, 1\}$ be the Boolean function defined by the rule $\lambda_{\mathbf{c}}(\mathbf{a}) = c_{w(\mathbf{a})}$, where $w(\mathbf{a})$ is the Hamming weight of \mathbf{a} . It is clear that $\text{Alt}(\lambda_{\mathbf{c}})$ equals the number of indices $i \in \{0, \dots, m-1\}$ such that $c_i \neq c_{i+1}$.

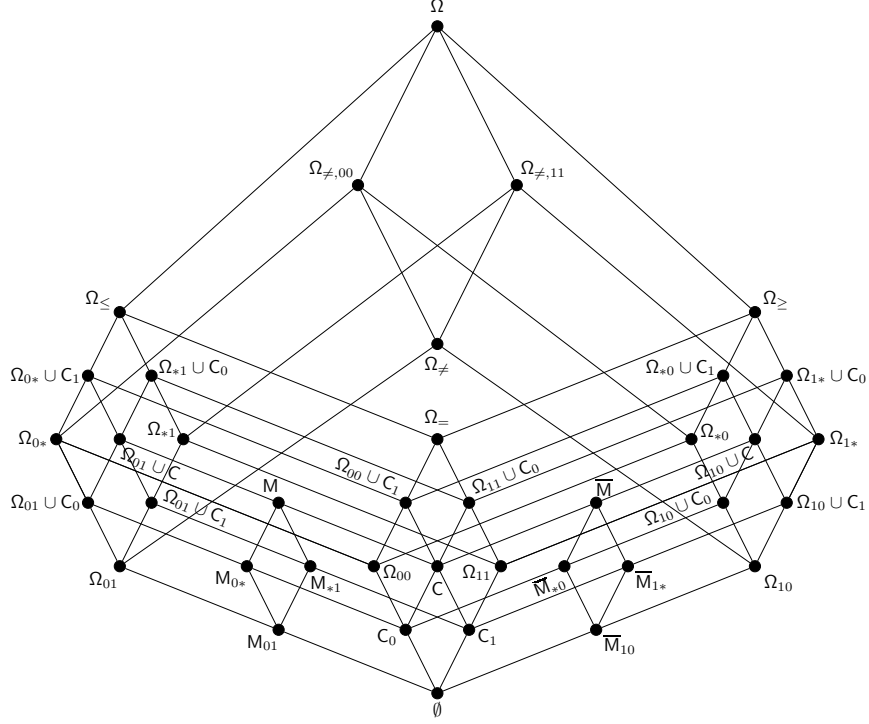
FIGURE 6.4. (M_{01}, SM) -clonoids.

The classes $A_{ab}^{\leq n}$ of Boolean functions with a bounded alternation number are not stable under left composition with V_{01} , with some exceptions for small bounds n .

Lemma 6.11. *For $n \geq 2$ and $a, b \in \{0, 1\}$ with $a + n \equiv b \pmod{2}$, unless $n = 2$ and $a = b = 1$, there exists an $m > n$ such that $V_{01} A_{ab}^n \cap V_{01} A_{ab}^m \neq \emptyset$; in particular, $V_{01} A_{ab}^n \not\subseteq A_{ab}^{\leq n}$.*

Proof. Let $k \in \mathbb{N}_+$. Let $\mathbf{a} = (0100)^k 0$, $\mathbf{b} = (0001)^k 0$. Then $\lambda_{\mathbf{a}}, \lambda_{\mathbf{b}} \in A_{00}^{2k}$, but $\vee(\lambda_{\mathbf{a}}, \lambda_{\mathbf{b}}) = \lambda_{\mathbf{u}}$, where $\mathbf{u} = (0101)^k 0$, and $\lambda_{\mathbf{u}} \in A_{00}^{4k}$, so $\lambda_{\mathbf{u}} \notin A_{00}^{\leq 2k}$. Moreover, $\lambda_{\mathbf{a}1}, \lambda_{\mathbf{b}1} \in A_{01}^{2k+1}$, but $\vee(\lambda_{\mathbf{a}1}, \lambda_{\mathbf{b}1}) = \lambda_{\mathbf{u}1} \in A_{01}^{4k+1}$ and $\lambda_{\mathbf{u}1} \notin A_{01}^{\leq 2k+1}$; $\lambda_{1\mathbf{a}}, \lambda_{1\mathbf{b}} \in A_{10}^{2k+1}$, but $\vee(\lambda_{1\mathbf{a}}, \lambda_{1\mathbf{b}}) = \lambda_{1\mathbf{u}} \in A_{10}^{4k+1}$ and $\lambda_{1\mathbf{u}} \notin A_{10}^{\leq 2k+1}$; and $\lambda_{1\mathbf{a}1}, \lambda_{1\mathbf{b}1} \in A_{11}^{2k+2}$, but $\vee(\lambda_{1\mathbf{a}1}, \lambda_{1\mathbf{b}1}) = \lambda_{1\mathbf{u}1} \in A_{11}^{4k+2}$ and $\lambda_{1\mathbf{u}1} \notin A_{11}^{\leq 2k+2}$. \square

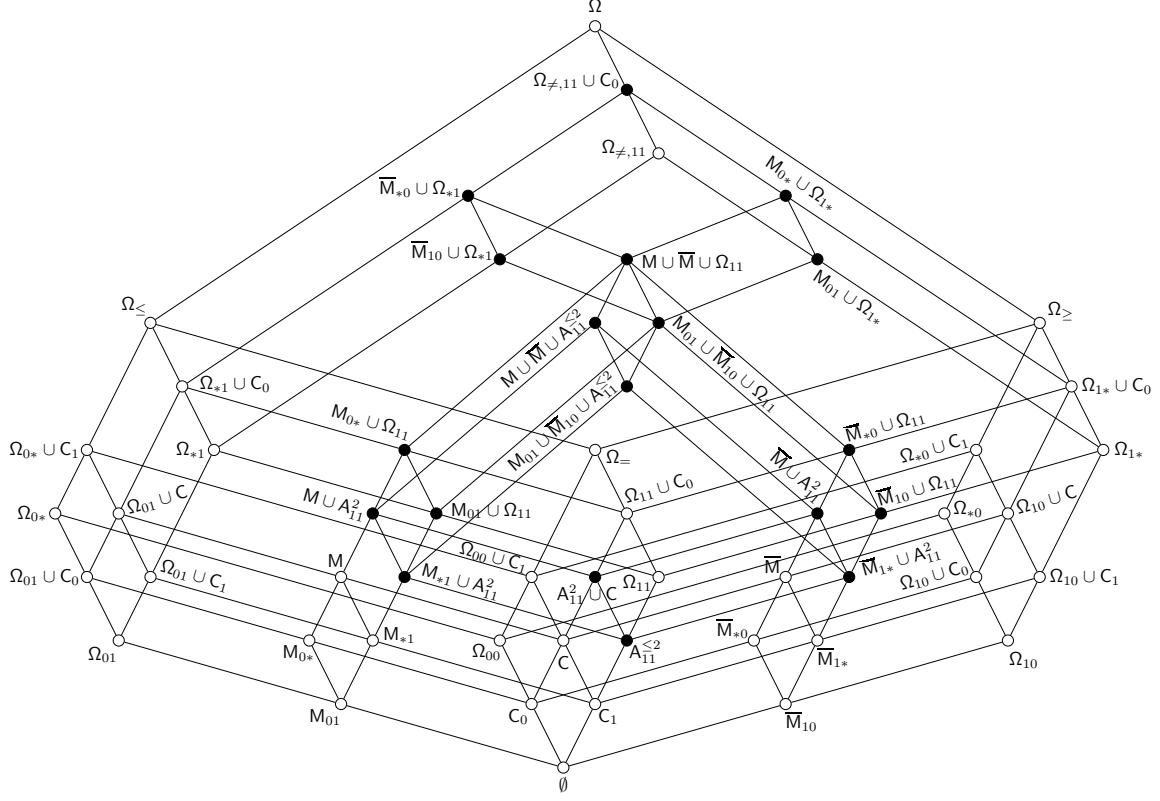
FIGURE 6.5. (M_{01}, V_{01}) -clonoids.

Proposition 6.12. *There are precisely 56 (M_{01}, V_{01}) -clonoids, and they are the following:*

$$\begin{aligned}
& \Omega, \Omega_{\neq,11} \cup C_0, \Omega_{\neq,11}, \Omega_{\geq}, \Omega_{\leq}, \Omega_{=}, \\
& \Omega_{0*} \cup C_1, \Omega_{*0} \cup C_1, \Omega_{1*} \cup C_0, \Omega_{*1} \cup C_0, \Omega_{01} \cup C, \Omega_{01} \cup C_0, \\
& \Omega_{01} \cup C_1, \Omega_{10} \cup C, \Omega_{10} \cup C_0, \Omega_{10} \cup C_1, \Omega_{00} \cup C_1, \Omega_{11} \cup C_0, \\
& \Omega_{0*}, \Omega_{*0}, \Omega_{1*}, \Omega_{*1}, \Omega_{01}, \Omega_{10}, \Omega_{00}, \Omega_{11}, \\
& M \cup \bar{M} \cup \Omega_{11}, M \cup \bar{M} \cup A_{11}^2, M_{01} \cup \bar{M}_{10} \cup \Omega_{11}, M_{01} \cup \bar{M}_{10} \cup A_{11}^{\leq 2}, \\
& M \cup A_{11}^2, M_{0*} \cup \Omega_{1*}, M_{0*} \cup \Omega_{11}, M_{*1} \cup A_{11}^2, \\
& \bar{M} \cup A_{11}^2, \bar{M}_{*0} \cup \Omega_{*1}, \bar{M}_{*0} \cup \Omega_{11}, \bar{M}_{1*} \cup A_{11}^2, \\
& M_{01} \cup \Omega_{1*}, M_{01} \cup \Omega_{11}, \bar{M}_{10} \cup \Omega_{*1}, \bar{M}_{10} \cup \Omega_{11}, \\
& M, M_{0*}, M_{*1}, M_{01}, \bar{M}, \bar{M}_{*0}, \bar{M}_{1*}, \bar{M}_{10}, \\
& A_{11}^2 \cup C, A_{11}^{\leq 2}, C, C_0, C_1, \emptyset.
\end{aligned}$$

The Hasse diagram of $\mathcal{L}_{(M_{01}, V_{01})}$ is shown in Figure 6.5.

Proof. By Theorem 6.6(iv) and Lemma 6.11, every (M_{01}, V_{01}) -clonoid must be of the form $A \cup B \cup C \cup D$, where

$$\begin{aligned}
A & \in \{\emptyset, A_{00}^0, \Omega_{00}\}, & B & \in \{\emptyset, A_{11}^0, A_{11}^{\leq 2}, \Omega_{11}\}, \\
C & \in \{\emptyset, A_{01}^1, \Omega_{01}\}, & D & \in \{\emptyset, A_{10}^1, \Omega_{10}\}.
\end{aligned}$$

Not every set of this form is a (M_{01}, V_{01}) -clonoid, though. We can exclude several with the following observations.

Claim 6.12.1. Assume $K \subseteq \Omega$ is stable under left composition with V_{01} .

- (i) If $A_{01}^1 \cup A_{10}^1 \subseteq K$, then $A_{11}^{\leq 2} \subseteq K$.
- (ii) If $\Omega_{ab} \cup A_{cd}^\ell \subseteq K$ for some $a, b, c, d \in \{0, 1\}$ and $\ell \in \{1, 2\}$ with $(c, d) \neq (0, 0)$ and $c + \ell \equiv d \pmod{2}$, then $\Omega_{rs} \subseteq K$, where $r = a \vee c$ and $s = b \vee d$.

Proof. (i) Let $f \in A_{11}^{\leq 2}$. If $f \in A_{11}^0 = C_1$, let g and h be the functions (of the same arity as f) given by the rules $g(\mathbf{a}) = 0$ if and only if $\mathbf{a} = \mathbf{0}$, and $h(\mathbf{a}) = 0$ if and only if $\mathbf{a} = \mathbf{1}$. If $f \in A_{11}^2$, define g and h by the rules

$$g(\mathbf{a}) = \begin{cases} 1, & \text{if } d_f(\mathbf{a}) = 2, \\ 0, & \text{otherwise,} \end{cases} \quad h(\mathbf{a}) = \begin{cases} 1, & \text{if } d_f(\mathbf{a}) = 0, \\ 0, & \text{otherwise.} \end{cases}$$

In either case, $g \in A_{01}^1$ and $h \in A_{10}^1$, and $f = g \vee h \in V_{01}(A_{01}^1 \cup A_{10}^1) \subseteq V_{01}K \subseteq K$.

- (ii) Let $f \in \Omega_{rs}$, and define functions g and h by the rules

$$g(\mathbf{a}) = \begin{cases} f(\mathbf{a}), & \text{if } \mathbf{a} \notin \{\mathbf{0}, \mathbf{1}\}, \\ a, & \text{if } \mathbf{a} = \mathbf{0}, \\ b, & \text{if } \mathbf{a} = \mathbf{1}, \end{cases} \quad h(\mathbf{a}) = \begin{cases} 0, & \text{if } \mathbf{a} \notin \{\mathbf{0}, \mathbf{1}\}, \\ c, & \text{if } \mathbf{a} = \mathbf{0}, \\ d, & \text{if } \mathbf{a} = \mathbf{1}. \end{cases}$$

We have $g \in \Omega_{ab}$ and $h \in A_{cd}^\ell$, and $f = g \vee h \in V_{01}(\Omega_{ab} \cup A_{cd}^\ell) \subseteq V_{01}K \subseteq K$. ■

We can exclude many quadruples (A, B, C, D) with the help of Claim 6.12.1. Namely, by Claim 6.12.1(i), we have that if $C \neq \emptyset$ and $D \neq \emptyset$, then $B \in \{A_{11}^{\leq 2}, \Omega_{11}\}$. By Claim 6.12.1(ii), we have that if $A = \Omega_{00}$ then $B \in \{\emptyset, A_{11}^0, \Omega_{11}\}$, $C \in \{\emptyset, \Omega_{01}\}$, and $D \in \{\emptyset, \Omega_{10}\}$; moreover, if $C = \Omega_{01}$ or $D = \Omega_{10}$, then $B \in \{\emptyset, A_{11}^0, \Omega_{11}\}$; even futher, if $(C = \Omega_{01} \text{ and } D \neq \emptyset)$ or $(C \neq \emptyset \text{ and } D = \Omega_{10})$, then $B = \Omega_{11}$.

This leaves us with the 56 possible combinations for the quadruples (A, B, C, D) and the corresponding classes $A \cup B \cup C \cup D$ that are presented in Table 6.1.

It remains to verify that these classes are indeed (M_{01}, V_{01}) -clonoids. For this, we only need to prove stability under left composition with V_{01} . Because intersections of (M_{01}, V_{01}) -clonoids are (M_{01}, V_{01}) -clonoids, it suffices to verify this only for the 12 meet-irreducible classes Ω , Ω_{\leq} , Ω_{\geq} , $\Omega_{\neq, 11} \cup C_0$, $\Omega_{\neq, 11}$, $\Omega_{0*} \cup C_1$, $\Omega_{*0} \cup C_1$, Ω_{0*} , Ω_{*0} , $\Omega_{*1} \cup \overline{M}_{*0}$, $\Omega_{1*} \cup M_{0*}$, $M_{0*} \cup \overline{M}_{*0} \cup A_{11}^{\leq 2}$. We give below the proof for $M_{0*} \cup \overline{M}_{*0} \cup A_{11}^{\leq 2}$. For the remaining classes, the proof is straightforward verification, and we leave it for the reader.

Claim 6.12.2. $M_{0*} \cup \overline{M}_{*0} \cup A_{11}^{\leq 2}$ is stable under left composition with V_{01} .

Proof of Claim 6.12.2. By Lemma 2.9, it is enough to show that $\vee(f, g) \in M_{0*} \cup \overline{M}_{*0} \cup A_{11}^{\leq 2}$ whenever $f, g \in M_{0*} \cup \overline{M}_{*0} \cup A_{11}^{\leq 2}$. So, let $f, g \in M_{0*} \cup \overline{M}_{*0} \cup A_{11}^{\leq 2}$. If $f = 0$ or $g = 0$, then $f \vee g$ equals g or f and hence clearly belongs to $M_{0*} \cup \overline{M}_{*0} \cup A_{11}^{\leq 2}$. We may now assume that neither f nor g is a constant 0 function, that is, $f, g \in M_{01} \cup \overline{M}_{10} \cup A_{11}^{\leq 2}$. Because $(f(\mathbf{0}), f(\mathbf{1})) \neq (0, 0)$ and $(g(\mathbf{0}), g(\mathbf{1})) \neq (0, 0)$, it follows that $((f \vee g)(\mathbf{0}), (f \vee g)(\mathbf{1})) \neq (0, 0)$.

It suffices to show that $\text{Alt}(f \vee g) \leq 2$. Suppose, to the contrary, that $\text{Alt}(f \vee g) \geq 3$. Then there exist tuples $\mathbf{a}, \mathbf{b}, \mathbf{c}$ such that $\mathbf{0} < \mathbf{a} < \mathbf{b} < \mathbf{c}$ and

$$(f \vee g)(\mathbf{0}) \neq (f \vee g)(\mathbf{a}) \neq (f \vee g)(\mathbf{b}) \neq (f \vee g)(\mathbf{c}).$$

We consider two cases according to the value of $f \vee g$ at $\mathbf{0}$.

If $(f \vee g)(\mathbf{0}) = 0$ (and hence $(f \vee g)(\mathbf{a}) = (f \vee g)(\mathbf{c}) = 1$ and $(f \vee g)(\mathbf{b}) = 0$), then $f(\mathbf{0}) = g(\mathbf{0}) = f(\mathbf{b}) = g(\mathbf{b}) = 0$ and $f(\mathbf{a}) = 1$ or $g(\mathbf{b}) = 1$; without loss of generality, assume $f(\mathbf{a}) = 1$. Because $(f(\mathbf{0}), f(\mathbf{1})) \neq (0, 0)$, it follows that $\text{Alt}(f) \geq 3$, a contradiction.

A	B	C	D	$A \cup B \cup C \cup D$	A	B	C	D	$A \cup B \cup C \cup D$
\emptyset	\emptyset	\emptyset	\emptyset	\emptyset	A_{00}^0	A_{11}^0	\emptyset	\emptyset	C
\emptyset	\emptyset	\emptyset	A_{10}^1	\overline{M}_{10}	A_{00}^0	A_{11}^0	\emptyset	A_{10}^1	\overline{M}
\emptyset	\emptyset	\emptyset	Ω_{10}	Ω_{10}	A_{00}^0	A_{11}^0	\emptyset	Ω_{10}	$\Omega_{10} \cup C$
\emptyset	\emptyset	A_{01}^1	\emptyset	M_{01}	A_{00}^0	A_{11}^0	A_{01}^1	\emptyset	M
\emptyset	\emptyset	Ω_{01}	\emptyset	Ω_{01}	A_{00}^0	A_{11}^0	Ω_{01}	\emptyset	$\Omega_{01} \cup C$
\emptyset	A_{11}^0	\emptyset	\emptyset	C_1	A_{00}^0	$A_{11}^{\leq 2}$	\emptyset	\emptyset	$A_{11}^{\leq 2} \cup C_0$
\emptyset	A_{11}^0	\emptyset	A_{10}^1	\overline{M}_{1*}	A_{00}^0	$A_{11}^{\leq 2}$	\emptyset	A_{10}^1	$\overline{M} \cup A_{11}^2$
\emptyset	A_{11}^0	\emptyset	Ω_{10}	$\Omega_{10} \cup C_1$	A_{00}^0	$A_{11}^{\leq 2}$	A_{01}^1	\emptyset	$M \cup A_{11}^2$
\emptyset	A_{11}^0	A_{01}^1	\emptyset	M_{*1}	A_{00}^0	$A_{11}^{\leq 2}$	A_{01}^1	A_{10}^1	$M \cup \overline{M} \cup A_{11}^{\leq 2}$
\emptyset	A_{11}^0	Ω_{01}	\emptyset	$\Omega_{01} \cup C_1$	A_{00}^0	Ω_{11}	\emptyset	\emptyset	$\Omega_{11} \cup C_0$
\emptyset	$A_{11}^{\leq 2}$	\emptyset	\emptyset	$A_{11}^{\leq 2}$	A_{00}^0	Ω_{11}	\emptyset	A_{10}^1	$\Omega_{11} \cup \overline{M}_{*0}$
\emptyset	$A_{11}^{\leq 2}$	\emptyset	A_{10}^1	$\overline{M}_{1*} \cup A_{11}^2$	A_{00}^0	Ω_{11}	\emptyset	Ω_{10}	$\Omega_{1*} \cup C_0$
\emptyset	$A_{11}^{\leq 2}$	A_{01}^1	\emptyset	$M_{*1} \cup A_{11}^2$	A_{00}^0	Ω_{11}	A_{01}^1	\emptyset	$\Omega_{11} \cup M_{0*}$
\emptyset	$A_{11}^{\leq 2}$	A_{01}^1	A_{10}^1	$M_{01} \cup \overline{M}_{10} \cup A_{11}^{\leq 2}$	A_{00}^0	Ω_{11}	A_{01}^1	A_{10}^1	$M \cup \overline{M} \cup \Omega_{11}$
\emptyset	Ω_{11}	\emptyset	\emptyset	Ω_{11}	A_{00}^0	Ω_{11}	A_{01}^1	Ω_{10}	$\Omega_{1*} \cup M_{0*}$
\emptyset	Ω_{11}	\emptyset	A_{10}^1	$\Omega_{11} \cup \overline{M}_{10}$	A_{00}^0	Ω_{11}	Ω_{01}	\emptyset	$\Omega_{*1} \cup C_0$
\emptyset	Ω_{11}	\emptyset	Ω_{10}	Ω_{1*}	A_{00}^0	Ω_{11}	Ω_{01}	A_{10}^1	$\Omega_{*1} \cup \overline{M}_{*0}$
\emptyset	Ω_{11}	A_{01}^1	\emptyset	$\Omega_{11} \cup M_{01}$	A_{00}^0	Ω_{11}	Ω_{01}	Ω_{10}	$\Omega_{\neq,11} \cup C_0$
\emptyset	Ω_{11}	A_{01}^1	A_{10}^1	$\Omega_{11} \cup M_{01} \cup \overline{M}_{10}$	Ω_{00}	\emptyset	\emptyset	\emptyset	Ω_{00}
\emptyset	Ω_{11}	A_{01}^1	Ω_{10}	$\Omega_{1*} \cup M_{01}$	Ω_{00}	\emptyset	\emptyset	Ω_{10}	Ω_{*0}
\emptyset	Ω_{11}	Ω_{01}	\emptyset	Ω_{*1}	Ω_{00}	\emptyset	Ω_{01}	\emptyset	Ω_{0*}
\emptyset	Ω_{11}	Ω_{01}	A_{10}^1	$\Omega_{*1} \cup \overline{M}_{10}$	Ω_{00}	A_{11}^1	\emptyset	\emptyset	$\Omega_{00} \cup C_1$
\emptyset	Ω_{11}	Ω_{01}	Ω_{10}	$\Omega_{\neq,11}$	Ω_{00}	A_{11}^0	\emptyset	Ω_{10}	$\Omega_{*0} \cup C_1$
A_{00}^0	\emptyset	\emptyset	\emptyset	C_0	Ω_{00}	A_{11}^0	Ω_{01}	\emptyset	$\Omega_{0*} \cup C_1$
A_{00}^0	\emptyset	\emptyset	A_{10}^1	\overline{M}_{*0}	Ω_{00}	Ω_{11}	\emptyset	\emptyset	$\Omega_{=}$
A_{00}^0	\emptyset	\emptyset	Ω_{10}	$\Omega_{10} \cup C_0$	Ω_{00}	Ω_{11}	\emptyset	Ω_{10}	Ω_{\geq}
A_{00}^0	\emptyset	A_{01}^1	\emptyset	M_{0*}	Ω_{00}	Ω_{11}	Ω_{01}	\emptyset	Ω_{\leq}
A_{00}^0	\emptyset	Ω_{01}	\emptyset	$\Omega_{01} \cup C_0$	Ω_{00}	Ω_{11}	Ω_{01}	Ω_{10}	Ω

TABLE 6.1. The possible combinations of A, B, C, D in the proof of Proposition 6.12 and the 56 (M_{01}, V_{01}) -clonoids.

If $(f \vee g)(\mathbf{0}) = 1$ (and hence $(f \vee g)(\mathbf{a}) = (f \vee g)(\mathbf{c}) = 0$ and $(f \vee g)(\mathbf{b}) = 1$), then $f(\mathbf{a}) = g(\mathbf{a}) = f(\mathbf{c}) = g(\mathbf{c}) = 0$ and $f(\mathbf{b}) = 1$ or $g(\mathbf{b}) = 1$; without loss of generality, assume $f(\mathbf{b}) = 1$. Because $(f(\mathbf{0}), f(\mathbf{1})) \neq (0, 0)$, it follows that $\text{Alt}(f) \geq 3$, a contradiction. \blacksquare \square

Proposition 6.13. *There are precisely 56 (M_{01}, Λ_{01}) -clonoids, and they are precisely the duals of the (M_{01}, V_{01}) -clonoids described in Proposition 6.12.*

Proof. This follows by duality from Proposition 6.12. \square

In order to complete the picture, we are still going describe all (C_1, C_2) -clonoids for clones C_1 and C_2 , where $M_{01} \subseteq C_1$ and $V_{01} \subseteq C_2$. We achieve this by determining, for each (M_{01}, V_{01}) -clonoid K , the unique clones C_1^K and C_2^K with the property that for all clones C_1 and C_2 , $KC_1 \subseteq K$ if and only if $C_1 \subseteq C_1^K$, and $C_2K \subseteq K$ if and only if $C_2 \subseteq C_2^K$ (see Lemma 2.6).

Theorem 6.14. *For each (M_{01}, V_{01}) -clonoid K , as determined in Proposition 6.12, the clones C_1^K and C_2^K prescribed in Table 6.2 have the property that for every clone C , it holds that $KC \subseteq K$ if and only if $C \subseteq C_1^K$, and $CK \subseteq K$ if and only if $C \subseteq C_2^K$.*

For 37 out of the 56 (M_{01}, V_{01}) -clonoids, the stability has already been determined in [18, Theorem 5.1, Table 1], as indicated in Table 6.2. We focus on the

K	$KC \subseteq K$ iff $C \subseteq \dots$	$CK \subseteq K$ iff $C \subseteq \dots$	source	K	$KC \subseteq K$ iff $C \subseteq \dots$	$CK \subseteq K$ iff $C \subseteq \dots$	source
Ω	Ω	Ω	[18]	$M_{01} \cup \overline{M}_{10} \cup \Omega_{11}$	M_{01}	V_{*1}	6.14
$\Omega_{\neq,11} \cup C_0$	Ω_{01}	V	6.14	$M_{01} \cup \overline{M}_{10} \cup A_{11}^{\leq 2}$	M_{01}	V_{*1}	6.14
$\Omega_{\neq,11}$	Ω_{01}	W^2	[18]	$M \cup A_{11}^2$	M_{*1}	V	6.14
Ω_{\leq}	Ω_{01}	M	[18]	$M_{0*} \cup \Omega_{1*}$	M_{0*}	V	6.14
Ω_{\geq}	Ω_{01}	M	[18]	$M_{0*} \cup \Omega_{11}$	M_{01}	V	6.14
$\Omega_{=}$	Ω_{01}	Ω	[18]	$M_{*1} \cup A_{11}^2$	M_{*1}	V_{*1}	6.14
$\Omega_{0*} \cup C_1$	Ω_{0*}	M	[18]	$\overline{M} \cup A_{11}^2$	M_{0*}	V_{*1}	6.14
$\Omega_{*0} \cup C_1$	Ω_{*1}	M	[18]	$\overline{M}_{*0} \cup \Omega_{*1}$	M_{*1}	V	6.14
$\Omega_{1*} \cup C_0$	Ω_{0*}	M	[18]	$\overline{M}_{*0} \cup \Omega_{11}$	M_{01}	V	6.14
$\Omega_{*1} \cup C_0$	Ω_{*1}	M	[18]	$\overline{M}_{1*} \cup A_{11}^2$	M_{0*}	V_{*1}	6.14
$\Omega_{01} \cup C$	Ω_{01}	M	[18]	$M_{01} \cup \Omega_{1*}$	M_{01}	V_{*1}	6.14
$\Omega_{01} \cup C_0$	Ω_{01}	M_{0*}	[18]	$M_{01} \cup \Omega_{11}$	M_{01}	V_{*1}	6.14
$\Omega_{01} \cup C_1$	Ω_{01}	M_{*1}	[18]	$\overline{M}_{10} \cup \Omega_{*1}$	M_{01}	V_{*1}	6.14
$\Omega_{10} \cup C$	Ω_{01}	M	[18]	$\overline{M}_{10} \cup \Omega_{11}$	M_{01}	V_{*1}	6.14
$\Omega_{10} \cup C_0$	Ω_{01}	M_{0*}	[18]	M	M	M	[18]
$\Omega_{10} \cup C_1$	Ω_{01}	M_{*1}	[18]	M_{0*}	M_{0*}	M_{0*}	[18]
$\Omega_{00} \cup C_1$	Ω_{01}	M	[18]	M_{*1}	M_{*1}	M_{*1}	[18]
$\Omega_{11} \cup C_0$	Ω_{01}	M	[18]	M_{01}	M_{01}	M_{01}	[18]
Ω_{0*}	Ω_{0*}	Ω_{0*}	[18]	\overline{M}	M	M	[18]
Ω_{*0}	Ω_{*1}	Ω_{0*}	[18]	\overline{M}_{*0}	M_{*1}	M_{0*}	[18]
Ω_{1*}	Ω_{0*}	Ω_{*1}	[18]	\overline{M}_{1*}	M_{0*}	M_{*1}	[18]
Ω_{*1}	Ω_{*1}	Ω_{*1}	[18]	\overline{M}_{10}	M_{01}	M_{01}	[18]
Ω_{01}	Ω_{01}	Ω_{01}	[18]	$A_{11}^2 \cup C$	M_{01}	V	6.14
Ω_{10}	Ω_{01}	Ω_{01}	[18]	$A_{11}^{\leq 2}$	M_{01}	V_{*1}	6.14
Ω_{00}	Ω_{01}	Ω_{0*}	[18]	C	Ω	Ω	[18]
Ω_{11}	Ω_{01}	Ω_{*1}	[18]	C_0	Ω	Ω_{0*}	[18]
$M \cup \overline{M} \cup \Omega_{11}$	M_{01}	V	6.14	C_1	Ω	Ω_{*1}	[18]
$M \cup \overline{M} \cup A_{11}^2$	M	V	6.14	\emptyset	Ω	Ω	[18]

TABLE 6.2. (M_{01}, V_{01}) -clonoids and their stability under right and left composition with clones of Boolean functions.

remaining 19 clonoids, which are all contained in the interval $[A_{11}^{\leq 2}, \Omega_{\neq,11} \cup C_0]$ in $\mathcal{L}_{(M_{01}, V_{01})}$.

Lemma 6.15.

- (i) $\{\neg\}A_{11}^2 \not\subseteq \Omega_{\neq,11} \cup C_0$.
- (ii) $\{\wedge\}A_{11}^2 \not\subseteq \Omega_{\neq,00} \cup A_{11}^{\leq 2}$ and $\{\vee\}A_{11}^2 \not\subseteq \Omega_{\neq,00} \cup A_{11}^{\leq 2}$.
- (iii) $\{\wedge\}(M_{01} \cup \overline{M}_{10}) \not\subseteq \Omega_{\neq,11} \cup C_0$.
- (iv) $\{\wedge\}(M_{01} \cup A_{11}^2) \not\subseteq \Omega_{\geq} \cup M$ and $\{\vee\}(M_{01} \cup A_{11}^2) \not\subseteq \Omega_{\geq} \cup M$.
- (v) $\{\wedge\}\overline{M}_{10} \cup A_{11}^2 \not\subseteq \Omega_{\leq} \cup \overline{M}$ and $\{\vee\}\overline{M}_{10} \cup A_{11}^2 \not\subseteq \Omega_{\leq} \cup \overline{M}$.
- (vi) If $0 \in K$ and $\{\wedge\}K \not\subseteq K$, then $\{\vee\}K \not\subseteq K$.

Proof. (i) We have $\leftrightarrow \in A_{11}^2$, but $\neg(\leftrightarrow) = + \notin \Omega_{\neq,11} \cup C_0$.

(ii) We have $\lambda_{11101}, \lambda_{10111}, \lambda_{10001} \in A_{11}^2$, but $\wedge(\lambda_{11101}, \lambda_{10111}) = \lambda_{10101} \in A_{11}^4$ and $\lambda_{10001} \vee (\lambda_{11101} \wedge \lambda_{10111}) = \lambda_{10101} \in A_{11}^4$, and these are not in $\Omega_{\neq,00} \cup A_{11}^{\leq 2}$.

(iii) We have $\lambda_{011} \in M_{01}$ and $\lambda_{110} \in \overline{M}_{10}$, but $\wedge(\lambda_{011}, \lambda_{110}) = \lambda_{010} \in A_{00}^2$, which is disjoint from $\Omega_{\neq,11} \cup C_0$.

(iv) We have $\lambda_{0111}, \lambda_{0001} \in M_{01}$ and $\lambda_{1101} \in A_{11}^2$, but $\wedge(\lambda_{0111}, \lambda_{1101}) = \lambda_{0101} \in A_{01}^3$ and $\lambda_{0001} \vee (\lambda_{0111} \wedge \lambda_{1101}) = \lambda_{0101} \in A_{01}^3$, and these are not in $\Omega_{\geq} \cup M$.

(v) The proof is similar to (iv).

(vi) Because $\{\wedge\}K \not\subseteq K$, there exist $f, g \in K$ such that $f \wedge g \notin K$. Consequently, $0 \vee (f \wedge g) = f \wedge g \notin K$, which shows $\{\vee\}K \not\subseteq K$. \square

Lemma 6.16.

- (i) $A_{11}^2 \langle \neg \rangle \not\subseteq \Omega_{\neq,11} \cup C_0$.
- (ii) $A_{11}^2 \langle +_3 \rangle \not\subseteq \Omega_{\neq,00} \cup A_{11}^{\leq 2}$.
- (iii) $\{\text{id}\} \langle +_3 \rangle \not\subseteq \Omega_{\geq} \cup M_{01}$.
- (iv) $\{\neg\} \langle +_3 \rangle \not\subseteq \Omega_{\leq} \cup \overline{M}_{10}$.
- (v) $\{\text{id}\} \langle 0 \rangle \not\subseteq \Omega_{\neq,11}$.
- (vi) $A_{11}^2 \langle 0 \rangle \not\subseteq \Omega_{\leq}$.
- (vii) $A_{11}^4 \langle 0 \rangle \not\subseteq \Omega_{\leq} \cup \overline{M}_{10}$.
- (viii) $A_{01}^3 \langle 0 \rangle \not\subseteq \Omega_{\neq,11} \cup C_0$.
- (ix) $\{\neg\} \langle 1 \rangle \not\subseteq \Omega_{\neq,00}$.
- (x) $A_{11}^2 \langle 1 \rangle \not\subseteq \Omega_{\geq}$.
- (xi) $A_{11}^4 \langle 1 \rangle \not\subseteq \Omega_{\geq} \cup M_{01}$.
- (xii) $A_{10}^3 \langle 1 \rangle \not\subseteq \Omega_{\neq,11} \cup C_0$.

Proof. We apply Lemma 2.8.

(i) We have $\lambda_{101} = x_1 + x_2 + 1 \in A_{11}^2$, but $\lambda_{101} * \neg = + \in \Omega_{00} \setminus C_0$, and this is not in $\Omega_{\neq,11} \cup C_0$.

(ii) We have $\lambda_{101} \in A_{11}^2$, but $\lambda_{101} * +_3 = \lambda_{10101} \in A_{11}^4$, and this is not in $\Omega_{\neq,00} \cup A_{11}^{\leq 2}$.

(iii) We have $\text{id} * +_3 = +_3 = \lambda_{0101}$, which is not in $\Omega_{\geq} \cup M_{01}$.

(iv) The proof is similar to (iii).

(v) We have $\text{id} * 0 = 0 \notin \Omega_{\neq,11}$.

(vi) We have $\lambda_{101} \in A_{11}^2$, but $\lambda_{101} * 0 = \lambda_{10} \notin \Omega_{\leq}$.

(vii) We have $\lambda_{10101} \in A_{11}^4$, but $\lambda_{10101} * 0 = \lambda_{1010} \notin \Omega_{\leq} \cup \overline{M}_{10}$.

(viii) We have $+_3 = \lambda_{0101} \in A_{01}^3$, but $\lambda_{0101} * 0 = \lambda_{010} \notin \Omega_{\neq,11} \cup C_0$.

(ix) The proof is similar to (v).

(x) The proof is similar to (vi).

(xi) The proof is similar to (vii).

(xii) The proof is similar to (viii). \square

Proof of Theorem 6.14. For 37 out of the 56 (M_{01}, V_{01}) -clonoids K , the clones C_1^K and C_2^K have already been determined in [18, Theorem 5.1, Table 1]. These are indicated in Table 6.2 with “[18]” in the source column and in Figure 6.5 as the vertices drawn as hollow circles. From now on, we assume that K is one of the remaining (M_{01}, V_{01}) -clonoids: $\Omega_{\neq,11} \cup C_0$, $M \cup \overline{M} \cup \Omega_{11}$, $M \cup \overline{M} \cup A_{11}^2$, $M_{01} \cup \overline{M}_{10} \cup \Omega_{11}$, $M_{01} \cup \overline{M}_{10} \cup A_{11}^{\leq 2}$, $M \cup A_{11}^2$, $M_{0*} \cup \Omega_{1*}$, $M_{0*} \cup \Omega_{11}$, $M_{*1} \cup A_{11}^2$, $\overline{M} \cup A_{11}^2$, $\overline{M}_{*0} \cup \Omega_{*1}$, $\overline{M}_{*0} \cup \Omega_{11}$, $\overline{M}_{1*} \cup A_{11}^2$, $M_{01} \cup \Omega_{1*}$, $M_{01} \cup \Omega_{11}$, $\overline{M}_{10} \cup \Omega_{*1}$, $\overline{M}_{10} \cup \Omega_{11}$, $A_{11}^2 \cup C$, $A_{11}^{\leq 2}$.

We focus first on stability on left composition with a clone. We obviously have $V_{01}K \subseteq K$ because K is an (M_{01}, V_{01}) -clonoid. Moreover, $C_1 \subseteq K$, so $\{1\}K \subseteq C_1 \subseteq K$. On the other hand, we have $\{0\}K \subseteq K$ if and only if $C_0 \subseteq K$. This condition holds precisely when K is one of $\Omega_{\neq,11} \cup C_0$, $M \cup \overline{M} \cup \Omega_{11}$, $M \cup \overline{M} \cup A_{11}^2$, $M \cup A_{11}^2$, $M_{0*} \cup \Omega_{1*}$, $M_{0*} \cup \Omega_{11}$, $\overline{M} \cup A_{11}^2$, $\overline{M}_{*0} \cup \Omega_{*1}$, $\overline{M}_{*0} \cup \Omega_{11}$, $A_{11}^2 \cup C$, which we will refer to as the “clonoids with zero”.

Because $A_{11}^{\leq 2} \subseteq K \subseteq \Omega_{\neq,11} \cup C_0$, it follows from Lemma 6.15(i) that $\{\neg\}K \not\subseteq K$.

Because one of the conditions

$$\begin{aligned} A_{11}^2 \subseteq K \subseteq \Omega_{\neq,00} \cup A_{11}^{\leq 2}, & & M_{01} \cup \overline{M}_{10} \subseteq K \subseteq \Omega_{\neq,11} \cup C_0, \\ M_{01} \cup A_{11}^2 \subseteq K \subseteq \Omega_{\geq} \cup M, & & \overline{M}_{10} \cup A_{11}^2 \subseteq K \subseteq \Omega_{\leq} \cup \overline{M} \end{aligned}$$

holds, it follows from Lemma 6.15(ii)–(v) that $\{\wedge\}K \not\subseteq K$.

Moreover, because one of the conditions

$$\begin{aligned} A_{11}^2 \subseteq K \subseteq \Omega_{\neq,00} \cup A_{11}^{\leq 2}, & \quad 0 \in K, \\ M_{01} \cup A_{11}^2 \subseteq K \subseteq \Omega_{\geq} \cup M, & \quad \overline{M}_{10} \cup A_{11}^2 \subseteq K \subseteq \Omega_{\leq} \cup \overline{M} \end{aligned}$$

holds, it follows from Lemma 6.15(ii), (iv)–(vi) that $\{\vee\}K \not\subseteq K$.

We conclude that $CK \subseteq K$ if and only if (K is not a clonoid with zero and $C \subseteq V_{*1}$) or (K is a clonoid with zero and $C \subseteq V$).

We now focus on stability under right composition with clones. We obviously have $KM_{01} \subseteq K$ because K is a (M_{01}, V_{01}) -clonoid.

Because $A_{11}^{\leq 2} \subseteq K \subseteq \Omega_{\neq,11} \cup C_0$, it follows from Lemma 6.16(i) that $K\langle \neg \rangle \not\subseteq K$.

It is easy to verify that if $K = \Omega_{\neq,11} \cup C_0$, then $K\langle +_3 \rangle \subseteq K$. (For, note that $\langle +_3 \rangle \subseteq \Omega_{01}$, and therefore, for any $a, b \in \{0, 1\}$ and for $f \in \Omega_{ab}$ and $g_1, \dots, g_n \in \Omega_{01}$, we have $f(g_1, \dots, g_n)(\mathbf{0}) = f(\mathbf{0}) = a$ and $f(g_1, \dots, g_n)(\mathbf{1}) = f(\mathbf{1}) = b$; thus $f(g_1, \dots, g_n) \in \Omega_{ab}$. Moreover, if $f = 0$, then $f(g_1, \dots, g_n) = 0$.)

If $K \neq \Omega_{\neq,11} \cup C_0$, then one of the conditions

$$A_{11}^2 \subseteq K \subseteq \Omega_{\neq,00} \cup A_{11}^{\leq 2}, \quad \{\text{id}\} \subseteq K \subseteq \Omega_{\geq} \cup M_{01}, \quad \{\neg\} \subseteq K \subseteq \Omega_{\leq} \cup \overline{M}_{10}$$

holds, and it follows from Lemma 6.16(ii)–(iv) that $K\langle +_3 \rangle \not\subseteq K$.

Let us consider stability under right composition with $\langle 0 \rangle$. Note that $\langle 0 \rangle = l_0 \subseteq M_{0*}$. Therefore, $M_{0*}\langle 0 \rangle \subseteq M_{0*}$, $\overline{M}_{1*}\langle 0 \rangle = \overline{M}_{0*}\langle 0 \rangle = \overline{M}_{0*}\langle 0 \rangle \subseteq \overline{M}_{0*} = \overline{M}_{1*}$. $C\langle 0 \rangle = C$, and, moreover, by Lemma 6.5, $A_{11}^2\langle 0 \rangle \subseteq A_{1*}^{\leq 2} = A_{11}^2 \cup \overline{M}_{1*}$. Using Lemma 2.3, we get that if K is one of $M \cup \overline{M} \cup A_{11}^2$, $M_{0*} \cup \Omega_{1*}$, $\overline{M} \cup A_{11}^2$, $\overline{M}_{1*} \cup A_{11}^2$, then $K\langle 0 \rangle \subseteq K$.

If K is not one of $M \cup \overline{M} \cup A_{11}^2$, $M_{0*} \cup \Omega_{1*}$, $\overline{M} \cup A_{11}^2$, $\overline{M}_{1*} \cup A_{11}^2$, then one of the conditions

$$\begin{aligned} \{\text{id}\} \subseteq K \subseteq \Omega_{\neq,11}, & \quad A_{11}^2 \subseteq K \subseteq \Omega_{\leq}, \\ A_{11}^4 \subseteq K \subseteq \Omega_{\leq} \cup \overline{M}_{10}, & \quad A_{01}^3 \subseteq K \subseteq \Omega_{\neq,11} \cup C_0 \end{aligned}$$

holds, and it follows from Lemma 6.16(v)–(viii) that $K\langle 0 \rangle \not\subseteq K$.

Let us consider stability under right composition with $\langle 1 \rangle$. Note that $\langle 1 \rangle = l_1 \subseteq M_{*1}$. Therefore, $M_{*1}\langle 1 \rangle \subseteq M_{*1}$, $\overline{M}_{*0}\langle 1 \rangle = \overline{M}_{*1}\langle 1 \rangle = \overline{M}_{*1}\langle 1 \rangle \subseteq \overline{M}_{*1} = \overline{M}_{*0}$. $C\langle 1 \rangle = C$, and, moreover, by Lemma 6.5, $A_{11}^2\langle 1 \rangle \subseteq A_{*1}^{\leq 2} = A_{11}^2 \cup M_{*1}$. Using Lemma 2.3, we get that if K is one of $M \cup \overline{M} \cup A_{11}^2$, $\overline{M}_{*0} \cup \Omega_{*1}$, $M \cup A_{11}^2$, $M_{*1} \cup A_{11}^2$, then $K\langle 1 \rangle \subseteq K$.

If K is not one of $M \cup \overline{M} \cup A_{11}^2$, $\overline{M}_{*0} \cup \Omega_{*1}$, $M \cup A_{11}^2$, $M_{*1} \cup A_{11}^2$, then one of the conditions

$$\begin{aligned} \{\neg\} \subseteq K \subseteq \Omega_{\neq,00}, & \quad A_{11}^2 \subseteq K \subseteq \Omega_{\geq}, \\ A_{11}^4 \subseteq K \subseteq \Omega_{\geq} \cup M_{01}, & \quad A_{10}^3 \subseteq K \subseteq \Omega_{\neq,11} \cup C_0 \end{aligned}$$

holds, and it follows from Lemma 6.16(ix)–(xii) that $K\langle 1 \rangle \not\subseteq K$.

Putting these facts together, we obtain that

- if $K = \Omega_{\neq,11} \cup C_0$, then $KC \subseteq K$ if and only if $C \subseteq \langle M_{01} \cup \{+3\} \rangle = \Omega_{01}$,
- if $K = M \cup \overline{M} \cup A_{11}^2$, then $KC \subseteq K$ if and only if $C \subseteq \langle M_{01} \cup \{0, 1\} \rangle = M$,
- if $K \in \{M_{0*} \cup \Omega_{1*}, \overline{M} \cup A_{11}^2, \overline{M}_{1*} \cup A_{11}^2\}$, then $KC \subseteq K$ if and only if $C \subseteq \langle M_{01} \cup \{0\} \rangle = M_{0*}$,
- if $K \in \{\overline{M}_{*0} \cup \Omega_{*1}, M \cup A_{11}^2, M_{*1} \cup A_{11}^2\}$, then $KC \subseteq K$ if and only if $C \subseteq \langle M_{01} \cup \{1\} \rangle = M_{*1}$,
- otherwise, $KC \subseteq K$ if and only if $C \subseteq M_{01}$.

This is presented explicitly in Table 6.2. □

7. CLONIDS WITH A DISCRIMINATOR SOURCE CLONE

It was shown in [21, Corollary 4.2] that if C is a *discriminator clone* on a finite set A i.e., a clone containing the *discriminator function*

$$t(x, y, z) = \begin{cases} z, & \text{if } x = y, \\ x, & \text{if } x \neq y, \end{cases}$$

then there are only a finite number of C -equivalence classes in \mathcal{O}_A . In the case of Boolean functions, the discriminator clones are precisely the superclones of the clone S_{01} of idempotent self-dual functions. The C -equivalence classes and the C -minor poset were explicitly described for each discriminator clone C on $\{0, 1\}$ in [21, Section 5]. We are going to rephrase this result below in Theorem 7.1. For this, the following notation will be used. For $f: \{0, 1\}^n \rightarrow \{0, 1\}$, let $\text{Im}^{[2]}(f) := \{ \{f(\mathbf{a}), f(\bar{\mathbf{a}})\} \mid \mathbf{a} \in \{0, 1\}^n \}$, and for a nonempty subset R of $\{\{0\}, \{1\}, \{0, 1\}\}$, let

$$F^R := \{ f \in \Omega \mid \text{Im}^{[2]}(f) = R \}.$$

In order to simplify this notation, we are going to omit set brackets when we list elements of R ; for example, we are going to write $F_{01}^{0,1,01}$ for $F_{01}^{\{\{0\}, \{1\}, \{0,1\}\}}$.

Theorem 7.1 ([21, Section 5]).

- (i) *There are exactly 16 $\equiv_{S_{01}}$ -equivalence classes; they are the sets of the form F_{ab}^R , where $\emptyset \neq R \subseteq \{\{0\}, \{1\}, \{0, 1\}\}$ and $(a, b) \in \{0, 1\}^2$ with $\{a, b\} \in R$. The S_{01} -minor poset is shown in Figure 7.1.*
- (ii) *There are exactly 7 \equiv_S -equivalence classes; they are the sets of the form F^R , where $\emptyset \neq R \subseteq \{\{0\}, \{1\}, \{0, 1\}\}$. The S -minor poset is shown in Figure 7.3.*
- (iii) *There are exactly 6 $\equiv_{\Omega_{01}}$ -equivalence classes; they are $C_0, C_1, \Omega_{00} \setminus C_0, \Omega_{11} \setminus C_1, \Omega_{01}, \Omega_{10}$. The Ω_{01} -minor poset is shown in Figure 7.5.*
- (iv) *There are exactly 4 $\equiv_{\Omega_{0*}}$ -equivalence classes; they are $C_0, C_1, \Omega_{0*} \setminus C_0, \Omega_{1*} \setminus C_1$. The Ω_{0*} -minor poset is shown in Figure 7.7.*
- (v) *There are exactly 4 $\equiv_{\Omega_{*1}}$ -equivalence classes; they are $C_0, C_1, \Omega_{*0} \setminus C_0, \Omega_{*1} \setminus C_1$. The Ω_{*1} -minor poset is shown in Figure 7.9.*
- (vi) *There are exactly 3 \equiv_Ω -equivalence classes; they are $C_0, C_1, \Omega \setminus C$. The Ω -minor poset is shown in Figure 7.11.*

Theorem 7.2.

- (i) *There are exactly 1296 (S_{01}, J) -clonoids; they are the sets of the form $A \cup B \cup C \cup D$, where*

$$A \in \{\emptyset, C_0, R_{00}, S_{00}^-, R_{00} \cup S_{00}^-, \Omega_{00}\}, \quad B \in \{\emptyset, S_{01}, S_{01}^+, S_{01}^-, S_{01}^+ \cup S_{01}^-, \Omega_{01}\},$$

$$C \in \{\emptyset, S_{10}, S_{10}^+, S_{10}^-, S_{10}^+ \cup S_{10}^-, \Omega_{10}\}, \quad D \in \{\emptyset, C_1, S_{11}^+, R_{11}, S_{11}^+ \cup R_{11}, \Omega_{11}\}.$$

The lattice of (S_{01}, J) -clonoids is isomorphic to the direct product of four 6-element lattices as shown in Figure 7.2.

- (ii) *There are exactly 19 (S, J) -clonoids; they are*

$$\begin{array}{cccccc} \Omega, & R \cup S^- \cup S^+, & R \cup S^-, & R \cup S^+, & S^- \cup S^+, & \\ S^+ \cup C_0, & S^- \cup C_1, & R \cup S, & S^-, & S^+, & R, \\ S \cup C, & S \cup C_0, & S \cup C_1, & S, & C, & C_0, C_1, \emptyset. \end{array}$$

The lattice of (S, J) -clonoids is shown in Figure 7.4.

- (iii) *There are exactly 36 (Ω_{01}, J) -clonoids; they are the sets of the form $A \cup B \cup C \cup D$, where*

$$A \in \{\emptyset, C_0, \Omega_{00}\}, \quad B \in \{\emptyset, \Omega_{01}\}, \quad C \in \{\emptyset, \Omega_{10}\}, \quad D \in \{\emptyset, C_1, \Omega_{11}\}.$$

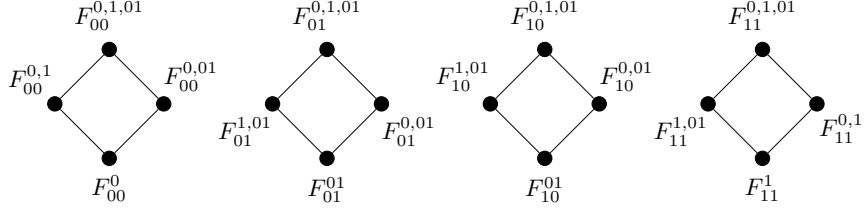
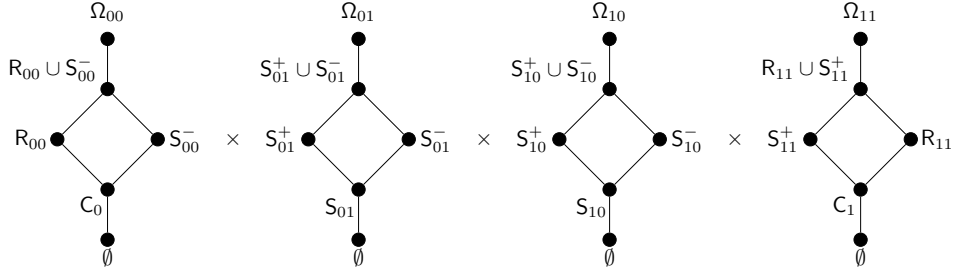
FIGURE 7.1. S_{01} -minor poset.FIGURE 7.2. (S_{01}, J) -clonoids. The lattice $\mathcal{L}_{(S_{01}, J)}$ is isomorphic to the direct product of four 6-element lattices. For the element (A, B, C, D) of the direct product, the corresponding clonoid is $A \cup B \cup C \cup D$.

The lattice of (Ω_{01}, J) -clonoids is shown in Figure 7.6.

- (iv) There are exactly 9 (Ω_{0*}, J) -clonoids; they are the sets of the form $A \cup B$, where $A \in \{\emptyset, C_0, \Omega_{0*}\}$ and $B \in \{\emptyset, C_1, \Omega_{1*}\}$. The lattice of (Ω_{0*}, J) -clonoids is shown in Figure 7.8.
- (v) There are exactly 9 (Ω_{*1}, J) -clonoids; they are the sets of the form $A \cup B$, where $A \in \{\emptyset, C_0, \Omega_{*0}\}$ and $B \in \{\emptyset, C_1, \Omega_{*1}\}$. The lattice of (Ω_{*1}, J) -clonoids is shown in Figure 7.10.
- (vi) There are exactly 5 (Ω, J) -clonoids; they are $\Omega, C, C_0, C_1, \emptyset$. The lattice of (Ω, J) -clonoids is shown in Figure 7.12.

Proof. This follows from Theorem 7.1 by applying Lemma 4.2. The (C, J) -clonoids are precisely the downsets of the C -minor quasi-order, and the latter are easy to determine from the Hasse diagram of the C -minor poset. \square

Remark 7.3. Because the $\leq_{S_{01}}$ -minor poset is disconnected with four connected components, its lattice of downsets is isomorphic to the direct product of the lattices of downsets of the four connected components (which are isomorphic to each other). The lattice has $6^4 = 1296$ elements; it is too large for its Hasse diagram being presented explicitly here. We simply give it as the direct product of the downset lattices of the four connected components; see Figure 7.2. For the element (A, B, C, D) of the direct product, the corresponding (S_{01}, J) -clonoid is $A \cup B \cup C \cup D$.

With the help of Theorem 7.2, it is now possible to determine the (C_1, C_2) -clonoids for clones C_1 and C_2 such that $S_{01} \subseteq C_1$ and C_2 is arbitrary. By Lemma 2.5, such (C_1, C_2) -clonoids are (S_{01}, J) -clonoids; it is just a matter of identifying them among the (S_{01}, J) -clonoids that were determined above. We start with the cases where the target clone is essentially at most unary.

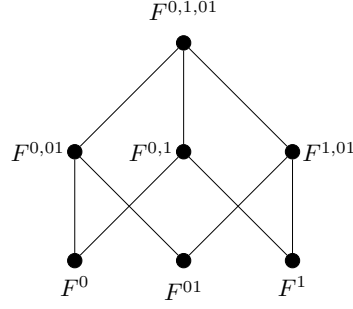

FIGURE 7.3. S-minor poset.

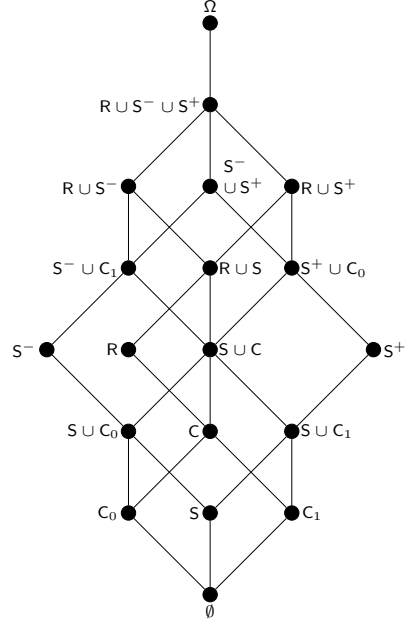

FIGURE 7.4. (S, J)-clonoids.

Proposition 7.4.

- (i) (a) *There are exactly 1081 (S_{01}, l_0) -clonoids; they are \emptyset and those (S_{01}, J) -clonoids K with $C_0 \subseteq K$.*
- (b) *There are exactly 1081 (S_{01}, l_1) -clonoids; they are \emptyset and those (S_{01}, J) -clonoids K with $C_1 \subseteq K$.*
- (c) *There are exactly 901 (S_{01}, l) -clonoids; they are \emptyset and those (S_{01}, J) -clonoids K with $C \subseteq K$.*
- (d) *There are exactly 36 (S_{01}, l^*) -clonoids; they are the sets of the form $A \cup B$, where*

$$A \in \{\emptyset, C, R, S_{00}^- \cup S_{11}^+, R \cup S_{00}^- \cup S_{11}^+, \Omega_=\},$$

$$B \in \{\emptyset, S, S_{01}^+ \cup S_{10}^-, S_{01}^- \cup S_{10}^+, S_{\neq}^+ \cup S_{\neq}^-, \Omega_{\neq}\}.$$

- (e) *There are exactly 31 $(S_{01}, \Omega(1))$ -clonoids; they are \emptyset and those (S_{01}, l^*) -clonoids K with $C \subseteq K$.*
- (ii) (a) *There are exactly 15 (S, l_0) -clonoids; they are $\Omega, R \cup S^- \cup S^+, R \cup S^-, R \cup S^+, S^- \cup S^+, S^+ \cup C_0, S^- \cup C_1, R \cup S, S^-, R, S \cup C, S \cup C_0, C, C_0, \emptyset$.*
- (b) *There are exactly 15 (S, l_1) -clonoids; they are $\Omega, R \cup S^- \cup S^+, R \cup S^-, R \cup S^+, S^- \cup S^+, S^+ \cup C_0, S^- \cup C_1, R \cup S, S^+, R, S \cup C, S \cup C_1, C, C_1, \emptyset$.*
- (c) *There are exactly 12 (S, l) -clonoids; they are $\Omega, R \cup S^- \cup S^+, R \cup S^-, R \cup S^+, S^- \cup S^+, S^+ \cup C_0, S^- \cup C_1, R \cup S, R, S \cup C, C, \emptyset$.*
- (d) *There are exactly 9 (S, l^*) -clonoids; they are $\Omega, R \cup S^- \cup S^+, S^- \cup S^+, R \cup S, R, S \cup C, S, C, \emptyset$.*
- (e) *There are exactly 8 $(S, \Omega(1))$ -clonoids; they are $\Omega, R \cup S^- \cup S^+, S^- \cup S^+, R \cup S, R, S \cup C, C, \emptyset$.*
- (iii) (a) *There are exactly 25 (Ω_{01}, l_0) -clonoids; they are \emptyset and the (Ω_{01}, J) -clonoids K with $C_0 \subseteq K$.*

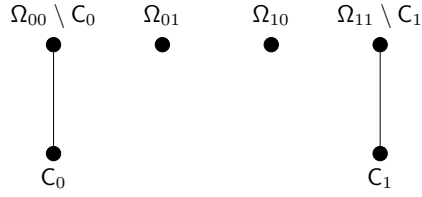

FIGURE 7.5. Ω_{01} -minor poset.

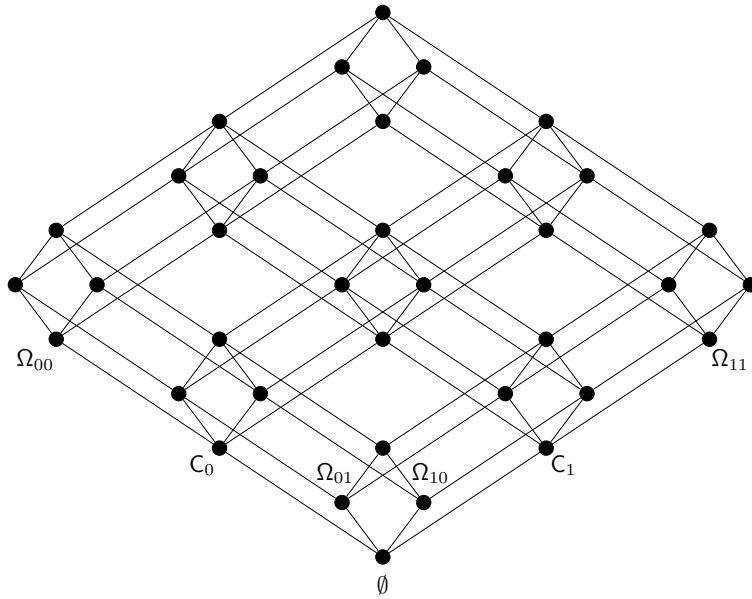

FIGURE 7.6. (Ω_{01}, J) -clonoids. Only the join-irreducible elements are named in the diagram. The remaining clonoids are unions of the join-irreducible ones.

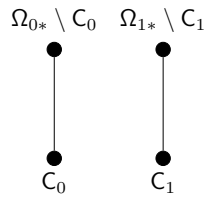

FIGURE 7.7. Ω_{0^*} -minor poset.

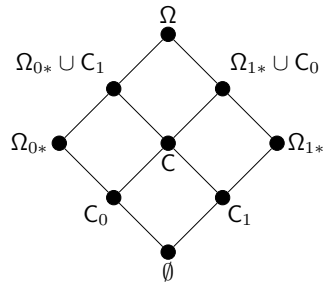
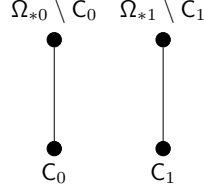
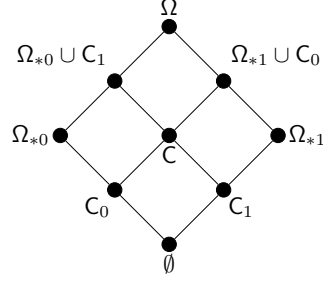
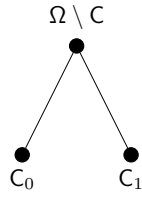
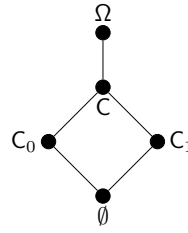

FIGURE 7.8. (Ω_{0^*}, J) -clonoids.

- (b) There are exactly 25 (Ω_{01}, I_1) -clonoids; they are \emptyset and the (Ω_{01}, J) -clonoids K with $C_1 \subseteq K$.
- (c) There are exactly 17 (Ω_{01}, I) -clonoids; they are \emptyset and the (Ω_{01}, J) -clonoids K with $C \subseteq K$.

FIGURE 7.9. Ω_{*1} -minor poset.FIGURE 7.10. (Ω_{*1}, J) -clonoids.FIGURE 7.11. Ω -minor poset.FIGURE 7.12. (Ω, J) -clonoids.

- (d) There are exactly 6 (Ω_{01}, l^*) -clonoids; they are Ω , $\Omega_{\neq} \cup C$, Ω_{\neq} , $\Omega_{=}$, C , \emptyset .
- (e) There are exactly 5 $(\Omega_{01}, \Omega(1))$ -clonoids; they are Ω , $\Omega_{\neq} \cup C$, $\Omega_{=}$, C , \emptyset .
- (iv) (a) There are exactly 7 (Ω_{0*}, l_0) -clonoids; they are Ω , $\Omega_{0*} \cup C_1$, $\Omega_{1*} \cup C_0$, Ω_{0*} , C , C_0 , \emptyset .
- (b) There are exactly 7 (Ω_{0*}, l_1) -clonoids; they are Ω , $\Omega_{0*} \cup C_1$, $\Omega_{1*} \cup C_0$, Ω_{1*} , C , C_1 , \emptyset .
- (c) There are exactly 5 (Ω_{0*}, l) -clonoids; they are Ω , $\Omega_{0*} \cup C_1$, $\Omega_{1*} \cup C_0$, C , \emptyset .
- (d) There are exactly 3 (Ω_{0*}, l^*) -clonoids; they are Ω , C , \emptyset .
- (e) There are exactly 3 $(\Omega_{0*}, \Omega(1))$ -clonoids; they are Ω , C , \emptyset .
- (v) (a) There are exactly 7 (Ω_{*1}, l_0) -clonoids; they are Ω , $\Omega_{*0} \cup C_1$, $\Omega_{*1} \cup C_0$, Ω_{*0} , C , C_0 , \emptyset .
- (b) There are exactly 7 (Ω_{*1}, l_1) -clonoids; they are Ω , $\Omega_{*0} \cup C_1$, $\Omega_{*1} \cup C_0$, Ω_{*1} , C , C_1 , \emptyset .
- (c) There are exactly 5 (Ω_{*1}, l) -clonoids; they are Ω , $\Omega_{*0} \cup C_1$, $\Omega_{*1} \cup C_0$, C , \emptyset .
- (d) There are exactly 3 (Ω_{*1}, l^*) -clonoids; they are Ω , C , \emptyset .
- (e) There are exactly 3 $(\Omega_{*1}, \Omega(1))$ -clonoids; they are Ω , C , \emptyset .
- (vi) (a) There are exactly 4 (Ω, l_0) -clonoids; they are Ω , C , C_0 , \emptyset .
- (b) There are exactly 4 (Ω, l_1) -clonoids; they are Ω , C , C_1 , \emptyset .
- (c) There are exactly 3 (Ω, l) -clonoids; they are Ω , C , \emptyset .
- (d) There are exactly 3 (Ω, l^*) -clonoids; they are Ω , C , \emptyset .
- (e) There are exactly 3 $(\Omega, \Omega(1))$ -clonoids; they are Ω , C , \emptyset .

Proof. This follows immediately from Theorem 7.2 and Lemmata 2.10 and 3.3. \square

The cases where the target clone C_2 includes L_c or SM have been described in earlier papers of the author's. We quote here only the results for the cases where

the target clone is L_c or SM . The results for their superclones can be found in the earlier papers, and we simply refer the reader to those papers.

Proposition 7.5 ([8, Theorem 7.1, Table 3]). *There are exactly 26 (S_{01}, L_c) -clonoids, and they are the following: Ω , Ω_{0*} , Ω_{1*} , Ω_{*0} , Ω_{*1} , $\Omega_{=}$, Ω_{\neq} , Ω_{00} , Ω_{01} , Ω_{10} , Ω_{11} , $S \cup R$, $S_{01} \cup R_{00}$, $S_{10} \cup R_{11}$, $S_{01} \cup R_{11}$, $S_{10} \cup R_{00}$, R , S , R_{00} , R_{11} , S_{01} , S_{10} , C , C_0 , C_1 , \emptyset .*

Proposition 7.6 ([18, Theorem 5.1, Table 1]). *There are precisely 57 (S_{01}, SM) -clonoids, and they are the following: Ω , Ω_{\leq} , Ω_{\geq} , $\Omega_{\neq, 00}$, $\Omega_{\neq, 11}$, $\Omega_{0*} \cup C_1$, $\Omega_{*0} \cup C_1$, $\Omega_{1*} \cup C_0$, $\Omega_{*1} \cup C_0$, Ω_{0*} , Ω_{*0} , Ω_{1*} , Ω_{*1} , $\Omega_{=}$, Ω_{\neq} , $\Omega_{01} \cup C$, $\Omega_{10} \cup C$, $\Omega_{01} \cup C_0$, $\Omega_{10} \cup C_0$, $\Omega_{01} \cup C_1$, $\Omega_{10} \cup C_1$, $\Omega_{00} \cup C_1$, $\Omega_{11} \cup C_0$, Ω_{00} , Ω_{11} , Ω_{01} , Ω_{10} , S^- , S^+ , S_{\neq}^- , S_{\neq}^+ , S_{0*}^- , S_{1*}^+ , S_{*0}^- , S_{*1}^+ , $S_{01}^- \cup C_0$, $S_{10}^+ \cup C_1$, $S_{10}^- \cup C_0$, $S_{01}^+ \cup C_1$, S_{01}^- , S_{10}^+ , S_{10}^- , S_{01}^+ , S_{00}^- , S_{11}^+ , S , S_{01} , S_{10} , R , $R_{00} \cup C$, $R_{11} \cup C$, R_{00} , R_{11} , C , C_0 , C_1 , \emptyset .*

Proposition 7.7. *There are precisely 123 (S_{01}, V_{01}) -clonoids. They are the classes listed in Table 7.1.*

The Hasse diagram of $\mathcal{L}_{(S_{01}, V_{01})}$ is shown in Figure 7.13.

Proof. By Lemma 2.5, every (S_{01}, V_{01}) -clonoid is a (S_{01}, J) -clonoid, so (S_{01}, V_{01}) -clonoids are sets of the form $A \cup B \cup C \cup D$, where A , B , C , and D are as described in Theorem 7.2(i). However, not every set of this form is a (S_{01}, V_{01}) -clonoid, and certain values for A , B , C , and D can be immediately excluded with the help of the following claims.

Claim 7.7.1. Let $K \subseteq \Omega$, and assume that $V_{01}K \subseteq K$. Let $a, b \in \{0, 1\}$.

- (i) If $S_{ab}^- \subseteq K$ and $(a, b) \neq (1, 1)$, then $\Omega_{ab} \subseteq K$.
- (ii) If $S_{a\bar{a}} \subseteq K$, then $S_{a\bar{a}}^+ \subseteq K$.

Proof of Claim 7.7.1. (i) Let $f \in \Omega_{ab}$. Define functions g and h (of the same arity as f) as follows. For $\mathbf{a} \in \{0, 1\}^n$, let

$$g(\mathbf{a}) := \begin{cases} f(\mathbf{a}), & \text{if } (f(\mathbf{a}), f(\bar{\mathbf{a}})) \neq (1, 1), \\ 0, & \text{if } (f(\mathbf{a}), f(\bar{\mathbf{a}})) = (1, 1) \text{ and } a_1 = 0, \\ 1, & \text{if } (f(\mathbf{a}), f(\bar{\mathbf{a}})) = (1, 1) \text{ and } a_1 = 1, \end{cases}$$

$$h(\mathbf{a}) := \begin{cases} f(\mathbf{a}), & \text{if } (f(\mathbf{a}), f(\bar{\mathbf{a}})) \neq (1, 1), \\ 1, & \text{if } (f(\mathbf{a}), f(\bar{\mathbf{a}})) = (1, 1) \text{ and } a_1 = 0, \\ 0, & \text{if } (f(\mathbf{a}), f(\bar{\mathbf{a}})) = (1, 1) \text{ and } a_1 = 1. \end{cases}$$

Clearly, $g, h \in S_{ab}^-$ and $f = g \vee h$. Therefore, $f \in V_{01}S_{ab}^- \subseteq V_{01}K \subseteq K$. We have thus shown that $\Omega_{ab} \subseteq K$.

(ii) If $f \in S_{a\bar{a}}^+$, then the functions g and h defined above belong to $S_{a\bar{a}}$ and $f = g \vee h$. We can then conclude that $f \in V_{01}S_{a\bar{a}} \subseteq V_{01}K \subseteq K$. This shows that $S_{a\bar{a}}^+ \subseteq K$. ■

It follows immediately from Claim 7.7.1 that every (S_{01}, V_{01}) -clonoid is of the form $A \cup B \cup C \cup D$, where

$$A \in \{\emptyset, C_0, R_{00}, \Omega_{00}\}, \quad B \in \{\emptyset, S_{01}^+, \Omega_{01}\}, \quad C \in \{\emptyset, S_{10}^+, \Omega_{10}\}, \\ D \in \{\emptyset, C_1, S_{11}^+, R_{11}, S_{11}^+ \cup R_{11}, \Omega_{11}\}.$$

We can exclude further quadruples (A, B, C, D) with the help of the following claim.

Claim 7.7.2. Let $K \subseteq \Omega$, and assume that $V_{01}K \subseteq K$. Let $a, b \in \{0, 1\}$.

- (i) If $\Omega_{01} \cup \Omega_{10} \subseteq K$, then $\Omega_{11} \subseteq K$.

A	B	C	D	K	$KC \subseteq K$ iff $C \subseteq \dots$	$CK \subseteq K$ iff $C \subseteq \dots$	source
\emptyset	\emptyset	\emptyset	\emptyset	\emptyset	Ω	Ω	[18]
\emptyset	\emptyset	\emptyset	C_1	C_1	Ω	Ω_{*1}	[18]
\emptyset	\emptyset	\emptyset	S_{11}^+	S_{11}^+	S_{01}	W^2	[18]
\emptyset	\emptyset	\emptyset	R_{11}	R_{11}	S_{01}	Ω_{*1}	[18]
\emptyset	\emptyset	\emptyset	$S_{11}^+ \cup R_{11}$	$S_{11}^+ \cup R_{11}$	S_{01}	V_{*1}	7.8
\emptyset	\emptyset	\emptyset	Ω_{11}	Ω_{11}	Ω_{01}	Ω_{*1}	[18]
\emptyset	\emptyset	S_{10}^+	\emptyset	S_{10}^+	S_{01}	W_{01}^2	[18]
\emptyset	\emptyset	S_{10}^+	C_1	$S_{10}^+ \cup C_1$	S_{01}	MW^2	[18]
\emptyset	\emptyset	S_{10}^+	S_{11}^+	S_{11}^+	S_{01}	W^2	[18]
\emptyset	\emptyset	S_{10}^+	$S_{11}^+ \cup R_{11}$	$S_{11}^+ \cup R_{11}$	S_{01}	V_{*1}	7.8
\emptyset	\emptyset	S_{10}^+	Ω_{11}	$S_{10}^+ \cup \Omega_{11}$	S_{01}	W^3	7.8
\emptyset	\emptyset	Ω_{10}	\emptyset	Ω_{10}	Ω_{01}	Ω_{01}	[18]
\emptyset	\emptyset	Ω_{10}	C_1	$\Omega_{10} \cup C_1$	Ω_{01}	M_{*1}	[18]
\emptyset	\emptyset	Ω_{10}	S_{11}^+	$\Omega_{10} \cup S_{11}^+$	S_{01}	V_{*1}	7.8
\emptyset	\emptyset	Ω_{10}	Ω_{11}	Ω_{1*}	Ω_{0*}	Ω_{*1}	[18]
\emptyset	S_{01}^+	\emptyset	\emptyset	S_{01}^+	S_{01}	W_{01}^2	[18]
\emptyset	S_{01}^+	\emptyset	C_1	$S_{01}^+ \cup C_1$	S_{01}	MW^2	[18]
\emptyset	S_{01}^+	\emptyset	S_{11}^+	S_{*1}	S_{01}	W^2	[18]
\emptyset	S_{01}^+	\emptyset	$S_{11}^+ \cup R_{11}$	$S_{11}^+ \cup R_{11}$	S_{01}	V_{*1}	7.8
\emptyset	S_{01}^+	\emptyset	Ω_{11}	$S_{01}^+ \cup \Omega_{11}$	S_{01}	W^3	7.8
\emptyset	S_{01}^+	S_{10}^+	S_{11}^+	S^+	S	W^2	[18]
\emptyset	S_{01}^+	S_{10}^+	$S_{11}^+ \cup R_{11}$	$S^+ \cup R_{11}$	S_{01}	V_{*1}	7.8
\emptyset	S_{01}^+	S_{10}^+	Ω_{11}	$S^+ \cup \Omega_{11}$	S_{01}	W^3	7.8
\emptyset	S_{01}^+	Ω_{10}	S_{11}^+	$\Omega_{10} \cup S_{11}^+$	S_{01}	V_{*1}	7.8
\emptyset	S_{01}^+	Ω_{10}	Ω_{11}	$\Omega_{1*} \cup S_{01}^+$	S_{01}	W^3	7.8
\emptyset	Ω_{01}	\emptyset	\emptyset	Ω_{01}	Ω_{01}	Ω_{01}	[18]
\emptyset	Ω_{01}	\emptyset	C_1	$\Omega_{01} \cup C_1$	Ω_{01}	M_{*1}	[18]
\emptyset	Ω_{01}	\emptyset	S_{11}^+	$\Omega_{01} \cup S_{11}^+$	S_{01}	V_{*1}	7.8
\emptyset	Ω_{01}	\emptyset	Ω_{11}	Ω_{*1}	Ω_{*1}	Ω_{*1}	[18]
\emptyset	Ω_{01}	S_{10}^+	S_{11}^+	$\Omega_{01} \cup S^+$	S_{01}	V_{*1}	7.8
\emptyset	Ω_{01}	S_{10}^+	Ω_{11}	$S^+ \cup \Omega_{*1}$	S_{01}	W^3	7.8
\emptyset	Ω_{01}	Ω_{10}	Ω_{11}	$\Omega_{\neq,11}$	Ω_{01}	W^2	[18]
C_0	\emptyset	\emptyset	\emptyset	C_0	Ω	Ω_{0*}	[18]
C_0	\emptyset	\emptyset	C_1	C	Ω	Ω	[18]
C_0	\emptyset	\emptyset	S_{11}^+	$S_{11}^+ \cup C_0$	S_{01}	V	7.8
C_0	\emptyset	\emptyset	R_{11}	$R_{11} \cup C_0$	S_{01}	M	[18]
C_0	\emptyset	\emptyset	$S_{11}^+ \cup R_{11}$	$S_{11}^+ \cup R_{11} \cup C_0$	S_{01}	V	7.8
C_0	\emptyset	\emptyset	Ω_{11}	$\Omega_{11} \cup C_0$	Ω_{01}	M	[18]
C_0	\emptyset	S_{10}^+	\emptyset	$S_{10}^+ \cup C_0$	S_{01}	V_{0*}	7.8
C_0	\emptyset	S_{10}^+	C_1	$S_{10}^+ \cup C$	S_{01}	V	7.8
C_0	\emptyset	S_{10}^+	S_{11}^+	$S_{11}^+ \cup C_0$	S_{01}	V	7.8
C_0	\emptyset	S_{10}^+	$S_{11}^+ \cup R_{11}$	$S_{11}^+ \cup R_{11} \cup C_0$	S_{01}	V	7.8
C_0	\emptyset	S_{10}^+	Ω_{11}	$S_{10}^+ \cup \Omega_{11} \cup C_0$	S_{01}	V	7.8
C_0	\emptyset	Ω_{10}	\emptyset	$\Omega_{10} \cup C_0$	Ω_{01}	M_{0*}	[18]
C_0	\emptyset	Ω_{10}	C_1	$\Omega_{10} \cup C$	Ω_{01}	M	[18]
C_0	\emptyset	Ω_{10}	S_{11}^+	$\Omega_{10} \cup S_{11}^+ \cup C_0$	S_{01}	V	7.8
C_0	\emptyset	Ω_{10}	Ω_{11}	$\Omega_{1*} \cup C_0$	Ω_{0*}	M	[18]
C_0	S_{01}^+	\emptyset	\emptyset	$S_{01}^+ \cup C_0$	S_{01}	V_{0*}	7.8
C_0	S_{01}^+	\emptyset	C_1	$S_{01}^+ \cup C$	S_{01}	V	7.8
C_0	S_{01}^+	\emptyset	S_{11}^+	$S_{*1} \cup C_0$	S_{01}	V	7.8
C_0	S_{01}^+	\emptyset	$S_{11}^+ \cup R_{11}$	$S_{11}^+ \cup R_{11} \cup C_0$	S_{01}	V	7.8
C_0	S_{01}^+	\emptyset	Ω_{11}	$S_{01}^+ \cup \Omega_{11} \cup C_0$	S_{01}	V	7.8
C_0	S_{01}^+	S_{10}^+	S_{11}^+	$S^+ \cup C_0$	S	V	7.8
C_0	S_{01}^+	S_{10}^+	$S_{11}^+ \cup R_{11}$	$S^+ \cup R_{11} \cup C_0$	S_{01}	V	7.8
C_0	S_{01}^+	S_{10}^+	Ω_{11}	$S^+ \cup \Omega_{11} \cup C_0$	S_{01}	V	7.8
C_0	S_{01}^+	Ω_{10}	S_{11}^+	$\Omega_{10} \cup S_{*1} \cup C_0$	S_{01}	V	7.8
C_0	S_{01}^+	Ω_{10}	Ω_{11}	$\Omega_{1*} \cup S_{01}^+ \cup C_0$	S_{01}	V	7.8
C_0	Ω_{01}	\emptyset	\emptyset	$\Omega_{01} \cup C_0$	Ω_{01}	M_{0*}	[18]
C_0	Ω_{01}	\emptyset	C_1	$\Omega_{01} \cup C$	Ω_{01}	M	[18]
C_0	Ω_{01}	\emptyset	S_{11}^+	$\Omega_{01} \cup S_{11}^+ \cup C_0$	S_{01}	V	7.8
C_0	Ω_{01}	\emptyset	Ω_{11}	$\Omega_{*1} \cup C_0$	Ω_{*1}	M	[18]
C_0	Ω_{01}	S_{10}^+	S_{11}^+	$\Omega_{01} \cup S^+ \cup C_0$	S_{01}	V	7.8

Continues to the next page.

TABLE 7.1. (S_{01}, V_{01}) -clonoids.

Continued from the previous page.

A	B	C	D	K	$KC \subseteq K$ iff $C \subseteq \dots$	$CK \subseteq K$ iff $C \subseteq \dots$	source
C_0	Ω_{01}	S_{10}^+	Ω_{11}	$\Omega_{*1} \cup S^+ \cup C_0$	S_{01}	V	7.8
C_0	Ω_{01}	Ω_{10}	Ω_{11}	$\Omega_{\neq,11} \cup C_0$	Ω_{01}	V	7.8
R_{00}	\emptyset	\emptyset	\emptyset	R_{00}	S_{01}	Ω_{0*}	[18]
R_{00}	\emptyset	\emptyset	C_1	$R_{00} \cup C_1$	S_{01}	M	[18]
R_{00}	\emptyset	\emptyset	S_{11}^+	$S_{11}^+ \cup R_{00}$	S_{01}	V	7.8
R_{00}	\emptyset	\emptyset	R_{11}	R	S	Ω	[18]
R_{00}	\emptyset	\emptyset	$S_{11}^+ \cup R_{11}$	$S_{11}^+ \cup R$	S_{01}	V	7.8
R_{00}	\emptyset	\emptyset	Ω_{11}	$\Omega_{11} \cup R_{00}$	S_{01}	V	7.8
R_{00}	\emptyset	S_{10}^+	\emptyset	$S_{10}^+ \cup R_{00}$	S_{01}	V_{0*}	7.8
R_{00}	\emptyset	S_{10}^+	C_1	$S_{10}^+ \cup R_{00} \cup C_1$	S_{01}	V	7.8
R_{00}	\emptyset	S_{10}^+	S_{11}^+	$S_{10}^+ \cup R_{00}$	S_{01}	V	7.8
R_{00}	\emptyset	S_{10}^+	$S_{11}^+ \cup R_{11}$	$S_{10}^+ \cup R$	S_{01}	V	7.8
R_{00}	\emptyset	S_{10}^+	Ω_{11}	$S_{10}^+ \cup \Omega_{11} \cup R_{00}$	S_{01}	V	7.8
R_{00}	\emptyset	Ω_{10}	\emptyset	$\Omega_{10} \cup R_{00}$	S_{01}	V_{0*}	7.8
R_{00}	\emptyset	Ω_{10}	C_1	$\Omega_{10} \cup R_{00} \cup C_1$	S_{01}	V	7.8
R_{00}	\emptyset	Ω_{10}	S_{11}^+	$\Omega_{10} \cup S_{11}^+ \cup R_{00}$	S_{01}	V	7.8
R_{00}	\emptyset	Ω_{10}	Ω_{11}	$\Omega_{1*} \cup R_{00}$	S_{01}	V	7.8
R_{00}	S_{01}^+	\emptyset	\emptyset	$S_{01}^+ \cup R_{00}$	S_{01}	V_{0*}	7.8
R_{00}	S_{01}^+	\emptyset	C_1	$S_{01}^+ \cup R_{00} \cup C_1$	S_{01}	V	7.8
R_{00}	S_{01}^+	\emptyset	S_{11}^+	$S_{01}^+ \cup R_{00}$	S_{01}	V	7.8
R_{00}	S_{01}^+	\emptyset	$S_{11}^+ \cup R_{11}$	$S_{01}^+ \cup R$	S_{01}	V	7.8
R_{00}	S_{01}^+	\emptyset	Ω_{11}	$S_{01}^+ \cup \Omega_{11} \cup R_{00}$	S_{01}	V	7.8
R_{00}	S_{01}^+	\emptyset	S_{11}^+	$S^+ \cup R_{00}$	S_{01}	V	7.8
R_{00}	S_{01}^+	S_{10}^+	$S_{11}^+ \cup R_{11}$	$S^+ \cup R$	S	V	7.8
R_{00}	S_{01}^+	S_{10}^+	Ω_{11}	$S^+ \cup \Omega_{11} \cup R_{00}$	S_{01}	V	7.8
R_{00}	S_{01}^+	Ω_{10}	S_{11}^+	$\Omega_{10} \cup S_{*1}^+ \cup R_{00}$	S_{01}	V	7.8
R_{00}	S_{01}^+	Ω_{10}	Ω_{11}	$\Omega_{1*} \cup S_{01}^+ \cup R_{00}$	S_{01}	V	7.8
R_{00}	Ω_{01}	\emptyset	\emptyset	$\Omega_{01} \cup R_{00}$	S_{01}	V_{0*}	7.8
R_{00}	Ω_{01}	\emptyset	C_1	$\Omega_{01} \cup R_{00} \cup C_1$	S_{01}	V	7.8
R_{00}	Ω_{01}	\emptyset	S_{11}^+	$\Omega_{01} \cup S_{11}^+ \cup R_{00}$	S_{01}	V	7.8
R_{00}	Ω_{01}	\emptyset	Ω_{11}	$\Omega_{*1} \cup R_{00}$	S_{01}	V	7.8
R_{00}	Ω_{01}	S_{10}^+	S_{11}^+	$\Omega_{01} \cup S^+ \cup R_{00}$	S_{01}	V	7.8
R_{00}	Ω_{01}	S_{10}^+	Ω_{11}	$S^+ \cup \Omega_{*1} \cup R_{00}$	S_{01}	V	7.8
R_{00}	Ω_{01}	Ω_{10}	Ω_{11}	$\Omega_{\neq,11} \cup R_{00}$	S_{01}	V	7.8
Ω_{00}	\emptyset	\emptyset	\emptyset	Ω_{00}	Ω_{01}	Ω_{0*}	[18]
Ω_{00}	\emptyset	\emptyset	C_1	$\Omega_{00} \cup C_1$	Ω_{01}	M	[18]
Ω_{00}	\emptyset	\emptyset	S_{11}^+	$\Omega_{00} \cup S_{11}^+$	S_{01}	V	7.8
Ω_{00}	\emptyset	\emptyset	Ω_{11}	$\Omega_{=}$	Ω_{01}	Ω	[18]
Ω_{00}	\emptyset	S_{10}^+	\emptyset	$\Omega_{00} \cup S_{10}^+$	S_{01}	V_{0*}	7.8
Ω_{00}	\emptyset	S_{10}^+	C_1	$\Omega_{00} \cup S_{10}^+ \cup C_1$	S_{01}	V	7.8
Ω_{00}	\emptyset	S_{10}^+	S_{11}^+	$\Omega_{00} \cup S_{1*}^+$	S_{01}	V	7.8
Ω_{00}	\emptyset	S_{10}^+	Ω_{11}	$\Omega_{=} \cup S_{10}^+$	S_{01}	V	7.8
Ω_{00}	\emptyset	Ω_{10}	\emptyset	Ω_{*0}	Ω_{*1}	Ω_{0*}	[18]
Ω_{00}	\emptyset	Ω_{10}	C_1	$\Omega_{*0} \cup C_1$	Ω_{*1}	M	[18]
Ω_{00}	\emptyset	Ω_{10}	S_{11}^+	$\Omega_{*0} \cup S_{11}^+$	S_{01}	V	7.8
Ω_{00}	\emptyset	Ω_{10}	Ω_{11}	Ω_{\geq}	Ω_{01}	M	[18]
Ω_{00}	S_{01}^+	\emptyset	\emptyset	$\Omega_{00} \cup S_{01}^+$	S_{01}	V_{0*}	7.8
Ω_{00}	S_{01}^+	\emptyset	C_1	$\Omega_{00} \cup S_{01}^+ \cup C_1$	S_{01}	V	7.8
Ω_{00}	S_{01}^+	\emptyset	S_{11}^+	$\Omega_{00} \cup S_{*1}^+$	S_{01}	V	7.8
Ω_{00}	S_{01}^+	\emptyset	Ω_{11}	$\Omega_{=} \cup S_{01}^+$	S_{01}	V	7.8
Ω_{00}	S_{01}^+	S_{10}^+	S_{11}^+	$\Omega_{00} \cup S^+$	S_{01}	V	7.8
Ω_{00}	S_{01}^+	S_{10}^+	Ω_{11}	$\Omega_{=} \cup S^+$	S_{01}	V	7.8
Ω_{00}	S_{01}^+	Ω_{10}	S_{11}^+	$\Omega_{*0} \cup S^+$	S_{01}	V	7.8
Ω_{00}	S_{01}^+	Ω_{10}	Ω_{11}	$\Omega_{\geq} \cup S^+$	S_{01}	V	7.8
Ω_{00}	Ω_{01}	\emptyset	\emptyset	Ω_{0*}	Ω_{0*}	Ω_{0*}	[18]
Ω_{00}	Ω_{01}	\emptyset	C_1	$\Omega_{0*} \cup C_1$	Ω_{0*}	M	[18]
Ω_{00}	Ω_{01}	\emptyset	S_{11}^+	$\Omega_{0*} \cup S_{11}^+$	S_{01}	V	7.8
Ω_{00}	Ω_{01}	\emptyset	Ω_{11}	Ω_{\leq}	Ω_{01}	M	[18]
Ω_{00}	Ω_{01}	S_{10}^+	S_{11}^+	$\Omega_{0*} \cup S^+$	S_{01}	V	7.8
Ω_{00}	Ω_{01}	S_{10}^+	Ω_{11}	$\Omega_{\leq} \cup S^+$	S_{01}	V	7.8
Ω_{00}	Ω_{01}	Ω_{10}	Ω_{11}	Ω	Ω	Ω	[18]

TABLE 7.1. (S_{01}, V_{01}) -clonoids.

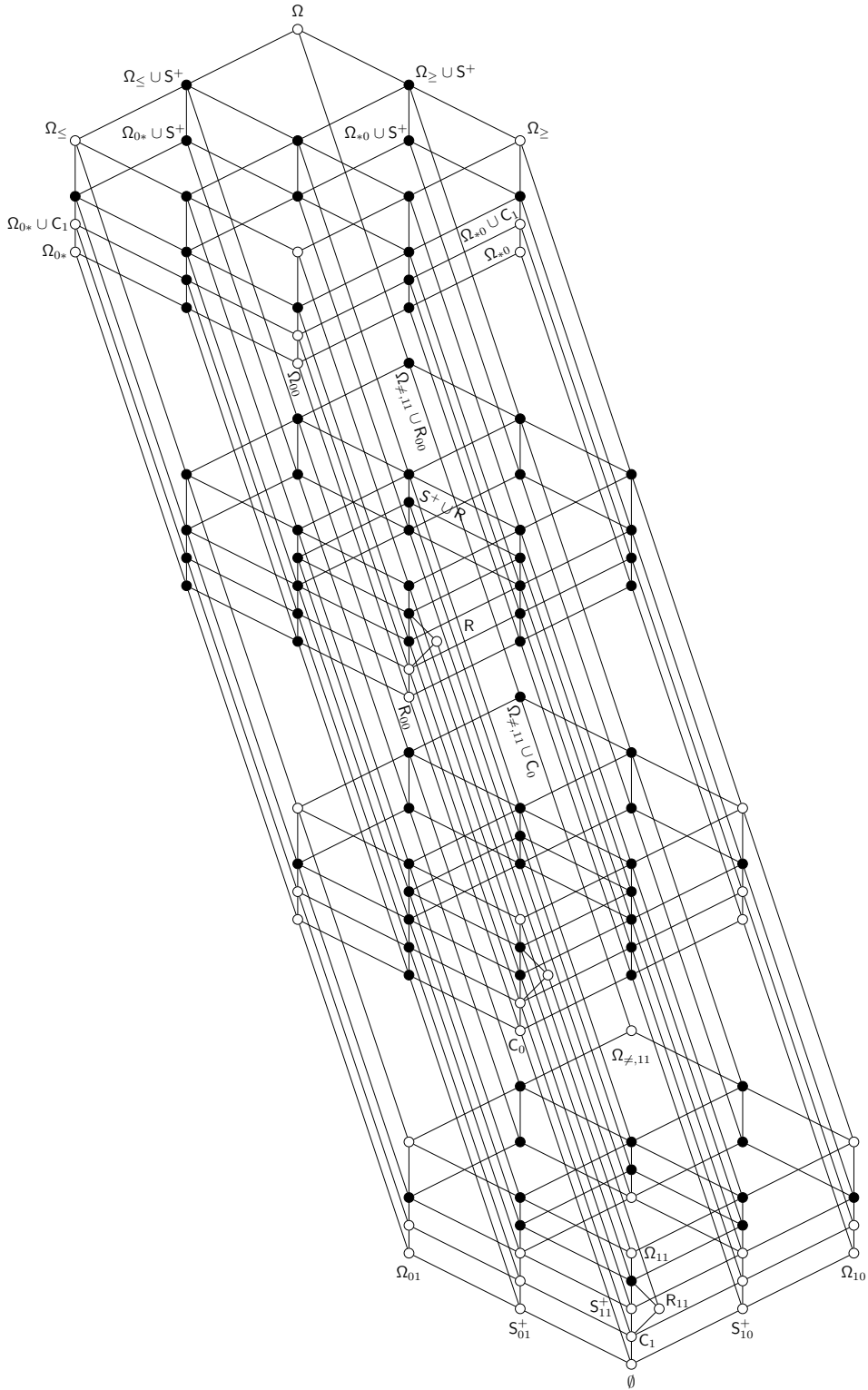

FIGURE 7.13. (S_{01}, V_{01}) -clonoids.

- (ii) If $\Omega_{ab} \cup R_{11} \subseteq K$, then $\Omega_{11} \subseteq K$.
- (iii) If $S_{01}^+ \cup S_{10}^+ \subseteq K$, then $S_{11}^+ \subseteq K$.
- (iv) If $S_{a\bar{a}}^+ \cup R_{11} \subseteq K$, then $S_{11}^+ \subseteq K$.

Proof of Claim 7.7.2. (i) Let $f \in \Omega_{11}$. Define functions g and h (of the same arity as f) as follows. For $\mathbf{a} \in \{0, 1\}^n$, let

$$g(\mathbf{a}) := \begin{cases} f(\mathbf{a}), & \text{if } \mathbf{a} \neq \mathbf{0}, \\ 0, & \text{if } \mathbf{a} = \mathbf{0}, \end{cases} \quad h(\mathbf{a}) := \begin{cases} f(\mathbf{a}), & \text{if } \mathbf{a} \neq \mathbf{1}, \\ 0, & \text{if } \mathbf{a} = \mathbf{1}, \end{cases}$$

Clearly, $g \in \Omega_{01}$, $h \in \Omega_{10}$, and $f = g \vee h$. Therefore, $f \in V_{01}(\Omega_{01} \cup \Omega_{10}) \subseteq V_{01}K \subseteq K$. We conclude that $\Omega_{11} \subseteq K$.

(ii) Let $f \in \Omega_{11}$. Define functions g and h (of the same arity as f) as follows. For $\mathbf{a} \in \{0, 1\}^n$, let

$$g(\mathbf{a}) := \begin{cases} f(\mathbf{a}), & \text{if } \mathbf{a} \notin \{\mathbf{0}, \mathbf{1}\}, \\ a, & \text{if } \mathbf{a} = \mathbf{0}, \\ b, & \text{if } \mathbf{a} = \mathbf{1}, \end{cases} \quad h(\mathbf{a}) := \begin{cases} 1, & \text{if } \mathbf{a} \in \{\mathbf{0}, \mathbf{1}\}, \\ 0, & \text{otherwise.} \end{cases}$$

Clearly, $g \in \Omega_{ab}$, $h \in R_{11}$, and $f = g \vee h$. Therefore, $f \in V_{01}(\Omega_{ab} \cup R_{11}) \subseteq V_{01}K \subseteq K$. We conclude that $\Omega_{11} \subseteq K$.

(iii) Let $f \in S_{11}^+$. Define functions g and h as in the proof of Claim 7.7.1(i). We now have $g \in S_{01}^+$, $h \in S_{10}^+$, and $f = g \vee h$. Therefore, $f \in V_{01}(S_{01}^+ \cup S_{10}^+) \subseteq V_{01}K \subseteq K$. We conclude that $S_{11}^+ \subseteq K$.

(iv) Let $f \in S_{11}^+$. Define functions g and h as in (ii), with $b = \bar{a}$. We now have $g \in S_{a\bar{a}}^+$, $h \in R_{11}$, and $f = g \vee h$. Therefore, $f \in V_{01}(S_{a\bar{a}}^+ \cup R_{11}) \subseteq V_{01}K \subseteq K$. We conclude that $S_{11}^+ \subseteq K$. ■

Claim 7.7.2 leaves us with the 123 quadruples (A, B, C, D) , or classes $K = A \cup B \cup C \cup D$, that are presented in Table 7.1 and in Figure 7.13. It remains to verify that these classes are indeed (S_{01}, V_{01}) -clonoids. For this, we only need to prove stability under left composition with V_{01} . Because intersections of (S_{01}, V_{01}) -clonoids are again (S_{01}, V_{01}) -clonoids, it suffices to verify this only for the 16 meet-irreducible classes: Ω , $\Omega_{\leq} \cup S^+$, $\Omega_{\geq} \cup S^+$, Ω_{\leq} , Ω_{\geq} , $\Omega_{0*} \cup S^+$, $\Omega_{*0} \cup S^+$, $\Omega_{0*} \cup C_1$, $\Omega_{*0} \cup C_1$, Ω_{0*} , Ω_{*0} , $\Omega_{\neq, 11} \cup R_{00}$, $\Omega_{\neq, 11} \cup C_0$, $\Omega_{\neq, 11}$, $S^+ \cup R$, R . This is straightforward verification, especially with the help of Lemma 3.1, and we leave the details to the reader. □

Theorem 7.8. *For each (S_{01}, V_{01}) -clonoid K , as determined in Proposition 7.7 and Table 7.1, the clones C_1^K and C_2^K prescribed in Table 7.1 have the property that for every clone C , it holds that $KC \subseteq K$ if and only if $C \subseteq C_1^K$, and $CK \subseteq K$ if and only if $C \subseteq C_2^K$.*

For 42 out of the 123 (S_{01}, V_{01}) -clonoids K , the clones C_1^K and C_2^K have already been determined in [18, Theorem 5.1, Table 1]. These are indicated in Table 7.1 with “[18]” in the source column and in Figure 7.13 as the vertices drawn as hollow circles (○). We focus on the remaining (S_{01}, V_{01}) -clonoids, indicated in Table 7.1 with “7.8” in the source column and in Figure 7.13 as the vertices drawn as filled circles (●).

Lemma 7.9.

- (i) For $a, b \in \{0, 1\}$ with $(a, b) \neq (0, 0)$, $\{\wedge\}S_{ab}^+ \not\subseteq S^+ \cup S^- \cup R \cup (\Omega \setminus \Omega_{ab})$.
- (ii) For $a \in \{0, 1\}$, $\{\wedge\}(\Omega_{a\bar{a}} \cup R_{00}) \not\subseteq \Omega_{\neq, 11} \cup R_{00}$.
- (iii) If $\{\wedge\}K \not\subseteq K$ and $C_0 \subseteq K$, then $\{\mu\}K \not\subseteq K$ and $\{\vee\}K \not\subseteq K$.
- (iv) $\{\mu\}(S_{11}^+ \cup R_{11}) \not\subseteq S^+ \cup S^- \cup R \cup \Omega_{\neq, 00}$.

- (v) For $a, b, c, d \in \{0, 1\}$ with $(a, b) \neq (0, 0)$, $\{\mu\}(S_{ab}^+ \cup \Omega_{cd}) \not\subseteq S^+ \cup S^- \cup R \cup (\Omega \setminus \Omega_{ab})$.
- (vi) For $a, b \in \{0, 1\}$ with $(a, b) \neq (0, 0)$, $\{\vee\}(S_{ab}^+ \cup R_{11}) \not\subseteq S^+ \cup S^- \cup R \cup \Omega_{\neq, 00}$.
- (vii) For $a \in \{0, 1\}$, $\{\vee\}(\Omega_{a\bar{a}} \cup S_{11}^+) \not\subseteq S^+ \cup S^- \cup R \cup \Omega_{\neq, 00}$.

Proof. (i) For the functions f and g specified by the operation table below, we have $f, g \in S_{ab}^+$, but $f \wedge g \notin S^+ \cup S^- \cup R \cup (\Omega \setminus \Omega_{ab})$.

x_1	x_2	x_3	f	g	$f \wedge g$
0	0	0	a	a	a
1	1	1	b	b	b
0	0	1	1	1	1
1	1	0	1	1	1
0	1	0	1	0	0
1	0	1	0	1	0
1	0	0	0	0	0
0	1	1	1	1	1

(ii) For the functions f and g specified by the operation table below, we have $f \in \Omega_{a\bar{a}}$, $g \in R_{00}$ but $f \wedge g \notin \Omega_{\neq, 11} \cup R_{00}$.

x_1	x_2	f	g	$f \wedge g$
0	0	a	0	0
0	1	0	1	0
1	0	1	1	1
1	1	\bar{a}	0	0

(iii) Because $\{\wedge\}K \not\subseteq K$, there exist $f, g \in K$ such that $f \wedge g \notin K$. Then

$$\begin{aligned} \mu(0, f, g) &= (0 \wedge f) \vee (0 \wedge g) \vee (f \wedge g) = f \wedge g \notin K, \\ \vee(0, f, g) &= 0 \vee (f \wedge g) = f \wedge g \notin K, \end{aligned}$$

so $\{\mu\}K \not\subseteq K$ and $\{\vee\}K \not\subseteq K$.

(iv), (v) For the functions f, g , and h specified by the operation table below, we have $f, g \in S_{ab}^+$ and $h \in \Omega_{cd}$ but $\mu(f, g, h) \notin S^+ \cup S^- \cup R \cup (\Omega \setminus \Omega_{ab})$. Moreover, if $c = d$, then $h \in R_{cc}$.

x_1	x_2	x_3	f	g	h	$\mu(f, g, h)$
0	0	0	a	a	c	a
1	1	1	b	b	d	b
0	0	1	1	1	1	1
1	1	0	1	1	1	1
0	1	0	1	0	0	0
1	0	1	0	1	0	0
1	0	0	0	0	0	0
0	1	1	1	1	0	1

(vi) For the functions f , g , and h specified by the operation table below, we have $f \in \mathbf{R}_{11}$ and $g, h \in \mathbf{S}_{ab}^+$ but $\wedge(f, g, h) \notin \mathbf{S}^+ \cup \mathbf{S}^- \cup \mathbf{R} \cup \Omega_{\neq, 00}$.

x_1	x_2	x_3	f	g	h	$\wedge(f, g, h)$
0	0	0	1	a	a	1
1	1	1	1	b	b	1
0	0	1	1	0	0	1
1	1	0	1	1	1	1
0	1	0	0	0	1	0
1	0	1	0	1	0	0
1	0	0	0	0	0	0
0	1	1	0	1	1	1

(vii) For the functions f , g , and h specified by the operation table below, we have $f \in \Omega_{a\bar{a}}$ and $g, h \in \mathbf{S}_{11}^+$ but $\wedge(f, g, h) \notin \mathbf{S}^+ \cup \mathbf{S}^- \cup \mathbf{R} \cup \Omega_{\neq, 00}$.

x_1	x_2	x_3	f	g	h	$\wedge(f, g, h)$
0	0	0	a	1	1	1
1	1	1	\bar{a}	1	1	1
0	0	1	0	1	1	1
1	1	0	0	1	1	1
0	1	0	0	0	1	0
1	0	1	0	1	0	0
1	0	0	0	0	0	0
0	1	1	0	1	1	1

□

Proof of Theorem 7.8. We determine, for each $(\mathbf{S}_{01}, \mathbf{V}_{01})$ -clonoid K , the clones C_1^K and C_2^K such that $KC_1 \subseteq C_1$ if and only if $C_1 \subseteq C_1^K$ and $C_2K \subseteq K$ if and only if $C_2 \subseteq C_2^K$. We get the clones C_1^K immediately from Theorem (i).

For 42 out of the 123 $(\mathbf{S}_{01}, \mathbf{V}_{01})$ -clonoids K , as indicated in Table 7.1 (the ones with “[18]” in the source column) and in Figure 7.13 (the vertices drawn as hollow circles), the clones C_2^K have been determined in [18, Theorem 5.1, Table 1]. From now on, we assume that K is one of the remaining $(\mathbf{S}_{01}, \mathbf{V}_{01})$ -clonoids.

By Lemma 2.9, left stability under composition with a clone C_2 can be tested with a generating set of C_2 . We are going to determine C_2^K by testing whether K is stable under left composition with certain functions. Using this information together with Post’s lattice, we can identify the right clone. We clearly have $\mathbf{V}_{01} \subseteq C_2^K$ because K is stable under left composition with \mathbf{V}_{01} .

Claim 7.9.1. For $a \in \{0, 1\}$, $a \in C_2^K$ if and only if $\mathbf{C}_a \subseteq K$.

Proof of Claim 7.9.1. This follows immediately from Lemma 2.10(ii). ■

Claim 7.9.2. $\wedge \notin C_2^K$.

Proof of Claim 7.9.2. Because one of the inclusions

$$\begin{aligned} \mathbf{S}_{01}^+ \subseteq K \subseteq \Omega_{\geq} \cup \mathbf{S}^+, \quad \mathbf{S}_{10}^+ \subseteq K \subseteq \Omega_{\leq} \cup \mathbf{S}^+, \quad \mathbf{S}_{11}^+ \subseteq K \subseteq \Omega_{\neq, 00} \cup \mathbf{S}^+ \cup \mathbf{R}, \\ \Omega_{01} \cup \mathbf{R}_{00} \subseteq K \subseteq \Omega_{*1} \cup \mathbf{R}_{00}, \quad \Omega_{10} \cup \mathbf{R}_{00} \subseteq K \subseteq \Omega_{1*} \cup \mathbf{R}_{00} \end{aligned}$$

holds, it follows from Lemma 7.9(i) and (ii) that $\{\wedge\}K \not\subseteq K$. ■

Claim 7.9.3. $\mu \notin C_2^K$.

Proof of Claim 7.9.3. Because one of the inclusions

$$\begin{aligned} C_0 \subseteq K, \quad S_{11}^+ \cup R_{11} \subseteq K \subseteq S^+ \cup R_{11}, \quad S_{01}^+ \cup \Omega_{11} \subseteq K \subseteq S_{01}^+ \cup \Omega_{1*}, \\ S_{10}^+ \cup \Omega_{11} \subseteq K \subseteq S_{10}^+ \cup \Omega_{*1}, \quad S_{11}^+ \cup \Omega_{01} \subseteq K \subseteq S_{1*}^+ \cup \Omega_{01}, \\ S_{11}^+ \cup \Omega_{10} \subseteq K \subseteq S_{*1}^+ \cup \Omega_{10} \end{aligned}$$

holds, it follows from Lemma 7.9(iii), (iv), and (v) that $\{\mu\}K \not\subseteq K$. ■

Claim 7.9.4. If K is not any of the classes $\Omega_{11} \cup S_{01}^+$, $\Omega_{11} \cup S_{10}^+$, $\Omega_{11} \cup S^+$, $\Omega_{*1} \cup S_{10}^+$, $\Omega_{1*} \cup S_{01}^+$, then $\vee \notin C_2^K$.

Proof of Claim 7.9.4. If K is not one of the five classes mentioned, then one of the inclusions

$$\begin{aligned} C_0 \subseteq K, \quad S_{11}^+ \cup R_{11} \subseteq K \subseteq S^+ \cup R_{11}, \\ \Omega_{01} \cup S_{11}^+ \subseteq K \subseteq \Omega_{01} \cup S_{1*}^+, \quad \Omega_{10} \cup S_{11}^+ \subseteq K \subseteq \Omega_{10} \cup S_{*1}^+ \end{aligned}$$

holds, and it follows from Lemma 7.9(iii), (vi), and (vii) that $\{x_1 \vee (x_2 \wedge x_3)\}K \not\subseteq K$. ■

Claim 7.9.5. If K is one of $\Omega_{11} \cup S_{01}^+$, $\Omega_{11} \cup S_{10}^+$, $\Omega_{11} \cup S^+$, $\Omega_{*1} \cup S_{10}^+$, $\Omega_{1*} \cup S_{01}^+$, then $\{\rightarrow, \text{th}_2^4\} \subseteq C_2^K$.

Proof of Claim 7.9.5. We prove first that $\{\rightarrow\}K \subseteq K$. Let $f, g \in K$, and consider $f \rightarrow g$. If g is in Ω_{11} (Ω_{*1} , Ω_{1*} , resp.), then $f \rightarrow g$ is in Ω_{11} (Ω_{*1} , Ω_{1*} , resp.) and we are done. If $g \in S_{01}^+$, then $f \rightarrow g$ is in Ω_{*1} . If $f \rightarrow g \in \Omega_{11}$, then we are done, so assume that $f \rightarrow g \in \Omega_{01}$. Because $g(\mathbf{a}) \vee g(\bar{\mathbf{a}}) = 1$ for all \mathbf{a} , we have

$$\begin{aligned} (f \rightarrow g)(\mathbf{a}) \vee (f \rightarrow g)(\bar{\mathbf{a}}) &= (f(\mathbf{a}) \rightarrow g(\mathbf{a})) \vee (f(\bar{\mathbf{a}}) \rightarrow g(\bar{\mathbf{a}})) \\ &= (\overline{f(\mathbf{a})} \vee g(\mathbf{a})) \vee (\overline{f(\bar{\mathbf{a}})} \vee g(\bar{\mathbf{a}})) = (\overline{f(\mathbf{a})} \vee \overline{f(\bar{\mathbf{a}})}) \vee (g(\mathbf{a}) \vee g(\bar{\mathbf{a}})) = 1, \end{aligned}$$

so, in fact, $f \rightarrow g \in S_{01}^+$. In a similar way, we can show that if $g \in S_{10}^+$, then $f \rightarrow g \in S_{10}^+$. From these facts it follows that $\{\rightarrow\}K \subseteq K$.

We now prove that $\{\text{th}_2^4\}K \subseteq K$. Let $f_1, f_2, f_3, f_4 \in K$, and consider $\varphi := \text{th}_2^4(f_1, f_2, f_3, f_4) \in \{\text{th}_2^4\}K$. If two of the functions f_1, f_2, f_3, f_4 are in Ω_{11} (Ω_{*1} , Ω_{1*} , resp.), then φ is in Ω_{11} (Ω_{*1} , Ω_{1*} , resp.). Assume thus that at most one of f_1, f_2, f_3, f_4 is in Ω_{11} (Ω_{*1} , Ω_{1*} , resp.); without loss of generality, assume that this function, if any, is f_4 . Then f_1, f_2, f_3 are in S_{01}^+ (S_{10}^+ , S^+ , resp.). But then, for any $\mathbf{a} \in \{0, 1\}^n$, there must exist $i, j \in [3]$ such that $f_i(\mathbf{a}) = f_j(\mathbf{a}) = 1$ or $f_i(\bar{\mathbf{a}}) = f_j(\bar{\mathbf{a}})$; consequently, $\varphi(\mathbf{a}) = 1$ or $\varphi(\bar{\mathbf{a}}) = 1$. Thus, $\varphi \in S^+$. Moreover, if $f_1, f_2, f_3 \in S_{01}^+$, then $\varphi \in S_{01}^+$; and if $f_1, f_2, f_3 \in S_{10}^+$, then $\varphi \in S_{10}^+$. From these facts it follows that $\{\text{th}_2^4\}K \subseteq K$. ■

From the above claims we conclude that $C_2^K = \langle \rightarrow, \text{th}_2^4 \rangle = \mathbf{W}^3$ if and only if K is one of the classes $\Omega_{11} \cup S_{01}^+$, $\Omega_{11} \cup S_{10}^+$, $\Omega_{11} \cup S^+$, $\Omega_{*1} \cup S_{10}^+$, $\Omega_{1*} \cup S_{01}^+$. In the case when K is not one of these classes, we have that $C_2^K = \mathbf{V}$ if and only if $C \subseteq K$; $C_2^K = \mathbf{V}_{0*}$ if and only if $C_0 \subseteq K$ but $C_1 \cap K = \emptyset$; $C_2^K = \mathbf{V}_{*1}$ if and only if $C_1 \subseteq K$ but $C_0 \cap K = \emptyset$; and $C_2^K = \mathbf{V}_{01}$ if and only if $C \cap K = \emptyset$. This is presented explicitly in Table 7.1. □

8. FINAL REMARKS

It remains out of the scope of this paper to consider (C_1, C_2) -clonoids in the cases where the source clone C_1 is not a discriminator clone nor a monotone clone. In such cases the (C_1, J) -clonoid lattice is uncountable, and it may not be possible to explicitly describe it. Sparks's theorem (Theorem 1.1) could nevertheless be extended by determining the cardinality of the lattice of (C_1, C_2) -clonoids for

arbitrary pairs (C_1, C_2) of clones (in Theorem 1.1, the source clone is fixed to be the clone of projections). This remains a topic for further investigation. Another direction for further further research lies in generalizing our current findings to arbitrary finite base sets.

REFERENCES

- [1] E. AICHINGER, P. MAYR, Finitely generated equational classes, *J. Pure Appl. Algebra* **220** (2016) 2816–2827.
- [2] L. BARTO, J. BULÍN, A. KROKHIN, J. OPRŠAL, Algebraic approach to promise constraint satisfaction, *J. ACM* **68** (2021) Art. 28, 66 pp.
- [3] J. BULÍN, A. KROKHIN, J. OPRŠAL, Algebraic approach to promise constraint satisfaction, In: *Proceedings of the 51st Annual ACM SIGACT Symposium on the Theory of Computing (STOC '19), June 23–26, 2019, Phoenix, AZ, USA*, ACM, New York, NY, USA, pp. 602–613.
- [4] P. M. COHN, *Universal Algebra*, Harper & Row, New York, NY, 1965.
- [5] M. COUCEIRO, S. FOLDES, On closed sets of relational constraints and classes of functions closed under variable substitution, *Algebra Universalis* **54** (2005) 149–165.
- [6] M. COUCEIRO, S. FOLDES, Functional equations, constraints, definability of function classes, and functions of Boolean variables, *Acta Cybernet.* **18** (2007) 61–75.
- [7] M. COUCEIRO, S. FOLDES, Function classes and relational constraints stable under compositions with clones, *Discuss. Math. Gen. Algebra Appl.* **29** (2009) 109–121.
- [8] M. COUCEIRO, E. LEHTONEN, Stability of Boolean function classes with respect to clones of linear functions, *Order* **41** (2024) 15–64.
- [9] S. FIORAVANTI, Closed sets of finitary functions between products of finite fields of coprime order, *Algebra Universalis* **82**(4) (2021) Art. 61.
- [10] S. FIORAVANTI, Expansions of abelian square-free groups, *Internat. J. Algebra Comput.* **31**(4) (2021) 623–638.
- [11] S. KOSUB, K. W. WAGNER, The Boolean hierarchy of NP-partitions, in: H. Reichel, S. Tison (Eds.), *STACS 2000, 17th Annual Symposium on Theoretical Aspects of Computer Science*, Lecture Notes in Comput. Sci., vol. 1770, Springer-Verlag, Berlin, 2000, pp. 157–168.
- [12] S. KOSUB, K. W. WAGNER, The Boolean hierarchy of NP-partitions, *Inform. and Comput.* **206** (2008) 538–568.
- [13] S. KREINECKER, Closed function sets on groups of prime order, *J. Mult.-Valued Logic Soft Comput.* **33** (2019) 51–74.
- [14] E. LEHTONEN, An infinite descending chain of Boolean subfunctions consisting of threshold functions, *Contributions to General Algebra* **17**, Proceedings of the Vienna Conference 2005 (AAA70), Verlag Johannes Heyn, Klagenfurt, 2006, pp. 145–148.
- [15] E. LEHTONEN, Descending chains and antichains of the unary, linear, and monotone subfunction relations, *Order* **23** (2006) 129–142.
- [16] E. LEHTONEN, A note on minors determined by clones of semilattices, *Novi Sad J. Math.* **40**(3) (2010) 75–81.
- [17] E. LEHTONEN, Labeled posets are universal, *European J. Combin.* **29** (2008) 493–506.
- [18] E. LEHTONEN, Majority-closed minions of Boolean functions, *Algebra Universalis* **85** (2024) Art. 6.
- [19] E. LEHTONEN, Near-unanimity-closed minions of Boolean functions, arXiv:2305.12904.
- [20] E. LEHTONEN, J. NEŠETRIL, Minors of Boolean functions with respect to clique functions and hypergraph homomorphisms, *European J. Combin.* **31** (2010) 1981–1995.
- [21] E. LEHTONEN, Á. SZENDREI, Equivalence of operations with respect to discriminator clones, *Discrete Math.* **309** (2009) 673–685.
- [22] E. LEHTONEN, Á. SZENDREI, The submaximal clones on the three-element set with finitely many relative \mathcal{R} -classes, *Discuss. Math. Gen. Algebra Appl.* **30** (2010) 7–33.
- [23] E. LEHTONEN, Á. SZENDREI, Clones with finitely many relative \mathcal{R} -classes, *Algebra Universalis* **65** (2011) 109–159.
- [24] E. LEHTONEN, Á. SZENDREI, Partial orders induced by quasilinear clones, *Contributions to General Algebra* **20**, Proceedings of the Salzburg Conference 2011 (AAA81), Verlag Johannes Heyn, Klagenfurt, 2012, pp. 51–84, ISBN: 978-3-7084-0447-9.
- [25] P. MAYR, P. WYNNE, Clonoids between modules, arXiv:2307.00076.
- [26] N. PIPPENGER, Galois theory for minors of finite functions, *Discrete Math.* **254** (2002) 405–419.
- [27] E. L. POST, *The Two-Valued Iterative Systems of Mathematical Logic*, Annals of Mathematics Studies, no. 5, Princeton University Press, Princeton, 1941.

- [28] I. ROSENBERG, Á. SZENDREI, Degrees of clones and relations, *Houston J. Math.* **9** (1983) 545–580.
- [29] A. SPARKS, On the number of clonoids, *Algebra Universalis* **80**(4) (2019), Paper No. 53, 10 pp.