



CMS-HIG-23-003

Search for bottom quark associated production of the standard model Higgs boson in final states with leptons in proton-proton collisions at $\sqrt{s} = 13$ TeV

The CMS Collaboration*

Abstract

This Letter presents the first search for bottom quark associated production of the standard model Higgs boson, in final states with leptons. Higgs boson decays to pairs of tau leptons and pairs of leptonically decaying W bosons are considered. The search is performed using data collected from 2016 to 2018 by the CMS experiment in proton-proton collisions at a centre-of-mass energy of 13 TeV, corresponding to an integrated luminosity of 138 fb^{-1} . Upper limits at the 95% confidence level are placed on the signal strength for Higgs boson production in association with bottom quarks; the observed (expected) upper limit is 3.7 (6.1) times the standard model prediction.

Submitted to Physics Letters B

1 Introduction

The discovery of the Higgs boson (H) [1–3] by the ATLAS [4] and CMS [5] Collaborations in 2012 was a milestone in the study of the standard model (SM) of particle physics. A broad programme of measurements, studying the properties of this newly found particle, has been carried out over the subsequent decade [6, 7].

The production of the SM Higgs boson at the CERN LHC can occur via several mechanisms [8]; the dominant ones, listed in order of decreasing production rate, are: gluon-gluon fusion (ggH), vector boson fusion (VBF), Higgs-strahlung (VH), top quark associated production ($t\bar{t}H$ and tH), and bottom quark associated production ($b\bar{b}H$). With the exception of the $b\bar{b}H$ and tH processes, these production modes have all been observed [6, 7]. With a predicted production cross section of $0.48_{-0.11}^{+0.10}$ pb [8], $b\bar{b}H$ production occurs almost as frequently as $t\bar{t}H$ production. However, distinguishing the Higgs boson signal from backgrounds is experimentally more challenging for $b\bar{b}H$ production than for $t\bar{t}H$ production, since the top quark decay products provide a clear experimental signature. As such, $t\bar{t}H$ production was already observed by both ATLAS [9] and CMS [10] in 2018. In addition to challenges related to the suppression of backgrounds, the $b\bar{b}H$ process interferes with other Higgs boson production mechanisms [11]. The destructive interference with Higgs boson production via ggH, in particular, hinders the possibility of directly constraining the Yukawa coupling between the Higgs boson and bottom quarks through studies of this process. Measurements of Higgs boson decays to bottom quarks provide more precise constraints on this Yukawa coupling, while $b\bar{b}H$ production remains sensitive to the correlation between the Higgs boson couplings to bottom and top quarks.

This Letter presents constraints on the production cross section of the Higgs boson in association with b quarks, using the proton-proton (pp) collision data set recorded by the CMS detector at $\sqrt{s} = 13$ TeV in 2016–2018. The search primarily targets Higgs boson decays into pairs of tau leptons. Higgs boson decays to leptonically decaying W bosons are also considered in the electron-muon pair final state. These decay channels are chosen for their sizeable branching fractions, in combination with moderate backgrounds, which result from the presence of leptons in the final state. Compared with previous searches performed by the CMS experiment [12, 13], this search is optimized to target the production mechanism of the 125 GeV Higgs boson in the SM. Tabulated results are provided in the HEPData record for this analysis [14].

2 Higgs boson production mechanisms and analysis strategy

Figure 1 shows the main Feynman diagrams for Higgs boson production in association with b quarks. The upper left diagram represents ggH production with an additional gluon splitting into a $b\bar{b}$ pair. In this diagram, the Higgs boson is produced via a quark (q) loop that mainly involves the top quark. The production cross section is therefore dominated by a contribution proportional to the square of the top quark Yukawa coupling (y_t). The theoretical production cross section for this process is evaluated as a fraction of the next-to-leading order (NLO) ggH production cross section with calculations performed in the four-flavour scheme [8], requiring the gluon to convert into a $b\bar{b}$ pair. This diagram interferes destructively with the diagram in Fig. 1 (upper right), the production of a Higgs boson and a $b\bar{b}$ pair via bottom quark fusion. The production cross section of this process is proportional to the square of the bottom quark Yukawa coupling (y_b). Quark-initiated diagrams are shown in Fig. 1 (lower): the Higgs boson is produced via the trilinear coupling to vector bosons (HVV) on the left and via the coupling y_b on the right. In the Higgs-strahlung diagram on the lower left, the b quarks are produced through the decay of an on-shell Z boson, and the diagram includes only electroweak terms at

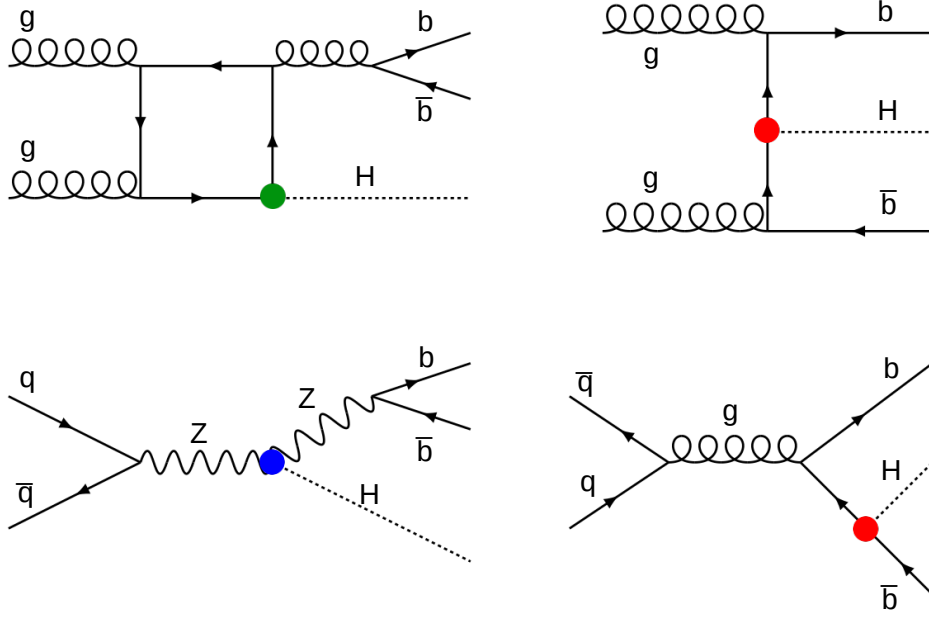

Figure 1: Dominant Feynman diagrams contributing to Higgs boson production in association with b quarks [11, 15]. The diagrams initiated by gluons (quarks) are shown in the upper (lower) row. The red circle is used to mark the Higgs boson coupling to b quarks, the green circle marks the Higgs boson coupling to top quarks, and the blue circle marks the coupling between the Higgs boson and vector bosons. In the ggH diagram (upper left), the additional gluon is radiated from within the quark loop, although it can equivalently radiate from one of the initial-state gluons.

leading order (LO). The resulting interference with the diagram on the lower right is therefore negligible with respect to the production cross section of the individual processes. In this Letter, the Higgs-strahlung process ($pp \rightarrow Z(\rightarrow b\bar{b}) + H$) is treated as a background because of the different coupling structure.

To distinguish the different contributions to Higgs boson production in association with b quarks, we use the following notation:

- $b\bar{b}H(y_b^2)$ refers to b quark associated Higgs boson production via Yukawa coupling to bottom quarks (e.g. the Feynman diagrams in Fig. 1 (right));
- $b\bar{b}H(y_t^2)$ marks Higgs boson production via a top quark loop; and
- $b\bar{b}H(y_t y_b)$ labels the interference term between the top-quark-mediated and the bottom-quark-mediated production processes.

The inclusive production across these terms is labelled as $b\bar{b}H$ or $b\bar{b}H(y_b, y_t)$.

The SM prediction for the $b\bar{b}H$ production cross section is therefore split into three contributions with the following production cross sections [8]: 1.040 pb for $b\bar{b}H(y_t^2)$ (NLO reweighted to next-to-next-to-NLO (N^3LO)), 0.482 pb for $b\bar{b}H(y_b^2)$ (NLO), and -0.033 pb for $b\bar{b}H(y_t y_b)$ (NLO), amounting to a total predicted production cross section of $\sigma(y_b, y_t) = 1.489$ pb.

The $b\bar{b}H$ search presented in this Letter is performed in final states of two oppositely charged leptons with different flavour, or hadronically decaying tau lepton (τ_h) candidates:

- two hadronically decaying tau leptons ($\tau_h \tau_h$);

- an electron and a hadronically decaying tau lepton ($e\tau_h$);
- a muon and a hadronically decaying tau lepton ($\mu\tau_h$);
- an electron and a muon ($e\mu$).

The first three final states originate from the decay of the Higgs boson to a pair of tau leptons, at least one of which decays hadronically. The $e\mu$ final state originates either from a Higgs boson decaying to a pair of tau leptons or from a Higgs boson decaying to a pair of W bosons. These two decay chains result in a similar event topology, and are therefore investigated as a single analysis channel. Final states with two electrons or muons have not been considered due to the overwhelming Drell-Yan background and low branching fractions.

3 The CMS detector

The CMS apparatus [5] is a multipurpose, nearly hermetic detector, designed to trigger on [16, 17] and identify electrons, muons, photons, and hadrons [18–20] produced in proton-proton collisions. A “particle-flow” (PF) algorithm [21] aims to reconstruct all individual particles in an event, combining information provided by the all-silicon inner tracker and by the crystal electromagnetic (ECAL) and brass-scintillator hadron calorimeters, operating inside a 3.8 T superconducting solenoid, with data from the gas-ionization muon detectors embedded in the flux-return yoke outside the solenoid. The reconstructed particles are used to build tau leptons, jets, and missing transverse momentum [22–24]. The missing transverse momentum vector \vec{p}_T^{miss} is computed as the negative vector sum of the transverse momenta of all the PF candidates in an event, and its magnitude is denoted as p_T^{miss} [24]. The \vec{p}_T^{miss} is modified to account for corrections to the energy scale of the reconstructed jets in the event.

Events of interest are selected using a two-tiered trigger system. The first level, composed of custom hardware processors, uses information from the calorimeters and muon detectors to select events at a rate of around 100 kHz within a fixed latency of about $4\ \mu\text{s}$ [16]. The second level, known as the high-level trigger (HLT), consists of a farm of processors running a version of the full event reconstruction software optimized for fast processing and reduces the event rate to around 1 kHz before data storage [17].

A more detailed description of the CMS detector, together with a definition of the coordinate system used and the relevant kinematic variables, can be found in Ref. [5].

4 Data and simulated samples

The pp collision data set used in this search was recorded by the CMS experiment between 2016 and 2018, at a centre-of-mass energy of 13 TeV. It corresponds to a total integrated luminosity of $138\ \text{fb}^{-1}$.

Several different Monte Carlo (MC) event generators are used to produce samples of simulated events of the signal and background processes. The simulation of the $b\bar{b}H$ signal was performed at NLO in quantum chromodynamics (QCD) using the MADGRAPH5_aMC@NLO 2.6.1 generator [25]. Three samples of simulated events are used, corresponding to the three distinct Higgs boson couplings contributing to the $b\bar{b}H$ process (y_b^2 , y_t^2 , and $y_t y_b$).

In all channels, the SM background is dominated by top quark-antiquark pair production ($t\bar{t}$) and by the production of a leptonically decaying weak boson in association with jets (V +jets). A sample of simulated $t\bar{t}$ events is generated with the POWHEG 2.0 generator [26–28] at NLO. The

production of V+jets events is simulated with the MADGRAPH5_aMC@NLO 2.6.5 generator at NLO. Samples of single top quark production events are generated at NLO with the POWHEG 2.0 generator, while diboson events are produced at NLO with the MADGRAPH5_aMC@NLO 2.6.5 generator, or with the POWHEG generator, depending on the specific combination of vector bosons studied. The background from SM events composed solely of jets produced through the strong interaction, referred to as QCD multijet events, is estimated from data as described in Section 6.

The NNPDF 3.1 [29] set of parton distribution functions (PDFs) at next-to-NLO (NNLO) is used in all simulated samples. Parton showering and hadronization are performed with PYTHIA 8.240 with the CP5 [30, 31] underlying event tune. The CMS detector response simulation is performed with GEANT4 [32] for all processes. In the samples produced at NLO with MADGRAPH5_aMC@NLO, the FxFx jet merging scheme is employed [33].

Event reconstruction in simulated samples and recorded data is performed with the same software. The recorded data samples contain additional pp interaction vertices from the same or nearby bunch crossings (pileup). Such additional interaction vertices are generated with PYTHIA and added to all simulated events in accordance with the expected pileup distribution. Corrections are applied to the simulated samples to match the distribution of the pileup multiplicity measured in the recorded data for each year.

5 Trigger and event selection

The online selection [17] for the $\tau_h\tau_h$ channel requires two hadronically decaying tau leptons. In the $\mu\tau_h$ ($e\tau_h$) channel the presence of a muon (electron) is required, and in the $e\mu$ channel a muon-electron pair must be present. In all channels, the selected leptons (ℓ) or hadronically decaying tau leptons (τ_h) are required to match the objects used in the online event selection.

The following selection criteria are common across all channels:

- there must be a $\tau_h\tau_h$, $e\tau_h$, $\mu\tau_h$, or $e\mu$ pair with opposite electric charge. No additional electrons or muons, passing loose identification criteria, may be present in the event;
- the leptons and τ_h candidates must be separated by $\Delta R = \sqrt{(\Delta\phi)^2 + (\Delta\eta)^2} > 0.5(0.3)$ in the $\tau_h\tau_h$, $e\tau_h$, and $\mu\tau_h$ ($e\mu$) channels. Here, ϕ and η refer to the azimuthal angle and the pseudorapidity of the object, respectively;
- there must be either one or two jets identified as originating from a b quark.

Across all channels, jets are selected if they have $p_T > 20$ GeV, $|\eta| < 2.4$, and if they pass quality criteria based on the jet shape. Jet constituents coming from pileup interactions are subtracted. Jets originating from b quarks are identified with the DEEPTAU algorithm [34], which uses information on tracks and secondary vertices associated with the jet to identify its type (g, u/d/s, c, or b). In this Letter an efficiency of 75% for b tagging is chosen, corresponding to a mistagging probability for jets originating from gluons or light quarks of about 3%.

In the $\tau_h\tau_h$ channel, two isolated τ_h candidates with $p_T > 40$ GeV and $|\eta| < 2.1$ are required. To distinguish genuine τ_h decays from jets originating from the hadronization of quarks or gluons, and from electrons or muons, the DEEPTAU algorithm [35] is used. Information from all individually reconstructed particles near the τ_h candidate axis is combined with properties of the τ_h candidate and of the event. Genuine τ_h candidates are selected with an efficiency of 70% for a jet misidentification rate of approximately 0.43%, averaging across jet p_T and flavour.

The misidentification rates of electrons and muons as τ_h candidates are approximately 3% and 0.2%.

In the $e\tau_h$, $\mu\tau_h$, and $e\mu$ channels, electrons and muons coming from W boson or tau lepton decays are treated according to the standard CMS reconstruction for electrons and muons [18, 19].

In the $e\tau_h$ and $\mu\tau_h$ channels, the leptonically decaying tau lepton (τ_ℓ) must have p_T at least 1 GeV above the trigger threshold. The electron is required to have $|\eta| < 2.1$ and $p_T > 26$ (33) GeV in the analysis of 2016 (2017, 2018) data, while the muon is required to have $|\eta| < 2.1$ and $p_T > 23$ (25) GeV for the 2016 (2017, 2018) data-taking period. Quality criteria are used to select the leptons based on their relative isolation from surrounding hadronic activity and the reconstruction quality of their tracks and energy deposits in the CMS subdetectors. The τ_h candidates are required to have $p_T > 30$ GeV, $|\eta| < 2.3$, and to satisfy the same quality criteria as are applied in the $\tau_h\tau_h$ channel. To suppress the Drell–Yan background contribution, we use the DEEPTAU algorithm to reject electrons and muons that mimic τ_h signatures. The residual electron (muon) misidentification rate is 3% ($< 0.1\%$) [35]. The invariant mass between the \vec{p}_T^{miss} and the lepton \vec{p}_T , calculated as

$$m_T(\vec{p}_T, \vec{p}_T^{\text{miss}}) = \sqrt{2p_T p_T^{\text{miss}}(1 - \cos[\Delta\phi(\vec{p}_T, \vec{p}_T^{\text{miss}})])}, \quad (1)$$

is required to be smaller than 60 GeV to reduce the contribution from W +jets events. This also results in the rejection of the $H \rightarrow WW$ signal from the $e\tau_h$ and $\mu\tau_h$ channels.

In the $e\mu$ channel, both the electron and the muon are required to have $p_T > 15$ GeV and $|\eta| < 2.4$, and to pass loose reconstruction criteria. As a result of the kinematical similarities for electron-muon pairs originating from $H \rightarrow WW$ and $H \rightarrow \tau\tau$ decays, as well as the overlap in acceptance, these decays were studied in a single analysis channel.

6 Background estimation

A multitude of background processes contribute to the presented search. Those backgrounds that include genuine hadronically decaying tau leptons, prompt leptons, or leptons misidentified as τ_h candidates are estimated from simulated events. Corrections are derived in sideband regions to better describe the data recorded by the CMS experiment. Processes involving jets misidentified as τ_h candidates and nonprompt leptons, appearing in multijet topologies, are estimated using control regions (CRs) in data, as discussed in the following section.

6.1 Methods based on control regions in data

In the $\tau_h\tau_h$, $e\tau_h$, and $\mu\tau_h$ final states, a large fraction of the background consists of jets misidentified as hadronic tau lepton decays. This contribution is estimated with the “fake factor” (F_F) method, first introduced in Ref. [36]. The shape of the misidentified τ_h background is estimated from a CR obtained by inverting the isolation criterion for the leading τ_h candidate. This CR is thus enriched in jets misidentified as τ_h candidates. The background shape is retrieved via event weights, denoted F_F , that are derived in determination regions (DRs) targeting a specific source of jet contamination. For the $\tau_h\tau_h$ channel only a QCD multijet DR is used, whereas the $e\tau_h$ and $\mu\tau_h$ channels require two additional DRs: one enriched in W +jets events and one enriched in $t\bar{t}$ events. The weights evaluated in these DRs are parameterized as a function of the transverse momenta of the τ_h candidates, and their angular separation, for the $\tau_h\tau_h$ channel. In the $e\tau_h$ and $\mu\tau_h$ channels, they are parameterized as a function of the τ_h candidate p_T .

The parameterization in the $\tau_h\tau_h$ channel also depends on other event properties, such as the number of gluon and light-flavour quark jets or b jets, and the p_T^{miss} . The weighted sum of these F_F is then used to estimate the misidentified τ_h contribution to the signal region.

In the $e\mu$ channel, the QCD multijet background is estimated from events with a reconstructed electron-muon pair with the same electric charge. A transfer factor between this region, and the one where the leptons have opposite charge, is determined in events where the muon isolation requirement is inverted. This background estimation method is commonly referred to as the ‘‘ABCD’’ method (discussed in Refs. [37, 38]).

6.2 Other backgrounds

Other background processes are estimated from simulation. They are corrected to better describe the recorded data separately for each data-taking period.

Corrections are mostly determined in dedicated sideband regions, orthogonal to the event selection described in Section 5. For example, single-lepton trigger efficiencies are computed for the $e\tau_h$ and $\mu\tau_h$ channels using $Z \rightarrow \ell\ell$ enriched CRs, while those for the combined triggers requiring two τ_h candidates or an electron and muon pair are determined, respectively, in a $\mu\tau_h$ - and a $t\bar{t}$ -enriched CR.

Simulation-to-data correction factors are applied to the simulated samples to correct for the mismodelling of the electron and muon identification and isolation efficiencies, and for the τ_h candidate identification efficiency and energy scale. The light lepton efficiencies are measured as a function of the lepton p_T and $|\eta|$, using a ‘‘tag-and-probe’’ technique in $Z \rightarrow ee$ and $Z \rightarrow \mu\mu$ events [19]. Correction factors for genuine τ_h candidates are determined based on their decay mode and p_T , while those for misidentified electrons or muons depend on η [35].

Jet energy and resolution corrections are applied to mitigate the effect of pileup interactions and detector inefficiencies during data taking [39]. Measurements of the momentum balance in dijet, $\gamma + \text{jet}$, $Z + \text{jet}$, and multijet events are used to correct for any residual differences in the jet energy scale between data and simulation [23].

To each reconstructed jet with $p_T > 20 \text{ GeV}$, b tagging scale factors are applied. The b tagging score is weighted based on a multivariate classifier using several jet properties to improve the data modelling [40].

The Z boson mass and momentum are corrected from $Z \rightarrow \mu\mu$ events as a function of the lepton p_T and η . The p_T spectrum in $t\bar{t}$ events is weighted to better describe the data, following the method described in Ref. [41].

7 Event classification

To improve the separation of signal from the background, boosted decision trees (BDTs) are used to classify events into distinct categories. Multiclass BDT models were trained for each channel and data-taking period. The output categories were chosen to reflect the different background compositions in each channel.

For an event, each trained BDT model returns a number of output scores equal to the number of output categories. The scores are then normalized so that their sum is equal to 1. Each output score is therefore interpreted as the probability for the event to originate from one of the physical processes targeting the associated category. Events are sorted into the category for which the output score is the highest.

Table 1: Summary of the BDT categories defined for each channel.

Channel	$e\mu$	$e\tau_h$	$\mu\tau_h$	$\tau_h\tau_h$
BDT Categories	DY, TT, $b\bar{b}H (\rightarrow WW)$, $b\bar{b}H (\rightarrow \tau\tau)$	DY, TT, $b\bar{b}H (\rightarrow \tau\tau)$	DY, TT, $b\bar{b}H (\rightarrow \tau\tau)$	DY+Higgs, TT, $j \rightarrow \tau_h$ misid., $b\bar{b}H (\rightarrow \tau\tau)$

Table 2: Input features to the BDT classifiers used in each of the studied channels. Each variable is marked with the \checkmark symbol if it is used for the training of the BDT models in a particular channel, or the \times symbol if it is not used.

Variable	$e\mu$	$e\tau_h$	$\mu\tau_h$	$\tau_h\tau_h$
$m_{\tau\tau}$	\times	\checkmark	\checkmark	\checkmark
m_{vis}	\checkmark	\checkmark	\checkmark	\checkmark
m_{coll}	\times	\checkmark	\checkmark	\times
D_ζ	\checkmark	\checkmark	\checkmark	\times
$\Delta\eta$ between lepton and τ_h	\times	\checkmark	\checkmark	\times
Total transverse mass	\checkmark	\times	\times	\times
Di- τ p_T	\checkmark	\checkmark	\checkmark	\checkmark
Electron p_T	\checkmark	\times	\times	\times
Muon p_T	\checkmark	\times	\times	\times
p_T of leading τ_h	\times	\times	\times	\checkmark
p_T of trailing τ_h	\times	\times	\times	\checkmark
m_T	\times	\checkmark	\checkmark	\times
Number of b-tagged jets	\checkmark	\times	\times	\checkmark
p_T of leading b-tagged jet	\checkmark	\checkmark	\checkmark	\checkmark
p_T of trailing b-tagged jet	\times	\checkmark	\checkmark	\times
B tag score for leading b-tagged jet	\times	\checkmark	\checkmark	\checkmark
$\Delta\eta$ between di- τ p_T and leading b-tagged jet	\times	\checkmark	\checkmark	\times
B tag score for trailing b-tagged jet	\times	\checkmark	\checkmark	\checkmark
Number of jets	\checkmark	\times	\times	\checkmark
p_T of leading jet	\checkmark	\times	\times	\checkmark
p_T of trailing jet	\checkmark	\times	\times	\checkmark
Dijet invariant mass	\times	\times	\times	\checkmark
Dijet $\Delta\eta$	\checkmark	\times	\times	\checkmark
p_T^{miss}	\times	\times	\times	\checkmark

All BDT models have a dedicated category targeting $H \rightarrow \tau\tau$ decays, trained on the $b\bar{b}H(y_b^2)$ and $b\bar{b}H(y_\tau^2)$ processes. The interference term was not used in the BDT training due to the low acceptance. Other common categories target the DY+jets (DY) and $t\bar{t}$ (TT) background processes, as their signatures in the detector resemble those of b quark associated Higgs boson production in final states involving tau leptons. The $e\mu$ channel has an additional signal category, targeting Higgs boson decays to W bosons. As the sensitivity of this channel is driven by the $H \rightarrow WW$ process, the BDT is trained to optimize the separation between this signal and the $t\bar{t}$ background. In the $\tau_h\tau_h$ channel the contribution of QCD multijet production with jets misidentified as τ_h candidates ($j \rightarrow \tau_h$ misid.) to the total background is larger than in the other channels and was therefore assigned to a dedicated category.

Additional BDT models incorporating a further background category targeting other Higgs boson production mechanisms, such as the Higgs-strahlung process with a Z boson decaying into

a pair of b quarks, were trained. These models identified the $b\bar{b}H$ process less efficiently, with a marginal improvement found only in the $\tau_h\tau_h$ channel. After applying the event selection introduced in Section 5, only a small number of events is left in this Higgs category, which is therefore merged with the DY+jets category for the statistical inference.

A summary of the BDT categories used in each channel is shown in Table 1. Although the label “TT” is used in all categories, the $t\bar{t}$ events used in each trained model differ: in the $\tau_h\tau_h$ channel only events with genuine τ_h candidates are targeted by the “TT” category, in the other channels the “TT” categories target $t\bar{t}$ events with no further selection.

As shown in Table 2, the set of variables used in the BDT training differs slightly across channels. Each set was chosen based on the potential separation between the $b\bar{b}H$ signals from the various backgrounds in each channel. Variables that were not satisfactorily modelled in the MC samples used to train the BDT models were removed from a set to avoid introducing a bias in the relative channel towards a specific category. In cases where the mismodelling was specifically found for one year of data taking, the variable was nonetheless removed from the training set for all BDT models related to that channel. Several input features are based on approximations of the Higgs boson invariant mass and transverse momentum. These event properties bring the best separation power between the $b\bar{b}H$ process and the backgrounds. In the $e\tau_h$, $\mu\tau_h$, and $\tau_h\tau_h$ channels, a dedicated likelihood-based algorithm, SVFIT [42], is used to reconstruct the kinematical properties of the di-tau system based on the momentum of the individual tau leptons, their decay modes, and the p_T^{miss} . The resulting di-tau mass and momentum are labelled as $m_{\tau\tau}$ and $p_{T,\tau\tau}$. The kinematical properties of individual tau leptons are additionally used as separate input features in the $\tau_h\tau_h$ channel.

Other variables related to the di-tau system are the collinear di-tau mass (m_{coll}), the invariant mass of the visible tau decay product system (m_{vis}), and the pseudorapidity separation between the visible decay products of the tau leptons ($\Delta\eta_{\ell,\tau_h}$). The collinear mass is reconstructed assuming that the neutrinos produced in tau lepton decays are collinear with the visible tau lepton decay products. It is defined as [43]:

$$m_{\text{coll}} = \frac{m_{\text{vis}}}{\sqrt{\frac{p_T^\ell}{p_T^\ell + p_T^{\text{miss}}} \frac{p_T^{\tau_h}}{p_T^{\tau_h} + p_T^{\text{miss}}}}. \quad (2)$$

Both mass variables are insensitive to $H \rightarrow WW$ decays due to their different p_T^{miss} distribution.

A similar assumption for the neutrino direction of flight underpins the introduction of the D_ζ variable. This is defined as the linear combination of the projection of the p_T^{miss} along the bisector of the leptons or τ_h candidates ($\hat{\zeta}$) and the momentum of the dilepton (or lepton plus τ_h) system (\vec{p}_T^{tot}):

$$D_\zeta = p_\zeta^{\text{miss}} - 0.85 p_\zeta^{\text{vis}}, \quad (3)$$

with

$$p_\zeta^{\text{miss}} = \vec{p}_T^{\text{miss}} \cdot \hat{\zeta} \quad \text{and} \quad p_\zeta^{\text{vis}} = \vec{p}_T^{\text{tot}} \cdot \hat{\zeta}. \quad (4)$$

The value of 0.85 was optimized to maximize the separation power between resonant $\tau_e\tau_\mu$ decays from Higgs or Z bosons and the more isotropic neutrino emissions found in $t\bar{t}$ or Higgs boson decays to W bosons [44].

The transverse mass (m_T), introduced in Eq. (1), is calculated using different objects, depending on the channel. In the $e\tau_h$ and $\mu\tau_h$ channels, the transverse mass is computed from the charged lepton and the missing transverse momentum. The observable is used to reduce the

background contribution from electroweak processes in these channels. In the $e\mu$ channel, m_T is used to compute the total transverse mass of the electron, muon, and missing transverse momentum system:

$$m_{T,\text{tot}} = \sqrt{m_T(\mu, e)^2 + m_T(e, p_T^{\text{miss}})^2 + m_T(\mu, p_T^{\text{miss}})^2}, \quad (5)$$

which is used as an estimator of the Higgs boson transverse mass for both the $H \rightarrow \tau\tau$ and $H \rightarrow WW$ decays.

Other features that enter the BDT training relate to the reconstructed jets.

As discussed in the next sections, the limits on the $b\bar{b}H$ production cross section are extracted from a combined fit of the distributions of the BDT scores across all categories. Figure 2 shows these distributions for the $H \rightarrow \tau\tau$ categories in the $\tau_h\tau_h$, $e\tau_h$, and $\mu\tau_h$ channels, and for the $H \rightarrow WW$ category in the $e\mu$ channel. The lower-BDT score regions are dominated by background processes, while the higher-score regions show an increasing contribution from the $b\bar{b}H$ process.

8 Systematic uncertainties

The uncertainty model includes theoretical uncertainties, experimental uncertainties, and uncertainties due to the limited size of the simulated samples of events.

Theoretical uncertainties include those in the parameters used to compute the production cross section predictions. These are uncertainties in the chosen value of the strong coupling, the uncertainty coming from higher-order QCD and EW corrections, and effects due to the variation of the renormalization and factorization scales. Uncertainties from higher-order corrections to the $b\bar{b}H$ production cross section lead to a normalization uncertainty ranging from -24% to 20% for the $b\bar{b}H(y_b^2)$ and $b\bar{b}H(y_t y_b)$ processes, and -6.7% to 4.6% for ggH production. An additional uncertainty ranging from -31% to 47% is introduced to cover theoretical uncertainties in the additional gluon splitting to $b\bar{b}$ ($b\bar{b}H(y_t^2)$) [8, 15].

The scale variation uncertainties not only affect the process normalization, but also the shapes of the distributions used for the statistical inference. These variations are computed by independently multiplying and dividing these scales by a factor of two with respect to their theoretical predictions, and re-evaluating the $b\bar{b}H$ production cross section. Additional uncertainties are introduced to cover the scale variation effects on the parton shower.

Uncertainties that affect only the normalization of the distributions used for the statistical inference follow a log-normal probability density function, and are labelled ‘lnN’ in Table 3. Some of the most notable are:

- the uncertainty in the integrated luminosity measurement, partially correlated between the different data-taking periods. The integrated luminosities for the 2016, 2017, and 2018 data-taking years have individual uncertainties ranging from 1.2 to 2.5% [45–47], while the overall uncertainty for the 2016–2018 period is 1.6%;
- the electron and muon identification efficiency uncertainties are estimated to be approximately 2%;
- the uncertainties in the misidentification rate of electrons and muons to τ_h depend on the $\tau_h\eta$, and are estimated to be 7.5% and 6%, respectively;
- the production cross section uncertainties are estimated as 5% for the diboson and

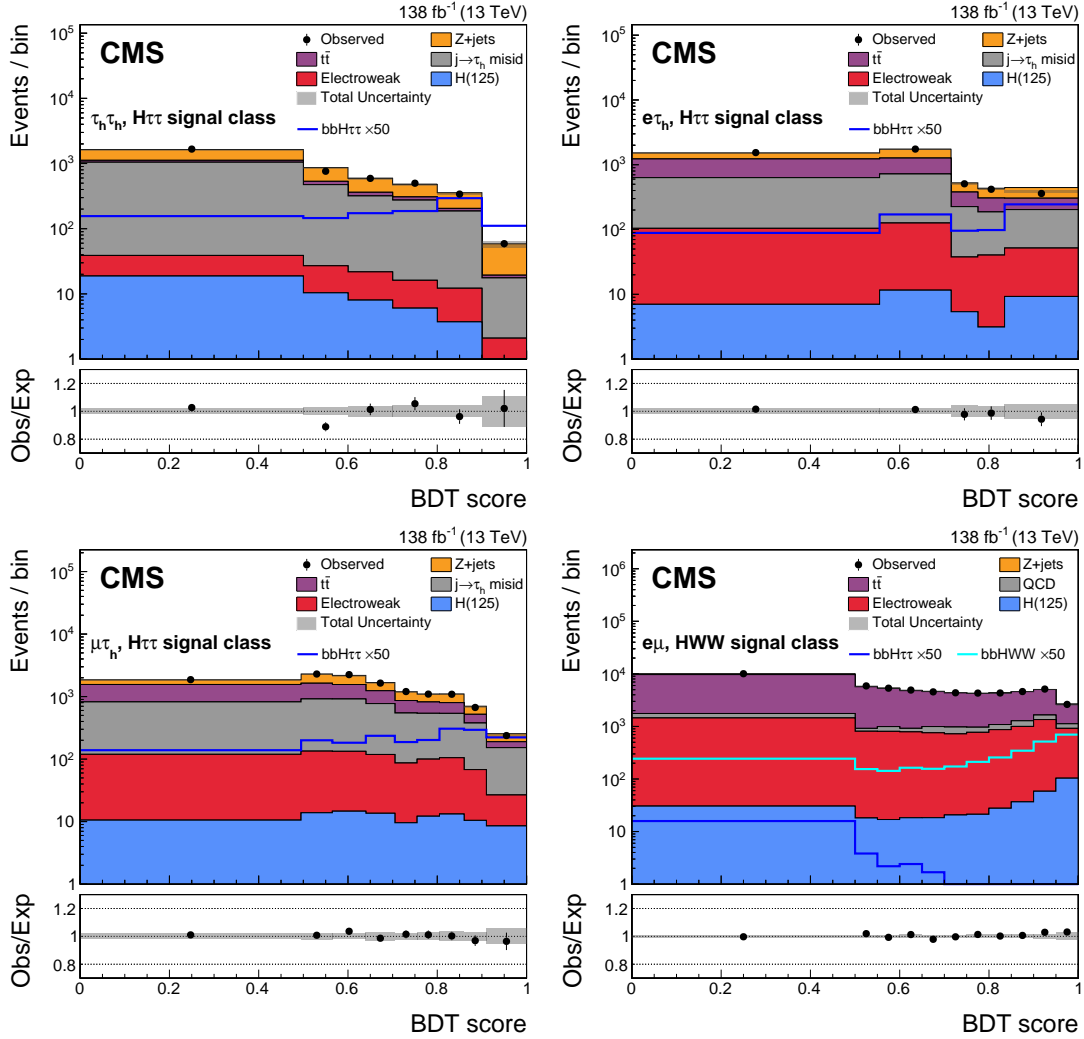

Figure 2: The BDT $H \rightarrow \tau\tau$ class output score distributions for the $\tau_h\tau_h$ (upper left), $e\tau_h$ (upper right), and $\mu\tau_h$ (lower left) channels; and the $H \rightarrow WW$ output score for the $e\mu$ channel (lower right). The $bbH\tau\tau$ signal is multiplied by a factor of 50, while all other processes are scaled according to a combined fit of all BDT categories for all channels and years used in this analysis. The total uncertainty includes the statistical and systematic uncertainties. Electroweak processes in the figure include diboson, W +jets, and single top quark production. For channels involving τ_h candidates, the $j \rightarrow \tau_h$ misid contribution is estimated from data with the F_F method and grouped together. Simulated events with jets misidentified as τ_h candidates are removed from the electroweak, DY +jets, and $t\bar{t}$ groups. For the $e\mu$ channel, the QCD multijet process is estimated using the “ABCD” method. The $H(125)$ group includes processes where a Higgs boson is produced not in association with b quarks, including the top quark associated production and Higgs-strahlung processes, since the b jets in these events originate from the top quark and vector boson decays.

single top quark processes [48, 49], 6% for $t\bar{t}$ [50, 51], 4% for the W +jets process [52], 2% for DY +jets [52, 53], and 15% for $t\bar{t}V$ +jets [54].

Uncertainties in the energy scale of objects such as jets, τ_h , and p_T^{miss} alter the distributions of the input features to the BDT models, and as such modify the shape of the BDT score distribution. The jet energy is corrected based on sources such as the detector efficiency during data taking, pileup interactions, and the clustering efficiency. The corresponding uncertainties are

Table 3: Summary table of the systematic uncertainties affecting the background processes. For uncertainties that vary significantly depending on the kinematic properties of the event, the label *event-dep.* is used. The labels ‘lnN’ and ‘shape’ are used, respectively, for uncertainties affecting only the process normalization or having a shape-altering effects.

Description	Value	Templates affected	Type
Luminosity	2016: 1.2% 2017: 2.3% 2018: 2.5%	MC	lnN
DY+jets production cross section	2%	DY	lnN
$t\bar{t}$ production cross section	6%	$t\bar{t}$	lnN
W+jets production cross section	4%	W+jets	lnN
Diboson production cross section	5%	VV	lnN
Single top quark production cross section	5%	single top	lnN
$t\bar{t}V$ +jets production cross section	15%	$t\bar{t}V$ +jets	lnN
Higgs boson production cross section	0.5–8%	H (except $b\bar{b}H$)	lnN
$H \rightarrow \tau\tau$ branching fraction	2.1%	$H \rightarrow \tau\tau$	lnN
$H \rightarrow WW$ branching fraction	1.5%	$H \rightarrow WW$	lnN
α_S variation	3.2%	$b\bar{b}H$	lnN
μ/e identification	2%	MC	lnN
$e\mu$ trigger	1.5%	MC	lnN
Single μ/e trigger	p_T and η dep.	MC	shape
τ_h trigger	p_T -dep.	MC	shape
b tagging	1–9%	MC	shape
$\mu(e) \rightarrow \tau_h$ fake rate	η_{τ_h} dep.	MC with $\ell \rightarrow \tau_h$	shape
τ_h identification	p_T and DM dep. (2–3%)	MC	shape
τ_h energy scale	DM dep. (1%)	MC	shape
Jet energy scale	event-dep.	MC	shape
Jet energy resolution	event-dep.	MC	shape
p_T^{miss} unclustered energy scale	event-dep.	MC	shape
Top quark p_T reweighting	event-dep. (<10%)	$t\bar{t}$, single top	shape
Z boson p_T reweighting	event-dep. (<5%)	DY	shape
QCD multijet unc.	event-dep.	nonprompt ℓ ($e\mu$ channel)	lnN
F_F uncertainties	event-dep.	$j \rightarrow \tau_h$ fakes	shape
Prefiring	event-dep.	MC	lnN
Bin-by-bin stat. unc.	$\sqrt{N_{\text{events}}}$	All	shape

divided into groups depending on whether they are correlated across data-taking years and channels, or uncorrelated. They are shown in Table 3 as *Jet ES* and *Jet energy resolution*, and their values depend primarily on the jet p_T . These corrections are propagated to the p_T^{miss} , in addition to those accounting for PF candidates that are not clustered within jets. The τ_h iden-

tification and energy scale depend on the τ_h candidate decay mode (DM) and p_T . Additional uncertainties cover the energy scales of prompt and misidentified electrons and muons, and the p_T^{miss} .

The estimation of background contributions originating from nonprompt or misidentified leptons and jets leads to additional uncertainties. The ‘‘ABCD’’ method for the $e\mu$ channel and the F_F method for the $\tau_h\tau_h$, $e\tau_h$, and $\mu\tau_h$ channels introduce shape-altering uncertainties pertaining to the statistical uncertainties in the samples used for the measurement of the extrapolation scale factors, the misidentification rate for jets as leptons or τ_h , and closure tests on observables used in the analysis. Residual disagreement in the background modelling is covered by additional uncertainties generally below 5–7% across the studied parameter space.

The shape correction for the b tagging classifier introduces shape-altering effects on the BDT score. Further uncertainties originate from the correction of the top quark and Z boson p_T spectra in the $t\bar{t}$ [55] and DY+jets processes, respectively. For both, the uncertainty is estimated as the size of the correction itself.

During the 2016 and 2017 data-taking periods, an increase in the offset of the ECAL timing pulse led the Level-1 trigger relying on ECAL to fire on the previous bunch crossing (prefiring). An uncertainty, negligible in some cases and ranging up to 4%, is introduced to account for this phenomenon.

Uncertainties accounting for the finite sizes of the simulated event samples, and the side-band regions used for the data-driven background estimates, are incorporated via the Barlow–Beeston ‘‘light’’ procedure [56, 57].

9 Results

The statistical analysis is performed via a simultaneous binned maximum likelihood fit to the data in all BDT categories described in Section 7. The results were obtained using the CMS statistical analysis tool COMBINE [58].

Upper limits at the 95% confidence level (CL) are set, considering as signal the sum of the $b\bar{b}H(y_b^2)$ and $b\bar{b}H(y_t^2)$ contributions together with their interference term. These sum up to a total cross section of $\sigma_{\text{theory}} = 1.489$ pb. Limits are placed on the ratio between the measured cross section and its theoretical prediction:

$$\mu = \frac{\sigma(\text{pp} \rightarrow b\bar{b}H(y_b, y_t))}{\sigma_{\text{theory}}}, \quad (6)$$

which is referred to as the signal strength.

The upper limits are set using the modified frequentist CL_s criterion [59, 60], with the profile likelihood ratio modified for upper limits [61] as the test statistic. The asymptotic approximation [62] is used in the limit setting procedure. To extract the two-dimensional constraints presented later in this section, we use the profile likelihood ratio from Ref. [61] as the test statistic. The 68% (95%) confidence intervals are constructed as the union of points for which the difference in twice the negative log-likelihood with respect to the minimum is below 2.28 (5.99). In all cases, the experimental and theoretical uncertainties are incorporated in the likelihood as nuisance parameters.

The 95% CL upper limits on the signal strength are shown in Fig. 3. These limits are obtained by coherently varying all contributions to the production cross section considered, namely those

depending on Yukawa couplings to the bottom or top quark and their interference term. The combination of all channels yields an observed (expected) upper limit of 3.7 (6.1) at 95% CL.

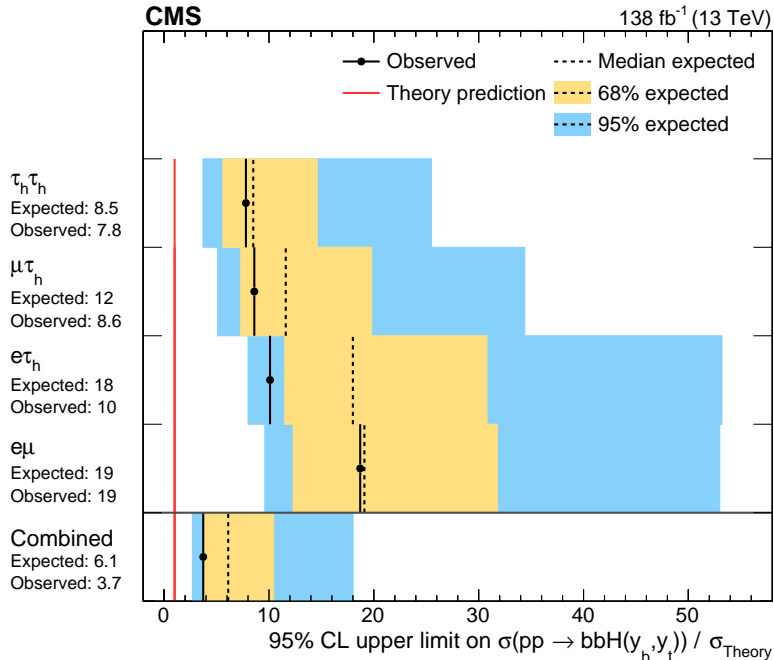

Figure 3: Upper limits at the 95% CL on the signal strength for the the $pp \rightarrow b\bar{b}H(y_b, y_t)$ process. The terms in which the Higgs boson is produced via Yukawa couplings with top or bottom quarks contribute to the estimated relative production cross sections. The interference term between these contributions is also accounted for. The $pp \rightarrow Z(\rightarrow b\bar{b})H$ process is treated as a background in this search. The theoretical prediction, shown as a red line placed at 1, corresponds to the estimated production cross section of 1.489 pb. The black markers show the observed limits, and the dashed lines with the yellow and blue uncertainty bands represent the expected upper limits with their 68% and 95% central intervals.

Varying each contribution separately makes it possible to constrain the coupling structure of the Higgs boson. This is done by introducing the coupling scaling parameters κ_t and κ_b , which represent deviations from the SM expectation in the Higgs boson coupling strengths, and performing a likelihood ratio scan over the κ_t - κ_b parameter space. To account for the bottom quark contribution to the quark loop in the $b\bar{b}H(y_t^2)$ process, this contribution is scaled by $1.04\kappa_t^2 - 0.04\kappa_b\kappa_t + 0.002\kappa_b^2$ [8], while the $b\bar{b}H(y_b^2)$ contribution and the interference term are scaled by κ_b^2 and $\kappa_b\kappa_t$, respectively. To constrain the κ_t parameter, the results obtained in this analysis have been combined with the Higgs boson production cross section measurement in final states with two tau leptons [63] previously published by the CMS Collaboration. The published measurement required the absence of b-tagged jets, meaning that its limits on κ_b are entirely derived from the constraints on the Higgs boson decay width that are present in the coupling modifier model. The combination was performed at the level of the inputs for the statistical inference, because the presence of a b jet veto in Ref. [63] makes that measurement orthogonal to the search presented here.

The expected constraints in the κ_t - κ_b parameter space are shown in Fig. 4 for the previous CMS results in red, and in combination with the study presented in this Letter in green. A noticeable improvement in the constraint on the κ_b parameter, shown by the tightening of the 68% confidence interval contour, is observed in the combined limits. The constraints observed

when fitting to the data are shown in blue, with the best fit point found at the coordinates $(\kappa_t, \kappa_b) = (-0.73, 1.58)$. The limits are compatible with the SM expectation at 95% CL. In this fit the κ_b and κ_t parameters are left freely floating, together with the coupling modifier for the tau leptons Yukawa coupling (κ_τ); the other coupling parameters are fixed to their SM values. This means some of the constraints on κ_b are indirect, from assumptions on the total Higgs boson decay width. The effects of these constraints can be observed in the red contours in Fig. 4, as the measurement of the $H \rightarrow \tau\tau$ production cross section from Ref. [63] did not include Higgs boson production processes involving the κ_b coupling, beyond its contribution to the quark loop in the ggH process.

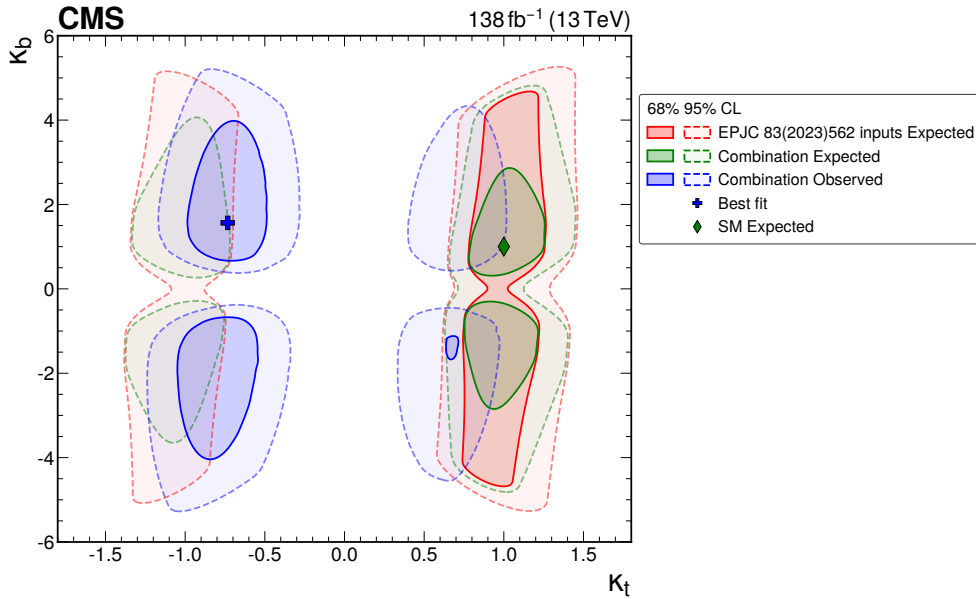

Figure 4: Two-dimensional confidence intervals on the κ_b and κ_t parameters for the channels studied in this search. Expected limits are shown in red for the $H \rightarrow \tau\tau$ cross section measurement [63] performed for other Higgs boson production mechanisms and in green for the combination with the analysis presented in this Letter. The observed constraints are shown in blue, with a cross marking the best fit point. A green diamond is placed to mark the SM expectation. Solid lines with shaded areas mark the 68% confidence interval contours, and dashed lines mark the 95% confidence interval.

Most of the considered processes are not sensitive to the sign of the Yukawa couplings, leading to a partial degeneracy with respect to the coupling sign. This is more noticeable for κ_b , since the degeneracy is only broken by the $b\bar{b}H(y_t y_b)$ interference term and the different flavour contributions to the quark loop in the ggH process. The observed limits on κ_t show a slight preference for negative values and are compatible with the SM prediction at 95% CL. The observed limits on κ_b exclude $\kappa_b = 0$ at 95% CL and are also compatible within 68% CL with those measured in a combined fit of Higgs boson production and decay channels, including $H \rightarrow b\bar{b}$, performed by the CMS Collaboration with data collected in Run 2 [7]. At present, the uncertainty in the κ_b measurement is around 7 times larger than the established constraints provided by the analysis of Higgs boson decays.

10 Summary

A search for the 125 GeV Higgs boson produced in association with bottom quarks and decaying into a pair of tau leptons or W bosons has been presented. The search was performed on data collected by the CMS experiment in the period 2016–2018 at a centre-of-mass energy of $\sqrt{s} = 13$ TeV, corresponding to an integrated luminosity of 138 fb^{-1} . This search was performed in four final states: $\tau_h\tau_h$, $e\tau_h$, $\mu\tau_h$, and $e\mu$. Higgs boson decays to tau leptons were targeted in all four final states, while $H \rightarrow WW$ decays contributed only in the $e\mu$ channel as a result of the kinematical similarities between the two decay processes. At the current level of precision, the background processes provide an adequate description of the observed data, and no significant excess above the background-only expectation was found. The observed (expected) upper limit at the 95% confidence level (CL) on the $b\bar{b}H$ production cross section is 3.7 (6.1) times the standard model prediction. The search also constrained the Higgs Yukawa couplings to bottom and top quarks in the κ -model interpretation. The best fit value for the coupling modifiers was found to be $(\kappa_t, \kappa_b) = (-0.73, 1.58)$. The observed constraints are compatible with the standard model expectation at the 95% CL.

Acknowledgments

We congratulate our colleagues in the CERN accelerator departments for the excellent performance of the LHC and thank the technical and administrative staffs at CERN and at other CMS institutes for their contributions to the success of the CMS effort. In addition, we gratefully acknowledge the computing centres and personnel of the Worldwide LHC Computing Grid and other centres for delivering so effectively the computing infrastructure essential to our analyses. Finally, we acknowledge the enduring support for the construction and operation of the LHC, the CMS detector, and the supporting computing infrastructure provided by the following funding agencies: SC (Armenia), BMBWF and FWF (Austria); FNRS and FWO (Belgium); CNPq, CAPES, FAPERJ, FAPERGS, and FAPESP (Brazil); MES and BNSF (Bulgaria); CERN; CAS, MoST, and NSFC (China); MINCIENCIAS (Colombia); MSES and CSF (Croatia); RIF (Cyprus); SENESCYT (Ecuador); ERC PRG, RVTT3 and MoER TK202 (Estonia); Academy of Finland, MEC, and HIP (Finland); CEA and CNRS/IN2P3 (France); SRNSF (Georgia); BMBF, DFG, and HGF (Germany); GSRI (Greece); NKFIH (Hungary); DAE and DST (India); IPM (Iran); SFI (Ireland); INFN (Italy); MSIP and NRF (Republic of Korea); MES (Latvia); LMTLT (Lithuania); MOE and UM (Malaysia); BUAP, CINVESTAV, CONACYT, LNS, SEP, and UASLP-FAI (Mexico); MOS (Montenegro); MBIE (New Zealand); PAEC (Pakistan); MES and NSC (Poland); FCT (Portugal); MESTD (Serbia); MCIN/AEI and PCTI (Spain); MOSTR (Sri Lanka); Swiss Funding Agencies (Switzerland); MST (Taipei); MHESI and NSTDA (Thailand); TUBITAK and TENMAK (Turkey); NASU (Ukraine); STFC (United Kingdom); DOE and NSF (USA).

Individuals have received support from the Marie-Curie programme and the European Research Council and Horizon 2020 Grant, contract Nos. 675440, 724704, 752730, 758316, 765710, 824093, 101115353, 101002207, and COST Action CA16108 (European Union); the Leventis Foundation; the Alfred P. Sloan Foundation; the Alexander von Humboldt Foundation; the Science Committee, project no. 22rl-037 (Armenia); the Belgian Federal Science Policy Office; the Fonds pour la Formation à la Recherche dans l'Industrie et dans l'Agriculture (FRIA-Belgium); the F.R.S.-FNRS and FWO (Belgium) under the "Excellence of Science – EOS" – be.h project n. 30820817; the Beijing Municipal Science & Technology Commission, No. Z191100007219010 and Fundamental Research Funds for the Central Universities (China); the Ministry of Education, Youth and Sports (MEYS) of the Czech Republic; the Shota Rustaveli National Science

Foundation, grant FR-22-985 (Georgia); the Deutsche Forschungsgemeinschaft (DFG), among others, under Germany's Excellence Strategy – EXC 2121 “Quantum Universe” – 390833306, and under project number 400140256 - GRK2497; the Hellenic Foundation for Research and Innovation (HFRI), Project Number 2288 (Greece); the Hungarian Academy of Sciences, the New National Excellence Program - ÚNKP, the NKFIH research grants K 131991, K 133046, K 138136, K 143460, K 143477, K 146913, K 146914, K 147048, 2020-2.2.1-ED-2021-00181, and TKP2021-NKTA-64 (Hungary); the Council of Science and Industrial Research, India; ICSC – National Research Centre for High Performance Computing, Big Data and Quantum Computing and FAIR – Future Artificial Intelligence Research, funded by the NextGenerationEU program (Italy); the Latvian Council of Science; the Ministry of Education and Science, project no. 2022/WK/14, and the National Science Center, contracts Opus 2021/41/B/ST2/01369 and 2021/43/B/ST2/01552 (Poland); the Fundação para a Ciência e a Tecnologia, grant CEECIND/01334/2018 (Portugal); the National Priorities Research Program by Qatar National Research Fund; MCIN/AEI/10.13039/501100011033, ERDF “a way of making Europe”, and the Programa Estatal de Fomento de la Investigación Científica y Técnica de Excelencia María de Maeztu, grant MDM-2017-0765 and Programa Severo Ochoa del Principado de Asturias (Spain); the Chulalongkorn Academic into Its 2nd Century Project Advancement Project, and the National Science, Research and Innovation Fund via the Program Management Unit for Human Resources & Institutional Development, Research and Innovation, grant B39G670016 (Thailand); the Kavli Foundation; the Nvidia Corporation; the SuperMicro Corporation; the Welch Foundation, contract C-1845; and the Weston Havens Foundation (USA).

References

- [1] ATLAS Collaboration, “Observation of a new particle in the search for the standard model Higgs boson with the ATLAS detector at the LHC”, *Phys. Lett. B* **716** (2012) 1, doi:10.1016/j.physletb.2012.08.020, arXiv:1207.7214.
- [2] CMS Collaboration, “Observation of a new boson at a mass of 125 GeV with the CMS experiment at the LHC”, *Phys. Lett. B* **716** (2012) 30, doi:10.1016/j.physletb.2012.08.021, arXiv:1207.7235.
- [3] CMS Collaboration, “Observation of a new boson with mass near 125 GeV in pp collisions at $\sqrt{s} = 7$ and 8 TeV”, *JHEP* **06** (2013) 081, doi:10.1007/JHEP06(2013)081, arXiv:1303.4571.
- [4] ATLAS Collaboration, “The ATLAS experiment at the CERN Large Hadron Collider”, *JINST* **3** (2008) S08003, doi:10.1088/1748-0221/3/08/S08003.
- [5] CMS Collaboration, “The CMS experiment at the CERN LHC”, *JINST* **3** (2008) S08004, doi:10.1088/1748-0221/3/08/S08004.
- [6] ATLAS Collaboration, “A detailed map of Higgs boson interactions by the ATLAS experiment ten years after the discovery”, *Nature* **607** (2022) 52, doi:10.1038/s41586-022-04893-w, arXiv:2207.00092. [Erratum: doi:10.1038/s41586-022-05581-5].
- [7] CMS Collaboration, “A portrait of the Higgs boson by the CMS experiment ten years after the discovery”, *Nature* **607** (2022) 60, doi:10.1038/s41586-022-04892-x, arXiv:2207.00043.

- [8] LHC Higgs Cross Section Working Group, “Handbook of LHC Higgs Cross Sections: 4. Deciphering the Nature of the Higgs Sector”, volume 2/2017. CERN, 10, 2016. doi:10.23731/CYRM-2017-002.
- [9] ATLAS Collaboration, “Observation of Higgs boson production in association with a top quark pair at the LHC with the ATLAS detector”, *Phys. Lett. B* **784** (2018) 173, doi:10.1016/j.physletb.2018.07.035, arXiv:1806.00425.
- [10] CMS Collaboration, “Observation of $t\bar{t}H$ production”, *Phys. Rev. Lett.* **120** (2018) 231801, doi:10.1103/PhysRevLett.120.231801, arXiv:1804.02610.
- [11] D. Pagani, H.-S. Shao, and M. Zaro, “RIP $Hb\bar{b}$: how other Higgs production modes conspire to kill a rare signal at the LHC”, *JHEP* **11** (2020) 036, doi:10.1007/JHEP11(2020)036, arXiv:2005.10277.
- [12] CMS Collaboration, “Search for additional neutral MSSM Higgs bosons in the $\tau\tau$ final state in proton-proton collisions at $\sqrt{s} = 13$ TeV”, *JHEP* **09** (2018) 007, doi:10.1007/JHEP09(2018)007, arXiv:1803.06553.
- [13] CMS Collaboration, “Searches for additional Higgs bosons and for vector leptoquarks in $\tau\tau$ final states in proton-proton collisions at $\sqrt{s} = 13$ TeV”, *JHEP* **07** (2023) 073, doi:10.1007/JHEP07(2023)073, arXiv:2208.02717.
- [14] HEPData record for this analysis, 2024. doi:10.17182/hepdata.153508.
- [15] N. Deutschmann, F. Maltoni, M. Wiesemann, and M. Zaro, “Top-Yukawa contributions to bbH production at the LHC”, *JHEP* **07** (2019) 054, doi:10.1007/JHEP07(2019)054, arXiv:1808.01660.
- [16] CMS Collaboration, “Performance of the CMS Level-1 trigger in proton-proton collisions at $\sqrt{s} = 13$ TeV”, *JINST* **15** (2020) P10017, doi:10.1088/1748-0221/15/10/P10017, arXiv:2006.10165.
- [17] CMS Collaboration, “The CMS trigger system”, *JINST* **12** (2017) P01020, doi:10.1088/1748-0221/12/01/P01020, arXiv:1609.02366.
- [18] CMS Collaboration, “Electron and photon reconstruction and identification with the CMS experiment at the CERN LHC”, *JINST* **16** (2021) P05014, doi:10.1088/1748-0221/16/05/P05014, arXiv:2012.06888.
- [19] CMS Collaboration, “Performance of the CMS muon detector and muon reconstruction with proton-proton collisions at $\sqrt{s} = 13$ TeV”, *JINST* **13** (2018) P06015, doi:10.1088/1748-0221/13/06/P06015, arXiv:1804.04528.
- [20] CMS Collaboration, “Description and performance of track and primary-vertex reconstruction with the CMS tracker”, *JINST* **9** (2014) P10009, doi:10.1088/1748-0221/9/10/P10009, arXiv:1405.6569.
- [21] CMS Collaboration, “Particle-flow reconstruction and global event description with the CMS detector”, *JINST* **12** (2017) P10003, doi:10.1088/1748-0221/12/10/P10003, arXiv:1706.04965.
- [22] CMS Collaboration, “Performance of reconstruction and identification of τ leptons decaying to hadrons and ν_τ in pp collisions at $\sqrt{s} = 13$ TeV”, *JINST* **13** (2018) P10005, doi:10.1088/1748-0221/13/10/P10005, arXiv:1809.02816.

- [23] CMS Collaboration, “Jet energy scale and resolution in the CMS experiment in pp collisions at 8 TeV”, *JINST* **12** (2017) P02014, doi:10.1088/1748-0221/12/02/P02014, arXiv:1607.03663.
- [24] CMS Collaboration, “Performance of missing transverse momentum reconstruction in proton-proton collisions at $\sqrt{s} = 13$ TeV using the CMS detector”, *JINST* **14** (2019) P07004, doi:10.1088/1748-0221/14/07/P07004, arXiv:1903.06078.
- [25] J. Alwall et al., “The automated computation of tree-level and next-to-leading order differential cross sections, and their matching to parton shower simulations”, *JHEP* **07** (2014) 079, doi:10.1007/JHEP07(2014)079, arXiv:1405.0301.
- [26] S. Frixione, P. Nason, and C. Oleari, “Matching NLO QCD computations with parton shower simulations: the POWHEG method”, *JHEP* **11** (2007) 070, doi:10.1088/1126-6708/2007/11/070, arXiv:0709.2092.
- [27] S. Alioli, P. Nason, C. Oleari, and E. Re, “A general framework for implementing NLO calculations in shower Monte Carlo programs: the POWHEG BOX”, *JHEP* **06** (2010) 043, doi:10.1007/JHEP06(2010)043, arXiv:1002.2581.
- [28] P. Nason, “A new method for combining NLO QCD with shower Monte Carlo algorithms”, *JHEP* **11** (2004) 040, doi:10.1088/1126-6708/2004/11/040, arXiv:hep-ph/0409146.
- [29] NNPDF Collaboration, “Parton distributions from high-precision collider data”, *Eur. Phys. J. C* **77** (2017) 663, doi:10.1140/epjc/s10052-017-5199-5, arXiv:1706.00428.
- [30] T. Sjöstrand et al., “An introduction to PYTHIA 8.2”, *Comput. Phys. Commun.* **191** (2015) 159, doi:10.1016/j.cpc.2015.01.024, arXiv:1410.3012.
- [31] CMS Collaboration, “Extraction and validation of a new set of CMS PYTHIA8 tunes from underlying-event measurements”, *Eur. Phys. J. C* **80** (2020) 4, doi:10.1140/epjc/s10052-019-7499-4, arXiv:1903.12179.
- [32] GEANT4 Collaboration, “GEANT4—a simulation toolkit”, *Nucl. Instrum. Meth. A* **506** (2003) 250, doi:10.1016/S0168-9002(03)01368-8.
- [33] R. Frederix and S. Frixione, “Merging meets matching in MC@NLO”, *JHEP* **12** (2012) 061, doi:10.1007/JHEP12(2012)061, arXiv:1209.6215.
- [34] E. Bols et al., “Jet flavour classification using DeepJet”, *JINST* **15** (2020) P12012, doi:10.1088/1748-0221/15/12/p12012.
- [35] CMS Collaboration, “Identification of hadronic tau lepton decays using a deep neural network”, *JINST* **17** (2022) P07023, doi:10.1088/1748-0221/17/07/P07023, arXiv:2201.08458.
- [36] CMS Collaboration, “Measurement of the $Z\gamma^* \rightarrow \tau\tau$ cross section in pp collisions at $\sqrt{s} = 13$ TeV and validation of τ lepton analysis techniques”, *Eur. Phys. J. C* **78** (2018) 708, doi:10.1140/epjc/s10052-018-6146-9, arXiv:1801.03535.
- [37] CDF Collaboration, “A measurement of the ratio $\sigma \times B(p\bar{p} \rightarrow W \rightarrow e\nu) / \sigma \times B(p\bar{p} \rightarrow Z^0 \rightarrow ee)$ in $p\bar{p}$ collisions at $\sqrt{s} = 1800$ GeV”, *Phys. Rev. D* **52** (1995) 2624, doi:10.1103/PhysRevD.52.2624.

- [38] CMS Collaboration, “Observation of the Higgs boson decay to a pair of τ leptons with the CMS detector”, *Phys. Lett. B* **779** (2018) 283, doi:10.1016/j.physletb.2018.02.004, arXiv:1708.00373.
- [39] CMS Collaboration, “Pileup mitigation at CMS in 13 TeV data”, *JINST* **15** (2020) P09018, doi:10.1088/1748-0221/15/09/P09018, arXiv:2003.00503.
- [40] CMS Collaboration, “Identification of heavy-flavour jets with the CMS detector in pp collisions at 13 TeV”, *JINST* **13** (2018) P05011, doi:10.1088/1748-0221/13/05/P05011, arXiv:1712.07158.
- [41] CMS Collaboration, “Measurement of the Higgs boson production rate in association with top quarks in final states with electrons, muons, and hadronically decaying tau leptons at $\sqrt{s} = 13$ TeV”, *Eur. Phys. J. C* **81** (2021) 378, doi:10.1140/epjc/s10052-021-09014-x, arXiv:2011.03652.
- [42] L. Bianchini, J. Conway, E. K. Friis, and C. Veelken, “Reconstruction of the Higgs mass in $H \rightarrow \tau\tau$ events by dynamical likelihood techniques”, *J. Phys. Conf. Ser.* **513** (2014) 022035, doi:10.1088/1742-6596/513/2/022035.
- [43] A. Elagin, P. Murat, A. Pranko, and A. Safonov, “A new mass reconstruction technique for resonances decaying to di-tau”, *Nucl. Instrum. Meth. A* **654** (2011) 481, doi:10.1016/j.nima.2011.07.009, arXiv:1012.4686.
- [44] CDF Collaboration, “Search for neutral MSSM Higgs bosons decaying to tau pairs in $p\bar{p}$ collisions at $\sqrt{s} = 1.96$ TeV”, *Phys. Rev. Lett.* **96** (2006) 011802, doi:10.1103/PhysRevLett.96.011802, arXiv:hep-ex/0508051.
- [45] CMS Collaboration, “Precision luminosity measurement in proton-proton collisions at $\sqrt{s} = 13$ TeV in 2015 and 2016 at CMS”, *Eur. Phys. J. C* **81** (2021) 800, doi:10.1140/epjc/s10052-021-09538-2, arXiv:2104.01927.
- [46] CMS Collaboration, “CMS luminosity measurement for the 2017 data-taking period at $\sqrt{s} = 13$ TeV”, CMS Physics Analysis Summary CMS-PAS-LUM-17-004, 2018.
- [47] CMS Collaboration, “CMS luminosity measurement for the 2018 data-taking period at $\sqrt{s} = 13$ TeV”, CMS Physics Analysis Summary CMS-PAS-LUM-18-002, 2019.
- [48] J. M. Campbell, R. K. Ellis, and C. Williams, “Vector boson pair production at the LHC”, *JHEP* **07** (2011) 018, doi:10.1007/JHEP07(2011)018, arXiv:1105.0020.
- [49] T. Gehrmann et al., “ W^+W^- production at hadron colliders in next to next to leading order QCD”, *Phys. Rev. Lett.* **113** (2014) 212001, doi:10.1103/PhysRevLett.113.212001, arXiv:1408.5243.
- [50] M. Czakon and A. Mitov, “Top++: A program for the calculation of the top-pair cross-section at hadron colliders”, *Comput. Phys. Commun.* **185** (2014) 2930, doi:10.1016/j.cpc.2014.06.021, arXiv:1112.5675.
- [51] N. Kidonakis, “Top quark production”, in *Helmholtz International Summer School on Physics of Heavy Quarks and Hadrons*, p. 139. 2014. arXiv:1311.0283. doi:10.3204/DESY-PROC-2013-03/Kidonakis.

















-
- [52] K. Melnikov and F. Petriello, “Electroweak gauge boson production at hadron colliders through $O(\alpha_s^2)$ ”, *Phys. Rev. D* **74** (2006) 114017, doi:10.1103/PhysRevD.74.114017, arXiv:hep-ph/0609070.
- [53] R. Gavin, Y. Li, F. Petriello, and S. Quackenbush, “FEWZ 2.0: A code for hadronic z production at next-to-next-to-leading order”, *Computer Physics Communications* **182** (2011) 2388, doi:10.1016/j.cpc.2011.06.008.
- [54] CMS Collaboration, “Measurement of the cross section for top quark pair production in association with a W or Z boson in proton-proton collisions at $\sqrt{s} = 13$ TeV”, *JHEP* **08** (2018) 011, doi:10.1007/JHEP08(2018)011, arXiv:1711.02547.
- [55] CMS Collaboration, “Differential cross section measurements for the production of top quark pairs and of additional jets using dilepton events from pp collisions at $\sqrt{s} = 13$ TeV”, 2024. arXiv:2402.08486. Submitted to the *JHEP*.
- [56] R. J. Barlow and C. Beeston, “Fitting using finite Monte Carlo samples”, *Comput. Phys. Commun.* **77** (1993) 219, doi:10.1016/0010-4655(93)90005-w.
- [57] J. S. Conway, “Incorporating nuisance parameters in likelihoods for multisource spectra”, in *PHYSTAT 2011*, p. 115. 2011. arXiv:1103.0354. doi:10.5170/CERN-2011-006.115.
- [58] CMS Collaboration, “The CMS statistical analysis and combination tool: COMBINE”, 2024. arXiv:2404.06614. Accepted by *Comput. Softw. Big Sci*.
- [59] T. Junk, “Confidence level computation for combining searches with small statistics”, *Nucl. Instrum. Meth. A* **434** (1999) 435, doi:10.1016/S0168-9002(99)00498-2, arXiv:hep-ex/9902006.
- [60] A. L. Read, “Presentation of search results: The CL_s technique”, *J. Phys. G* **28** (2002) 2693, doi:10.1088/0954-3899/28/10/313.
- [61] The ATLAS Collaboration, The CMS Collaboration, The LHC Higgs Combination Group, “Procedure for the LHC Higgs boson search combination in Summer 2011”, Technical Report CMS-NOTE-2011-005, ATL-PHYS-PUB-2011-11, 2011.
- [62] G. Cowan, K. Cranmer, E. Gross, and O. Vitells, “Asymptotic formulae for likelihood-based tests of new physics”, *Eur. Phys. J. C* **71** (2011) 1554, doi:10.1140/epjc/s10052-011-1554-0, arXiv:1007.1727. [Erratum: doi:10.1140/epjc/s10052-013-2501-z].
- [63] CMS Collaboration, “Measurements of Higgs boson production in the decay channel with a pair of τ leptons in proton-proton collisions at $\sqrt{s} = 13$ TeV”, *Eur. Phys. J. C* **83** (2023) 562, doi:10.1140/epjc/s10052-023-11452-8, arXiv:2204.12957.

A The CMS Collaboration

Yerevan Physics Institute, Yerevan, Armenia

A. Hayrapetyan, A. Tumasyan¹ 













Institut für Hochenergiephysik, Vienna, Austria

W. Adam , J.W. Andrejkovic, T. Bergauer , S. Chatterjee , K. Damanakis , M. Dragicevic , P.S. Hussain , M. Jeitler² , N. Krammer , A. Li , D. Liko , I. Mikulec , J. Schieck² , R. Schöfbeck , D. Schwarz , M. Sonawane , W. Waltenberger , C.-E. Wulz² 

















Universiteit Antwerpen, Antwerpen, Belgium

T. Janssen , T. Van Laer, P. Van Mechelen 













Vrije Universiteit Brussel, Brussel, Belgium

N. Breugelmans, J. D'Hondt , S. Dansana , A. De Moor , M. Delcourt , F. Heyen, S. Lowette , I. Makarenko , D. Müller , S. Tavernier , M. Tytgat³ , G.P. Van Onsem , S. Van Putte , D. Vannerom 















Université Libre de Bruxelles, Bruxelles, Belgium

B. Bilin , B. Clerbaux , A.K. Das, G. De Lentdecker , H. Evard , L. Favart , P. Gianneios , J. Jaramillo , A. Khalilzadeh, F.A. Khan , K. Lee , M. Mahdavihorrani , A. Malara , S. Paredes , M.A. Shahzad, L. Thomas , M. Vanden Bemden , C. Vander Velde , P. Vanlaer 











Ghent University, Ghent, Belgium

M. De Coen , D. Dobur , G. Gokbulut , Y. Hong , J. Knolle , L. Lambrecht , D. Marckx , K. Mota Amarilo , K. Skovpen , N. Van Den Bossche , J. van der Linden , L. Wezenbeek 

















Université Catholique de Louvain, Louvain-la-Neuve, Belgium

A. Benecke , A. Bethani , G. Bruno , C. Caputo , J. De Favereau De Jeneret , C. Delaere , I.S. Donertas , A. Giammanco , A.O. Guzel , Sa. Jain , V. Lemaitre, J. Lidrych , P. Mastrapasqua , T.T. Tran , S. Wertz 









Centro Brasileiro de Pesquisas Fisicas, Rio de Janeiro, Brazil

G.A. Alves , M. Alves Gallo Pereira , E. Coelho , G. Correia Silva , C. Hensel , T. Menezes De Oliveira , C. Mora Herrera⁴ , A. Moraes , P. Rebello Teles , M. Soeiro, A. Vilela Pereira⁴ 

Universidade do Estado do Rio de Janeiro, Rio de Janeiro, Brazil

W.L. Aldá Júnior , M. Barroso Ferreira Filho , H. Brandao Malbouisson , W. Carvalho , J. Chinellato⁵, E.M. Da Costa , G.G. Da Silveira⁶ , D. De Jesus Damiao , S. Fonseca De Souza , R. Gomes De Souza, T. Laux Kuhn, M. Macedo , J. Martins⁷ , L. Mundim , H. Nogima , J.P. Pinheiro , A. Santoro , A. Sznajder , M. Thiel 

Universidade Estadual Paulista, Universidade Federal do ABC, São Paulo, Brazil

C.A. Bernardes⁶ , L. Calligaris , T.R. Fernandez Perez Tomei , E.M. Gregores , I. Maitto Silverio , P.G. Mercadante , S.F. Novaes , B. Orzari , Sandra S. Padula 



Institute for Nuclear Research and Nuclear Energy, Bulgarian Academy of Sciences, Sofia, Bulgaria

A. Aleksandrov , G. Antchev , R. Hadjiiska , P. Iaydjiev , M. Misheva , M. Shopova , G. Sultanov 



University of Sofia, Sofia, Bulgaria

A. Dimitrov , L. Litov , B. Pavlov , P. Petkov , A. Petrov , E. Shumka 



Instituto De Alta Investigación, Universidad de Tarapacá, Casilla 7 D, Arica, Chile

S. Keshri , D. Laroze , S. Thakur 













Beihang University, Beijing, China

T. Cheng , T. Javaid , L. Yuan 

Department of Physics, Tsinghua University, Beijing, China

Z. Hu , Z. Liang, J. Liu, K. Yi^{8,9} 

Institute of High Energy Physics, Beijing, China

G.M. Chen¹⁰ , H.S. Chen¹⁰ , M. Chen¹⁰ , F. Iemmi , C.H. Jiang, A. Kapoor¹¹ , H. Liao , Z.-A. Liu¹² , R. Sharma¹³ , J.N. Song¹², J. Tao , C. Wang¹⁰, J. Wang , Z. Wang¹⁰, H. Zhang , J. Zhao 

State Key Laboratory of Nuclear Physics and Technology, Peking University, Beijing, China

A. Agapitos , Y. Ban , S. Deng , B. Guo, C. Jiang , A. Levin , C. Li , Q. Li , Y. Mao, S. Qian, S.J. Qian , X. Qin, X. Sun , D. Wang , H. Yang, L. Zhang , Y. Zhao, C. Zhou 

Guangdong Provincial Key Laboratory of Nuclear Science and Guangdong-Hong Kong Joint Laboratory of Quantum Matter, South China Normal University, Guangzhou, China

S. Yang 

Sun Yat-Sen University, Guangzhou, China

Z. You 

University of Science and Technology of China, Hefei, China

K. Jaffel , N. Lu 

Nanjing Normal University, Nanjing, China

G. Bauer¹⁴, B. Li, J. Zhang 

Institute of Modern Physics and Key Laboratory of Nuclear Physics and Ion-beam Application (MOE) - Fudan University, Shanghai, China

X. Gao¹⁵ , Y. Li

Zhejiang University, Hangzhou, Zhejiang, China

Z. Lin , C. Lu , M. Xiao 

Universidad de Los Andes, Bogota, Colombia

C. Avila , D.A. Barbosa Trujillo, A. Cabrera , C. Florez , J. Fraga , J.A. Reyes Vega

Universidad de Antioquia, Medellin, Colombia

F. Ramirez , C. Rendón, M. Rodriguez , A.A. Ruales Barbosa , J.D. Ruiz Alvarez 

University of Split, Faculty of Electrical Engineering, Mechanical Engineering and Naval Architecture, Split, Croatia

D. Giljanovic , N. Godinovic , D. Lelas , A. Sculac 

University of Split, Faculty of Science, Split, Croatia

M. Kovac , A. Petkovic, T. Sculac 



Institute Rudjer Boskovic, Zagreb, Croatia

P. Bargassa , V. Brigljevic , B.K. Chitroda , D. Ferencek , K. Jakovcic, A. Starodumov¹⁶ , T. Susa 

University of Cyprus, Nicosia, Cyprus

A. Attikis , K. Christoforou , A. Hadjiagapiou, C. Leonidou , J. Mousa , C. Nicolaou, L. Paizanos, F. Ptochos , P.A. Razis , H. Rykaczewski, H. Saka , A. Stepennov 



Charles University, Prague, Czech Republic

M. Finger , M. Finger Jr. , A. Kveton 



Universidad San Francisco de Quito, Quito, Ecuador

E. Carrera Jarrin 









Academy of Scientific Research and Technology of the Arab Republic of Egypt, Egyptian Network of High Energy Physics, Cairo, Egypt

B. El-mahdy, S. Khalil¹⁷ , E. Salama^{18,19} 

Center for High Energy Physics (CHEP-FU), Fayoum University, El-Fayoum, Egypt

A. Lotfy , M.A. Mahmoud 















National Institute of Chemical Physics and Biophysics, Tallinn, Estonia

K. Ehataht , M. Kadastik, T. Lange , S. Nandan , C. Nielsen , J. Pata , M. Raidal , L. Tani , C. Veelken 

Department of Physics, University of Helsinki, Helsinki, Finland

H. Kirschenmann , K. Osterberg , M. Voutilainen 



















Helsinki Institute of Physics, Helsinki, Finland

S. Bharthuar , N. Bin Norjoharuddeen , E. Brücken , F. Garcia , P. Inkaew , K.T.S. Kallonen , T. Lampén , K. Lassila-Perini , S. Lehti , T. Lindén , L. Martikainen , M. Myllymäki , M.m. Rantanen , H. Siikonen , J. Tuominiemi 



























Lappeenranta-Lahti University of Technology, Lappeenranta, Finland

P. Luukka , H. Petrow 

















IRFU, CEA, Université Paris-Saclay, Gif-sur-Yvette, France

M. Besancon , F. Couderc , M. Dejardin , D. Denegri, J.L. Faure, F. Ferri , S. Ganjour , P. Gras , G. Hamel de Monchenault , M. Kumar , V. Lohezic , J. Malcles , F. Orlandi , L. Portales , A. Rosowsky , M.Ö. Sahin , A. Savoy-Navarro²⁰ , P. Simkina , M. Titov , M. Tornago 

Laboratoire Leprince-Ringuet, CNRS/IN2P3, Ecole Polytechnique, Institut Polytechnique de Paris, Palaiseau, France

F. Beaudette , G. Boldrini , P. Busson , A. Cappati , C. Charlot , M. Chiusi , F. Damas , O. Davignon , A. De Wit , I.T. Ehle , B.A. Fontana Santos Alves , S. Ghosh , A. Gilbert , R. Granier de Cassagnac , A. Hakimi , B. Harikrishnan , L. Kalipoliti , G. Liu , M. Nguyen , C. Ochando , R. Salerno , J.B. Sauvan , Y. Sirois , L. Urda Gómez , E. Vernazza , A. Zabi , A. Zghiche 

















Université de Strasbourg, CNRS, IPHC UMR 7178, Strasbourg, France

J.-L. Agram²¹ , J. Andrea , D. Apparú , D. Bloch , J.-M. Brom , E.C. Chabert , C. Collard , S. Falke , U. Goerlach , R. Haeberle , A.-C. Le Bihan , M. Meena , O. Poncet , G. Saha , M.A. Sessini , P. Van Hove , P. Vaucelle 



Centre de Calcul de l'Institut National de Physique Nucleaire et de Physique des Particules, CNRS/IN2P3, Villeurbanne, France

A. Di Florio 

Institut de Physique des 2 Infinis de Lyon (IP2I), Villeurbanne, France

D. Amram, S. Beauceron , B. Blancon , G. Boudoul , N. Chanon , D. Contardo , P. Depasse , C. Dozen²² , H. El Mamouni, J. Fay , S. Gascon , M. Gouzevitch , C. Greenberg, G. Grenier , B. Ille , E. Jourd’huy, I.B. Laktineh, M. Lethuillier , L. Mirabito, S. Perries, A. Purohit , M. Vander Donckt , P. Verdier , J. Xiao 





























Georgian Technical University, Tbilisi, Georgia

A. Khvedelidze¹⁶ , I. Lomidze , Z. Tsamalaidze¹⁶ 









RWTH Aachen University, I. Physikalisches Institut, Aachen, Germany

V. Botta , S. Consuegra Rodríguez , L. Feld , K. Klein , M. Lipinski , D. Meuser , A. Pauls , D. Pérez Adán , N. Röwert , M. Teroerde 





RWTH Aachen University, III. Physikalisches Institut A, Aachen, Germany

S. Diekmann , A. Dodonova , N. Eich , D. Eliseev , F. Engelke , J. Erdmann , M. Erdmann , P. Fackeldey , B. Fischer , T. Hebbeker , K. Hoepfner , F. Ivone , A. Jung , M.y. Lee , F. Mausolf , M. Merschmeyer , A. Meyer , S. Mukherjee , D. Noll , F. Nowotny, A. Pozdnyakov , Y. Rath, W. Redjeb , F. Rehm, H. Reithler , V. Sarkisovi , A. Schmidt , C. Seth, A. Sharma , J.L. Spah , A. Stein , F. Torres Da Silva De Araujo²³ , S. Wiedenbeck , S. Zaleski







































RWTH Aachen University, III. Physikalisches Institut B, Aachen, Germany

C. Dziwok , G. Flügge , T. Kress , A. Nowack , O. Pooth , A. Stahl , T. Ziemons , A. Zotz 









Deutsches Elektronen-Synchrotron, Hamburg, Germany



























H. Aarup Petersen , M. Aldaya Martin , J. Alimena , S. Amoroso, Y. An , J. Bach , S. Baxter , M. Bayatmakou , H. Becerril Gonzalez , O. Behnke , A. Belvedere , F. Blekman²⁴ , K. Borras²⁵ , A. Campbell , A. Cardini , C. Cheng, F. Colombina , G. Eckerlin, D. Eckstein , L.I. Estevez Banos , O. Filatov , E. Gallo²⁴ , A. Geiser , V. Guglielmi , M. Guthoff , A. Hinzmann , L. Jeppe , B. Kaech , M. Kasemann , C. Kleinwort , R. Kogler , M. Komm , D. Krücker , W. Lange, D. Leyva Pernia , K. Lipka²⁶ , W. Lohmann²⁷ , F. Lorkowski , R. Mankel , I.-A. Melzer-Pellmann , M. Mendizabal Morentin , A.B. Meyer , G. Milella , K. Moral Figueroa , A. Mussgiller , L.P. Nair , J. Niedziela , A. Nürnberg , Y. Otari, J. Park , E. Ranken , A. Raspereza , D. Rastorguev , J. Rübenach, L. Rygaard, A. Saggio , M. Scham^{28,25} , S. Schnake²⁵ , P. Schütze , C. Schwanenberger²⁴ , D. Selivanova , K. Sharko , M. Shchedrolosiev , D. Stafford, P. Stelldinger²⁹ , F. Vazzoler , A. Ventura Barroso , R. Walsh , D. Wang , Q. Wang , Y. Wen , K. Wichmann, L. Wiens²⁵ , C. Wissing , Y. Yang , A. Zimmermann Castro Santos 

University of Hamburg, Hamburg, Germany

A. Albrecht , S. Albrecht , M. Antonello , S. Bein , L. Benato , S. Bollweg, M. Bonanomi , P. Connor , K. El Morabit , Y. Fischer , E. Garutti , A. Grohsjean , J. Haller , H.R. Jabusch , G. Kasieczka , P. Keicher, R. Klanner , W. Korcari , T. Kramer , C.c. Kuo, V. Kutzner , F. Labe , J. Lange , A. Lobanov , C. Matthies , L. Moureaux , M. Mrowietz, A. Nigamova , Y. Nissan, A. Paasch , K.J. Pena Rodriguez , T. Quadfasel , B. Raciti , M. Rieger , D. Savoie , J. Schindler , P. Schleper , M. Schröder , J. Schwandt , M. Sommerhalder , H. Stadie , G. Steinbrück , A. Tews, M. Wolf 

Karlsruher Institut fuer Technologie, Karlsruhe, Germany

S. Brommer , M. Burkart, E. Butz , T. Chwalek , A. Dierlamm , A. Droll, U. Elicabuk, N. Faltermann , M. Giffels , A. Gottmann , F. Hartmann³⁰ , R. Hofsaess 

M. Horzela , U. Husemann , J. Kieseler , M. Klute , R. Koppenhöfer , J.M. Lawhorn , M. Link, A. Lintuluoto , S. Maier , S. Mitra , M. Mormile , Th. Müller , M. Neukum, M. Oh , E. Pfeffer , M. Presilla , G. Quast , K. Rabbertz , B. Regnery , N. Shadskiy , I. Shvetsov , H.J. Simonis , L. Sowa, L. Stockmeier, K. Tauqeer, M. Toms , N. Trevisani , R.F. Von Cube , M. Wassmer , S. Wieland , F. Wittig, R. Wolf , X. Zuo 

Institute of Nuclear and Particle Physics (INPP), NCSR Demokritos, Aghia Paraskevi, Greece

G. Anagnostou, G. Daskalakis , A. Kyriakis, A. Papadopoulos³⁰, A. Stakia 

National and Kapodistrian University of Athens, Athens, Greece

P. Kontaxakis , G. Melachroinos, Z. Painesis , I. Papavergou , I. Paraskevas , N. Saoulidou , K. Theofilatos , E. Tziaferi , K. Vellidis , I. Zisopoulos 





National Technical University of Athens, Athens, Greece

G. Bakas , T. Chatzistavrou, G. Karapostoli , K. Kousouris , I. Papakrivopoulos , E. Siamarkou, G. Tsipolitis , A. Zacharopoulou

University of Ioánnina, Ioánnina, Greece

K. Adamidis, I. Bestintzanos, I. Evangelou , C. Foudas, C. Kamtsikis, P. Katsoulis, P. Kokkas , P.G. Kosmoglou Kioseoglou , N. Manthos , I. Papadopoulos , J. Strologas 

HUN-REN Wigner Research Centre for Physics, Budapest, Hungary

C. Hajdu , D. Horvath^{31,32} , K. Márton, A.J. Rádl³³ , F. Sikler , V. Veszpremi 

MTA-ELTE Lendület CMS Particle and Nuclear Physics Group, Eötvös Loránd University, Budapest, Hungary

M. Csanád , K. Farkas , A. Fehérkuti³⁴ , M.M.A. Gadallah³⁵ , Á. Kadlecik , P. Major , G. Pásztor , G.I. Veres 

Faculty of Informatics, University of Debrecen, Debrecen, Hungary

B. Ujvari , G. Zilizi 













Institute of Nuclear Research ATOMKI, Debrecen, Hungary

G. Bencze, S. Czellar, J. Molnar, Z. Szillasi

Karoly Robert Campus, MATE Institute of Technology, Gyongyos, Hungary

F. Nemes³⁴ , T. Novak 

Panjab University, Chandigarh, India

S. Bansal , S.B. Beri, V. Bhatnagar , G. Chaudhary , S. Chauhan , N. Dhingra³⁶ , A. Kaur , A. Kaur , H. Kaur , M. Kaur , S. Kumar , K. Sandeep , T. Sheokand, J.B. Singh , A. Singla 

















University of Delhi, Delhi, India

A. Ahmed , A. Bhardwaj , A. Chhetri , B.C. Choudhary , A. Kumar , A. Kumar , M. Naimuddin , K. Ranjan , M.K. Saini, S. Saumya 

Saha Institute of Nuclear Physics, HBNI, Kolkata, India

S. Baradia , S. Barman³⁷ , S. Bhattacharya , S. Das Gupta, S. Dutta , S. Dutta, S. Sarkar

Indian Institute of Technology Madras, Madras, India

M.M. Ameen , P.K. Behera , S.C. Behera , S. Chatterjee , G. Dash , P. Jana , P. Kalbhor , S. Kamble , J.R. Komaragiri³⁸ , D. Kumar³⁸ , T. Mishra , B. Parida , P.R. Pujahari , N.R. Saha , A. Sharma , A.K. Sikdar , R.K. Singh, P. Verma, S. Verma , A. Vijay











Tata Institute of Fundamental Research-A, Mumbai, India

S. Dugad, G.B. Mohanty , M. Shelake, P. Suryadevara









Tata Institute of Fundamental Research-B, Mumbai, India

A. Bala , S. Banerjee , R.M. Chatterjee, M. Guchait , Sh. Jain , A. Jaiswal, S. Kumar , G. Majumder , K. Mazumdar , S. Parolia , A. Thachayath 



National Institute of Science Education and Research, An OCC of Homi Bhabha National Institute, Bhubaneswar, Odisha, India

S. Bahinipati³⁹ , C. Kar , D. Maity⁴⁰ , P. Mal , V.K. Muraleedharan Nair Bindhu⁴⁰ , K. Naskar⁴⁰ , A. Nayak⁴⁰ , S. Nayak, K. Pal, P. Sadangi, S.K. Swain , S. Varghese⁴⁰ , D. Vats⁴⁰ 







Indian Institute of Science Education and Research (IISER), Pune, India

S. Acharya⁴¹ , A. Alpana , S. Dube , B. Gomber⁴¹ , P. Hazarika , B. Kansal , A. Laha , B. Sahu⁴¹ , S. Sharma , K.Y. Vaish 

Isfahan University of Technology, Isfahan, Iran

H. Bakhshiansohi⁴² , A. Jafari⁴³ , M. Zeinali⁴⁴ 































Institute for Research in Fundamental Sciences (IPM), Tehran, Iran

S. Bashiri, S. Chenarani⁴⁵ , S.M. Etesami , Y. Hosseini , M. Khakzad , E. Khazaie⁴⁶ , M. Mohammadi Najafabadi , S. Tizchang⁴⁷ 





























University College Dublin, Dublin, Ireland

M. Felcini , M. Grunewald 





INFN Sezione di Bari^a, Università di Bari^b, Politecnico di Bari^c, Bari, Italy

M. Abbrescia^{a,b} , A. Colaleo^{a,b} , D. Creanza^{a,c} , B. D'Anzi^{a,b} , N. De Filippis^{a,c} , M. De Palma^{a,b} , W. Elmetenawee^{a,b,48} , L. Fiore^a , G. Iaselli^{a,c} , L. Longo^a , M. Louka^{a,b}, G. Maggi^{a,c} , M. Maggi^a , I. Margjeka^a , V. Mastrapasqua^{a,b} , S. My^{a,b} , S. Nuzzo^{a,b} , A. Pellecchia^{a,b} , A. Pompili^{a,b} , G. Pugliese^{a,c} , R. Radogna^{a,b} , D. Ramos^a , A. Ranieri^a , L. Silvestris^a , F.M. Simone^{a,c} , Ü. Sözbilir^a , A. Stamerra^{a,b} , D. Troiano^{a,b} , R. Venditti^{a,b} , P. Verwilligen^a , A. Zaza^{a,b} 

















INFN Sezione di Bologna^a, Università di Bologna^b, Bologna, Italy

G. Abbiendi^a , C. Battilana^{a,b} , D. Bonacorsi^{a,b} , P. Capiluppi^{a,b} , A. Castro^{+a,b} , F.R. Cavallo^a , M. Cuffiani^{a,b} , G.M. Dallavalle^a , T. Diotallevi^{a,b} , F. Fabbri^a , A. Fanfani^{a,b} , D. Fasanella^a , P. Giacomelli^a , L. Giommi^{a,b} , C. Grandi^a , L. Guiducci^{a,b} , S. Lo Meo^{a,49} , M. Lorusso^{a,b} , L. Lunerti^a , S. Marcellini^a , G. Masetti^a , F.L. Navarra^{a,b} , G. Paggi^{a,b} , A. Perrotta^a , F. Primavera^{a,b} , A.M. Rossi^{a,b} , S. Rossi Tisbeni^{a,b} , T. Rovelli^{a,b} , G.P. Siroli^{a,b} 

INFN Sezione di Catania^a, Università di Catania^b, Catania, Italy





















































S. Costa^{a,b,50} , A. Di Mattia^a , A. Lapertosa^a , R. Potenza^{a,b}, A. Tricomi^{a,b,50} , C. Tuve^{a,b} 





























INFN Sezione di Firenze^a, Università di Firenze^b, Firenze, Italy

P. Assiouras^a , G. Barbagli^a , G. Bardelli^{a,b} , B. Camaiani^{a,b} , A. Cassese^a , R. Ceccarelli^a , V. Ciulli^{a,b} , C. Civinini^a , R. D'Alessandro^{a,b} , E. Focardi^{a,b} , T. Kello^a, G. Latino^{a,b} , P. Lenzi^{a,b} , M. Lizzo^a , M. Meschini^a , S. Paoletti^a , A. Papanastassiou^{a,b}, G. Sguazzoni^a , L. Viliani^a 







INFN Laboratori Nazionali di Frascati, Frascati, Italy

L. Benussi , S. Bianco , S. Meola⁵¹ , D. Piccolo 

INFN Sezione di Genova^a, Università di Genova^b, Genova, ItalyP. Chatagnon^a , F. Ferro^a , E. Robutti^a , S. Tosi^{a,b} **INFN Sezione di Milano-Bicocca^a, Università di Milano-Bicocca^b, Milano, Italy**A. Benaglia^a , F. Brivio^a , F. Cetorelli^{a,b} , F. De Guio^{a,b} , M.E. Dinardo^{a,b} , P. Dini^a , S. Gennai^a , R. Gerosa^{a,b} , A. Ghezzi^{a,b} , P. Govoni^{a,b} , L. Guzzi^a , M.T. Lucchini^{a,b} , M. Malberti^a , S. Malvezzi^a , A. Massironi^a , D. Menasce^a , L. Moroni^a , M. Paganoni^{a,b} , S. Palluotto^{a,b} , D. Pedrini^a , A. Perego^{a,b} , B.S. Pinolini^a, G. Pizzati^{a,b}, S. Ragazzi^{a,b} , T. Tabarelli de Fatis^{a,b} **INFN Sezione di Napoli^a, Università di Napoli 'Federico II'^b, Napoli, Italy; Università della Basilicata^c, Potenza, Italy; Scuola Superiore Meridionale (SSM)^d, Napoli, Italy**S. Buontempo^a , A. Cagnotta^{a,b} , F. Carnevali^{a,b}, N. Cavallo^{a,c} , F. Fabozzi^{a,c} , A.O.M. Iorio^{a,b} , L. Lista^{a,b,52} , P. Paolucci^{a,30} , B. Rossi^a **INFN Sezione di Padova^a, Università di Padova^b, Padova, Italy; Università di Trento^c, Trento, Italy**R. Ardino^a , P. Azzi^a , N. Bacchetta^{a,53} , P. Bortignon^a , G. Bortolato^{a,b}, A. Bragagnolo^{a,b} , A.C.M. Bulla^a , R. Carlin^{a,b} , P. Checchia^a , T. Dorigo^a , F. Fanzago^a , U. Gasparini^{a,b} , S. Giorgetti^a, F. Gonella^a , E. Lusiani^a , M. Margoni^{a,b} , A.T. Meneguzzo^{a,b} , M. Migliorini^{a,b} , J. Pazzini^{a,b} , P. Ronchese^{a,b} , R. Rossin^{a,b} , F. Simonetto^{a,b} , M. Tosi^{a,b} , A. Triossi^{a,b} , S. Ventura^a , M. Zanetti^{a,b} , P. Zotto^{a,b} , A. Zucchetta^{a,b} , G. Zumerle^{a,b} **INFN Sezione di Pavia^a, Università di Pavia^b, Pavia, Italy**C. Aimè^a , A. Braghieri^a , S. Calzaferri^a , D. Fiorina^a , P. Montagna^{a,b} , V. Re^a , C. Riccardi^{a,b} , P. Salvini^a , I. Vai^{a,b} , P. Vitulo^{a,b} **INFN Sezione di Perugia^a, Università di Perugia^b, Perugia, Italy**S. Ajmal^{a,b} , M.E. Ascioti^{a,b}, G.M. Bilei^a , C. Carrivale^{a,b}, D. Ciangottini^{a,b} , L. Fanò^{a,b} , M. Magherini^{a,b} , V. Mariani^{a,b} , M. Menichelli^a , F. Moscatelli^{a,54} , A. Rossi^{a,b} , A. Santocchia^{a,b} , D. Spiga^a , T. Tedeschi^{a,b} **INFN Sezione di Pisa^a, Università di Pisa^b, Scuola Normale Superiore di Pisa^c, Pisa, Italy; Università di Siena^d, Siena, Italy**C.A. Alexe^{a,c} , P. Asenov^{a,b} , P. Azzurri^a , G. Bagliesi^a , R. Bhattacharya^a , L. Bianchini^{a,b} , T. Boccali^a , E. Bossini^a , D. Bruschini^{a,c} , R. Castaldi^a , M.A. Ciocci^{a,b} , M. Cipriani^{a,b} , V. D'Amante^{a,d} , R. Dell'Orso^a , S. Donato^a , A. Giassi^a , F. Ligabue^{a,c} , A.C. Marini^a , D. Matos Figueiredo^a , A. Messineo^{a,b} , S. Mishra^a , M. Musich^{a,b} , F. Palla^a , A. Rizzi^{a,b} , G. Rolandi^{a,c} , S. Roy Chowdhury^a , T. Sarkar^a , A. Scribano^a , P. Spagnolo^a , R. Tenchini^a , G. Tonelli^{a,b} , N. Turini^{a,d} , F. Vaselli^{a,c} , A. Venturi^a , P.G. Verdini^a **INFN Sezione di Roma^a, Sapienza Università di Roma^b, Roma, Italy**C. Baldenegro Barrera^{a,b} , P. Barria^a , C. Basile^{a,b} , F. Cavallari^a , L. Cunqueiro Mendez^{a,b} , D. Del Re^{a,b} , E. Di Marco^{a,b} , M. Diemoz^a , F. Errico^{a,b} , E. Longo^{a,b} , J. Mijuskovic^{a,b} , G. Organtini^{a,b} , F. Pandolfi^a , R. Paramatti^{a,b} , C. Quaranta^{a,b} , S. Rahatlou^{a,b} , C. Rovelli^a , F. Santanastasio^{a,b} , L. Soffi^a **INFN Sezione di Torino^a, Università di Torino^b, Torino, Italy; Università del Piemonte Orientale^c, Novara, Italy**N. Amapane^{a,b} , R. Arcidiacono^{a,c} , S. Argiro^{a,b} , M. Arneodo^{a,c} , N. Bartosik^a , R. Bellan^{a,b} , A. Bellora^{a,b} , C. Biino^a , C. Borca^{a,b} , N. Cartiglia^a , M. Costa^{a,b}

R. Covarelli^{a,b} , N. Demaria^a , L. Finco^a , M. Grippo^{a,b} , B. Kiani^{a,b} , F. Legger^a , F. Luongo^{a,b} , C. Mariotti^a , L. Markovic^{a,b} , S. Maselli^a , A. Mecca^{a,b} , L. Menzio^{a,b}, P. Meridiani^a , E. Migliore^{a,b} , M. Monteno^a , R. Mulargia^a , M.M. Obertino^{a,b} , G. Ortona^a , L. Pacher^{a,b} , N. Pastrone^a , M. Pelliccioni^a , M. Ruspa^{a,c} , F. Siviero^{a,b} , V. Sola^{a,b} , A. Solano^{a,b} , A. Staiano^a , C. Tarricone^{a,b} , D. Trocino^a , G. Umoret^{a,b} , R. White^{a,b} 

INFN Sezione di Trieste^a, Università di Trieste^b, Trieste, Italy

J. Babbar^{a,b} , S. Belforte^a , V. Candelise^{a,b} , M. Casarsa^a , F. Cossutti^a , K. De Leo^a , G. Della Ricca^{a,b} 





Kyungpook National University, Daegu, Korea

S. Dogra , J. Hong , B. Kim , J. Kim, D. Lee, H. Lee, S.W. Lee , C.S. Moon , Y.D. Oh , M.S. Ryu , S. Sekmen , B. Tae, Y.C. Yang 

Department of Mathematics and Physics - GWNNU, Gangneung, Korea

M.S. Kim 

Chonnam National University, Institute for Universe and Elementary Particles, Kwangju, Korea

G. Bak , P. Gwak , H. Kim , D.H. Moon 

Hanyang University, Seoul, Korea

E. Asilar , J. Choi , D. Kim , T.J. Kim , J.A. Merlin, Y. Ryou

Korea University, Seoul, Korea

S. Choi , S. Han, B. Hong , K. Lee, K.S. Lee , S. Lee , J. Yoo 













Kyung Hee University, Department of Physics, Seoul, Korea

J. Goh , S. Yang 







Sejong University, Seoul, Korea

H. S. Kim , Y. Kim, S. Lee



Seoul National University, Seoul, Korea

J. Almond, J.H. Bhyun, J. Choi , J. Choi, W. Jun , J. Kim , Y.W. Kim, S. Ko , H. Kwon , H. Lee , J. Lee , J. Lee , B.H. Oh , S.B. Oh , H. Seo , U.K. Yang, I. Yoon 

University of Seoul, Seoul, Korea

W. Jang , D.Y. Kang, Y. Kang , S. Kim , B. Ko, J.S.H. Lee , Y. Lee , I.C. Park , Y. Roh, I.J. Watson 

Yonsei University, Department of Physics, Seoul, Korea

S. Ha , H.D. Yoo 

Sungkyunkwan University, Suwon, Korea

M. Choi , M.R. Kim , H. Lee, Y. Lee , I. Yu 





College of Engineering and Technology, American University of the Middle East (AUM), Dasman, Kuwait

T. Beyrouthy, Y. Gharbia

Kuwait University - College of Science - Department of Physics, Safat, Kuwait

F. Alazemi 

Riga Technical University, Riga, Latvia

K. Dreimanis , A. Gaile , C. Munoz Diaz, D. Osite , G. Pikurs, A. Potrebko , M. Seidel 

D. Sidiropoulos Kontos

University of Latvia (LU), Riga, Latvia

N.R. Strautnieks 







Vilnius University, Vilnius, Lithuania

M. Ambrozas , A. Juodagalvis , A. Rinkevicius , G. Tamulaitis 

National Centre for Particle Physics, Universiti Malaya, Kuala Lumpur, Malaysia

I. Yusuff⁵⁵ , Z. Zolkapli



Universidad de Sonora (UNISON), Hermosillo, Mexico

J.F. Benitez , A. Castaneda Hernandez , H.A. Encinas Acosta, L.G. Gallegos Maríñez, M. León Coello , J.A. Murillo Quijada , A. Sehrawat , L. Valencia Palomo 





Centro de Investigacion y de Estudios Avanzados del IPN, Mexico City, Mexico

G. Ayala , H. Castilla-Valdez , H. Crotte Ledesma, E. De La Cruz-Burelo , I. Heredia-De La Cruz⁵⁶ , R. Lopez-Fernandez , J. Mejia Guisao , C.A. Mondragon Herrera, A. Sánchez Hernández 

Universidad Iberoamericana, Mexico City, Mexico

C. Oropeza Barrera , D.L. Ramirez Guadarrama, M. Ramírez García 

Benemerita Universidad Autonoma de Puebla, Puebla, Mexico

I. Bautista , I. Pedraza , H.A. Salazar Ibarquen , C. Uribe Estrada 

University of Montenegro, Podgorica, Montenegro

I. Bubanja , N. Raicevic 

University of Canterbury, Christchurch, New Zealand

P.H. Butler 

National Centre for Physics, Quaid-I-Azam University, Islamabad, Pakistan

A. Ahmad , M.I. Asghar, A. Awais , M.I.M. Awan, H.R. Hoorani , W.A. Khan 







AGH University of Krakow, Faculty of Computer Science, Electronics and Telecommunications, Krakow, Poland

V. Avati, L. Grzanka , M. Malawski 

National Centre for Nuclear Research, Swierk, Poland

H. Bialkowska , M. Bluj , M. Górski , M. Kazana , M. Szleper , P. Zalewski 

















Institute of Experimental Physics, Faculty of Physics, University of Warsaw, Warsaw, Poland

K. Bunkowski , K. Doroba , A. Kalinowski , M. Konecki , J. Krolikowski , A. Muhammad 



Warsaw University of Technology, Warsaw, Poland

K. Pozniak , W. Zabolotny 

Laboratório de Instrumentação e Física Experimental de Partículas, Lisboa, Portugal

M. Araujo , D. Bastos , C. Beirão Da Cruz E Silva , A. Boletti , M. Bozzo , T. Camporesi , G. Da Molin , P. Faccioli , M. Gallinaro , J. Hollar , N. Leonardo , G.B. Marozzo, T. Niknejad , A. Petrilli , M. Pisano , J. Seixas , J. Varela , J.W. Wulff































Faculty of Physics, University of Belgrade, Belgrade, Serbia

P. Adzic , P. Milenovic 

VINCA Institute of Nuclear Sciences, University of Belgrade, Belgrade, Serbia

D. Devetak, M. Dordevic , J. Milosevic , V. Rekovic















Centro de Investigaciones Energéticas Medioambientales y Tecnológicas (CIEMAT), Madrid, Spain

J. Alcaraz Maestre , Cristina F. Bedoya , J.A. Brochero Cifuentes , Oliver M. Carretero , M. Cepeda , M. Cerrada , N. Colino , B. De La Cruz , A. Delgado Peris , A. Escalante Del Valle , D. Fernández Del Val , J.P. Fernández Ramos , J. Flix , M.C. Fouz , O. Gonzalez Lopez , S. Goy Lopez , J.M. Hernandez , M.I. Josa , J. Llorente Merino , E. Martin Viscasillas , D. Moran , C. M. Morcillo Perez , Á. Navarro Tobar , C. Perez Dengra , A. Pérez-Calero Yzquierdo , J. Puerta Pelayo , I. Redondo , S. Sánchez Navas , J. Sastre , J. Vazquez Escobar 



















Universidad Autónoma de Madrid, Madrid, Spain

J.F. de Trocóniz 



Universidad de Oviedo, Instituto Universitario de Ciencias y Tecnologías Espaciales de Asturias (ICTEA), Oviedo, Spain

B. Alvarez Gonzalez , J. Cuevas , J. Fernandez Menendez , S. Folgueras , I. Gonzalez Caballero , J.R. González Fernández , P. Leguina , E. Palencia Cortezon , J. Prado Pico, C. Ramón Álvarez , V. Rodríguez Bouza , A. Soto Rodríguez , A. Trapote , C. Vico Villalba , P. Vischia 

Instituto de Física de Cantabria (IFCA), CSIC-Universidad de Cantabria, Santander, Spain

S. Bhowmik , S. Blanco Fernández , I.J. Cabrillo , A. Calderon , J. Duarte Campderros , M. Fernandez , G. Gomez , C. Lasasoa García , R. Lopez Ruiz , C. Martinez Rivero , P. Martinez Ruiz del Arbol , F. Matorras , P. Matorras Cuevas , E. Navarrete Ramos , J. Piedra Gomez , L. Scodellaro , I. Vila , J.M. Vizan Garcia 

University of Colombo, Colombo, Sri Lanka

B. Kailasapathy⁵⁷ , D.D.C. Wickramarathna 

University of Ruhuna, Department of Physics, Matara, Sri Lanka

W.G.D. Dharmaratna⁵⁸ , K. Liyanage , N. Perera 

CERN, European Organization for Nuclear Research, Geneva, Switzerland



































D. Abbaneo , C. Amendola , E. Auffray , G. Auzinger , J. Baechler, D. Barney , A. Bermúdez Martínez , M. Bianco , A.A. Bin Anuar , A. Bocci , L. Boronovi , C. Botta , E. Brondolin , C. Caillol , G. Cerminara , N. Chernyavskaya , D. d'Enterria , A. Dabrowski , A. David , A. De Roeck , M.M. Defranchis , M. Deile , M. Dobson , G. Franzoni , W. Funk , S. Giani, D. Gigi, K. Gill , F. Glege , J. Hegeman , J.K. Heikkilä , B. Huber, V. Innocente , T. James , P. Janot , O. Kaluzinska , O. Karacheban²⁷ , S. Laurila , P. Lecoq , E. Leutgeb , C. Lourenço , L. Malgeri , M. Mannelli , M. Matthewman, A. Mehta , F. Meijers , S. Mersi , E. Meschi , V. Milosevic , F. Monti , F. Moortgat , M. Mulders , I. Neutelings , S. Orfanelli, F. Pantaleo , G. Petrucciani , A. Pfeiffer , M. Pierini , H. Qu , D. Rabady , B. Ribeiro Lopes , M. Rovere , H. Sakulin , S. Sanchez Cruz , S. Scarfi , C. Schwick, M. Selvaggi , A. Sharma , K. Shchelina , P. Silva , P. Sphicas⁵⁹ , A.G. Stahl Leiton , A. Steen , S. Summers , D. Treille , P. Tropea , D. Walter , J. Wanczyk⁶⁰ , J. Wang, K.A. Wozniak⁶¹ , S. Wuchterl , P. Zehetner , P. Zejdl , W.D. Zeuner

Paul Scherrer Institut, Villigen, Switzerland



















T. Bevilacqua⁶² , L. Caminada⁶² , A. Ebrahimi , W. Erdmann , R. Horisberger , Q. Ingram , H.C. Kaestli , D. Kotlinski , C. Lange , M. Missiroli⁶² , L. Noehte⁶² 

T. Rohe , A. Samalan



ETH Zurich - Institute for Particle Physics and Astrophysics (IPA), Zurich, Switzerland

T.K. Aarrestad , K. Androsov⁶⁰ , M. Backhaus , G. Bonomelli, A. Calandri , C. Cazaniga , K. Datta , P. De Bryas Dexmiers D'archiac⁶⁰ , A. De Cosa , G. Dissertori , M. Dittmar, M. Donegà , F. Eble , M. Galli , K. Gedia , F. Glessgen , C. Grab , N. Härringer , T.G. Harte, D. Hits , W. Lustermann , A.-M. Lyon , R.A. Manzoni , M. Marchegiani , L. Marchese , C. Martin Perez , A. Mascellani⁶⁰ , F. Nessi-Tedaldi , F. Pauss , V. Perovic , S. Pigazzini , B. Ristic , F. Riti , R. Seidita , J. Steggemann⁶⁰ , A. Tarabini , D. Valsecchi , R. Wallny 











Universität Zürich, Zurich, Switzerland

C. Amsler⁶³ , P. Bäertschi , M.F. Canelli , K. Cormier , M. Huwiler , W. Jin , A. Jofrehei , B. Kilminster , S. Leontsinis , S.P. Liehti , A. Macchiolo , P. Meiring , F. Meng , U. Molinatti , J. Motta , A. Reimers , P. Robmann, M. Senger , E. Shokr, F. Stäger , R. Tramontano 

National Central University, Chung-Li, Taiwan

C. Adloff⁶⁴, D. Bhowmik, C.M. Kuo, W. Lin, P.K. Rout , P.C. Tiwari³⁸ , S.S. Yu 



















National Taiwan University (NTU), Taipei, Taiwan

L. Ceard, K.F. Chen , P.s. Chen, Z.g. Chen, A. De Iorio , W.-S. Hou , T.h. Hsu, Y.w. Kao, S. Karmakar , G. Kole , Y.y. Li , R.-S. Lu , E. Paganis , X.f. Su , J. Thomas-Wilsker , L.s. Tsai, D. Tsiou, H.y. Wu, E. Yazgan 

High Energy Physics Research Unit, Department of Physics, Faculty of Science, Chulalongkorn University, Bangkok, Thailand

C. Asawatangtrakuldee , N. Srimanobhas , V. Wachirapusanand 

Çukurova University, Physics Department, Science and Art Faculty, Adana, Turkey

D. Agyel , F. Boran , F. Dolek , I. Dumanoglu⁶⁵ , E. Eskut , Y. Guler⁶⁶ , E. Gurpinar Guler⁶⁶ , C. Isik , O. Kara, A. Kayis Topaksu , U. Kiminsu , G. Onengut , K. Ozdemir⁶⁷ , A. Polatoz , B. Tali⁶⁸ , U.G. Tok , S. Turkcapar , E. Uslan , I.S. Zorbakir 

Middle East Technical University, Physics Department, Ankara, Turkey

G. Sokmen, M. Yalvac⁶⁹ 

Bogazici University, Istanbul, Turkey

B. Akgun , I.O. Atakisi , E. Gülmez , M. Kaya⁷⁰ , O. Kaya⁷¹ , S. Tekten⁷² 





Istanbul Technical University, Istanbul, Turkey

A. Cakir , K. Cankocak^{65,73} , G.G. Dincer⁶⁵ , Y. Komurcu , S. Sen⁷⁴ 

Istanbul University, Istanbul, Turkey

O. Aydilek⁷⁵ , B. Hacisahinoglu , I. Hos⁷⁶ , B. Kaynak , S. Ozkorucuklu , O. Potok , H. Sert , C. Simsek , C. Zorbilmez 

Yildiz Technical University, Istanbul, Turkey

S. Cerci , B. Isildak⁷⁷ , D. Sunar Cerci , T. Yetkin 

















Institute for Scintillation Materials of National Academy of Science of Ukraine, Kharkiv, Ukraine

A. Boyaryntsev , B. Grynyov 

























National Science Centre, Kharkiv Institute of Physics and Technology, Kharkiv, Ukraine

L. Levchuk 















































University of Bristol, Bristol, United Kingdom

D. Anthony , J.J. Brooke , A. Bundock , F. Bury , E. Clement , D. Cussans , H. Flacher , M. Glowacki , J. Goldstein , H.F. Heath , M.-L. Holmberg , L. Kreczko , S. Paramesvaran , L. Robertshaw , S. Seif El Nasr-Storey , V.J. Smith , N. Stylianou⁷⁸ , K. Walkingshaw Pass



Rutherford Appleton Laboratory, Didcot, United Kingdom

A.H. Ball , K.W. Bell , A. Belyaev⁷⁹ , C. Brew , R.M. Brown , D.J.A. Cockerill , C. Cooke , A. Elliot , K.V. Ellis , K. Harder , S. Harper , J. Linacre , K. Manolopoulos , D.M. Newbold , E. Olaiya , D. Petyt , T. Reis , A.R. Sahasransu , G. Salvi , T. Schuh , C.H. Shepherd-Themistocleous , I.R. Tomalin , K.C. Whalen , T. Williams 













Imperial College, London, United Kingdom

I. Andreou , R. Bainbridge , P. Bloch , C.E. Brown , O. Buchmuller , V. Cacchio , C.A. Carrillo Montoya , G.S. Chahal⁸⁰ , D. Colling , J.S. Dancu , I. Das , P. Dauncey , G. Davies , J. Davies , M. Della Negra , S. Fayer , G. Fedi , G. Hall , M.H. Hassanshahi , A. Howard , G. Iles , C.R. Knight , J. Langford , J. León Holgado , L. Lyons , A.-M. Magnan , B. Maier , S. Mallios , M. Mieskolainen , J. Nash⁸¹ , M. Pesaresi , P.B. Pradeep , B.C. Radburn-Smith , A. Richards , A. Rose , K. Savva , C. Seez , R. Shukla , A. Tapper , K. Uchida , G.P. Uttley , L.H. Vage , T. Virdee³⁰ , M. Vojinovic , N. Wardle , D. Winterbottom 







Brunel University, Uxbridge, United Kingdom

J.E. Cole , A. Khan , P. Kyberd , I.D. Reid 











Baylor University, Waco, Texas, USA

S. Abdullin , A. Brinkerhoff , E. Collins , M.R. Darwish⁸² , J. Dittmann , K. Hatakeyama , J. Hiltbrand , B. McMaster , J. Samudio , S. Sawant , C. Sutantawibul , J. Wilson 





















Catholic University of America, Washington, DC, USA

R. Bartek , A. Dominguez , C. Huerta Escamilla , A.E. Simsek , R. Uniyal , A.M. Vargas Hernandez 





















The University of Alabama, Tuscaloosa, Alabama, USA

B. Bam , A. Buchot Perraguin , R. Chudasama , S.I. Cooper , C. Crovella , S.V. Gleyzer , E. Pearson , C.U. Perez , P. Rumerio⁸³ , E. Usai , R. Yi 





Boston University, Boston, Massachusetts, USA

A. Akpinar , C. Cosby , G. De Castro , Z. Demiragli , C. Erice , C. Fangmeier , C. Fernandez Madrazo , E. Fontanesi , D. Gastler , F. Golf , S. Jeon , J. O'cain , I. Reed , J. Rohlf , K. Salyer , D. Sperka , D. Spitzbart , I. Suarez , A. Tsatsos , A.G. Zecchinelli 

Brown University, Providence, Rhode Island, USA

G. Benelli , D. Cutts , L. Gouskos , M. Hadley , U. Heintz , J.M. Hogan⁸⁴ , T. Kwon , G. Landsberg , K.T. Lau , D. Li , J. Luo , S. Mondal , N. Pervan , T. Russell , S. Sagir⁸⁵ , X. Shen , F. Simpson , M. Stamenkovic , N. Venkatasubramanian , X. Yan 

University of California, Davis, Davis, California, USA

S. Abbott , C. Brainerd , R. Breedon , H. Cai , M. Calderon De La Barca Sanchez 

M. Chertok , M. Citron , J. Conway , P.T. Cox , R. Erbacher , F. Jensen , O. Kukral , G. Mocellin , M. Mulhearn , S. Ostrom , W. Wei , S. Yoo , F. Zhang 

























University of California, Los Angeles, California, USA

M. Bachtis , R. Cousins , A. Datta , G. Flores Avila , J. Hauser , M. Ignatenko , M.A. Iqbal , T. Lam , E. Manca , A. Nunez Del Prado, D. Saltzberg , V. Valuev 

University of California, Riverside, Riverside, California, USA

R. Clare , J.W. Gary , M. Gordon, G. Hanson , W. Si 

University of California, San Diego, La Jolla, California, USA

A. Aportela, A. Arora , J.G. Branson , S. Cittolin , S. Cooperstein , D. Diaz , J. Duarte , L. Giannini , Y. Gu, J. Guiang , R. Kansal , V. Krutelyov , R. Lee , J. Letts , M. Masciovecchio , F. Mokhtar , S. Mukherjee , M. Pieri , M. Quinnan , B.V. Sathia Narayanan , V. Sharma , M. Tadel , E. Vourliotis , F. Würthwein , Y. Xiang , A. Yagil 















University of California, Santa Barbara - Department of Physics, Santa Barbara, California, USA

A. Barzdukas , L. Brennan , C. Campagnari , K. Downham , C. Grieco , J. Incandela , J. Kim , A.J. Li , P. Masterson , H. Mei , J. Richman , S.N. Santpur , U. Sarica , R. Schmitz , F. Setti , J. Sheplock , D. Stuart , T.Á. Vámi , S. Wang , D. Zhang















California Institute of Technology, Pasadena, California, USA

S. Bhattacharya , A. Bornheim , O. Cerri, A. Latorre, J. Mao , H.B. Newman , G. Reales Gutiérrez, M. Spiropulu , J.R. Vlimant , C. Wang , S. Xie , R.Y. Zhu 















Carnegie Mellon University, Pittsburgh, Pennsylvania, USA

J. Alison , S. An , P. Bryant , M. Cremonesi, V. Dutta , T. Ferguson , T.A. Gómez Espinosa , A. Harilal , A. Kallil Tharayil, C. Liu , T. Mudholkar , S. Murthy , P. Palit , K. Park, M. Paulini , A. Roberts , A. Sanchez , W. Terrill 



































































University of Colorado Boulder, Boulder, Colorado, USA







J.P. Cumalat , W.T. Ford , A. Hart , A. Hassani , G. Karathanasis , N. Manganelli , J. Pearkes , C. Savard , N. Schonbeck , K. Stenson , K.A. Ulmer , S.R. Wagner , N. Zipper , D. Zuolo 

Cornell University, Ithaca, New York, USA



















J. Alexander , S. Bright-Thonney , X. Chen , D.J. Cranshaw , J. Fan , X. Fan , S. Hogan , P. Kotamvives, J. Monroy , M. Oshiro , J.R. Patterson , M. Reid , A. Ryd , J. Thom , P. Wittich , R. Zou 

Fermi National Accelerator Laboratory, Batavia, Illinois, USA













M. Albrow , M. Alyari , O. Amram , G. Apollinari , A. Apresyan , L.A.T. Bauerdick , D. Berry , J. Berryhill , P.C. Bhat , K. Burkett , J.N. Butler , A. Canepa , G.B. Cerati , H.W.K. Cheung , F. Chlebana , G. Cummings , J. Dickinson , I. Dutta , V.D. Elvira , Y. Feng , J. Freeman , A. Gandrakota , Z. Gecse , L. Gray , D. Green, A. Grummer , S. Grünendahl , D. Guerrero , O. Gutsche , R.M. Harris , R. Heller , T.C. Herwig , J. Hirschauer , B. Jayatilaka , S. Jindariani , M. Johnson , U. Joshi , T. Klijsma , B. Klima , K.H.M. Kwok , S. Lammel , D. Lincoln , R. Lipton , T. Liu , C. Madrid , K. Maeshima , C. Mantilla , D. Mason , P. McBride , P. Merkel , S. Mrenna , S. Nahn , J. Ngadiuba , D. Noonan , S. Norberg, V. Papadimitriou , N. Pastika , K. Pedro , C. Pena⁸⁶ , F. Ravera , A. Reinsvold Hall⁸⁷ , L. Ristori , M. Safdari , E. Sexton-Kennedy , N. Smith , A. Soha , L. Spiegel , S. Stoynev , J. Strait 

L. Taylor , S. Tkaczyk , N.V. Tran , L. Uplegger , E.W. Vaandering , I. Zoi 





University of Florida, Gainesville, Florida, USA

C. Aruta , P. Avery , D. Bourilkov , P. Chang , V. Cherepanov , R.D. Field, C. Huh , E. Koenig , M. Kolosova , J. Konigsberg , A. Korytov , K. Matchev , N. Menendez , G. Mitselmakher , K. Mohrman , A. Muthirakalayil Madhu , N. Rawal , S. Rosenzweig , Y. Takahashi , J. Wang 























Florida State University, Tallahassee, Florida, USA

T. Adams , A. Al Kadhim , A. Askew , S. Bower , V. Hagopian , R. Hashmi , R.S. Kim , S. Kim , T. Kolberg , G. Martinez, H. Prosper , P.R. Prova, M. Wulansatiti , R. Yohay , J. Zhang











Florida Institute of Technology, Melbourne, Florida, USA

B. Alsufyani, M.M. Baarmand , S. Butalla , S. Das , T. Elkafrawy¹⁹ , M. Hohlmann , E. Yanes











University of Illinois Chicago, Chicago, USA, Chicago, USA

M.R. Adams , A. Baty , C. Bennett, R. Cavanaugh , R. Escobar Franco , O. Evdokimov , C.E. Gerber , M. Hawksworth, A. Hingrajiya, D.J. Hofman , J.h. Lee , D. S. Lemos , A.H. Merrit , C. Mills , S. Nanda , G. Oh , B. Ozek , D. Pilipovic , R. Pradhan , E. Pifti, T. Roy , S. Rudrabhatla , N. Singh, M.B. Tonjes , N. Varelas , M.A. Wadud , Z. Ye , J. Yoo 























The University of Iowa, Iowa City, Iowa, USA

M. Alhousseini , D. Blend, K. Dilsiz⁸⁸ , L. Emediato , G. Karaman , O.K. Köseyan , J.-P. Merlo, A. Mestvirishvili⁸⁹ , O. Neogi, H. Ogul⁹⁰ , Y. Onel , A. Penzo , C. Snyder, E. Tiras⁹¹ 









Johns Hopkins University, Baltimore, Maryland, USA

B. Blumenfeld , L. Corcodilos , J. Davis , A.V. Gritsan , L. Kang , S. Kyriacou , P. Maksimovic , M. Roguljic , J. Roskes , S. Sekhar , M. Swartz 

















The University of Kansas, Lawrence, Kansas, USA

A. Abreu , L.F. Alcerro Alcerro , J. Anguiano , S. Arteaga Escatel , P. Baringer , A. Bean , Z. Flowers , D. Grove , J. King , G. Krintiras , M. Lazarovits , C. Le Mahieu , J. Marquez , M. Murray , M. Nickel , M. Pitt , S. Popescu⁹² , C. Rogan , C. Royon , R. Salvatico , S. Sanders , C. Smith , G. Wilson 





















Kansas State University, Manhattan, Kansas, USA

B. Allmond , R. Gujju Gurunadha , A. Ivanov , K. Kaadze , Y. Maravin , J. Natoli , D. Roy , G. Sorrentino 

University of Maryland, College Park, Maryland, USA

A. Baden , A. Belloni , J. Bistany-riebman, Y.M. Chen , S.C. Eno , N.J. Hadley , S. Jabeen , R.G. Kellogg , T. Koeth , B. Kronheim, Y. Lai , S. Lascio , A.C. Mignerey , S. Nabili , C. Palmer , C. Papageorgakis , M.M. Paranjpe, E. Popova⁹³ , A. Shevelev , L. Wang 

Massachusetts Institute of Technology, Cambridge, Massachusetts, USA













J. Bendavid , I.A. Cali , P.c. Chou , M. D'Alfonso , J. Eysermans , C. Freer , G. Gomez-Ceballos , M. Goncharov, G. Grosso, P. Harris, D. Hoang, D. Kovalskiy , J. Krupa , L. Lavezzo , Y.-J. Lee , K. Long , C. Mcginn, A. Novak , C. Paus , C. Reissel , C. Roland , G. Roland , S. Rothman , G.S.F. Stephans , Z. Wang 

B. Wyslouch , T. J. Yang 











University of Minnesota, Minneapolis, Minnesota, USA

B. Crossman , B.M. Joshi , C. Kapsiak , M. Krohn , D. Mahon , J. Mans ,
B. Marzocchi , M. Revering , R. Rusack , R. Saradhy , N. Strobbe 



















University of Nebraska-Lincoln, Lincoln, Nebraska, USA

K. Bloom , D.R. Claes , G. Haza , J. Hossain , C. Joo , I. Kravchenko , J.E. Siado ,
W. Tabb , A. Vagnerini , A. Wightman , F. Yan , D. Yu 







State University of New York at Buffalo, Buffalo, New York, USA

H. Bandyopadhyay , L. Hay , H.w. Hsia, I. Iashvili , A. Kalogeropoulos ,
A. Kharchilava , M. Morris , D. Nguyen , J. Pekkanen , S. Rappoccio , H. Rejeb Sfar,
A. Williams , P. Young 



























Northeastern University, Boston, Massachusetts, USA

G. Alverson , E. Barberis , J. Bonilla , M. Campana , J. Dervan, Y. Haddad , Y. Han ,
I. Israr , A. Krishna , J. Li , M. Lu , G. Madigan , R. Mccarthy , D.M. Morse ,
V. Nguyen , T. Orimoto , A. Parker , L. Skinnari , D. Wood 









Northwestern University, Evanston, Illinois, USA

J. Bueghly, S. Dittmer , K.A. Hahn , Y. Liu , Y. Miao , D.G. Monk , M.H. Schmitt ,
A. Taliercio , M. Velasco

















University of Notre Dame, Notre Dame, Indiana, USA

G. Agarwal , R. Band , R. Bucci, S. Castells , A. Das , R. Goldouzian , M. Hildreth ,
K.W. Ho , K. Hurtado Anampa , T. Ivanov , C. Jessop , K. Lannon , J. Lawrence ,
N. Loukas , L. Lutton , J. Mariano, N. Marinelli, I. Mcalister, T. McCauley , C. Mcgrady ,
C. Moore , Y. Musienko¹⁶ , H. Nelson , M. Osherson , A. Piccinelli , R. Ruchti ,
A. Townsend , Y. Wan, M. Wayne , H. Yockey, M. Zarucki , L. Zygalá 

The Ohio State University, Columbus, Ohio, USA

A. Basnet , B. Bylsma, M. Carrigan , L.S. Durkin , C. Hill , M. Joyce , M. Nunez Ornelas ,
K. Wei, B.L. Winer , B. R. Yates 



















Princeton University, Princeton, New Jersey, USA

H. Bouchamaoui , K. Coldham, P. Das , G. Dezoort , P. Elmer , A. Frankenthal ,
B. Greenberg , N. Haubrich , K. Kennedy, G. Kopp , S. Kwan , D. Lange ,
A. Loeliger , D. Marlow , I. Ojalvo , J. Olsen , D. Stickland , C. Tully 



University of Puerto Rico, Mayaguez, Puerto Rico, USA

S. Malik 

Purdue University, West Lafayette, Indiana, USA



A.S. Bakshi , S. Chandra , R. Chawla , A. Gu , L. Gutay, M. Jones , A.W. Jung ,
A.M. Koshy, M. Liu , G. Negro , N. Neumeister , G. Paspalaki , S. Piperov ,
V. Scheurer, J.F. Schulte , M. Stojanovic , J. Thieman , A. K. Viridi , F. Wang ,
A. Wildridge , W. Xie , Y. Yao 

Purdue University Northwest, Hammond, Indiana, USA

J. Dolen , N. Parashar , A. Pathak 

Rice University, Houston, Texas, USA





















D. Acosta , T. Carnahan , K.M. Ecklund , P.J. Fernández Manteca , S. Freed, P. Gardner,
F.J.M. Geurts , I. Krommydas , W. Li , J. Lin , O. Miguel Colin , B.P. Padley 

R. Redjimi, J. Rotter , E. Yigitbasi , Y. Zhang 











University of Rochester, Rochester, New York, USA

A. Bodek , P. de Barbaro , R. Demina , J.L. Dulemba , A. Garcia-Bellido ,
O. Hindrichs , A. Khukhunaishvili , N. Parmar, P. Parygin⁹³ , R. Taus 















Rutgers, The State University of New Jersey, Piscataway, New Jersey, USA

B. Chiarito, J.P. Chou , S.V. Clark , D. Gadkari , Y. Gershtein , E. Halkiadakis ,
M. Heindl , C. Houghton , D. Jaroslawski , S. Konstantinou , I. Laflotte , A. Lath ,
R. Montalvo, K. Nash, J. Reichert , H. Routray , P. Saha , S. Salur , S. Schnetzer,
S. Somalwar , R. Stone , S.A. Thayil , S. Thomas, J. Vora , H. Wang 

University of Tennessee, Knoxville, Tennessee, USA

D. Ally , A.G. Delannoy , S. Fiorendi , S. Higginbotham , T. Holmes , A.R. Kanu-
ganti , N. Karunarathna , L. Lee , E. Nibigira , S. Spanier 











Texas A&M University, College Station, Texas, USA

D. Aebi , M. Ahmad , T. Akhter , O. Bouhali⁹⁴ , R. Eusebi , J. Gilmore , T. Huang ,
T. Kamon⁹⁵ , H. Kim , S. Luo , R. Mueller , D. Overton , D. Rathjens , A. Safonov 

Texas Tech University, Lubbock, Texas, USA

N. Akchurin , J. Damgov , N. Gogate , V. Hegde , A. Hussain , Y. Kazhykarim,
K. Lamichhane , S.W. Lee , A. Mankel , T. Peltola , I. Volobouev 

Vanderbilt University, Nashville, Tennessee, USA

E. Appelt , Y. Chen , S. Greene, A. Gurrola , W. Johns , R. Kunnawalkam Elayavalli ,
A. Melo , F. Romeo , P. Sheldon , S. Tuo , J. Velkovska , J. Viinikainen 























University of Virginia, Charlottesville, Virginia, USA

B. Cardwell , H. Chung, B. Cox , J. Hakala , R. Hirosky , A. Ledovskoy , C. Neu 

Wayne State University, Detroit, Michigan, USA

















S. Bhattacharya , P.E. Karchin 

University of Wisconsin - Madison, Madison, Wisconsin, USA

A. Aravind, S. Banerjee , K. Black , T. Bose , S. Dasu , I. De Bruyn , P. Everaerts ,
C. Galloni, H. He , M. Herndon , A. Herve , C.K. Koraka , A. Lanaro, R. Loveless ,
J. Madhusudanan Sreekala , A. Mallampalli , A. Mohammadi , S. Mondal, G. Parida ,
L. Pétré , D. Pinna, A. Savin, V. Shang , V. Sharma , W.H. Smith , D. Teague, H.F. Tsoi ,
W. Vetens , A. Warden 

Authors affiliated with an institute or an international laboratory covered by a cooperation agreement with CERN

S. Afanasiev , V. Alexakhin , D. Budkouski , I. Golutvin[†] , I. Gorbunov ,
V. Karjavine , V. Korenkov , A. Lanev , A. Malakhov , V. Matveev⁹⁶ ,
V. Palichik , V. Perelygin , M. Savina , V. Shalaev , S. Shmatov , S. Shulha ,
V. Smirnov , O. Teryaev , N. Voytishin , B.S. Yuldashev⁹⁷, A. Zarubin , I. Zhizhin ,
G. Gavrillov , V. Golovtcov , Y. Ivanov , V. Kim⁹⁶ , P. Levchenko⁹⁸ , V. Murzin ,
V. Oreshkin , D. Sosnov , V. Sulimov , L. Uvarov , A. Vorobyev[†], Yu. Andreev ,
A. Dermenev , S. Gninenko , N. Golubev , A. Karneyeu , D. Kirpichnikov ,
M. Kirsanov , N. Krasnikov , I. Tlisova , A. Toropin , T. Aushev , V. Gavrillov ,
N. Lychkovskaya , A. Nikitenko^{99,100} , V. Popov , A. Zhokin , R. Chistov⁹⁶ ,
M. Danilov⁹⁶ , S. Polikarpov⁹⁶ , V. Andreev , M. Azarkin , M. Kirakosyan,
A. Terkulov , E. Boos , V. Bunichev , M. Dubinin⁸⁶ , L. Dudko , A. Gribushin 

V. Klyukhin , O. Kodolova¹⁰⁰ , S. Obraztsov , M. Perfilov, S. Petrushanko , V. Savrin , G. Vorotnikov , V. Blinov⁹⁶, T. Dimova⁹⁶ , A. Kozyrev⁹⁶ , O. Radchenko⁹⁶ , Y. Skovpen⁹⁶ , V. Kachanov , D. Konstantinov , S. Slabospitskii , A. Uzunian , A. Babaev , V. Borshch , D. Druzhkin¹⁰¹ 

Authors affiliated with an institute formerly covered by a cooperation agreement with CERN

V. Chekhovsky, V. Makarenko 

†: Deceased

¹Also at Yerevan State University, Yerevan, Armenia

²Also at TU Wien, Vienna, Austria

³Also at Ghent University, Ghent, Belgium

⁴Also at Universidade do Estado do Rio de Janeiro, Rio de Janeiro, Brazil

⁵Also at Universidade Estadual de Campinas, Campinas, Brazil

⁶Also at Federal University of Rio Grande do Sul, Porto Alegre, Brazil

⁷Also at UFMS, Nova Andradina, Brazil

⁸Also at Nanjing Normal University, Nanjing, China

⁹Now at The University of Iowa, Iowa City, Iowa, USA

¹⁰Also at University of Chinese Academy of Sciences, Beijing, China

¹¹Also at China Center of Advanced Science and Technology, Beijing, China

¹²Also at University of Chinese Academy of Sciences, Beijing, China

¹³Also at China Spallation Neutron Source, Guangdong, China

¹⁴Now at Henan Normal University, Xinxiang, China

¹⁵Also at Université Libre de Bruxelles, Bruxelles, Belgium

¹⁶Also at an institute or an international laboratory covered by a cooperation agreement with CERN

¹⁷Also at Zewail City of Science and Technology, Zewail, Egypt

¹⁸Also at British University in Egypt, Cairo, Egypt

¹⁹Now at Ain Shams University, Cairo, Egypt

²⁰Also at Purdue University, West Lafayette, Indiana, USA

²¹Also at Université de Haute Alsace, Mulhouse, France

²²Also at Istinye University, Istanbul, Turkey

²³Also at The University of the State of Amazonas, Manaus, Brazil

²⁴Also at University of Hamburg, Hamburg, Germany

²⁵Also at RWTH Aachen University, III. Physikalisches Institut A, Aachen, Germany

²⁶Also at Bergische University Wuppertal (BUW), Wuppertal, Germany

²⁷Also at Brandenburg University of Technology, Cottbus, Germany

²⁸Also at Forschungszentrum Jülich, Juelich, Germany

²⁹Also at Hamburg University of Applied Sciences (HAW Hamburg), Hamburg, Germany

³⁰Also at CERN, European Organization for Nuclear Research, Geneva, Switzerland

³¹Also at Institute of Nuclear Research ATOMKI, Debrecen, Hungary

³²Now at Universitatea Babeş-Bolyai - Facultatea de Fizica, Cluj-Napoca, Romania

³³Also at MTA-ELTE Lendület CMS Particle and Nuclear Physics Group, Eötvös Loránd University, Budapest, Hungary

³⁴Also at HUN-REN Wigner Research Centre for Physics, Budapest, Hungary

³⁵Also at Physics Department, Faculty of Science, Assiut University, Assiut, Egypt

³⁶Also at Punjab Agricultural University, Ludhiana, India

³⁷Also at University of Visva-Bharati, Santiniketan, India

³⁸Also at Indian Institute of Science (IISc), Bangalore, India

³⁹Also at IIT Bhubaneswar, Bhubaneswar, India

- ⁴⁰Also at Institute of Physics, Bhubaneswar, India
- ⁴¹Also at University of Hyderabad, Hyderabad, India
- ⁴²Also at Deutsches Elektronen-Synchrotron, Hamburg, Germany
- ⁴³Also at Isfahan University of Technology, Isfahan, Iran
- ⁴⁴Also at Sharif University of Technology, Tehran, Iran
- ⁴⁵Also at Department of Physics, University of Science and Technology of Mazandaran, Behshahr, Iran
- ⁴⁶Also at Department of Physics, Isfahan University of Technology, Isfahan, Iran
- ⁴⁷Also at Department of Physics, Faculty of Science, Arak University, ARAK, Iran
- ⁴⁸Also at Helwan University, Cairo, Egypt
- ⁴⁹Also at Italian National Agency for New Technologies, Energy and Sustainable Economic Development, Bologna, Italy
- ⁵⁰Also at Centro Siciliano di Fisica Nucleare e di Struttura Della Materia, Catania, Italy
- ⁵¹Also at Università degli Studi Guglielmo Marconi, Roma, Italy
- ⁵²Also at Scuola Superiore Meridionale, Università di Napoli 'Federico II', Napoli, Italy
- ⁵³Also at Fermi National Accelerator Laboratory, Batavia, Illinois, USA
- ⁵⁴Also at Consiglio Nazionale delle Ricerche - Istituto Officina dei Materiali, Perugia, Italy
- ⁵⁵Also at Department of Applied Physics, Faculty of Science and Technology, Universiti Kebangsaan Malaysia, Bangi, Malaysia
- ⁵⁶Also at Consejo Nacional de Ciencia y Tecnología, Mexico City, Mexico
- ⁵⁷Also at Trincomalee Campus, Eastern University, Sri Lanka, Nilaveli, Sri Lanka
- ⁵⁸Also at Saegis Campus, Nugegoda, Sri Lanka
- ⁵⁹Also at National and Kapodistrian University of Athens, Athens, Greece
- ⁶⁰Also at Ecole Polytechnique Fédérale Lausanne, Lausanne, Switzerland
- ⁶¹Also at University of Vienna, Vienna, Austria
- ⁶²Also at Universität Zürich, Zurich, Switzerland
- ⁶³Also at Stefan Meyer Institute for Subatomic Physics, Vienna, Austria
- ⁶⁴Also at Laboratoire d'Annecy-le-Vieux de Physique des Particules, IN2P3-CNRS, Annecy-le-Vieux, France
- ⁶⁵Also at Near East University, Research Center of Experimental Health Science, Mersin, Turkey
- ⁶⁶Also at Konya Technical University, Konya, Turkey
- ⁶⁷Also at Izmir Bakircay University, Izmir, Turkey
- ⁶⁸Also at Adiyaman University, Adiyaman, Turkey
- ⁶⁹Also at Bozok Universitetesi Rektörlüğü, Yozgat, Turkey
- ⁷⁰Also at Marmara University, Istanbul, Turkey
- ⁷¹Also at Milli Savunma University, Istanbul, Turkey
- ⁷²Also at Kafkas University, Kars, Turkey
- ⁷³Now at Istanbul Okan University, Istanbul, Turkey
- ⁷⁴Also at Hacettepe University, Ankara, Turkey
- ⁷⁵Also at Erzincan Binali Yildirim University, Erzincan, Turkey
- ⁷⁶Also at Istanbul University - Cerrahpasa, Faculty of Engineering, Istanbul, Turkey
- ⁷⁷Also at Yildiz Technical University, Istanbul, Turkey
- ⁷⁸Also at Vrije Universiteit Brussel, Brussel, Belgium
- ⁷⁹Also at School of Physics and Astronomy, University of Southampton, Southampton, United Kingdom
- ⁸⁰Also at IPPP Durham University, Durham, United Kingdom
- ⁸¹Also at Monash University, Faculty of Science, Clayton, Australia
- ⁸²Also at Institute of Basic and Applied Sciences, Faculty of Engineering, Arab Academy for

Science, Technology and Maritime Transport, Alexandria, Egypt

⁸³Also at Università di Torino, Torino, Italy

⁸⁴Also at Bethel University, St. Paul, Minnesota, USA

⁸⁵Also at Karamanoğlu Mehmetbey University, Karaman, Turkey

⁸⁶Also at California Institute of Technology, Pasadena, California, USA

⁸⁷Also at United States Naval Academy, Annapolis, Maryland, USA

⁸⁸Also at Bingol University, Bingol, Turkey

⁸⁹Also at Georgian Technical University, Tbilisi, Georgia

⁹⁰Also at Sinop University, Sinop, Turkey

⁹¹Also at Erciyes University, Kayseri, Turkey

⁹²Also at Horia Hulubei National Institute of Physics and Nuclear Engineering (IFIN-HH), Bucharest, Romania

⁹³Now at another institute or international laboratory covered by a cooperation agreement with CERN

⁹⁴Also at Texas A&M University at Qatar, Doha, Qatar

⁹⁵Also at Kyungpook National University, Daegu, Korea

⁹⁶Also at another institute or international laboratory covered by a cooperation agreement with CERN

⁹⁷Also at Institute of Nuclear Physics of the Uzbekistan Academy of Sciences, Tashkent, Uzbekistan

⁹⁸Also at Northeastern University, Boston, Massachusetts, USA

⁹⁹Also at Imperial College, London, United Kingdom

¹⁰⁰Now at Yerevan Physics Institute, Yerevan, Armenia

¹⁰¹Also at Universiteit Antwerpen, Antwerpen, Belgium