

From Recognition to Prediction: Leveraging Sequence Reasoning for Action Anticipation

XIN LIU*, School of Electrical and Information Engineering, Tianjin University, China, and Computer Vision and Pattern Recognition Laboratory, School of Engineering Sciences, Lappeenranta-Lahti University of Technology LUT, Finland

CHAO HAO*, School of Electrical and Information Engineering, Tianjin University, China

ZITONG YU†, School of Computing and Information Technology, Great Bay University, China

HUANJING YUE and JINGYU YANG, School of Electrical and Information Engineering, Tianjin University, China

The action anticipation task refers to predicting what action will happen based on observed videos, which requires the model to have a strong ability to summarize the present and then reason about the future. Experience and common sense suggest that there is a significant correlation between different actions, which provides valuable prior knowledge for the action anticipation task. However, previous methods have not effectively modeled this underlying statistical relationship. To address this issue, we propose a novel end-to-end video modeling architecture that utilizes attention mechanisms, named Anticipation via Recognition and Reasoning (ARR). ARR decomposes the action anticipation task into action recognition and sequence reasoning tasks, and effectively learns the statistical relationship between actions by next action prediction (NAP). In comparison to existing temporal aggregation strategies, ARR is able to extract more effective features from observable videos to make more reasonable predictions. In addition, to address the challenge of relationship modeling that requires extensive training data, we propose an innovative approach for the unsupervised pre-training of the decoder, which leverages the inherent temporal dynamics of video to enhance the reasoning capabilities of the network. Extensive experiments on the Epic-kitchen-100, EGTEA Gaze+, and 50salads datasets demonstrate the efficacy of the proposed methods. The code is available at <https://github.com/linuxsino/ARR>.

CCS Concepts: • **Computing methodologies** → **Activity recognition and understanding**.

Additional Key Words and Phrases: Action anticipation, Action recognition, Sequence reasoning

ACM Reference Format:

Xin Liu, Chao Hao, Zitong Yu, Huanjing Yue, and Jingyu Yang. 2018. From Recognition to Prediction: Leveraging Sequence Reasoning for Action Anticipation. *ACM Trans. Multimedia Comput. Commun. Appl.* 37, 4, Article 111 (August 2018), 19 pages. <https://doi.org/XXXXXXXX.XXXXXXX>

*Both authors contributed equally to this research.

†Corresponding author.

Authors' addresses: Xin Liu, linuxsino@gmail.com, School of Electrical and Information Engineering, Tianjin University, Tianjin, China and, and Computer Vision and Pattern Recognition Laboratory, School of Engineering Sciences, Lappeenranta-Lahti University of Technology LUT, Lappeenranta, Finland; Chao Hao, 3018234336@tju.edu.cn, School of Electrical and Information Engineering, Tianjin University, Tianjin, China; Zitong Yu, School of Computing and Information Technology, Great Bay University, Dongguan, China, zitong.yu@ieee.org; Huanjing Yue, huanjing.yue@tju.edu.cn; Jingyu Yang, yjy@tju.edu.cn, School of Electrical and Information Engineering, Tianjin University, Tianjin, China.

Permission to make digital or hard copies of all or part of this work for personal or classroom use is granted without fee provided that copies are not made or distributed for profit or commercial advantage and that copies bear this notice and the full citation on the first page. Copyrights for components of this work owned by others than the author(s) must be honored. Abstracting with credit is permitted. To copy otherwise, or republish, to post on servers or to redistribute to lists, requires prior specific permission and/or a fee. Request permissions from permissions@acm.org.

© 2018 Copyright held by the owner/author(s). Publication rights licensed to ACM.

ACM 1551-6857/2018/8-ART111

<https://doi.org/XXXXXXXX.XXXXXXX>

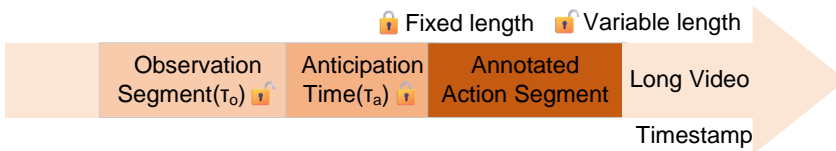

Fig. 1. Description of action anticipation task. In a long video, observed segments of length τ_o are used to infer actions after an anticipation time of length τ_a . “Observation Segment” is used as input, and the output is the action category of “Annotated Action Segment” that we predict, and then calculates the prediction loss with its corresponding annotation. τ_o is not fixed and can be selected according to needs, while τ_a is fixed. Different datasets have different settings.

1 INTRODUCTION

Imagine a future world where a smart home robot is taking care of a child, suddenly, the robot senses that the child is showing signs of falling and helps to support the child in time to avoid potential harm to the child. This proactive intervention to prevent falls is more important than simply helping a child get up after a fall. Predicting the future actions of humans is an important and interesting task for artificial intelligence systems. It is currently receiving widespread attention [20, 23, 54, 79] and has many applications in our lives. If self-driving cars can avoid pedestrians in advance, surveillance videos can detect certain dangers and forewarning, these technologies will make our lives better.

The current general action anticipation task refers to predicting the (verb, noun) label of a future action by observing the segment before it occurs [12–14], as shown in Fig. 1. Action anticipation is similar to the action recognition task [42, 80], both tasks take a video as input and produce an action classification as output. However, the former predicts future actions, while the latter recognizes actions in the present. These two tasks typically utilize the same datasets and annotations [14, 39, 63]. In a lengthy video, the action recognition task solely employs labeled action segments. Conversely, the input of action anticipation comprises both labeled action segments and unlabeled segments, with variable input length. Evidently, action anticipation task is considerably more challenging, with certain state-of-the-art action recognition models demonstrating subpar performance in action anticipation task [43, 59].

When making predictions, humans typically assess the current situation first and then draw on past experiences to inform their judgments. For example, if someone is chopping vegetables in the kitchen, it’s more likely that he will cook rather than cleaning. Clearly, based on our experience, different actions are interconnected, and there is a statistical relationship between the likelihood of their occurrence. This relationship is illustrated in Fig. 2. We analyze the frequency of pairs of actions, consisting of a randomly chosen action followed by a subsequent action. Our findings show that only a few types of actions typically follow any given action. According to our experience, these sequences have strong correlations. The majority of potential subsequent actions are unlikely to occur after the initial action, providing crucial prior information that is beneficial for the task of action anticipation. However, previous methods often ignored this important factor.

The conventional strategy for addressing long-term predictive reasoning tasks entails initial feature extraction at the frame or clip level [7, 67] using established architectures. Subsequently, aggregation is achieved through various methods, including clustering [24], recurrence [19, 31], or models based on attention mechanisms [22, 46]. They are more about iterating and aggregating the extracted features, while ignoring the deeper correlation among actions for action anticipation. In contrast, we think that learning the intrinsic correlations among different actions is beneficial in making more reasonable predictions. As shown in Fig. 3, our method will first get the current

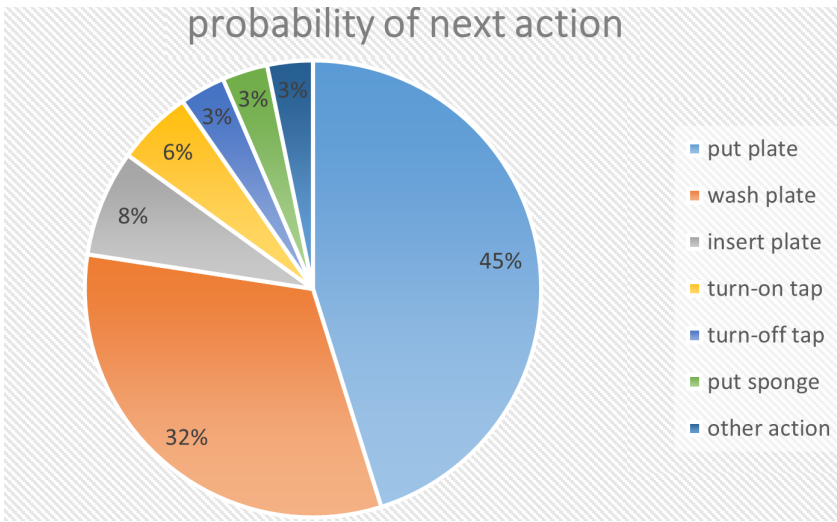

Fig. 2. The probability of next action. We randomly select an action in EK100 dataset as the current action (e.g., “wash plate”). We count the frequency of the next action, and use the frequency to calculate the probability. Although there are thousands of actions in the dataset, we can see that only some actions (e.g., “put plate” and “wash plate”) highly correlated will occur after the given action, and most actions will not appear.

action and then go through the action sequence to get the final result instead of directly getting the prediction like the previous method.

In this work, we propose Anticipation via Recognition and Reasoning (ARR). We decompose the action anticipation task into two tasks of action recognition and sequence reasoning, which have been studied a lot. We model the input video as a sequence input, and map them into action sequences through action recognition task. Then we use the causal decoder structure that has been proven to have powerful reasoning capabilities by large language models [5, 51, 52, 57, 64, 66, 77] to complete sequence reasoning task. We draw on the popular Next Token Prediction (NTP) task [51] of the current large language model and propose Next Action Prediction (NAP), which enables the network to fully learn and model the correlation among different actions, and enhance the reasoning ability of the network. In addition, to solve the problem that NAP requires a large amount of training data, we also use an unsupervised pre-training method [3, 23, 75] to initialize the sequence reasoning network to further enhance the performance of the network.

Specifically, ARR uses vision Transformer [2, 4, 17, 27] and causal decoder [68] to realize the main function. Since the emergence of vision Transformer, action recognition technology has developed very advanced. The highest recognition accuracy of the K400 dataset [7] has reached 91% [73], which has exceeded the human level. Using action recognition task for supervised training can ensure that we extract more effective features from observation clips [45], which pay more attention to action content rather than other useless information. In addition, causal masked self-attention ensures that each predicted action can only obtain information from its front, and there is no risk of information leakage, which is crucial for the action anticipation task [14, 21]. Through this paradigm, the network can be based on actions that occurred in the past to predict the next action and realize the modeling of the correlation between actions. As for the unsupervised pre-training based on the natural timing of the video before the overall training, we do not change the overall architecture of the network, but replacing the supervised learning method with the self-supervised form of learning the next feature.

In summary, our main contributions include:

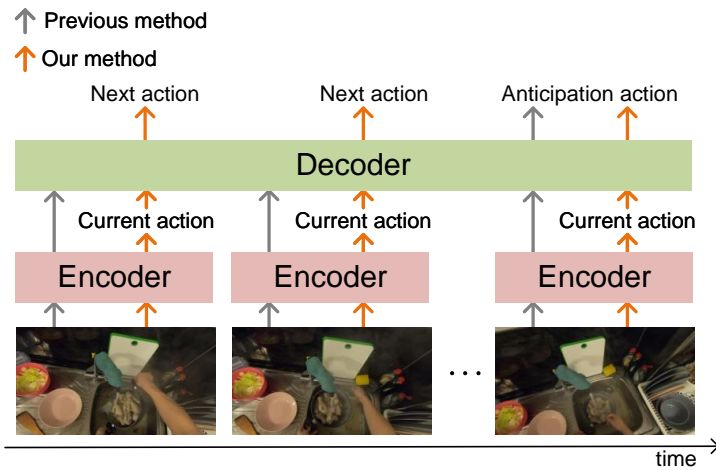

Fig. 3. Comparison of our method with previous methods. While previous methods tend to predict actions directly from a given video, our method learns the correlation among actions to benefit prediction by recognizing actions and then conducting sequence reasoning.

- We propose the ARR, a novel end-to-end architecture for implementing action anticipation, which is based on the pure attention mechanism and effectively completes the action anticipation task.
- We decompose the relatively difficult task of action anticipation into two simpler tasks (i.e., action recognition and sequence reasoning), and propose the NAP to learn the intrinsic correlation among different actions. Thus, the model can better utilize the statistic relationship among actions to complete the inference.
- We propose a method for unsupervised pre-training using the natural timing of videos, which provides an effective method for network initialization of action anticipation task.
- We achieve competitive results on the Epic-kitchen-100, EGTEA Gaze+ and 50salads datasets and demonstrate a strong statistical correlation among actions.

2 RELATED WORK

Action Recognition is essentially a classification task of judging actions from a given video. In the early days, people extracted features through manual design methods [35, 36, 70, 71], these methods often require careful design but the performance is not good enough. With the emergence of deep learning methods [34], the accuracy of action recognition has begun to increase significantly, and various efficient algorithms and large-scale datasets have also begun to appear. Karpathy et al. [32] considered the use of convolutional neural networks (CNN) and investigated different strategies for fusing per-frame predictions. Simonyan et al. [62] proposed two-stream CNN, a multi-branch architecture for action recognition by processing appearance (RGB) and motion (optical flow) data. Carreira et al. [7] proposed to expand 2D CNN into 3D to make better use of large-scale pre-training of images. Timesformer [4] was the first to propose a video-based Transformer architecture and achieved good results, and then the attention-based methods directly dominated this field [37, 38, 45, 74]. The action recognition module in this work is also based on Transformer architecture [76].

Action Anticipation task [78] appeared not long ago but has received widespread attention, especially in the field of first-person video. The current mainstream method is to sample the video to form a sequence, then extract information through the encoder, and finally predict the

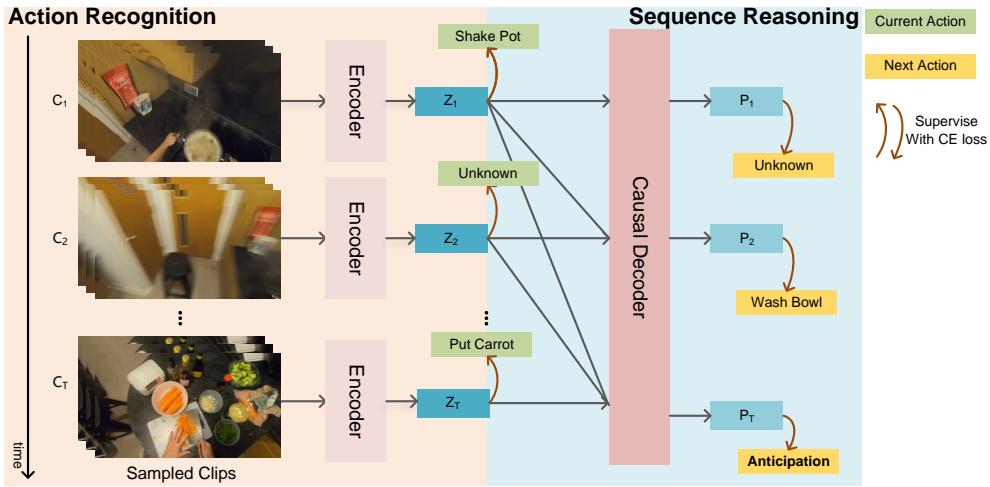

Fig. 4. Overall framework of the ARR. The model consists of two components: on the left is a complete action recognition network that identifies the action corresponding to the current video clip within the action annotation sequence. On the right is a complete sequence reasoning network that predicts the next action corresponding to the current video clip within the action annotation sequence.

anticipation action by aggregating the extracted features through LSTM [30] or other sequence models [16, 52]. Furnari et al. [20] used pre-extracted frame-level features for recursive modeling and prediction via LSTM [30]. Girdhar et al. [23] first used the pre-trained causal decoder as the prediction head to greatly improve the prediction ability. Zhong et al. [79] explored the relationship between different modal information and the influence of the interaction mode between them on the prediction results. This work is also based on the encoder and decoder structure but has been modified for some specific problems. Roy et al. [56] proposed a new strategy that greatly improved the indicators of action anticipation tasks by paying special attention to human-object interaction and temporal dynamics along the motion paths.

Action recognition and action prediction are two highly related tasks, one focuses on the present and the other focuses on the future. There have been some works [40, 41] trying to jointly learn them. The method proposed in this paper is to predict the future on the basis of a better understanding of the present, which is a reasonable and effective extension of end-to-end action recognition to action prediction.

Next Token Prediction (NTP) is the essence of text generation and a key to the success of large language models [5]. It has almost become the basic pre-training task of all large language models [5, 11, 53, 57, 66, 77]. The language model learns the potential relationship between languages by predicting the probability of the next word. The GPT series were the first to use this NTP-based task to train a model, it fits perfectly with the pure causal decoder structure. Although the performance was not as good as Bert [15] at the beginning, with the increase of training data, GPT3.5 made people see the hope of powerful artificial intelligence. In this work, we follow the example of NTP to construct the Next Action Prediction (NAP), hoping that the model can better learn the statistical relationship among actions through this training method. NAP predicts the next action based on a sequence of preceding actions. Initially, a video encoder is required to convert input video clips into an action sequence, followed by the use of a decoder to model the relationships between actions.

Self-supervised pre-training. The model capability of supervised learning is always limited by the size of the dataset [28]. In some cases the labeled dataset is too expensive and requires a lot of manpower and material resources, so people have been hoping to construct some self-supervised learning tasks to overcome the limitation of a lack of training data. Masked Autoencoder (MAE) [28] imitates Bert's [15] cloze task to obtain the ability to extract effective features by masking and reconstructing pictures. Similarly VideoMAE [65, 72] reconstructs video through mask and achieved state-of-the-art results on multiple downstream tasks. There are also some other self-supervised pre-training tasks such as self-distillation [6, 49], contrastive learning [10, 29, 48], etc. In this work, we draw on [3, 23] to use the natural timing of the video to train the network and improve the reasoning ability of the network.

3 METHOD

The overall architecture of the ARR model is shown in Fig. 4. It is evident that this is a two-stage approach consisting of action recognition and sequence reasoning. We begin by feeding a sequence of video clips sampled from observed segments into the spatial-temporal encoder. Through action recognition supervision, this process enables the extraction of a feature sequence representing present-action information [4, 76]. Subsequently, this feature sequence is input to the subsequent causal decoder for NAP, facilitating the network's capacity to model the statistical relationships among actions. We will proceed to provide a detailed exposition of each component of the model, along with an introduction to training and implementation details.

3.1 Sequence Modeling

The first step we undertake is to sample video clips from the observed segments and model them as a sequence. Here, we sample T clips at intervals of the anticipation time τ_a . Each clip comprises n frames. Consequently, we obtain a video input V in sequence form. Furthermore, we acquire the action category for each clip based on the original annotations of the dataset. For clips that lack annotations in the original dataset, we label them as unknown action (which will be discussed in the subsequent experimental section). This allows us to acquire action annotation sequences A that correspond one-to-one with the input video clip sequences. We then employ these action annotation sequences as ground truth to provide supervision for subsequent action recognition and NAP tasks.

Modeling the input video as a sequence with strict temporal order is necessary. This necessity arises from the fact that the subsequent causal decoder needs to ensure that when predicting the next action, it exclusively focuses on the preceding action information and can not get information from the future to avoid information leakage. This approach enables robust modeling and representation of the statistical relationships and correlations among various actions. Such a rigorous configuration serves as the foundation for endowing ARR with formidable reasoning capabilities [52].

3.2 Action Recognition from Video Sequence

The input of the network is a video sequence containing T clips, $V = \{C_1, C_2, \dots, C_T\}$, each clip contains n frames, $C = \{F_1, F_2, \dots, F_n\}$. Input V into recognition Net, ϕ , it will process each clip separately, extract a feature z for each clip for subsequent action classification and sent to the sequence reasoning network, the feature sequence can be expressed as $Z = \{z_1, z_2, \dots, z_T\}$ where $z_t = \phi(C_t)$. Similarly, each video clip C_t has a corresponding action label a_t , the action annotation sequence can be expressed as $A = \{a_1, a_2, \dots, a_T\}$, which is in one-to-one correspondence with V .

The encoder part of ARR can use almost all video understanding models [2, 4, 45, 65], and in this work we use AIM [76] as the backbone of our action recognition network to process clip-level

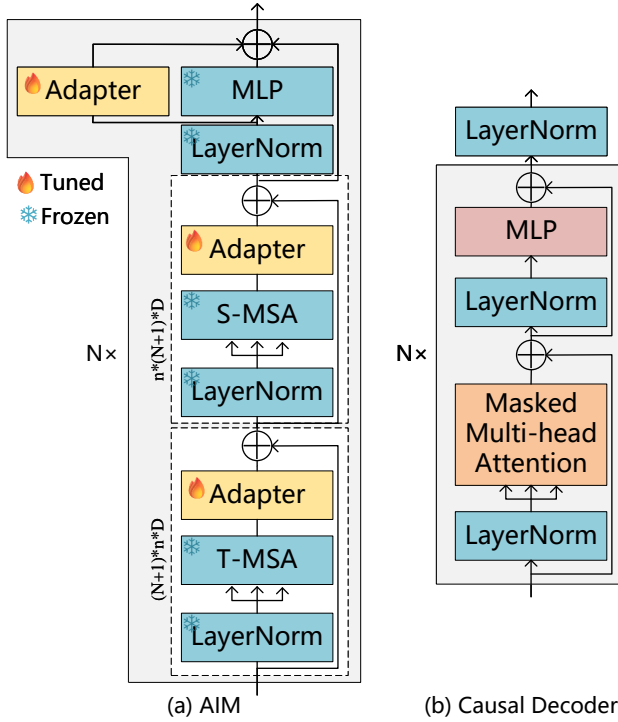

Fig. 5. Architectures of AIM and Causal Decoder. (a) AIM uses vanilla ViT [17] model to initialize the weight of the blue part. Only the Adapter part of the model is trainable during training. (b) This is a standard decoder architecture with masked self-attention, which guarantees that the output is only related to the input before it, all parameters need to be updated during training.

input. The structure of AIM is shown in Fig. 5(a). AIM plugs a temporal processing module on the basis of ViT [17], and achieves equal attention to space and time information through a clever transposition. It has a powerful spatial-temporal modeling ability and performs well in the action recognition task. AIM can easily process input video clips of arbitrary length, and when the input is a single frame, its performance is consistent with ViT, showcasing strong flexibility.

Specifically, a video V containing T clips is input to the encoder. The network independently processes each clip C , where $C \in \mathbb{R}^{n \times H \times W \times C}$, ensuring that their information remains non-interacting. Similar to most video-based models, we segment RGB frames of size 224×224 into non-overlapping patches of 16×16 , these patches are then mapped into tokens of length D , generating N tokens per frame. Additionally, a class token is appended for subsequent classification tasks. Consequently, the input clip C becomes $n \times (N + 1) \times D$ tokens. During temporal modeling, this layout is transposed to $(N + 1) \times n \times D$ for temporal attention. Similarly, for spatial attention, it remains $n \times (N + 1) \times D$. AIM processes these tokens to learn their spatial-temporal information. The final output is the average of n class tokens, representing the clip, which accomplishes subsequent classification tasks and proceeds to the subsequent layers of the network. This yields a feature sequence Z from T input clips, where $Z \in \mathbb{R}^{T \times D}$.

Then, we classify the obtained action feature sequence Z through a linear layer, supervised by the action label sequence A obtained above, and we use the cross-entropy loss to calculate the first part of the action recognition loss:

Algorithm 1: Unsupervised Pre-training for ARR Decoder

Data: Input unlabeled long video V

Result: Decoder ψ

- 1 Sample n frames at regular intervals from V : $f_1, \dots, f_n = \text{Sample}(V)$
 - 2 Use Encoder φ to extract features: $\{z_1, \dots, z_n\} = \varphi(\{f_1, \dots, f_n\})$
 - 3 Use the decoder ψ to predict the next feature: $\{\hat{z}_2, \dots, \hat{z}_{n+1}\} = \psi(\{z_1, \dots, z_n\})$
 - 4 Calculate the loss using MSE loss: $\text{loss} = \sum_{t=2}^n \text{MSE}(\hat{z}_t, z_t)$
 - 5 Compute gradients and update parameters: $\text{loss.backward}(), \text{update}(\psi.\text{params}())$
 - 6 **return** ψ
-

$$\mathcal{L}_{rec} = - \sum_{t=1}^T \log \hat{r}_t[a_t], \quad (1)$$

where \hat{r}_t is the classification result obtained by z_t through the linear layer, and a_t is the ground truth label.

The action recognition loss can ensure that the extracted features pay more attention to the current action information rather than other irrelevant information [55] and is beneficial to the subsequent NAP task [58].

3.3 Sequence Reasoning from Action Feature Sequence

The input to the sequence reasoning network is the previously generated action feature sequence Z , where each z_t represents an action clip. When Z is fed into the sequence reasoning network, ψ , it produces a new sequence P , $P = \{p_1, p_2, \dots, p_T\}$, where $p_t = \psi(z_1, z_2, \dots, z_t)$. We use p_t to predict the next action, which only contains information from the past.

Similarly, the sequence reasoning module here can adapt to most sequence models, such as LSTM [30], GRU [16], etc. Here we use the standard transformer causal decoder [52, 68] based on the masked self-attention mechanism [68]. As shown in Fig. 5(b), the structure of this pure decoder has been proved by many large language models to have a strong sequence reasoning ability through the NTP task, so here we use it as our sequence reasoning module.

The masked self-attention mechanism is the key to the network's ability to predict the future [61]. It uses the observed action information to predict the next action, and effectively models the correlation and statistical relationship between actions. Specifically, our predicted next action feature p_t goes through a linear layer for classification, and uses the next action label a_{t+1} to supervise it, thus obtaining the prediction loss:

$$\mathcal{L}_{pre} = - \sum_{t=1}^T \log \hat{y}_t[a_{t+1}], \quad (2)$$

where \hat{y}_t is the classification result obtained by p_t through the linear layer, and a_{t+1} is the ground truth label, here we also use the cross entropy loss function.

The prediction loss can ensure that our sequence reasoning network focuses on the correct judgment of the next action [55]. This training method enables the enhanced network to learn the correlation between actions, thereby improving the prediction ability [52].

Table 1. Experiments to verify action associations. Three labeling methods were tested for the clips that were not marked at the corresponding time. “Unknown” refers to adding an unknown action that does not exist in the data set to label, “Random” refers to randomly selecting an existent action to label. “Previous” refers to using the previous action to label. length refers to the length of the input sequence. cm Recall refers to class mean Top-5 Recall. The best results are highlighted in **bold**.

Method	Unknown					Random					Previous				
Length	4	6	8	10	12	4	6	8	10	12	4	6	8	10	12
cm Recall	16.04	17.51	19.09	17.93	16.95	15.27	15.64	15.51	16.48	16.19	16.69	16.79	17.38	17.02	17.23

Table 2. Comparison of state-of-the-art methods on the validation set of EK100. All methods only use RGB modality as input to be fair, and the evaluation index is class mean Top-5 Recall. The best results are highlighted in **bold**.

Method	Verb	Noun	Action
RULSTM [20]	27.5	29.0	13.3
TemAgg [58]	23.2	31.4	14.3
AVT [23]	30.2	31.7	14.9
AFFT [79]	\	\	16.1
ARR (Ours)	31.3	32.0	16.3

3.4 Unsupervised Pre-training based on Video

As we all know, the ability of large language models based on causal decoders is not good enough at the beginning [51, 52], and its performance has been improved qualitatively with the large increase in the amount of training data [5, 52]. However, in the task of action anticipation, labeled videos only accounting for a small fraction, most videos are still unlabeled, so we need to find an unsupervised pre-training method to improve network performance. However, the vanilla NTP task cannot be directly applied to video pre-training as video frames are not limited in quantity like words, and we cannot build a vector for each frame to represent it [68, 69].

Drawing on the work [3, 69], we propose a method that leverages the natural timing of videos for unsupervised pre-training. As shown in Algorithm 1, we do not directly predict the next video frame, but predicting the features of the next video frame through a specific encoder. We use the distance loss like *MSE loss* to force the causal decoder to learn a specific representation of the next frame. In this way, the reasoning ability of the decoder can be enhanced. With this unsupervised pre-training method, almost all long videos can be used for training, which greatly expands the scale of trainable data.

3.5 Total Loss

We train ARR end-to-end with the above recognition loss and prediction loss together for supervision:

$$\mathcal{L}_{total} = \mathcal{L}_{rec} + \mathcal{L}_{pre}. \quad (3)$$

The recognition loss and prediction loss here are supervised by the same action label sequence and cross entropy loss, but there is a shift in time, which is the key to the NAP task, noted that the action labeling sequence requires us to pre-process the annotation file of the dataset to obtain.

Table 3. Comparison of state-of-the-art methods on the EGTEA Gaze+. Methods marked with * are averaged across the three official splits, while others are based on split 1 only. Top-1 refers to top1 accuracy, cm Top-1 refers to class mean Top-1 accuracy. cm Top-1 needs to take into account the balance between classes more. The best results are highlighted in **bold**.

Method	Top-1			cm Top-1		
	Verb	Noun	Action	Verb	Noun	Action
I3D-Res50 [8]	48.0	42.1	34.8	31.3	30.0	23.2
FHOI [44]	49.0	45.5	36.6	32.5	32.7	25.3
AVT [23]	54.9	52.2	43.0	49.9	48.3	35.2
AFFT* [79]	53.4	50.4	42.5	42.4	44.5	35.2
ARR (Ours)	53.5	52.1	43.1	47.5	46.3	35.0

4 EXPERIMENTS

4.1 Experimental Setup

This section discusses the experimental related settings, including the datasets used for evaluation and evaluation measures.

Datasets. We conducted experiments on three large-scale datasets: Epic-kitchen-100 (EK100) [14], EGTEA Gaze+ [39], and 50salads [63]. EK100 is an unscripted egocentric action dataset collected from 45 kitchens in four cities worldwide. It includes 100 hours of video content, with 20M frames extracted and annotated with 9K action segments. The dataset comprises 97 verb classes and 300 noun classes, which is the largest dataset in the field of action anticipation tasks. Epic-kitchen also has an early version Epic-kitchen-55 (EK55) [12], which contains 55 hours of video, EK100 contains EK55. The anticipation time in EK100 is set at 1s. EGTEA Gaze+ is an egocentric video dataset containing 10K action annotations, covering 19 verbs, 51 nouns, and 106 unique actions. The anticipation time is set at 0.5s. 50salads is a smaller-scale third-person perspective video dataset, consisting of 0.9K action segments, encompassing 17 different actions, we use it to demonstrate the generality of our method, the anticipation time is set at 1s.

Metrics. Referring to previous work [20, 23, 79], we employ the Top-k metric to evaluate our method, as it fundamentally remains a classification task. That is, if the top-k predictions include the correct ground truth action label, we consider the prediction to be accurate. For categories with a substantial number of classes, such as EK100, we use the class mean Top-5 recall (cm Recall) metric, obtained by averaging the Top-5 recall values across all classes. As observed in prior studies [18, 33], considering the uncertainty of future predictions (i.e., many plausible actions can be taken after observation), this evaluation approach is suitable. Averaging across all categories requires the network to equally prioritize each class, rather than disregarding classes with fewer instances. The task of action anticipation is relatively challenging, and if using Top-1 accuracy on datasets would yield markedly low results, which wouldn't effectively gauge the network's performance. All results in the table are displayed in percentage form, and % is omitted.

4.2 Implementation Details

Similar to most experimental settings in [23, 25, 50], we first change the height of all input RGB images to 256, and then crop them to 224×224 during training. During testing, we utilize a 3-crop approach, wherein we calculate three spatial crops in input frames of size 224. Subsequently, we average the predictions over these three corresponding inputs. In most experiments, 8 clips are sampled at intervals of anticipation time, and each clip contains 4 frames. The encoder part uses the AIM pre-training model. The decoder, as shown in Fig. 5(b), is configured to match the size of

Table 4. Comparison of state-of-the-art methods on 50salads. Because there are few types of actions, the Top-1 accuracy is directly used as the evaluation indicator here. ARR outperforms prior work in 50salads dataset. The best results are highlighted in **bold**.

Method	Top-1
RNN[1]	30.1
CNN[1]	29.8
ActionBanks[60]	40.7
AVT[23]	48.0
ARR (Ours)	49.2

the GPT-2 Small model [52]. Specifically, it comprises 12 Transformer blocks, with 12 heads, and a model dimension of 768. It has a total of approximately 120M parameters and a computational load of 2.3 GFlops. It is initialized using the above-mentioned unsupervised pre-training. We also tried the GPT2 pretrained model, and their depth N is set to 12. We train ARR end-to-end with Adam using $4 * 10^{-5}$ weight decay and 10^{-4} learning rate for 50 epochs, with a 20 epochs warmup [26] and 30 epochs of cosine annealed decay [47]. We set the batch size to 8 and train the model on two 3090 GPU for approximately 50 hours.

4.3 Statistical correlation between actions

Firstly, we conducted experiments to verify the statistical correlations between actions. We directly employed the action annotation sequence A mentioned earlier for validation. Training was performed on sequence A obtained from the training set, and performance testing was carried out on the validation set. The causal decoder mentioned earlier was utilized as the network architecture. After embedding the action labels, they were fed into the network. The evaluation was based on the same class mean Top-5 recall metric as previously mentioned.

It can be seen from Table 1 that only using action sequences for reasoning can achieve good performance, indicating that there is indeed a strong statistical relationship among actions, which verifies our conjecture. The best performance is achieved when the input sequence length is 8 and unknown action class is introduced to populate unannotated segments. Too short and too long input lengths are inappropriate. When the input length is too short, the input information is insufficient to effectively model the potential correlation. When the input length is too long, the correlation between the previous information and the subsequent information is too weak to introduce useless information and increase the amount of calculation, resulting in greater redundancy [64]. This setup is maintained throughout subsequent experiments. It is worth noting that these experiments are only to confirm the statistical correlation between actions and cannot be used to measure ARR network performance for it does not use video input.

4.4 Comparison to the state-of-the-art

EK100. We first compare ARR with previous work [8, 23, 44, 79] on the validation set of EK100, since our input only takes RGB single modality input. For a fair comparison, only those single modality methods are compared. As shown in Table 2, our method achieves the best performance, surpassing the previous best work AVT, also based on the encoder-decoder architecture. The architectures of these models are similar, but our method better models the correlation between actions instead of just recursively predicting some frame or clip-level representations and makes better use of this prior information.

Table 5. Ablations on unsupervised pretraining. We conduct a comparison test on the EK100 validation set, and compare the decoder obtained by our unsupervised pre-training with other methods. “our pretrain” refers to pre-training on the EK100 dataset, which is also the default practice in this paper, “pretrain (on EK100 and K400)” refers to pre-training on the EK100 dataset and K400 [9] dataset. The encoder part uses AIM, and the evaluation indicators are cm Recall. The best results are highlighted in **bold**.

Decoder	Verb	Noun	Action
GPT2 [52]	30.8	32.1	16.0
w/o pretrain	27.9	29.6	14.1
our pretrain	31.3	32.0	16.3
pretrain (on EK100 and K400)	31.6	32.3	16.5

It can be seen that the performance of our method is approaching the results in Table 1. Although the action recognition part will cause some performance differences, there are some additional scene information in the video that we can capture to make up for part of the gap.

EGTEA Gaze+. Next we evaluate our method on EGTEA Gaze+, as shown in Table 3. Following previous work [20], we set the expected time τ_a to be 0.5s. It can be seen that our method can also achieve good performance in different anticipation time settings, which proves that our method is robust and can be used in a variety of anticipation task settings. Because the number of action categories is small, we report the Top-1 accuracy and class mean Top-1 accuracy respectively, the latter is averaged between each category regardless of the number of samples in each category, requiring the network to pay equal attention to each category instead of ignoring those classes with a small number of samples.

50salads. Finally, we show that ARR is not limited to first-person videos, but also works in third-person videos. In contrast to first-person videos that primarily focus on the hand area, in third-person videos, the person’s body is also largely visible. We report Top-1 accuracy averaged over the pre-defined 5 splits following prior work [60] in Table 4, because 50salads has a small number of action categories, this indicator can be used for evaluation. We can see that our method outperforms previous methods and can achieve an accuracy close to 50%, demonstrating the generality of our method.

4.5 Ablations and Analysis

The effect of unsupervised pre-training. We first investigated whether our proposed unsupervised pretraining method using the natural temporal order of videos is effective for the causal decoder. We employed the ARR architecture, where the action recognition network utilized ARR. The sequence inference networks were implemented with three different decoders: GPT2 decoder, randomly initialized decoder, and the decoder obtained through our method. We compared their performance on the EK100 validation dataset.

As shown in Table 5, we can see that our method achieves the best results. GPT2 [52] is a large language model that uses text pre-training and is also used in reasoning networks for other work. It has been proven to have a strong reasoning ability. The method of random initialization has poor performance, which is very reasonable, because it is difficult to obtain good performance directly through fine-tuning for a large-scale network without large-scale pre-training [28]. Our method uses video data for pre-training, although there are not as many training data as GPT2, but the performance is comparable or even slightly exceeded. We guess that the performance of GPT2 may not be fully utilized because of the domain gap between text pre-training and video pre-training. In other words, the result can prove the effectiveness of our unsupervised pre-training method.

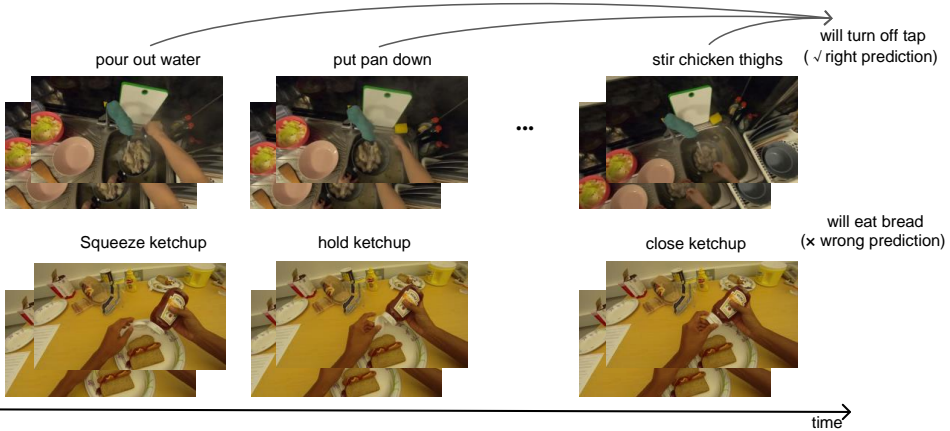

Fig. 6. Schematic diagram of inference process. ARR first judges the current action, and then judges the actions that may occur next according to the current action sequence. We demonstrate one correct inference and one incorrect inference.

Table 6. Ablations on different encoders. We conduct a comparison test on the EK100 validation set. The decoder part uses GPT2, and the evaluation indicators are cm Recall.

encoder	Verb	Noun	Action
Timesformer [4]	30.8	31.9	16.0
Vivit [2]	30.5	31.4	15.8
VideoMAE [65]	31.0	32.0	16.1
AIM [76]	31.3	32.0	16.3

Table 7. Effect of clip length on performance. We explored the impact of the length of a single clip on the performance of the model. We compared the performance on the EK100 verification set.

Num_frames	1	2	4	6	8
cm Recall	14.8	15.2	16.3	16.5	16.8

In addition, we further expanded the size of the pre-training data. It can be seen that when the size of the pre-training data is expanded from the EK100 dataset to the EK100 dataset and the K400 dataset [9], the performance of the network is further improved, which shows that our pre-training method can make the performance of the decoder further improves with the increase of pre-training data, demonstrating the scaling potential of our unsupervised pre-training method.

The effect of different encoders. As shown in Table 6, we use different action recognition networks as encoders to verify the effectiveness of our ARR architecture. It can be seen that the performance of using these mainstream action recognition networks as encoders is very good. Among them, using AIM as the encoder has the best performance, and only needs to adjust the parameters of the adapter part, so in this work we use AIM as the encoder by default.

Clip Length. In Table 7, we explore the impact of the number of frames contained in a single clip in the input video sequence on performance. It can be seen that as the number of frames increases, the performance of the network gradually improves. This is easy to understand. In the action classification task, as the number of input frames increases, the performance of the network will also improve. However, it can be seen that when the number of frames exceeds 4, the

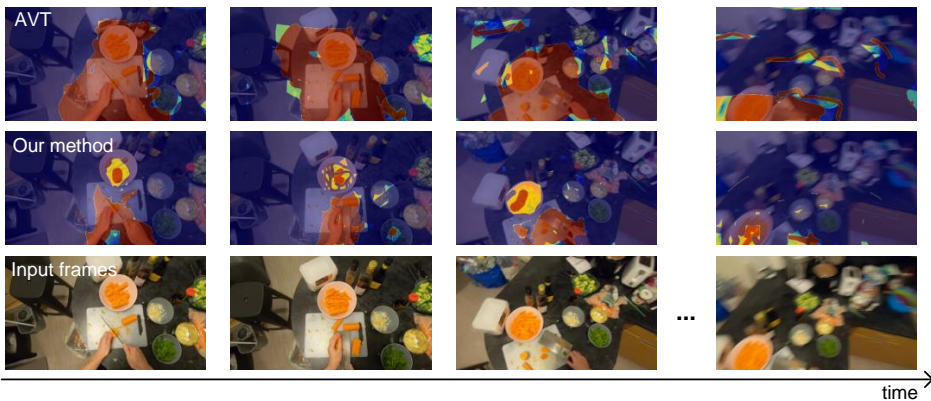

Fig. 7. Attention visualization. ARR is able to automatically focus on regions that are more relevant to actions and the scope is more precise.

performance improvement is not so obvious. In consideration of the tradeoffs between performance and calculation, we use 4 frames as the length of the clip in most experiments.

Predicting Next Action. As shown in Fig. 6, we show the inference process of ARR. ARR will recognize the current action based on the current action state, first “pour out water”, then “put pan down”, “stir chicken thighs”, ARR will judge that the next action is “turn off tap” based on the existing action state combined with the correlation between the actions it has learned. Thus, this way of reasoning is consistent with what we expected.

However, this inference mode will also bring some errors. When the actions are too dense, ARR will make wrong judgments, as shown in the bottom part of Fig. 6. The true label is to continue to “close ketchup”, while the prediction given by ARR is “eat bread”. ARR tends to be judged based on experience, but it is easy to ignore the speed of the action.

Visualization. We analyze models’ visual attention of the last layer of the encoder on the EK100 dataset to qualitatively evaluate the effectiveness of learnable spatio-temporal representation. As shown in Fig. 7, it is clear that through the supervision of the action recognition task, the network can automatically focus on the areas that are more relevant to the current action (usually the hand area). Although there are many objects in the frame, the model still learns to pay more attention to the objects related to the current action instead of others irrelevant. Compared to other methods, our focus areas are also more precise and specific.

5 CONCLUSIONS

We proposed ARR, an end-to-end video modeling architecture based on attention mechanisms. By decomposing the action anticipation task into action recognition and sequence reasoning tasks, we constructed predicting the next action through a temporal shifting supervision, which effectively modeled and learned the underlying relationships among actions and achieved competitive results on multiple datasets. Our proposed method of utilizing the natural temporal order of videos for unsupervised pre-training also resolved the problem of NAP requiring large number of training data. We hope to continue to explore unsupervised training methods related to action anticipation in the future.

6 ACKNOWLEDGMENTS

This work was supported in part by the National Natural Science Foundation of China under Grant 62171309 and 62306061, Guangdong Basic and Applied Basic Research Foundation (Grant

No. 2023A1515140037), and Open Fund of National Engineering Laboratory for Big Data System Computing Technology (Grant No. SZU-BDSC-OF2024-02).

REFERENCES

- [1] Yazan Abu Farha, Alexander Richard, and Juergen Gall. 2018. When will you do what?-anticipating temporal occurrences of activities. In *Proceedings of the IEEE conference on computer vision and pattern recognition*. 5343–5352.
- [2] Anurag Arnab, Mostafa Dehghani, Georg Heigold, Chen Sun, Mario Lučić, and Cordelia Schmid. 2021. Vivit: A video vision transformer. In *Proceedings of the IEEE/CVF international conference on computer vision*. 6836–6846.
- [3] Mahmoud Assran, Quentin Duval, Ishan Misra, Piotr Bojanowski, Pascal Vincent, Michael Rabbat, Yann LeCun, and Nicolas Ballas. 2023. Self-supervised learning from images with a joint-embedding predictive architecture. In *Proceedings of the IEEE/CVF Conference on Computer Vision and Pattern Recognition*. 15619–15629.
- [4] Gedas Bertasius, Heng Wang, and Lorenzo Torresani. 2021. Is space-time attention all you need for video understanding?. In *ICML*, Vol. 2. 4.
- [5] Tom Brown, Benjamin Mann, Nick Ryder, Melanie Subbiah, Jared D Kaplan, Prafulla Dhariwal, Arvind Neelakantan, Pranav Shyam, Girish Sastry, Amanda Askell, et al. 2020. Language models are few-shot learners. *Advances in neural information processing systems* 33 (2020), 1877–1901.
- [6] Mathilde Caron, Hugo Touvron, Ishan Misra, Hervé Jégou, Julien Mairal, Piotr Bojanowski, and Armand Joulin. 2021. Emerging properties in self-supervised vision transformers. In *Proceedings of the IEEE/CVF international conference on computer vision*. 9650–9660.
- [7] Joao Carreira and Andrew Zisserman. 2017. Quo vadis, action recognition? a new model and the kinetics dataset. In *proceedings of the IEEE Conference on Computer Vision and Pattern Recognition*. 6299–6308.
- [8] Joao Carreira and Andrew Zisserman. 2017. Quo vadis, action recognition? a new model and the kinetics dataset. In *proceedings of the IEEE Conference on Computer Vision and Pattern Recognition*. 6299–6308.
- [9] Joao Carreira and Andrew Zisserman. 2017. Quo vadis, action recognition? a new model and the kinetics dataset. In *proceedings of the IEEE Conference on Computer Vision and Pattern Recognition*. 6299–6308.
- [10] Ting Chen, Simon Kornblith, Mohammad Norouzi, and Geoffrey Hinton. 2020. A simple framework for contrastive learning of visual representations. In *International conference on machine learning*. PMLR, 1597–1607.
- [11] Aakanksha Chowdhery, Sharan Narang, Jacob Devlin, Maarten Bosma, Gaurav Mishra, Adam Roberts, Paul Barham, Hyung Won Chung, Charles Sutton, Sebastian Gehrmann, et al. 2022. Palm: Scaling language modeling with pathways. *arXiv preprint arXiv:2204.02311* (2022).
- [12] Dima Damen, Hazel Doughty, Giovanni Maria Farinella, Sanja Fidler, Antonino Furnari, Evangelos Kazakos, Davide Moltisanti, Jonathan Munro, Toby Perrett, Will Price, and Michael Wray. 2018. Scaling Egocentric Vision: The EPIC-KITCHENS Dataset. In *European Conference on Computer Vision (ECCV)*.
- [13] Dima Damen, Hazel Doughty, Giovanni Maria Farinella, Sanja Fidler, Antonino Furnari, Evangelos Kazakos, Davide Moltisanti, Jonathan Munro, Toby Perrett, Will Price, and Michael Wray. 2021. The EPIC-KITCHENS Dataset: Collection, Challenges and Baselines. *IEEE Transactions on Pattern Analysis and Machine Intelligence (TPAMI)* 43, 11 (2021), 4125–4141. <https://doi.org/10.1109/TPAMI.2020.2991965>
- [14] Dima Damen, Hazel Doughty, Giovanni Maria Farinella, Antonino Furnari, Evangelos Kazakos, Jian Ma, Davide Moltisanti, Jonathan Munro, Toby Perrett, Will Price, et al. 2022. Rescaling egocentric vision: Collection, pipeline and challenges for epic-kitchens-100. *International Journal of Computer Vision* (2022), 1–23.
- [15] Jacob Devlin, Ming-Wei Chang, Kenton Lee, and Kristina Toutanova. 2018. Bert: Pre-training of deep bidirectional transformers for language understanding. *arXiv preprint arXiv:1810.04805* (2018).
- [16] Rahul Dey and Fathi M Salem. 2017. Gate-variants of gated recurrent unit (GRU) neural networks. In *2017 IEEE 60th international midwest symposium on circuits and systems (MWSCAS)*. IEEE, 1597–1600.
- [17] Alexey Dosovitskiy, Lucas Beyer, Alexander Kolesnikov, Dirk Weissenborn, Xiaohua Zhai, Thomas Unterthiner, Mostafa Dehghani, Matthias Minderer, Georg Heigold, Sylvain Gelly, et al. 2020. An image is worth 16x16 words: Transformers for image recognition at scale. *arXiv preprint arXiv:2010.11929* (2020).

- [18] Antonino Furnari, Sebastiano Battiato, and Giovanni Maria Farinella. 2018. Leveraging uncertainty to rethink loss functions and evaluation measures for egocentric action anticipation. In *Proceedings of the European Conference on Computer Vision (ECCV) Workshops*. 0–0.
- [19] Antonino Furnari and Giovanni Maria Farinella. 2019. What would you expect? anticipating egocentric actions with rolling-unrolling lstms and modality attention. In *Proceedings of the IEEE/CVF International Conference on Computer Vision*. 6252–6261.
- [20] Antonino Furnari and Giovanni Maria Farinella. 2020. Rolling-unrolling lstms for action anticipation from first-person video. *IEEE transactions on pattern analysis and machine intelligence* 43, 11 (2020), 4021–4036.
- [21] Harshala Gammulle, Simon Denman, Sridha Sridharan, and Clinton Fookes. 2019. Predicting the future: A jointly learnt model for action anticipation. In *Proceedings of the IEEE/CVF International Conference on Computer Vision*. 5562–5571.
- [22] Rohit Girdhar, Joao Carreira, Carl Doersch, and Andrew Zisserman. 2019. Video action transformer network. In *Proceedings of the IEEE/CVF conference on computer vision and pattern recognition*. 244–253.
- [23] Rohit Girdhar and Kristen Grauman. 2021. Anticipative video transformer. In *Proceedings of the IEEE/CVF international conference on computer vision*. 13505–13515.
- [24] Rohit Girdhar, Deva Ramanan, Abhinav Gupta, Josef Sivic, and Bryan Russell. 2017. Actionvlad: Learning spatio-temporal aggregation for action classification. In *Proceedings of the IEEE conference on computer vision and pattern recognition*. 971–980.
- [25] Rohit Girdhar, Mannat Singh, Nikhila Ravi, Laurens van der Maaten, Armand Joulin, and Ishan Misra. 2022. Omnivore: A single model for many visual modalities. In *Proceedings of the IEEE/CVF Conference on Computer Vision and Pattern Recognition*. 16102–16112.
- [26] Priya Goyal, Piotr Dollár, Ross Girshick, Pieter Noordhuis, Lukasz Wesolowski, Aapo Kyrola, Andrew Tulloch, Yangqing Jia, and Kaiming He. 2017. Accurate, large minibatch sgd: Training imagenet in 1 hour. *arXiv preprint arXiv:1706.02677* (2017).
- [27] Chao Hao, Zitong Yu, Xin Liu, Jun Xu, Huanjing Yue, and Jingyu Yang. 2024. A Simple yet Effective Network based on Vision Transformer for Camouflaged Object and Salient Object Detection. *arXiv preprint arXiv:2402.18922* (2024).
- [28] Kaiming He, Xinlei Chen, Saining Xie, Yanghao Li, Piotr Dollár, and Ross Girshick. 2022. Masked autoencoders are scalable vision learners. In *Proceedings of the IEEE/CVF conference on computer vision and pattern recognition*. 16000–16009.
- [29] Kaiming He, Haoqi Fan, Yuxin Wu, Saining Xie, and Ross Girshick. 2020. Momentum contrast for unsupervised visual representation learning. In *Proceedings of the IEEE/CVF conference on computer vision and pattern recognition*. 9729–9738.
- [30] Sepp Hochreiter and Jürgen Schmidhuber. 1997. Long short-term memory. *Neural computation* 9, 8 (1997), 1735–1780.
- [31] Andrej Karpathy, George Toderici, Sanketh Shetty, Thomas Leung, Rahul Sukthankar, and Li Fei-Fei. 2014. Large-scale video classification with convolutional neural networks. In *Proceedings of the IEEE conference on Computer Vision and Pattern Recognition*. 1725–1732.
- [32] Andrej Karpathy, George Toderici, Sanketh Shetty, Thomas Leung, Rahul Sukthankar, and Li Fei-Fei. 2014. Large-scale video classification with convolutional neural networks. In *Proceedings of the IEEE conference on Computer Vision and Pattern Recognition*. 1725–1732.
- [33] Hema S Koppula and Ashutosh Saxena. 2015. Anticipating human activities using object affordances for reactive robotic response. *IEEE transactions on pattern analysis and machine intelligence* 38, 1 (2015), 14–29.
- [34] Alex Krizhevsky, Ilya Sutskever, and Geoffrey E Hinton. 2012. Imagenet classification with deep convolutional neural networks. *Advances in neural information processing systems* 25 (2012).
- [35] Ivan Laptev. 2005. On space-time interest points. *International journal of computer vision* 64 (2005), 107–123.
- [36] Ivan Laptev, Marcin Marszalek, Cordelia Schmid, and Benjamin Rozenfeld. 2008. Learning realistic human actions from movies. In *2008 IEEE Conference on Computer Vision and Pattern Recognition*. IEEE, 1–8.
- [37] Kunchang Li, Yali Wang, Yinan He, Yizhuo Li, Yi Wang, Limin Wang, and Yu Qiao. 2022. Uniformerv2: Spatiotemporal learning by arming image vits with video uniformer. *arXiv preprint arXiv:2211.09552* (2022).

- [38] Kunchang Li, Yali Wang, Yizhuo Li, Yi Wang, Yinan He, Limin Wang, and Yu Qiao. 2023. Unmasked teacher: Towards training-efficient video foundation models. *arXiv preprint arXiv:2303.16058* (2023).
- [39] Yin Li, Miao Liu, and James M Rehg. 2018. In the eye of beholder: Joint learning of gaze and actions in first person video. In *Proceedings of the European conference on computer vision (ECCV)*. 619–635.
- [40] Junwei Liang. 2020. From Recognition to Prediction: Analysis of Human Action and Trajectory Prediction in Video. *arXiv preprint arXiv:2011.10670* (2020).
- [41] Junwei Liang, Lu Jiang, Juan Carlos Niebles, Alexander G Hauptmann, and Li Fei-Fei. 2019. Peeking into the future: Predicting future person activities and locations in videos. In *Proceedings of the IEEE/CVF conference on computer vision and pattern recognition*. 5725–5734.
- [42] Shuang Liang, Wentao Ma, and Chi Xie. 2023. Relation with Free Objects for Action Recognition. *ACM Transactions on Multimedia Computing, Communications and Applications* 20, 2 (2023), 1–19.
- [43] Ji Lin, Chuang Gan, and Song Han. 2019. Tsm: Temporal shift module for efficient video understanding. In *Proceedings of the IEEE/CVF international conference on computer vision*. 7083–7093.
- [44] Miao Liu, Siyu Tang, Yin Li, and James M Rehg. 2020. Forecasting human-object interaction: joint prediction of motor attention and actions in first person video. In *Computer Vision—ECCV 2020: 16th European Conference, Glasgow, UK, August 23–28, 2020, Proceedings, Part I 16*. Springer, 704–721.
- [45] Ze Liu, Jia Ning, Yue Cao, Yixuan Wei, Zheng Zhang, Stephen Lin, and Han Hu. 2022. Video swin transformer. In *Proceedings of the IEEE conference on computer vision and pattern recognition*. 3202–3211.
- [46] Xiang Long, Chuang Gan, Gerard De Melo, Jiajun Wu, Xiao Liu, and Shilei Wen. 2018. Attention clusters: Purely attention based local feature integration for video classification. In *Proceedings of the IEEE conference on computer vision and pattern recognition*. 7834–7843.
- [47] Ilya Loshchilov and Frank Hutter. 2016. Sgdr: Stochastic gradient descent with warm restarts. *arXiv preprint arXiv:1608.03983* (2016).
- [48] Aaron van den Oord, Yazhe Li, and Oriol Vinyals. 2018. Representation learning with contrastive predictive coding. *arXiv preprint arXiv:1807.03748* (2018).
- [49] Maxime Oquab, Timothée Darcet, Théo Moutakanni, Huy Vo, Marc Szafraniec, Vasil Khalidov, Pierre Fernandez, Daniel Haziza, Francisco Massa, Alaaeldin El-Nouby, et al. 2023. Dinov2: Learning robust visual features without supervision. *arXiv preprint arXiv:2304.07193* (2023).
- [50] Mandela Patrick, Dylan Campbell, Yuki Asano, Ishan Misra, Florian Metze, Christoph Feichtenhofer, Andrea Vedaldi, and Joao F Henriques. 2021. Keeping your eye on the ball: Trajectory attention in video transformers. *Advances in neural information processing systems* 34 (2021), 12493–12506.
- [51] Alec Radford, Karthik Narasimhan, Tim Salimans, Ilya Sutskever, et al. 2018. Improving language understanding by generative pre-training. (2018).
- [52] Alec Radford, Jeffrey Wu, Rewon Child, David Luan, Dario Amodei, Ilya Sutskever, et al. 2019. Language models are unsupervised multitask learners. *OpenAI blog* 1, 8 (2019), 9.
- [53] Jack W Rae, Sebastian Borgeaud, Trevor Cai, Katie Millican, Jordan Hoffmann, Francis Song, John Aslanides, Sarah Henderson, Roman Ring, Susannah Young, et al. 2021. Scaling language models: Methods, analysis & insights from training gopher. *arXiv preprint arXiv:2112.11446* (2021).
- [54] Nicholas Rhinehart and Kris M Kitani. 2017. First-person activity forecasting with online inverse reinforcement learning. In *Proceedings of the IEEE International Conference on Computer Vision*. 3696–3705.
- [55] Debaditya Roy and Basura Fernando. 2022. Predicting the next action by modeling the abstract goal. *arXiv preprint arXiv:2209.05044* (2022).
- [56] Debaditya Roy, Ramanathan Rajendiran, and Basura Fernando. 2024. Interaction Region Visual Transformer for Egocentric Action Anticipation. In *Proceedings of the IEEE/CVF Winter Conference on Applications of Computer Vision*. 6740–6750.
- [57] Teven Le Scao, Angela Fan, Christopher Akiki, Ellie Pavlick, Suzana Ilić, Daniel Hesslow, Roman Castagné, Alexandra Sasha Luccioni, François Yvon, Matthias Gallé, et al. 2022. Bloom: A 176b-parameter open-access multilingual language model. *arXiv preprint arXiv:2211.05100* (2022).

- [58] Fadime Sener, Dibyadip Chatterjee, and Angela Yao. 2021. Technical report: Temporal aggregate representations. *arXiv preprint arXiv:2106.03152* (2021).
- [59] Fadime Sener, Dipika Singhania, and Angela Yao. 2020. Temporal aggregate representations for long-range video understanding. In *Computer Vision—ECCV 2020: 16th European Conference, Glasgow, UK, August 23–28, 2020, Proceedings, Part XVI 16*. Springer, 154–171.
- [60] Fadime Sener, Dipika Singhania, and Angela Yao. 2020. Temporal aggregate representations for long-range video understanding. In *Computer Vision—ECCV 2020: 16th European Conference, Glasgow, UK, August 23–28, 2020, Proceedings, Part XVI 16*. Springer, 154–171.
- [61] Buck Shlegeris, Fabien Roger, Lawrence Chan, and Euan McLean. 2022. Language models are better than humans at next-token prediction. *arXiv preprint arXiv:2212.11281* (2022).
- [62] Karen Simonyan and Andrew Zisserman. 2014. Two-stream convolutional networks for action recognition in videos. *Advances in neural information processing systems* 27 (2014).
- [63] Sebastian Stein and Stephen J McKenna. 2013. Combining embedded accelerometers with computer vision for recognizing food preparation activities. In *Proceedings of the 2013 ACM international joint conference on Pervasive and ubiquitous computing*. 729–738.
- [64] Romal Thoppilan, Daniel De Freitas, Jamie Hall, Noam Shazeer, Apoorv Kulshreshtha, Heng-Tze Cheng, Alicia Jin, Taylor Bos, Leslie Baker, Yu Du, et al. 2022. Lamda: Language models for dialog applications. *arXiv preprint arXiv:2201.08239* (2022).
- [65] Zhan Tong, Yibing Song, Jue Wang, and Limin Wang. 2022. Videomae: Masked autoencoders are data-efficient learners for self-supervised video pre-training. *Advances in neural information processing systems* 35 (2022), 10078–10093.
- [66] Hugo Touvron, Thibaut Lavril, Gautier Izacard, Xavier Martinet, Marie-Anne Lachaux, Timothée Lacroix, Baptiste Rozière, Naman Goyal, Eric Hambro, Faisal Azhar, et al. 2023. Llama: Open and efficient foundation language models. *arXiv preprint arXiv:2302.13971* (2023).
- [67] Du Tran, Lubomir Bourdev, Rob Fergus, Lorenzo Torresani, and Manohar Paluri. 2015. Learning spatiotemporal features with 3d convolutional networks. In *Proceedings of the IEEE international conference on computer vision*. 4489–4497.
- [68] Ashish Vaswani, Noam Shazeer, Niki Parmar, Jakob Uszkoreit, Llion Jones, Aidan N Gomez, Łukasz Kaiser, and Illia Polosukhin. 2017. Attention is all you need. *Advances in neural information processing systems* 30 (2017).
- [69] Carl Vondrick, Hamed Pirsiavash, and Antonio Torralba. 2016. Anticipating visual representations from unlabeled video. In *Proceedings of the IEEE conference on computer vision and pattern recognition*. 98–106.
- [70] Heng Wang, Alexander Kläser, Cordelia Schmid, and Cheng-Lin Liu. 2013. Dense trajectories and motion boundary descriptors for action recognition. *International journal of computer vision* 103 (2013), 60–79.
- [71] Haoran Wang, Yajie Wang, Baosheng Yu, Yibing Zhan, Chunfeng Yuan, and Wankou Yang. 2023. Attentional Composition Networks for Long-Tailed Human Action Recognition. *ACM Transactions on Multimedia Computing, Communications and Applications* (2023).
- [72] Limin Wang, Bingkun Huang, Zhiyu Zhao, Zhan Tong, Yinan He, Yi Wang, Yali Wang, and Yu Qiao. 2023. Videomae v2: Scaling video masked autoencoders with dual masking. In *Proceedings of the IEEE/CVF Conference on Computer Vision and Pattern Recognition*. 14549–14560.
- [73] Yi Wang, Kunchang Li, Yizhuo Li, Yinan He, Bingkun Huang, Zhiyu Zhao, Hongjie Zhang, Jilan Xu, Yi Liu, Zun Wang, et al. 2022. Internvideo: General video foundation models via generative and discriminative learning. *arXiv preprint arXiv:2212.03191* (2022).
- [74] Chao-Yuan Wu, Yanghao Li, Karttikeya Mangalam, Haoqi Fan, Bo Xiong, Jitendra Malik, and Christoph Feichtenhofer. 2022. Memvit: Memory-augmented multiscale vision transformer for efficient long-term video recognition. In *Proceedings of the IEEE/CVF Conference on Computer Vision and Pattern Recognition*. 13587–13597.
- [75] Chi Xie, Zikun Zhuang, Shengjie Zhao, and Shuang Liang. 2023. Temporal Dropout for Weakly Supervised Action Localization. *ACM Transactions on Multimedia Computing, Communications and Applications* 19, 3 (2023), 1–24.
- [76] Taojiannan Yang, Yi Zhu, Yusheng Xie, Aston Zhang, Chen Chen, and Mu Li. 2023. Aim: Adapting image models for efficient video action recognition. *arXiv preprint arXiv:2302.03024* (2023).

- [77] Susan Zhang, Stephen Roller, Naman Goyal, Mikel Artetxe, Moya Chen, Shuohui Chen, Christopher Dewan, Mona Diab, Xian Li, Xi Victoria Lin, et al. 2022. Opt: Open pre-trained transformer language models. *arXiv preprint arXiv:2205.01068* (2022).
- [78] Na Zheng, Xuemeng Song, Tianyu Su, Weifeng Liu, Yan Yan, and Liqiang Nie. 2023. Egocentric Early Action Prediction via Adversarial Knowledge Distillation. *ACM Transactions on Multimedia Computing, Communications and Applications* 19, 2 (2023), 1–21.
- [79] Zeyun Zhong, David Schneider, Michael Voit, Rainer Stiefelhagen, and Jürgen Beyerer. 2023. Anticipative feature fusion transformer for multi-modal action anticipation. In *Proceedings of the IEEE/CVF Winter Conference on Applications of Computer Vision*. 6068–6077.
- [80] Suguo Zhu, Xiaoxian Yang, Jun Yu, Zhenying Fang, Meng Wang, and Qingming Huang. 2020. Proposal complementary action detection. *ACM Transactions on Multimedia Computing, Communications, and Applications (TOMM)* 16, 2s (2020), 1–12.

Received 20 February 2007; revised 12 March 2009; accepted 5 June 2009