

# Development of a Mouse for Individuals without Upper Limbs using Arduino Technology

Alfonso Gunsha-Morales  
*Facultad de Ciencias de la Ingeniería*  
*Universidad Técnica Estatal de Quevedo*  
Quevedo-Ecuador  
0000-0002-1485-1522

Pedro Pardo  
*Carrera de Telecomunicaciones*  
*Instituto Superior Tecnológico Huaquillas*  
Huaquillas-Ecuador  
pardopedro46@gmail.com

Luis Enrique Chuquimarca Jimenez  
*FACSISTEL*  
*Universidad Peninsula de Santa Elena*  
La libertad-Ecuador  
0000-0003-3296-4309

David Herrera  
*Carrera de Telecomunicaciones*  
*Instituto Superior Tecnológico Huaquillas*  
Huaquillas-Ecuador  
jdherreira@isthuaquillas.edu.ec

**Abstract – This project focuses on the design and construction of a prototype mouse based on the Arduino platform, intended for individuals without upper limbs to use computers more effectively. The prototype comprises a microcontroller responsible for processing signals from the MPU-6050 sensor, used as a reference for cursor position, and foot-operated buttons for right and left-click functions. Its design enables cursor control through head movements, providing users with an easy and intuitive way to interact with the computer's graphical interface. Feasibility testing was conducted through experimental trials, resulting in ideal accuracy and precision. These trials indicate that the device is viable for use in individuals without upper limbs.**

## I. INTRODUCTION

The use of Information and Communication Technologies (ICT) is prevalent in personal, professional, and educational domains, offering various services to users. Common applications include information retrieval, new forms of communication, virtual learning, online banking, and e-commerce. Individuals with disabilities who face physical limitations hindering their access to ICT often experience a lack of digital skills, preventing them from acquiring knowledge, developing skills, and competing in the job market [1].

Many disabled individuals without upper limbs often refrain from using computers due to difficulties in using the peripherals

designed for control. Market alternatives are either scarce or come at a high cost [2].

Hence, there is a pertinent need for the development of devices that cater to the specific needs of individuals with special abilities, enabling them to manipulate ICT and access the benefits offered by these technologies [3].

This is why the investigation into the implementation of an economically accessible mouse becomes relevant. Such a mouse would allow individuals without upper limbs to use their head and feet for navigating the graphical interface of an operating system and interacting with various programs in a way that is easy and interactive for the user.

Section 2 details the methodology applied in the development of this work, covering both hardware and software designs, along with system implementation and testing. Section 3 presents the results with detailed analysis, while Section 4 contains the conclusions derived from integrating these findings with the initial objectives of the project.

## II. METHODOLOGY

First, an analysis of the operation of a conventional mouse was conducted to transfer the same functions and adapt them to the needs of individuals without upper limbs [4] [5] [6]. The prototype is a wired mouse that allows cursor movement

979-8-3503-2820-2/\$31.00 ©2024 IEEE

© 2024 IEEE. Personal use of this material is permitted. Permission from IEEE must be obtained for all other uses, in any current or future media, including reprinting/republishing this material for advertising or promotional purposes, creating new collective works, for resale or redistribution to servers or lists, or reuse of any copyrighted component of this work in other works.

DOI: <https://doi.org/10.1109/10493246>

through head gestures and performs right and left-click functions using foot-operated pedals [7] [8] [9].

Subsequently, the prototype was manufactured by completing the final assembly of the electronic circuit on perforated microbakelite. Experimental tests were then conducted with the accelerometer of the MPU-6050 sensor incorporated into the GY-521 module [10] [11], connected to the Arduino Leonardo platform along with two pedal-operated buttons, implementing the configuration of 2 pull-down resistors [12] (see Figure 1).

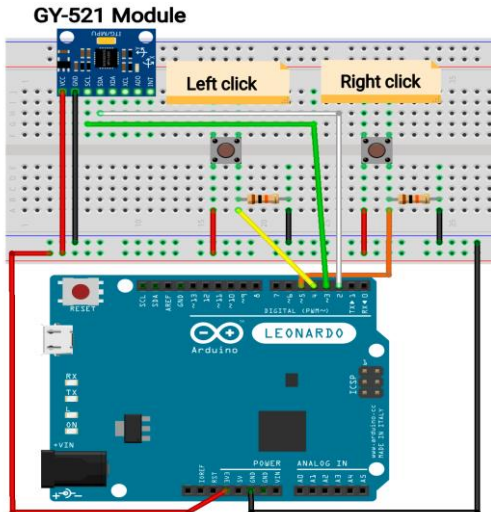

Figure 1. Diagram of the prototype.

#### A. Hardware design

The protective casing of the Arduino features: a USB cable used for connection to a computer, a diagnostic indicator system allowing the user to monitor the operational status of the prototype, and 2 female USB ports for accessories A and B [13].

#### Protective Casing of the Arduino

Figure 2 provides an interior view of the protective casing of the implemented prototype, showcasing the perforated microboard connected to the Arduino with USB ports. These ports facilitate communication between the Arduino Leonardo board, the GY-521 Module, and the foot-operated pedal buttons [14].

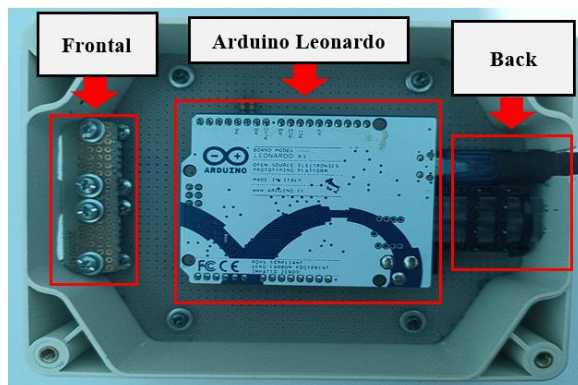

Figure 2. Interior view of the protective casing of the Arduino-based air mouse prototype.

979-8-3503-2820-2/\$31.00 ©2024 IEEE

© 2024 IEEE. Personal use of this material is permitted. Permission from IEEE must be obtained for all other uses, in any current or future media, including reprinting/republishing this material for advertising or promotional purposes, creating new collective works, for resale or redistribution to servers or lists, or reuse of any copyrighted component of this work in other works.

DOI: <https://doi.org/10.1109/10493246>

On the front side of the protective casing, there are USB ports that grant access to connectors for accessories A (device for cursor movement) and B (pedals for right and left-click), as depicted in Figure 3.

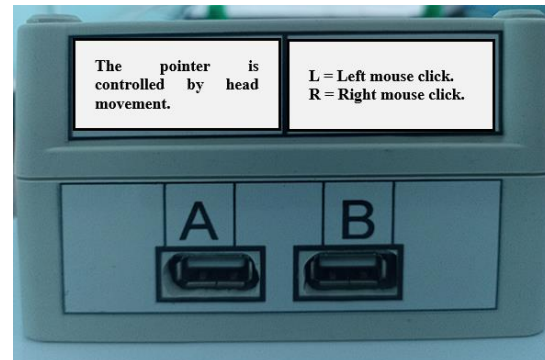

Figure 3. Front view of the protective casing of the mouse prototype for individuals without upper limbs.

At the back of the protective casing, indicators for the device's operational status and the USB cable used for computer connection are located, as shown in Figure 4.



Figure 4. Rear view of the protective casing of the mouse prototype for individuals without upper limbs.

#### Accessory A

This accessory consists of an elastic band designed to be worn on the head. It includes a small transparent plastic box containing the GY-521 Module [15]. The letter A serves as an identifier for the USB port connection to the prototype. This accessory is illustrated in Figure 5.

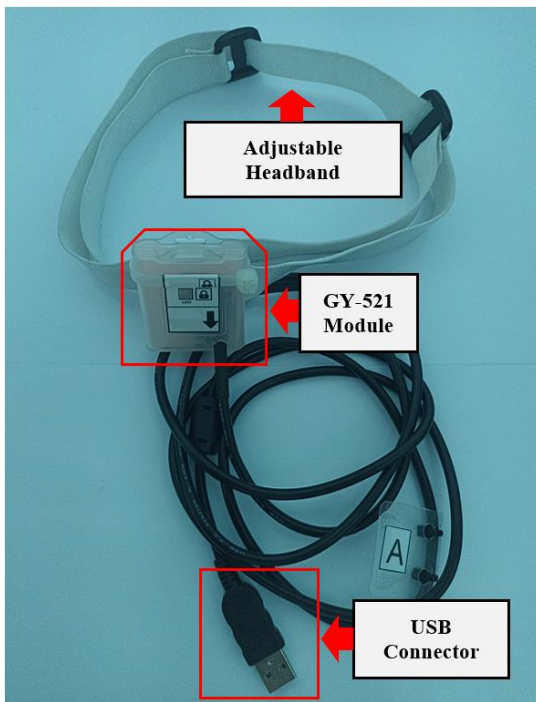

Figure 5. Accessory A that enables pointer movement.

### Accessory B

This accessory comprises 2 pedal-shaped buttons [16]. The letters L and R serve as identifiers for left and right-click functions, respectively, while the letter B identifies the USB cable connection to the corresponding port on the prototype. This accessory is depicted in Figure 6.

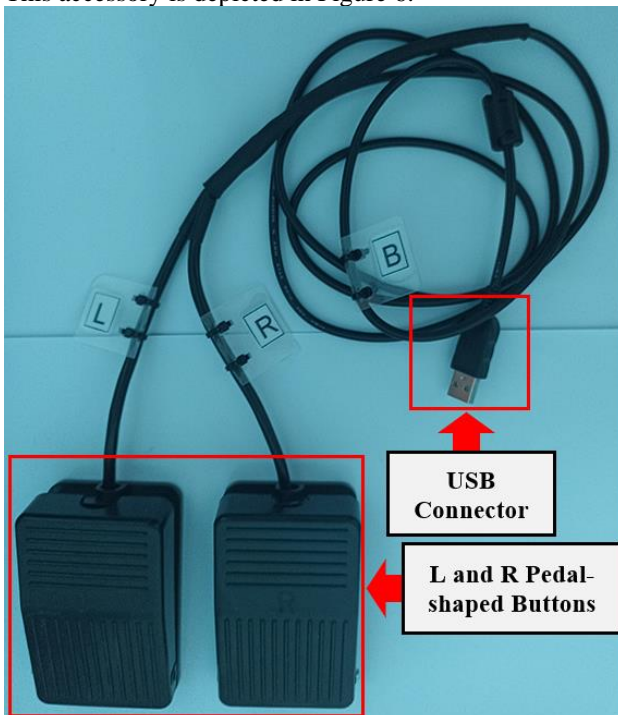

Figure 6. Accessory B, placed on the floor near the user's feet to serve as the prototype's button.

979-8-3503-2820-2/\$31.00 ©2024 IEEE

© 2024 IEEE. Personal use of this material is permitted. Permission from IEEE must be obtained for all other uses, in any current or future media, including reprinting/republishing this material for advertising or promotional purposes, creating new collective works, for resale or redistribution to servers or lists, or reuse of any copyrighted component of this work in other works.

DOI: <https://doi.org/10.1109/10493246>

### B. Software design

Programming language: Arduino IDE development platform.

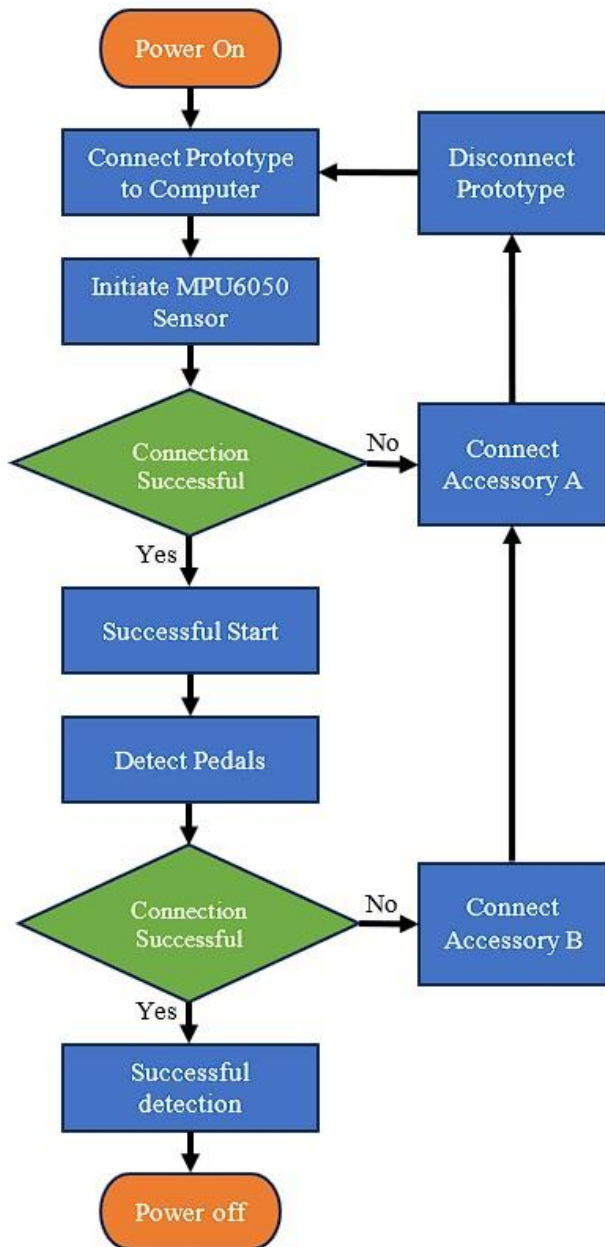

Figure 7. Flowchart depicting the operation of the mouse prototype for individuals without upper limbs.

### C. Prototype development

The USB cable from Accessory A is connected to USB Port A. The elastic band of Accessory A is worn on the head, with the protective box of the GY-521 module positioned to the right, pointing downwards. The two buckles on the elastic band are then used to adjust it to the user's head size, ensuring a secure fit [17].

The USB cable from Accessory B is connected to USB Port B, and the two pedals are placed on the floor near the user's feet.

The R pedal is positioned in front of the right foot, and the L pedal is placed in front of the left foot.

The USB cable from the Arduino protective casing is connected to an available USB port on the computer, which will automatically detect the new input device. Diagnostic indicators should be checked, and an orange LED 2 indicates that the prototype and its accessories are functioning correctly [18].

The user utilizes head movements to navigate the computer's graphical interface. The right foot is used to press the R pedal for right-click, and the left foot is used to press the L pedal for left-click, as needed [19].

### D. Design and Performance Testing

The prototype underwent real-world testing, where a user performed everyday actions, such as opening the browser and accessing a webpage, as depicted in Figure 8 and Figure 9. These tests were conducted by connecting the prototype's USB cable to a computer's USB 2.0 port, and it began functioning immediately upon connection without requiring the installation of any additional drivers [20].

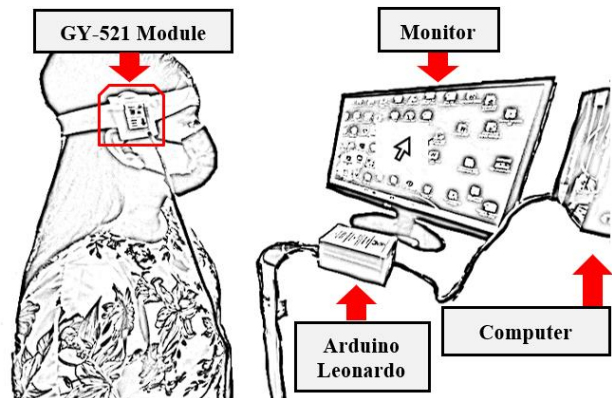

Fig. 8. Functionality test of Accessory A.

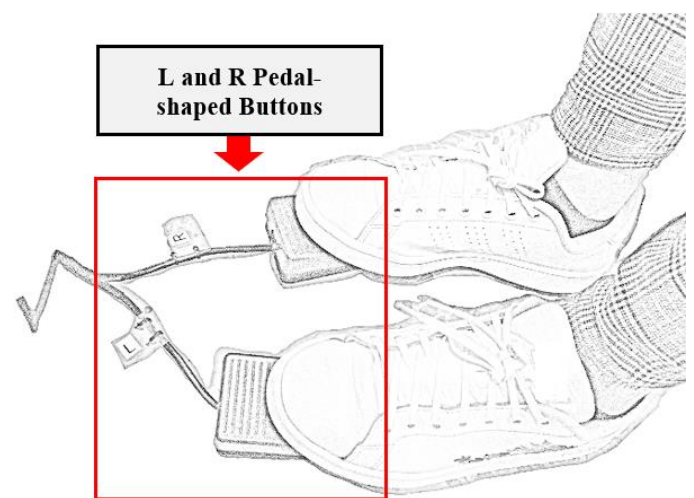

Fig. 9. Functionality test of Accessory B.

979-8-3503-2820-2/\$31.00 ©2024 IEEE

© 2024 IEEE. Personal use of this material is permitted. Permission from IEEE must be obtained for all other uses, in any current or future media, including reprinting/republishing this material for advertising or promotional purposes, creating new collective works, for resale or redistribution to servers or lists, or reuse of any copyrighted component of this work in other works.

DOI: <https://doi.org/10.1109/10493246>

### III. RESULTS AND DISCUSSION

To fully meet the set objectives, a comparison was made between the Arduino-based air mouse for individuals without upper limbs and the Genius USB DX-120 mouse. The results are presented in Table I.

Table I. Comparative table of features offered by a common mouse

Characteristics of a Conventional USB Mouse	Genius USB DX-120	Mouse for Individuals without Upper Limbs
Wired USB type A connectivity	Yes	Yes
Full cursor control	Yes	Yes
Static cursor stability	Yes	No
Correct cursor movement (non-erratic)	Yes	Yes
Scroll Wheel	Yes	No
Compatible with PC and Laptop	Yes	Yes
Right and left-click buttons	Yes	Yes
Compatible with Windows 10	Yes	Yes
Detects button press when moving	Yes	No
Normal delay when detecting button press	Yes	Yes
Number of buttons	3	2
Set DPI (Dots Per Inch) value	1.000	-
Cost	\$ 7,00	\$ 52.49

After the obtained data analysis, it is evident that the Arduino-based air mouse for individuals without upper limbs provides the user with most of the functions required for computer use. It adequately addresses the needs that may arise in a real-life scenario for a person without upper limbs when using a computer.

### IV. CONCLUSIONS

The results demonstrate that the prototype design is functional and aligns with the user's needs, allowing correct interaction with the computer's graphical interface, including cursor movement, left-click, and right-click. However, it lacks the scroll wheel function. On the flip side, one of its significant advantages is the low manufacturing cost, and the fact that the components required for its assembly are common and easy to acquire.

### REFERENCE

- [1] L. Hernandez and M. Ospina, 'Scheme and Creation of a Prototype for the Supervision of Lights and Electronic Devices with a PBX, Using a WLAN Solution Based on IoT', in 2019 IEEE Colombian Conference on Communications and Computing (COLCOM), 2019, pp. 1–6.
- [2] L. Dioses, M. Tupia, and M. Bruzza, 'State-of-art for accessibility measurement in electronic government services for people with visual disabilities', in 2021 16th Iberian Conference on Information Systems and Technologies (CISTI), 2021, pp. 1–6.
- [3] M. Rodríguez, L. Muñoz, and V. Villarreal, 'Systematic Review of the Literature focused on the use of Technology Assistive for people with visual impairment', in 2022 V Congreso Internacional en Inteligencia Ambiental, Ingeniería de Software y Salud Electrónica y Móvil (AmITIC), 2022, pp. 1–8.
- [4] P. O. Jagun, A. A. Okandjeji, M. B. Olajide, M. T. Kabir, F. Onaifo, and P. O. Alao, 'Design and development of a computer controlled switching system via universal serial bus port', 2020.
- [5] B. Shubankar, M. Chowdhary, and M. Priyaadharshini, 'IoT device for disabled people', *Procedia Computer Science*, vol. 165, pp. 189–195, 2019.
- [6] M. Zonneveld, A.-H. Patomella, E. Asaba, and S. Guidetti, 'The use of information and communication technology in healthcare to improve participation in everyday life: a scoping review', *Disability and rehabilitation*, vol. 42, no. 23, pp. 3416–3423, 2020.
- [7] R. Kumar, R. Gupta, and M. S. Faraz, 'Application and Designing of Wireless Mouse using Object Tracking', in 2019 6th International Conference on Computing for Sustainable Global Development (INDIACom), 2019, pp. 22–26.
- [8] S. Fernández-Canosa, V. L. González, A. Consoli, and V. Soto-León, 'Healthcare Based on IoT Using Arduino, MPU6050 Accelerometer and Gyroscope Sensor and FSR-174 Strain Gauge for Fatigue', in International Conference on Pervasive Computing Technologies for Healthcare, 2022, pp. 138–148.
- [9] Y. Elsahar, S. Hu, K. Bouazza-Marouf, D. Kerr, and A. Mansor, 'Augmentative and alternative communication (AAC) advances: A review of configurations for individuals with a speech disability', *Sensors*, vol. 19, no. 8, p. 1911, 2019.
- [10] R. Osorio-Comparan, F. G. Osorio, H. Kaschel, C. Ahumada, S. Cordero, and G. Lefranc, 'Virtual Monitoring of the 3D Movement of a Mobile Object, using UNITY', in 2022 IEEE International Conference on Automation/XXV Congress of the Chilean Association of Automatic Control (ICA-ACCA), 2022, pp. 1–6.

- [11] A. A. Rafiq, W. N. Rohman, and S. D. Riyanto, 'Development of a simple and low-cost smartphone gimbal with MPU-6050 sensor', *Journal of Robotics and Control (JRC)*, vol. 1, no. 4, pp. 136–140, 2020.
- [12] J. Blum, *Exploring Arduino: tools and techniques for engineering wizardry*. John Wiley & Sons, 2019.
- [13] H. K. Kondaveeti, N. K. Kumaravelu, S. D. Vanambathina, S. E. Mathe, and S. Vappangi, 'A systematic literature review on prototyping with Arduino: Applications, challenges, advantages, and limitations', *Computer Science Review*, vol. 40, p. 100364, 2021.
- [14] N. Cameron, N. Cameron, and Pao, *Arduino Applied*. Springer, 2019.
- [15] S. Fernández-Canosa, V. L. González, A. Consoli, and V. Soto-León, 'Healthcare Based on IoT Using Arduino, MPU6050 Accelerometer and Gyroscope Sensor and FSR-174 Strain Gauge for Fatigue', in *International Conference on Pervasive Computing Technologies for Healthcare*, 2022, pp. 138–148.
- [16] N. W. Moon, P. M. A. Baker, and K. Goughnour, 'Designing wearable technologies for users with disabilities: Accessibility, usability, and connectivity factors', *Journal of Rehabilitation and Assistive Technologies Engineering*, vol. 6, p. 2055668319862137, 2019.
- [17] K. R. Ooi, M. A. A. Rosli, A. R. A. Latiff, W. Othman, S. S. N. Alhady, and A. A. A. Wahab, 'Design of hoeckens linkage based walking robot with MPU6050 IMU as navigation sensor', in *Journal of Physics: Conference Series*, 2021, vol. 1969, p. 012004.
- [18] C. Bell and C. Bell, 'Introducing the Arduino', *Beginning IoT Projects: Breadboard-less Electronic Projects*, pp. 31–70, 2021.
- [19] X. Pengfei, C. Shiwen, and Y. Zhang, 'Design of Pose measurement and Display system based on STM32 and MPU6050', in *2021 International Conference on Intelligent Computing, Automation and Systems (ICICAS)*, 2021, pp. 71–74.
- [20] M. Tupac-Yupanqui, C. Vidal-Silva, L. Pavese-Farriol, A. S. Ortiz, J. Cardenas-Cobo, and F. Pereira, 'Exploiting Arduino features to develop programming competencies', *IEEE Access*, vol. 10, pp. 20602–20615, 2022.