

# Smart Contract Vulnerabilities, Tools, and Benchmarks: an Updated Systematic Literature Review

GERARDO IULIANO, University of Salerno, Italy

DARIO DI NUCCI, University of Salerno, Italy

Smart contracts are self-executing programs on blockchain platforms like Ethereum, which have revolutionized decentralized finance by enabling trustless transactions and the operation of decentralized applications. Despite their potential, the security of smart contracts remains a critical concern due to their immutability and transparency, which expose them to malicious actors. The connections of contracts further complicate vulnerability detection. This paper presents a systematic literature review that explores vulnerabilities in Ethereum smart contracts, focusing on automated detection tools and benchmark evaluation. We reviewed 1,888 studies from five digital libraries and five major software engineering conferences, applying a structured selection process that resulted in 131 high-quality studies. The key results include a hierarchical taxonomy of 101 vulnerabilities grouped into ten categories, a comprehensive list of 144 detection tools with corresponding functionalities, methods, and code transformation techniques, and a collection of 102 benchmarks used for tool evaluation. We conclude with insights on the current state of Ethereum smart contract security and directions for future research.

CCS Concepts: • **Security and privacy** → **Distributed systems security**; • **Software and its engineering** → **Maintaining software**.

Additional Key Words and Phrases: Smart Contracts, Vulnerabilities, Benchmarks, Systematic Literature Review

## ACM Reference Format:

Gerardo Iuliano and Dario Di Nucci. 2024. Smart Contract Vulnerabilities, Tools, and Benchmarks: an Updated Systematic Literature Review. 1, 1 (December 2024), 42 pages. <https://doi.org/XXXXXXXX.XXXXXXX>

## 1 INTRODUCTION

Smart contracts (SC) are self-executing programs running on blockchain platforms like Ethereum, where transactions are automatically enforced without intermediaries. These contracts are pivotal in decentralized systems due to their inherent transparency properties, tamper resistance, and immutability. They have revolutionized finance, healthcare, and supply chain management by ensuring trustless computation. In decentralized finance (DeFi), smart contracts form the backbone of financial protocols, enabling decentralized applications (dApps) to facilitate lending, borrowing, trading, and other financial services without traditional intermediaries. Ethereum, the most widely used blockchain for DeFi and dApps, supports a vast ecosystem of smart contracts managing valuable assets, including fungible and non-fungible tokens (NFTs). This surge in decentralized financial activity has attracted significant attention from developers and attackers, with billions of dollars now at stake.

Despite their potential, smart contracts face numerous challenges, particularly regarding security. Developing secure smart contracts is inherently difficult due to platform-specific limitations, complex business logic, and the immutability of deployed contracts. Once a contract is live, any error, weakness, or vulnerability becomes

---

Authors' addresses: Gerardo Iuliano, University of Salerno, Fisciano, Italy, [geiuliano@unisa.it](mailto:geiuliano@unisa.it); Dario Di Nucci, University of Salerno, Fisciano, Italy, [ddinucci@unisa.it](mailto:ddinucci@unisa.it).

---

Permission to make digital or hard copies of all or part of this work for personal or classroom use is granted without fee provided that copies are not made or distributed for profit or commercial advantage and that copies bear this notice and the full citation on the first page. Copyrights for components of this work owned by others than the author(s) must be honored. Abstracting with credit is permitted. To copy otherwise, or republish, to post on servers or to redistribute to lists, requires prior specific permission and/or a fee. Request permissions from [permissions@acm.org](mailto:permissions@acm.org).

© 2024 Copyright held by the owner/author(s). Publication rights licensed to ACM.

ACM XXXX-XXXX/2024/12-ART

<https://doi.org/XXXXXXXX.XXXXXXX>

permanent, making smart contracts appealing targets for malicious actors. The transparency of the blockchain allows attackers to analyze and exploit contracts, often leading to high-stakes breaches and financial losses in DeFi protocols. Furthermore, the interconnected nature of smart contracts, where contracts can interact and trigger each other, adds another layer of complexity, making vulnerabilities harder to detect and mitigate. In smart contracts, the line between a weakness and a vulnerability is often blurred. Weaknesses in code—although not immediately exploitable—can quickly become vulnerabilities if the right conditions or interactions with other contracts occur. The public visibility of code, coupled with the immutability of deployed contracts, makes identifying and classifying vulnerabilities crucial for ensuring the security of dApps. A comprehensive taxonomy is necessary to be aware of weaknesses and vulnerabilities, but developing such a taxonomy remains challenging due to the existing confusion in the literature.

Rameder *et al.* [78] conducted a systematic literature review (SLR) focusing on automated vulnerability analysis of Ethereum smart contracts. They analyzed over 300 studies published up to 2021, examining the classification of vulnerabilities, detection methods, security analysis tools, and benchmarks for evaluating tools. Their work laid the foundation for systematically understanding the complexities of smart contract vulnerabilities, the tools available to address them, and the open challenges and gaps in automated detection systems.

Our study updates Rameder *et al.* [78] to overcome previous limitations like the absence of a structured snowballing process, a comprehensive mapping between tools and vulnerabilities, and the unchecked benchmarks for duplicates. We answered four research questions to provide an updated and more complete perspective on Ethereum vulnerabilities, detection tools, and benchmarks. We analyzed five digital libraries and five main conferences on software engineering and conducted two snowballing processes to collect 1,888. We then applied a carefully documented process to select and evaluate 277 studies of immediate relevance. Quality appraisal reduced the analysis to 131 studies with sufficient intrinsic and contextual data quality that allowed us to answer our RQs. As a result, we realized a structured taxonomy that organizes hierarchically 101 vulnerabilities in 10 categories, a list of 144 automated detection tools with relative functionalities, methods, and code transformation techniques, a mapping between our taxonomy and the list of tools, and a list of 102 benchmarks used for tool evaluation. We provide the following contributions:

- A vulnerability taxonomy comprising 101 vulnerabilities hierarchically organized into ten categories and serving as a comprehensive aggregation of the most state-of-the-art classifications.
- A list of 144 tools used in the literature to address various problems concerning SCs, providing their functionalities along with the method and code transformation technique they apply.
- A mapping between our taxonomy and the tools that clarify the focus of researchers and gaps.
- A list of 102 benchmarks used for tool evaluation, tool comparing, or conducting experiments.
- A list of 131 quality papers on security vulnerabilities identifiable in blockchain smart contracts.

The paper is structured as follows. Section 2 describes the background of Ethereum SCs and their vulnerabilities. Section 3 exposes the research method and design adopted in our study and describes all the steps followed to answer our research questions. The results for each research question are reported in Section 4. Section 5 is dedicated to discussing our findings compared to the Rameder *et al.* [78] and lists the research opportunities. Section 6 defines the threats to validity, and finally, Section 7 concludes the paper.

## 2 BACKGROUND

In this section, we provide preliminary information about Ethereum, smart contract vulnerabilities, and the difference between related works and our contributions.

## 2.1 Ethereum

Ethereum is a decentralized, open-source blockchain platform that facilitates the creation and execution of smart contracts and decentralized applications (dApps) [9]. Proposed by Vitalik Buterin in late 2013 [8], Ethereum was designed to extend blockchain technology beyond simple data storage to include code execution, thus creating a versatile platform for developers. Unlike Bitcoin [66], which primarily functions as a digital currency, Ethereum allows for the development and deployment of decentralized applications. At its core, Ethereum features the Ethereum Virtual Machine (EVM), a decentralized virtual machine that executes code on the Ethereum network. This platform supports a near Turing-complete programming language, enabling complex computations and decentralized applications. A key feature of Ethereum is its use of three Merkle Patricia [56] trees to maintain blockchain state information, which facilitates efficient and verifiable data queries. Ether (ETH), Ethereum's native cryptocurrency, powers transactions and rewards miners, ensuring the network's security and functionality.

## 2.2 Smart Contracts

The idea of smart contracts, which Nick Szabo initially introduced in 1994 [91], has found new life on the Ethereum blockchain. Smart contracts on Ethereum are self-executing contracts with the terms directly written into code [2]. These contracts run on the Ethereum network, a decentralized platform that eliminates the need for intermediaries by automating contract execution. Each smart contract has a unique address and is initiated by a transaction between a sender and the contract. Execution incurs a computational cost measured in gas, which regulates resource usage and rewards miners. Developers write smart contracts in Solidity [18] or Vyper [47], two languages designed explicitly for this purpose. Once deployed on the blockchain, these contracts become immutable and tamper-proof [48]. They automatically execute predefined conditions, ensuring trust and reliability. Smart contracts enable seamless collaboration, enforce contract clauses, and are pivotal in developing decentralized applications on the Ethereum platform.

## 2.3 Smart Contract Vulnerabilities

Smart contracts on the Ethereum blockchain offer significant benefits but are susceptible to vulnerabilities, further compounded by blockchain technology's immutable nature [73], stemming from coding errors and bugs common in software development. Smart contracts can contain permanent mistakes once deployed, potentially leading to unintended behaviors or exploitations. The reentrancy attack [81] stands out among these vulnerabilities, wherein a contract calls another before updating its state, opening the door for recursive calls that could drain funds or disrupt intended execution. Furthermore, smart contracts often interact with external contracts and data sources, introducing additional vulnerabilities if these interactions are inadequately checked. Immutability ensures transparency and trust but makes code defects permanent. Fixing such defects requires the creation of new contracts and user migration, which is a complex and risky task underscoring the importance of exhaustive security measures. The potential of smart contracts in enabling decentralized applications is vast, although realizing this potential requires prioritizing security considerations. While blockchain's public nature enhances transparency, it also exposes smart contract codes to potential attackers, who can exploit weaknesses upon scrutiny. Mitigating smart contract vulnerabilities necessitates rigorous auditing and testing of code, adherence to best practices, and the implementation of mechanisms such as upgradeable contracts [13] or thorough vetting of external dependencies. By prioritizing security measures, we can harness the full potential of smart contracts while minimizing associated risks.

## 2.4 Related Work

In the recent past, some literature reviews targeted SC vulnerabilities and security. Oualid Zaaza and Hanan El Bakkali [116] conducted a comprehensive examination of scholarly literature from 2016 to 2021, focusing on

papers that address the detection of vulnerabilities in smart contracts. Their objective is to systematically extract and compile all vulnerabilities documented in the selected articles and analyze the various techniques researchers use to identify these vulnerabilities, with particular emphasis on machine learning (ML) models. Additionally, they aim to collect and consolidate a repository of ML datasets to build robust models capable of addressing the problem. The findings reveal insufficient coverage of the identified vulnerabilities and highlight the limited number (four) of blockchain platforms studied for smart contract security. The authors urge developers to exercise greater diligence in their development practices to improve blockchain network security, reducing user risks. Compared to the study, we delved into the tools' design, analyzing functionality, methods, and code transformation techniques they implement. Oualid Zaazaa and Hanan El Bakkali also realized a detailed examination and classification of vulnerabilities [115]. Compared to their taxonomy, we organized the vulnerabilities hierarchically and categorized them into ten categories. Kushwaha *et al.* conducted two different studies. On the one hand, they systematically reviewed Ethereum smart contract security vulnerabilities, including well-known attacks and their preventive methods [49]. They discussed the vulnerabilities based on their root and sub-causes and systematically presented well-known attacks. On the other hand, they systematically reviewed and categorized Ethereum smart contract analysis tools [48]. They analyzed 86 security analysis tools developed for Ethereum blockchain smart contracts, regardless of tool type or analysis approach, highlighted several challenges, and recommended future research. In our work, we overcome their limitations. We have considered tools that do not have names or have been proposed in pre-print articles and provided a collection of benchmarks for tool evaluation. Vidal *et al.* [100] review recent smart contract vulnerability detection research, focusing on detection techniques, targeted vulnerabilities, and evaluation datasets. It maps vulnerabilities to the DASP and SWC classification schemes, identifying research trends and gaps. The study highlights that existing schemes, especially SWC, may not capture newer vulnerabilities, suggesting updated classification frameworks are needed. The heterogeneity in detection tools' capabilities and evaluation settings hinders comparison, pointing to the importance of standardized benchmarks for assessing tool effectiveness. Compared to this study, we have realized a structured taxonomy and analyzed more aspects of vulnerability detection tools, such as the code transformation techniques and the implemented functionalities. Finally, Rameder *et al.* [78] conducted the SLR we updated. The study assesses state of the art regarding automated vulnerability analysis of Ethereum smart contracts, focusing on vulnerability classifications, detection methods, security analysis tools, and benchmarks for tool evaluation. Their initial search across major online libraries identifies over 1,300 publications. After applying a structured protocol to remove duplicates and implement inclusion/exclusion criteria, they retain 303 publications. The authors assess the quality of these studies based on the reputation of the publication venues and predefined contextual criteria. For 165 publications with at least a medium quality score, they extract data on vulnerabilities, methods, and tools. They then synthesize this data, providing a classification of 54 smart contract vulnerabilities, an overview of 140 tools, and a list of benchmarks used for tool evaluation. Finally, they present a detailed discussion of their findings. Our study overcomes previous limitations like the absence of a structured snowballing process and a comprehensive mapping between tools and vulnerabilities.

Our systematic literature review fills previous research gaps and overcomes their limitations by extending existing studies. We analyze tool design, including code transformation techniques and functionality. We also propose a hierarchical taxonomy of vulnerabilities, categorizing them into ten groups. Additionally, we include unnamed and pre-print tools, establish a list of benchmarks, execute a structured snowballing process, and provide a comprehensive tool vulnerability mapping.

### 3 RESEARCH METHOD

Nepomuceno and Soares [67] highlighted the desire among researchers to keep SLRs current, even if others carry out the updating process. However, Mendes *et al.* [62] pointed out the importance of employing decision-support

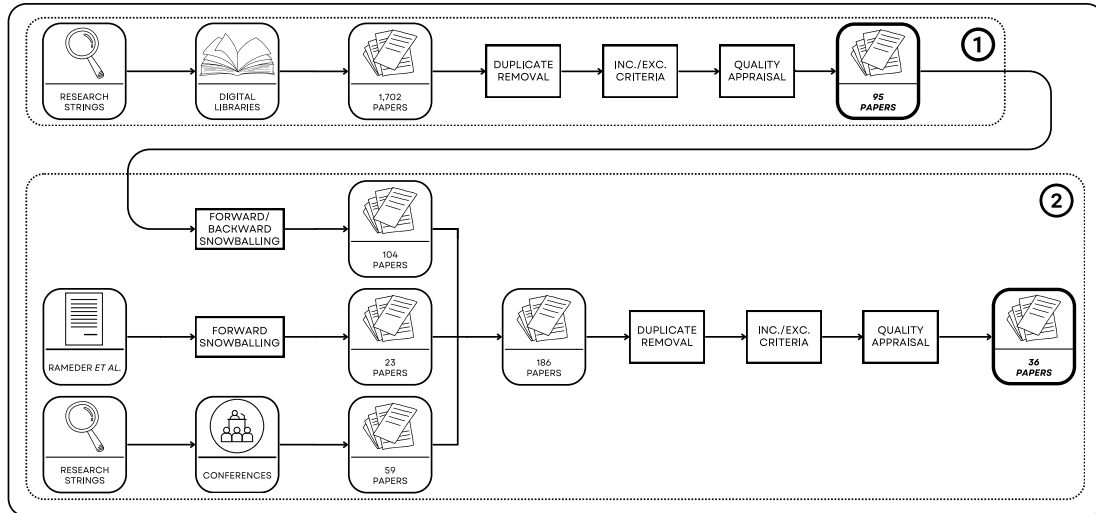

Fig. 1. Research Method

mechanisms to aid the software engineering community in determining the need for SLR updates. Indeed, to decide whether the literature by Rameder *et al.* [78] needed to be updated, we opted to apply the 3PDF framework introduced by Garner *et al.* [33] and approved by Mendes *et al.* [62].

Table 1. Application of the 3PDF Framework to Rameder *et al.* [78]

SLR	1.a	1.b	1.c	2.a	2.b	3.a	3.b	Result
[78]	YES	YES	YES	-	YES	-	YES	Upgradeable
<p><b>1.a</b> Does the published SLR still address a current question?  <b>1.b</b> Has the SLR had good access or use?  <b>1.c</b> Has the SLR used valid methods and was well-conducted?  <b>2.a</b> Are there any new relevant methods?  <b>2.b</b> Are there any new studies or new information?  <b>3.a</b> Will adopting new methods change the findings, conclusions, or credibility?  <b>3.b</b> Will the inclusion of new studies/information/data change findings, conclusions, or credibility?</p>								

The decision framework includes three steps to be applied sequentially. The first step consists of answering three questions, and if the answer to at least one of Step 1’s questions is ‘NO,’ there is no arguable need to update an SLR. Of course, the SLR addresses current problems related to Ethereum SCs, detection tools, and benchmarks; it is accessible through the open-access publication on Frontiers in Blockchain and uses a rigorous methodology, ensuring valid and well-conducted results. The second step invites checking whether more recent research offers significant contributions that justify updating or supplementing the systematic review. It requires at least one positive answer. In recent years, important events related to Blockchain technology have occurred. In 2021, there was the NFT boom; in 2022, the transition of Ethereum to PoS was finalized; and in 2023, the blockchain project-based increase was 19% compared to the previous year, and several enterprises around the world are still

quietly investing in blockchain <sup>1</sup>. These changes have triggered a strong interest in the research world, which has contributed to numerous studies. The third step requires an assessment of the impact of any research updates on the SLR conclusions. Also, the final step requires at least one positive answer. The addition of recent studies would bring new perspectives, increase the comprehensiveness of the review, improve credibility, and update the conclusions based on the latest available data.

Finally, the decision framework revealed that the SLR is suitable for upgrading, as outlined in Table 1. We deliberately chose not to modify the search strings and data extraction form of the original study, given the findings of Nepomuceno and Soares [67], who observed that such alterations typically result in creating a new SLR rather than an update. By incorporating insights from prior research and leveraging the 3PDF framework, we aimed to ensure a systematic and informed approach to updating the SLR on automated vulnerability analysis of Ethereum smart contracts. Our methodology underscores the importance of maintaining currency in research literature while respecting established frameworks and guidelines.

### 3.1 Goal and Research Questions

The *goal* of this work is to investigate current research studies and the most significant contributions in the field of smart contract vulnerabilities. Concurrently, offering a comprehensive and systematic perspective can contribute to the research community by facilitating assessments and discussions on future directions related to these issues. We also aimed to comprehend how the research area has evolved. Consequently, as mentioned in the previous section, we examined the same research questions (RQs) posed by Rameder *et al.* [78] except for one. Indeed, we decided to exclude RQ<sub>5</sub> (i.e., “What are the open challenges of automated detection?”) because its systematic and rigorous replication was challenging due to the lack of a data extraction form. Even though we did not consider analyzing the open challenges related to the automated detection of software vulnerabilities as a research question, they were discussed in Section 5. In detail, we posed the following research questions.

**RQ<sub>1</sub>.** *Which vulnerabilities are mentioned? How are vulnerabilities classified?*

RQ<sub>1</sub> allows structuring SC vulnerability understanding. A comprehensive taxonomy could enhance risk assessment and mitigation to prioritize efforts and allocate resources more effectively and efficiently.

**RQ<sub>2</sub>.** *Which methods do automated tools use to detect vulnerabilities?*

RQ<sub>2</sub> analyzes automated tools able to scan large codebases. Understanding these methods could reveal tool capabilities and limitations to guide the development of new techniques and tool selection.

**RQ<sub>3</sub>.** *Which vulnerabilities are addressed by the tools?*

RQ<sub>3</sub> helps assess coverage and gaps in automated vulnerability detection. It enables the selection of complementary tools for comprehensive protection and highlights areas that need manual review or additional measures.

**RQ<sub>4</sub>.** *How are the tools evaluated?*

RQ<sub>4</sub> examines how the performances of vulnerability detection tools are evaluated. Proper evaluation ensures tools perform as expected and allows for effective comparison between different solutions.

### 3.2 Identification of Relevant Literature

Figure 1 depicts the process we followed to update the systematic literature review proposed by Rameder *et al.* [78]. Brereton *et al.* [7] emphasize the importance of searching multiple databases because no single repository contains all pertinent papers. We conducted our search across five digital libraries in step 1, aiming to identify relevant studies comprehensively. We used the same search string (see Table 2) as the original SLR;

<sup>1</sup><https://www.forbes.com/sites/ninabambysheva/2023/02/07/forbes-blockchain-50-2023/>

Table 2. Query Strings on Different Search Engines

Database	Query
ACM Digital Library	Title: ("smart contract" OR "smart contracts") AND AllField: (vulnerability OR vulnerabilities OR bug OR bugs OR tool OR security OR analysis OR detection OR verification)
Google Scholar	allintitle: ("smart contract" OR "smart contracts" OR Ethereum) AND (vulnerability OR vulnerabilities OR bug OR bugs OR security OR analysis OR detection OR tool OR verification)
IEEE Xplore	"All Metadata": ("smart contract" OR "smart contracts") AND (vulnerability OR vulnerabilities OR bug OR bugs OR tool) AND (security OR analysis OR detection OR verification)
Science Direct	Title, abstract, keywords: "smart contract" AND (vulnerability OR vulnerabilities OR bug OR tool OR security OR analysis OR detection OR verification)
TU Wien CatalogPlus	title contains ("smart contract" OR "smart contracts") AND Subject contains (security OR vulnerability OR vulnerabilities OR bug OR bugs OR analysis OR detection OR tool OR verification)

consequently, the choices and motivations behind each search string are detailed in the original SLR [78], which also highlighted the need for a structured snowballing process to avoid overlooking essential studies. Therefore, in addition to analyzing the libraries, we conducted a second search in step 2. We applied backward and forward snowballing on the papers extracted from Google Scholar that passed the quality assessment stage to ensure a thorough exploration of the literature and capture relevant studies that may have been missed in the initial search. Furthermore, we applied forward snowballing on Rameder *et al.* [78] to identify additional relevant studies through the references of the initial paper. Finally, we analyzed publications from major conferences such as ICSE, FSE, ASE, ISSTA, and ICST. These highly relevant conferences often feature high-quality research on the analyzed topics; therefore, this further step provides valuable insights into current trends and developments in smart contract vulnerabilities.

Table 3. Inclusion and Exclusion Criteria

Inclusion Criteria
1 - SC security bugs or vulnerabilities
2 - SC vulnerability detection, analysis, or security verification tools
3 - Automated detection or verification methods
Exclusion Criteria
1 - Unrelated to Ethereum
2 - Not written in English
3 - A patent, blog entry, or other grey literature
4 - Not accessible online via the library network of the University of Salerno
5 - Published before 2021

### 3.3 Inclusion and Exclusion Criteria

We adopted the inclusion and exclusion criteria of the original SLR with two modifications. The original SLR, conducted at the end of January 2021, included publications from 2014. Given the nature of our study, we modified this exclusion criterion from “published before 2014” to “published before 2021”, aligning with the timeframe of our study. The second change is about the fourth exclusion criteria; it passed from “Not accessible online via the library network of TU Wien” to “Not accessible online via the library network of the University of Salerno”. All other criteria remained unchanged and are shown in Table 3.

### 3.4 Selection and Classification

We carefully reviewed and assigned each study to one of these three distinct groups.

**Systematic Literature Reviews (SLRs)** include comprehensive reviews that systematically collect, critically analyze, and synthesize existing research on smart contract security.

**Surveys and review studies** on smart contract security analysis tools, methods, and vulnerabilities provide overviews and comparative analyses of the state of the art.

**Primary Studies (PSs)** consist of original research on developing and evaluating smart contract security analysis and vulnerability detection tools and methods. PSs provide novel methodologies and empirical findings.

### 3.5 Quality Appraisal

The quality of the papers was evaluated in detail by applying the intrinsic and contextual data quality metrics described by Strong *et al.* [87].

Table 4. IDQ Assessment by Venue Ranking

SCImago	CORE	Scopus	IDQ
Q1	A*, A	$\geq 75^{th}$ percentile	1.0
Q2	B	$\geq 50^{th} \wedge < 75^{th}$ percentile	0.8
Q3, Q4	C	$\geq 25^{th} \wedge < 50^{th}$ percentile	0.5
		not indexed, but pub. by IEEE, ACM, Springer	0.4
		$< 25^{th}$ percentile	0.2
		other sources, e.g., arXiv, preprints, theses, reports	0.2

**Intrinsic Data Quality (IDQ)** assesses the accuracy, objectivity, credibility, and reputation of the publication venues. We convert other metrics, including the SCImago Journal Ranking, the CORE Journal or Conference Ranking, and the Scopus CiteScore percentile ranking, into scores ranging from 0 to 1. Table 4 shows the IDQ score for venue ranking. In cases where a journal or conference has yet to be ranked for the current year, we consider the most recent ranking available. We select the highest score as the IDQ (Indicator of Journal/Conference Quality) if multiple rankings are available.

**Contextual Data Quality (CDQ)** assesses the relevance, added value, timeliness, completeness, and amount of data, and thus depends on the context of the evaluation, e.g., the purpose of the systematic review, the research questions, and the data to extract and analyze. The CDQ score is the arithmetic mean of the answers to the questions, each being a number between 0 and 1. The questionnaire is based on the DARE criteria suggested by Kitchenham and Charters [49] and consists of seven questions for SLRs and Surveys (see Table 5) and two questions for Primary Studies (see Table 6).

**Final Data Quality (FDQ)** combines IDQ and CDQ. We compute the FDQ score as the arithmetic mean of the other two scores; thus, it is a number between 0 and 1. We map CDQ and FDQ to a three-point Likert scale for readability and ease of classification. We consider a score low if it is below 0.5, high if it is at least 0.8, and medium otherwise. Studies with a CDQ or FDQ score below 0.5 are excluded from the survey.

### 3.6 Data Extraction

Once we identified the final set of sources, we extracted information relevant to our research questions, following Nepomuceno and Soares's guidelines [67]. We utilized the same data extraction forms as Rameder *et al.* [78], ensuring consistency in collecting and organizing data about vulnerabilities, analysis tools, datasets, and test sets. We collected detailed information about vulnerabilities, including the identifier or code, name and alternate names, description, category, and reference paper. Regarding tools and frameworks, we collected essential information



Table 5. CDQ Assessment Criteria of SLRs and Surveys

<b>Q1: Is the methodology and literature search of the review systematic and documented? Are all relevant studies at the time likely to be covered?</b>	
<b>1.0</b>	Yes, in comprehensive detail, systematic and good quality. To be (re)classified as SLR.
<b>Not Graded</b>	No, to be (re)classified as survey.
<b>Q2: Does the study focus on work about smart contract vulnerabilities, detection tools, or approaches to automated detection or verification?</b>	
<b>1.0</b>	Yes, the research topic closely related and covers major parts of this work.
<b>0.6</b>	It covers related topics, but important areas differ or are missing.
<b>0.3</b>	Some similar areas are covered.
<b>0.0</b>	The review focuses on different research topics, only a very small part is related.
<b>Q3: Does the study cover the evaluation of smart contract vulnerabilities?</b>	
<b>1.0</b>	Yes, the work includes a survey, evaluation and detailed description of vulnerabilities including classifications.
<b>0.6</b>	Descriptions or classifications of certain vulnerabilities are given, but it is not a major focus of the work.
<b>0.3</b>	Some vulnerabilities are superficially listed or mentioned.
<b>0.0</b>	No, the focus is not on the survey of vulnerabilities.
<b>Q4: How many tools or analysis/verification methods does the review identify, classify, compare or evaluate?</b>	
<b>1.0</b>	more than 12.
<b>0.6</b>	8 to 12.
<b>0.3</b>	4 to 7.
<b>0.0</b>	less than 4.
<b>Q5: Did the author(s) assess and compare the quality/validity of tools or automated detection/verification approaches in detail?</b>	
<b>1.0</b>	Yes, in detail and high quality, including practical experiments or comprehensive/in-depth coverage and classification.
<b>0.6</b>	Yes, compared/evaluated in some detail, but only theoretically.
<b>0.3</b>	Only superficial description.
<b>0.0</b>	No.
<b>Q6: Is a set of smart contract benchmarks provided?</b>	
<b>1.0</b>	Yes.
<b>Not Graded</b>	No.
<b>Q7: How current is the review?</b>	
<b>1.0</b>	2023/2024.
<b>0.5</b>	2022.
<b>0.0</b>	2021.

such as the tool name, description, and the article introducing it. We also reported whether the tool is open source, provided links to the tool's page or GitHub repository, and provided the publication date and the last update date. Additionally, we documented the source language. Technical specifications were also recorded, including the input needed by the tools (i.e., EVM bytecode or source code), its purpose, the type of analysis conducted, and any code transformation techniques and analysis methods employed. This comprehensive collection allowed us to assess the tools thoroughly. For datasets and test sets used to compute tool benchmarks, we noted the reference article introducing the dataset, the tools or projects using it, and the repository link. We also recorded the number of contracts within the dataset and the form in which the contracts are represented (i.e., Solidity source code, bytecode, address). Furthermore, we checked for analysis results and any identified exploits. This detailed approach ensured that we clearly understood the roles of the datasets and test sets in tool evaluation. By

Table 6. CDQ Assessment Criteria of Primary Studies (PSs)

<b>Q1: Is the PS referenced in a selected SLR or survey? How often is it cited according to Google Scholar?</b>	
<b>1.0</b>	referenced in selected SLR or Survey, or cited more than 12 times according to Google Scholar.
<b>0.6</b>	8 to 12 citations.
<b>0.3</b>	4 to 7 citations.
<b>0.0</b>	less than 4 citations.
<b>Q2: Is the PS related to an executable tool or to a framework for verifying security properties or identifying vulnerabilities of Ethereum smart contracts?</b>	
<b>1.0</b>	Yes.
<b>0.0</b>	No.

meticulously collecting and organizing this information, we ensured an accurate and systematic approach to understanding vulnerabilities, analysis tools, and performance benchmarks. This methodical process enhanced the reliability and comprehensiveness of our study.

Table 7. Statistics about the Search Process Execution.

	Init Sel	Dupl	Unique	Inc C 1	Inc C 2	Inc C 3	Exc C 1	Exc C 2	Exc C 3	Exc C 4	Exc C 5	Tot Inc/Exc	QA
Step 1	1,702	166	1,536	89	147	46	38	14	28	29	4	229	95
Step 2	186	96	90	17	40	22	4	2	0	1	1	48	36
Total	1,888	262	1,626	106	187	68	42	16	28	30	5	277	131

### 3.7 Search Process Execution

The search was conducted between January and March 2024. We started the research with Step 1, which yielded 1,702 results from the five digital libraries. After removing 166 duplicates, we retained 1,536 unique papers. Then, we applied inclusion and exclusion criteria. Table 7 shows the occurrences of each criterion. An article was included if it satisfied at least one inclusion criterion and no exclusion criteria. After applying inclusion and exclusion criteria, 229 papers were retained for the quality appraisal. In total, quality appraisal in Step 1 produced 95 papers, of which eight were SLRs [48, 49, 75, 80, 82, 96, 114, 116], 11 were Surveys [1, 10, 12, 15, 35, 45, 77, 89, 115, 126, 129], and 76 were PS [2–9, 11, 13, 17, 18, 20, 23–25, 28–32, 34, 36–39, 41–43, 46, 47, 51–53, 55, 58–62, 65, 68–71, 73, 74, 76, 78, 79, 88, 90, 91, 93, 94, 97–100, 103, 107–110, 112, 113, 118–124, 127, 128, 131].

Afterward, we started Step 2, conducting forward and backward snowballing on the 95 papers obtained in Step 1. During snowballing, pre-2021 papers were not considered due to one of the exclusion criteria. Snowballing contributed 104 papers. We also conducted forward snowballing on the work by Rameder *et al.* [78], which helped to find another 23 papers. Finally, we analyzed the publications at major conferences. We manually applied research string on papers to collect only relevant papers. Conferences contributed another 59 papers. Overall, in Step 2, we analyzed 186 papers, 96 of which were removed because they were duplicates. On the remaining 90 papers, we applied inclusion and exclusion criteria and obtained 48 papers. Quality appraisal produced 36 papers, of which five were Surveys [19, 21, 22, 64, 101] and 31 were PS [14, 16, 26, 27, 33, 40, 44, 50, 54, 56, 57, 63, 66, 67, 72, 81, 83, 84, 86, 87, 92, 95, 102, 104–106, 111, 117, 125, 130, 132].

We analyzed 1,888 publications, 1,702 in step one and 186 in step two. The first step contributed 95 papers, and the second contributed 36 papers, for a total of 131 papers. As shown in Table 7, the most frequent inclusion criterion was the second (i.e., SC vulnerability detection, analysis, or security verification tools), while the most frequented exclusion criterion was the first (i.e., Unrelated to Ethereum).

Fig. 2. Distribution of publication venues per publication class

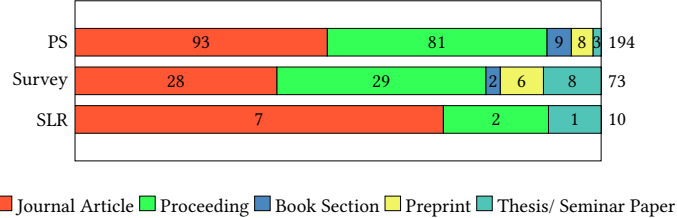

Fig. 3. Number of publications per IDQ score, by publication venue

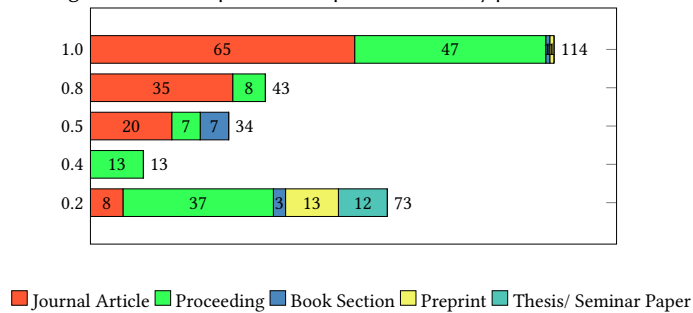
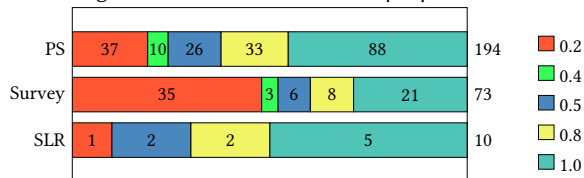

Fig. 4. Distribution of IDQ scores per publication class



*Analysis of the Selected Papers.* Figure 2 breaks down the distribution of publication venues per publication class. 70% of SLRs, 78% of Surveys, and 89% of PS are journal articles or conference papers. Figure 3 shows the IDQ score per publication class. Out of 277, 114 publications (41.1%) received the highest IDQ score of 1.0, while 43 publications (15.5%) were rated at 0.8 and 34 (12.3%) at 0.5. On the lower end of the spectrum, 13 publications (4.7%) scored 0.4, and 73 (26.4%) scored 0.2. Figure 4 breaks down the IDQ score within the three publication classes. The 70% of SLRs have an IDQ grader equal to 0.8. About 62% of the Primary Study also have an IDQ grader equal to 0.8. Finally, Surveys have the lowest percentage, with 39.7% of publications with an IDQ grader equal to 0.8. Also, in the work of Rameder *et al.*, the quality of the surveys is rather low compared to SLRs and PSs. During the quality assessment, four surveys were reclassified as primary studies.

### 3.8 Data Synthesis and Analysis

We analyzed the above-selected studies to answer our research questions. To answer  $RQ_1$ , we focused on the SLRs and surveys. In total, we analyzed 83 studies. In particular, to classify vulnerabilities and organize them hierarchically, we followed a series of steps:

- (1) **Pilot Study.** We randomly selected and analyzed 20 sources to establish an initial taxonomy draft, as suggested by Ralph [77].
- (2) **Pilot Study: Inter-rater Assessment.** We performed an inter-rater assessment of the vulnerabilities to reach unanimity on their classification, clustering, and hierarchical position, leading to several changes.
- (3) **Full Study.** The rest of the papers were analyzed following the consensus reached in the previous step. The sources were split into two halves, each analyzed independently by one researcher.
- (4) **Full Study: Inter-rater Assessment.** After the independent vulnerability extraction, the researchers looked into each other's taxonomy to inter-rater assess them. All the discrepancies were solved via discussions and reasoning.

Each researcher followed the following steps:

- (1) **Vulnerability Collection.** We extracted all information related to vulnerabilities, e.g., their name, ID, description, impact, classification, and eventually, the alternative names used to refer to them.
- (2) **Duplicate Removal.** We focused exclusively on vulnerabilities with the same name or similar description to reduce the number of vulnerabilities but also to ensure that in the literature, two vulnerabilities with the same name describe the same issue.
- (3) **Vulnerability Classification.** The classification was based on their impact or effect, leveraging the ten classes proposed by Rameder *et al.* [78].
- (4) **Vulnerability Clustering.** We noted numerous vulnerabilities with similar names, which allowed us to divide them into unique clusters and analyze them deeply. For each cluster, if the vulnerabilities were not present in the original study [78], we named it based on the number of occurrences in the state of the art. In particular, we selected the most commonly used names in the literature and provided the other names as alternatives.
- (5) **Hierarchical Organization.** The previous cluster analysis revealed that the vulnerabilities are present in the literature with numerous alternative names and described in various levels of detail. Therefore, we organized the vulnerabilities hierarchically, placing them on two levels: a first level, more general and representative, and a second and more detailed one.
- (6) **Existing Terminology Usage.** Due to the vast terminology used in literature to refer to vulnerabilities, our work of classifying and organizing them was based exclusively on existing terminology without introducing new identifiers and names or adapting the existing nomenclatures. Since our work extends and updates a previous taxonomy [78], we prioritized the already employed names. We selected the most frequent names in the state of the art for the new vulnerabilities. When the number of occurrences in the literature was equal, we selected the most explanatory name.

To answer  $RQ_2$ , we applied Closed Coding [80], adopting the same categories used by Rameder *et al.* [78] to collect all tool information. The three main analyzed areas are functionality, code transformation technique, and methods, each comprising several categories:

**Functionalities:** Vulnerability Detection, Program Correctness, Gas/Resource Analysis, Bulk Analysis/Full Automation, Exploit Generation, Reactive Defenses, Manual Analysis/Developer Support.

**Code Transformation Techniques:** Control Flow Graph, Data Flow, Transaction Analysis, Traces, Abstract Syntax Tree, Decompilation, Compiler, Intermediate Representation, Specification Language (Opcode), Disassembly, Finite State Machine.

**Methods:** Symbolic Execution, Formal Verification, Constraint Solving, Model Checking, Abstract Interpretation, Fuzzing, Runtime Verification, Concolic Testing, Mutation Testing, Pattern Matching, Code Instrumentation, Machine Learning, Taint Analysis.

We also collected additional information, such as the tool name, brief description, link to the repository, date of publication, last update, development languages, input type, and analysis type. The vulnerabilities identified in  $RQ_1$  and the tools identified in  $RQ_2$  provided the basis to answer  $RQ_3$ . We identified the vulnerabilities detected by each tool and created a detailed mapping between them. Finally, to answer  $RQ_4$ , we adopt the Closed Coding approach [80]. We collected various benchmarks to evaluate tools or conduct other experiments. We gathered the same information extracted by Rameder *et al.*, like the smart contract types (i.e., source code, bytecode, or addresses), their size in terms of the number of SCs, the associated links, if present, and the analysis results when available. Furthermore, we mapped the benchmarks to the tools to evaluate and compare their performance.

### 3.9 Replication Package

To facilitate the validation and replication of our study, we have made the replication package online <sup>2</sup>. It contains the full list of studies that emerged from queries on digital libraries, the results of snowballing, and all the conference papers. The inclusion/exclusion criteria and the results of qualitative analysis are present for each paper. Finally, a complete and comprehensive taxonomy, a full list of tools, a mapping between tools and vulnerabilities, and benchmarks used for tools evaluation or other experiments are included.

Fig. 5. Publication trend per year for SLRs, Surveys, and Primary Studies.

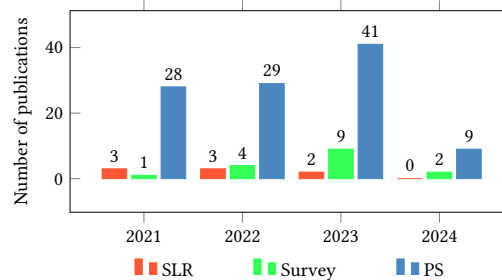

## 4 ANALYSIS OF THE RESULTS

Before delving into the results to address the RQs, we provide some meta-information about the studies in our systematic literature review. Figure 5 shows the number of papers published yearly. The plot shows a slight growth in the number of papers published recently. However, the graph represents only those papers that have passed the quality assessment. The trend may indicate that several other papers will be published shortly, motivating our work. In addition, 2024 has yet to be analyzed, which explains the sudden decline.

### 4.1 RQ1. Which Vulnerabilities are Mentioned? How are Vulnerabilities Classified?

Following the steps described in Section 3.8, we answered to  $RQ_1$  realizing a structured taxonomy. Initially, we identified 326 vulnerabilities. The first challenge was to remove all duplicates, which allowed us to reduce this number to 280. The second step was analyzing the remaining vulnerabilities to cluster them. We divided the 280

<sup>2</sup><https://figshare.com/s/6e49677bc49ada0f3753>

vulnerabilities into 101 unique clusters. For each cluster, a vulnerability was placed as a cluster representative. In contrast, the remaining vulnerabilities were posed as alternative names. In other words, we have identified 101 vulnerability clusters with alternative names used in the literature to refer to the same phenomenon. For example, one cluster comprises *Block State Dependency* [14] and *Block Info Dependency* [12], two vulnerabilities with similar names and expressing the same concept. Specifically, this vulnerability arises from smart contracts relying on blockchain state attributes, which can be exploited due to the predictable nature of specific blockchain attributes. In the context of Ethereum, miners can manipulate these attributes of the block retarding the submit up to 900ms [116]. Another example is the cluster that includes *Timestamp dependency* [15, 48, 49, 89, 129] [78], *Timestamp restrictions* [97], *Time Constraints* [78], and *Time manipulation* [1] [78]. These vulnerabilities express the same concept: the block's timestamp should not be used for precise calculations or critical time dependencies in the contract logic. The next step was to hierarchically organize the clusters based on the level of detail of their description. As shown in Table 8, we organized 59 vulnerabilities on the first level and 42 vulnerabilities on the second level.

The hierarchical organization reveals that the well-known vulnerability, *1A1-Reentrancy*, is actually a specific instance of a broader vulnerability, *1A-Call to the unknown* [78]. Similarly, the *3B1-Mishandled out-of-gas exception* is a subcategory of the broader *3B-Unexpected throw or revert* vulnerability as also exposed in prior research [78]. The sheer variety of names that refer to a single vulnerability category is remarkable. The literature references vulnerabilities such as 1B, 2D, 3A, 3C, 6B, 7C, 8H, and 10B using at least seven names. Rameder's taxonomy [78] addresses this issue by grouping several vulnerabilities as alternative names for a single vulnerability. For instance, *6D1-Missing protection against signature replay attacks*, *6D2-Lack of proper signature verification*, *6D3-Hash collisions with multiple variable-length arguments*, *6D4-Function clashing*, and *6D5-Signature malleability* are all alternative names for *6D-Signature-based vulnerabilities*. Conversely, the taxonomy proposed by Zaazaa and El Bakkali [115] classifies each vulnerability independently and further delineates their differences. This divergence in classification was resolved by organizing vulnerabilities into two hierarchical levels: *6D-Signature-based vulnerabilities* occupies the first level due to its general nature, whereas the specific vulnerabilities are placed at the second level to distinguish their unique characteristics. Similar hierarchical structuring has been applied to other vulnerabilities, such as *5C:5C1-5C2* and *1B:1B1-1B2*.

 **Take-Away RQ<sub>1</sub>.** We developed a structured taxonomy for Ethereum SC vulnerabilities by clustering 280 unique vulnerabilities into 101 groups. Groups are classified into ten categories based on impact or effect. Each group consists of a representative vulnerability and alternative names, reflecting the various terminologies used in the literature for similar issues. Each group hierarchically organizes vulnerabilities into two levels based on their specificity. The first level contains 59, while the second contains 42.

Table 8. A Comprehensive List of Vulnerabilities Hierarchical Organized.

Id	Name	Alternative Names
<b>1 - Malicious Environment, Transactions, or Input</b>		
1A	Call to the unknown [49, 89, 115, 116]	Unexpected fallback function [78]
1A1	Reentrancy [10, 14, 15, 48, 89, 101, 115, 116, 129]	Reentrancy-eth [1] [24], Cross function race condition, Recursive call vulnerability, Race to empty [78]
1B	Exact balance dependency [78]	Unexpected Ether, Manipulated balance, Unexpected Balance [115, 116], Unexpected Ether balance [64], Unprotected Ether Balance [89], Balance equality [1], Strict Balance Equality [12]

Continued on next page

Continued from previous page

<b>Id</b>	<b>Name</b>	<b>Alternative Names</b>
1B1	Forcing Ether to contracts [78]	Check on force to receive balance [22]
1B2	Pre-sent Ether [78]	
1C	Improper data validation [78]	Untrustworthy data feeds [78] [49, 115, 116]
1D	Vulnerable Delegatecall [78]	Delegate call to Untrusted Callee [64, 115, 116], Delegate call to Insecure Contracts [129], Unsafe delegatecall [101], check on target address in delegatecall [22], Delegate call [1, 48, 49]
<b>2 - Blockchain/Environment Dependency</b>		
2A	Block State Dependency [12, 14]	Block Info Dependency [12]
2A1	Timestamp dependency [78] [15, 48, 49, 89, 129]	Time constraints, Time manipulation [78], Time restriction [97], Block values as a proxy for time [115, 116]
2A2	Block number dependency [78]	
2A3	Blockhash dependency [78]	Blockhash usage [89]
2B	Transaction-ordering dependency [1, 15, 48, 49, 89, 115, 116, 129]	Event-ordering bugs [78]
2B1	Front-running attack [78]	Race condition [78]
2C	Bad random number generation [78]	Generating Randomness [78] [89, 129], Bad randomness [78], Weak Sources of Randomness from Chain Attributes [115, 116], Random Number [97]
2C1	Randomness Using Block Hash [49]	
2D	Leakage of confidential information [78]	Lack of transaction privacy [78] [49], Private information leakage, Nothing is secret, Confidentiality failure, Keeping secrets, Data exposure [78], On-chain oracle manipulation [10], Secrecy failure [89], Exposed secret [64], Unencrypted private data on-chain [78] [101, 115, 116], Secrets [97]
2E	Unpredictable state [78] [97]	
2E1	Dynamic Library [115, 116]	
2E2	References to destroyed contracts [64]	
2E3	Using components with known vulnerabilities [115, 116]	
2E4	External Contract Referencing [129]	Misuse of address parameters in the constructor [64], Value assigned to contract address [22]
<b>3 - Exception &amp; Error Handling Disorders</b>		
3A	Unchecked low-level call/send return values [78]	Unchecked call return values [78] [1, 89, 115, 116], Unchecked external calls [12], Check on external call [64], Unchecked call [48], Unchecked send [78] [89, 101], Unhandled exception [78] [15], Improper handling of exceptions [115, 116], Unchecked/unsafe send [78]
3A1	Send instead of transfer [78] [64]	
3B	Unexpected throw or revert [78]	Unexpected-throw-DoS, DoS with unexpected revert/throw[78], DoS with failed call [78] [49, 64, 115, 116], Dos by External contracts [78] [89]
3B1	Mishandled out-of-gas exception [78]	Gasless send[78] [49, 89]
3C	Assert, require or revert violation [78]	Assert violation [78] [115, 116], Assertion failure [14], Requirement violation [14, 89, 101], Requirement violation by the called smart contract [115, 116], Require on input variable [22], Revert require, Exception state [1]
<b>4 - Denial of Service</b>		
4A	Greedy contract [78]	Locked Ether [78], Freezing Ether [14, 48, 89, 129]
4A1	Locked Money [1, 15, 115, 116]	

Continued on next page

Continued from previous page

<b>Id</b>	<b>Name</b>	<b>Alternative Names</b>
4A2	Frozen Ether [78]	
4B	Ether lost in transfer[78]	Transfer to orphan address [78], Lost of Ether [49, 89, 115, 116], Loss of Ether [97]
4C	DoS with block gas limit reached [78] [49, 101, 115, 116]	DoS Costly Pattern and Loops [89], Check on gas Limit [22], Gas limit in loops, Extra Gas in loop [1]
4C1	Multiple calls in a single transaction [115, 116]	Nested Call [12], Multiple calls, Transfer in loop [1]
4C2	Array length manipulation [1, 115, 116]	
4C3	Infinite loop [101]	Unbounded mass operation [64]
4D	DoS by Exception inside loop [78]	DoS under external influence [78] [12], Wallet grieving causing out of gas exception [78]
4E	Insufficient gas grieving [78] [49, 64, 101, 115, 116]	
4F	Overpowered Role [1]	Check on overpowered role [22]
4G	Missed to implement a fallback function [64]	
<b>5 - Resurce Consumption &amp; Gas Related Issues</b>		
5A	Gas costly loops [78]	Invariants in loops [78]
5B	Gas costly pattern [78]	
5C	High gas consumption of variable data type or declaration	
5C1	Byte Array [78]	Variable type [22]
5C2	Invariant State variables not declared constant [78]	Declaration of invariant state variable [22]
5D	High gas consumption function type [78] [12]	Function declaration public instead of external [78]
5E	Under-priced opcodes [78]	
5F	Transfer of all the gas [78]	
<b>6 - Authentication &amp; Access Control Vulnerabilities</b>		
6A	Prodigal contract	
6A1	Authorization via transaction origin [78]	Authentication through tx.origin [78] [1, 49, 89, 101, 115, 116, 129], Transaction state dependency [64], Transaction origin use [14]
6B	Unauthorized accessibility due to wrong function or state variable visibility [78]	Visibility of exposed functions [78] [89] Function or state variable default visibility [115, 116], Function/State visibility error [10], Unspecified visibility level [64], Bad visibility [1], Default visibility [129], No restricted write, Implicit visibility level, Non-public variables accessed by public/external functions, Default/Unintended/Erroneous visibility [78]
6B1	Function default visibility [49, 101]	
6B2	State variable default visibility [101]	
6C	Access Control management [115, 116]	
6C1	Unprotected self-destruction [78] [1, 15, 48, 49, 89, 129]	Unexpected kill, Destroyable contract [78], Suicidal contract [14], Unsafe suicide [101], Check on suicide functionality [22]
6C2	Unauthorized Ether withdrawal [78]	Unprotected Ether withdrawal [49, 89, 101, 115, 116] Check on balance withdrawal [22], Ether leak [14]
6D	Signature based vulnerabilities [78]	Insufficient signability information [78]
6D1	Missing protection against signature replay attack [78] [89, 101, 115, 116]	
6D2	Lack of proper signature verification [78] [101, 115, 116]	
6D3	Hash collision with multiple variable length arguments [78] [49, 115, 116]	

Continued on next page



Continued from previous page

<b>Id</b>	<b>Name</b>	<b>Alternative Names</b>
6D4	Function Clashing [78] [115, 116]	
6D5	Signature Malleability [89, 101, 115, 116]	
6D6	Map overlap [64]	
6E	Identity verification [115, 116]	
<b>7 - Arithmetic bugs</b>		
7A	Integer over- or underflow [78] [1, 15, 49, 64, 89, 101, 115, 116]	Arithmetic UnderflowOverflow [48], Integer bug [14], Value assignment with too many digits [22]
7B	Floating point & Precision [78]	
7B1	Integer division [78]	Money leak [115, 116], Unexpected result from division [64]
7B2	Arithmetic Precision [89]	
7C	Integer bugs or Arithmetic Issues [78]	Integer sign [78] [22], Signedness bugs [1], Check on arithmetic operation [22], Integer Truncation [78] [22], Truncation Bugs [1], Unchecked Math, Wrong operator [78]
7C1	Unchecked division [115, 116],	
<b>8 - Bad Coding Quality and Programming Language Specifics</b>		
8A	Type cast [78] [89, 115, 116]	Unsafe type declaration, Insecure inference [64], Unsafe type inference [78], Type conversion [97]
8B	Coding error [78]	Typographical error [78] [101, 115, 116], Immutable bugs [78] [97], Coding Bug[78]
8C	Bad coding pattern [78]	
8D	Deprecated source language features [78]	Use of deprecated Solidity function [115, 116]
8E	Write to arbitrary storage location [78] [22, 101, 115, 116]	Arbitrary send [1], Arbitrary write [14]
8F	Use of assembly [78] [1]	Assembly-based vulnerabilities [115, 116], Usage of assembly [1]
8F1	Arbitrary jump with function type variable [101, 115, 116]	Arbitrary jump [89], Control-Flow hijack [14], Function type variables assignment using arbitrary values [22], Specify function variable as any type[78]
8F2	Constant function using assembly code [1]	Constant Function [1]
8F3	Returning results using assembly code in constructor [78]	
8G	Incorrect inheritance order [78] [101, 115, 116]	
8H	Variable shadowing [78]	Hidden state variable [78], Shadowing state variables [115, 116], Variable name [22], Tained memory [64], Shadowing state, Shadowing abstract, Shadowing builtin, Shadowing local [1]
8I	Misleading source code [78]	
8I1	Right to Left override [89, 101] [78]	
8I2	Misleading data location [12]	
8I3	Hidden built-in symbols [78]	Built-in symbol shadowing [115, 116], Use of deprecated built-in symbols [22]
8J	Missing logic [78]	Code with no effects [78] [101, 115, 116], Presence of unused variables [78] [101], Unused statement [12], Unused return [1], Logical errors or dead code [78]
8K	Insecure contract upgrading [78]	Upgradable contract, Patching [78]
8L	Inadequate or incorrect logging or documentation [78]	
8M	Hardcoded addresses [1, 12, 115, 116]	
8N	Send to zero address [115, 116]	
8O	Double constructor [115, 116]	

Continued on next page

Continued from previous page

<b>Id</b>	<b>Name</b>	<b>Alternative Names</b>
<b>9 - Environment Configuration Issues</b>		
9A	Short address [78] [15, 89, 129]	Check on input address length [22], Address shortening [64]
9B	Outdated compiler version [78] [101, 115, 116]	Pragmas version [1], Unspecified Compiler version [12], Compiler version [22]
9C	Floating or no pragma [78] [49, 101]	Floating compiler version [115, 116]
9D	Token API violation [78] [115, 116]	Token standard incompatibility [78], Unmatched ERC-20 Standard [12]
9D1	Improper or missing event handling [115, 116]	Missing Reminder [12], Fake Deposit [64]
9E	Ethereum update incompatibility [78]	Failing to accept new deposit, Deposit Acceptance [64], Message call with hardcoded gas amount [78] [101, 115, 116]
9F	Configuration error [78]	
9G	Missing Interrupter [12]	
<b>10 - Eliminated/Deprecated syntax</b>		
10A	Callstack depth limit [78]	Stack size limit [78], Limited stack size [78] [115, 116], Stack size [97]
10B	Uninitialized storage pointer [78] [64, 115, 116]	Uninitialized local/state variable [78], Uninitialized state variables [15], Uninitialized state, Uninitialized storage, Uninitialized local [1], Initialization of local variables, Initialization of state variables, Initialization of storage pointer, Missing initialization [22]
10C	Erroneous constructor name [78]	Incorrect constructor name [78] [101, 115, 116], Constructor name [22]
10D	Deprecated APIs [12]	

## 4.2 RQ2. Which Methods Do Automated Tools Use to Detect Vulnerabilities?

To address the second research question, we extracted and analyzed tools from the selected studies in detail. Approximately 68% of these tools were identified directly from the primary studies. The criteria used to assess the contextual data quality of the primary studies proved highly effective. Through this analysis, we identified a total of 144 distinct tools listed in Table 9.

*Input and Analysis Types.* The input type most analyzed is the source code. Out of 144 tools, 89 analyze only source code, 44 analyze only bytecode, and 11 analyze both types. It is important to note that all tools are implemented and tested on Solidity code, and Vyper has never been considered.

Static analysis is the most frequent analysis type, with 94 tools conducting only this type of analysis. In contrast, 23 tools perform only dynamic analysis, and 27 tools perform both types of analysis.

*Tool's Functionalities.* Figure 6 details the functionalities implemented by the tools. The most frequent functionality observed is Vulnerability Detection, accounting for 91.6% of cases. This high percentage is expected because many functionalities indirectly contribute to vulnerability detection. These include, for example, tools that analyze the use of gas and resources or offer developer support. An analysis of the functionalities revealed a need for fully automated tools, i.e., performing vulnerability detection with subsequent patch generation and finally fixing vulnerability by updating the contract using the appropriate techniques or patterns. Another lack lies in the tools that deal with exploit generation. In particular, the few tools that generate attack vectors or vulnerable transactions do so to prove the actual presence of the vulnerability they identify. An example is SMARTTEST [86] as discussed by Zhang et al. [126], which aims to detect bugs in smart contracts and generate vulnerable transaction sequences that automatically prove the flaws. A relevant aspect that has emerged is the focus on resource and gas use. Minimizing and optimizing resource use leads to a reduction in fees and, thus, gas.

All this can be translated into savings on the user's side. 21.5% of the tools focus on this aspect, showing interest in optimizing resources and gas. Although most tools focus on vulnerability detection, only some are integrated into development environments, and some still need to be fully implemented. Therefore, further studies are required to investigate the performance of such tools.

Fig. 6. Number of Tools Providing a Specific Functionality.

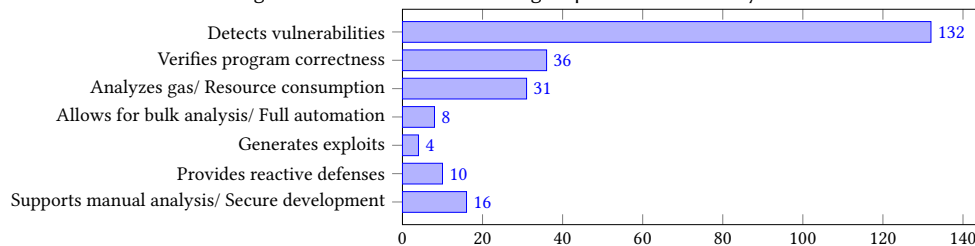

*Code Transformation Techniques.* As shown in Figure 7, the considered tools use different techniques and structures to represent and analyze the code. The most used code structures leveraged by static analysis tools are Control Flow Graphs (CFG), Intermediate Representations, Specification Languages, and Abstract Syntax Trees (AST). Techniques such as Decompilation, Finite State Machines (FSM), and Disassembly remain underutilized. Dynamic analyzers mostly use Data Flow Graphs, Transaction Analysis, and Execution Traces. They use intermediate representations very few times, followed by CFGs and ASTs. When conducting dynamic analysis, contract execution traces, transaction analysis, and data flows are crucial considerations. These techniques can capture the behavior of smart contracts when they are executed. Finally, the most used structures leveraged by tools performing both types of analysis are CFGs, with nine occurrences; Data Flow, Transaction Analysis, and Execution Traces, with seven occurrences; and ASTs, with five occurrences.

*Tool's Methods.* As detailed in Figure 8, several methods are used by tools to analyze code, with some methods being more suitable than others. Static analysis tools mostly use machine learning. Numerous tools extract code metrics to feed ML models, as discussed by Zaazaa and El Bakkali [116], Quian *et al.* [77], and Zhang *et al.* [126]. Peculiar [102] analyzes Crucial Data Flow Graphs extracted from the source code. Ben *et al.* [102] use AST Fuse program Slicing (AFS) to fuse code characteristics and feed them to deep learning models. SC-VDM [113] transforms smart contract bytecode into grayscale matrix pictures and then uses Convolutional Neural Networks (CNNs) for vulnerability detection. Finally, Huang *et al.* [40] developed a smart contract vulnerability detection model based on multi-task learning. In some cases, Machine Learning is supported by Pattern Matching and Syntactical Analysis. For example, GPSCVulDetector [58] combines graph neural networks and pattern matching for comprehensive detection, whereas SVScanner [118] extracts semantic features from AST of different patterns and uses a text CNN to detect contract bugs. Symbolic execution and Taint analysis are also used; for example, SIGUARD [119], RNVulDet [78] and Achecker [30] combine both methods, SmartFast [127] and SESCon [2] focus only on taint analysis while ReDetect [111], and Ethersolve [16, 73] focus on symbolic execution.

Dynamic analysis tools mostly use mutation testing and fuzzing methods. On the one hand, tools like SuMo [4], AMAT [91], and MulESC [93] perform mutation testing to assess the quality of test suites. On the other hand, EVM-Fuzzer [30], IR-Fuzz [59], Ity-Fuzz [84], and SynTest-Solidity [70] perform fuzzing. Effuzz [43] and EtherFuzz [99] combine both techniques, selectively mutating the input for the fuzzing phase.

Some tools perform both static and dynamic analyses by combining different methods. Smartscan [83] identifies potentially vulnerable patterns and then uses dynamic analysis to confirm their precise exploitability.

Fig. 7. Number of Tools Employing a Specific Code Transformation Technique.

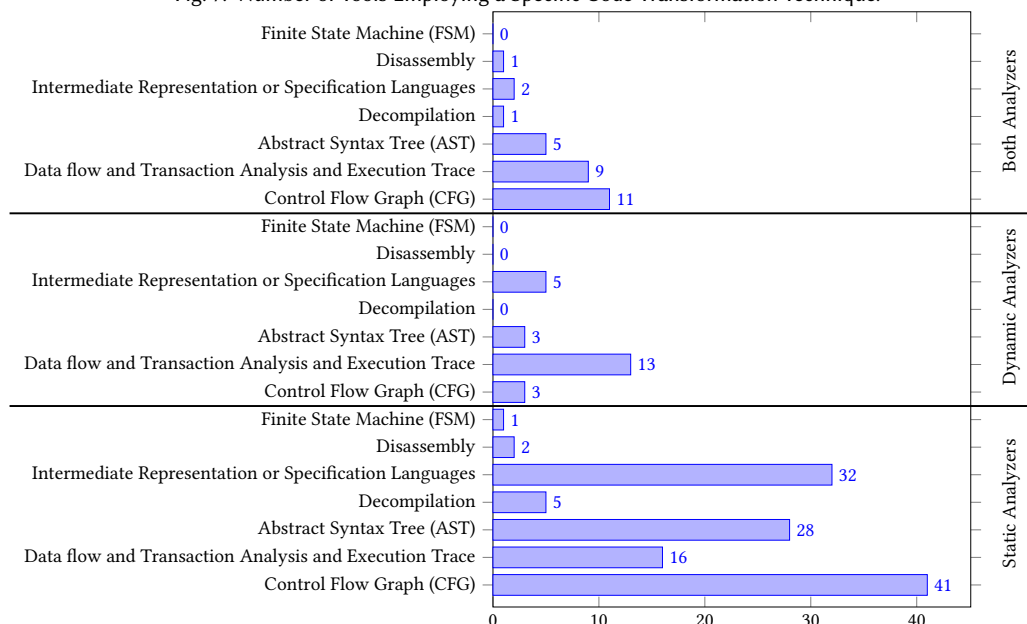

EtherProv [55] leverages Solidity source code static and dynamic analysis data through contract bytecode instrumentation and taint analysis. Finally, VulHunter [51] uses hybrid attention and multi-instance learning mechanisms to detect vulnerabilities, then applies symbolic execution to validate their feasibility.

*Open Source Tools.* The tools identified in our study offer valuable resources and knowledge that can benefit both researchers and practitioners. They can serve as benchmarks and be extended, enhanced, or integrated into development pipelines. However, only 62 of these tools are open-source and publicly available. Of those, few are ready for immediate use, while many remain in the form of demos or experimental implementations designed for performance testing, requiring further development to become fully functional.

**Take-Away RQ<sub>2</sub>.** We collected 144 distinct tools, with 68% sourced from PS. Tools significantly focus on source code analysis (89 tools) and static analysis methods (94 tools). While vulnerability detection is the primary functionality of these tools (91.6%), there is a notable gap in fully automated solutions encompassing vulnerability detection, patch generation, and exploit generation. Additionally, only 62 tools are open-source, with many still requiring further development to achieve full usability. The study emphasizes the need for improved automation and integration of these tools into IDEs to enhance security development practices.

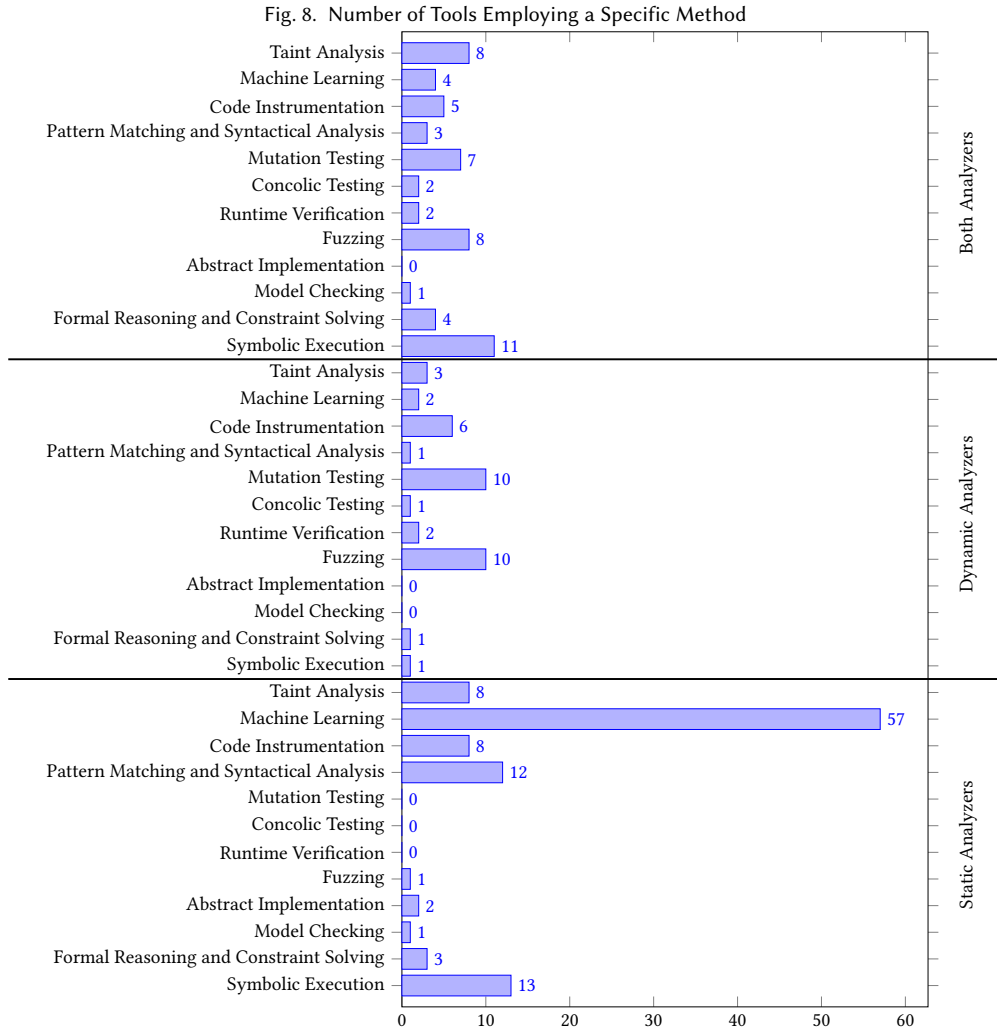

Table 9. A Comprehensive List of Tools.

Tool	Article	Link	Pub. Date	Language	Bytecode	Source Code	Static	Dynamic
SCStudio	[81]	url	2021-03	Python		✓	✓	✓
SmartScan	[94]	url	2021-05			✓	✓	✓
SGUARD	[63]	url	2021-04	Node.js		✓	✓	✓
WANA	[130]	url	2020-08	Python	✓		✓	✓
Artemis	[101]				✓		✓	

Continued on next page

Continued from previous page								
Tool	Article	Link	Pub. Date	Language	Bytecode	Source Code	Static	Dynamic
SCScan	[37]					✓	✓	✓
GasFuzzer	[4]				✓		✓	✓
DEPOSafe	[43]				✓	✓	✓	✓
ReDefender	[95]				✓			✓
Sooyeon <i>et al.</i> Tool	[52]					✓	✓	✓
OYENTE (Enanched version)	[94]				✓		✓	
YuXing <i>et al.</i> tool	[92]					✓		✓
Targy (built on sFuzz)	[44]				✓			✓
OYENTE (Enanched version)	[15]				✓		✓	
Pouyan <i>et al.</i>	[63]					✓	✓	
EtherSolve	[26]	url	2021-03	Java	✓		✓	
CORREAS <i>et al.</i> (Extends GASOL)	[17]				✓	✓	✓	
DeeSCVHunter	[16]	url	2021-04	C		✓	✓	
Fuchen <i>et al.</i> (Extends FISCO-BCOS)	[59]	url	2018-03	C++	✓			✓
Eth2Vec	[74]	url	2021-03	Javascript, Java	✓		✓	
VSCL	[55]				✓		✓	
ESAF	[122]	url	2020-11	Pseudocode	✓		✓	✓
Yuhang <i>et al.</i>	[89]					✓	✓	
Peculiar	[102]	url	2021-07	C		✓	✓	
Ben <i>et al.</i>	[103]					✓	✓	
Wanqing <i>et al.</i>	[46]				✓	✓	✓	
EtherProv	[9]	url	2021-10	Python		✓	✓	✓
SmartGift	[69]	url	2021-10	Python		✓	✓	
AME (CGE)	[83]	url	2021-05	Python		✓	✓	
SC-VDM	[113]				✓		✓	
Xu <i>et al.</i>	[132]					✓	✓	
GPSCVulDetector	[11]	url		Python		✓	✓	
Jianjun <i>et al.</i>	[42]				✓		✓	
Ziyuan <i>et al.</i>	[53]					✓	✓	
Shasha <i>et al.</i>	[21]					✓	✓	
Rejection	[60]					✓	✓	
MENGLIN <i>et al.</i> (Extends Mythril)	[28]				✓		✓	✓
Yuqi <i>et al.</i>	[23]				✓		✓	
Yang <i>et al.</i>	[108]					✓	✓	
EVMFuzzer	[46]	url	2019-08	Python	✓			✓
CodeNet	[14]				✓		✓	
EVMPATCH	[79]	url	2021-08	Python	✓		✓	✓
SmartConDetect	[44]	url	2023-09			✓	✓	
XFuzz	[106]	url	2022-06	C++		✓	✓	✓
RLF	[90]	url	2022-10	Python		✓		✓
IR-Fuzz	[2]	url	2023-01	C++		✓		✓
Ity-Fuzz	[84]	url	2023-06	Rust		✓		✓
SafeSmartContracts	[93]	url	2019-12	Python	✓		✓	
ReChecker (VulDeeSmartContract)	[75]	url	2020-01	Python		✓	✓	
DL-MDF	[19]					✓	✓	
HCC	[34]					✓	✓	
DeFinary (built on SCRepair)	[97]	url	2022-08	JavaScript		✓	✓	✓
JiEtAl2023	[43]					✓	✓	
SmartFast	[41]	url	2022-10	Python		✓	✓	
MSmart	[40]					✓	✓	
SuMo	[76]	url	2022-06	JavaScript		✓		✓
ReSuMo	[111]					✓	✓	✓
Huang <i>et al.</i>	[38]				✓		✓	
M-A-R	[110]	url	2021-08	Python		✓		✓
SMARTEST	[86]					✓	✓	
Porosity	[88]	url	2017-01	C++	✓		✓	✓
MANDO-GURU	[54]	url	2022-11	Python		✓	✓	
MANDO-HGT	[112]	url	2023-01	Python	✓		✓	
SCGRU	[23]					✓	✓	
VulHunter	[78]		2023-11			✓	✓	✓
Vulpedia	[118]	url	2022-06	Python		✓	✓	
ReDetect	[72]				✓	✓	✓	
MEVD	[123]					✓	✓	

Continued on next page

Continued from previous page								
Tool	Article	Link	Pub. Date	Language	Bytecode	Source Code	Static	Dynamic
Dynamit	[30]					✓		✓
Aroc	[52]					✓	✓	
ConFuzzius	[58]	url	2021-09	Python		✓	✓	✓
Cai <i>et al.</i> Framework	[97]					✓	✓	
SmartGraph	[42]					✓	✓	
S-BiGRU	[127]					✓	✓	
GraphSA	[71]					✓	✓	
Duan <i>et al.</i> Framework	[36]				✓	✓	✓	
EDIT	[7]					✓	✓	
ASSBert	[18]					✓	✓	✓
GRATDet	[59]					✓	✓	
Cao <i>et al.</i> Framework	[108]					✓	✓	
AutoMESC	[51]	url	2023-09	Python	✓	✓	✓	✓
AMAT	[87]					✓	✓	✓
RNVulDet	[125]	url	2023-07	Python	✓		✓	✓
SCVDIE	[105]	url	2022-05	Python		✓	✓	
eTainter	[24]	url	2022-07	Python	✓		✓	
Park	[70]					✓	✓	✓
Achecker	[99]	url	2023-05	Python	✓		✓	
SIGUARD	[39]	url	2023-05	Python	✓		✓	
SmartState	[79]	url	2023-07	Python	✓		✓	
Teacher-Student Framework	[29]	url	2023-04	Python	✓		✓	
SynTest-Solidity	[119]	url	2022-05	TypeScript		✓		✓
Elysium	[128]	url	2022-10	JavaScript, Python	✓		✓	
Sollicitous (2.0)	[67]					✓	✓	
MagicMirror	[88]					✓	✓	✓
SMARTIAN	[113]	url	2021-11	F#	✓		✓	✓
CrossFuzz (Extends ConFuzzius)	[4]					✓	✓	✓
Block-Gram	[32]				✓		✓	
EtherGIS	[57]				✓		✓	
ESCORT	[116]				✓		✓	
SVScanner	[25]					✓	✓	
Effuzz	[73]					✓		✓
SmartDagger	[3]				✓		✓	
ReVulDL	[28]	url		Python		✓	✓	
ASGVulDetector	[91]					✓	✓	
BASGVulDetector	[91]				✓		✓	
TxMirror	[8]				✓			✓
TxSpector		url	2020-08	Go	✓			✓
SPCBIG-EC (SPCNN)	[60]	url	2022-06	Python		✓	✓	
CBGRU	[96]	url	2022-05			✓	✓	✓
SmartBugs2.0	[61]	url	2021-11	Python	✓	✓	✓	
GraBit	[37]					✓	✓	
PSCVFinder	[68]					✓	✓	
HGAT	[120]					✓	✓	
EtherFuzz	[13]					✓		✓
SoliTester	[5]					✓		✓
sFuzz2.0	[6]	url	2023-02	C++		✓		✓
HeEtAl2024	[34]				✓		✓	
TIPS	[93]	url	2023-09	Python		✓	✓	
SCsVulLyzer	[107]	url	2024-02	Python		✓	✓	
EtherSolve2.0 (Extends EtherSolve)	[109]	url	2023-03	Java	✓		✓	
MODNN	[124]				✓	✓	✓	
SuperDetector	[131]					✓	✓	
SoliDetector	[121]					✓	✓	
SCcheck	[82]					✓	✓	
SESScon	[98]					✓	✓	
Sailfish (built on Slither)	[20]					✓	✓	
MuIESC	[17]	url	2022-02	Python		✓		✓
FSL-Detect	[62]				✓		✓	
EthVer	[100]	url	2021-09	Haskell		✓	✓	
Gas Gauge	[102]	url	2021-12	Python		✓	✓	✓
Pakala	[57]	url	2018-12	Python	✓		✓	

Continued on next page

Continued from previous page								
Tool	Article	Link	Pub. Date	Language	Bytecode	Source Code	Static	Dynamic
SolGuard (Extends Solhint)	[31]		2021-08			✓	✓	
Ethlint		url	2018-01	JavaScript		✓	✓	
Solitor	[86]	url	2018-11	Java		✓		✓
SCSVM	[92]					✓	✓	
SCLMF	[92]					✓	✓	
Kaya	[106]	url	2020-10	JavaScript, Python		✓		✓
ConFuzzius-BI	[53]	url	2022-12	Python		✓	✓	✓
Horus	[27]	url	2021-01	Python		✓		✓
Ethchecker	[33]				✓		✓	
Developer	[104]					✓	✓	
DL4SC	[56]	url	2024-03	Python	✓		✓	
HARDEN	[50]				✓		✓	
Jie <i>et al.</i> Framework	[46]					✓	✓	

### 4.3 RQ3. Which Vulnerabilities Do the Tools Address?

Several tools were not included in this mapping for specific reasons. For instance, tools that were not explicitly designed to detect vulnerabilities, such as compilers [62] and decompilers [88], were omitted. We also excluded tools that do not focus on specific vulnerabilities but instead apply machine learning to classify smart contracts as vulnerable [18, 71] or use mutation testing without focusing on vulnerability-specific mutation operators [70, 91]. These tools are too generic to be mapped accurately. Next, we analyzed each tool individually to identify the vulnerabilities they detected. During this mapping process, several challenges arose. Many tools claimed to detect broad categories of vulnerabilities, such as 'DoS vulnerabilities,' 'Gas-related vulnerabilities,' 'Access Control Vulnerabilities,' and 'Arithmetic vulnerabilities' [30, 65, 84, 105, 128]. However, in our taxonomy, these labels represent categories that include multiple distinct vulnerabilities. Mapping these tools to all vulnerabilities within such categories would lead to a broad generalization; therefore, we only mapped tools to specific vulnerabilities closely aligned with our taxonomy. Our focus was also on tools that facilitate patch generation to address vulnerabilities. For instance, tools like Elysium [28] that rely on other tools for the detection phase were mapped only to the vulnerabilities for which they can generate patches. Finally, tools that aggregate several others [20, 97] or that lacked sufficient documentation [86, 106][102] were also not fully mapped. For these, we mapped only the well-defined vulnerabilities that matched our taxonomy. The mapping includes 122 tools in total. Of these, 86 were fully mapped, while 36 were partially mapped because the tools identified vulnerabilities that were too generically described for precise categorization.

The results show that the vulnerability most frequently analyzed is Reentrancy, with 97 tools, followed by Timestamp Dependency, with 57 tools, and Integer Overflow/Underflow, with 46 tools. This knowledge is informative and crucial for understanding the current state of vulnerabilities in smart contracts. It is worth highlighting that the tools identified in our study cannot identify all the vulnerabilities present in our taxonomy. Out of 101 vulnerabilities, 38 are not addressed by tools. Furthermore, out of 63 addressed vulnerabilities, only 11 are detected by at least 10 tools. In other words, several vulnerabilities can be detected by a few available tools.

 **Take-Away RQ3.** We mapped 144 tools to our taxonomy. Notably, 86 tools were fully mapped, 36 were only partially mapped due to generic descriptions of the vulnerabilities they identified, and 22 were not mapped due to their functionalities. The results indicate that Reentrancy is the most commonly analyzed vulnerability, detected by 97 tools, followed by Timestamp Dependency (57 tools) and Integer Overflow/Underflow (46 tools). Our study revealed significant gaps in coverage: 38 vulnerabilities from our taxonomy remain unaddressed.

### 4.4 RQ4. How are the Tools Evaluated?

Table 10 shows collected benchmarks. The "Discussed in" column contains a paper that cites the benchmark, while the "Publication" column contains a paper that releases the benchmark. We collected 102 benchmarks, out of which 72 were used to evaluate and compare the performance of multiple tools; we could not find information concerning , Vol. 1, No. 1, Article . Publication date: December 2024.



the usage of the remaining 30 benchmarks. Most benchmarks, i.e., 61, contain only smart contracts written in Solidity, while 17 include only bytecode and nine include both. We could not find information concerning the remaining 15 benchmarks. Furthermore, some tools did not release the benchmarks used for their evaluation, and some benchmarks are closed to users and require access authorization (Vulpedia's benchmark<sup>3</sup>, SCsVulLyzer benchmark<sup>4</sup>). We found that 44 of the 102 benchmarks are public and accessible, providing a significant resource for the community. Additionally, 17 benchmarks include the analysis results of tools evaluations.

**Take-Away RQ4.** We collected 102 benchmarks used for tool performance evaluations. The majority (61) contain Solidity contracts, while some include bytecode or both. Notably, 44 benchmarks are publicly accessible, and 17 benchmarks provide tool evaluation results that contribute valuable data to the community.

Table 10. A List of the Benchmarks used in the Literature.

Discussed in	Publication	Tools	Link	N. Contracts	Analysis Results	Source Code	Bytecode	Addresses
[75]	[3]	-	-	12	-	-	✓	-
[75]	[5]	-	-	-	-	-	-	-
[75]	[6]	-	-	112,802	-	-	✓	-
[75]	[10]	sCompile	-	36,099	-	✓	-	-
[75]	[11]	Deviant	-	3	-	✓	-	-
[75]	[12]	-	-	36,764	-	✓	-	-
[75]	[14]	-	-	16,000	-	✓	-	-
[75]	[20]	-	-	2	-	✓	-	-
[75]	[22]	DOORchain	-	-	-	✓	-	-
[75]	[25]	Slither	-	36,000	-	✓	-	-
[75]	[29]	-	-	10,000	-	✓	-	-
[75]	[31]	Easyflow	-	-	-	-	✓	-
[75]	[35]	MadMax	-	-	-	✓	-	-
[75]	[36]	-	-	3,444,354	-	✓	-	-
[75]	[39]	-	-	18,498	-	✓	-	-
[75]	[40]	-	-	-	-	-	✓	-
[75]	[41]	-	-	-	-	✓	-	-
[75]	[45]	-	-	482	-	✓	-	-
[75]	[50]	-	-	-	-	-	✓	-
[75]	[51]	-	-	7,000	-	✓	-	-
[75]	[54]	MuSC	-	-	-	✓	-	-
[75]	[58]	EVM*	-	10	-	-	✓	-
[75]	[61]	SolUnit	-	-	-	✓	-	-
[75]	[64]	-	-	13,745	-	✓	-	-
[75]	[65]	Manticore	-	100	-	✓	-	-
[75]	[68]	-	-	-	-	✓	-	-
[75]	[70]	-	-	970,898	-	-	✓	-
[75]	[71]	-	-	-	-	-	✓	-
[75]	[72]	SIF, SolAnalyser, Oyente, Securify, Maian, SmartCheck, Mythril	-	1,838	-	✓	-	-
[75]	[83]	-	-	-	-	✓	✓	-
[75]	[84]	-	-	-	-	✓	-	-
[75]	[95]	-	-	20	-	-	✓	-
[75]	[98]	Osiris	url	50,535	✓	-	✓	✓
[75]	[99]	Solidify	-	24,594	✓	-	✓	-
[75]	[99]	Solidify	-	100	✓	✓	-	-
[75]	[105]	-	-	-	-	✓	-	-
[75]	[109]	-	-	31,097	-	-	✓	-
[75]	[110]	-	-	49,522	-	✓	-	-
[75]	[111]	-	-	2,214,409	-	-	✓	-
[75, 116]	[85]	Oyente, ContractWard	-	49,502	-	✓	-	-

Continued on next page

<sup>3</sup>[https://drive.google.com/file/d/1kizsz0\\_8B8nP4UNVr0gYjaj25VVZMO8C/edit](https://drive.google.com/file/d/1kizsz0_8B8nP4UNVr0gYjaj25VVZMO8C/edit)

<sup>4</sup><https://www.yorku.ca/research/bccc/ucs-technical/cybersecurity-datasets-cds/>

Continued from previous page									
Discussed in	Publication	Tools	Link	N. Contracts	Analysis Results	Source Code	Bytecode	Addresses	
[75, 116]	[32]	Deckard, SmartCheck, SMARTEMBED	url	22,725	-	✓	-	✓	
[75, 116]	[96]	Smartcheck	url	4,600	-	✓	-	-	
[75, 116]	[104]	NPChecker, Securify, Oyente, Mythril	-	30,000	-	✓	✓	-	
[116]	-	Smartcheck, Oyente, Mythril, Securify, Slither, Osiris, DeeSCVHunter	url	-	-	✓	-	-	
[116]	-	Smartcheck, Oyente, Mythril, Securify, Slither, Osiris, DeeSCVHunter	url	-	-	✓	-	-	
[116]	-	Smartcheck, Oyente, Mythril, Securify, Slither, Osiris, DeeSCVHunter	url	-	-	✓	✓	-	
[116]	-	Slither	url	-	-	-	-	✓	
[116]	-	Yingjie et al., SmartBugs, Solid-ify	url	-	✓	✓	-	-	
[116]	[76]	VulDeeSmartContract (their tool also called BLSTM-ATT), Securify, SmartCheck, Mythril, Oyente	url	-	✓	✓	-	-	
[116]	[55]	SoliAudit, Oyente, Remix	url	21,044	-	-	-	✓	
[116]	[102]	Peculiar	url	40,742	✓	✓	-	✓	
[116]	[4]	GasFuzzer	url	3,170	-	-	-	✓	
[116]	[83]	SmartScan, SmartCheck	-	500	-	-	-	-	
[116]	[69]	SGUARD	-	5,000	-	-	-	-	
[116]	[72]	ReDefender	-	204	-	-	-	-	
[116]	[72]	ReDefender	-	395	-	-	-	-	
[116]	[16]	EtherSolve	-	1,000	-	-	-	-	
[116]	[3]	Eth2Vec	-	95,152	-	-	-	-	
[116]	[130]	SMARTGIFT	-	-	-	-	-	-	
[116]	[57]	AME (CGE)	-	40,932	-	✓	-	-	
[116]	[42]	Jianjun et al tool	-	2,000,000	-	-	✓	-	
[116]	[27]	ÆGIS, ECFChecker, Sereum	-	675,444	-	✓	-	-	
[116]	[90]	SC Analyzer	url	55,046	-	✓	-	-	
[116]	[69]	sfuzz, ContractFuzzer, Oyente	-	4,112	-	✓	-	-	
[116]	[101]	Artemis, Maian	-	12,899	-	✓	-	-	
[116]	[38]	SCScan	-	1,000	-	✓	-	-	
[116]	[107]	Clairvoyance, Slither, Oyente, Securify	url	11,714	✓	✓	-	✓	
[116]	[26]	Smartbugs	url	47,398	✓	✓	-	✓	
[116]	[1]	SAFEVM, VeryMax, SeaHorn, CPAchecker, Oyente, EthIR	url	24,294	-	✓	-	✓	
[116]	[1]	SAFEVM	url	29	-	✓	-	✓	
[116]	[16]	OYENTE, MAIAN, Mythril, Evmdis, Miasm, Porosity	-	4,979,625	-	-	-	-	
[116]	[74]	Mythril-enhanced version	-	167,698	✓	-	-	-	
[116]	[112]	SASC, oyente	-	2,952	-	-	-	-	
[21]	[82]	eThor	url	720	-	-	✓	✓	
[21]	[114]	EverEvolvingG	url	344	-	✓	-	✓	
[21]	[26]	SmartBugs	url	143	-	✓	-	-	
-	[21]	-	url	4,859	-	✓	✓	✓	
-	[42]	SmartConDetect	url	10,000	-	✓	-	-	
-	[10]	-	url	-	✓	✓	✓	✓	
-	[127]	SmartFast	url	149	✓	✓	-	-	
-	[127]	SmartFast	url	13,509	✓	✓	-	✓	
-	[68]	MANDO-HGT, MANDO-GURU	url	-	✓	✓	-	-	
-	[68]	MANDO-HGT, MANDO-GURU	url	-	✓	✓	✓	✓	
-	[109]	Vulpedia	url	-	-	-	-	-	
-	[31]	MEVD	url	-	✓	✓	-	-	
-	[23]	Duan et al. Framework	url	-	-	-	-	-	

Continued on next page

Continued from previous page

Discussed in	Publication	Tools	Link	N. Contracts	Analysis Results	Source Code	Bytecode	Addresses
-	[78]	RNVulDet	url	-	-	-	-	✓
-	[88]	SmartState	url	-	-	✓	-	✓
-	[14]	Smartian	url	-	-	✓	✓	✓
-	[32]	SCsVullyzer	-	-	-	✓	-	-
-	[122]	MODNN	url	18,796	-	✓	-	-
-	[17]	SuperDetector	url	-	-	✓	-	✓
-	[17]	SuperDetector	url	-	-	✓	-	✓
-	[37]	SolidDetector	url	-	-	✓	-	✓
-	[66]	Gas Gauge	url	-	✓	✓	-	✓
-	[85]	-	url	-	-	✓	-	-
-	[79]	Teacher-Student framework	url	-	-	-	✓	-
-	[79]	Teacher-Student framework	url	-	-	✓	-	-
-	[92]	ConFuzzius-BI	url	43	-	✓	-	-
-	[92]	ConFuzzius-BI	url	19	-	✓	-	✓
-	[101]	-	url	110	✓	✓	-	-
-	[19]	-	url	248,328	-	✓	✓	✓

## 5 DISCUSSION AND IMPLICATIONS

This section discusses the difference between our study and the updated SLR [78] and the research opportunity highlighted by the results.

### 5.1 Taxonomy Differences

As highlighted by the literature review we updated [78], we confirm that some vulnerabilities describe specific and limited cases of a broader problem. Therefore, we organized our taxonomy on two levels to provide an easy understanding of the high-level problems. This structure also allows highlighting specific vulnerabilities that could arise from high-level issues. We kept the vulnerability identifiers of the updated literature to maintain the mapping with the SWC Registry<sup>5</sup> and DASP Top 10<sup>6</sup> taxonomies, previously mapped in previous work [78].

### 5.2 Tool Differences Compared to the 2016-2021 Period

The number of tools developed (144) has grown proportionally from 2021 to 2024 compared to the period from 2016 to 2021 (140 tools). The demand for secure development has also grown with the increasing interest in DApps and security. However, the literature lacks comprehensive best practices or guidelines for secure smart contract development.

*Functionalities.* About the functionalities of developed tools, we observed a significant increase in the use of vulnerability detection tools, rising from 79.5% to 92.8%. Resource analysis and gas usage are also up sharply, from 12.1% to 22.3%, signaling an increasing focus on issues such as sustainability and security. In contrast, there is a decrease in the search for more comprehensive and articulated solutions such as Full Automation and Bulk Analysis, which drop from 41.3% to 5.7%. The focus on exploit generation has also decreased, from 7.1% to 2.9%. These data indicate a shift in priorities toward security and resource efficiency.

*Code Transformation Techniques.* The use of code transformation techniques has remained more or less stable. A slight increase was seen in using CFG, DFG, Execution Traces, and Transactions. Techniques such as disassembly and FSM are less widely used.

*Methods.* Methods such as mutation testing, fuzzing, taint analysis, and machine learning are increasingly used. Furthermore, methods such as formal reasoning and constraint solving, model checking, pattern matching, and abstract interpretation are being dropped. Remain invariable with the use of code instrumentation. Several experiments currently combine multiple methods. However, the future of research is shifting towards using LLMs

<sup>5</sup><https://swcregistry.io/>

<sup>6</sup><https://dasp.co/>

capable of performing refactoring and code repair operations, thereby supporting the removal of vulnerabilities from smart contracts.

### 5.3 Vulnerabilities Addressed by Tools

In the previous study [78], the mapping between tools and vulnerabilities was not completely conducted. The reason was that each tool employs different methods and may classify contracts differently, even when they seemingly address the same vulnerability. Tools also refer to taxonomies incompatible with each other. However, our taxonomy serves as a point of aggregation of many state-of-the-art classifications and allows us to map tools and vulnerabilities.

### 5.4 Research Opportunities

*Vulnerability Layers.* Our taxonomy focuses mainly on the vulnerabilities affecting smart contracts. A blockchain comprises several layers besides the application and presentation layers to which the SCs belong. The Consensus Layer, Network Layer, Data Layer, and Infrastructure Layer each present additional vulnerabilities that need more attention. The shift to Proof of Stake (PoS) has solved many of Ethereum's structural vulnerabilities related to mining and centralization (Selfish mining, 51% Attack, Replay Attack), making the network more secure, sustainable, and resistant to attacks. However, PoS also introduces new challenges related to governance, stake concentration, and validator protection, which need to be addressed through appropriate security mechanisms and incentives.

*Performance Comparison.* The tools proposed in the current state of the art offer significant benefits, offering researchers and practitioners several approaches and methods to adopt. However, understanding the optimal solution based on specific needs remains unclear due to the challenge of obtaining a comprehensive understanding of tools' performance. Many tools rely on different benchmarks for performance evaluation, and the execution environments and conditions differ, making it challenging to conduct fair and consistent comparisons. Additional analysis is needed to examine the specific implementations, methods, and techniques to address each vulnerability.

*Secure-by-design and Sustainability.* There is a notable gap in tools that support developers during the early stages of code implementation. Few tools are designed to be integrated into integrated development environments (IDEs) or development pipelines. Given the immutable nature of blockchain, it is necessary to focus on developing secure smart contracts by design, reducing the need for time-consuming patch generation and code repair systems. This approach enhances security and offers significant advantages from a sustainability perspective. The blockchain ecosystem is notorious for its high energy consumption, and replacing faulty smart contracts with vulnerability-free versions aggravates this issue. Deploying and discarding faulty contracts is an unsustainable practice contributing to unnecessary energy waste. By prioritizing secure development practices, we can reduce environmental impact, improve the overall efficiency of blockchain operations, and enhance the security of SCs.

*Tool Coverage Gaps.* Our mapping of tools to vulnerabilities offers a clear view of how the literature is evolving. Unsurprisingly, most tools focus on well-known vulnerabilities such as Reentrancy, Timestamp Dependence, and Integer Over/Underflow. However, there is a noticeable lack of interest in addressing many other vulnerabilities. According to our findings, the top 10 identified vulnerabilities (10%) are addressed by an average of 37 tools each. In contrast, the next 53% of vulnerabilities attract significantly less attention, with an average of only three tools per vulnerability. Furthermore, the remaining 37% of vulnerabilities are not addressed by any tool. The top 10 vulnerabilities are not guaranteed to have the most significant impact and may deserve further scrutiny. This mapping reveals a substantial gap in interest for a wide range of vulnerabilities.

*Unexplored Solution.* Further analysis is needed to examine the specific implementations, methods, and techniques to address each vulnerability. This would also help identify unexplored combinations of solutions that could be further developed. Our mapping provides a foundation for this more profound analysis. Future research in this field could explore new solutions and combinations that have not yet been implemented or tested.

*Consolidated Ground of truth.* We verified the ground truth of the benchmarks wherever possible. Given that some benchmark sizes were expressed using the number of chain blocks or files, we further investigated and reported their size in terms of the number of SCs they contain. A key aspect of benchmarks is how they are created. Most are sourced from Etherscan [16, 69, 83], which allows for the consultation of smart contracts deployed on the blockchain. However, others are purpose-built and contain SCs manually injected with vulnerabilities [17, 92]. For instance, Sun *et al.* [92] manually injected 19 SCs with eight different vulnerabilities. This study emphasizes the need for consistent benchmarks free of false positives, numerous in instances, and broad in vulnerability coverage, which can serve as standards for tool evaluation. Their contribution would improve tool assessment and facilitate a fair, unbiased comparison of their performance.

## 6 THREATS TO VALIDITY

The section describes the possible threats to validity, i.e., construct, internal, external, and conclusion [115].

### 6.1 Construct Validity

*Search Method.* Missing relevant primary studies could seriously impact SLR quality. Therefore, we adopted different strategies to collect as many studies as possible. We used the five most common digital libraries. We applied backward and forward snowballing to the results from the Digital Libraries and forward snowballing to the study of Ramender *et al.* [78]. In addition, we analyzed the five main conferences in the field under analysis to conduct the research as comprehensively as possible.

*Inappropriate or Incomplete Terms in Search Strings.* The research strings and terms used may affect the construct validity. We used the same research strings of the SLR we updated, as they were well-discussed and motivated, and customized them for each digital library.

### 6.2 Internal Validity

*Publication Bias.* Positive results are more likely to be published than negative results. Furthermore, some studies tend to report particular success stories. We checked the suitability of each study using inclusion/exclusion criteria to avoid considering only papers reporting positive results.

*Subjective Quality Assessment.* The paper assessment was based on our judgment, which could have been biased, expressing a threat. Inclusion and exclusion criteria helped us reduce the number of studies to be analyzed. We independently conducted the quality assessment using a form to evaluate all studies, leveraging a form featuring multiple well-defined and detailed answers that left little room for subjectivity. They used two question forms: one for SLRs and Surveys and one for PS.

### 6.3 External Validity

*Restricted Resources.* The restricted number of researchers who worked on the study could affect the external validity. In the planning phase, we established externally validated roles and tasks to be carried out.

*Inaccessible Papers and Databases.* A relevant aspect concerns the inaccessibility of papers and databases, which was primarily resolved using numerous digital libraries, constructing customized research strings for each digital

library, and applying exclusion criteria number four, which excludes papers not accessible online via the library network of our university.

#### 6.4 Conclusion Validity

*Study Misclassification.* Quality appraisal was based on the paper classification (i.e., SLR, survey, and primary studies) performed at the beginning of the research. Thus, some studies could have been mistakenly classified and subsequently appraised. However, some quality assessment questions, particularly those related to primary studies, do not apply to surveys or SLRs, contributing to the correct classification of the analyzed studies.

*Bias in Study Selection.* Misinterpretations of the title or the abstract could affect the study selection. During the data extraction process, we checked the citation whenever a citation contained relevant information for our study. When an original study cited in the papers was not present among the studies selected for our research but in the list of papers extracted, it was recovered thanks to question 1 of the CDQ form of primary studies. This practice allowed us to recover studies that had initially been discarded.

*Benchmarks Labelling and Validation Process.* The labeling process could have been conducted manually or automatically. Some benchmarks are manually labeled [17, 31, 42, 72, 88, 101], whereas, automated labeling is quite challenging. Not all vulnerability patterns are used; some are not well-researched, and it is hard to ensure sufficient patterns, leading to benchmarks featuring false positives that directly impact the performance of the tools. Finally, the validation processes should be better described and documented.

## 7 CONCLUSION

This paper presents a systematic literature review on smart contract vulnerabilities, detection tools, and benchmarks used for tool evaluation. The review covers various research aspects and aims to assess the current challenges related to smart contract security.

Our taxonomy merges the vulnerabilities identified in the literature through a rigorous SLR process. It serves as a comprehensive aggregation of the most state-of-the-art classifications. It addresses the existing confusion in the literature by organizing vulnerabilities into a clear hierarchical structure, reducing inconsistencies in nomenclature and making it easier to navigate. This structured categorization enables users to quickly capture the nature of the vulnerabilities, facilitating a more immediate understanding of the potential issues being addressed.

Our SLR revealed many aspects to investigate, and as described in Section 5, there are many opportunities. Our research will focus on constructing new benchmarks by mutating smart contracts, we will explore the detection of vulnerabilities, in particular by conducting software component analysis, and we will set up an infrastructure that allows the tools to run within the same environment, under the same conditions, and using the same benchmarks, in order to compare their performance fairly and unbiased. Our work aims to provide the basis for future research, offering a valuable resource for researchers interested in advancing this field, which could greatly benefit from additional empirical studies and investigations.

## ACKNOWLEDGMENT

This work has been partially funded by the European Union under NextGenerationEU with the *SMARTITUDE* research project, which has been funded by MUR under the PRIN 2022 program (Code: 202233YFCJ). Views and opinions expressed are however those of the author(s) only and do not necessarily reflect those of the European Union or The European Research Executive Agency. Neither the European Union nor the granting authority can be held responsible for them. We thank Fabiano Izzo and the AstraKode team for the fruitful discussions that motivated our literature review and allowed us to elaborate on its implications.

## PAPERS INCLUDED IN THE SYSTEMATIC LITERATURE REVIEW

- [A1] Rachit Agarwal, Tanmay Thapliyal, and Sandeep Kumar Shukla. 2021. Vulnerability and Transaction Behavior Based Detection of Malicious Smart Contracts. In *Cyberspace Safety and Security: 13th International Symposium, CSS 2021, Virtual Event, November 9–11, 2021, Proceedings*. Springer-Verlag, Berlin, Heidelberg, 79–96. [https://doi.org/10.1007/978-3-030-94029-4\\_6](https://doi.org/10.1007/978-3-030-94029-4_6)
- [A2] Amir Ali, Zain Ul Abideen, and Kalim Ullah. 2021. SESCon: Secure Ethereum Smart Contracts by Vulnerable Patterns' Detection. *Security and communication networks 2021* (2021), 1–14.
- [A3] Nami Ashizawa, Naoto Yanai, Jason Paul Cruz, and Shingo Okamura. 2021. Eth2Vec: Learning Contract-Wide Code Representations for Vulnerability Detection on Ethereum Smart Contracts. In *Proceedings of the 3rd ACM International Symposium on Blockchain and Secure Critical Infrastructure* (Virtual Event, Hong Kong) (*BSCI '21*). Association for Computing Machinery, New York, NY, USA, 47–59. <https://doi.org/10.1145/3457337.3457841>
- [A4] Morena Barboni, Andrea Morichetta, and Andrea Polini. 2022. SuMo: A mutation testing approach and tool for the Ethereum blockchain. *Journal of Systems and Software* 193 (2022), 111445. <https://doi.org/10.1016/j.jss.2022.111445>
- [A5] Morena Barboni, Andrea Morichetta, Andrea Polini, and Francesco Casoni. 2023. ReSuMo: a regression strategy and tool for mutation testing of solidity smart contracts. *Software Quality Journal* 32, 1 (jun 2023), 225–253. <https://doi.org/10.1007/s11219-023-09637-1>
- [A6] Priyanka Bose, Dipanjan Das, Yanju Chen, Yu Feng, Christopher Kruegel, and Giovanni Vigna. 2022. SAILFISH: Vetting Smart Contract State-Inconsistency Bugs in Seconds. In *2022 IEEE Symposium on Security and Privacy (SP)*. IEEE, 161–178.
- [A7] Jie Cai, Bin Li, Jiale Zhang, Xiaobing Sun, and Bing Chen. 2023. Combine sliced joint graph with graph neural networks for smart contract vulnerability detection. *Journal of Systems and Software* 195 (2023), 111550.
- [A8] Yuanlong Cao, Fan Jiang, Jianmao Xiao, Shaolong Chen, Xun Shao, and Celimuge Wu. 2023. SCcheck: A Novel Graph-driven and Attention-enabled Smart Contract Vulnerability Detection Framework for Web 3.0 Ecosystem. *IEEE Transactions on Network Science and Engineering* (2023), 1–12. <https://doi.org/10.1109/TNSE.2023.3324942>
- [A9] Yuanlong Cao, Fan Jiang, Jianmao Xiao, Shaolong Chen, Wei Yang, and Yugen Yi. 2023. Data Flow-driven and Attention Mechanism-enabled Smart Contract Vulnerability Detection for Secure and Green Blockchain-based Service Networks. In *ICC 2023 - IEEE International Conference on Communications*. 5135–5140. <https://doi.org/10.1109/ICC45041.2023.10279381>
- [A10] Stefanos Chaliasos, Marcos Antonios Charalambous, and Liyi Zhou. 2023. Smart Contract and DeFi Security Tools: Do They Meet the Needs of Practitioners? <https://synthical.com/article/ed404388-ffad-11ed-9b54-72eb57fa10b3>. arXiv:2304.02981 [cs.CR]
- [A11] Jiachi Chen, Xin Xia, David Lo, John Grundy, Xiapu Luo, and Ting Chen. 2022. DefectChecker: Automated Smart Contract Defect Detection by Analyzing EVM Bytecode. *IEEE Transactions on Software Engineering* 48, 7 (2022), 2189–2207. <https://doi.org/10.1109/TSE.2021.3054928>
- [A12] Jiachi Chen, Xin Xia, David Lo, John Grundy, Xiapu Luo, and Ting Chen. 2022. Defining Smart Contract Defects on Ethereum. *IEEE transactions on software engineering* 48, 1 (2022), 327–345.
- [A13] Qianguo Chen, Teng Zhou, Kui Liu, Li Li, Chunpeng Ge, Zhe Liu, Jacques Klein, and Tegawendé F. Bissyandé. 2023. Tips: towards automating patch suggestion for vulnerable smart contracts. *Automated software engineering* 30, 2 (2023), 31.
- [A14] Jaeseung Choi, Doyeon Kim, Soomin Kim, Gustavo Grieco, Alex Groce, and Sang Kil Cha. 2021. SMARTIAN: Enhancing Smart Contract Fuzzing with Static and Dynamic Data-Flow Analyses. In *2021 36th IEEE/ACM International Conference on Automated Software Engineering (ASE)*. 227–239. <https://doi.org/10.1109/ASE51524.2021.9678888>
- [A15] Hanting Chu, Pengcheng Zhang, Hai Dong, Yan Xiao, Shunhui Ji, and Wenrui Li. 2023. A survey on smart contract vulnerabilities: Data sources, detection and repair. *Information and Software Technology* (2023), 107221.
- [A16] Filippo Contro, Marco Crosara, Mariano Ceccato, and Mila Dalla Preda. 2021. EtherSolve: Computing an Accurate Control-Flow Graph from Ethereum Bytecode. In *2021 IEEE/ACM 29th International Conference on Program Comprehension (ICPC)*. 127–137. <https://doi.org/10.1109/ICPC52881.2021.00021>
- [A17] Meiyi Dai, Zhe Yang, and Jian Guo. 2022. SuperDetector: A Framework for Performance Detection on Vulnerabilities of Smart Contracts. *Journal of physics. Conference series* 2289, 1 (2022), 12010.
- [A18] Andrea De Salve, Alessandro Brighente, and Mauro Conti. 2024. EDIT: A data inspection tool for smart contracts temporal behavior modeling and prediction. *Future Generation Computer Systems* 154 (2024), 413–425.
- [A19] Monika Di Angelo, Thomas Durieux, João Ferreira, and Gernot Salzer. 2023. Evolution of Automated Weakness Detection in Ethereum Bytecode: a Comprehensive Study. *Empirical Software Engineering* 29 (11 2023). <https://doi.org/10.48550/arXiv.2303.10517>
- [A20] Monika di Angelo, Thomas Durieux, Joao F. Ferreira, and Gernot Salzer. 2023. SmartBugs 2.0: An Execution Framework for Weakness Detection in Ethereum Smart Contracts. In *2023 38th IEEE/ACM International Conference on Automated Software Engineering (ASE)*. IEEE, 2102–2105.
- [A21] Monika di Angelo and Gernot Salzer. 2024. Consolidation of Ground Truth Sets for Weakness Detection in Smart Contracts. In *Financial Cryptography and Data Security: FC 2023 International Workshops*, Aleksander Essex, Shin'ichiro Matsuo, Oksana Kulyk, Lewis Gudgeon, Ariah Klages-Mundt, Daniel Perez, Sam Werner, Andrea Bracciali, and Geoff Goodell (Eds.). Springer Nature Switzerland, Cham, 439–455.

- [A22] Bruno Dia, Naghmeh Ivaki, and Nuno Laranjeiro. 2021. An Empirical Evaluation of the Effectiveness of Smart Contract Verification Tools. In *2021 IEEE 26th Pacific Rim International Symposium on Dependable Computing (PRDC)*. 17–26. <https://doi.org/10.1109/PRDC53464.2021.00013>
- [A23] Li Duan, Liu Yang, Chunhong Liu, Wei Ni, and Wei Wang. 2023. A New Smart Contract Anomaly Detection Method by Fusing Opcode and Source Code Features for Blockchain Services. *IEEE Transactions on Network and Service Management* 20, 4 (2023), 4354–4368. <https://doi.org/10.1109/TNSM.2023.3278311>
- [A24] Mojtaba Eshghie, Cyrille Artho, and Dilian Gurov. 2021. Dynamic Vulnerability Detection on Smart Contracts Using Machine Learning. In *Proceedings of the 25th International Conference on Evaluation and Assessment in Software Engineering (Trondheim, Norway) (EASE '21)*. Association for Computing Machinery, New York, NY, USA, 305–312. <https://doi.org/10.1145/3463274.3463348>
- [A25] Jijia Fei, Xiaohan Chen, and Xiangfu Zhao. 2023. MSmart: Smart Contract Vulnerability Analysis and Improved Strategies Based on Smartcheck. *Applied Sciences* 13, 3 (2023), 1733.
- [A26] Huadong Feng, Xiaolei Ren, Qiping Wei, Yu Lei, Raghu Kacker, D. Richard Kuhn, and Dimitris E. Simos. 2023. MagicMirror: Towards High-Coverage Fuzzing of Smart Contracts. In *2023 IEEE Conference on Software Testing, Verification and Validation (ICST)*. 141–152. <https://doi.org/10.1109/ICST57152.2023.00022>
- [A27] Christof Ferreira Torres, Antonio Ken Iannillo, Arthur Gervais, and Radu State. 2021. The Eye of Horus: Spotting and Analyzing Attacks on Ethereum Smart Contracts. In *Financial Cryptography and Data Security*, Nikita Borisov and Claudia Diaz (Eds.). Springer Berlin Heidelberg, Berlin, Heidelberg, 33–52.
- [A28] Christof Ferreira Torres, Hugo Jonker, and Radu State. 2022. Elysium: Context-Aware Bytecode-Level Patching to Automatically Heal Vulnerable Smart Contracts. In *Proceedings of the 25th International Symposium on Research in Attacks, Intrusions and Defenses (Limassol, Cyprus) (RAID '22)*. Association for Computing Machinery, New York, NY, USA, 115–128. <https://doi.org/10.1145/3545948.3545975>
- [A29] Asem Ghaleb, Julia Rubin, and Karthik Pattabiraman. 2022. eTainter: detecting gas-related vulnerabilities in smart contracts. In *Proceedings of the 31st ACM SIGSOFT International Symposium on Software Testing and Analysis (<conf-loc>, <city>Virtual</city>, <country>South Korea</country>, </conf-loc>) (ISSTA 2022)*. Association for Computing Machinery, New York, NY, USA, 728–739. <https://doi.org/10.1145/3533767.3534378>
- [A30] Asem Ghaleb, Julia Rubin, and Karthik Pattabiraman. 2023. AChecker: Statically Detecting Smart Contract Access Control Vulnerabilities. In *Proceedings of the 45th International Conference on Software Engineering (Melbourne, Victoria, Australia) (ICSE '23)*. IEEE Press, 945–956. <https://doi.org/10.1109/ICSE48619.2023.00087>
- [A31] Junjun Guo, Long Lu, and Jingkui Li. 2024. Smart Contract Vulnerability Detection Based on Multi-Scale Encoders. *Electronics* 13, 3 (2024), 489.
- [A32] Sepideh HajiHosseinKhani, Arash Habibi Lashkari, and Ali Mizani Oskui. 2024. Unveiling vulnerable smart contracts: Toward profiling vulnerable smart contracts using genetic algorithm and generating benchmark dataset. *Blockchain: Research and Applications* 5, 1 (2024), 100171.
- [A33] Qiang Han, Lu Wang, Haoyu Zhang, Leyi Shi, and Danxin Wang. 2024. Ethchecker: a context-guided fuzzing for smart contracts. *The Journal of Supercomputing* 80, 10 (Jul 2024), 13949–13975. <https://doi.org/10.1007/s11227-024-05954-9>
- [A34] Daojing He, Ke Ding, Sammy Chan, and Mohsen Guizani. 2024. Unknown Threats Detection Methods of Smart Contracts. *IEEE internet of things journal* 11, 3 (2024), 1–1.
- [A35] Daojing He, Rui Wu, Xinji Li, Sammy Chan, and Mohsen Guizani. 2023. Detection of Vulnerabilities of Blockchain Smart Contracts. *IEEE Internet of Things Journal* 10, 14 (2023), 12178–12185. <https://doi.org/10.1109/JIOT.2023.3241544>
- [A36] Long He, Xiangfu Zhao, Yichen Wang, Jiahui Yang, and Xuelei Sun. 2023. *GraphSA: Smart Contract Vulnerability Detection Combining Graph Neural Networks and Static Analysis*. FAIA, Vol. 372. Chapter GraphSA: Smart Contract Vulnerability Detection Combining Graph Neural Networks and Static Analysis, 1020–1027. <https://doi.org/10.3233/FAIA230374>
- [A37] Tianyuan Hu, Bixin Li, Zhenyu Pan, and Chen Qian. 2024. Detect Defects of Solidity Smart Contract Based on the Knowledge Graph. *IEEE transactions on reliability* 73, 1 (2024), 1–17.
- [A38] Tianyuan Hu, Jingyue Li, Xiangfei Xu, and Bixin Li. [n. d.]. SoliTester: Detecting exploitable external-risky vulnerability in smart contracts using contract account triggering method. *Journal of Software: Evolution and Process* ([n. d.]), e2633.
- [A39] Jianjun Huang, Songming Han, Wei You, Wenchang Shi, Bin Liang, Jingzheng Wu, and Yanjun Wu. 2021. Hunting Vulnerable Smart Contracts via Graph Embedding Based Bytecode Matching. *IEEE transactions on information forensics and security* 16 (2021), 2144–2156.
- [A40] Jing Huang, Kuo Zhou, Ao Xiong, and Dongmeng Li. 2022. Smart contract vulnerability detection model based on multi-task learning. *Sensors* 22, 5 (2022), 1829.
- [A41] Seon-Jin Hwang, Seok-Hwan Choi, Jinmyeong Shin, and Yoon-Ho Choi. 2022. CodeNet: Code-Targeted Convolutional Neural Network Architecture for Smart Contract Vulnerability Detection. *IEEE Access* 10 (2022), 32595–32607. <https://doi.org/10.1109/ACCESS.2022.3162065>
- [A42] Sowon Jeon, Gilhee Lee, Hyoungshick Kim, and Simon Woo. 2023. Design and evaluation of highly accurate smart contract code vulnerability detection framework. *Data Mining and Knowledge Discovery* (10 2023). <https://doi.org/10.1007/s10618-023-00981-1>



- [A43] Songyan Ji, Jin Wu, Junfu Qiu, and Jian Dong. 2023. Effuzz: Efficient fuzzing by directed search for smart contracts. *Information and Software Technology* 159 (2023), 107213.
- [A44] Bo Jiang, Yifei Chen, Dong Wang, Imran Ashraf, and W.K. Chan. 2021. WANA: Symbolic Execution of Wasm Bytecode for Extensible Smart Contract Vulnerability Detection. In *2021 IEEE 21st International Conference on Software Quality, Reliability and Security (QRS)*. 926–937. <https://doi.org/10.1109/QRS54544.2021.00102>
- [A45] Fan Jiang, Kailin Chao, Jianmao Xiao, Qinghua Liu, Keyang Gu, Junyi Wu, and Yuanlong Cao. 2023. Enhancing smart-contract security through machine learning: A survey of approaches and techniques. *Electronics* 12, 9 (2023), 2046.
- [A46] Wanqing Jie, Qi Chen, Jiaqi Wang, Arthur Sandor Voundi Koe, Jin Li, Pengfei Huang, Yaqi Wu, and Yin Wang. 2023. A novel extended multimodal AI framework towards vulnerability detection in smart contracts. *Information Sciences* 636 (2023), 118907. <https://doi.org/10.1016/j.ins.2023.03.132>
- [A47] Hai Jin, Zeli Wang, Ming Wen, Weiqi Dai, Yu Zhu, and Deqing Zou. 2022. Aroc: An Automatic Repair Framework for On-Chain Smart Contracts. *IEEE Transactions on Software Engineering* 48, 11 (2022), 4611–4629. <https://doi.org/10.1109/TSE.2021.3123170>
- [A48] Satpal Singh Kushwaha, Sandeep Joshi, Dilbag Singh, Manjit Kaur, and Heung-No Lee. 2022. Ethereum Smart Contract Analysis Tools: A Systematic Review. *IEEE Access* 10 (2022), 57037–57062. <https://doi.org/10.1109/ACCESS.2022.3169902>
- [A49] Satpal Singh Kushwaha, Sandeep Joshi, Dilbag Singh, Manjit Kaur, and Heung-No Lee. 2022. Systematic Review of Security Vulnerabilities in Ethereum Blockchain Smart Contract. *IEEE Access* 10 (2022), 6605–6621. <https://doi.org/10.1109/ACCESS.2021.3140091>
- [A50] Hozefa Lakadawala, Komla Dzigbede, and Yu Chen. 2024. Detecting Reentrancy Vulnerability in Smart Contracts using Graph Convolution Networks. In *2024 IEEE 21st Consumer Communications & Networking Conference (CCNC)*. 188–193. <https://doi.org/10.1109/CCNC51664.2024.10454763>
- [A51] Zhaoxuan Li, Siqi Lu, Rui Zhang, Ziming Zhao, Rujin Liang, Rui Xue, Wenhao Li, Fan Zhang, and Sheng Gao. 2023. VulHunter: Hunting Vulnerable Smart Contracts at EVM Bytecode-Level via Multiple Instance Learning. *IEEE Transactions on Software Engineering* 49, 11 (2023), 4886–4916. <https://doi.org/10.1109/TSE.2023.3317209>
- [A52] Jiayu Liang and Yuqing Zhai. 2023. SCGRU: A Model for Ethereum Smart Contract Vulnerability Detection Combining CNN and BiGRU-Attention. In *2023 8th International Conference on Signal and Image Processing (ICSIP)*. 831–837. <https://doi.org/10.1109/ICSIP57908.2023.10270857>
- [A53] Zeqin Liao, Sicheng Hao, Yuhong Nan, and Zibin Zheng. 2023. SmartState: Detecting State-Reverting Vulnerabilities in Smart Contracts via Fine-Grained State-Dependency Analysis. In *Proceedings of the 32nd ACM SIGSOFT International Symposium on Software Testing and Analysis* (<conf-loc>, <city>Seattle</city>, <state>WA</state>, <country>USA</country>, </conf-loc>) (*ISSTA 2023*). Association for Computing Machinery, New York, NY, USA, 980–991. <https://doi.org/10.1145/3597926.3598111>
- [A54] Zeqin Liao, Zibin Zheng, Xiao Chen, and Yuhong Nan. 2022. SmartDagger: a bytecode-based static analysis approach for detecting cross-contract vulnerability. In *Proceedings of the 31st ACM SIGSOFT International Symposium on Software Testing and Analysis* (<conf-loc>, <city>Virtual</city>, <country>South Korea</country>, </conf-loc>) (*ISSTA 2022*). Association for Computing Machinery, New York, NY, USA, 752–764. <https://doi.org/10.1145/3533767.3534222>
- [A55] Shlomi Linoy, Suprio Ray, and Natalia Stakhanova. 2021. EtherProv: Provenance-Aware Detection, Analysis, and Mitigation of Ethereum Smart Contract Security Issues. In *2021 IEEE International Conference on Blockchain (Blockchain)*. 1–10. <https://doi.org/10.1109/Blockchain53845.2021.00014>
- [A56] Yang Liu, Chao Wang, and Yan Ma. 2024. DL4SC: a novel deep learning-based vulnerability detection framework for smart contracts. *Automated Software Engineering* 31, 1 (Mar 2024), 24. <https://doi.org/10.1007/s10515-024-00418-z>
- [A57] Zhenguang Liu, Peng Qian, Xiang Wang, Lei Zhu, Qinming He, and Shouling Ji. 2021. Smart Contract Vulnerability Detection: From Pure Neural Network to Interpretable Graph Feature and Expert Pattern Fusion. In *Proceedings of the Thirtieth International Joint Conference on Artificial Intelligence, IJCAI-21*, Zhi-Hua Zhou (Ed.). International Joint Conferences on Artificial Intelligence Organization, 2751–2759. <https://doi.org/10.24963/ijcai.2021/379> Main Track.
- [A58] Zhenguang Liu, Peng Qian, Xiaoyang Wang, Yuan Zhuang, Lin Qiu, and Xun Wang. 2023. Combining Graph Neural Networks With Expert Knowledge for Smart Contract Vulnerability Detection. *IEEE Transactions on Knowledge and Data Engineering* 35, 2 (2023), 1296–1310. <https://doi.org/10.1109/TKDE.2021.3095196>
- [A59] Zhenguang Liu, Peng Qian, Jiaxu Yang, Lingfeng Liu, Xiaojun Xu, Qinming He, and Xiaosong Zhang. 2023. Rethinking Smart Contract Fuzzing: Fuzzing With Invocation Ordering and Important Branch Revisiting. *IEEE transactions on information forensics and security* 18 (2023), 1–1.
- [A60] Oliver Lutz, Huili Chen, Hossein Fereidooni, Christoph Sendner, Alexandra Dmitrienko, Ahmad Reza Sadeghi, and Farinaz Koushanfar. 2021. ESCORT: Ethereum Smart COntRACts Vulnerability Detection using Deep Neural Network and Transfer Learning. [arXiv:2103.12607](https://arxiv.org/abs/2103.12607) [cs.CR]
- [A61] Chuang Ma, Shuaiwu Liu, and Guangxia Xu. 2023. HGAT: smart contract vulnerability detection method based on hierarchical graph attention network. *Journal of cloud computing : advances, systems and applications* 12, 1 (2023), 93–13.
- [A62] Lukasz Mazurek. [n. d.]. EthVer: Formal Verification of Randomized Ethereum Smart Contracts. In *Financial Cryptography and Data Security. FC 2021 International Workshops*. Springer Berlin Heidelberg, Berlin, Heidelberg, 364–380.

- [A63] Feng Mi, Zhuoyi Wang, Chen Zhao, Jinghui Guo, Fawaz Ahmed, and Latifur Khan. 2021. VSCL: Automating Vulnerability Detection in Smart Contracts with Deep Learning. In *2021 IEEE International Conference on Blockchain and Cryptocurrency (ICBC)*. 1–9. <https://doi.org/10.1109/ICBC51069.2021.9461050>
- [A64] Sundas Munir and Walid Taha. 2023. Pre-deployment Analysis of Smart Contracts – A Survey. arXiv:2301.06079 [cs.CR]
- [A65] K Lakshmi Narayana and K Sathiyamurthy. 2023. Automation and smart materials in detecting smart contracts vulnerabilities in Blockchain using deep learning. *Materials Today: Proceedings* 81 (2023), 653–659.
- [A66] Behkish Nassirzadeh, Huaiying Sun, Sebastian Banescu, and Vijay Ganesh. 2023. Gas Gauge: A Security Analysis Tool for Smart Contract Out-of-Gas Vulnerabilities. In *Mathematical Research for Blockchain Economy*, Panos Pardalos, Ilias Kotsireas, Yike Guo, and William Knottenbelt (Eds.). Springer International Publishing, Cham, 143–167.
- [A67] Hoang H. Nguyen, Nhat-Minh Nguyen, Hong-Phuc Doan, Zahra Ahmadi, Thanh-Nam Doan, and Lingxiao Jiang. 2022. MANDO-GURU: vulnerability detection for smart contract source code by heterogeneous graph embeddings. In *Proceedings of the 30th ACM Joint European Software Engineering Conference and Symposium on the Foundations of Software Engineering* (<conf-loc>, <city>Singapore</city>, <country>Singapore</country>, </conf-loc>) (ESEC/FSE 2022). Association for Computing Machinery, New York, NY, USA, 1736–1740. <https://doi.org/10.1145/3540250.3558927>
- [A68] Hoang H. Nguyen, Nhat-Minh Nguyen, Chunyao Xie, Zahra Ahmadi, Daniel Kudendo, Thanh-Nam Doan, and Lingxiao Jiang. 2023. MANDO-HGT: Heterogeneous Graph Transformers for Smart Contract Vulnerability Detection. In *2023 IEEE/ACM 20th International Conference on Mining Software Repositories (MSR)*. IEEE, 334–346.
- [A69] Tai D. Nguyen, Long H. Pham, and Jun Sun. 2021. SGuard: Towards Fixing Vulnerable Smart Contracts Automatically. In *2021 IEEE Symposium on Security and Privacy (SP)*. 1215–1229. <https://doi.org/10.1109/SP40001.2021.00057>
- [A70] Mitchell Olsthoorn, Dimitri Stallenberg, Arie van Deursen, and Annibale Panichella. 2022. SynTest-solidity: automated test case generation and fuzzing for smart contracts. In *Proceedings of the ACM/IEEE 44th International Conference on Software Engineering: Companion Proceedings* (Pittsburgh, Pennsylvania) (ICSE '22). Association for Computing Machinery, New York, NY, USA, 202–206. <https://doi.org/10.1145/3510454.3516869>
- [A71] Rodrigo Otoni, Matteo Marescotti, Leonardo Alt, Patrick Eugster, Antti Hyvärinen, and Natasha Sharygina. 2023. A Solicitous Approach to Smart Contract Verification. *ACM Trans. Priv. Secur.* 26, 2, Article 15 (mar 2023), 28 pages. <https://doi.org/10.1145/3564699>
- [A72] Zhenyu Pan, Tianyuan Hu, Chen Qian, and Bixin Li. 2021. ReDefender: A Tool for Detecting Reentrancy Vulnerabilities in Smart Contracts Effectively. In *2021 IEEE 21st International Conference on Software Quality, Reliability and Security (QRS)*. 915–925. <https://doi.org/10.1109/QRS54544.2021.00101>
- [A73] Michele Pasqua, Andrea Benini, Filippo Contro, Marco Crosara, Mila Dalla Preda, and Mariano Ceccato. 2023. Enhancing Ethereum smart-contracts static analysis by computing a precise Control-Flow Graph of Ethereum bytecode. *Journal of Systems and Software* 200 (2023), 111653.
- [A74] Gong Peng, Yang Wenzhong, Wang Liejun, Wei Fuyuan, HaiLaTi KeZiErBieKe, and Liao Yuanyuan. 2023. GRATDet: Smart Contract Vulnerability Detector Based on Graph Representation and Transformer. *Computers, Materials & Continua* 76, 2 (2023), 1439–1462. <https://doi.org/10.32604/cmc.2023.038878>
- [A75] Valentina Piantadosi, Giovanni Rosa, Davide Placella, Simone Scalabrino, and Rocco Oliveto. 2022. Detecting functional and security-related issues in smart contracts: A systematic literature review. *Software: Practice and Experience* 53 (10 2022). <https://doi.org/10.1002/spe.3156>
- [A76] Purathani Praitheeshan, Lei Pan, Xi Zheng, Alireza Jolfaei, and Robin Doss. 2021. SolGuard: Preventing external call issues in smart contract-based multi-agent robotic systems. *Information Sciences* 579 (2021), 150–166.
- [A77] Peng Qian, Rui Cao, Zhenguang Liu, Wenqing Li, Ming Li, Lun Zhang, Yufeng Xu, Jianhai Chen, and Qinming He. 2023. Empirical Review of Smart Contract and DeFi Security: Vulnerability Detection and Automated Repair. arXiv:2309.02391 [cs.CR]
- [A78] Peng Qian, Jianting He, Lingling Lu, Siwei Wu, Zhipeng Lu, Lei Wu, Yajin Zhou, and Qinming He. 2023. Demystifying Random Number in Ethereum Smart Contract: Taxonomy, Vulnerability Identification, and Attack Detection. *IEEE Transactions on Software Engineering* 49, 7 (2023), 3793–3810. <https://doi.org/10.1109/TSE.2023.3271417>
- [A79] Peng Qian, Zhenguang Liu, Yifang Yin, and Qinming He. 2023. Cross-Modality Mutual Learning for Enhancing Smart Contract Vulnerability Detection on Bytecode. In *Proceedings of the ACM Web Conference 2023* (<conf-loc>, <city>Austin</city>, <state>TX</state>, <country>USA</country>, </conf-loc>) (WWW '23). Association for Computing Machinery, New York, NY, USA, 2220–2229. <https://doi.org/10.1145/3543507.3583367>
- [A80] Heidelinde Rameder. 2021. Systematic review of ethereum smart contract security vulnerabilities, analysis methods and tools. *PhD thesis* (2021).
- [A81] Meng Ren, Fuchen Ma, Zijing Yin, Huizhong Li, Ying Fu, Ting Chen, and Yu Jiang. 2021. SCStudio: a secure and efficient integrated development environment for smart contracts. In *Proceedings of the 30th ACM SIGSOFT International Symposium on Software Testing and Analysis* (Virtual, Denmark) (ISSTA 2021). Association for Computing Machinery, New York, NY, USA, 666–669. <https://doi.org/10.1145/3460319.3469078>

- [A82] Senou Mahugnon Rosaire and Degila Jules. 2022. Smart contracts security threats and solutions. *International Journal of Information Technology and Web Engineering (IJITWE)* 17, 1 (2022), 1–30.
- [A83] Noama Fatima Samreen and Manar H Alalfi. 2021. Smartscan: an approach to detect denial of service vulnerability in ethereum smart contracts. In *2021 IEEE/ACM 4th International Workshop on Emerging Trends in Software Engineering for Blockchain (WETSEB)*. IEEE, 17–26.
- [A84] Chaofan Shou, Shangyin Tan, and Koushik Sen. 2023. ItyFuzz: Snapshot-Based Fuzzer for Smart Contract. In *Proceedings of the 32nd ACM SIGSOFT International Symposium on Software Testing and Analysis* (<conf-loc>, <city>Seattle</city>, <state>WA</state>, <country>USA</country>, </conf-loc>) (*ISSTA 2023*). Association for Computing Machinery, New York, NY, USA, 322–333. <https://doi.org/10.1145/3597926.3598059>
- [A85] Sigma Prime. 2023. Solidity Security: Comprehensive Guide to Smart Contract Security. <https://blog.sigmaprime.io/solidity-security.html>. Accessed: [Date of access].
- [A86] Sunbeom So, Seongjoon Hong, and Hakjoo Oh. 2021. SmarTest: Effectively Hunting Vulnerable Transaction Sequences in Smart Contracts through Language Model-Guided Symbolic Execution. In *30th USENIX Security Symposium (USENIX Security 21)*. USENIX Association, 1361–1378. <https://www.usenix.org/conference/usenixsecurity21/presentation/so>
- [A87] Shuxiao Song, Xiao Yu, Yuexuan Ma, Jiale Li, and Jie Yu. 2024. Multi-model Smart Contract Vulnerability Detection Based on BiGRU. In *Neural Information Processing*, Biao Luo, Long Cheng, Zheng-Guang Wu, Hongyi Li, and Chaojie Li (Eds.). Springer Nature Singapore, Singapore, 3–14.
- [A88] Majd Soud, Ilham Qasse, Grischa Liebel, and Mohammad Hamdaqa. 2023. AutoMESC: Automatic Framework for Mining and Classifying Ethereum Smart Contract Vulnerabilities and Their Fixes. In *2023 49th Euromicro Conference on Software Engineering and Advanced Applications (SEAA)*. 410–417. <https://doi.org/10.1109/SEAA60479.2023.00068>
- [A89] Mirko Staderini. 2022. *Towards the Assessment and the Improvement of Smart Contract Security*. Ph. D. Dissertation. University of Florence, Florence, Italy. [https://flore.unifi.it/retrieve/e398c382-6050-179a-e053-3705fe0a4cff/Towards\\_Assessment\\_Improvement\\_Solidity\\_Smart\\_Contracts.pdf](https://flore.unifi.it/retrieve/e398c382-6050-179a-e053-3705fe0a4cff/Towards_Assessment_Improvement_Solidity_Smart_Contracts.pdf) PhD thesis.
- [A90] Jianzhong Su, Hong-Ning Dai, Lingjun Zhao, Zibin Zheng, and Xiapu Luo. 2023. Effectively Generating Vulnerable Transaction Sequences in Smart Contracts with Reinforcement Learning-guided Fuzzing. In *Proceedings of the 37th IEEE/ACM International Conference on Automated Software Engineering* (Rochester, MI, USA) (*ASE '22*). Association for Computing Machinery, New York, NY, USA, Article 36, 12 pages. <https://doi.org/10.1145/3551349.3560429>
- [A91] R SUJEEETHA and K AKILA. 2023. AUTOMATED MUTATION ANALYSIS FOR SMART CONTRACT USING AMA TOOL WITH ENHANCED GA AND MACHINE LEARNING APPROACH. *Journal of Theoretical and Applied Information Technology* 101, 21 (2023).
- [A92] Jinlei Sun, Song Huang, Xingya Wang, Meijuan Wang, and Jinhu Du. 2022. A Detection Method for Scarcity Defect of Blockchain Digital Asset based on Invariant Analysis. In *2022 IEEE 22nd International Conference on Software Quality, Reliability and Security (QRS)*. 73–84. <https://doi.org/10.1109/QRS57517.2022.00018>
- [A93] Jinlei Sun, Song Huang, Changyou Zheng, Tingyong Wang, Cheng Zong, and Zhanwei Hui. 2022. Mutation testing for integer overflow in ethereum smart contracts. *Tsinghua science and technology* 27, 1 (2022), 27–40.
- [A94] Xiaobing Sun, Liangqiong Tu, Jiale Zhang, Jie Cai, Bin Li, and Yu Wang. 2023. ASSBert: Active and semi-supervised bert for smart contract vulnerability detection. *Journal of Information Security and Applications* 73 (2023), 103423.
- [A95] Christof Ferreira Torres, Antonio Ken Iannillo, Arthur Gervais, and Radu State. 2021. ConFuzzius: A Data Dependency-Aware Hybrid Fuzzer for Smart Contracts. In *2021 IEEE European Symposium on Security and Privacy*. 103–119. <https://doi.org/10.1109/EuroSP51992.2021.00018>
- [A96] Anna Vacca, Andrea Di Sorbo, Corrado A Visaggio, and Gerardo Canfora. 2021. A systematic literature review of blockchain and smart contract development: Techniques, tools, and open challenges. *Journal of Systems and Software* 174 (2021), 110891.
- [A97] Antonio López Vivar, Ana Lucila Sandoval Orozco, and Luis Javier García Villalba. 2021. A security framework for Ethereum smart contracts. *Computer Communications* 172 (2021), 119–129.
- [A98] Haoyu Wang, Zan Wang, Shuang Liu, Jun Sun, Yingquan Zhao, Yan Wan, and Tai D. Nguyen. 2023. sFuzz2.0: Storage-access pattern guided smart contract fuzzing. *Journal of software : evolution and process* 36, 4 (2023).
- [A99] Xiaoyin Wang, Jiase Sun, Chunyang Hu, Panpan Yu, Bin Zhang, and Donghai Hou. 2022. EtherFuzz: Mutation Fuzzing Smart Contracts for TOD Vulnerability Detection. *Wireless communications and mobile computing* 2022 (2022), 1–8.
- [A100] Zexu Wang, Bin Wen, Ziqiang Luo, and Shaojie Liu. 2021. M-A-R: A Dynamic Symbol Execution Detection Method for Smart Contract Reentry Vulnerability. In *Blockchain and Trustworthy Systems*. Springer Singapore, Singapore, 418–429.
- [A101] Zhiyuan Wei, Jing Sun, Zijian Zhang, Xianhao Zhang, Xiaoxuan Yang, and Liehuang Zhu. 2023. Survey on Quality Assurance of Smart Contracts. arXiv:2311.00270 [cs.CR]
- [A102] Hongjun Wu, Yihao Qin, Bo Lin, Xiaoguang Mao, Yan Lei, Zhuo Zhang, Shangwen Wang, and Haoyu Zhang. 2021. Peculiar: Smart Contract Vulnerability Detection Based on Crucial Data Flow Graph and Pre-training Techniques. <https://doi.org/10.1109/ISSRE52982.2021.00047>

- [A103] Xueshuo Xie, Haolong Wang, Zhaolong Jian, Yaozheng Fang, Zichun Wang, and Tao Li. 2023. Block-gram: Mining knowledgeable features for efficiently smart contract vulnerability detection. *Digital Communications and Networks* (2023).
- [A104] Rongze Xu, Zhanyong Tang, Guixin Ye, Huanting Wang, Xin Ke, Dingyi Fang, and Zheng Wang. 2022. Detecting code vulnerabilities by learning from large-scale open source repositories. *Journal of Information Security and Applications* 69 (2022), 103293. <https://doi.org/10.1016/j.jisa.2022.103293>
- [A105] Yingjie Xu, Gengran Hu, Lin You, and Chengtang Cao. 2021. A novel machine learning-based analysis model for smart contract vulnerability. *Security and Communication Networks* 2021 (2021), 1–12.
- [A106] Yinxing Xue, Jiaming Ye, Wei Zhang, Jun Sun, Lei Ma, Haijun Wang, and Jianjun Zhao. 2024. xFuzz: Machine Learning Guided Cross-Contract Fuzzing. *IEEE Transactions on Dependable and Secure Computing* 21, 2 (2024), 515–529. <https://doi.org/10.1109/TDSC.2022.3182373>
- [A107] Huiwen Yang, Xiguo Gu, Xiang Chen, Liwei Zheng, and Zhanqi Cui. 2024. CrossFuzz: Cross-contract fuzzing for smart contract vulnerability detection. *Science of Computer Programming* 234 (2024), 103076.
- [A108] Zhongju Yang, Weixing Zhu, and Minggang Yu. 2023. Improvement and Optimization of Vulnerability Detection Methods for Ethernet Smart Contracts. *IEEE Access* 11 (2023), 78207–78223. <https://doi.org/10.1109/ACCESS.2023.3298672>
- [A109] Jiaming Ye, Mingliang Ma, Yun Lin, Lei Ma, Yinxing Xue, and Jianjun Zhao. 2022. Vulpedia: Detecting vulnerable ethereum smart contracts via abstracted vulnerability signatures. *Journal of Systems and Software* 192 (2022), 111410. <https://doi.org/10.1016/j.jss.2022.111410>
- [A110] Lei Yu, Junyi Lu, Xianglong Liu, Li Yang, Fengjun Zhang, and Jiajia Ma. 2023. PSCVFinder: A Prompt-Tuning Based Framework for Smart Contract Vulnerability Detection. In *2023 IEEE 34th International Symposium on Software Reliability Engineering (ISSRE)*. IEEE, 556–567.
- [A111] Rutao Yu, Jiangang Shu, Dekai Yan, and Xiaohua Jia. 2021. ReDetect: Reentrancy Vulnerability Detection in Smart Contracts with High Accuracy. In *2021 17th International Conference on Mobility, Sensing and Networking (MSN)*. 412–419. <https://doi.org/10.1109/MSN53354.2021.00069>
- [A112] Rongwei Yu, Yuhang Zhang, Yong Wang, and Chen Liu. 2023. TxMirror: When the Dynamic EVM Stack Meets Transactions for Smart Contract Vulnerability Detection. *Symmetry (Basel)* 15, 7 (2023), 1345.
- [A113] Xingxin Yu, Haoyue Zhao, Botao Hou, Zonghao Ying, and Bin Wu. 2021. DeeSCVHunter: A Deep Learning-Based Framework for Smart Contract Vulnerability Detection. In *2021 International Joint Conference on Neural Networks (IJCNN)*. 1–8. <https://doi.org/10.1109/IJCNN52387.2021.9534324>
- [A114] Semi Yulianto, Harco Leslie Hendric Spits Warnars, Harjanto Prabowo, Meyliana, and Achmad Nizar Hidayanto. 2023. Security Risks and Best Practices for Blockchain and Smart Contracts: A Systematic Literature Review. In *2023 International Conference on Information Management and Technology (ICIMTech)*. 1–6. <https://doi.org/10.1109/ICIMTech59029.2023.10278055>
- [A115] Oualid Zaazaa and Hanan El Bakkali. 2023. Unveiling the Landscape of Smart Contract Vulnerabilities: A Detailed Examination and Codification of Vulnerabilities in Prominent Blockchains. *International Journal of Computer Networks and Communications* 15, 6 (Nov. 2023), 55–75. <https://doi.org/10.5121/ijcnc.2023.15603>
- [A116] Oualid Zaazaa and Hanan El Bakkali. 2023. A systematic literature review of undiscovered vulnerabilities and tools in smart contract technology. *Journal of Intelligent Systems* 32, 1 (2023), 20230038.
- [A117] Qingren Zeng, Jiahao He, Gansen Zhao, Shuangyin Li, Jingji Yang, Hua Tang, and Haoyu Luo. 2022. EtherGIS: A Vulnerability Detection Framework for Ethereum Smart Contracts Based on Graph Learning Features. In *2022 IEEE 46th Annual Computers, Software, and Applications Conference (COMPSAC)*. 1742–1749. <https://doi.org/10.1109/COMPSAC54236.2022.00277>
- [A118] Hengyan Zhang, Weizhe Zhang, Yuming Feng, and Yang Liu. 2023. SVScanner: Detecting smart contract vulnerabilities via deep semantic extraction. *Journal of Information Security and Applications* 75 (2023), 103484.
- [A119] Jiashuo Zhang, Yue Li, Jianbo Gao, Zhi Guan, and Zhong Chen. 2023. Siguard: Detecting Signature-Related Vulnerabilities in Smart Contracts. In *Proceedings of the 45th International Conference on Software Engineering: Companion Proceedings* (Melbourne, Victoria, Australia) (ICSE '23). IEEE Press, 31–35. <https://doi.org/10.1109/ICSE-Companion58688.2023.00019>
- [A120] Lejun Zhang, Weijie Chen, Weizheng Wang, Zilong Jin, Chunhui Zhao, Zhennao Cai, and Huiling Chen. 2022. CBGRU: A Detection Method of Smart Contract Vulnerability Based on a Hybrid Model. *Sensors (Basel, Switzerland)* 22, 9 (2022), 3577.
- [A121] Lejun Zhang, Yuan Li, Tianxing Jin, Weizheng Wang, Zilong Jin, Chunhui Zhao, Zhennao Cai, and Huiling Chen. 2022. SPCBIG-EC: A Robust Serial Hybrid Model for Smart Contract Vulnerability Detection. *Sensors (Basel, Switzerland)* 22, 12 (2022), 4621.
- [A122] Lejun Zhang, Jinlong Wang, Weizheng Wang, Zilong Jin, Yansen Su, and Huiling Chen. 2022. Smart contract vulnerability detection combined with multi-objective detection. *Computer Networks* 217 (2022), 109289.
- [A123] Lejun Zhang, Jinlong Wang, Weizheng Wang, Zilong Jin, Chunhui Zhao, Zhennao Cai, and Huiling Chen. 2022. A novel smart contract vulnerability detection method based on information graph and ensemble learning. *Sensors* 22, 9 (2022), 3581.
- [A124] Yujian Zhang and Daifu Liu. 2022. Toward vulnerability detection for ethereum smart contracts using graph-matching network. *Future Internet* 14, 11 (2022), 326.

- [A125] Zhuo Zhang, Yan Lei, Meng Yan, Yue Yu, Jiachi Chen, Shangwen Wang, and Xiaoguang Mao. 2023. Reentrancy Vulnerability Detection and Localization: A Deep Learning Based Two-phase Approach. In *Proceedings of the 37th IEEE/ACM International Conference on Automated Software Engineering* (<conf-loc>, <city>Rochester</city>, <state>MI</state>, <country>USA</country>, </conf-loc>) (ASE '22). Association for Computing Machinery, New York, NY, USA, Article 83, 13 pages. <https://doi.org/10.1145/3551349.3560428>
- [A126] Zhuo Zhang, Brian Zhang, Wen Xu, and Zhiqiang Lin. 2023. Demystifying Exploitable Bugs in Smart Contracts. In *Proceedings of the 45th International Conference on Software Engineering* (Melbourne, Victoria, Australia) (ICSE '23). IEEE Press, 615–627. <https://doi.org/10.1109/ICSE48619.2023.00061>
- [A127] Li Zhaoxuan, Siqi Lu, Rui Zhang, Rui Xue, Wenqiu Ma, Rujin Liang, Ziming Zhao, and Sheng Gao. 2022. SmartFast: an accurate and robust formal analysis tool for Ethereum smart contracts. *Empirical Software Engineering* 27 (10 2022). <https://doi.org/10.1007/s10664-022-10218-2>
- [A128] Peilin Zheng, Zibin Zheng, and Xiapu Luo. 2022. Park: accelerating smart contract vulnerability detection via parallel-fork symbolic execution. In *Proceedings of the 31st ACM SIGSOFT International Symposium on Software Testing and Analysis* (<conf-loc>, <city>Virtual</city>, <country>South Korea</country>, </conf-loc>) (ISSTA 2022). Association for Computing Machinery, New York, NY, USA, 740–751. <https://doi.org/10.1145/3533767.3534395>
- [A129] Haozhe Zhou, Amin Milani Fard, and Adetokunbo Makanju. 2022. The state of ethereum smart contracts security: Vulnerabilities, countermeasures, and tool support. *Journal of Cybersecurity and Privacy* 2, 2 (2022), 358–378.
- [A130] Teng Zhou, Kui Liu, Li Li, Zhe Liu, Jacques Klein, and Tegawendé F. Bissyandé. 2021. SmartGift: Learning to Generate Practical Inputs for Testing Smart Contracts. In *2021 IEEE International Conference on Software Maintenance and Evolution (ICSME)*. 23–34. <https://doi.org/10.1109/ICSME52107.2021.00009>
- [A131] Huijuan Zhu, Kaixuan Yang, Liangmin Wang, Zhicheng Xu, and Victor S. Sheng. 2023. GraBit: A Sequential Model-Based Framework for Smart Contract Vulnerability Detection. In *2023 IEEE 34th International Symposium on Software Reliability Engineering (ISSRE)*. IEEE, 568–577.
- [A132] Andrei Zhukov and Vladimir Korkhov. 2023. SmartGraph: Static Analysis Tool for Solidity Smart Contracts. In *Computational Science and Its Applications – ICCSA 2023 Workshops*, Osvaldo Gervasi, Beniamino Murgante, Ana Maria A. C. Rocha, Chiara Garau, Francesco Scorza, Yeliz Karaca, and Carmelo M. Torre (Eds.). Springer Nature Switzerland, Cham, 584–598.

## REFERENCES

- [B1] Elvira Albert, Jesús Correás, Pablo Gordillo, Guillermo Román-Díez, and Albert Rubio. 2019. SAFEVM: a safety verifier for Ethereum smart contracts. In *Proceedings of the 28th ACM SIGSOFT International Symposium on Software Testing and Analysis* (Beijing, China) (ISSTA 2019). Association for Computing Machinery, New York, NY, USA, 386–389. <https://doi.org/10.1145/3293882.3338999>
- [B2] Andreas M Antonopoulos and Gavin Wood. 2018. *Mastering ethereum: building smart contracts and dapps*. O'reilly Media.
- [B3] M. Ashouri. 2020. Etherolic: A practical security analyzer for smart contracts. In *Proceedings of the 35th Annual ACM Symposium on Applied Computing*. ACM, 353–356.
- [B4] Imran Ashraf, Xiaoxue Ma, Bo Jiang, and W.K. Chan. 2020. GasFuzzer: Fuzzing Ethereum Smart Contract Binaries to Expose Gas-Oriented Exception Security Vulnerabilities. *IEEE Access* PP (05 2020), 1–1. <https://doi.org/10.1109/ACCESS.2020.2995183>
- [B5] S. Azzopardi, J. Ellul, and G. J. Pace. 2018. Monitoring smart contracts: contractlarva and open challenges beyond. In *Proceedings of the International Conference on Runtime Verification*. 113–137.
- [B6] K. Bhargavan, A. Delignat-Lavaud, C. Fournet, et al. 2016. Formal verification of smart contracts. In *Proceedings of the 2016 ACM Workshop on Programming Languages and Analysis for Security*. 91–96.
- [B7] Pearl Brereton, Barbara A. Kitchenham, David Budgen, Mark Turner, and Mohamed Khalil. 2007. Lessons from applying the systematic literature review process within the software engineering domain. *Journal of Systems and Software* 80, 4 (2007), 571–583. <https://doi.org/10.1016/j.jss.2006.07.009> Software Performance.
- [B8] Vitalik Buterin et al. 2013. Ethereum white paper. *GitHub repository* 1 (2013), 22–23.
- [B9] Vitalik Buterin et al. 2014. A next-generation smart contract and decentralized application platform. *white paper* 3, 37 (2014), 2–1.
- [B10] J. Chang, B. Gao, H. Xiao, J. Sun, Y. Cai, and Z. Yang. 2019. sCompile: Critical path identification and analysis for smart contracts. In *Proceedings of the International Conference on Formal Engineering Methods*. 286–304.
- [B11] P. Chapman, D. Xu, L. Deng, and Y. Xiong. 2019. Deviant: A mutation testing tool for solidity smart contracts. In *Proceedings of the 2019 IEEE International Conference on Blockchain (Blockchain)*. 319–324.
- [B12] K. Chatterjee, A. K. Goharshady, and E. K. Goharshady. 2019. The treewidth of smart contracts. In *Proceedings of the 34th ACM/SIGAPP Symposium on Applied Computing*. 400–408.
- [B13] Jiachi Chen, Xin Xia, David Lo, John Grundy, and Xiaohu Yang. 2020. Maintaining smart contracts on ethereum: Issues, techniques, and future challenges. *arXiv preprint arXiv:2007.00286* (2020).
- [B14] T. Chen, X. Li, Y. Wang, et al. 2017. An adaptive gas cost mechanism for ethereum to defend against under-priced dos attacks. In *Proceedings of the International Conference on Information Security Practice and Experience*. 3–24.

- [B15] Ting Chen, Zihao Li, Yufei Zhang, Xiapu Luo, Ting Wang, Teng Hu, Xiuzhuo Xiao, Dong Wang, Jin Huang, and Xiaosong Zhang. 2019. A Large-Scale Empirical Study on Control Flow Identification of Smart Contracts. In *2019 ACM/IEEE International Symposium on Empirical Software Engineering and Measurement (ESEM)*. 1–11. <https://doi.org/10.1109/ESEM.2019.8870156>
- [B16] Ting Chen, Zihao Li, Yufei Zhang, Xiapu Luo, Ting Wang, Teng Hu, Xiuzhuo Xiao, Dong Wang, Jin Huang, and Xiaosong Zhang. 2019. A Large-Scale Empirical Study on Control Flow Identification of Smart Contracts. In *2019 ACM/IEEE International Symposium on Empirical Software Engineering and Measurement (ESEM)*. 1–11. <https://doi.org/10.1109/ESEM.2019.8870156>
- [B17] Jesus Correas, Pablo Gordillo, and Guillermo Román Díez. 2021. Static Profiling and Optimization of Ethereum Smart Contracts Using Resource Analysis. *IEEE Access* PP (02 2021), 1–1. <https://doi.org/10.1109/ACCESS.2021.3057565>
- [B18] Chris Dannen. 2017. *Introducing Ethereum and solidity*. Vol. 1. Springer.
- [B19] Weichu Deng, Huanchun Wei, Teng Huang, Cong Cao, Yun Peng, and Xuan Hu. 2023. Smart Contract Vulnerability Detection Based on Deep Learning and Multimodal Decision Fusion. *Sensors* 23 (08 2023), 7246. <https://doi.org/10.3390/s23167246>
- [B20] C. Dong, Y. Li, and L. Tan. 2019. A new approach to prevent reentrant attack in solidity smart contracts. In *Proceedings of the CCF China Blockchain Conference*. 83–103.
- [B21] Shasha Du and Huiwu Huang. 2020. A General Framework of Smart Contract Vulnerability Mining Based on Control Flow Graph Matching. In *Artificial Intelligence and Security*, Xingming Sun, Jinwei Wang, and Elisa Bertino (Eds.). Springer Singapore, Singapore, 166–175.
- [B22] M. A. El-Dosuky and G. H. Eladl. 2019. DOORchain: deep ontology-based operation research to detect malicious smart contracts. In *Proceedings of the World Conference on Information Systems and Technologies*. 538–545.
- [B23] Yuqi Fan, Siyuan Shang, and Xu Ding. 2021. Smart Contract Vulnerability Detection Based on Dual Attention Graph Convolutional Network. In *Collaborative Computing: Networking, Applications and Worksharing*, Honghao Gao and Xinheng Wang (Eds.). Springer International Publishing, Cham, 335–351.
- [B24] Josselin Feist, Gustavo Grieco, and Alex Groce. 2019. Slither: a static analysis framework for smart contracts. In *2019 IEEE/ACM 2nd International Workshop on Emerging Trends in Software Engineering for Blockchain (WETSEB)*. IEEE, 8–15.
- [B25] J. Feist, G. Grieco, and A. Groce. 2019. Slither: A static analysis framework for smart contracts. In *Proceedings of the 2019 IEEE/ACM 2nd International Workshop on Emerging Trends in Software Engineering for Blockchain (WETSEB)*. 8–15.
- [B26] João F. Ferreira, Pedro Cruz, Thomas Durieux, and Rui Abreu. 2021. SmartBugs: a framework to analyze solidity smart contracts. In *Proceedings of the 35th IEEE/ACM International Conference on Automated Software Engineering (Virtual Event, Australia) (ASE '20)*. Association for Computing Machinery, New York, NY, USA, 1349–1352. <https://doi.org/10.1145/3324884.3415298>
- [B27] Christof Ferreira Torres, Mathis Baden, Robert Norvill, Beltran Borja Fiz Pontiveros, Hugo Jonker, and Sjouke Mauw. 2020. ÆGIS: Shielding Vulnerable Smart Contracts Against Attacks. In *Proceedings of the 15th ACM Asia Conference on Computer and Communications Security (Taipei, Taiwan) (ASIA CCS '20)*. Association for Computing Machinery, New York, NY, USA, 584–597. <https://doi.org/10.1145/3320269.3384756>
- [B28] Menglin Fu, Lifa Wu, Zheng Hong, Feng Zhu, He Sun, and Wenbo Feng. 2019. A Critical-Path-Coverage-Based Vulnerability Detection Method for Smart Contracts. *IEEE Access* 7 (2019), 147327–147344. <https://doi.org/10.1109/ACCESS.2019.2947146>
- [B29] M. Fu, L. Wu, Z. Hong, F. Zhu, H. Sun, and W. Feng. 2019. A critical-path-coverage-based vulnerability detection method for smart contracts. *IEEE Access* 7 (2019), 147327–147344.
- [B30] Ying Fu, Meng Ren, Fuchen Ma, Heyuan Shi, Xin Yang, Yu Jiang, Huizhong Li, and Xiang Shi. 2019. EVMFuzzer: detect EVM vulnerabilities via fuzz testing. In *Proceedings of the 2019 27th ACM Joint Meeting on European Software Engineering Conference and Symposium on the Foundations of Software Engineering (Tallinn, Estonia) (ESEC/FSE 2019)*. Association for Computing Machinery, New York, NY, USA, 1110–1114. <https://doi.org/10.1145/3338906.3341175>
- [B31] J. Gao, H. Liu, C. Liu, Q. Li, Z. Guan, and Z. Chen. 2019. Easyflow: keep ethereum away from overflow. In *Proceedings of the 2019 IEEE/ACM 41st International Conference on Software Engineering: Companion Proceedings (ICSE-Companion)*. 23–26.
- [B32] Zhipeng Gao, Lingxiao Jiang, Xin Xia, David Lo, and John Grundy. 2021. Checking Smart Contracts With Structural Code Embedding. *IEEE Transactions on Software Engineering* 47, 12 (2021), 2874–2891. <https://doi.org/10.1109/TSE.2020.2971482>
- [B33] Paul Garner, Sally Hopewell, Jackie Chandler, Harriet MacLehose, Holger Schünemann, Elie Akl, Joseph Beyene, Stephanie Chang, Rachel Churchill, Karin Dearness, Gordon Guyatt, Carol Lefebvre, Beth Liles, Rachel Marshall, Laura García, Chris Mavergames, Mona Nasser, Amir Qaseem, Margaret Sampson, and Ed Wilson. 2016. When and how to update systematic reviews: Consensus and checklist. *BMJ* 354 (07 2016), i3507. <https://doi.org/10.1136/bmj.i3507>
- [B34] Jens-Rene Giesen, Sebastien Andreina, Michael Rodler, Ghassan O. Karame, and Lucas Davi. 2022. Practical Mitigation of Smart Contract Bugs. arXiv:2203.00364 [cs.CR] <https://arxiv.org/abs/2203.00364>
- [B35] N. Grech, M. Kong, A. Jurisevic, L. Brent, B. Scholz, and Y. Smaragdakis. 2018. Madmax: surviving out-of-gas conditions in ethereum smart contracts. *Proc ACM Program Lang* 2 (2018), 1–27.
- [B36] S. Grossman, I. Abraham, G. Golan-Gueta, et al. 2017. Online detection of effectively callback free objects with applications to smart contracts. *Proc ACM Program Lang* 2 (2017), 1–28.

- [B37] Xiaohan Hao, Wei Ren, Wenwen Zheng, and Tianqing Zhu. 2020. SCScan: A SVM-Based Scanning System for Vulnerabilities in Blockchain Smart Contracts. In *2020 IEEE 19th International Conference on Trust, Security and Privacy in Computing and Communications (TrustCom)*. 1598–1605. <https://doi.org/10.1109/TrustCom50675.2020.00221>
- [B38] Xiaohan Hao, Wei Ren, Wenwen Zheng, and Tianqing Zhu. 2020. SCScan: A SVM-Based Scanning System for Vulnerabilities in Blockchain Smart Contracts. In *2020 IEEE 19th International Conference on Trust, Security and Privacy in Computing and Communications (TrustCom)*. 1598–1605. <https://doi.org/10.1109/TrustCom50675.2020.00221>
- [B39] J. He, M. Balunovic, N. Ambroladze, P. Tsankov, and M. Vechev. 2019. Learning to fuzz from symbolic execution with application to smart contracts. In *Proceedings of the 2019 ACM SIGSAC Conference on Computer and Communications Security*. 531–548.
- [B40] Y. Hirai. 2017. Defining the ethereum virtual machine for interactive theorem provers. In *International Conference on Financial Cryptography and Data Security*. 520–535.
- [B41] J. J. Honig, M. H. Everts, and M. Huisman. 2019. Practical mutation testing for smart contracts. In *Data Privacy Management, Cryptocurrencies and Blockchain Technology*, P.-S. Cristina, N.-A. Guillermo, B. Alex, and G.-J. Joaquin (Eds.). Springer, 289–303.
- [B42] Jianjun Huang, Songming Han, Wei You, Wenchang Shi, Bin Liang, Jingzheng Wu, and Yanjun Wua. 2021. Hunting Vulnerable Smart Contracts via Graph Embedding Based Bytecode Matching. *IEEE Transactions on Information Forensics and Security* PP (01 2021), 1–1. <https://doi.org/10.1109/TIFS.2021.3050051>
- [B43] Ru Ji, Ningyu He, Lei Wu, Haoyu Wang, Guangdong Bai, and Yao Guo. 2020. DEPOSafe: Demystifying the Fake Deposit Vulnerability in Ethereum Smart Contracts. In *2020 25th International Conference on Engineering of Complex Computer Systems (ICECCS)*. 125–134. <https://doi.org/10.1109/ICECCS51672.2020.00022>
- [B44] Songyan Ji, Jian Dong, Junfu Qiu, Bowen Gu, Ye Wang, and Tongqi Wang. 2021. Increasing Fuzz Testing Coverage for Smart Contracts with Dynamic Taint Analysis. In *2021 IEEE 21st International Conference on Software Quality, Reliability and Security (QRS)*. 243–247. <https://doi.org/10.1109/QRS54544.2021.00035>
- [B45] J. Jiao, S. W. Lin, and J. Sun. 2020. A generalized formal semantic framework for smart contracts. In *FASE*. 75–96.
- [B46] Wanqing Jie, Arthur Sandor Voundi Koe, Pengfei Huang, and Shuwen Zhang. 2021. Full-Stack Hierarchical Fusion of Static Features for Smart Contracts Vulnerability Detection. In *2021 IEEE International Conference on Blockchain (Blockchain)*. 95–102. <https://doi.org/10.1109/Blockchain53845.2021.00091>
- [B47] Mudabbir Kaleem, Anastasia Mavridou, and Aron Laszka. 2020. Vyper: A Security Comparison with Solidity Based on Common Vulnerabilities. In *2020 2nd Conference on Blockchain Research & Applications for Innovative Networks and Services (BRAINS)*. 107–111. <https://doi.org/10.1109/BRAINS49436.2020.9223278>
- [B48] Rajesh Kumar Kaushal, Naveen Kumar, Surya Narayan Panda, and Vinay Kukreja. 2021. Immutable smart contracts on blockchain technology: Its benefits and barriers. In *2021 9th International Conference on Reliability, Infocom Technologies and Optimization (Trends and Future Directions)(ICRITO)*. IEEE, 1–5.
- [B49] Barbara Kitchenham and Stuart Charters. 2007. Guidelines for performing Systematic Literature Reviews in Software Engineering. 2 (01 2007).
- [B50] A. Lahbib, A. A. Wakrime, A. Laouiti, K. Toumi, and S. Martin. 2020. An event-B based approach for formal modelling and verification of smart contracts. In *Proceedings of the International Conference on Advanced Information Networking and Applications*. 1303–1318.
- [B51] E. Lai and W. Luo. 2020. Static analysis of integer overflow of smart contracts in ethereum. In *Proceedings of the 2020 4th International Conference on Cryptography, Security and Privacy*. 110–115.
- [B52] Sooyeon Lee and Eun-Sun Cho. 2021. Lightweight extension of an execution environment for safer function calls in Solidity/Ethereum Virtual Machine smart contracts. In *2021 IEEE International Conference on Software Analysis, Evolution and Reengineering (SANER)*. 689–695. <https://doi.org/10.1109/SANER50967.2021.00087>
- [B53] Ziyuan Li, Wangshu Guo, Quan Xu, Yingjie Xu, Huimei Wang, and Ming Xian. 2021. Research on Blockchain Smart Contracts Vulnerability and A Code Audit Tool based on Matching Rules. In *Proceedings of the 2020 International Conference on Cyberspace Innovation of Advanced Technologies (Guangzhou, China) (CIAT 2020)*. Association for Computing Machinery, New York, NY, USA, 484–489. <https://doi.org/10.1145/3444370.3444617>
- [B54] Z. Li, H. Wu, J. Xu, X. Wang, L. Zhang, and Z. Chen. 2019. MuSC: a tool for mutation testing of ethereum smart contract. In *Proceedings of the 2019 34th IEEE/ACM International Conference on Automated Software Engineering (ASE)*. 1198–1201.
- [B55] Jian-Wei Liao, Tsung-Ta Tsai, Chia-Kang He, and Chin-Wei Tien. 2019. SoliAudit: Smart Contract Vulnerability Assessment Based on Machine Learning and Fuzz Testing. In *2019 Sixth International Conference on Internet of Things: Systems, Management and Security (IOTSMS)*. 458–465. <https://doi.org/10.1109/IOTSMS48152.2019.8939256>
- [B56] Haojun Liu, Xinbo Luo, Hongrui Liu, and Xubo Xia. 2021. Merkle Tree: A Fundamental Component of Blockchains. In *2021 International Conference on Electronic Information Engineering and Computer Science (EIECS)*. 556–561. <https://doi.org/10.1109/EIECS53707.2021.9588047>
- [B57] Pierre-Alain Losi. 2024. Pakala: A Toolkit for Analyzing Ethereum Smart Contracts. <https://www.palkeo.com/en/projets/ethereum/pakala.html> Accessed: 2024-10-08.

- [B58] F. Ma, Y. Fu, M. Ren, et al. 2019. EVM\*: from offline detection to online reinforcement for Ethereum virtual machine. In *Proceedings of the 2019 IEEE 26th International Conference on Software Analysis, Evolution and Reengineering (SANER)*. 554–558.
- [B59] Fuchen Ma, Meng Ren, Ying Fu, Mingzhe Wang, Huizhong Li, Houbing Song, and Yu Jiang. 2021. Security reinforcement for Ethereum virtual machine. *Information Processing & Management* 58, 4 (2021), 102565. <https://doi.org/10.1016/j.ipm.2021.102565>
- [B60] Rui Ma, Zefeng Jian, Guangyuan Chen, Ke Ma, and Yujia Chen. 2020. Rejection: A AST-Based Reentrancy Vulnerability Detection Method. In *Trusted Computing and Information Security - 13th Chinese Conference, CTCIS 2019, Revised Selected Papers (Communications in Computer and Information Science)*, Weili Han, Liehuang Zhu, and Fei Yan (Eds.). Springer, Germany, 58–71. [https://doi.org/10.1007/978-981-15-3418-8\\_5](https://doi.org/10.1007/978-981-15-3418-8_5) Publisher Copyright: © Springer Nature Singapore Pte Ltd 2020.; 13th Chinese Conference on Trusted Computing and Information Security, CTCIS 2019 ; Conference date: 24-10-2019 Through 27-10-2019.
- [B61] H. Medeiros, P. Vilain, J. Mylopoulos, and H. A. Jacobsen. 2019. SolUnit: a framework for reducing execution time of smart contract unit tests. In *Proceedings of the 29th Annual International Conference on Computer Science and Software Engineering*. 264–273.
- [B62] Emília Mendes, Claes Wohlin, Katia Felizardo, and Marcos Kalinowski. 2020. When to Update Systematic Literature Reviews in Software Engineering. (04 2020).
- [B63] Pouyan Momeni, Yu Wang, and Reza Samavi. 2019. Machine Learning Model for Smart Contracts Security Analysis. In *2019 17th International Conference on Privacy, Security and Trust (PST)*. 1–6. <https://doi.org/10.1109/PST47121.2019.8949045>
- [B64] P. Momeni, Y. Wang, and R. Samavi. 2019. Machine learning model for smart contracts security analysis. In *Proceedings of the 2019 17th International Conference on Privacy, Security and Trust (PST)*. 1–6.
- [B65] M. Mossberg, F. Manzano, E. Hennenfent, et al. 2019. Manticore: a user-friendly symbolic execution framework for binaries and smart contracts. In *Proceedings of the 2019 34th IEEE/ACM International Conference on Automated Software Engineering (ASE)*. 1186–1189.
- [B66] Satoshi Nakamoto. 2008. Bitcoin: A peer-to-peer electronic cash system. (2008).
- [B67] Vilmar Nepomuceno and Sergio Soares. 2019. On the need to update systematic literature reviews. *Information and Software Technology* 109 (2019), 40–42. <https://doi.org/10.1016/j.infsof.2019.01.005>
- [B68] Q. B. Nguyen, A. Q. Nguyen, V. H. Nguyen, T. Nguyen-Le, and K. Nguyen-An. 2019. Detect abnormal behaviours in ethereum smart contracts using attack vectors. In *Proceedings of the International Conference on Future Data and Security Engineering*. 485–505.
- [B69] Tai D. Nguyen, Long H. Pham, Jun Sun, Yun Lin, and Quang Tran Minh. 2020. sFuzz: an efficient adaptive fuzzer for solidity smart contracts. In *Proceedings of the ACM/IEEE 42nd International Conference on Software Engineering (Seoul, South Korea) (ICSE '20)*. Association for Computing Machinery, New York, NY, USA, 778–788. <https://doi.org/10.1145/3377811.3380334>
- [B70] I. Nikolic, A. Kolluri, I. Sergey, P. Saxena, and A. Hobor. 2018. Finding the greedy, prodigal, and suicidal contracts at scale. 653–663.
- [B71] D. Park, Y. Zhang, M. Saxena, P. Daian, and G. Rosu. 2018. A formal verification tool for Ethereum VM bytecode. In *Proceedings of the 2018 26th ACM Joint Meeting on European Software Engineering Conference and Symposium on the Foundations of Software Engineering*. 912–915.
- [B72] C. Peng, S. Akca, and A. Rajan. 2019. SIF: a framework for solidity contract instrumentation and analysis. In *Proceedings of the 2019 26th Asia-Pacific Software Engineering Conference (APSEC)*. 466–473.
- [B73] Eugenia Politou, Fran Casino, Efthimios Alepis, and Constantinos Patsakis. 2019. Blockchain mutability: Challenges and proposed solutions. *IEEE Transactions on Emerging Topics in Computing* 9, 4 (2019), 1972–1986.
- [B74] David Prechtel, Tobias Groß, and Tilo Müller. 2019. Evaluating Spread of ‘Gasless Send’ in Ethereum Smart Contracts. In *2019 10th IFIP International Conference on New Technologies, Mobility and Security (NTMS)*. 1–6. <https://doi.org/10.1109/NTMS.2019.8763848>
- [B75] Peng Qian, Zhenguang Liu, Qinming He, Roger Zimmermann, and Xun Wang. 2020. Towards Automated Reentrancy Detection for Smart Contracts Based on Sequential Models. *IEEE Access* 8 (2020), 19685–19695. <https://doi.org/10.1109/ACCESS.2020.2969429>
- [B76] Peng Qian, Zhenguang Liu, Qinming He, Roger Zimmermann, and Xun Wang. 2020. Towards Automated Reentrancy Detection for Smart Contracts Based on Sequential Models. *IEEE Access* 8 (2020), 19685–19695. <https://doi.org/10.1109/ACCESS.2020.2969429>
- [B77] Paul Ralph. 2019. Toward Methodological Guidelines for Process Theories and Taxonomies in Software Engineering. *IEEE Transactions on Software Engineering* 45, 7 (2019), 712–735. <https://doi.org/10.1109/TSE.2018.2796554>
- [B78] Heidelinde Rameder, Monika Di Angelo, and Gernot Salzer. 2022. Review of Automated Vulnerability Analysis of Smart Contracts on Ethereum. *Frontiers in Blockchain* 5 (03 2022). <https://doi.org/10.3389/fbloc.2022.814977>
- [B79] Michael Rodler, Wenting Li, Ghassan O. Karame, and Lucas Davi. 2020. EVMPatch: Timely and Automated Patching of Ethereum Smart Contracts. In *USENIX Security Symposium*. <https://api.semanticscholar.org/CorpusID:222090393>
- [B80] Johnny Saldaña. 2021. The coding manual for qualitative researchers. (2021).
- [B81] Noama Fatima Samreen and Manar H Alalfi. 2020. Reentrancy vulnerability identification in ethereum smart contracts. In *2020 IEEE International Workshop on Blockchain Oriented Software Engineering (IWBOSE)*. IEEE, 22–29.
- [B82] Clara Schneidewind, Ilya Grishchenko, Markus Scherer, and Matteo Maffei. 2020. eThor: Practical and Provably Sound Static Analysis of Ethereum Smart Contracts. In *Proceedings of the 2020 ACM SIGSAC Conference on Computer and Communications Security (Virtual Event, USA) (CCS '20)*. Association for Computing Machinery, New York, NY, USA, 621–640. <https://doi.org/10.1145/3372297.3417250>
- [B83] I. Sergey, V. Nagaraj, J. Johannsen, A. Kumar, A. Trunov, and K. C. G. Hao. 2019. Safer smart contract programming with Scilla. *Proc ACM Program Lang* 3 (2019), 1–30.



- [B84] E. Shishkin. 2019. Debugging smart contract’s business logic using symbolic model checking. *Program Comput Softw* 45(8) (2019), 590–599.
- [B85] J. Song, H. He, Z. Lv, C. Su, G. Xu, and W. Wang. 2019. An efficient vulnerability detection model for Ethereum smart contracts. In *International Conference on Network and System Security*. 433–442.
- [B86] Lars Stegeman. 2018. Solitor: runtime verification of smart contracts on the Ethereum network. <http://essay.utwente.nl/76902/>
- [B87] Diane Strong, Yang Lee, and Richard Wang. 2002. Data Quality in Context. *Commun. ACM* 40 (08 2002). <https://doi.org/10.1145/253769.253804>
- [B88] Matt Suiche. 2017. Porosity: A decompiler for blockchain-based smart contracts bytecode. *DEF con* 25, 11 (2017).
- [B89] Yuhang Sun and Lize Gu. 2021. Attention-based Machine Learning Model for Smart Contract Vulnerability Detection. *Journal of Physics: Conference Series* 1820, 1 (mar 2021), 012004. <https://doi.org/10.1088/1742-6596/1820/1/012004>
- [B90] Sukyoung Ryu Sungjae Hwang. 2020. Gap between Theory and Practice : An Empirical Study of Security Patches in Solidity. In *Proceedings of the 42nd International Conference on Software Engineering*.
- [B91] Nick Szabo. 1994. Smart contracts <http://www.fon.hum.uva.nl/rob/Courses/InformationInSpeech/CDROM/Literature.LOTwinter-school2006/szabo.best.vwh.net/smart.contracts.html> (1994).
- [B92] YuXing Tang, ZiHao Li, and YanXu Bai. 2021. Rethinking of Reentrancy on the Ethereum. In *2021 IEEE Intl Conf on Dependable, Autonomic and Secure Computing, Intl Conf on Pervasive Intelligence and Computing, Intl Conf on Cloud and Big Data Computing, Intl Conf on Cyber Science and Technology Congress (DASC/PiCom/CBDCom/CyberSciTech)*. 68–75. <https://doi.org/10.1109/DASC-PiCom-CBDCom-CyberSciTech52372.2021.00025>
- [B93] Wesley Joon-Wie Tann, Xing Jie Han, Sourav Sen Gupta, and Yew-Soon Ong. 2018. Towards Safer Smart Contracts: A Sequence Learning Approach to Detecting Vulnerabilities. *CoRR* abs/1811.06632 (2018). arXiv:1811.06632 <http://arxiv.org/abs/1811.06632>
- [B94] Zemin Tian. 2019. Smart Contract Defect Detection Based on Parallel Symbolic Execution. In *2019 3rd International Conference on Circuits, System and Simulation (ICCS)*. 127–132. <https://doi.org/10.1109/CIRSYSSIM.2019.8935603>
- [B95] Z. Tian. 2019. Smart contract defect detection based on parallel symbolic execution. In *Proceedings of the 2019 3rd International Conference on Circuits, System and Simulation (ICCS)*. 127–132.
- [B96] Sergei Tikhomirov, Ekaterina Voskresenskaya, Ivan Ivanitskiy, Ramil Takhaviev, Evgeny Marchenko, and Yaroslav Alexandrov. 2018. SmartCheck: static analysis of ethereum smart contracts. In *Proceedings of the 1st International Workshop on Emerging Trends in Software Engineering for Blockchain (Gothenburg, Sweden) (WETSEB '18)*. Association for Computing Machinery, New York, NY, USA, 9–16. <https://doi.org/10.1145/3194113.3194115>
- [B97] Palina Tolmach, Yi Li, and Shang-Wei Lin. 2023. Property-Based Automated Repair of DeFi Protocols. In *Proceedings of the 37th IEEE/ACM International Conference on Automated Software Engineering (Rochester, MI, USA) (ASE '22)*. Association for Computing Machinery, New York, NY, USA, Article 184, 5 pages. <https://doi.org/10.1145/3551349.3559560>
- [B98] C. F. Torres, J. Schütte, and R. State. 2018. Osiris: hunting for integer bugs in ethereum smart contracts. In *Proceedings of the 34th Annual Computer Security Applications Conference*. 664–676.
- [B99] P. Tsankov, A. Dan, D. Drachler-Cohen, A. Gervais, F. Buenzli, and M. Vechev. 2018. Securify: practical security analysis of smart contracts. In *Proceedings of the 2018 ACM SIGSAC Conference on Computer and Communications Security*. 67–82.
- [B100] Fernando Richter Vidal, Naghmeh Ivaki, and Nuno Laranjeiro. 2024. Vulnerability detection techniques for smart contracts: A systematic literature review. *Journal of Systems and Software* 217 (2024), 112160. <https://doi.org/10.1016/j.jss.2024.112160>
- [B101] Anqi Wang, Hao Wang, Bo Jiang, and W. K. Chan. 2020. Artemis: An Improved Smart Contract Verification Tool for Vulnerability Detection. In *2020 7th International Conference on Dependable Systems and Their Applications (DSA)*. 173–181. <https://doi.org/10.1109/DSA51864.2020.00031>
- [B102] Ben Wang, Hanting Chu, Pengcheng Zhang, and Hai Dong. 2021. Smart Contract Vulnerability Detection Using Code Representation Fusion. In *2021 28th Asia-Pacific Software Engineering Conference (APSEC)*. 564–565. <https://doi.org/10.1109/APSEC53868.2021.00069>
- [B103] Ben Wang, Hanting Chu, Pengcheng Zhang, and Hai Dong. 2021. Smart Contract Vulnerability Detection Using Code Representation Fusion. *2021 28th Asia-Pacific Software Engineering Conference (APSEC)* (2021), 564–565. <https://api.semanticscholar.org/CorpusID:246945372>
- [B104] Shuai Wang, Chengyu Zhang, and Zhendong Su. 2019. Detecting nondeterministic payment bugs in Ethereum smart contracts. *Proc. ACM Program. Lang.* 3, OOPSLA, Article 189 (oct 2019), 29 pages. <https://doi.org/10.1145/3360615>
- [B105] Z. Wang, W. Dai, K. K. R. Choo, H. Jin, and D. Zou. 2020. FSFC: an input filter-based secure framework for smart contract. *J Netw Comput Appl* 154 (2020), 102530.
- [B106] Zhenhao Wu, Jiashuo Zhang, Jianbo Gao, Yue Li, Qingshan Li, Zhi Guan, and Zhong Chen. 2020. Kaya: A Testing Framework for Blockchain-based Decentralized Applications. In *2020 IEEE International Conference on Software Maintenance and Evolution (ICSME)*. 826–829. <https://doi.org/10.1109/ICSME46990.2020.00103>
- [B107] YinXing Xue, Mingliang Ma, Yun Lin, Yulei Sui, Jiaming Ye, and Tianyong Peng. 2021. Cross-contract static analysis for detecting practical reentrancy vulnerabilities in smart contracts. In *Proceedings of the 35th IEEE/ACM International Conference on Automated Software Engineering (Virtual Event, Australia) (ASE '20)*. Association for Computing Machinery, New York, NY, USA, 1029–1040.

- <https://doi.org/10.1145/3324884.3416553>
- [B108] Zhen Yang, Jacky Keung, Miao Zhang, Yan Xiao, Yangyang Huang, and Tik Hui. 2020. Smart Contracts Vulnerability Auditing with Multi-semantics. In *2020 IEEE 44th Annual Computers, Software, and Applications Conference (COMPSAC)*. 892–901. <https://doi.org/10.1109/COMPSAC48688.2020.0-153>
- [B109] J. Ye, M. Ma, T. Peng, and Y. Xue. 2020. A software analysis based vulnerability detection system for smart contracts. In *Integrating Research and Practice in Software Engineering*, J. Stan, A. P.-M. Aneta, and M. Lech (Eds.). Springer, 69–81.
- [B110] Q. Zhang, Y. Wang, J. Li, and S. Ma. 2020. EthPloit: from fuzzing to efficient exploit generation against smart contracts. In *Proceedings of the 2020 IEEE 27th International Conference on Software Analysis, Evolution and Reengineering (SANER)*. 116–126.
- [B111] Y. Zhang, S. Ma, J. Li, K. Li, S. Nepal, and D. Gu. 2020. SMARTSHIELD: automatic smart contract protection made easy. In *Proceedings of the 2020 IEEE 27th International Conference on Software Analysis, Evolution and Reengineering (SANER)*. 23–34.
- [B112] Ence Zhou, Song Hua, Bingfeng Pi, Jun Sun, Yashihide Nomura, Kazuhiro Yamashita, and Hidetoshi Kurihara. 2018. Security Assurance for Smart Contract. In *2018 9th IFIP International Conference on New Technologies, Mobility and Security (NTMS)*. 1–5. <https://doi.org/10.1109/NTMS.2018.8328743>
- [B113] Ke Zhou, Jieren Cheng, Hui Li, Yuming Yuan, Le Liu, and Xiulai Li. 2021. SC-VDM: A Lightweight Smart Contract Vulnerability Detection Model. In *Data Mining and Big Data*, Ying Tan, Yuhui Shi, Albert Zomaya, Hongyang Yan, and Jun Cai (Eds.). Springer Singapore, Singapore, 138–149.
- [B114] Shunfan Zhou, Zhemin Yang, Jie Xiang, Yinzhi Cao, Zhemin Yang, and Yuan Zhang. 2020. An Ever-evolving Game: Evaluation of Real-world Attacks and Defenses in Ethereum Ecosystem. In *29th USENIX Security Symposium (USENIX Security 20)*. USENIX Association, 2793–2810. <https://www.usenix.org/conference/usenixsecurity20/presentation/zhou-shunfan>
- [B115] Xin Zhou, Yuqin Jin, He Zhang, Shanshan Li, and Xin Huang. 2016. A Map of Threats to Validity of Systematic Literature Reviews in Software Engineering. In *2016 23rd Asia-Pacific Software Engineering Conference (APSEC)*. 153–160. <https://doi.org/10.1109/APSEC.2016.031>