

Highlights

Levelised Cost of Demand Response: Estimating the Cost-Competitiveness of Flexible Demand

Jacob Thrän, Tim C. Green, Robert Shorten

- The LCODR permits the comparison of storage and demand response solutions
- Four DR schemes: V2G, smart charging, smart heat pump, heat pump + thermal storage
- Heat pumps with thermal storage are cheaper than any other DR or storage technology
- V2G and smart charging are competitive with storage for some applications

Levelised Cost of Demand Response: Estimating the Cost-Competitiveness of Flexible Demand

Jacob Thrän^{a,b,*}, Tim C. Green^a, Robert Shorten^b

^a*Department of Electrical and Electronic Engineering, Imperial College London, South Kensington Campus, London, SW7 2AZ, United Kingdom*

^b*Dyson School of Design Engineering, Imperial College London, South Kensington Campus, London, SW7 2AZ, United Kingdom*

Abstract

To make well-informed investment decisions, energy system stakeholders require reliable cost frameworks for demand response (DR) and storage technologies. While the levelised cost of storage (LCOS) permits comprehensive cost comparisons between different storage technologies, no generic cost measure for the comparison of different DR schemes exists. This paper introduces the levelised cost of demand response (LCODR) which is an analogous measure to the LCOS but crucially differs from it by considering consumer reward payments. Additionally, the value factor from cost estimations of variable renewable energy is adapted to account for the variable availability of DR. The LCODRs for four direct load control (DLC) schemes and twelve storage applications are estimated and contrasted against LCOS literature values for the most competitive storage technologies. The DLC schemes are vehicle-to-grid, smart charging, smart heat pumps, and heat pumps with thermal storage. The results show that only heat pumps with thermal storage consistently outcompete storage technologies with EV-based DR schemes being competitive for some applications. The results and the underlying methodology offer a tool for energy system stakeholders to assess the competitiveness of DR schemes even with limited user data.

Keywords: Levelised cost of storage, Demand response, Electric vehicles, Vehicle-to-grid, Heat pumps

PACS: 0000, 1111

2000 MSC: 0000, 1111

1. Introduction

Demand response (DR) has long been praised for its potential benefits for power system operation [1]. The energy transition, with its need for the integration of increasing shares of variable renewable energy (VRE), has only amplified these potential benefits [2]. The addition of large domestic loads, like electric vehicles (EVs) and heat pumps (HPs) has simultaneously increased the effectiveness of DR [3], and advances in digital control have reduced the perceived inconvenience associated with it [4]. Barriers to DR remain, though, with two regularly mentioned challenges being the fragmented business case of DR and the regulatory framework around it [5]. The business case for DR is described as fragmented because it has the potential to create benefits for various stakeholders across the energy system. This fragmentation of DR benefits means that no single agent reaps all the benefits of an investment in DR schemes, potentially making it harder to establish a business model [5]. Various aspects of the regulatory framework have been described as barriers to DR uptake, with the exclusion of DR from certain revenue streams (e.g. capacity markets) being a frequently mentioned example [6].

For policymakers and stakeholders to reduce barriers to DR, it is imperative that they have detailed information about the competitiveness of different DR technologies. To understand the competitiveness of different consumer flexibility technologies, their costs and benefits have to be estimated and compared. To further assess their competitiveness against non-DR flexibility assets, cost and benefit estimations need to be in a format that allows for their

*Corresponding author

Email address: j.thran22@imperial.ac.uk (Jacob Thrän)

$$LCODR\left[\frac{\$}{MWh}\right] = \frac{Investment + \sum_t^T \frac{O\&M}{(1+r)^t} + \sum_t^T \frac{Rewards}{(1+r)^t} + \sum_t^T \frac{Rebound}{(1+r)^t} + \frac{End-of-life\ costs}{(1+r)^{T+1}}}{\sum_t^T \frac{E_{app}}{(1+r)^t}} \quad (1)$$

comparison with storage, or flexible generation assets. The benefits of DR have been appraised both qualitatively [5], and quantitatively [7]. A number of reviews have also qualitatively discussed the barriers and costs of DR [8]. For quantitative cost estimations, however, existing studies either only consider consumer payments [4, 9, 10] or techno-economic costs [11, 12, 13]. To the best of the author’s knowledge, no measure exists that combines consumer payments and techno-economic costs into a comprehensive framework which can also be used to compare costs to other flexibility assets, like energy storage.

DR schemes are often framed as a cost-efficient alternative to investment in energy storage because they promise lower capital costs [14]. This advantage may be counteracted by DR’s requirement for continuous reward payments which increases operational costs [9]. For cost assessments of electricity generation and storage, capital and operational expenditure are often combined in the levelised cost of electricity (LCOE) or storage (LCOS). These represent the average annuitised cost per unit of electricity (generated or stored). DR, by definition, shifts electricity demand temporally, thereby creating a similar effect on the electricity grid as grid-connected energy storage. As such, a measure for the levelised cost of demand response (LCODR), analogous to the LCOS is proposed in this paper, providing a combined measure of investment and operational expenses for DR.

Vehicle-to-grid (V2G) technology, which will be considered a type of DR in this paper, has recently been included in extended LCOS estimations [11, 12, 13]. These estimations simply extend the LCOS methodology to the techno-economic features of V2G, though, and do not consider that DR schemes like V2G exhibit crucial differences to storage technologies. The recently proposed levelised cost of energy flexibility (LCOEF) [15] is, to the best of the authors’ knowledge, the only measure that aims to compare the annuitised lifetime per-unit costs of different DR schemes. However, it also focuses mostly on the techno-economic features and does not consider survey-informed consumer reward payments in detail. None of the studies mentioned above [11, 12, 13, 15] develop a methodology to address the availability profiles of different DR schemes and how they may affect their value. The LCODR proposed in this work improves upon this by adjusting the LCOS methodology to account for two key differences with DR: firstly, DR schemes require consumer participation which necessitates paying participation rewards, something that grid-scale storage naturally does not require. This difference is addressed in this paper by including an additional “reward payments” term in the LCODR equation. The second key difference is that DR exhibits variations in availability whereas storage technologies tend to be continuously connected. Flexibility from V2G for example will only be available when the corresponding EV is plugged in. This difference is analogous to the difference in availability between VRE sources like wind or solar and continuously available conventional generators like gas turbines. Numerous studies have developed methods to adjust the LCOE for this difference in availability [16]. One of these methods, the value factor from Hirth [17] is adapted in this paper to address the intermittent availability of DR assets.

The remainder of this paper is organised as follows: Section 2 formally introduces the LCODR as well as the DR schemes and applications for which it is calculated. Section 3 presents the methodology for estimating the LCODR of various pairings of DR schemes and applications, including the estimation of the value factor to adjust for variable availability. Section 4 describes the data that was used for a case study of the levelised DR costs in the context of the British electricity system. Section 5 presents the results, contrasts them with storage costs and discusses their limitations. Section 6 concludes the paper.

2. Levelised cost of demand response

Borrowing from the definition of the LCOS [18], the levelised cost of demand response is the total lifetime cost of a DR scheme per unit of cumulative shifted electricity demand. Shifted electricity is always measured as the delivered reduction in electricity demand rather than the increase in demand at other times. This is in line with the definition of the LCOS which measures costs per unit of discharged electrical energy [19]. In the case of V2G, shifted electricity can also extend to electricity delivered back to the grid. The computation of the LCODR in energy terms is shown in Equation (1). For applications that value available power rather than delivered energy, the LCODR in power terms, shown in Appendix A, may be preferred. The LCODR terms in the numerator are identical to that of the LCOS, except

Nomenclature

A	Area rented for hot water storage in m^2	ΔQ_b	Building's permitted heat divergence kWh
COP	Heat pump's coefficient of performance	ΔT_w	Temperature range of hot water storage in K
E_{drive}^{daily}	Energy used by EV daily for driving in kWh	ΔT_b	Maximum permitted temperature divergence in heat-pump-only DLC contract in K
E_{EV}^{arr}	EV battery's energy level upon arrival in kWh	Δt_{cha}^{day}	Daily time required for charging EV in h
E_{EV}^{max}	EV battery's energy capacity in kWh	Δt_{DD}	Application's discharge duration in h
E_{EV}^{min}	EV battery's minimum energy level in kWh	Δt_{PD}	Average plug-in duration in h
E_{app}	Application's shifted/discharged energy in kWh	Δt_{RP}	Daily required plug-in time (RPT) in h
E_{bat}^{max}	Battery's energy capacity in kWh	$\Delta t_{base}^{plug-in}$	RPT for p_{base}^{WTA} in h
E_{bat}^{min}	Battery's minimum energy level in kWh	δ_w	Hot water storage density in kg/m^3
H	Residential ceiling height in m	η_{cha}	Efficiency of charger
L	Wall thickness of hot water storage in m	a_f^{V2G}	Availability factor for V2G (fraction of time that an EV is plugged in for)
N_{cha}^E	Number of required V2G chargers for energy	a_{GMC}	Guaranteed minimum charge in %
N_{cha}^P	Number of required V2G chargers for power	a_{HC}	Fraction of EV's driving energy charged at home
N_{HP}^{adj}	Number of required HPs adjusted for activation frequency constraints	$c_{p,b}$	Building's specific heat capacity in $kJ/(kg \cdot K)$
N_{cha}^{avail}	Number of available V2G chargers required	$c_{p,w}$	Hot water specific heat capacity in $kJ/(kg \cdot K)$
N_{cha}^{contr}	Number of contracted V2G chargers required	f_{act}^{max}	Maximum frequency of activations in heat-pump-only DLC contract per month
N_{1D}	Number of required unidirectional DR assets	m_b	Building's mass in kg
N_{app}^{cyc}	Application's number of annual cycles	m_w	Hot water storage mass in kg
P_t^{DR}	Available DR power reduction at time t in kW	p_t^E	Electricity spot price in time interval t in $$/kWh$
P_{app}^{cap}	Application's required power capacity in kW	p^{WTA}	Consumers' median willingness-to-accept for DR heating schemes in $$/month$
P_{cha}^{cap}	Power capacity of EV charger in kW	p_{base}^{WTA}	Consumers' median willingness-to-accept for base contract of 11.5 hours of RPT in $$/month$
P_{1D}^{avg}	Average shiftable power consumption of a unidirectional DR asset in kW	p_{hour}^{WTA}	Consumers' median willingness-to-accept per hour of RPT in $$/month$
P_{1D}^{cap}	Power consumption capacity of a unidirectional DR asset in kW	r	Discount rate
P_{EV}^{max}	EV charger's maximum power in kW	t_{EV}^{arr}	EV's arrival time
$P_{HP}^{act,avg}$	Average power use of activated HPs in kW	t_{EV}^{dep}	EV's departure time
P_{bat}^{max}	Battery's maximum power in kW	t_{act}	Time of DR activation
Q_w	Thermal energy in hot water storage in kWh	t/T	Index/Set of time intervals
SPF	Heat pump's seasonal performance factor		
V_w	Hot water storage volume in m^3		
ΔE_{HP}^{elec}	HP's electrical energy needs for heating thermal storage in kWh		
ΔP_{HP}^{red}	DR-related reduction in HP power in kW		

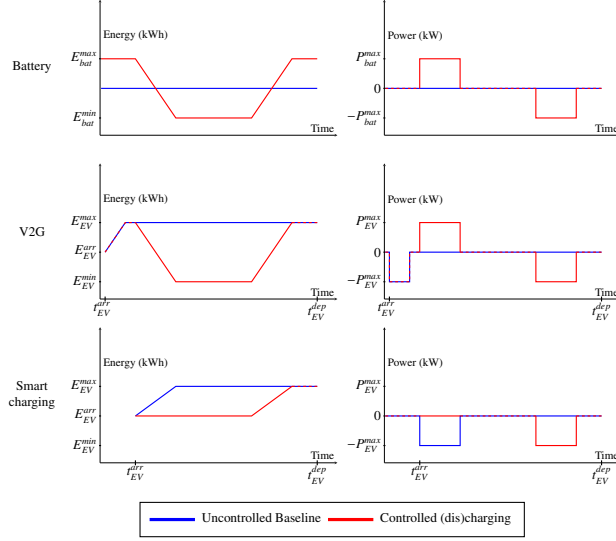

Figure 1: Energy and power profiles for servicing an energy storage application with different technologies. Note that the minimum energy level for EVs (E_{EV}^{min}) is their energy capacity (E_{EV}^{max}) multiplied by the guaranteed minimum charge (f_{GMC}): $E_{EV}^{min} = E_{EV}^{max} \times f_{GMC}$

for two differences. Firstly, the charging costs are replaced by rebound costs which describe the cost of supplying electricity for the shifted electricity demand. Secondly, an additional reward payments term is introduced in Equation (1) to reflect the need for financial compensation to consumers.

Figure 1 shows how a single discharge cycle can be provided using a battery, a V2G-capable vehicle, or a uni-directional smart charger. Storage and DR assets can be used to service a variety of applications, such as energy arbitrage or various ancillary services. The LCOS is normally estimated individually for each potential application. Any application that is centred on active power delivery, can be characterised by four main features: response time, rated power, discharge duration, and the annual number of discharges [18]. Response time is a prerequisite for a technology to be able to service a certain application. The other three features strongly impact the required design of a storage or DR asset, and thereby greatly influence the resulting levelised costs.

The power and energy capacities of storage technologies can be designed relatively independently to meet the characteristics of a specific application. The domestic DR assets that are considered in this paper, on the other hand, are often much more constrained in their power-to-energy capacity ratio. For V2G and smart charging, for example, the energy capacity is very difficult to change for a single vehicle/charger, because this would imply redesigning the EV's battery. The power capacity of the charger would be easier to alter but is usually limited by the power rating of a household's grid connection. Charger power and the energy capacity of an EV's battery are therefore considered unchangeable in the rest of this paper. The only DR scheme where the power-to-energy capacity ratio is not considered set is the combination of heat pump and hot water tank (HP + thermal storage) where the tank's volume is independent of the power capacity.

With DR's fragmented business case, different elements of the costs are incurred by different stakeholders, meaning it is important to specify the perspective of the cost assessment. The proposed LCODR approach takes the perspective of the beneficiary from responsive consumers, rather than the consumers themselves. In recent literature, this beneficiary is often referred to as an "aggregator" which could be an energy supplier or an intermediary that sells flexibility from DR to grid operators, generators or suppliers. The proposed DR schemes all fall under the DR category of direct load control (DLC), meaning they do not require consumers to directly engage with a price signal. Instead, consumers are paid monthly compensation for giving away some of the control over one of their assets. In the assessed DR scenarios, installing the required infrastructure is considered a cost to the aggregator, meaning consumers have it installed at no extra cost to them as part of their DR contract.

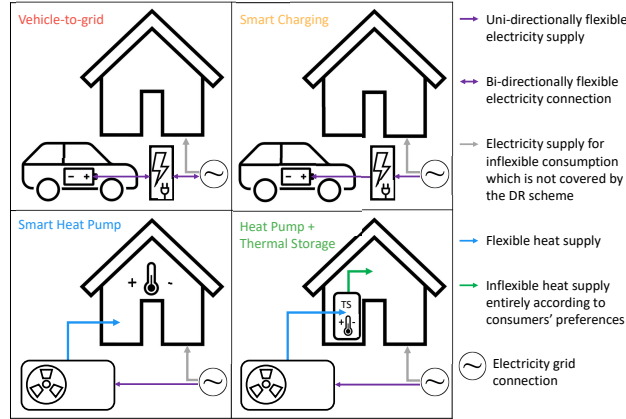

Figure 2: Illustration of the components and estimation process of the availability profile-adjusted LCODR ($LCODR_{VF}$)

2.1. Demand response schemes and applications

The levelised costs for four different DR schemes are considered in this paper: V2G, EV smart charging, smart heat pumps and heat pumps with thermal storage. They are illustrated in Figure 2 and their details are listed below.

1. **V2G** describes the delivery of power from EVs to the grid and requires the installation of a bidirectional charger. Consumers on this contract indicate their departure time at which the aggregator ensures a fully charged battery. Before departure, the aggregator is free to discharge the battery to a specified guaranteed minimum charge (GMC) which the consumer reserves for unexpected journeys. Consumers commit to fulfilling a daily required plug-in time (RPT) and receive a monthly reward for making their vehicle available for V2G.
2. **Smart charging** contracts work much in the same way as V2G except that they work with unidirectional chargers. Rather than discharging, smart charging allows the aggregator to shift the charging time within the plugin period (again while ensuring a full battery at the indicated departure).
3. The heat pump schemes also work by shifting electricity consumption temporally. The **smart heat pump** scheme uses consumers' homes as a thermal battery while the heat pump with thermal storage uses home-installed hot water storage tanks instead. Consumers on the smart heat pump scheme specify a maximum temperature setting divergence (ΔT_b) which allows the aggregator to temporarily increase their house's temperature above or below the specified setting. The aggregator can only do this for a specified maximum number of activations per month (f_{act}^{max}).
4. The **heat pump with thermal storage** tariff installs a heat storage tank within the consumer's home which will be entirely controlled by the aggregator while ensuring the heating preferences of the consumer are met without exception. This scheme is somewhat innovative in that it potentially does not impact consumers' lives at all (not even having to indicate preferences like departure times). For that reason, no conventional reward payments are considered for this tariff. Instead, consumers are compensated for the space that the hot water tank takes up (the installation of which is already paid for by the aggregator).

The 12 storage applications from [18] are considered in this paper as potential applications for DR. Table 1 shows the suitability of the DR schemes for the 12 applications. Response times should not be an issue for any of the DR technologies with Zhang et al. [20] and Lee et al. [21] showing that even the pairing of heat pumps with primary response is possible. Black start, power reliability and power quality services require active power delivery rather than just load shifting, so unidirectional DR assets are not suitable for this. Seasonal storage requires long discharge durations that cannot be serviced by any of the DR assets.

	P_{app}^{cap} MW	Δt_{DD} h	N_{app}^{cyc}	V2G	Smart charging	Heat pump	HP & thermal storage
Energy arbitrage	100	4	300	✓	✓	✓	✓
Primary response	10	0.5	5000	✓	✓	✓	✓
Secondary response	100	1	1000	✓	✓	✓	✓
Tertiary response	100	4	10	✓	✓	✓	✓
Peaker replacement	100	4	50	✓	✓	✓	✓
Black start	10	1	10	✓			
Seasonal storage	100	700	3				
T&D invest. deferral	100	8	300	✓	✓	✓	✓
Congest. management	100	1	300	✓	✓	✓	✓
Bill management	1	4	500	✓	✓	✓	✓
Power quality	1	0.5	100	✓			
Power reliability	1	8	50	✓			

Table 1: Suitability of DR schemes for storage applications including application requirements from [18]

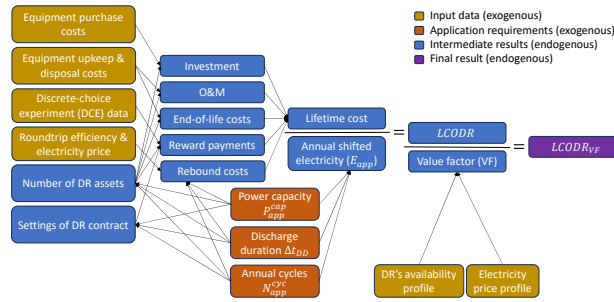

Figure 3: Illustration of the components and estimation process of the availability profile-adjusted LCODR ($LCODR_{VF}$)

3. Methodology

In the following, a consumer who is enrolled in a DLC scheme and has the required infrastructure installed will be labelled a “DR asset”. To identify the cost of delivering a certain service, it is crucial to identify the number of DR assets that are required to be available to deliver said service (Section 3.1). The number of assets and their reward payments can further be affected by the required discharge duration (Section 3.2) and the number of annual activations (Section 3.3). To adjust the LCODR for differences in availability profile, it is divided by the value factor (Section 3.4). To account for uncertainties in all of the input data, a Monte-Carlo simulation is carried out (Section 3.5). Figure 3 illustrates the estimation process for the availability profile-adjusted LCODR. It differentiates input parameters and intermediate variables. Input parameters are either from the data sources detailed in Section 4 or dictated by the requirements of the application for which the LCODR is being estimated (see Table 1).

3.1. Estimating the number of required demand response assets

The methodology for identifying the number of required assets varies between V2G and unidirectional DR schemes.

3.1.1. Vehicle-to-grid

Given that the chargers’ power capacity and the EVs’ energy capacity are considered immutable, the number of available chargers required, N_{cha}^{avail} , is either dictated by the power, P_{app}^{cap} , or the energy, E_{app} , requirements, depending on the application. To make sure that both energy and power requirements are met, the higher number between the energy-mandated (N_{cha}^E) and power-mandated (N_{cha}^P) number of chargers has to be chosen.

$$N_{cha}^{avail} = \max(N_{cha}^P, N_{cha}^E) \quad (2)$$

The number of available chargers required to provide the needed power (N_{cha}^P) is simply the power capacity required by the application (P_{app}^{cap}) divided by the effective power capacity of an individual bidirectional charger ($P_{cha}^{cap} \times \eta_{cha}$).

$$N_{cha}^P = \frac{P_{app}^{cap}}{P_{cha}^{cap} \times \eta_{cha}} \quad (3)$$

Similarly, the number of available chargers needed to provide the required energy capacity (N_{cha}^E) is obtained by dividing an application's required energy capacity (E_{app}^{cap}) by the available energy capacity of a singular EV ($E_{EV}^{max} - E_{EV}^{min}$). The available energy capacity of a single EV is dictated by its battery's capacity (E_{EV}^{max}) and the guaranteed minimum charge (a_{GMC}) which is the minimum level of energy that a V2G contract commits to always leaving in a vehicle's battery. The needed energy capacity for an application is the product of power capacity (P_{app}^{cap}) and discharge duration (Δt_{DD}).

$$N_{cha}^E = \frac{E_{app}}{E_{EV}^{max} - E_{EV}^{min}} = \frac{P_{app}^{cap} \times \Delta t_{DD}}{E_{EV}^{max} \times (1 - a_{GMC})} \quad (4)$$

The estimations above are for the required number of available chargers. A key difference between DR and storage is that DR assets are not always available (e.g. V2G-capable EVs are not always plugged in). To obtain a cost estimate, it is crucial to obtain the number of contracted chargers that are required to ensure that on average there are enough available chargers. The number of available chargers is a product of the number of contracted chargers and the availability factor (a_f^{V2G}) which is the fraction of time that each charger is available for. This relationship can be rearranged to calculate the number of contracted chargers required

$$N_{cha}^{contr} = \frac{N_{cha}^{avail}}{a_f^{V2G}} \quad (5)$$

The available time per day for bidirectional charging is simply the average daily time that the vehicle is plugged in for, and not charging. The amount of time that EVs will be plugged in for, if drivers get paid for plugging in, is difficult to estimate because few such schemes exist today. Many V2G choice experiments [22, 23] include a minimum daily RPT term, though. It is assumed that consumers plug in for as long as they are required by their contracts (Δt_{RP}), and no longer. The daily charging time (Δt_{cha}^{day}) can be determined from the effective charger power ($P_{cha}^{cap} \times \eta_{cha}$) and the average daily energy used for driving (E_{drive}^{daily}). f_{hc} is the fraction of the latter which is charged at the domestic V2G charger.

$$a_f^{V2G} = \frac{\Delta t_{RP} - \Delta t_{cha}^{day}}{24h} = \frac{\Delta t_{RP} - \frac{E_{drive}^{daily} \times a_{HC}}{\eta_{cha} \times P_{cha}^{cap}}}{24h} \quad (6)$$

Dividing by the availability factors only means that the required capacity will be available on average. While this ensures that on average the DR assets can provide the same service as storage, their profile may vary quite significantly from the flat profile of a continuously available storage asset. Section 3.4 introduces a methodology to adjust for an uneven availability profile.

3.1.2. Unidirectional demand response

In contrast to V2G, unidirectional DR schemes have the number of required available assets dictated only by power requirements. This is because the available power is dictated by the uncontrolled power consumption that can be moved by DR. This consumption also dictates the energy that can be moved, meaning that meeting the power requirements also ensures that the energy requirements are met. Equation (7) gives the number of assets (N_{1D}) required to fulfil the power requirements which is similar to that of V2G from Equation (3).

$$N_{1D} = \frac{P_{app}^{cap}}{P_{1D}^{avg}} \quad (7)$$

Unidirectional DR assets are only available when they would otherwise be consuming in an uncontrolled scenario, meaning usually more need to be contracted than in the V2G scenario to ensure enough of them are available. No availability factor has to be applied to Equation (7) because utilising the average power is equivalent to adjusting the power capacity for its availability (i.e. $P_{1D}^{avg} = P_{1D}^{cap} \times a_f^{1D}$).

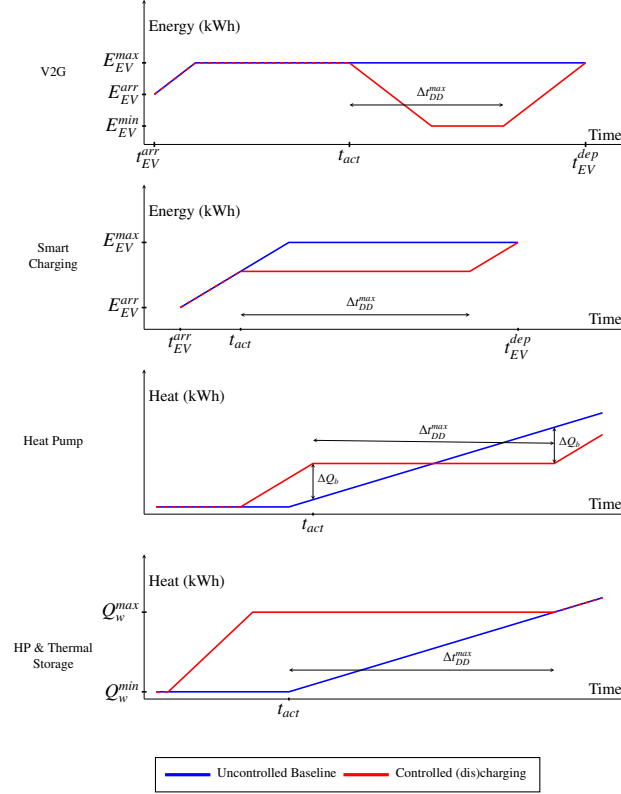

Figure 4: Discharge duration limits illustration on the energy profiles of different DR assets. Note that the heat pump-only profile (3rd graph) shows an activation that reduces the heat pump's power consumption to zero ($\Delta P_{HP}^{red} = P_{HP}^{act,avg}$)

3.2. Discharge duration constraints

Even though unidirectional DR assets do not discharge energy, the term discharge duration will be used throughout this paper to denote the duration of activation, i.e. duration of lowered electricity consumption. The discharge duration is limited by the rebound for unidirectional DR assets (recharge for V2G). This is because the energy that is required to fulfil the rebound requirements would count against the DR activation and thereby annul it, even if other assets were continuing the demand reduction. Figure 4 shows how the rebound limits the discharge duration for the different DR assets.

3.2.1. Vehicle-to-grid

For both EV-based DR schemes, the discharge duration depends on the average duration for which vehicles are plugged in. While data exists for current plug-in durations [24], this does not take into account that plug-in durations will likely be longer when consumers are financially incentivised to plug in for longer. Consumer survey data for the effect of financial incentives on daily RPT is available both for V2G (e.g. [22, 25, 26]) and smart charging [27]. RPT states the number of hours per day that an EV has to be plugged in for and can only be translated into the average plug-in duration by assuming a plug-in frequency. An EV that has an average daily plug-in time of 20 hours, for example, will have an average plug-in duration of 10 hours if its plug-in frequency is twice per day. In the following, an average plug-in frequency of once per day is assumed, resulting in the average plug-in duration being equal to the daily RPT ($\Delta t_{PD} = \Delta t_{RP}$).

For V2G, the discharge may start at any point during the time that an EV is available for V2G services which will be simulated by assuming that discharge starts halfway through the plug-in period. This means that, during actual

operation, the discharge duration may be constrained to be shorter or allowed to be longer, but on average it will be constrained by Equation (8).

$$\Delta t_{DD}^{max} = \frac{\Delta t_{PD} - \frac{E_{drive}^{daily} \times a_{HC}}{\eta_{cha} \times P_{cha}^{cap}}}{2} - \frac{E_{EV}^{max} - E_{EV}^{min}}{\eta_{cha} \times P_{cha}^{cap}} \quad (8)$$

The time needed for charging driving energy needs ($E_{drive}^{daily} \times a_{HC}$) and recharging any V2G-discharged energy ($E_{EV}^{max} - E_{EV}^{min}$) cannot be used for V2G, and therefore has to be subtracted.

3.2.2. Smart charging

The activation of flexibility from smart charging can only occur when the EV would otherwise be charging, which, in an uncontrolled charging scenario, is only the case for a limited time window after plugging in. The remaining time therefore acts as an upper constraint for the discharge duration, because afterwards, the previously delayed energy will have to be charged.

$$\Delta t_{DD}^{max} = \Delta t_{PD} - \frac{E_{drive}^{daily} \times a_{HC}}{P_{cha}^{cap} \times \eta_{cha}} \quad (9)$$

Note that several EVs are needed to achieve a discharge duration that is longer than the uncontrolled charging time. Once an EV is forced to recharge because its departure is near, however, the recharge would work against the effect of the next EV's charging delay, turning the plug-out time into an upper limit for the discharge duration.

3.2.3. Smart heat pump

For the heat pump-only scheme, the discharge duration is limited by the allowed temperature divergence (ΔT_b) and the building's heat capacity ($m_b c_{p,b}$) which is the amount of thermal energy it takes to heat the building by one degree Celsius. Together these dictate the possible difference in the building's thermal energy (ΔQ_b) which can be used to deduct the discharge duration as shown in Figure 4. Note that Figure 4 shows a case in which the heat pump is used to actively heat up the building but if the heat pump only maintained the temperature to make up for heat losses, the inferred relationships would remain the same. The difference in the red and blue slopes is the reduction in the effective heating rate which is the product of the reduction in heating power and the seasonal performance factor ($\Delta P_{HP}^{red} \times SPPF$). The $SPPF$ is an annual power-weighted average of the Coefficient of Performance (COP) which measures the heat output of a heat pump per unit of electrical energy input. Dividing the difference in electrical energy input (E_{HP}^{elec}) by the reduction in heating power (ΔP_{HP}^{red}) gives the duration associated with a certain temperature threshold (ΔT_b). This duration is doubled to obtain the maximum discharge duration (Δt_{dd}^{max}) because the temperature setting can be exceeded by ΔT_b before activation and subsided by ΔT_b afterwards.

$$\Delta t_{DD}^{max} = 2 \times \frac{\Delta E_{HP}^{elec}}{\Delta P_{HP}^{red}} = 2 \times \frac{\Delta Q_b}{\Delta P_{HP}^{red} \times SPPF} = 2 \times \frac{m_b c_{p,b} \Delta T_b}{\Delta P_{HP}^{red} \times SPPF} \quad (10)$$

The possible reduction in heating power decreases as discharge duration goes up because longer discharge durations require longer reductions in heating power which can only remain within the tolerated temperature divergence (ΔT_b) if the heating power is reduced by less. It would be impossible for the power reduction to exceed the heat pump's active power consumption which is accounted for in Equation (11).

$$\Delta P_{HP}^{red} \leq P_{HP}^{act,avg} \quad (11)$$

$P_{HP}^{act,avg}$ denotes the average power consumption of activated heat pumps, i.e. the average power consumption when a heat pump is turned on. Even though heat pumps are a unidirectional DR asset, $P_{HP}^{act,avg} \neq P_{1D}^{avg}$ because the former denotes the average non-zero power whereas the latter includes times when the heat pump is off.

3.2.4. Heat pump and thermal storage

For the tariff that includes thermal storage, the discharge duration is limited by how long the thermal storage can sustain the heat supply that would otherwise have been supplied by the average power consumption of the heat pump when switched on ($P_{HP}^{act,avg}$). Since the heat storage can be designed to always meet the entire heating demand, a DR activation in this scheme always reduces the power demand to zero ($\Delta P_{HP}^{red} = P_{HP}^{act,avg}$), to minimise the number of required assets under contract.

$$\Delta t_{DD}^{max} = \frac{\Delta E_{HP}^{elec}}{\Delta P_{HP}^{red}} = \frac{Q_w^{max} - Q_w^{min}}{P_{HP}^{act,avg} \times S PF} = \frac{m_w c_{p,w} \Delta T_w^{max}}{P_{HP}^{act,avg} \times S PF} \quad (12)$$

The mass of water within the thermal storage can be calculated from its density and the volume of the storage. It is assumed that the hot water storage tanks are cylindrical but that reward payments have to be paid for the associated square area on which the cylinder sits. Equation 13 expresses water mass as a function of the rented area (A).

$$m^w = \delta_w V_{st} = \delta^w ((H - 2L) \times (\pi \times (\frac{\sqrt{A}}{2} - L)^2)) \quad (13)$$

Here, H is the ceiling height and L is the insulation wall thickness.

3.3. Constraints for the number of cycles

The smart heat pump scheme (without thermal storage) is the only one that limits the number of annual cycles. This is because an activation affects consumers directly as it influences the temperature within their home. The allowed number of weekly activations is a key contract term for the heat pump scheme and if there are more cycles than can be provided by a single contracted heat pump, more heat pumps are needed following the relation shown in Equation (14).

$$N_{HP}^{adj} = \frac{f_{act}^{max} \times 12}{N_{app}^{cyc}} \times N_{1D} \quad (14)$$

Here, N_{HP}^{adj} denotes the number of contracted heat pumps once adjusted for the number of allowed activations. This is expressed as a function of the unadjusted number of heat pumps (N_{1D}), the maximum number of activations per month (f_{act}^{max}), and the annual cycle requirement of the storage application (N_{app}^{cyc}).

3.4. Value factor

The value of electricity is strongly influenced by the time at which it is made available. When assessing the cost of VRE, this issue was quickly realised and addressed by a broad body of literature [16, 17, 28, 29, 30]. With LCOS being equivalent to LCOE for storage technologies, DR assets can be considered to behave analogous to VRE generation in that they vary in their availability. The methods that adjust for the variability of VRE can therefore be applied to address the variable availability of DR. In this paper, the value factor from [17] is adapted. To obtain this for a given VRE asset, its generation profile is multiplied by the energy price profile and then divided by the same product for a flat generation profile. The same procedure is applied for DR, with the main difference being that rather than generated electricity, the potential for electricity demand reduction (or discharge in the case of V2G) is measured, denoted in Equation (15) as P_t^{DR} .

$$VF = \frac{\sum_{t=1}^{t=T} P_t^E P_t^{DR}}{\sum_{t=1}^{t=T} P_t^E \frac{\sum_{t=1}^{t=T} P_t^{DR}}{T}} \quad (15)$$

For unidirectional DR assets P_t^{DR} is simply the power that would be consumed in an uncontrolled scenario in time period t and can be moved away. For V2G, P_t^{DR} is the available charger power that can be discharged in time period t . When the energy requirements dictate the number of V2G chargers (i.e. $N_{cha}^E > N_{cha}^P$), P_t^{DR} has to be replaced by E_t^{DR} which is the energy available for discharging in time period t . To assess the power and energy profiles for V2G, the virtual battery from Thrän et al. [31] was used, with P_t^{DR} being inferred from the power boundary and E_t^{DR} being the

difference between the energy boundaries. A value-adjusted LCODR ($LCODR_{VF}$) can be computed by dividing the original cost estimate by the value factor as shown in Equation (16).

$$LCODR_{VF} = \frac{LCODR}{VF} \quad (16)$$

3.5. Monte-Carlo simulation

To reflect the uncertainty of the input parameters that are presented in the following section, a Monte Carlo simulation is implemented. The methodology for this largely follows that of Schmidt and Staffell [32] with the number of drawn samples set to 1000. Monte Carlo samples are taken from a normal distribution that is truncated at 1.285 standard deviations above and below the mean input value. The mean input values for different parameters are given in the various tables in Section 4. Standard deviations are assumed to be at 33% for all inputs except for the highly uncertain parameters which are assumed to be subject to a standard deviation of 67%. The latter applies to the V2G charger cost, the investment costs required for thermal storage, and all consumer reward terms. For the estimated value factors, a standard deviation of 10% is assumed to reflect the possible effect of increased VRE generation or a potential price cannibalism effect caused by higher penetrations of storage or DR. The uncertainty in the value factors is expected to be relatively low because some established electricity price profile patterns (e.g. expensive evening hours) would have to significantly change for them to vary.

4. Data

Differences in socio-economic patterns, car usage, and climate mean that the LCODR is better computed for specific regions rather than globally. The presented data in this section is for a case study of the LCODR in Great Britain. Because of the low prevalence of domestic DLC schemes, data sources are not always available for Britain so data was also taken from studies that were conducted in regions with similar socio-economic structures. In general, the lack of accessible DLC consumer engagement data has meant that data sometimes had to be repurposed out of context, reducing the robustness of the results.

4.1. Investment costs

Capital costs for the different DR schemes are given in Table 2. Note that all investment costs measure the upgrade from an existing domestic charging/heating set-up, as consumers are expected to install this regardless of DR participation. The first three DR schemes all require investment in only one piece of infrastructure (first three rows of Table 2). Heat pumps with thermal storage, however, require both a smart thermostat and hot water storage. Advanced metering infrastructure is also a prerequisite for any of the DR tariffs and can come at a considerable cost [33]. However, many countries, including the United Kingdom, have pledged to roll out smart meters, meaning this will likely not be a cost to the DR aggregator [34] and is therefore not considered in this study.

Parameter	Unit	Value	Source
V2G charger cost	\$/charger (7.4kW)	3,000	[11, 12]
Smart charger cost	\$/charger (7.4kW)	107	[35]
Smart thermostat	\$/thermostat	85	[36]
Hot water storage	\$/m ³	2042	[37]

Table 2: Investment costs

4.2. Reward payments

Accurately estimating reward payments is a difficult aspect of the LCODR data collection. Few commercial DR schemes exist for the four variants considered in this paper so consumers' preferences cannot be inferred from them, especially when considering their choices regarding specific contract settings like RPT for the EV-based schemes. When consumers' revealed preferences cannot be observed by looking at their purchasing habits (i.e. enrolment data for existing commercial DR schemes), consumers' stated preferences can instead be captured through discrete-choice

experiments (DCEs) [38]. DCEs ask participants to choose between hypothetical alternative scenarios of a good or service with different attributes. The relative importance of these attributes can then be inferred from their choices [39] and can be translated into the willingness-to-pay (WTP) for an attribute. For DLC schemes, where the aggregator pays the consumers, the equivalent measure for WTP is the willingness-to-accept (WTA) which states the amount of monthly financial reward participants associate with a change in the terms of the DR contract. DCEs have been carried out to estimate the WTA for EV-based DR attributes like GMC or RPT for V2G [22, 26, 40, 41] and smart charging tariffs [27, 42]. While giving a good estimate of, for example, the WTA per additional hour of RPT (p_{hour}^{WTA}), they do not measure the “base-WTA” (p_{base}^{WTA}) that consumers need to receive to sign up for a flexible charging tariff over their base contract that allows them uncontrolled charging. There are only a couple of studies that set out to measure p_{base}^{WTA} for V2G over uncontrolled charging [10, 43] and there are, to the best of the authors’ knowledge, no studies that measure p_{base}^{WTA} of choosing a smart charging tariff over uncontrolled charging. To use consistent data sources, and since there were no academic sources for the smart charging “base-WTA”, commercially available smart charging [44, 45, 46] and V2G [47] tariffs were used instead. These are often given as reductions on the energy price for EV charging which are converted to monthly reward payment costs by multiplying them with the daily driving energy (E_{drive}^{daily}), the fraction of that charged at home (a_{HC}), and the consumer energy price [48]. Table 3 shows the reward payment parameters that are ultimately used to estimate the LCODR. The WTA per hour of RPT is taken from DCEs in various countries. The reward payments per charger for a given RPT can be calculated by using the base cost and adding the WTA per hour of RPT multiplied by the additional number of hours. For an exemplary smart charging contract with an RPT of 15 hours, the reward payment estimation is shown in Equation (17).

$$Rewards = p_{base}^{WTA} + (\Delta t_{RP} - \Delta t_{base}^{plug-in}) \times p_{hour}^{WTA} = 33.1 + (15 - 11.5) \times 19.3 = 100.7\$/DR\ asset \quad (17)$$

To ensure that Equation (17) does not produce negative reward payments, a minimum monthly reward of \$5 was assumed for Smart charging and heat pumps with thermal storage. A minimum of \$10 was assumed for V2G. Regarding reward payments for the heat pump tariff, data from a controlled air conditioning DCE in the US is repurposed under the assumption that temperature differences cause the same discomfort, be it for cooling or heating. All DCE data represents the median WTA, i.e. the reward payment at which half of the sample population is expected to participate in a DR scheme. At low penetrations of DR, WTA may be significantly cheaper because consumers with a lower WTA (e.g. early adopters) could be targeted first.

DR Scheme	Measure	Unit	Value	Source
V2G	p_{base}^{WTA}	\$/month/charger	46.4	[47]
	p_{hour}^{WTA}	\$/month/hour(RPT)	27.2	[22, 25, 26]
Smart charging	p_{base}^{WTA}	\$/month/charger	33.1	[44, 45, 46]
	p_{hour}^{WTA}	\$/month/hour(RPT)	19.3	[27]
Heat pump	p_{hour}^{WTA}	\$/month/thermostat	9.5	[33]
HP & storage	p^{WTA}	\$/month/m ²	13.6	[49, 50]

Table 3: Reward payments

4.3. Operation and maintenance, end-of-life costs and lifetime

In line with recent studies [51] the annual operation and maintenance costs ($O\&M$) are assumed to be 5% of the capital investment and the lifetime is assumed to be 15 years. End-of-life costs are assumed to be zero for the smart charging and smart heat pump tariff, 50\$ per V2G charger, and 10\$ per m² of hot water tank surface.

4.4. Miscellaneous data

The estimates for additional parameters, including their sources, are shown in Table 4. Note that, the temperature difference for the hot water storage (ΔT_w) can take any value, as long as the high temperature does not exceed 100°C. A higher value of ΔT_w results in higher losses from decreased COPs and heat dissipation while also decreasing the required storage volume and thereby area. Optimisation could be applied to ΔT_w to balance these counteracting effects but this is outside the scope of this work. Instead, ΔT_w was chosen at the relatively low value of 35 K to reduce energy losses from COP changes and heat transfer so that they can be neglected. With the hot water storage assumed to be inside the living area, heat dissipation may be considered to contribute to space heating anyway. The electricity price was assumed to be 50\$/MWh to be consistent with Schmidt et al. [18].

Scheme	Parameter	Symbol	Unit	Value	Source	
V2G & smart charging	(Dis-)charging efficiency	η	%	92	[52]	
	Base plug-in time (avg)	$t_{base}^{plug-in}$	h	11.5	[24]	
	EV battery's energy capacity	E_{EV}^{max}	kWh	60	[53]	
	Charger's power capacity	P_{cha}^{cap}	kW	7.4	[54]	
	Guaranteed minimum charge	a_{GMC}	%	30	[47]	
	Daily driving energy	E_{drive}^{daily}	kWh/day	5.56	[55, 56]	
	RPT for p_{base}^{WTA}	$\Delta t_{base}^{plug-in}$	h	11.5	[24, 47]	
	Fraction of energy charged at home	a_{HC}	%	90	[57]	
	Heat pump	Average power consumption	P_{HP}^{avg}	kW	0.46	[58]
		Average power when on	$P_{HP}^{avg,act}$	kW	1.68	[58]
Seasonal performance factor		SPF		2.71	[58]	
Storage	Building's heat capacity	$m^b c_p^b$	kJ/K	34,780	[49, 59]	
	Insulation thickness	L	m	0.05	[60]	
	Min. ceiling height	H	m	2.3	[61]	
	Water density	δ^w	kg/m ³	1,000	[62]	
	Specific heat capacity of water	c_p^w	kJ/(kg · K)	4.18	[62]	
	Water storage temperature difference	ΔT_{max}^w	K	35	Design choice	

Table 4: Additional Parameters

4.5. Value factor

The value factor for the EV-based tariffs is estimated based on data from the Department for Transport [24]. For the heat pump-based tariffs, the estimations are based on data from the Renewable Heat Premium Payment scheme [58]. Price data in both cases comes from the Balancing Mechanism Reporting Service [63].

5. Results and discussion

5.1. Value factor

Results for the value factors were obtained using the methodology in Section 3.4 and the data sources from Section 4.5. Table 5 shows the value factor results for the different DR schemes. The value factor compares the availability profile of a DR scheme with a continuously available flexibility asset (i.e. most storage technologies). The more a DR asset's availability coincides with high energy prices, the higher its value factor. An asset with an entirely even availability profile by definition has a value factor of one. Value factors above one denote that a DR scheme's availability generally coincides with above-average electricity prices while a value factor below one indicates prevailing availability at times when electricity prices are low. Note that value factors only measure the value of the normalised availability profile. The value factor is unaffected by a DR scheme's total availability hours. These are instead captured by V2G's availability factor (a_f^{V2G}) or the average shiftable power consumption of unidirectional assets (P_{1d}^{avg}) which, in both cases, determine the required number of assets. For unidirectional DR assets the availability profile is given by the uncontrolled load profile of the DR asset as this is the consumption that can be moved by DR. Smart charging has the highest value factor, because uncontrolled domestic charging mostly takes place in the evening hours, coinciding with high demand. Moving domestic EV demand is valuable because it would otherwise occur at times with high energy prices. Heat pump schemes with and without storage have the same value factor because in both schemes the uncontrolled demand comes from heat pumps that have the same heating demand profiles in an uncontrolled scenario. Heating demand occurs primarily in the expensive morning and evening hours ($VF > 1$) but is generally spread more evenly than smart charging demand, leading to a slightly lower value factor. V2G is the only scheme where the value factor is not determined by the load profiles of uncontrolled demand but by discharge availability instead. Since the used dataset consists mostly of domestic chargers, EVs tend to plug in overnight, covering both the high-demand evening hours as well as low-demand nighttime. This explains their value factor close to unity, meaning their profile value does not vary much from a continuously available asset. Note how there are different V2G-value factors for available energy and power because, differently from other DR schemes, power and energy profiles can diverge for V2G. The power VF is applied when the number of chargers determines the required V2G chargers while the energy VF is applied when the available battery capacity sets the number of contracted V2G chargers, as determined by Equation (2)).

	V2G	Smart Charging	Heat Pump	HP & Thermal Storage
Value factor	0.98 (Energy) 0.99(Power)	1.12	1.05	1.05

Table 5: Value factors for the different technologies

Figure 5 shows daily profiles for the parameters that were used to estimate the different value factors. Comparing the price profile with a parameter’s profile gives an idea of how the value factor is estimated. However, it should be noted that seasonal fluctuations in price can naturally also affect the value factor but cannot be inferred from Figure 5.

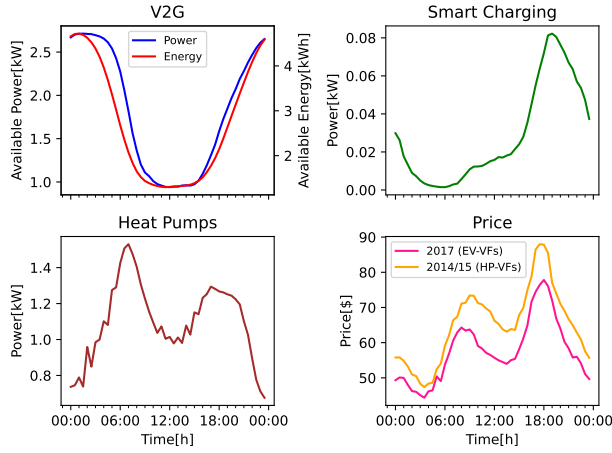

Figure 5: Average daily profiles of value factor parameters

5.2. Levelised cost

Figure 6 and Figure 7 show the LCODR in energy terms adjusted for their respective value factor ($LCODR_{VF}$) for the twelve different applications. It also contrasts the $LCODR_{VF}$ results with the cost-optimal LCOS from [18]. The LCOS was taken as their predictions for the year 2025 and all included results were adjusted for inflation. DR technologies are included in Figure 6 following their technical suitability which is indicated in Table 1. The results show that heat pumps combined with thermal storage, where feasible, significantly outperform other DR or storage technologies. This underlines a huge potential for cheap flexibility from residential thermal storage. While outside the scope of this study, it should be noted that district heating with large-scale thermal storage may present an even more cost-effective flexibility source and Vilén and Ahlgren [64] suggests that these could even provide seasonal load-shifting. The smart heat pump scheme cannot compete with either storage or any of the other DR technologies. The EV-based schemes are able to contend with the most cost-competitive storage technology for applications with a high total annual discharge ($N_{app,yc}^c \times \Delta t_{DD}$), most prominently energy arbitrage, primary response, and transmission and distribution (T&D) investment deferral. The reason for this is that higher discharge requirements allow the EV-based schemes to leverage their advantage over storage technologies with lower roundtrip efficiencies (e.g. hydrogen).

Figure 8 shows the estimated likelihood of different technologies presenting the cheapest option in terms of energy-based LCODR. It excludes the option of heat pumps with thermal storage as these would otherwise present the cheapest technology across all applications where they can be used. The equivalent results for the power-based LCODR can be found in Appendix A. Figures 6 and 8 show that DLC schemes are often unable to provide more cost-effective flexibility than storage assets. Heat pumps with thermal storage are the only one out of four trialled schemes that achieve consistently lower levelised costs than storage technologies. This insight should encourage energy system stakeholders to pursue flexibility from thermal storage in buildings with electrical heating. EV-based

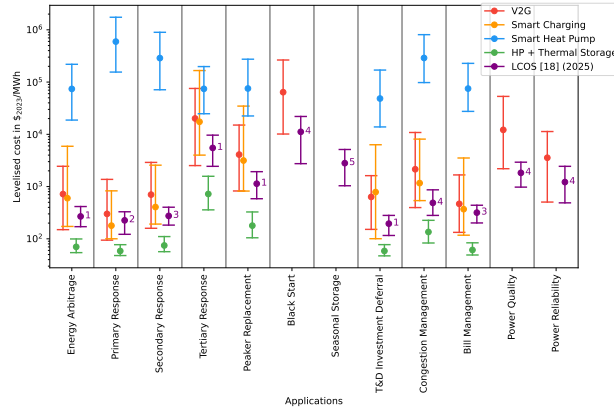

Figure 6: $LCODR_{VF}$ in energy terms from Monte Carlo simulation for the twelve different applications. LCOS results from Schmidt et al. [18] are included for comparison with numbers indicating the cheapest storage technology (1: Pumped hydro, 2: Flywheel, 3: Vanadium-flow, 4: Lithium-ion, 5:Hydrogen, 6: Compressed air)

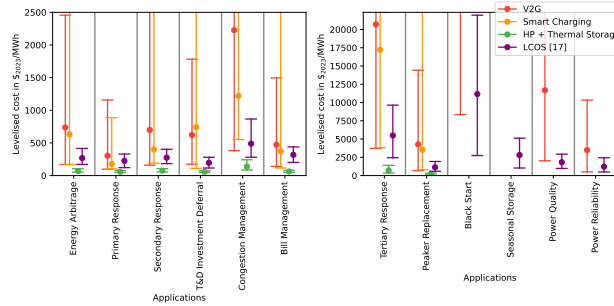

Figure 7: Split-up version of Figure 6 to allow better results identification on linear scale.

DR schemes cannot compete with thermal storage but may still be cost-competitive against storage in certain short-discharge applications. Deployment of EV-based DR schemes should therefore focus on those applications since these are the only ones where they are likely to outcompete storage.

Figure 9 shows the fraction of the LCODR that is associated with each term in the numerator of Equation (1). It shows that reward payments make up a large part of the total cost for all studied schemes highlighting the importance of adequately portraying this cost component in cost assessments of DR. Rebound costs make up a larger part of the thermal storage scheme because of its comparatively low reward payments term.

5.3. Limitations

Three major limitations should be considered when interpreting the results.

1. DR is not storage. The LCODR methodology builds upon the LCOS methodology because DR can provide the same service as storage in many situations. For storage, however, the times of charge and discharge are more independent of each other than for most of the DR applications, where the rebound sometimes has to occur immediately after the end of the discharge period. The proposed methodology does not account for time constraints on the rebound period, and a comprehensive value assessment should also include a value factor for the energy that is used for the rebound. The heat pump schemes, for example, may have a higher value factor because their consumption is higher in winter, but without the ability to move their consumption seasonally, this should arguably not increase their assigned value.
2. V2G also includes a period of Smart Charging. Figure 1 shows that V2G vehicles are charged immediately to then discharge as required. However, this period of immediate charging could also be shifted like in the Smart Charging

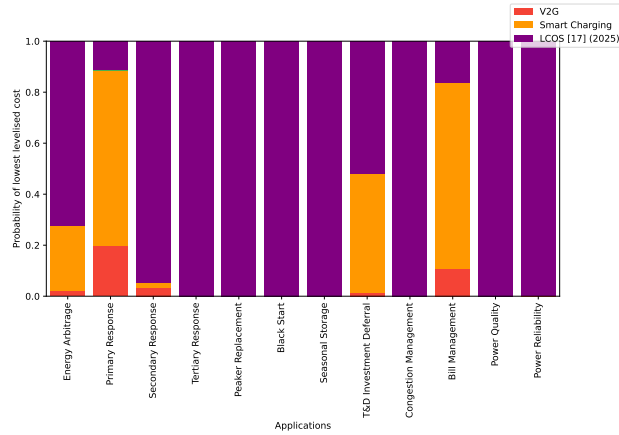

Figure 8: The probabilities of different technologies to achieve the lowest $LCODR_{VF}$ in energy terms for all twelve applications. Results for heat pumps with thermal storage were excluded because these present the cheapest option with a 100% probability for all applications where they are feasible.

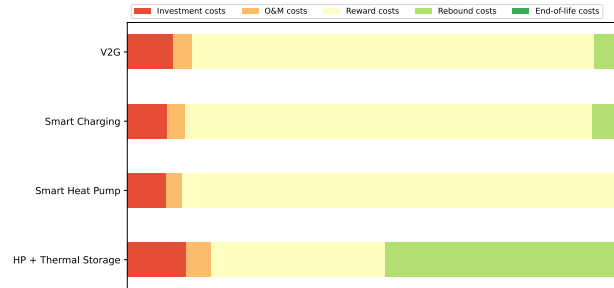

Figure 9: Breakdown of average cost components for different technologies. Note that the share of rebound costs can vary significantly depending on the application and this figure only shows an average of all applications.

schemes, thereby potentially offering further services from V2G and lowering its costs.

- Better data is needed. Several assumptions had to be made due to lacking data, and existing data had to be interpreted outside of its geographic and technical context, as shown in Section 4. To get a measure of how RPT affects discharge duration, for example, it had to be assumed that vehicles plug in once a day and that consumers never plug in for longer than they are contractually obliged to. Rather than measuring the proportion of the day that drivers are plugged in for, future studies should aim to measure the plug-in durations of drivers who have been incentivised financially to plug in their EVs. More granular data may also allow the estimations to move beyond averages and take into account the spectrum of participants in each DR scheme.

6. Conclusion

Assessment of lifetime costs of demand response has received relatively little attention and so this paper addresses the issue by introducing a levelised cost of demand response, $LCODR$. A methodology for estimating the lifetime costs of storage-equivalent DR services is elaborated across twelve applications that may be provided by storage or DR. Data from academic literature and industry is applied to assess the $LCODR$ for four different demand response schemes. The results suggest that residential heat pumps with thermal storage can provide flexibility more cost-effectively than previously studied storage technologies for most applications that can be serviced through demand reduction. Smart charging and, to a lesser extent, vehicle-to-grid can compete with storage technologies in applications that are activated for a comparatively larger proportion of the year, i.e. primary response. Results should be interpreted

with caution because data was collated from various sources with simplifying assumptions required at times. Future work should therefore aim to collect consistent consumer data that is tailored towards a granular LCODR estimation. The proposed methodology and results present a versatile decision-making framework for energy system stakeholders who want to compare the costs of DR and storage.

Appendix A. Results for power-based LCODR

Equation (A.1) displays the estimation of the power-based LCODR. Figure A.11 shows the power-based LCODR results including a comparison with the power-based LCOS of the most competitive storage technology. The power-based LCOS is also referred to as the annuitized capacity cost (ACC) [32]. Figure A.10 shows the probabilities of different DR technologies to achieve the lowest availability profile-adjusted ACC when the thermal storage tank scheme is excluded.

$$LCODR\left[\frac{\$}{kW_{year}}\right] = \frac{Investment + \sum_t \frac{O\&M}{(1+r)^t} + \sum_t \frac{Rewards}{(1+r)^t} + \sum_t \frac{Rebound}{(1+r)^t} + \frac{End-of-life\ costs}{(1+r)^{T+1}}}{\sum_t \frac{E_{app}^{cap}}{(1+r)^t}} \quad (A.1)$$

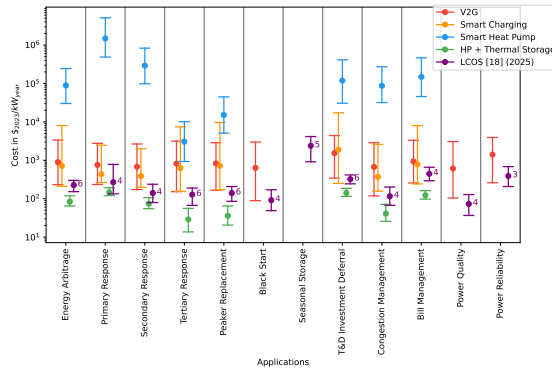

Figure A.10: $LCODR/VF$ in power terms from Monte Carlo simulation for the twelve different applications. LCOS results from Schmidt et al. [18] are included for comparison. Numbers indicate the cheapest storage technology (1: Pumped hydro, 2: Flywheel, 3: Vanadium-flow, 4: Lithium-ion, 5:Hydrogen, 6: Compressed air)

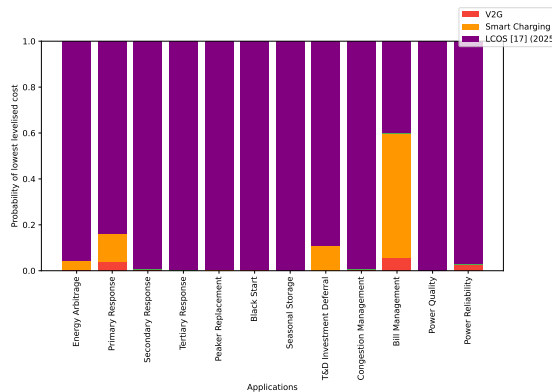

Figure A.11: The probabilities of different technologies to achieve the lowest $LCODR/VF$ in power terms. Excludes the DR scheme that combines heat pumps with thermal storage.

References

- [1] G. Strbac, Demand side management: Benefits and challenges, *Energy Policy* 36 (2008) 4419–4426.
- [2] H. C. Gils, Economic potential for future demand response in Germany—modeling approach and case study, *Applied Energy* 162 (2016) 401–415.
- [3] D. Fischer, H. Madani, On heat pumps in smart grids: A review, *Renewable and Sustainable Energy Reviews* 70 (2017) 342–357.
- [4] A. Faruqui, S. Sergici, Arcturus: international evidence on dynamic pricing, *The Electricity Journal* 26 (2013) 55–65.
- [5] N. O’Connell, P. Pinson, H. Madsen, M. O’Malley, Benefits and challenges of electrical demand response: A critical review, *Renewable and Sustainable Energy Reviews* 39 (2014) 686–699.
- [6] M. Á. Lynch, S. Nolan, M. T. Devine, M. O’Malley, The impacts of demand response participation in capacity markets, *Applied Energy* 250 (2019) 444–451.
- [7] E. Klaassen, R. Van Gerwen, J. Frunt, J. Slootweg, A methodology to assess demand response benefits from a system perspective: A Dutch case study, *Utilities Policy* 44 (2017) 25–37.
- [8] N. Good, K. A. Ellis, P. Mancarella, Review and classification of barriers and enablers of demand response in the smart grid, *Renewable and Sustainable Energy Reviews* 72 (2017) 57–72.
- [9] B. Parrish, R. Gross, P. Heptonstall, On demand: Can demand response live up to expectations in managing electricity systems?, *Energy Research & Social Science* 51 (2019) 107–118.
- [10] N. Baumgartner, F. Kellerer, M. Ruppert, S. Hirsch, S. Mang, W. Fichtner, Does experience matter? Assessing user motivations to accept a vehicle-to-grid charging tariff, *Transportation Research Part D: Transport and Environment* 113 (2022) 103528.
- [11] J. Geng, B. Bai, H. Hao, X. Sun, M. Liu, Z. Liu, F. Zhao, Assessment of vehicle-side costs and profits of providing vehicle-to-grid services, *eTransportation* 19 (2024) 100303.
- [12] J. Geng, H. Hao, X. Hao, X. Sun, M. Liu, H. Dou, Z. Liu, F. Zhao, Techno-economic comparison of vehicle-to-grid and stationary battery energy storage system: Insights for the technology roadmap of electric vehicle batteries, Available at SSRN 4872108 (2024).
- [13] M. M. Rahman, E. Gemechu, A. O. Oni, A. Kumar, The development of a techno-economic model for assessment of cost of energy storage for vehicle-to-grid applications in a cold climate, *Energy* 262 (2023) 125398.
- [14] P. Siano, Demand response and smart grids—a survey, *Renewable and Sustainable Energy Reviews* 30 (2014) 461–478.
- [15] X. Zang, H. Li, S. Wang, Levelized cost quantification of energy flexibility in high-density cities and evaluation of demand-side technologies for providing grid services, *Renewable and Sustainable Energy Reviews* 211 (2025) 115290.
- [16] J. Simpson, E. Loth, K. Dykes, Cost of valued energy for design of renewable energy systems, *Renewable Energy* 153 (2020) 290–300.
- [17] L. Hirth, The market value of variable renewables: The effect of solar wind power variability on their relative price, *Energy Economics* 38 (2013) 218–236.
- [18] O. Schmidt, S. Melchior, A. Hawkes, I. Staffell, Projecting the future levelized cost of electricity storage technologies, *Joule* 3 (2019) 81–100.
- [19] V. Jülch, Comparison of electricity storage options using levelized cost of storage (LCOS) method, *Applied Energy* 183 (2016) 1594–1606.
- [20] M. Zhang, Q. Wu, T. B. H. Rasmussen, X. Yang, J. Wen, Heat pumps in Denmark: Current situation in providing frequency control ancillary services, *CSEE Journal of Power and Energy Systems* 8 (2022) 769–779. URL: <https://www.sciopen.com/article/10.17775/CSEEJPES.2020.06070>. doi:10.17775/CSEEJPES.2020.06070.
- [21] Z. E. Lee, Q. Sun, Z. Ma, J. Wang, J. S. MacDonald, K. Max Zhang, Providing grid services with heat pumps: A review, *Journal of Engineering for Sustainable Buildings and Cities* 1 (2020) 011007.
- [22] B. Huang, A. G. Meijssen, J. A. Annema, Z. Lukszo, Are electric vehicle drivers willing to participate in vehicle-to-grid contracts? a context-dependent stated choice experiment, *Energy Policy* 156 (2021) 112410.
- [23] C.-Y. Lee, J.-W. Jang, M.-K. Lee, Willingness to accept values for vehicle-to-grid service in South Korea, *Transportation Research Part D: Transport and Environment* 87 (2020) 102487.
- [24] Department for Transport, Electric chargepoint analysis 2017: Domestic, <https://www.data.gov.uk/dataset/5438d88d-695b-4381-a5f2-6ea03bf3dcf0/electric-chargepoint-analysis-2017-domestic>, 2018. Accessed: 2023-09-15.
- [25] G. R. Parsons, M. K. Hidrue, W. Kempton, M. P. Gardner, Willingness to pay for vehicle-to-grid (V2G) electric vehicles and their contract terms, *Energy Economics* 42 (2014) 313–324.
- [26] S.-Y. Lim, H.-H. Kim, S.-H. Yoo, Assessment of the potential consumers’ preference for the V2G system, *Journal of Energy Engineering* 25 (2016) 93–102.
- [27] P. Fabianek, R. Madlener, Willing to wait? acceptance for load management at e-vehicle charging stations in germany, in: 2024 20th International Conference on the European Energy Market (EEM), IEEE, 2024, pp. 1–5.
- [28] P. L. Joskow, Comparing the costs of intermittent and dispatchable electricity generating technologies, *American Economic Review* 101 (2011) 238–241.
- [29] F. Ueckerdt, L. Hirth, G. Luderer, O. Edenhofer, System LCOE: What are the costs of variable renewables?, *Energy* 63 (2013) 61–75.
- [30] E. Loth, C. Qin, J. G. Simpson, K. Dykes, Why we must move beyond LCOE for renewable energy design, *Advances in Applied Energy* 8 (2022) 100112.
- [31] J. Thrän, J. Mareček, R. N. Shorten, T. C. Green, Reserve provision from electric vehicles: Aggregate boundaries and stochastic model predictive control, arXiv preprint arXiv:2406.07454 (2024).
- [32] O. Schmidt, I. Staffell, Monetizing energy storage: a toolkit to assess future cost and value, Oxford University Press, 2024.
- [33] J. Kaczmarek, B. Jones, J. Chermak, Determinants of demand response program participation: Contingent valuation evidence from a smart thermostat program, *Energies* 15 (2022) 590.
- [34] Office of Gas and Electricity Markets (Ofgem), Smart meter transition and the data communications company (DCC), <https://www.ofgem.gov.uk/energy-policy-and-regulation/policy-and-regulatory-programmes/smart-meter-transition-and-data-communications-company-dcc>, 2024. Accessed: 2024-09-18.
- [35] C. Heilmann, D. Wozabal, How much smart charging is smart?, *Applied Energy* 291 (2021) 116813.

- [36] D. Schäuble, A. Marian, L. Cremonese, Conditions for a cost-effective application of smart thermostat systems in residential buildings, *Applied Energy* 262 (2020) 114526.
- [37] A. Odukamaiya, J. Woods, N. James, S. Kaur, K. R. Gluesenkamp, N. Kumar, S. Mumme, R. Jackson, R. Prasher, Addressing energy storage needs at lower cost via on-site thermal energy storage in buildings, *Energy & Environmental Science* 14 (2021) 5315–5329.
- [38] P. A. Samuelson, Consumption theory in terms of revealed preference, *Economica* 15 (1948) 243–253.
- [39] L. J. Mangham, K. Hanson, B. McPake, How to do (or not to do)... designing a discrete choice experiment for application in a low-income country, *Health policy and planning* 24 (2009) 151–158.
- [40] J. Bailey, J. Axsen, Anticipating PEV buyers' acceptance of utility controlled charging, *Transportation Research Part A: Policy and Practice* 82 (2015) 29–46.
- [41] J. Geske, D. Schumann, Willing to participate in vehicle-to-grid (V2G)? why not!, *Energy Policy* 120 (2018) 392–401.
- [42] S. Yilmaz, X. Xu, D. Cabrera, C. Chanez, P. Cuony, M. K. Patel, Analysis of demand-side response preferences regarding electricity tariffs and direct load control: Key findings from a swiss survey, *Energy* 212 (2020) 118712.
- [43] A. Ensslen, P. Ringler, L. Dörr, P. Jochem, F. Zimmermann, W. Fichtner, Incentivizing smart charging: Modeling charging tariffs for electric vehicles in German and French electricity markets, *Energy Research & Social Science* 42 (2018) 112–126.
- [44] Octopus Energy UK, How EV tariffs work for electric cars, <https://octopusev.com/ev-hub/guide-to-energy-tariffs-for-electric-cars>, 2023. Accessed: 2024-09-05.
- [45] OVO Energy, Charge anytime - the uk's cheapest home EV charging, <https://www.ovoenery.com/electric-cars/charge-anytime>, 2023. Accessed: 2024-09-05.
- [46] EdF Energy, EV tariffs - designed specifically for EV drivers, <https://www.edfenergy.com/electric-cars/ev-tariffs>, 2024. Accessed: 2024-09-05.
- [47] Octopus Energy UK, Octopus power pack: the UK's first vehicle-to-grid tariff, <https://octopus.energy/power-pack/>, 2024. Accessed: 2024-09-05.
- [48] Office of Gas and Electricity Markets (ofgem), Energy price cap, <https://www.ofgem.gov.uk/energy-price-cap>, 2025. Accessed: 2025-01-22.
- [49] Ministry of Housing, Communities and Local Government, Size of English homes - English housing survey 2018-19, https://assets.publishing.service.gov.uk/media/5f047a01d3bf7f2be8350262/Size_of_English_Homes_Fact_Sheet_EHS_2018.pdf, 2019. Accessed: 2024-09-04.
- [50] Office for National Statistics, Private rent and house prices, uk: August 2024, <https://www.ons.gov.uk/economy/inflationandpriceindices/bulletins/privaterentandhousepricesuk/august2024>, 2024. Accessed: 2024-09-04.
- [51] D. Huber, Q. De Clerck, C. De Cauwer, N. Sapountzoglou, T. Coosemans, M. Messagie, Vehicle to grid impacts on the total cost of ownership for electric vehicle drivers, *World Electric Vehicle Journal* 12 (2021) 236.
- [52] H. Zhang, Z. Hu, Z. Xu, Y. Song, Evaluation of achievable vehicle-to-grid capacity using aggregate pev model, *IEEE Transactions on Power Systems* 32 (2016) 784–794.
- [53] Department for Transport, Vehicle licensing statistics data tables, <https://www.gov.uk/government/statistical-data-sets/vehicle-licensing-statistics-data-tables#ultra-low-emission-vehicles>, 2024. Accessed: 2025-01-14.
- [54] UK Electric Vehicle Supply Equipment Association, Western Power Distribution, A guide on electric vehicle charging and dno engagement for local authorities, <https://www.nationalgrid.co.uk/downloads/29134>, 2022. Accessed: 2025-01-24.
- [55] Department for Transport, Vehicle mileage and occupancy, <https://www.gov.uk/government/statistical-data-sets/nts09-vehicle-mileage-and-occupancy#car-mileage>, 2013. Accessed: 2024-09-20.
- [56] E. Database, Energy consumption of electric vehicles, <https://ev-database.org/uk/cheatsheet/energy-consumption-electric-car>, 2024. Accessed: 2024-09-20.
- [57] BritainThinks, Department for Transport, Electric vehicle charging research: Survey with electric vehicle drivers, <https://assets.publishing.service.gov.uk/media/628f5603d3bf7f037097bd73/dft-ev-driver-survey-summary-report.pdf>, 2022. Accessed: 2025-01-14.
- [58] R. Lowe, Renewable heat premium payment scheme: Heat pump monitoring: Cleaned data, 2013-2015, <http://doi.org/10.5255/UKDA-SN-8151-1>, 2016. doi:10.5255/UKDA-SN-8151-1.
- [59] M. J. O. Panão, N. M. Mateus, G. C. Da Graça, Measured and modeled performance of internal mass as a thermal energy battery for energy flexible residential buildings, *Applied Energy* 239 (2019) 252–267.
- [60] P. Armstrong, D. Ager, I. Thompson, M. McCulloch, Improving the energy storage capability of hot water tanks through wall material specification, *Energy* 78 (2014) 128–140. URL: <https://www.sciencedirect.com/science/article/pii/S0360544214011189>. doi:<https://doi.org/10.1016/j.energy.2014.09.061>.
- [61] Department for Communities and Local Government, Technical housing standards – nationally described space standard, https://assets.publishing.service.gov.uk/government/uploads/system/uploads/attachment_data/file/1012976/160519_Nationally_Described_Space_Standard.pdf, 2015. Accessed: 2025-01-16.
- [62] C. Luerssen, H. Verbois, O. Gandhi, T. Reindl, C. Sekhar, D. Cheong, Global sensitivity and uncertainty analysis of the levelised cost of storage (LCOS) for solar-PV-powered cooling, *Applied Energy* 286 (2021) 116533.
- [63] Elexon, Balancing mechanism reporting service (BMRS): Market index data, <https://www.bmreports.com/bmrs/?q=balancing/marketindex/historic>, 2023. Accessed: 2023-09-15.
- [64] K. Vilén, E. O. Ahlgren, Seasonal large-scale thermal energy storage in an evolving district heating system—long-term modeling of interconnected supply and demand, *Smart Energy* 15 (2024) 100156.