

# FedP<sup>2</sup>EFT: Federated Learning to Personalize Parameter Efficient Fine-Tuning for Multilingual LLMs

Royson Lee<sup>1</sup> Minyoung Kim<sup>1</sup> Fady Rezk<sup>2</sup> Rui Li<sup>1</sup> Stylianos I. Venieris<sup>1</sup> Timothy Hospedales<sup>1,2</sup>

## Abstract

Federated learning (FL) has enabled the training of multilingual large language models (LLMs) on diverse and decentralized multilingual data, especially on low-resource languages. To improve client-specific performance, personalization via the use of parameter-efficient fine-tuning (PEFT) modules such as LoRA is common. This involves a *personalization strategy* (PS), such as the design of the PEFT adapter structures (e.g., in which layers to add LoRAs and what ranks) and choice of hyperparameters (e.g., learning rates) for fine-tuning. Instead of manual PS configuration, we propose FedP<sup>2</sup>EFT, a federated *learning-to-personalize* method for multilingual LLMs in cross-device FL settings. Unlike most existing PEFT structure selection methods, which are prone to overfitting low-data regimes, FedP<sup>2</sup>EFT collaboratively learns the optimal personalized PEFT structure for each client via Bayesian sparse rank selection. Evaluations on both simulated and real-world multilingual FL benchmarks demonstrate that FedP<sup>2</sup>EFT largely outperforms existing personalized fine-tuning methods, while complementing a range of existing FL methods.

## 1. Introduction

Federated learning (FL) makes it possible to train multilingual large language models (LLMs) across different geographical regions, protecting linguistic diversity for low-resource languages (Zhao et al., 2024) while being compliant with privacy regulations (Lim et al., 2020), e.g., General Data Protection Regulation (GDPR). Despite the impressive capabilities demonstrated by these models across various languages, their performance can vary significantly depending on the specific language (Rust et al., 2021) and the data quantity (Adelani et al., 2021) on each client.

<sup>1</sup>Samsung AI Center, Cambridge, UK <sup>2</sup>University of Edinburgh, UK. Correspondence to: Royson Lee <royson.lee@samsung.com>.

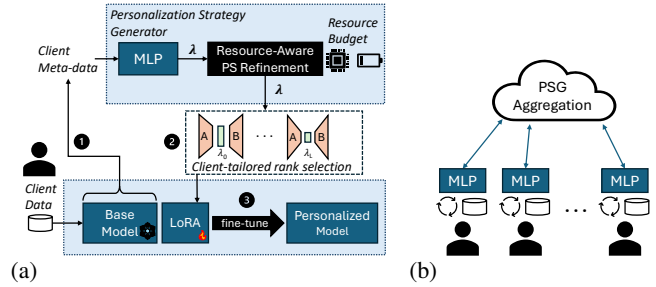

Figure 1. (a) FedP<sup>2</sup>EFT’s inference stage on a single client. ① Given the *base model* and the client’s train dataset, features are extracted and passed into our PS generator (PSG) to generate a PS,  $\lambda$ , suited to the client’s resource budget. ②  $\lambda$  is then used to initialize all LoRA modules before ③ the *base model* is personalized. The resulting personalized model is then used to evaluate on the client’s test samples. (b) We train PSG using standard FL approaches.

Moreover, the majority of existing FL-based multilingual LLM approaches have thus far focused on training a single global model (Iacob et al., 2025; Weller et al., 2022; Ye et al., 2024), limiting their performance on specific languages. Concretely, scaling a single model to different languages is challenged by issues such as the *Curse of Multilinguality* (Conneau et al., 2020), where adding more languages often leads to diminishing returns, and *Negative Interference* (Wang et al., 2020b), where diverse languages compete for limited model capacity. From a personalized FL perspective, learning a global model often increases the initial performance at the expense of personalized performance, e.g., fine-tuning from the global model (Jiang et al., 2019).

Naturally, personalized FL approaches can help bridge the gap and improve language personalization. However, existing techniques are either too costly to be applied to LLMs, e.g., the use of meta-learning (Chen et al., 2018) and hypernetworks (Shamsian et al., 2021), or rely on suboptimal hand-crafted personalization strategies, e.g., manual choice of personalized and language-specific layers (Iacob et al., 2025; Zhao et al., 2024; Wu et al., 2024; Qi et al., 2024), parameter-efficient fine-tuning (PEFT) adapter structures (Yang et al., 2024a;b), or clustering based on class labels and/or language commonality (Mansour et al., 2020;

Sattler et al., 2020; Ye et al., 2024).

Intuitively, optimizing personalization in personalized FL often necessitates dataset- and task-specific methods. The optimal level of personalization varies significantly depending on the characteristics of the data and the specific FL scenario (Chen et al., 2022; Ye et al., 2024). For instance, an English-pretrained LLM may require stronger personalization, *e.g.*, higher learning rates, when fine-tuning on German than on English. The optimal personalization strategy (PS) is thus contingent upon the specific task, the client, and the given *base model* (Lee et al., 2023).

In this paper, we address the issues above by learning to personalize PEFT for each client. To this end, we propose FedP<sup>2</sup>EFT, a method that enables clients to collaboratively learn language personalization strategies using FL. Specifically, we federatedly train a PS generator (PSG), as depicted in Fig. 1(b), which allows all participating clients to collaboratively learn the optimal mapping between local meta-data to optimal LoRA (Hu et al., 2022) ranks. Fig. 1(a) illustrates the personalization process of FedP<sup>2</sup>EFT on a single client during inference, where per-layer LoRA ranks are generated depending on the initial *base model*, the client’s dataset, and their resource budget. These personalized LoRA modules are then used to apply PEFT on the *base model* and yield the personalized model.

As FedP<sup>2</sup>EFT focuses on improving the PEFT process per-dataset/task/client, it is directly pluggable to any starting *base model*, which may or may not be federatedly trained. This includes off-the-shelf pretrained models, FL approaches that learn a single global model (McMahan et al., 2017; Oh et al., 2022; Karimireddy et al., 2020; Acar et al., 2021), and even personalized FL approaches that deploy personalized layers, *e.g.*, monolingual tokenizer and embeddings (Iacob et al., 2025), personalized LoRA adapters (Qi et al., 2024; Wu et al., 2024; Yang et al., 2024b), and language embeddings (Silva et al., 2023). Through our experiments (Section 4), we show that our method 1) largely outperforms both existing non-FL LoRA rank selection and FL-based learning-to-personalize techniques, and 2) complements well with a range of existing FL approaches.

## 2. Related Work

**Multilingual LLMs (MLLMs).** Existing efforts in multilingual LLMs often underperform on low-resource languages due to 1) data scarcity (Xu et al., 2024b), 2) the model’s limited capacity to learn the intricacies of multiple languages (Conneau et al., 2020), and 3) negative transfer learning among languages (Wang et al., 2020b). Common ways to counteract these challenges include the use of separate vocabulary and embeddings (Artetxe et al., 2020), hand-crafted adapters (Pfeiffer et al., 2020), automatic data

annotation (Dubey et al., 2024), clustering and merging languages with similar representations (Chung et al., 2020), among other contributions (Wang et al., 2020a; Conneau et al., 2019). Our work is orthogonal to these approaches and builds upon recent FL-based MLLMs (Zhao et al., 2024; Iacob et al., 2025; Ye et al., 2024), which utilize FL to tap into previously inaccessible low-resource data sources.

**Personalized Federated Learning.** To obtain personalized client-specific models, various approaches have been proposed, including the use of personalized layers (Arivazhagan et al., 2019), meta-learning (Chen et al., 2018), model mixtures (Marfoq et al., 2021), hypernetworks (Shamsian et al., 2021), transfer learning between global and local models (Shen et al., 2020), among other contributions (Deng et al., 2020). Some of these techniques have also been adopted for LLMs, *e.g.*, personalized LoRAs (Yang et al., 2024b), hypernetworks for client embeddings (Silva et al., 2023), and mixtures of LoRA experts (Zhang et al., 2024b). Our work complements these approaches as personalized models can benefit from further fine-tuning as shown in Section 4.2.1.

**Federated Hyperparameter Optimization (HPO).** Most federated approaches to HPO do not utilize the client dataset for personalized hyperparameters. Instead, they employ a single set of hyperparameters across all clients based on the local validation loss evaluated before FL (Zhou et al., 2023; Holly et al., 2022) or sample from federatedly learnt hyperparameter categorical distributions for each client (Khodak et al., 2021). An exception to this is FedL2P (Lee et al., 2023) which utilizes a PSG for personalized per-layer learning rates and batch normalization hyperparameters. We compare with FedL2P in our experiments.

**PEFT Structure Learning.** Contrary to the conventional approach of distributing uniform adapter modules across all layers, a recent line of work allows different LoRA ranks to be used across a model’s weight matrices. Using fine-grained per-layer rank selection, existing methods include SVD-based LoRA reformulation followed by importance-based rank assignment (Zhang et al., 2023), trainable ranking units (Ding et al., 2023), selectively employing parallel weight modules (Song et al., 2024), meta-learning-based (Zhang et al., 2024a) and black-box optimization techniques (Tribes et al., 2024), specialized training recipes for multi-rank LoRA modules that allow flexible extraction of a range of ranks (Valipour et al., 2023), and coarse-grained dropping of LoRA-enhanced layers (Yao et al., 2024). While these methods can be effective in centralized setups, they typically require an excessive number of optimization steps, which is prone to overfitting in FL settings, where clients have limited amount of data.

### 3. Our Approach

#### 3.1. Preliminaries & Motivation

In personalized FL, the goal is to minimize each client’s local objective  $\mathbb{E}_{(x,y) \sim P^i} \mathcal{L}^i(\Phi^i; x, y)$  where  $P^i$  represents the data distribution of the  $i$ -th client,  $x$  and  $y$  are the input data and labels, respectively, and  $\mathcal{L}^i(\Phi^i; x, y)$  is the loss function for client  $i$  given model parameters  $\Phi^i$ . This is typically achieved via fine-tuning (Matsuda et al., 2022; Chen et al., 2022) a *base model*, with parameters  $\Phi_{BM}^i$  and a set of hyperparameters, e.g. learning rate. Note that  $\Phi_{BM}^i$  may differ across clients if it is already personalized, e.g. if  $\Phi_{BM}^i$  is obtained using a personalized FL algorithm.

Fine-tuning LLMs, however, is unprecedentedly compute and memory intensive, and prone to overfitting. As such, the majority of existing federated LLM works (Zhao et al., 2024; Sun et al., 2024) rely on PEFT methods, with LoRA (Hu et al., 2022) being a prevalent choice due to its efficiency and performance. Specifically, for a frozen weight matrix  $W \in \mathbb{R}^{d \times e}$ , LoRA introduces low-rank matrices  $B \in \mathbb{R}^{d \times r}$  and  $A \in \mathbb{R}^{r \times e}$  where  $r \ll \min(d, e)$ . The adapted weights are then expressed as:  $W' = W + \frac{\alpha_{\text{LoRA}}}{r} BA$  where  $\alpha_{\text{LoRA}}$  is a hyperparameter and only  $B$  and  $A$  are trained during fine-tuning. Although effective, these FL works rely on a fixed hand-crafted PS, e.g., a manually defined LoRA rank on hand-picked layers, for all clients, leading to suboptimal personalized models.

#### 3.2. Personalized PEFT

We, instead, propose using a different PS for each client. Common hyperparameter choices from previous federated HPO approaches (Section 2) include learning rates and batch normalization (BN) hyperparameters. While these hyperparameters have been shown to be effective for handling data heterogeneity in popular vision and speech benchmarks (Li et al., 2021; 2016; Arivazhagan et al., 2019), they are less consequential or not applicable when fine-tuning LLMs. This stems from the fact that LLMs are often fine-tuned using adaptive optimizers, e.g. Adam, which are more robust to the learning rate (Zhao et al., 2025), and BN layers are not typically used. A more critical hyperparameter choice shown to be effective, especially for cross-lingual transfer learning (Pfeiffer et al., 2020), is the PEFT adapter structure; specifically which layers to introduce LoRAs in and what ranks to utilize (Zhang et al., 2023; 2024a).

**Adapting BayesTune for LoRA Rank Selection.** Building upon BayesTune (Kim & Hospedales, 2023), a Bayesian sparse model selection approach, we formulate PEFT personalization as a sparse LoRA rank selection problem and propose BayesTune-LoRA. Concretely, we introduce rank-wise latent variables  $\lambda \in \mathbb{R}^r$ ,  $\lambda_i > 0$ ,  $\forall i = 1, 2, \dots, r$  for each LoRA matrix:  $B\lambda A$ . Let  $\boldsymbol{\lambda} = \{\lambda_{l,\cdot}\}_{l=1}^L$  be the

set of all  $\boldsymbol{\lambda}$  where  $\lambda_{l,\cdot}$  represents the rank-wise scales for layer  $l$  in a model with  $L$  LoRA modules (similarly for  $\mathbf{A}$  and  $\mathbf{B}$ ). Using BayesTune, the values for  $\theta = (\boldsymbol{\lambda}, \mathbf{A}, \mathbf{B})$  are optimized as:

$$\theta^* = \arg \min_{\theta} \mathcal{L}_{\text{CE}}(\theta; D) + \frac{\alpha_s}{N} \mathcal{L}_s(\boldsymbol{\lambda}, \mathbf{B}) + \frac{\alpha_p}{N} \mathcal{L}_p(\boldsymbol{\lambda}) \quad (1)$$

where  $D = \{(x_i, y_i)\}_{i=1}^N$  is the train dataset,  $N$  the size of  $D$ ,  $\mathcal{L}_{\text{CE}}(\theta; D)$  the cross-entropy loss,  $\alpha_p$  and  $\alpha_s$  hyperparameters,  $\mathcal{L}_s$  the logarithm of the Laplace distribution (prior imposed on  $p(B|\lambda)$ <sup>1</sup>),  $f(\|B_{l,i}\|_1; \mu, b) = \frac{1}{2b} \exp\left(-\frac{\|B_{l,i}\|_1 - \mu|}{b}\right)$  with  $\mu = 0$  ( $B$  is initialized to 0 in LoRA) and  $b = \lambda_{l,i}$ :

$$\mathcal{L}_s(\boldsymbol{\lambda}, \mathbf{B}) = \sum_l \sum_i^r \left( \log \lambda_{l,i} + \frac{\|B_{l,i}\|_1}{\lambda_{l,i}} + \log 2 \right) \quad (2)$$

and  $\mathcal{L}_p$  is the logarithm of the Gamma distribution (hyper-prior imposed on  $\lambda$ ),  $\mathcal{G}(\lambda_{l,i}; \alpha_g, \beta_g) = \frac{\beta_g^{\alpha_g}}{\Gamma(\alpha_g)} \lambda_{l,i}^{\alpha_g-1} e^{-\beta_g \lambda_{l,i}}$  where  $\alpha_g = 0.01$ ,  $\beta_g = 100$  following the hyperparameters set by the original authors:

$$\mathcal{L}_p(\boldsymbol{\lambda}) = \sum_l \sum_i^r (0.99 \cdot \log \lambda_{l,i} + 100 \cdot \lambda_{l,i} - 0.01 \log(100) + \log \Gamma(0.01)) \quad (3)$$

In practice, we can save computations by removing all constants and the duplicate term  $\log \lambda$ , resulting in the following approximated penalty losses:

$$\mathcal{L}_s(\boldsymbol{\lambda}, \mathbf{B}) = \sum_l \sum_i^r \frac{\|B_{l,i}\|_1}{\lambda_{l,i}} \quad (4)$$

$$\mathcal{L}_p(\boldsymbol{\lambda}) = \sum_l \sum_i^r (\log \lambda_{l,i} + 100 \cdot \lambda_{l,i}) \quad (5)$$

Roughly speaking,  $\mathcal{L}_p$  encourages small  $\lambda$  while  $\mathcal{L}_s$  encourages larger  $\lambda$  for larger LoRA  $B$  (per column) updates. Hence, minimizing the losses in Eq. (1) encourages larger  $\lambda$  in more significant ranks.

**Personalizing PEFT with BayesTune-LoRA.** For each client, we attach BayesTune-LoRA modules,  $\theta$ , to all linear layers of its *base model* with rank  $r_{\text{init}} = \alpha_{r\_mul} \cdot r_{\text{max target}}$  where  $r_{\text{max target}}$  is the maximum inference resource budget and  $r_{\text{init}}$  is the initial rank before pruning.  $\theta$  is then optimized using Adam (Kingma & Ba, 2015) as per Eq. (1).<sup>2</sup>

After training, we freeze the resulting  $\boldsymbol{\lambda}$  and use it for per-

<sup>1</sup>Unlike BayesTune, where every parameter is associated with its own prior scale, we use an “independent” Laplace prior where each  $\lambda_{l,i}$  applies to all entries of  $B_{l,i}$

<sup>2</sup>BayesTune proposed using SGLD (Welling & Teh, 2011), adding Gaussian noise to the gradient updates and sampling from the posterior distribution. Due to the challenges of estimating the full posterior distribution in FL settings, particularly with limited client data, we opt to find a point estimate.

sonalization. Specifically, given a resource budget (total rank budget) of  $r \cdot L$ , we prune  $\lambda$  by taking the top- $(r \cdot L)$  largest ranks, along with the corresponding rows of  $A$  and columns of  $B$ .<sup>3</sup> We then reinitialize the pruned  $A$  and  $B$  and perform standard fine-tuning on  $\mathcal{L}_{CE}$  with the frozen pruned  $\lambda$  to obtain the personalized model. Note that we only have to train  $\lambda$  once for all ranks  $\leq r_{\max \text{ target}}$ .

### 3.3. FedP<sup>2</sup>EFT: FL to Personalize PEFT

The limited data available to each client in FL makes it difficult to train an effective PS in isolation, frequently resulting in overfitting. Following FedL2P (Lee et al., 2023), we mitigate this by federatedly learning a common PSG that generates client-wise PS. Concretely, we use a small, one hidden layer multilayer perceptron (MLP) with parameters  $\phi$  that takes as input the client meta-data and outputs an estimated PS as follows:

$$\hat{\lambda} = \text{MLP}(\phi; E(h_0), SD(h_0), E(h_1), SD(h_1), \dots, E(h_{L-1}), SD(h_{L-1})) \quad (6)$$

where  $h_{l-1}$  is the input feature to the  $l$ -th layer in the *base model*, and  $E(\cdot)$  and  $SD(\cdot)$  are the mean and standard deviation (SD), respectively.

In contrast to FedL2P, which adopts a computationally demanding meta-learning approach to train MLP, we take a two-stage strategy for each client: 1) first, learn  $\lambda$ , followed by 2) regression learning of MLP to target the learned  $\lambda$ .

**Federated Training of FedP<sup>2</sup>EFT.** Fig. 2 shows the entire FedP<sup>2</sup>EFT algorithm during federated training. For each federated round, each sampled participating client  $i$  receives  $\phi$  from the server and loads them into its MLP. They then ① perform a forward pass of the local train dataset on their *base model* and a forward pass of the MLP with the resulting features as per Eq. (6). ② The estimated  $\hat{\lambda}^i$  is plugged into our proposed BayesTune-LoRA (Section 3.2) and ③ fine-tuning is performed as per Eq. (1) for  $s$  steps (Stage 1). ④ The resulting  $\hat{\lambda}^{i,s}$  is used as an approximated ground-truth for regression learning of MLP to target the learned  $\hat{\lambda}^{i,s}$ , where  $\mathcal{L}_1$  is the L1 loss (Stage 2). Finally, ⑤  $\phi$  is sent back to the server for aggregation. As there is no single aggregation method that outperforms all others in every situation (Matsuda et al., 2022; Chen et al., 2022; Ye et al., 2024), we utilize FedAvg (McMahan et al., 2017). The aggregated  $\phi$  is then sent to clients for the next round.

At the end of federated training, the learned  $\phi$  can be deployed to any client, *seen* or *unseen* during federated training. Note that unlike FedL2P, which requires federated training for every target rank, FedP<sup>2</sup>EFT inherits the property of BayesTune-LoRA; federated training is a one-time cost for all ranks  $\leq r_{\max \text{ target}}$ .

<sup>3</sup>The LoRA module is discarded for layers where  $\|\lambda_l\|_1 = 0$

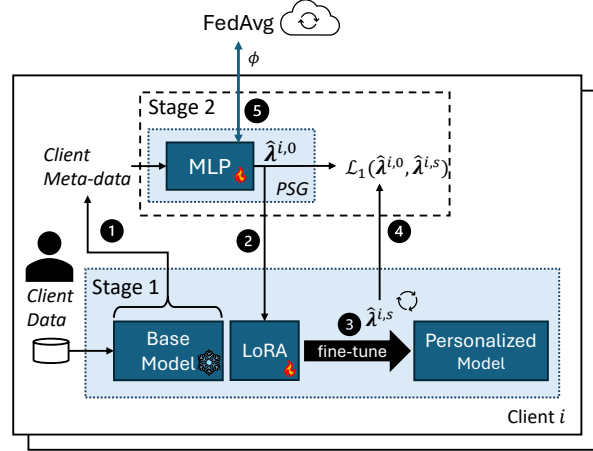

Figure 2. FedP<sup>2</sup>EFT’s federated training of PSG for each federated round (See text in Section. 3.3).

**Inference with FedP<sup>2</sup>EFT.** Fig. 1(a) shows how FedP<sup>2</sup>EFT personalizes PEFT for each client upon deployment. Given the learned MLP and the client’s *base model*, ① the client meta-data are retrieved (Eq. 6) and used to generate the client’s PS,  $\lambda$ . ② Given the client’s resource budget of total rank  $r \cdot L$ , we take the top- $(r \cdot L)$  largest ranks in  $\lambda$ , freeze them, and initialize our proposed BayesTune-LoRA modules for all layers where  $\|\lambda_l\|_1 > 0$ . ③ The personalized LoRA ranks are used for fine-tuning before merging back to the *base model* to obtain the final personalized model.

## 4. Evaluation

### 4.1. Experimental Setup

We conduct experiments on multilingual scenarios, where clients with diverse high- and low-resource languages can collaboratively learn how to personalize a given base model to better cater to their language preferences. In all experiments, we divide clients in two pools, *seen* and *unseen*, where only the clients in the *seen* pool actively participate in federated training. We set the maximum number of communication rounds for training the PSG to 150, randomly sampling 10% of participating clients every round. We use Adam (Kingma & Ba, 2015) as the default optimizer for all our experiments. We evaluate on resource budgets  $r = 2, 4, 8, 16$  where the total rank budget is  $r \cdot L$ . We summarize the FL scenarios that we consider in our experiments, leaving comprehensive details in Appendix A.

#### 4.1.1. TASKS, MODELS, AND DATASETS

**Text Classification.** We adopt the pretrained multilingual BERT (Devlin et al., 2018) (mBERT) for all text classification experiments. For datasets, we introduce additional data heterogeneity to the simulated FL setups, XNLI (Conneau et al., 2018) and MasakhaNEWS (Adelani et al., 2023), proposed in PE\_FL (Zhao et al., 2024).

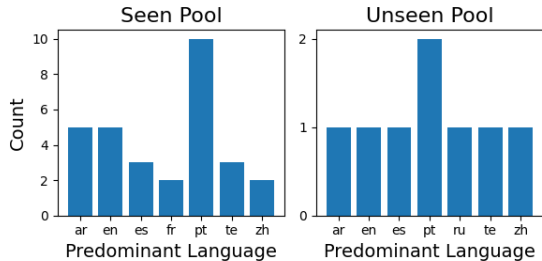

Figure 3. The number of clients in each predominant language in our Fed-Aya setup.

For our XNLI setup, we sample 2k instances for train and 500 for test in each pool. In contrast to PE\_FL, which had 15 clients (1 language per client), we divide the data equally among 20 clients for each language. We then adopt the latent Dirichlet allocation (LDA) partition method (Hsu et al., 2019; Yurochkin et al., 2019),  $y \sim Dir(\alpha)$ , to simulate non-IID label shifts among these clients, with  $\alpha = 0.5$ . Hence, there is a total of 600 clients (15 languages  $\cdot$  20 clients per language  $\cdot$  2 pools), consisting of both label and feature heterogeneity.

For MasakhaNEWS, we first split the data in each of the 16 languages by half for each pool. Similar to our XNLI setup, we divide each language’s data equally among 10 clients and adopt LDA with  $\alpha = 0.5$ , resulting in 320 clients in total. Differing from our XNLI setup, each language varies in the amount of samples, adding another layer of data heterogeneity to the setup: quantity skew.

**Instruction-Tuning Generation.** We adopt pretrained MobileLLaMA-1.4B (Chu et al., 2023) and Llama-3.2-3B (Dubey et al., 2024), which are representative of commonly supported model sizes on recent high-end edge devices (Mehta et al., 2024; Tan et al., 2024; Xu et al., 2024a). For each model, we run experiments on the recent Fed-Aya dataset. Fed-Aya is a real-world FL dataset naturally partitioned by annotator ID and each client has data with up to 4 languages. Out of a total of 38 clients, we select 8 clients for our *unseen* pool. We also split each client’s data 80%/20% for train and test, respectively. Fig. 3 shows the distribution of predominant languages, where predominant refers to the client’s most commonly used language, in our setup.

#### 4.1.2. COMPLEMENTARY APPROACHES

We show FedP<sup>2</sup>EFT’s compatibility with both off-the-shelf models and models trained using existing FL methods. Concretely, given a pretrained model, we obtain a *base model* using one of the following approaches:

**Standard FL.** We further train the pretrained model federatedly on the *seen* pool, either using existing PEFT methods or full fine-tuning (Ye et al., 2024; Sun et al., 2024),

**Personalized FL.** We adopt two recent personalized FL works: *i*) FedDPA-T (Yang et al., 2024b), which learns

per-client personalized LoRA modules in addition to global LoRA modules, and *ii*) DEPT (SPEC) (Jacob et al., 2025), which learns per-client personalized token and positional embeddings while keeping the rest of the model shared. The *base model* hence differs for each client.

**Off-the-shelf.** We use the pretrained model as the *base model* without additional training.

#### 4.1.3. BASELINES

Given a *base model*, we compare FedP<sup>2</sup>EFT with existing fine-tuning and *learning to personalize* approaches.

**LoRA PEFT.** We deploy LoRA (Hu et al., 2022) on all linear layers of the model with a fixed rank  $r$ .

**Non-FL Rank Selection.** We compare with AdaLoRA (Zhang et al., 2023) and our proposed LoRA-variant of BayesTune (Kim & Hospedales, 2023), BayesTune-LoRA (Section 3.2), which optimizes  $\lambda$  separately for each client.

**FL to Personalize.** We compare with FedL2P (Lee et al., 2023) which trains a MLP federatedly to output per-client learning rates for each LoRA module.

For each baseline, we either follow best practices recommended by the corresponding authors or employ a simple grid search and pick the best performing hyperparameters. Full details in Appendix. A.

## 4.2. Results on Text Classification

We evaluate our approach in a typical FL setup, where the pretrained model is first trained using Standard FL with full fine-tuning and the resulting *base model* is then personalized to each client. Tables 1 & 2 show the mean and standard deviation (SD) of the accuracy for each language in our MasakhaNEWS setup for *seen* and *unseen* pool respectively (similarly for XNLI in Appendix Tables 8 & 9). In addition, we also show the number of languages, labelled “Wins”, an approach is best performing for each budget  $r$ .

The results in all four tables show that federated *learning to personalize* methods (FedL2P and FedP<sup>2</sup>EFT) outperform the other baselines in most cases. Non-FL rank selection approaches (AdaLoRA and BayesTune-LoRA), on the other hand, tend to overfit and/or struggle to learn an optimal rank structure given the limited number of samples in each client. Comparing FedL2P and FedP<sup>2</sup>EFT, FedP<sup>2</sup>EFT largely surpass FedL2P with a few exceptions, indicating that learning to personalize LoRA rank structure is the better hyperparameter choice than personalizing learning rates; this finding is also aligned with recent LLM-based optimizer findings (Zhao et al., 2025), which shows that Adam’s performance is robust with respect to its learning rate.









## References

- Acar, D. A. E., Zhao, Y., Matas, R., Mattina, M., Whatmough, P., and Saligrama, V. Federated Learning Based on Dynamic Regularization. In *International Conference on Learning Representations*, 2021.
- Adelani, D. I., Abbott, J., Neubig, G., D’souza, D., Kreutzer, J., Lignos, C., Palen-Michel, C., Buzaaba, H., Rijhwani, S., Ruder, S., et al. MasakhaNER: Named entity recognition for African languages. *Transactions of the Association for Computational Linguistics*, 2021.
- Adelani, D. I., Masiak, M., Azime, I. A., Alabi, J. O., Tonja, A. L., Mwase, C., Ogundepo, O., Dossou, B. F., Oladipo, A., Nixdorf, D., et al. MasakhaNEWS: News Topic Classification for African languages. In *4th Workshop on African Natural Language Processing*, 2023.
- Arivazhagan, M. G., Aggarwal, V., Singh, A. K., and Choudhary, S. Federated Learning with Personalization Layers. *arXiv preprint arXiv:1912.00818*, 2019.
- Artetxe, M., Ruder, S., and Yogatama, D. On the Cross-lingual Transferability of Monolingual Representations. In *Proceedings of the 58th Annual Meeting of the Association for Computational Linguistics*, 2020.
- Banerjee, S. and Lavie, A. METEOR: An automatic metric for MT evaluation with improved correlation with human judgments. In *Proceedings of the ACL Workshop on Intrinsic and Extrinsic Evaluation Measures for Machine Translation and/or Summarization*, 2005.
- Bengio, Y., Léonard, N., and Courville, A. Estimating or Propagating Gradients Through Stochastic Neurons for Conditional Computation. *arXiv preprint arXiv:1308.3432*, 2013.
- Chen, D., Gao, D., Kuang, W., Li, Y., and Ding, B. pFL-Bench: A Comprehensive Benchmark for Personalized Federated Learning. *Advances in Neural Information Processing Systems*, 2022.
- Chen, F., Luo, M., Dong, Z., Li, Z., and He, X. Federated Meta-Learning with Fast Convergence and Efficient Communication. *arXiv preprint arXiv:1802.07876*, 2018.
- Chu, X., Qiao, L., Lin, X., Xu, S., Yang, Y., Hu, Y., Wei, F., Zhang, X., Zhang, B., Wei, X., et al. MobileVLM: A Fast, Strong and Open Vision Language Assistant for Mobile Devices. *arXiv preprint arXiv:2312.16886*, 2023.
- Chung, H. W., Garrette, D., Tan, K. C., and Riesa, J. Improving Multilingual Models with Language-Clustered Vocabularies. In *Proceedings of the 2020 Conference on Empirical Methods in Natural Language Processing*, 2020.
- Conneau, A., Rinott, R., Lample, G., Williams, A., Bowman, S. R., Schwenk, H., and Stoyanov, V. Xnli: Evaluating cross-lingual sentence representations. In *Proceedings of the 2018 Conference on Empirical Methods in Natural Language Processing*, 2018.
- Conneau, A., Khandelwal, K., Goyal, N., Chaudhary, V., Wenzek, G., Guzmán, F., Grave, E., Ott, M., Zettlemoyer, L., and Stoyanov, V. Unsupervised Cross-lingual Representation Learning at Scale. In *Annual Meeting of the Association for Computational Linguistics*, 2019.
- Conneau, A., Khandelwal, K., Goyal, N., Chaudhary, V., Wenzek, G., Guzmán, F., Grave, E., Ott, M., Zettlemoyer, L., and Stoyanov, V. Unsupervised cross-lingual representation learning at scale. In *Proceedings of the 58th Annual Meeting of the Association for Computational Linguistics*, 2020.
- Deng, Y., Kamani, M. M., and Mahdavi, M. Adaptive Personalized Federated Learning. *arXiv preprint arXiv:2003.13461*, 2020.
- Devlin, J., Chang, M.-W., Lee, K., and Toutanova, K. BERT: Pre-training of Deep Bidirectional Transformers for Language Understanding. *arXiv preprint arXiv:1810.04805*, 2018.
- Ding, N., Lv, X., Wang, Q., Chen, Y., Zhou, B., Liu, Z., and Sun, M. Sparse Low-rank Adaptation of Pre-trained Language Models. In *The 2023 Conference on Empirical Methods in Natural Language Processing*, 2023.
- Dubey, A., Jauhri, A., Pandey, A., Kadian, A., Al-Dahle, A., Letman, A., Mathur, A., Schelten, A., Yang, A., Fan, A., et al. The Llama 3 Herd of Models. *arXiv preprint arXiv:2407.21783*, 2024.
- Glorot, X. and Bengio, Y. Understanding the Difficulty of Training Deep Feedforward Neural Networks. In *International Conference on Artificial Intelligence and Statistics*, 2010.
- Holly, S., Hiessl, T., Lakani, S. R., Schall, D., Heitzinger, C., and Kemnitz, J. Evaluation of Hyperparameter-Optimization Approaches in an Industrial Federated Learning System. In *Data Science–Analytics and Applications*, 2022.
- Hsu, T.-M. H., Qi, H., and Brown, M. Measuring the Effects of Non-identical Data Distribution for Federated Visual Classification. *arXiv preprint arXiv:1909.06335*, 2019.
- Hu, E. J., Shen, Y., Wallis, P., Allen-Zhu, Z., Li, Y., Wang, S., Wang, L., and Chen, W. LoRA: Low-Rank Adaptation of Large Language Models. *International Conference on Learning Representations*, 2022.

- Iacob, A., Sani, L., Kurmanji, M., Shen, W. F., Qiu, X., Cai, D., Gao, Y., and Lane, N. D. DEPT: Decoupled Embeddings for Pre-training Language Models. In *International Conference on Learning Representations*, 2025.
- Jiang, Y., Konečný, J., Rush, K., and Kannan, S. Improving Federated Learning Personalization via Model Agnostic Meta Learning. *arXiv preprint arXiv:1909.12488*, 2019.
- Karimireddy, S. P., Kale, S., Mohri, M., Reddi, S., Stich, S., and Suresh, A. T. SCAFFOLD: Stochastic Controlled Averaging for Federated Learning. In *International Conference on Machine Learning*, 2020.
- Khodak, M., Tu, R., Li, T., Li, L., Balcan, M.-F. F., Smith, V., and Talwalkar, A. Federated Hyperparameter Tuning: Challenges, Baselines, and Connections to Weight-Sharing. *Advances in Neural Information Processing Systems*, 2021.
- Kim, M. and Hospedales, T. BayesTune: Bayesian Sparse Deep Model Fine-tuning. *Advances in Neural Information Processing Systems*, 2023.
- Kingma, D. P. and Ba, J. Adam: A Method for Stochastic Optimization. In *International Conference on Learning Representations*, 2015.
- Kudo, T. and Richardson, J. SentencePiece: A simple and language independent subword tokenizer and detokenizer for Neural Text Processing. In *Conference on Empirical Methods in Natural Language Processing*, 2018.
- Lee, R., Kim, M., Li, D., Qiu, X., Hospedales, T., Huszár, F., and Lane, N. FedL2P: Federated Learning to Personalize. *Advances in Neural Information Processing Systems*, 2023.
- Li, X., Jiang, M., Zhang, X., Kamp, M., and Dou, Q. FedBN: Federated Learning on Non-IID Features via Local Batch Normalization. In *International Conference on Learning Representations*, 2021.
- Li, Y., Wang, N., Shi, J., Liu, J., and Hou, X. Revisiting Batch Normalization For Practical Domain Adaptation. *arXiv preprint arXiv:1603.04779*, 2016.
- Lim, W. Y. B., Luong, N. C., Hoang, D. T., Jiao, Y., Liang, Y.-C., Yang, Q., Niyato, D., and Miao, C. Federated Learning in Mobile Edge Networks: A Comprehensive Survey. *IEEE Communications Surveys & Tutorials*, 2020.
- Lin, C.-Y. ROUGE: A package for automatic evaluation of summaries. In *Text Summarization Branches Out*, 2004.
- Mansour, Y., Mohri, M., Ro, J., and Suresh, A. T. Three Approaches for Personalization with Applications to Federated Learning. *arXiv preprint arXiv:2002.10619*, 2020.
- Marfoq, O., Neglia, G., Bellet, A., Kameni, L., and Vidal, R. Federated Multi-Task Learning Under a Mixture of Distributions. *Advances in Neural Information Processing Systems*, 2021.
- Matsuda, K., Sasaki, Y., Xiao, C., and Onizuka, M. An Empirical Study of Personalized Federated Learning. *arXiv preprint arXiv:2206.13190*, 2022.
- McMahan, B., Moore, E., Ramage, D., Hampson, S., and y Arcas, B. A. Communication-Efficient Learning of Deep Networks from Decentralized Data. In *Artificial Intelligence and Statistics*, 2017.
- Mehta, S., Sekhavat, M. H., Cao, Q., Horton, M., Jin, Y., Sun, C., Mirzadeh, S. I., Najibi, M., Belenko, D., Zatloukal, P., and Rastegari, M. OpenELM: An Efficient Language Model Family with Open Training and Inference Framework. In *Workshop on Efficient Systems for Foundation Models II @ ICML2024*, 2024.
- Oh, J., Kim, S., and Yun, S.-Y. FedBABU: Towards Enhanced Representation for Federated Image Classification. In *International Conference on Learning Representations*, 2022.
- Pfeiffer, J., Vulić, I., Gurevych, I., and Ruder, S. MAD-X: An Adapter-Based Framework for Multi-Task Cross-Lingual Transfer. In *Proceedings of the 2020 Conference on Empirical Methods in Natural Language Processing*, 2020.
- Qi, J., Luan, Z., Huang, S., Fung, C., Yang, H., and Qian, D. FDLORA: Personalized Federated Learning of Large Language Model via Dual LoRA Tuning. *arXiv preprint arXiv:2406.07925*, 2024.
- Rust, P., Pfeiffer, J., Vulić, I., Ruder, S., and Gurevych, I. How Good is Your Tokenizer? On the Monolingual Performance of Multilingual Language Models. In *Proceedings of the 59th Annual Meeting of the Association for Computational Linguistics and the 11th International Joint Conference on Natural Language Processing*, 2021.
- Sattler, F., Müller, K.-R., and Samek, W. Clustered Federated Learning: Model-Agnostic Distributed Multitask Optimization Under Privacy Constraints. *IEEE Transactions on Neural Networks and Learning Systems*, 2020.
- Shamsian, A., Navon, A., Fetaya, E., and Chechik, G. Personalized Federated Learning Using Hypernetworks. In *International Conference on Machine Learning*, 2021.
- Shen, T., Zhang, J., Jia, X., Zhang, F., Huang, G., Zhou, P., Kuang, K., Wu, F., and Wu, C. Federated Mutual Learning. *arXiv preprint arXiv:2006.16765*, 2020.

- Silva, A., Tambwekar, P., and Gombolay, M. FedPerC: Federated Learning for Language Generation with Personal and Context Preference Embeddings. In *Findings of the Association for Computational Linguistics*, 2023.
- Singh, S., Vargus, F., Dsouza, D., Karlsson, B. F., Mahendiran, A., Ko, W.-Y., Shandilya, H., Patel, J., Mataciunas, D., OMahony, L., et al. Aya Dataset: An Open-Access Collection for Multilingual Instruction Tuning. *arXiv preprint arXiv:2402.06619*, 2024.
- Song, H., Zhao, H., Majumder, S., and Lin, T. Increasing Model Capacity for Free: A Simple Strategy for Parameter Efficient Fine-tuning. In *The Twelfth International Conference on Learning Representations*, 2024.
- Sun, G., Khalid, U., Mendieta, M., Wang, P., and Chen, C. Exploring Parameter-Efficient Fine-Tuning to Enable Foundation Models in Federated Learning. In *IEEE International Conference on Big Data*, 2024.
- Tan, F., Lee, R., Łukasz Dudziak, Hu, S. X., Bhattacharya, S., Hospedales, T., Tzimiropoulos, G., and Martinez, B. MobileQuant: Mobile-friendly Quantization for On-device Language Models. In *Conference on Empirical Methods in Natural Language Processing*, 2024.
- Tribes, C., Benarroch-Lelong, S., Lu, P., and Kobzyev, I. Hyperparameter optimization for large language model instruction-tuning. In *Edge Intelligence Workshop AAAI*, 2024.
- Valipour, M., Rezagholizadeh, M., Kobzyev, I., and Ghodsi, A. DyLoRA: Parameter-Efficient Tuning of Pre-trained Models using Dynamic Search-Free Low-Rank Adaptation. In *Proceedings of the 17th Conference of the European Chapter of the Association for Computational Linguistics (EACL)*, 2023.
- Wang, Z., Karthikeyan, K., Mayhew, S., and Roth, D. Extending Multilingual BERT to Low-Resource Languages. In *Findings of the Association for Computational Linguistics: EMNLP*, 2020a.
- Wang, Z., Lipton, Z. C., and Tsvetkov, Y. On Negative Interference in Multilingual Models: Findings and A Meta-Learning Treatment. In *Proceedings of the 2020 Conference on Empirical Methods in Natural Language Processing*, 2020b.
- Weller, O., Marone, M., Braverman, V., Lawrie, D., and Van Durme, B. Pretrained Models for Multilingual Federated Learning. In *Proceedings of the 2022 Conference of the North American Chapter of the Association for Computational Linguistics: Human Language Technologies*, 2022.
- Welling, M. and Teh, Y. W. Bayesian Learning via Stochastic Gradient Langevin Dynamics. In *Proceedings of the 28th International Conference on Machine Learning*, 2011.
- Wu, X., Liu, X., Niu, J., Wang, H., Tang, S., and Zhu, G. FedLoRA: When Personalized Federated Learning Meets Low-Rank Adaptation. 2024.
- Xu, D., Yin, W., Zhang, H., Jin, X., Zhang, Y., Wei, S., Xu, M., and Liu, X. EdgeLLM: Fast On-device LLM Inference with Speculative Decoding. *IEEE Transactions on Mobile Computing (TMC)*, 2024a.
- Xu, Y., Hu, L., Zhao, J., Qiu, Z., Ye, Y., and Gu, H. A Survey on Multilingual Large Language Models: Corpora, Alignment, and Bias. *arXiv preprint arXiv:2404.00929*, 2024b.
- Yang, Y., Liu, X., Gao, T., Xu, X., and Wang, G. SA-FedLora: Adaptive Parameter Allocation for Efficient Federated Learning with LoRA Tuning. *arXiv preprint arXiv:2405.09394*, 2024a.
- Yang, Y., Long, G., Shen, T., Jiang, J., and Blumenstein, M. Dual-Personalizing Adapter for Federated Foundation Models. In *Advances in Neural Information Processing Systems*, 2024b.
- Yao, K., Gao, P., Li, L., Zhao, Y., Wang, X., Wang, W., and Zhu, J. Layer-wise Importance Matters: Less Memory for Better Performance in Parameter-efficient Fine-tuning of Large Language Models. In *Findings of the Association for Computational Linguistics: EMNLP 2024*, 2024.
- Ye, R., Ge, R., Zhu, X., Chai, J., Du, Y., Liu, Y., Wang, Y., and Chen, S. FedLLM-Bench: Realistic Benchmarks for Federated Learning of Large Language Models. In *Advances in Neural Information Processing Systems*, 2024.
- Yurochkin, M., Agarwal, M., Ghosh, S., Greenewald, K., Hoang, N., and Khazaeni, Y. Bayesian Nonparametric Federated Learning of Neural Networks. In *International Conference on Machine Learning*, 2019.
- Zhang, Q., Chen, M., Bukharin, A., He, P., Cheng, Y., Chen, W., and Zhao, T. AdaLoRA: Adaptive Budget Allocation for Parameter-Efficient Fine-Tuning. In *The Eleventh International Conference on Learning Representations*, 2023.
- Zhang, R., Qiang, R., Somayajula, S. A., and Xie, P. AutoLoRA: Automatically Tuning Matrix Ranks in Low-Rank Adaptation Based on Meta Learning. In *Proceedings of the 2024 Conference of the North American Chapter of the Association for Computational Linguistics (NAACL)*, 2024a.

Zhang, Y., Qin, Z., Wu, Z., and Deng, S. Personalized Federated Fine-Tuning for LLMs via Data-Driven Heterogeneous Model Architectures. *arXiv preprint arXiv:2411.19128*, 2024b.

Zhao, R., Morwani, D., Brandfonbrener, D., Vyas, N., and Kakade, S. Deconstructing What Makes a Good Optimizer for Autoregressive Language Models. In *International Conference on Learning Representations*, 2025.

Zhao, W., Chen, Y., Lee, R., Qiu, X., Gao, Y., Fan, H., and Lane, N. D. Breaking Physical and Linguistic Borders: Multilingual Federated Prompt Tuning for Low-Resource Languages. In *International Conference on Learning Representations*, 2024.

Zhou, Y., Ram, P., Salonidis, T., Baracaldo, N., Samulowitz, H., and Ludwig, H. Single-shot General Hyper-parameter Optimization for Federated Learning. In *International Conference on Learning Representations*, 2023.

## A. Detailed Experimental Setup

For reproducibility and completeness, we provide comprehensive details of all setups, datasets, tasks, models, baselines, and hyperparameters. Code is in the process of being released.

### A.1. Tasks, Datasets, and Data Partitioning

**XNLI (Conneau et al., 2018)** A natural language inference benchmark dataset for evaluating cross-lingual understanding covering 15 diverse languages including both high- and low-resources languages: English, French, Spanish, German, Greek, Bulgarian, Russian, Turkish, Arabic, Vietnamese, Thai, Chinese, Hindi, Swahili and Urdu. XNLI consists of premise-hypothesis pairs, labeled as entailment, contradiction, or neutral across different languages. We sample 2k instances from the XNLI train split and 500 instances from the test split for each pool. The data is then divided equally among 20 clients for each language using the latent Dirichlet allocation (LDA) partition with  $\alpha = 0.5$ . Hence, the total number of clients is 600 (15 languages · 20 clients per language · 2 pools).

**MasakhaNEWS (Adelani et al., 2023)** A news topic classification benchmark designed to address the lack of resources for African languages. It covers 2 high-resource languages, English and French, and 14 low-resource languages, namely Amharic, Hausa, Igbo, Lingala, Luganda, Naija, Oromo, Rundi, chiShona, Somali, Kiswahili, Tigrinya, isiXhosa, and Yorùbá. Each sample contains a headline, the body text, and one of the 7 labels: business, entertainment, health, politics, religion, sports, or technology. We first combine all samples from the MasakhaNEWS train and validation split to form our train set, and use the MasakhaNEWS test split as our test set. We then split both train and test in each of the 16 languages by half for each pool. Following our XNLI setup, we adopt LDA  $\alpha = 0.5$  and divide each language’s data equally into 10 clients. Hence, the total number of clients is 320 (16 languages · 10 clients per language · 2 pools). Note that unlike XNLI, the number of samples for each language differs, hence there is quantity skew across clients.

**Fed-Aya (Ye et al., 2024)** A federated instruction tuning benchmark, based on Aya (Singh et al., 2024), where the data is annotated by contributors and partitioned by annotator ID. Following FedLLM-Bench (Ye et al., 2024), we focus on 6 high-resource languages, English, Spanish, French, Russian, Portuguese, Chinese, and 2 low-resource languages, Arabic and Telugu. Additionally, we filter out the other languages from the dataset. Out of 38 clients, we select 8 for our *unseen* pool, `client_ids = [21, 22, 23, 24, 25, 26, 27, 34]` and the rest goes into our *seen* pool. Each client can have up to 4 languages where the number of data samples can range from a hundred to over a

thousand samples per client.

## A.2. Models, Tokenizers, and Data Preprocessing

**mBERT (Devlin et al., 2018).** We use the pretrained multilingual BERT with its WordPiece tokenizer for all sequence classification experiments, namely all XNLI and MasakhaNEWS setups with various *base models*. For both datasets, we use a training batch size of 32 and pad input tokens on the right to a max token length of 128 and 256 respectively.

**MobileLLaMA-1.4B (Chu et al., 2023).** We train a *base model* with a pretrained MobileLLaMA-1.4B with Standard FL using LoRA in our Fed-Aya setup. We use the default LLaMA tokenizer which is a BPE model based on sentencepiece (Kudo & Richardson, 2018) and adopt the UNK token as the PAD token. During training, we use an effective batch size of 16 and pad right to the longest token in the batch up to a max token length of 1024. For evaluation, we use a batch size of 8, padding left instead, with greedy sampling up to a max new token length of 1024. We use the Alpaca template to format each prompt:

```
alpaca_template = """Below is an
instruction that describes a task.
Write a response that appropriately
completes the request.
```

```
### Instruction:
{}
```

```
### Response: {}{}"""
```

**Llama-3.2-3B (Dubey et al., 2024).** We use the off-the-shelf Llama-3.2-3B-Instruct model as our *base model* and its default tokenizer which is a BPE model based on tiktoken<sup>5</sup>. Training and evaluation hyperparameters are the same as the ones we use for MobileLLaMA. The only two differences are 1) we add a PAD token ‘<pad>’, and 2) we use the Llama 3 instruction template instead:

```
llama3_instruct_template = """</
begin_of_text|></start_header_id|>user
</end_header_id|>
```

```
{}</eot_id|></start_header_id|>assistant</
end_header_id|>
```

```
{}}{}
"""
```

## A.3. Complementary Approaches and Base Models

In this work, we experiment with different *base models* to show that FedP<sup>2</sup>EFT is complementary to a range of off-the-shelf models and models trained using existing FL ap-

proaches. In this section, we detail the different approaches we used to obtain these *base models*.

**Standard FL.** Standard FL involves training a single global model. Given a pretrained LLM, we run FedAvg on the *seen* pool of clients, where 10% of participating clients are sampled every round to train the model before sending the weights back for aggregation. In our XNLI and MasakhaNEWS setup, we do full fine-tuning of mBERT, setting each client’s learning rate to  $5e-5$  and running FedAvg for 100 rounds. In our Fed-Aya setup, we adopt the training recipe from FedLLM-Bench (Ye et al., 2024) for MobileLLaMA-1.4B, where we do PEFT with LoRA applied to query and value attention weights ( $r = 16$ ,  $\alpha_{lora} = 32$ , dropout= 0.05) for 200 rounds. We use the cosine learning rate decay over 200 rounds with initial learning rate  $2e^{-5}$  and minimum learning rate  $1e^{-6}$ .

**Personalized FL.** We train personalized *base models* using FedDPA-T (Yang et al., 2024b) and DEPT(SPEC) (Iacob et al., 2025) in our XNLI setup. FedDPA-T proposed having two separate LoRA adapters, one of which is shared (global) and the other is kept locally for each client (local). We adopted their training recipe for sequence classification, where the classifier is shared together with the global LoRA modules and the local LoRA modules stay local. LoRA modules are only applied to query and value attention weights ( $r=8$ ,  $\alpha_{lora} = 8$ , dropout=0.05). We set the learning rate to  $5e^{-5}$ .

DEPT (SPEC), on the other hand, proposed having personalized token and positional embeddings for each client. As DEPT was proposed for cross-silo FL, while we target cross-device FL, they assumed that each data source has an abundance of data to retrain the newly initialized embeddings. Hence, to adapt to the cross-device FL setting, we did not reinitialize the embeddings; each client fine-tunes their own embeddings starting from the pretrained mBERT embeddings. In other words, for each FL round, each client does full fine-tuning, sending weights of all layers except their own embeddings back to the server for aggregation. As with FedDPA-T, the learning rate is set to  $5e^{-5}$ .

**Off-the-shelf.** In our Fed-Aya setup, we use an off-the-shelf instruction finetuned Llama-3.2-3B-Instruct as our *base model*.

## A.4. Baselines and FedP<sup>2</sup>EFT

To avoid an exponentially big search space, all hyperparameter tuning is done using simple grid search on our XNLI setup, with mBERT, and Fed-Aya setup, with MobileLLaMA as the *base model*. The best hyperparameters found are then used for MasakhaNEWS and Fed-Aya with Llama3 respectively.

**LoRA PEFT (Hu et al., 2022).** We search for the learning

<sup>5</sup><https://github.com/openai/tiktoken>

rate  $[1e^{-5}, 1e^{-4}, 1e^{-3}]$  and the number of epochs  $[1, 2, 3]$  and find that the learning rate  $1e^{-4}$  with 2 epochs had the best performance on the train set. We fixed  $\alpha_{lora} = 2r$ . To ensure a similar inference budget across baselines, we set the number of epochs to 2 for all our experiments.

**AdaLoRA (Zhang et al., 2023).** Similarly to LoRA, we search for the learning rate  $[1e^{-5}, 1e^{-4}, 1e^{-3}, 1e^{-2}]$ , the time interval between two budget allocations,  $\Delta_T$ ,  $[1, 10, 100]$  and the coefficient of the orthogonal regularization,  $\gamma$ ,  $[0.1, 0.5]$ . Within our search space, we find learning rate  $= 1e^{-3}$ ,  $\Delta_T = 1.0$ , and  $\gamma = 0.1$  to be the best performing one. We run AdaLoRA once per resource budget  $r$ , setting the initial rank to be  $1.5 \times$  of  $r$ , as recommended. We set the initial fine-tuning warmup steps and final fine-tuning steps to be 10% and 30% of the total steps respectively.

**BayesTune-LoRA (Section 3.2).** For fair comparison with FedP<sup>2</sup>EFT, we use the same hyperparameters as FedP<sup>2</sup>EFT. This baseline, hence, is an ablation study of how much performance collaboratively learning a PSG adds.

**FedL2P (Lee et al., 2023)** As FedL2P requires a validation set for outer-loop bi-level optimization and federated early stopping, we split the train set of every client 80% train and 20% validation. Following FedL2P, we set the federated early stopping patience to 50 rounds, MLP hidden dimension is set to 100, the inner-loop learning rate to be the same as finetuning,  $1e^{-4}$ , and the hypergradient hyperparameters,  $Q = 3, \psi = 0.1$  with hypergradient clamping of  $[-1, 1]$ . We use Adam for both the inner-loop and outer-loop optimizers and search for the learning rate for the MLP (LRNet)  $[1e^{-5}, 1e^{-4}, 1e^{-3}]$  and the learnable post-multiplier learning rate  $\tilde{\eta}$   $[1e^{-4}, 1e^{-5}, 1e^{-6}]$ , picking  $1e^{-4}$  and  $1e^{-6}$  to be the best respectively. Finally, we use 3 outer-loop steps with an effective outer-loop batch size of 16.

**FedP<sup>2</sup>EFT (Section 3.3)** We set  $\alpha_{r,mul} = 2$ , our resulting  $r_{init}$  is, hence, 32 since our  $r_{max,target} = 16$  for all experiments. Following our standard LoRA fine-tuning baseline, we adopt the same learning rate and  $\alpha_{lora}$ ,  $1e^{-4}$  and  $2r_{init}$  respectively. The learning rate of  $\lambda$ , on the other hand, is searched  $[1e^{-1}, 1e^{-2}, 1e^{-3}, 1e^{-4}]$ , and we pick  $1e^{-2}$  for all experiments. All  $\lambda$  values are initialized to  $1e^{-4}$ . The MLP hidden dimension is set to  $2 \times$  the input dimension, which is model dependent. We clamp the output of the MLP as well as  $\lambda$  with a minimum value of  $1e^{-4}$  in the forward pass during training. Following FedL2P, we use a straight-through estimator (Bengio et al., 2013) after clamping to propagate gradients. We initialize the weights of MLP with Xavier initialization (Glorot & Bengio, 2010) using the normal distribution with a gain value of  $1e^{-6}$  and the bias with a constant  $1e^{-4}$ . Lastly, we set  $\alpha_s = 1e^{+2}$  and  $\alpha_p = 1e^{-2}$  for all experiments.

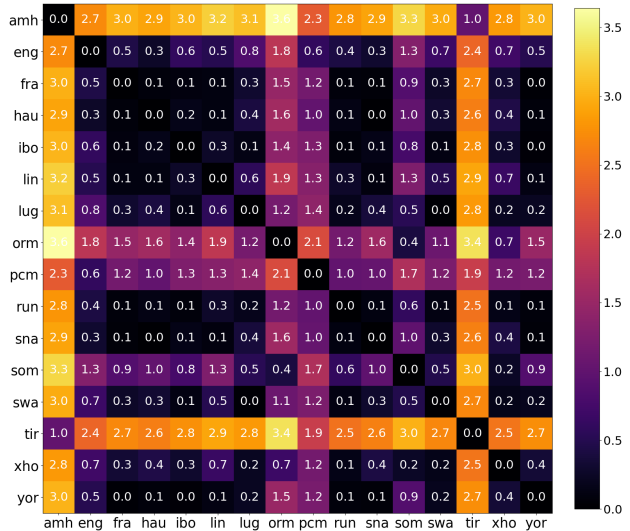

Figure 5.  $\lambda$  distance among languages in our MasakhaNEWS setup. Each block shows the log-scale normalized average Euclidean distances between all pairs of clients’  $\lambda$  for two languages (see text). The smaller the distance, the more similar  $\lambda$  is.

## B. Additional Results

This section contains supplementary results and analyses, omitted from the main paper due to space limitations, that complement the presented findings. Fig. 8-15 show the language-agnostic rank structures under different budgets ( $r = 2$  and  $r = 16$ ) learnt by FedP<sup>2</sup>EFT for different setups as mentioned in Section 4.5. These plots illustrate the prioritization of layers for LoRA fine-tuning.

Note that while the rank structure is the same across languages, the strength of personalization, absolute value of  $\lambda$ , differs, as shown in Fig. 5 in this Section and Fig. 4 in the main paper. These two figures show the difference in  $\lambda$  across languages as described in Section 4.5. To sum up, the smaller the distance between two languages, represented as a block in the figure, the more similar their generated  $\lambda$  are. The results show that while similar languages sometimes exhibit similar  $\lambda$  values, unrelated languages also occasionally share similar  $\lambda$ , consistent with findings in the literature that leveraging dissimilar languages can be beneficial.

Lastly, Tables 8 and 9 contain results for our XNLI setup where the *base model* is fine-tuned from the pretrained mBERT with Standard FL using full fine-tuning and is used to complement results and findings in Section 4.2. Similarly, Tables 10 and 11 complement the results and findings of our Fed-Aya setup described in Section 4.3.

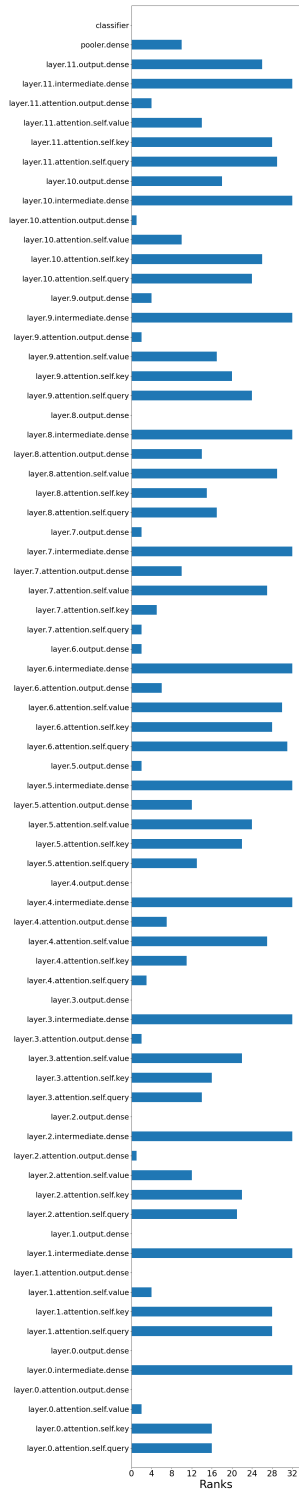

Figure 6. Language agnostic rank structure of mBERT in our XNLI setup where the *base model* is trained with FedIFT full-finetuning ( $r = 16$ ).

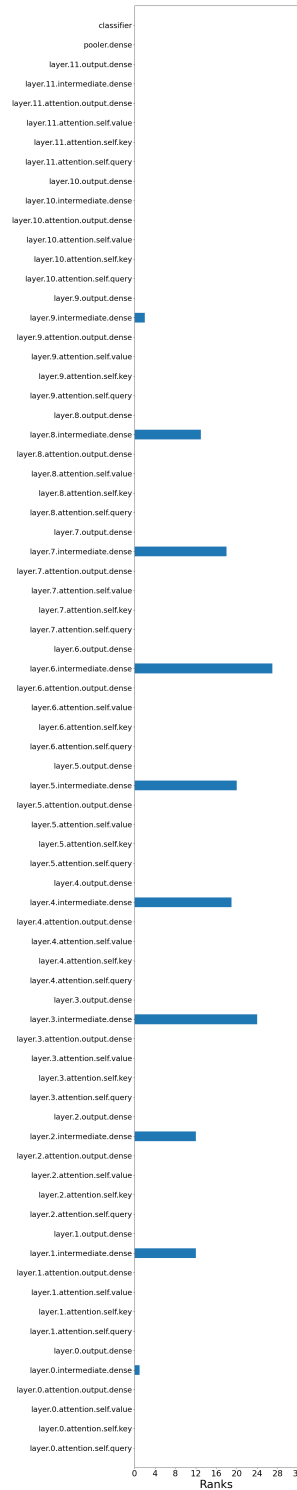

Figure 7. Language agnostic rank structure of mBERT in our XNLI setup where the *base model* is trained with FedIFT full-finetuning ( $r = 2$ ).

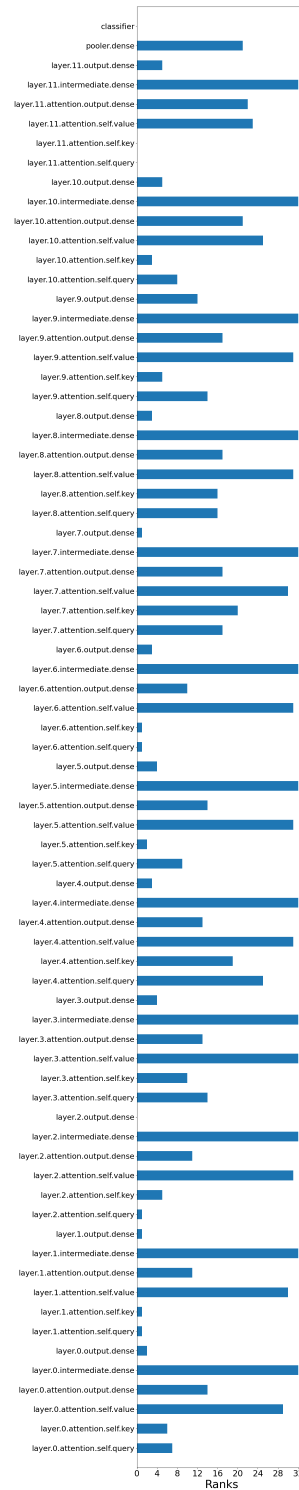

Figure 8. Language agnostic rank structure of mBERT in our XNLI setup where the *base model* is trained with DEPT(SPEC) ( $r = 16$ ).

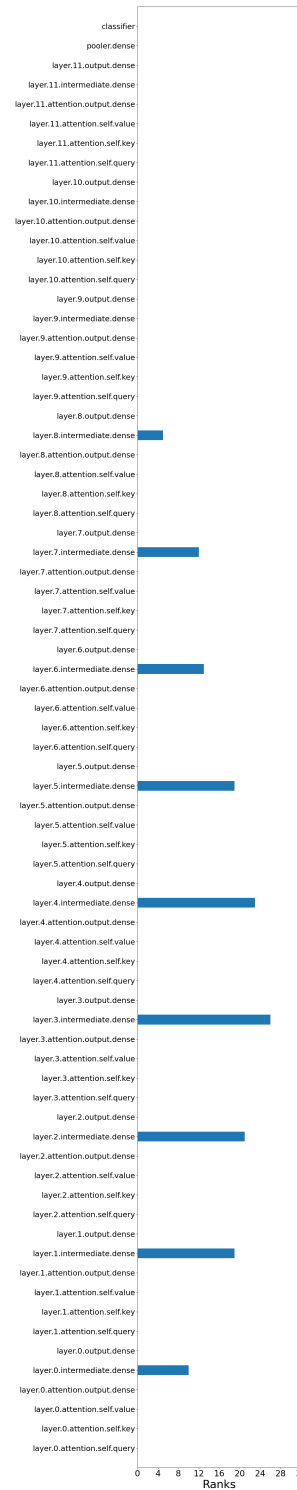

Figure 9. Language agnostic rank structure of mBERT in our XNLI setup where the *base model* is trained with DEPT(SPEC) ( $r = 2$ ).

## Federated Learning to Personalize PEFT for Multilingual LLMs

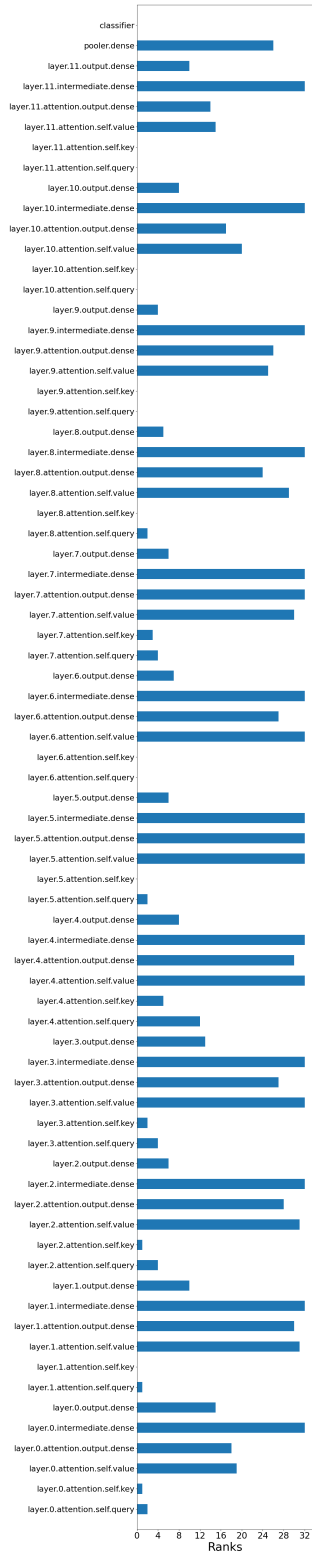

Figure 10. Language agnostic rank structure of mBERT in our MasakhaNEWS setup where the *base model* is trained with FedIFT full-finertuning ( $r = 16$ ).

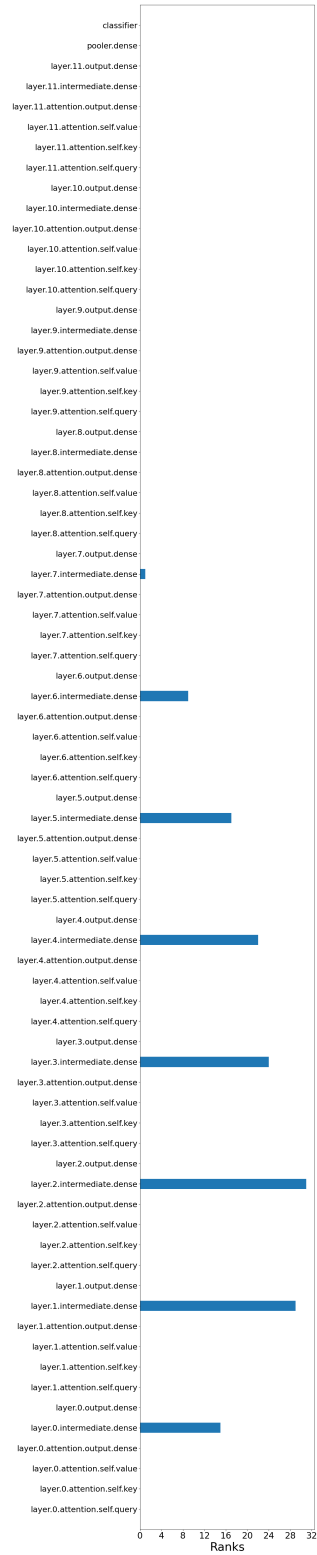

Figure 11. Language agnostic rank structure of mBERT in our MasakhaNEWS setup where the *base model* is trained with FedIFT full-finertuning ( $r = 2$ ).



# Federated Learning to Personalize PEFT for Multilingual LLMs

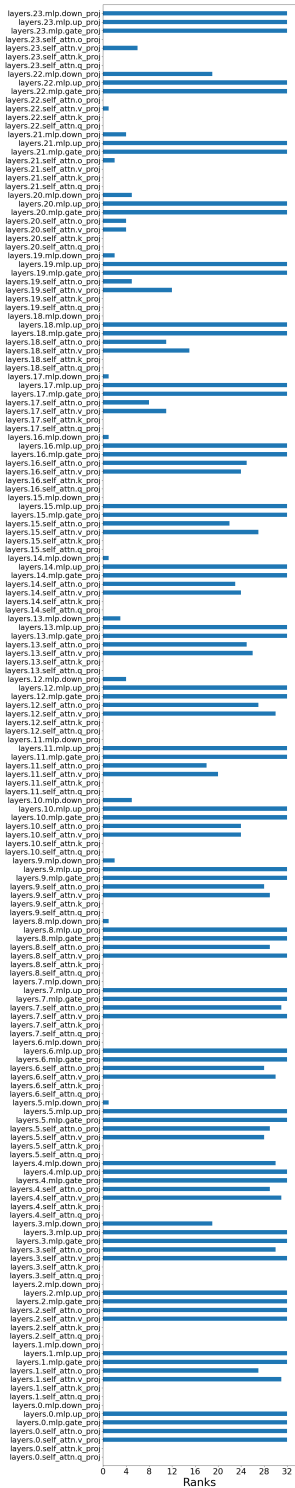

Figure 12. Language agnostic rank structure of MobileLLaMA-1.4B in our Fed-Aya setup where the *base model* is trained with FedIFT LoRA ( $r = 16$ ). Zoom in for best results.

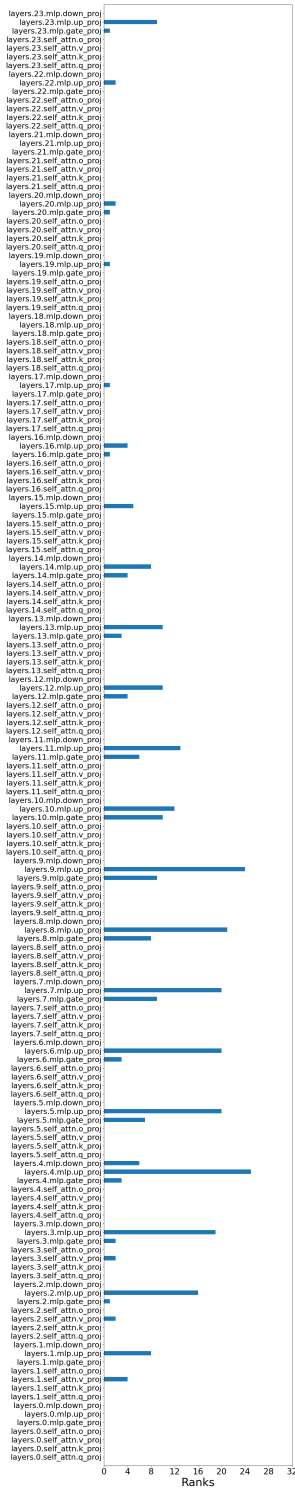

Figure 13. Language agnostic rank structure of MobileLLaMA-1.4B in our Fed-Aya setup where the *base model* is trained with FedIFT LoRA ( $r = 2$ ). Zoom in for best results.

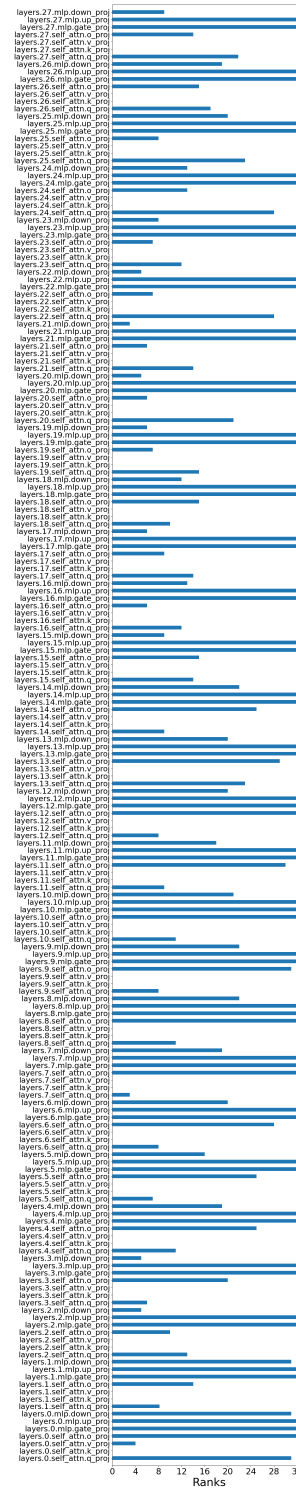

Figure 14. Language agnostic rank structure of Llama-3.2-3B in our Fed-Aya setup where the *base model* is an off-the-shelf instruction tuned Llama-3.2-3B-Instruct ( $r = 16$ ). Zoom in for best results.

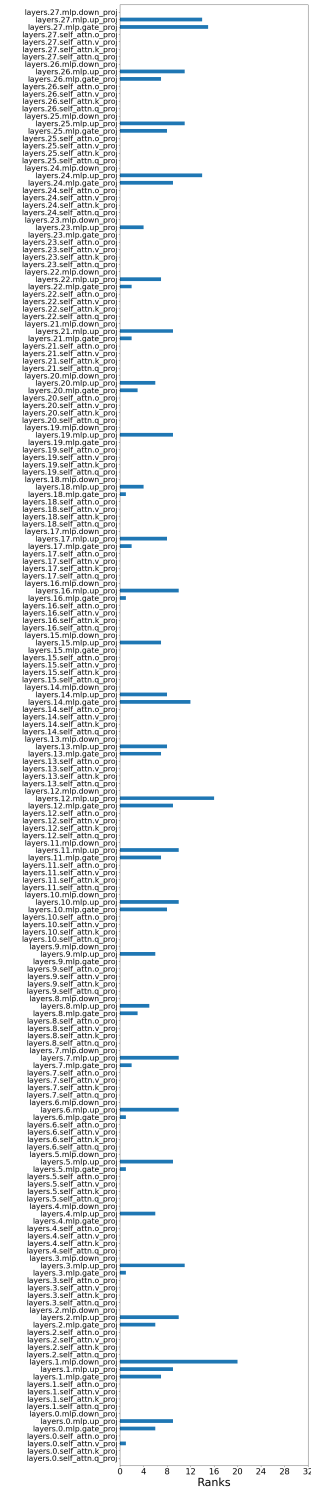

Figure 15. Language agnostic rank structure of Llama-3.2-3B in our Fed-Aya setup where the *base model* is an off-the-shelf instruction tuned Llama-3.2-3B-Instruct ( $r = 2$ ). Zoom in for best results.

