

**SEMI-INCLUSIVE HADRON-HADRON TRANSVERSE  
SPIN ASYMMETRIES AND THEIR IMPLICATION  
FOR POLARIZED DIS**

M. Boglione  
*Vrije Universiteit Amsterdam*  
E. Leader  
*Birkbeck College, London*

Abstract

We discuss <sup>1</sup> a possible explanation of the 25 year old mystery of the large transverse spin asymmetries found in many semi-inclusive hadron-hadron reactions. We obtain the first reliable information about the transverse polarized quark densities  $\Delta_T q(x)$  and we find surprising implications for the usual, longitudinal, polarized DIS. The plan of the presentation is as follows: 1) A brief reminder about the internal structure of the nucleon. 2) The transverse asymmetries. 3) Why it is so difficult to explain the asymmetries. 4) Failure and then success using a new soft mechanism. 5) implications for polarized DIS.

---

<sup>1</sup>Presented by E. Leader

## 1 Internal structure of the nucleon at the parton level

For each quark there are three kinds of number densities:

a) The usual  $q(x)$

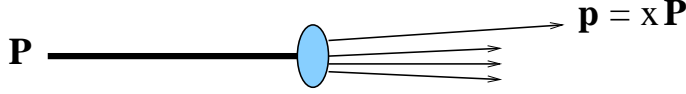

$q(x)$  is the number density of quarks with momentum fraction in the range  $x \leq p/P \leq x + \Delta x$ . This is mostly measured in DIS.

b) The longitudinal polarized density  $\Delta q(x)$

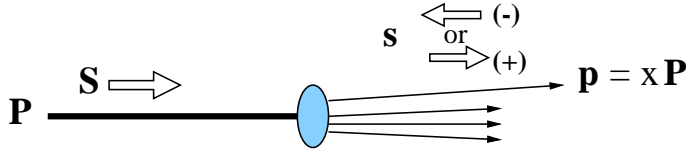

$q_{\pm}(x)$  is the number density at  $x$  with spin  $\mathbf{s}$  along (+) or opposite (-) to the spin  $\mathbf{S}$  ( $\implies$ ) of the nucleon. The new density is

$$\Delta q(x) = q_{+}(x) - q_{-}(x). \quad (1)$$

It is measured in DIS using a longitudinally polarized nucleon target.

c) The transverse polarized density  $\Delta_T q(x)$

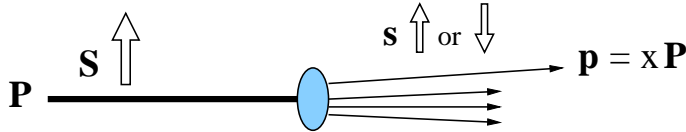

$q_{\uparrow\downarrow}(x)$  are the number densities at  $x$  with transverse spin  $\mathbf{s}$  along ( $\uparrow$ ) or opposite ( $\downarrow$ ) to the transverse nucleon spin  $\mathbf{S}$  ( $\uparrow$ ). The new density is

$$\Delta_T q(x) = q_{\uparrow}(x) - q_{\downarrow}(x). \quad (2)$$

Note that  $\Delta_T q(x)$  *cannot* be measured in DIS with a transversely polarized target;  $g_2(x)$  does not tell us anything about  $\Delta_T q(x)$ .

In summary there are 3 independent functions, all equally fundamental, describing the internal structure of the nucleon:  $q(x)$ ,  $\Delta q(x)$  and  $\Delta_T q(x)$ .

How can we measure  $\Delta_T q(x)$ ? The ideal reaction would be Drell-Yan using transversely polarized beam and target, but this has never been done. It is one of the prime aims at RHIC. Can one use semi-inclusive hadron-hadron reactions with a transversely polarized target? At first sight, yes. At second sight, no. And finally, yes, but one has to introduce a new theoretical idea and thereby it seems possible to resolve the ancient puzzle of the large transverse spin asymmetries.

## 2 The transverse spin asymmetries

There is a mass of data on reactions of the type  $A^\uparrow + B \rightarrow C + X$  for which the asymmetry  $A_N$  under the reversal of the transverse spin is measured:

$$A_N = \frac{d\sigma^\uparrow - d\sigma^\downarrow}{d\sigma^\uparrow + d\sigma^\downarrow}. \quad (3)$$

Some examples are shown in Fig. 1 for  $p^\uparrow p \rightarrow \pi X$  and  $\bar{p}^\uparrow p \rightarrow \pi X$  <sup>1)</sup> respectively. From looking at many reactions one concludes that:

- the asymmetries are large !
- they increase with  $p_T$
- they increase with  $x_F$
- they seem independent of energy
- they occur in a variety of reactions.

For decades there has been no serious theoretical explanation and, as we shall see, the standard approach via perturbative QCD gives  $A_N = 0$ .

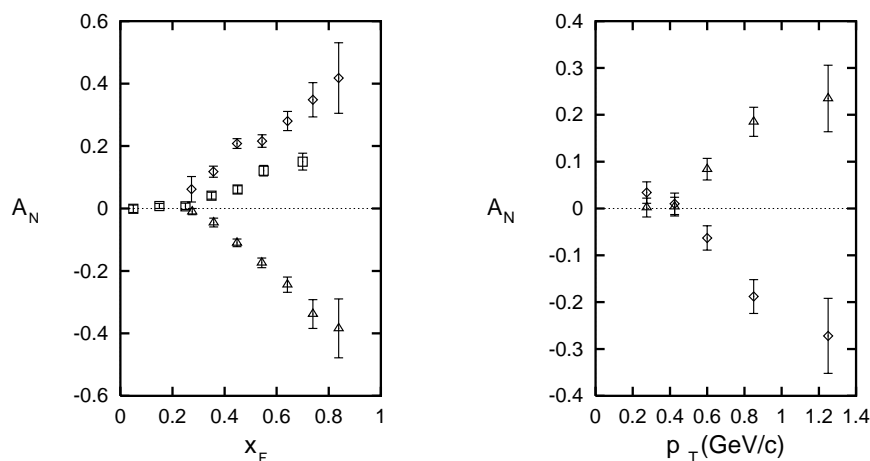
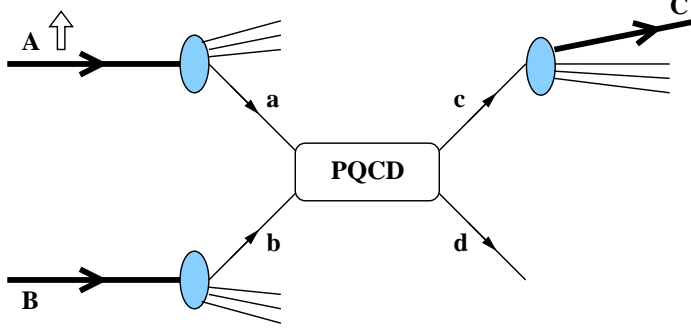

Figure 1: *Single spin asymmetry for  $p^\uparrow p \rightarrow \pi X$  versus  $x_F$  and  $\bar{p}^\uparrow p \rightarrow \pi X$  versus  $p_T$ , both at 200 GeV<sup>2</sup> <sup>1)</sup>. Diamonds correspond to  $\pi^+$ , squares to  $\pi^0$  and triangles to  $\pi^-$ .*

### 3 Why it is difficult to explain the asymmetries

The standard parton model picture for  $A^\uparrow + B \rightarrow C + X$  at large momentum transfer is



The hadronic  $A_N$  depends upon the asymmetry  $\hat{a}_N$  at the parton level, i.e. the asymmetry in

$$q_a^\uparrow + q_b \rightarrow q_c + q_d. \quad (4)$$

But

$$\hat{a}_N \propto \text{Im}\{(\text{Helicity Non-flip})^* (\text{Single flip})\}. \quad (5)$$

In lowest order this is doubly zero: there is no helicity flip and the amplitudes are real. Going to higher order doesn't help. One finds, if one takes  $m_q \neq 0$ ,

$$\hat{a}_N = \alpha_s \frac{m_q}{\sqrt{\hat{s}}} f(\theta^*) \quad (6)$$

which gives asymmetries of less than 1%.

### 4 New soft mechanism

Consider, for concreteness, the reaction  $p^\uparrow p \rightarrow \pi^\pm X$ . Let us concentrate only on the partons in the polarized proton and follow them through the partonic diagram. We assume that the  $\pi$ 's come mainly from the fragmentation of quarks. The notation is the following:  $f_{q/p}$  is the number density of  $q$  in  $p$  and  $D^{\pi/q}$  the number density of  $\pi$  in the fragmentation of  $q$ .

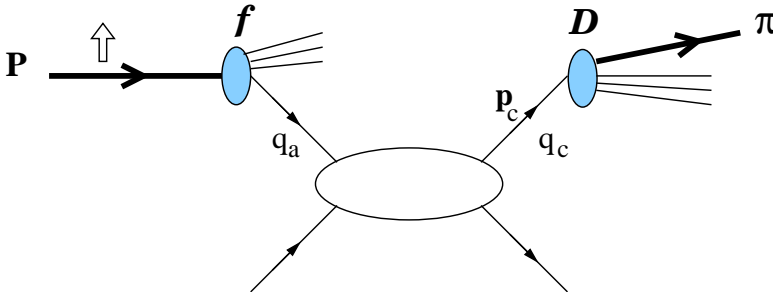

Proceeding blindly to sum over all possible spins of the quarks leads to

$$d\sigma^\uparrow - d\sigma^\downarrow = [f_{q_a/p^\uparrow} - f_{q_a/p^\downarrow}] \cdot \hat{\sigma} \cdot D^{\pi/q} + [f_{q_a^\uparrow/p^\uparrow} - f_{q_a^\downarrow/p^\uparrow}] \cdot \Delta\hat{\sigma} \cdot [D^{\pi/q_c}(\mathbf{s}_c) - D^{\pi/q_c}(-\mathbf{s}_c)] \quad (7)$$

where  $D^{\pi/q}$  is the usual, unpolarized fragmentation function, and  $\Delta\hat{\sigma}$  will be defined presently;  $\mathbf{s}_c$  is the polarization vector of quark  $c$ . The key question is: which, if any, of these terms are non-zero ?

a) With usual collinear kinematics

$$f_{q/p^\uparrow} - f_{q/p^\downarrow} = 0 \quad (8)$$

Reason ?

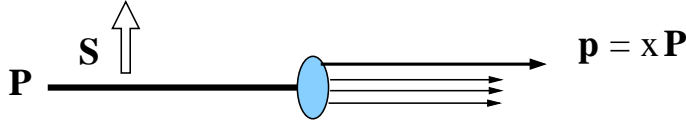

There are only two independent vectors,  $\mathbf{P}$  and the pseudovector  $\mathbf{S}$ . We cannot construct a *scalar* which depends on  $\mathbf{S}$ . Similarly

$$D^{\pi/q}(\mathbf{s}) - D^{\pi/q}(-\mathbf{s}) = 0 \quad (9)$$

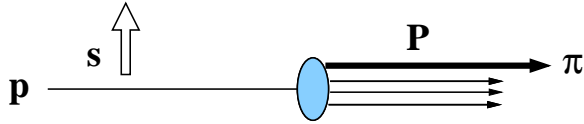

Again, we cannot construct a scalar from the vector  $\mathbf{P}$  and the pseudovector  $\mathbf{s}$ .

Thus both terms in Eq. (7) vanish in the collinear kinematics and  $A_N = 0$ .

b) With intrinsic transverse momentum

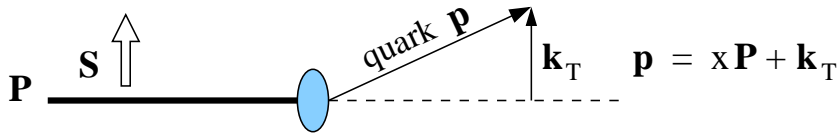

Now, apparently, we could have

$$f_{q/p(s)}(x, k_T) = f(x, k_T) + \tilde{f}(x, k_T) \mathbf{S} \cdot (\mathbf{P} \times \mathbf{k}_T) \quad (10)$$

implying

$$f_{q/p^\uparrow} - f_{q/p^\downarrow} \neq 0 \quad (11)$$

This mechanism was proposed by Sivers <sup>2)</sup> and further studied in <sup>3)</sup>. However, it violates time-reversal invariance, so we shall take the first term in Eq. (7) to be zero. Strangely, the analogous mechanism for the fragmentation

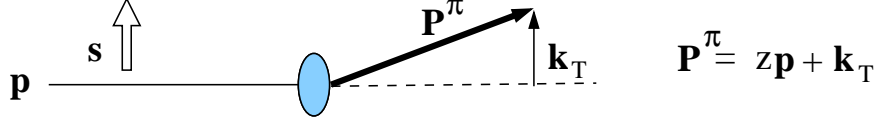

$$D^{\pi/q}(\mathbf{s}) - D^{\pi/q}(-\mathbf{s}) \neq 0 \quad (12)$$

does not violate time-reversal invariance. This is the Collins mechanism <sup>4)</sup>. Hence Eq. (7) becomes

$$\begin{aligned} d\sigma^\uparrow - d\sigma^\downarrow &= [f_{q_a^\uparrow/p^\uparrow} - f_{q_a^\downarrow/p^\uparrow}] \cdot \Delta\hat{\sigma} \cdot [D^{\pi/q_c}(\mathbf{s}_c) - D^{\pi/q_c}(-\mathbf{s}_c)] \\ &= [\Delta_T q_a] \cdot \left[ \frac{d\hat{\sigma}}{d\hat{t}}(a^\uparrow b \rightarrow c^\uparrow d) - \frac{d\hat{\sigma}}{d\hat{t}}(a^\uparrow b \rightarrow c^\downarrow d) \right] \cdot [\Delta_N D_{\pi/q_c}]. \end{aligned} \quad (13)$$

In full detail <sup>5)</sup>

$$\begin{aligned} d\sigma^\uparrow - d\sigma^\downarrow &\propto \int dx_a dx_b d^2\mathbf{k}_T^\pi q(x_b) \Delta_T q(x_a) \times \\ &\times \left[ \frac{d\hat{\sigma}}{d\hat{t}}(a^\uparrow b \rightarrow c^\uparrow d) - \frac{d\hat{\sigma}}{d\hat{t}}(a^\uparrow b \rightarrow c^\downarrow d) \right] \cdot \Delta_N D_{\pi/q_c}(z, \mathbf{k}_T^\pi), \end{aligned} \quad (14)$$

where the term  $[\frac{d\hat{\sigma}}{d\hat{t}}(a^\uparrow b \rightarrow c^\uparrow d) - \frac{d\hat{\sigma}}{d\hat{t}}(a^\uparrow b \rightarrow c^\downarrow d)]$  is calculated in PQCD. The result depends on two unknown functions:  $\Delta_T q(x)$  and  $\Delta_N D_{\pi/q_c}$ , which we can measure by trying to fit the data.

Now, as stressed earlier, the asymmetries are large, so will demand large values of  $\Delta_T q(x)$  and  $\Delta_N D_{\pi/q_c}$ . However, positivity requires that

$$|\Delta_N D_{\pi/q_c}| \leq 2D_{\pi/q_c} \quad (15)$$

and the Soffer bound <sup>6)</sup> restricts the magnitude of  $\Delta_T q(x)$ :

$$|\Delta_T q(x)| \leq \frac{1}{2}[q(x) + \Delta q(x)] \quad (16)$$

where  $\Delta q(x)$  is the usual longitudinal polarized quark density.

How important is the Soffer bound? In Fig. 2 we show a typical picture of  $\Delta u(x)$  and  $\Delta d(x)$ . We see that:

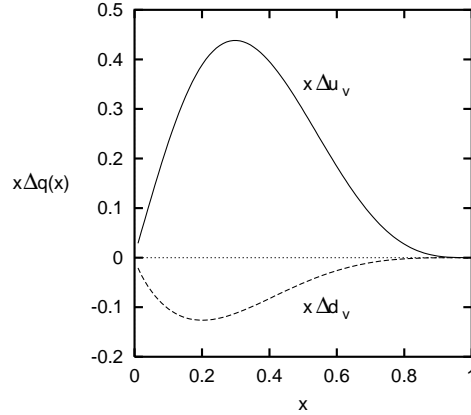

Figure 2: A typical picture of  $\Delta u(x)$  and  $\Delta d(x)$ , from LSS <sup>7)</sup> fit to polarized DIS experimental data.

a)  $\Delta u(x)$  is positive everywhere, so that

- $u(x) + \Delta u(x)$  is big
- RHS of Soffer bound is large
- not very restrictive on  $\Delta_T u(x)$

b)  $\Delta d(x)$  is (usually) negative everywhere, so that

- $d(x) + \Delta d(x)$  is small
- RHS of Soffer bound is small
- highly restrictive on  $\Delta_T d(x)$

But the measured asymmetries are such that  $A_N^{\pi^+} \simeq -A_N^{\pi^-}$ , so that if the  $\pi^+$  come mainly from the  $u$ -quarks and the  $\pi^-$  from  $d$ -quarks we expect trouble in getting a large enough asymmetry for  $\pi^-$ . Indeed, if we use the Gehrman-Stirling (GS) <sup>8)</sup>  $\Delta u(x)$  and  $\Delta d(x)$  to bound  $\Delta_T u(x)$  and  $\Delta_T d(x)$  we obtain a catastrophic fit to the data (Fig. 3) with  $\chi_{D.O.F}^2 \sim 25$  !

Can we escape this dilemma ? There is a surprising escape route !

There is an old PQCD argument <sup>9)</sup> that requires for quarks, antiquarks and gluons

$$\frac{\Delta q(x)}{q(x)} \rightarrow 1 \text{ as } x \rightarrow 1 \quad (17)$$

which implies that all  $\Delta q(x)$  must become positive as  $x \rightarrow 1$ . But almost all fits to polarized DIS ignore this condition on the grounds that (i) Eq. (17) is incompatible with DGLAP evolution and that (ii) the data demand a negative  $\Delta d(x)$ . In fact, these arguments are spurious because (i) DGLAP is not valid as  $x \rightarrow 1$  where one

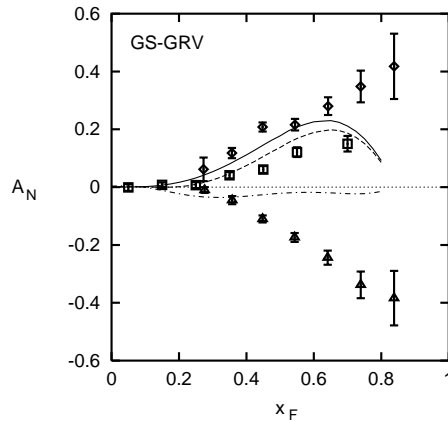

Figure 3: *Single spin asymmetry for pion production in the process  $p^\uparrow p \rightarrow \pi X$  <sup>1)</sup> as a function of  $x_F$  obtained by using the GS <sup>8)</sup> set of distribution functions. The solid line refers to  $\pi^+$ , the dashed line to  $\pi^0$  and the dash dotted line to  $\pi^-$ .*

approaches the exclusive region and (ii) the data do not really extend to large  $x$ . So let us try to impose  $\Delta q(x)/q(x) \rightarrow 1$  as  $x \rightarrow 1$  in the fits to polarized DIS. In fact, this was done by Brodsky, Burkhardt and Schmidt (BBS <sup>12)</sup>, but the treatment was rough and evolution was not included. This was improved upon by Leader, Sidorov and Stamenov (LSS)<sub>BBS</sub> <sup>11)</sup> so as to include evolution and a reasonably good fit to the polarized DIS data was achieved. In Fig. 4 we compare the GS and BBS  $\Delta d(x)$ . It is clear that the Soffer bound on  $\Delta_T d(x)$  will be much less restrictive at large  $x$  for the BBS case. Indeed, using the BBS  $\Delta q(x)$  to bound the  $\Delta_T q(x)$  has a dramatic effect upon our attempts to fit the  $\pi^\pm$  asymmetries as can be seen in Fig. 5 where  $\chi^2_{D.O.F} = 1.45$ . In carrying out the fit <sup>13)</sup> we made the following simplifications:

- a) The asymmetry is largest at large  $x_F \implies$  large  $x$  is important. Therefore we used only  $u$  and  $d$  quarks.
- b) Large  $x_F \implies$  large  $z$  in the fragmentation. Hence we assumed  $u \rightarrow \pi^+$ ,  $d \rightarrow \pi^-$  only.
- c) The unknown functions were parameterized so that the bounds in Eqs. (15) and (16) are automatically satisfied. Thus we took

$$\Delta_T q(x) = N_q \left[ \frac{x^a (1-x)^b}{\frac{a^a b^b}{(a+b)^{a+b}}} \right] \left\{ \frac{1}{2} [q(x) + \Delta q(x)] \right\} \quad (18)$$



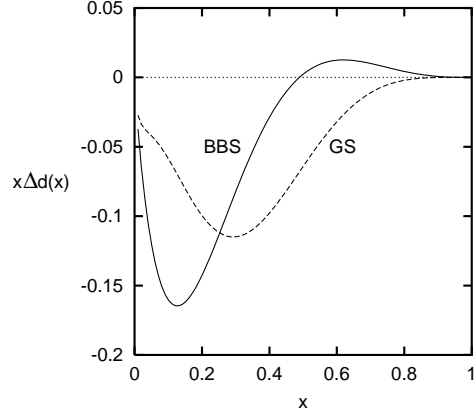

Figure 4: Comparison of the GS <sup>8)</sup> and BBS <sup>12)</sup>  $\Delta d(x)$ .

and

$$\Delta_N D(z) = N_F \left[ \frac{z^\alpha (1-z)^\beta}{\frac{\alpha^\alpha \beta^\beta}{(\alpha+\beta)^{\alpha+\beta}}} \right] \{2 D(z)\}, \quad (19)$$

where  $N_{q,F}$  are real constants with  $|N_{q,F}| \leq 1$ , and the functions in square brackets have modulus  $\leq 1$ . The fit to the asymmetry data then determines a range of possible  $\Delta_T u(x)$  and  $\Delta_T d(x)$  as shown in Fig. 6.

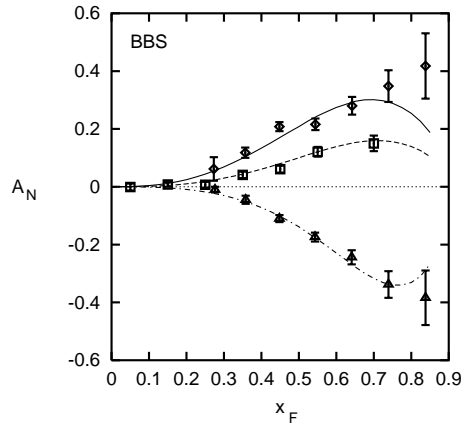

Figure 5: Single spin asymmetry for  $p^\uparrow p \rightarrow \pi X$  <sup>1)</sup> as obtained by using the BBS <sup>12)</sup> set of distribution functions. The solid line refers to  $\pi^+$ , the dashed line to  $\pi^0$  and the dash dotted line to  $\pi^-$ .

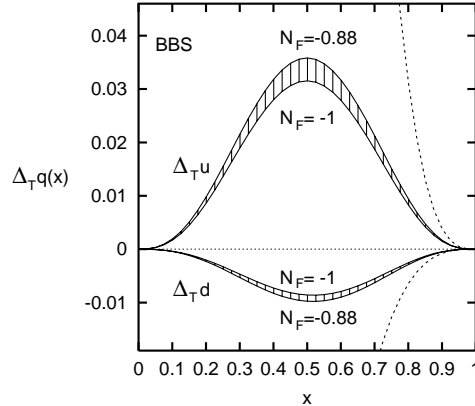

Figure 6: *The allowed range of distribution functions  $\Delta_T u(x)$  and  $\Delta_T d(x)$  versus  $x$ , as determined by the fit using the BBS <sup>12)</sup> distribution functions. The dotted lines are the boundaries imposed by the Soffer inequality.*

## 5 Implications and conclusions

- a) It seems that the soft Collins mechanism can explain the semi-inclusive transverse spin asymmetries if  $\Delta_T u(x)$  and  $\Delta_T d(x)$  are large enough in magnitude.
- b) This, via the Soffer bound, seems to require  $\Delta q(x)/q(x) \rightarrow 1$  as  $x \rightarrow 1$ .
- c) For the  $d$ -quark this implies that  $\Delta d(x)$  must change sign and become positive at large  $x$ .
- d) This, in turn, has a significant effect upon the shape of  $g_1^n(x)$  at large  $x$ . Fig. 7 compares the behavior of  $g_1^n(x)$  for the “best” usual fit to the polarized parton densities with that from fits satisfying  $\Delta d(x)/d(x) \rightarrow 1$ . The exciting link between transverse asymmetries and polarized DIS emphasizes the importance of extending that polarized DIS measurements to larger  $x$ .
- e) Some notes of caution:
  - (i) The Collins mechanism does not seem able to produce large enough  $A_N$  at the largest  $x_F$  measured. However, there does exist another kind of mechanism, outside the framework of the usual parton model, based on correlated quark-gluon densities in a hadron, which can also produce a transverse spin asymmetry. It may be that a superposition of the two mechanisms is needed.
  - (ii) For either of these mechanisms  $A_N$  must decrease when  $\mathbf{p}_T^\pi$  becomes much

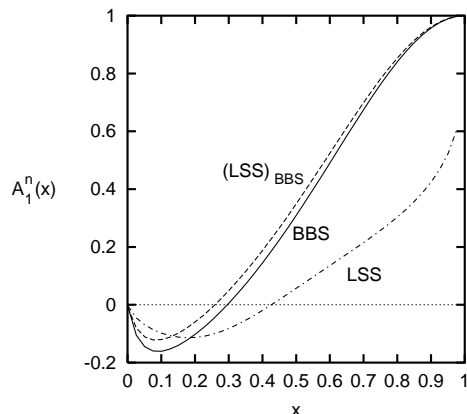

Figure 7: The neutron longitudinal asymmetry  $A_1^n(x)$ , as obtained by using the BBS <sup>12)</sup> and  $(LSS)_{BBS}$  <sup>11)</sup> parametrizations (solid and dashed lines respectively), and the LSS parametrizations (dash-dotted line).

greater than the intrinsic  $\mathbf{k}_T^\pi$ . So far there is no sign of such a decrease in the data.

- f) Finally, we wish to re-emphasize the beautiful interplay between, at first sight, quite unrelated aspects of particle physics.

## 6 Acknowledgements

E. L. is grateful to G. Bellettini and M. Greco for their hospitality. This research project was supported by the Foundation for Fundamental Research on Matter (FOM) and the Dutch Organization for Scientific Research (NWO).

## References

1. D.L. Adams *et al.*, Phys. Lett. **B264**, 462 (1991); A. Bravar *et al.*, Phys. Rev. Lett. **77**, 2626 (1996).
2. D. Sivers, Phys. Rev. **D41**, 83 (1990); **D41**, 261 (1991).
3. M. Anselmino, M. Boglione, F. Murgia, Phys. Lett. **B362**, 164 (1995), M. Anselmino and F. Murgia, Phys. Lett. **B442**, 470 (1998).
4. J.C. Collins, Nucl. Phys. **B396**, 161 (1993).

5. M. Anselmino, M. Boglione, F. Murgia, Phys. Rev. **D60**, 054027, (1999); M. Boglione and P.J. Mulders, Phys. Rev. **D60**, 054007 (1999).
6. J. Soffer, Phys. Rev. Lett. **74**, 1292 (1995).
7. E. Leader, A.V. Sidorov and D.B. Stamenov, Phys. Rev. **D58**, 114028 (1998); Phys. Lett. **B462**, 189 (1999).
8. T. Gehrmann and W.J. Stirling, Phys. Rev. **D53**, 6100 (1996).
9. G. R. Farrar and D. R. Jackson, Phys. Rev. Lett. **35**, 1416 (1975).
10. S.J. Brodsky, M. Burkhardt and I. Schmidt, Nucl. Phys. **B441**, 197 (1995).
11. E. Leader, A.V. Sidorov and D.B. Stamenov, Int. Journ. Mod. Phys. **A13**, No.32, 5573 (1998).
12. S.J. Brodsky, M. Burkhardt and I. Schmidt, Nucl. Phys. **B441**, 197 (1995).
13. M. Boglione and E. Leader, Phys. Rev. **D61** 114001 (2000).