

CP Violation: Past, Present, and Future*

Jonathan L. Rosner

*Enrico Fermi Institute and Department of Physics
University of Chicago, Chicago, IL 60637 USA*

We discuss the history of CP violation and its manifestations in kaon physics, its explanation in terms of phases of the Cabibbo-Kobayashi-Maskawa matrix describing charge-changing weak quark transitions, predictions for experiments involving B mesons, and the light it can shed on physics beyond the Standard Model.

I. INTRODUCTION

CP symmetry and its violation are important guides to fundamental quark properties and to the understanding of the matter-antimatter asymmetry of the Universe. In this review, an updated version of one presented earlier in the year [1], we describe past, present, and future aspects of CP violation studies. After an illustration of fundamental discrete symmetries in Maxwell's equations (Sec. II), we recall the history of CP violation's discovery [2] in the decays of neutral kaons (Sec. III). The product CPT so far seems to be conserved, as is expected in local Lorentz-invariant quantum field theories [3]. We then discuss the electroweak theory's explanation of CP violation [4] in terms of phases of the Cabibbo-Kobayashi-Maskawa (CKM) [4,5] matrix in Sec. IV), and mention some present tests of this theory with kaons (Sec. V) B mesons (Sec. VI), and charmed particles (Sec. VII). The future of CP violation studies (Sec. VIII) is very rich, with a wide variety of experiments relevant to physics beyond the Standard Model and the baryon asymmetry of the Universe.

II. DISCRETE SYMMETRIES IN MAXWELL'S EQUATIONS

The behavior of the Maxwell equations under the discrete symmetries P (parity), T (time reversal), C (charge conjugation), and CPT is summarized in Table I. Each term behaves as shown.

TABLE I. Behavior of Maxwell's equations under discrete symmetries.

Equation	P	T	C	CPT
$\nabla \cdot \mathbf{E} = 4\pi\rho$	+	+	-	-
$\nabla \cdot \mathbf{B} = 0$	-	-	-	-
$\nabla \times \mathbf{B} - \frac{1}{c} \frac{\partial \mathbf{E}}{\partial t} = \frac{4\pi}{c} \mathbf{j}$	-	-	-	-
$\nabla \times \mathbf{E} + \frac{1}{c} \frac{\partial \mathbf{B}}{\partial t} = 0$	+	+	-	-

Under P, we have

$$\mathbf{E}(\mathbf{x}, t) \rightarrow -\mathbf{E}(-\mathbf{x}, t), \quad \mathbf{B}(\mathbf{x}, t) \rightarrow \mathbf{B}(-\mathbf{x}, t), \quad (1)$$

$$\nabla \rightarrow -\nabla, \quad \mathbf{j}(\mathbf{x}, t) \rightarrow -\mathbf{j}(-\mathbf{x}, t). \quad (2)$$

Electric fields change in sign while magnetic fields do not, and currents change in direction. Under T,

$$\mathbf{E}(\mathbf{x}, t) \rightarrow \mathbf{E}(\mathbf{x}, -t), \quad \mathbf{B}(\mathbf{x}, t) \rightarrow -\mathbf{B}(\mathbf{x}, -t), \quad (3)$$

$$\partial/\partial t \rightarrow -\partial/\partial t, \quad \mathbf{j}(\mathbf{x}, t) \rightarrow -\mathbf{j}(\mathbf{x}, -t). \quad (4)$$

Magnetic fields change in sign while electric fields do not, since directions of currents are reversed. Under C,

$$\mathbf{E}(\mathbf{x}, t) \rightarrow -\mathbf{E}(\mathbf{x}, t), \quad \mathbf{B}(\mathbf{x}, t) \rightarrow -\mathbf{B}(\mathbf{x}, t), \quad (5)$$

$$\rho(\mathbf{x}, t) \rightarrow -\rho(\mathbf{x}, t), \quad \mathbf{j}(\mathbf{x}, t) \rightarrow -\mathbf{j}(\mathbf{x}, t). \quad (6)$$

Both electric and magnetic fields change sign, since their sources ρ and \mathbf{j} change sign. Finally, under CPT, space and time are inverted but electric and magnetic fields retain their signs:

$$\mathbf{E}(\mathbf{x}, t) \rightarrow \mathbf{E}(-\mathbf{x}, -t), \quad \mathbf{B}(\mathbf{x}, t) = \mathbf{B}(-\mathbf{x}, -t). \quad (7)$$

A fundamental term in the Lagrangian behaving as $\mathbf{E} \cdot \mathbf{B}$, while Lorentz covariant, would violate P and T. Such a term seems to be strongly suppressed, in view of the small value of the neutron electric dipole moment. Its absence is a mystery, but several possible reasons have been proposed (see, e.g., [6]).

III. CP SYMMETRY FOR KAONS

Some neutral particles, such as the photon, the neutral pion, and the Z^0 , are their own antiparticles, while some – those carrying nonzero quantum numbers – are not. The neutral kaon K^0 , discovered in 1946 [7] in cosmic radiation, was assigned a “strangeness” quantum number $S = 1$ in the classification scheme of Gell-Mann and Nishijima [8] in order to explain its strong production and weak decay. Production would conserve strangeness, while the weaker decay process would not. For this scheme to make sense it was then necessary that there also exist an anti-kaon, the \bar{K}^0 , with $S = -1$.

As Gell-Mann described this scheme at a seminar at the University of Chicago, Enrico Fermi asked him what distinguished the \bar{K}^0 from the K^0 if both could decay to $\pi\pi$, as seemed to be observed. This question led Gell-Mann and Pais [9] to propose that the states of definite mass and lifetime were

$$K_1 = \frac{K^0 + \bar{K}^0}{\sqrt{2}} \quad (C = +), \quad (8)$$

$$K_2 = \frac{K^0 - \bar{K}^0}{\sqrt{2}} \quad (C = -), \quad (9)$$

$$(10)$$

with the K_1 allowed by C invariance (then thought to be a property of weak interactions) to decay to $\pi\pi$ and the K_2 forbidden to decay to $\pi\pi$. The K_2 would be allowed to decay only to three-body final states such as $\pi^+\pi^-\pi^0$ and thus would have a much longer lifetime. It was looked for and found in 1956 [10]. The discovery that the weak interactions violated C and P but apparently preserved the product CP [11] led to a recasting of the above argument through the identification $CP(K_1) = +(K_1)$, $CP(K_2) = -(K_2)$.

The K_1 - K_2 system can be illustrated using a degenerate two-state example such as a pair of coupled pendula [12] or the first excitations of a drum head. There is no way to distinguish between the basis states illustrated in Fig. 1(a), in which the nodal lines are at angles of $\pm 45^\circ$ with respect to the horizontal, and those in Fig. 1(b), in which they are horizontal and vertical.

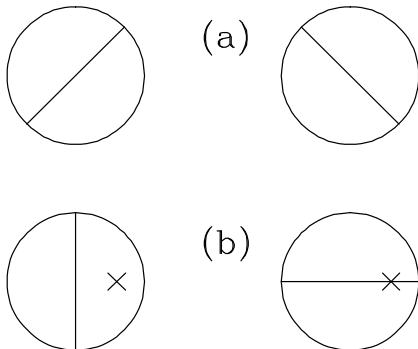

FIG. 1. Basis states for first excitations of a drum head. (a) Nodal lines at $\pm 45^\circ$ with respect to horizontal; (b) horizontal and vertical nodal lines.

If a fly lands on the drum-head at the point marked “x”, the basis (b) corresponds to eigenstates. One of the modes couples to the fly; the other doesn’t. The basis in (a) is like that of (K^0, \bar{K}^0) , while that in (b) is like that of (K_1, K_2) . Neutral kaons are produced as in (a), while they decay as in (b), with the fly analogous to the $\pi\pi$ state. The short-lived state (K_1 , in this CP-conserving approximation) has a lifetime of 0.089 ns, while the long-lived state ($\simeq K_2$) lives ~ 600 times as long, for 52 ns.

In 1964 Christenson, Cronin, Fitch, and Turlay [2] found that indeed one in about 500 long-lived neutral kaons *did* decay to $\pi^+\pi^-$, and one in about 1000 decayed to $\pi^0\pi^0$. The states of definite mass and lifetime could then be written, approximately, as

$$\begin{aligned} K_S \text{ (“short”) } &\simeq K_1 + \epsilon K_2, \\ K_L \text{ (“long”) } &\simeq K_2 + \epsilon K_1, \end{aligned} \quad (11)$$

with a parameter ϵ whose magnitude was about 2×10^{-3} and whose phase was about 45° . Since the states of definite mass and lifetime were no longer CP eigenstates, CP had to be violated *somewhere*. However, for many years ϵ was the only parameter describing CP violation. One could measure its magnitude and phase more and more precisely (including learning about $\text{Re}(\epsilon)$ through a study of charge asymmetries in $K_L \rightarrow \pi^\pm l^\mp \nu$), but its origin remained a mystery. One viable theory included a “superweak” one [13] which postulated a new interaction mixing $K^0 = d\bar{s}$ and $\bar{K}^0 = s\bar{d}$ but with no other consequences.

Kobayashi and Maskawa offered a new opportunity to describe CP violation by boldly postulating three quark families [4] when charm (the last member of the second family) had not yet even been firmly established. In the diagram of Fig. 2 describing the second-order weak transition $d\bar{s} \rightarrow s\bar{d}$ through intermediate states involving pairs of quarks $i, j = u, c, t$ with charges $2/3$, the phases of complex weak couplings can have physical effects. As long as there are at least three quark families, one cannot redefine quark phases so that all such couplings are real, and one can generate a nonzero value of ϵ .

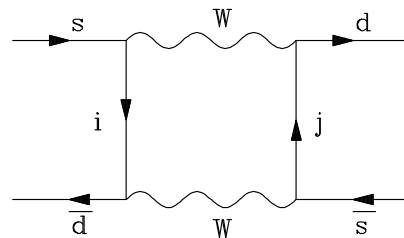

FIG. 2. Box diagram describing the second-order weak mixing of a $K^0 = d\bar{s}$ with a $\bar{K}^0 = s\bar{d}$. There is another diagram with vertical W^+W^- and horizontal quark-antiquark pairs $i, j = u, c, t$.

The time-dependence of the two-component K^0 and \bar{K}^0 system is governed by a 2×2 mass matrix \mathcal{M} [14]:

$$i \frac{\partial}{\partial t} \begin{bmatrix} K^0 \\ \bar{K}^0 \end{bmatrix} = \mathcal{M} \begin{bmatrix} K^0 \\ \bar{K}^0 \end{bmatrix}, \quad (12)$$

where $\mathcal{M} = M - i\Gamma/2$, and M and Γ are Hermitian matrices. The eigenstates (11) then correspond to the eigenvalues $\mu_{S,L} = m_{S,L} - i\gamma_{S,L}/2$, with

$$\epsilon \simeq \frac{\text{Im}(\Gamma_{12}/2) + i \text{Im} M_{12}}{\mu_S - \mu_L}. \quad (13)$$

Using data and the magnitude of CKM matrix elements one can show [14] that the second term dominates. Since the mass difference $m_L - m_S$ and width difference $\gamma_S - \gamma_L$ are nearly equal, the phase of $\mu_L - \mu_S$ is about $\pi/4$, so that the phase of ϵ is also $\pi/4 \pmod{\pi}$.

It is easy to model the CP-conserving neutral kaon system in table-top systems with two degenerate states

[12]. The demonstration of CP violation requires systems that emulate $\text{Im}(M_{12}) \neq 0$ or $\text{Im}(\Gamma_{12}) \neq 0$. One can couple two identical resonant circuits “directionally” to each other (see Fig. 3) so that the energy fed from circuit 1 to circuit 2 differs from that fed in the reverse direction [15]. Devices with this property utilize Faraday rotation of the plane of polarization of radio-frequency waves; some references may be found in [16]. This asymmetric coupling also is inherent in the equations of motion of a spherical (or “conical”) pendulum in a rotating coordinate system [17], so that the Foucault pendulum is a demonstration (though perhaps not “table-top”) of CP violation. A ball rolling with viscous damping in a rotating vase of elliptical cross section holds more promise for a laboratory setting [16]. In all such cases the CP-violating effect is imposed “from the outside,” leaving open the question of whether some “new physics” is governing the corresponding effect in particle physics.

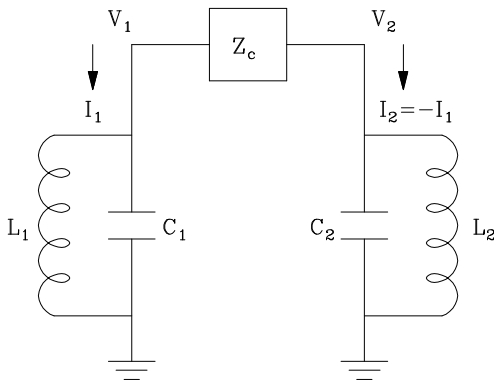

FIG. 3. Coupled “tank” circuits illustrating the $K^0 - \bar{K}^0$ system. The coupling impedance Z_c must be asymmetric to emulate CP violation.

IV. KOBAYASHI-MASKAWA THEORY OF CP VIOLATION

The interactions of quarks with W^\pm bosons are described by

$$\mathcal{L}_{\text{int}} = \frac{g}{\sqrt{2}} [\bar{U}'_L \gamma^\mu W_\mu^{(+)} D'_L + \text{H.c.}], \quad (14)$$

where the primed quarks are “weak eigenstates”:

$$U' \equiv \begin{bmatrix} u' \\ c' \\ t' \end{bmatrix}, \quad D' \equiv \begin{bmatrix} d' \\ s' \\ b' \end{bmatrix}. \quad (15)$$

In the weak-eigenstate basis, the mass term in the Lagrangian,

$$\mathcal{L}_m = -[\bar{U}'_R \mathcal{M}_U U'_L + \bar{D}'_L \mathcal{M}_D D'_L + \text{H.c.}], \quad (16)$$

will involve a general 3×3 matrix \mathcal{M} , which requires separate left and right unitary transformations

$$R_Q^\dagger \mathcal{M}_Q L_Q = \Lambda_Q \quad (17)$$

to obtain a diagonal matrix Λ_Q with non-negative entries. If we define unprimed (mass) eigenstates by

$$Q'_L = L_Q Q_L, \quad Q'_R = R_Q Q_R \quad (Q = U, D), \quad (18)$$

the interaction Lagrangian may be expressed as

$$\mathcal{L}_{\text{int}} = \frac{g}{\sqrt{2}} [\bar{U}_L \gamma^\mu W_\mu^{(+)} V D_L + \text{H.c.}], \quad (19)$$

where $V \equiv L_U^\dagger L_D$ is the Cabibbo-Kobayashi-Maskawa (CKM) matrix. As a result of its unitarity, $V^\dagger V = V V^\dagger = 1$, the $Zq\bar{q}$ couplings in the electroweak theory are flavor-diagonal. Since it contains no information about R_U or R_D , V provides only partial information about \mathcal{M}_Q .

For n u -type quarks and n d -type quarks, V is $n \times n$. Since it is unitary, it can be described by n real parameters. Relative quark phases account for $2n - 1$ of these, leaving $n^2 - (2n - 1) = (n - 1)^2$ physical parameters. Of these, $n(n - 1)/2$ (the number of independent rotations in n dimensions) correspond to angles, while the rest, $(n - 1)(n - 2)/2$, correspond to phases.

For $n = 2$, we have one angle and no phases. The matrix V then can always be chosen as orthogonal [5,18]. For $n = 3$, we have three angles and one phase, which in general cannot be eliminated by arbitrary choices of phases in the quark fields. It was this phase that motivated Kobayashi and Maskawa [4] to introduce a third quark doublet in 1973 when only two were known. (The bottom quark was discovered in 1977 [19], and the top in 1994 [20].) The Kobayashi-Maskawa theory provides a potential source of CP violation, serving as the leading contender for the observed CP-violating effects in the kaon system and suggesting substantial CP asymmetries in the decays of mesons containing b quarks. The pattern of charge-changing weak transitions among quarks is depicted in Fig. 4.

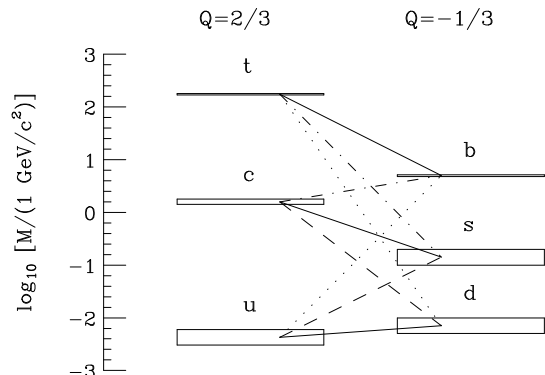

FIG. 4. Pattern of charge-changing weak transitions among quarks. Solid lines: relative strength 1; dashed lines: relative strength 0.22; dot-dashed lines: relative strength 0.04; dotted lines: relative strength ≤ 0.01 . Breadths of levels denote estimated errors in quark masses.

A convenient parametrization of the CKM matrix utilizes a hierarchy [21] whereby magnitudes of elements are approximately powers of $\lambda \equiv \sin \theta_c \simeq 0.22$, where θ_c is the Gell-Mann–Lévy–Cabibbo angle [5,22] describing strange particle decays. The matrix may be expressed as

$$V = \begin{bmatrix} 1 - \frac{\lambda^2}{2} & \lambda & A\lambda^3(\rho - i\eta) \\ -\lambda & 1 - \frac{\lambda^2}{2} & A\lambda^2 \\ A\lambda^3(1 - \rho - i\eta) & -A\lambda^2 & 1 \end{bmatrix}, \quad (20)$$

where rows denote u, c, t and columns denote d, s, b .

We learn $|V_{cb}| = A\lambda^2 \simeq 0.041 \pm 0.003$ from the dominant decays of b quarks, which are to charmed quarks [23,24]. Smaller errors are quoted in most reviews [25] which take different views of the dominantly theoretical sources of error. As an indication that this number is still in some flux we note a new measurement $|V_{cb}| = 0.046 \pm 0.004$ by the CLEO group [26].) Similarly, we shall take from charmless b decays $|V_{ub}/V_{cb}| = 0.090 \pm 0.025 = \lambda(\rho^2 + \eta^2)^{1/2}$ [27], leading to $\rho^2 + \eta^2 = 0.41 \pm 0.11$, whereas smaller errors are quoted by most authors.

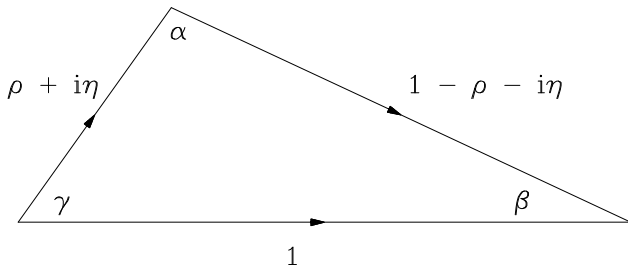

FIG. 5. Unitarity triangle for CKM elements. Here $\rho + i\eta = V_{ub}^*/A\lambda^3$; $1 - \rho - i\eta = V_{td}/A\lambda^3$.

As a result of the unitarity of the CKM matrix, the quantities $V_{ub}^*/A\lambda^3 = \rho + i\eta$, $V_{td}/A\lambda^3 = 1 - \rho - i\eta$, and 1 form a triangle in the (ρ, η) plane (Fig. 5). We still do not have satisfactory limits on the angle γ of this “unitarity triangle.” Further information comes from the following constraints:

1. *Mixing of neutral B mesons* is dominated by top quark contributions to graphs such as Fig. 2 but with external quarks $d\bar{b}$ for B^0 or $s\bar{b}$ for B_s . For example, the mass splitting in the nonstrange neutral B system is

$$\Delta m_d = 0.487 \pm 0.014 \text{ ps}^{-1} \sim f_B^2 B_B |V_{td}|^2, \quad (21)$$

where f_B is the B meson decay constant and $B_B = \mathcal{O}(1)$ is the “vacuum saturation factor,” describing the degree to which graphs such as Fig. 2 describe the mixing. Recent estimates [28] give $f_B \sqrt{B_B} = 230 \pm 40$ MeV. Consequently, one finds [23] $|1 - \rho - i\eta| = 0.87 \pm 0.21$. Neutral strange B mesons are characterized by [29]

$$\Delta m_s \sim f_{B_s}^2 B_{B_s} |V_{ts}|^2 > 15 \text{ ps}^{-1}. \quad (22)$$

Since $|V_{ts}| \simeq |V_{cb}|$ is approximately known, this information mainly serves to constrain the product $f_{B_s} \sqrt{B_{B_s}}$

and, given information on the ratio of strange and non-strange constants [30], the value of $|V_{td}|$, leading to $|1 - \rho - i\eta| < 1.01$. The large top mass, $m_t = 174 \pm 5$ GeV [31], is crucial for these mixings to be so large.

2. *CP-violating K^0 – \bar{K}^0 mixing* through the box graphs of Fig. 2 accounts for the parameter [31]

$$\epsilon = (2.27 \times 10^{-3}) e^{i43.3^\circ} \sim \text{Im} \mathcal{M}_{12} \sim f_K^2 B_K \text{Im}(V_{td}^2), \quad (23)$$

leading to a constraint [23,24]

$$\eta(1 - \rho + 0.39) = 0.35 \pm 0.12 \quad . \quad (24)$$

Here we have used $f_K = 161$ MeV and $B_K = 0.87 \pm 0.13$ [32]. If top quarks were fully dominant the left-hand side of this equation would be just $\eta(1 - \rho)$. The term 0.39 in brackets is a correction due to charmed quarks.

The constraints are plotted on the (ρ, η) plane in Fig. 6. Also shown are the $\pm 1\sigma$ bounds on $\sin 2\beta$, to be discussed presently, from an average 0.49 ± 0.23 [24] of OPAL, ALEPH, CDF, BaBar, and BELLE values. The allowed region is larger than that favored by many other analyses [25].

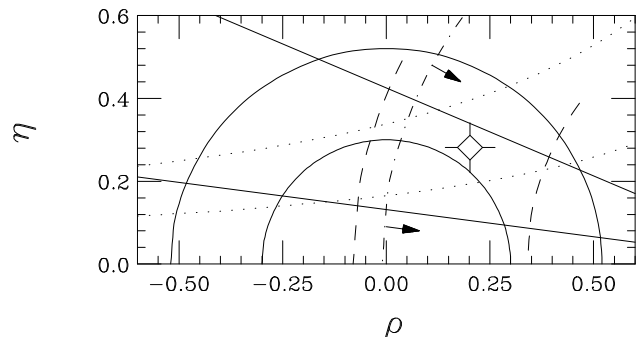

FIG. 6. Region of (ρ, η) specified by constraints on CKM matrix parameters. Solid semicircles denote limits based on $|V_{ub}/V_{cb}| = 0.090 \pm 0.025$; dashed arcs denote limits $0.66 \leq |1 - \rho - i\eta| \leq 1.08$ based on B^0 – \bar{B}^0 mixing; dot-dashed arc denotes limit $|1 - \rho - i\eta| < 1.01$ based on B_s – \bar{B}_s mixing; dotted lines denote limits $\eta(1 - \rho + 0.39) = 0.35 \pm 0.12$ based on CP-violating K^0 – \bar{K}^0 mixing. Rays: $\pm 1\sigma$ limits on $\sin 2\beta$ (see Sec. VI). The plotted point at $(\rho, \eta) \simeq (0.20, 0.28)$ lies roughly in the middle of the allowed region.

V. THE CKM MATRIX AND PREDICTIONS FOR KAON PHYSICS

A. $K_{S,L} \rightarrow \pi\pi$ rates

If we define

$$\eta_{+-} \equiv \frac{A(K_L \rightarrow \pi^+ \pi^-)}{A(K_S \rightarrow \pi^+ \pi^-)}, \quad \eta_{00} \equiv \frac{A(K_L \rightarrow \pi^0 \pi^0)}{A(K_S \rightarrow \pi^0 \pi^0)}, \quad (25)$$

the possibility of different CP-violating effects in $\pi\pi$ states of isospin $I_{\pi\pi} = 2$ and $I_{\pi\pi} = 0$ [33] gives rise

to a parameter ϵ' such that $\eta_{+-} = \epsilon + \epsilon'$, $\eta_{00} = \epsilon - 2\epsilon'$. The following ratio of ratios then can differ from unity:

$$R \equiv \frac{\Gamma(K_L \rightarrow \pi^+\pi^-)}{\Gamma(K_S \rightarrow \pi^+\pi^-)} / \frac{\Gamma(K_L \rightarrow \pi^0\pi^0)}{\Gamma(K_S \rightarrow \pi^0\pi^0)} = 1 + 6 \operatorname{Re} \frac{\epsilon'}{\epsilon}. \quad (26)$$

The ratio ϵ'/ϵ is expected to be approximately real in a CPT-invariant theory [14]. A key prediction of the KM theory is that ϵ'/ϵ should be a number of order 10^{-3} . Two types of amplitudes contribute to $K \rightarrow \pi\pi$ decays.

1. *Tree amplitudes*, involving the quark subprocess $s \rightarrow u\bar{u}d$, have both $\Delta I = 1/2$ and $\Delta I = 3/2$ components and thus contribute to both $I_{\pi\pi} = 0$ and $I_{\pi\pi} = 2$ states. In a standard convention [21], tree amplitudes contain no weak phases, since they involve the CKM elements V_{ud} and V_{us} .

2. *Penguin amplitudes*, involving the quark subprocess $s \rightarrow d$ with an intermediate loop consisting of a W boson and the quarks u , c , t , and interacting with the rest of the system through one or more gluons, have only $\Delta I = 1/2$ and thus can only contribute to the $I_{\pi\pi} = 0$ state. The top quark in the loop gives rise to a weak phase through the CKM element V_{td} .

A relative weak phase of $I_{\pi\pi} = 0$ and $I_{\pi\pi} = 2$ states is thus generated in the KM theory, leading to $\epsilon'/\epsilon \neq 0$. *Electroweak* penguin amplitudes, in which the gluon connecting the $s \rightarrow d$ subprocess to the rest of the diagram is replaced by a photon or Z^0 , can have both $\Delta I = 1/2$ and $\Delta I = 3/2$ components and tend to reduce the predicted value of ϵ'/ϵ . One range of estimates [34] finds a broad and somewhat asymmetric probability distribution extending from slightly below zero to above 2×10^{-3} . Others (see articles in [35]) permit slightly higher values.

Recent experiments on $\operatorname{Re}(\epsilon'/\epsilon)$ [36–39] are summarized in Table II. (The error in the average includes a scale factor [31] of 1.86.) The magnitude of ϵ'/ϵ is consistent with estimates based on the Kobayashi-Maskawa theory. The qualitative agreement is satisfactory, given that we still cannot account reliably for the large enhancement of $\Delta I = 1/2$ amplitudes with respect to $\Delta I = 3/2$ amplitudes in *CP-conserving* $K \rightarrow \pi\pi$ decays. More data are expected from the Fermilab and CERN experiments, reducing the eventual statistical error on ϵ'/ϵ to a part in 10^4 .

TABLE II. Recent experimental values for $\operatorname{Re}(\epsilon'/\epsilon)$.

Experiment	Reference	Value ($\times 10^{-4}$)	$\Delta\chi^2$
Fermilab E731	[36]	7.4 ± 5.9	3.97
CERN NA31	[37]	23.0 ± 6.5	0.35
Fermilab E832	[38]	28.0 ± 4.1	4.65
CERN NA48	[39]	14.0 ± 4.3	1.44
Average		19.2 ± 4.6	$\Sigma = 10.4$

B. $K \rightarrow \pi^+l^-$ information

1. *The decay* $K^+ \rightarrow \pi^+\nu\bar{\nu}$ involves loop diagrams involving V_{td} and a small charm correction in such a way that the combination $|1.4 - \rho - i\eta|$ is constrained, with a predicted branching ratio of order

$$\mathcal{B}(K^+ \rightarrow \pi^+\nu\bar{\nu}) \simeq 10^{-10} \left| \frac{1.4 - \rho - i\eta}{1.4} \right|^2, \quad (27)$$

or for the range permitted in Fig. 6, a branching ratio of about $(0.8 \pm 0.2) \times 10^{-10}$ [40]. Additional uncertainties are associated with m_c [41] and $|V_{cb}|$. A measurement of $\mathcal{B}(K^+ \rightarrow \pi^+\nu\bar{\nu})$ to 10% will help to constrain (ρ, η) more tightly than in Fig. 6 or will expose inconsistencies in our present picture of CP violation.

Up to now the Brookhaven E787 Collaboration sees only one $K^+ \rightarrow \pi^+\nu\bar{\nu}$ event with negligible background [42], corresponding to

$$\mathcal{B}(K^+ \rightarrow \pi^+\nu\bar{\nu}) = (1.5_{-1.2}^{+3.4}) \times 10^{-10}. \quad (28)$$

More data are expected from the final analysis of this experiment, as well as from a future version with improved sensitivity.

2. *The decays* $K_L \rightarrow \pi^0l^+l^-$ should be dominated by CP-violating contributions, both indirect ($\sim \epsilon$) and direct, with a CP-conserving ‘‘contaminant’’ from $K_L \rightarrow \pi^0\gamma\gamma \rightarrow \pi^0l^+l^-$. The direct contribution probes the parameter η . Each contribution (including the CP-conserving one) is expected to correspond to a $\pi^0e^+e^-$ branching ratio of a few parts in 10^{12} . However, $K_L \rightarrow \pi^0e^+e^-$ may be limited by backgrounds in the $\gamma\gamma e^+e^-$ final state associated with radiation of a photon in $K_L \rightarrow \gamma e^+e^-$ from one of the leptons [43]. Present experimental upper limits (90% c.l.) [44] are

$$\mathcal{B}(K_L \rightarrow \pi^0e^+e^-) < 5.1 \times 10^{-10},$$

$$\mathcal{B}(K_L \rightarrow \pi^0\mu^+\mu^-) < 3.8 \times 10^{-10}, \quad (29)$$

still significantly above most theoretical expectations. (See, however, [45].)

3. *The decay* $K_L \rightarrow \pi^0\nu\bar{\nu}$ should be due entirely to CP violation, and provides a clean probe of η . Its branching ratio, proportional to $A^4\eta^2$, is expected to be about 3×10^{-11} . The best current experimental upper limit (90% c.l.) for this process [46] is $\mathcal{B}(K_L \rightarrow \pi^0\nu\bar{\nu}) < 5.9 \times 10^{-7}$, several orders of magnitude above the expected value.

C. Other rare kaon decays

1. *The decay* $K_L \rightarrow \pi^+\pi^-e^+e^-$ involves three independent momenta in the final state and thus offers the opportunity to observe a T-odd observable through a characteristic distribution in the angle ϕ between the $\pi^+\pi^-$ and e^+e^- planes. A CP- or T-violating angular asymmetry in this process has recently been reported [47,48].

2. The decay $K_L \rightarrow \mu^+ \mu^- \gamma$ has been studied with sufficiently high statistics to permit a greatly improved measurement of the virtual-photon form factor in $K_L \rightarrow \gamma^* \gamma$ [49]. This measurement is useful in estimating the long-distance contribution to the real part of the amplitude in $K_L \rightarrow \gamma^{(*)} \gamma^{(*)} \rightarrow \mu^+ \mu^-$, which in turn allows one to limit the short-distance contribution to $K_L \rightarrow \mu^+ \mu^-$.

D. Is the CKM picture of CP violation correct?

The KM theory is comfortable with the observed range of ϵ'/ϵ , and its prediction for $\mathcal{B}(K^+ \rightarrow \pi^+ \nu \bar{\nu})$ is consistent with the one event seen so far. Further anticipated tests are the measurement η through the decay $K_L \rightarrow \pi^0 \nu \bar{\nu}$ (see below), and the search for CP violation in hyperon decays, which is already under way [50,51]. One also looks forward to a rich set of effects in decays of particles containing b quarks, particularly B mesons. We now describe the experiments and the effects they are expected to see.

VI. CP VIOLATION IN B DECAYS

A. Current and planned experiments

Asymmetric e^+e^- collisions are being studied at “ B factories”: the PEP-II machine at SLAC with the BaBar detector, and the KEK-B collider in Japan with the Belle detector. By July 2000, these detectors had accumulated about 14 and 6 fb^{-1} of data at the energy of the $\Upsilon(4S)$ resonance, which decays almost exclusively to $B\bar{B}$ [52,53]. As of September, 2000, PEP-II and KEK-B were providing about 150 and 100 pb^{-1} per day to their respective detectors.

Further data on e^+e^- collisions at the $\Upsilon(4S)$ will be provided by the Cornell Electron Storage Ring with the upgraded CLEO-III detector. The HERA-b experiment at DESY in Hamburg hopes to study b quark production via the collisions of 920 GeV protons with a fixed target. The CDF and D0 detectors at Fermilab will devote a significant part of their program at Run II of the Tevatron to B physics. One can expect further results on B physics from the general-purpose LHC detectors ATLAS and CMS, and the dedicated detectors at LHC-b at CERN and BTeV at Fermilab.

B. Types of CP violation

In contrast to neutral kaons, whose mass eigenstates differ in lifetime by nearly a factor of 600, the corresponding $B^0-\bar{B}^0$ mass eigenstates are predicted to differ in lifetime by at most 10–20% for strange B 's [54,55], and much less for nonstrange B 's. Thus, instead of mass eigenstates like K_L , two main types of B decays are of

interest: decays to CP eigenstates, and “self-tagging” decays. Both have their advantages and disadvantages.

1. *Decays to CP eigenstates* $f = \pm \text{CP}(f)$ utilize interference between direct decays $B^0 \rightarrow f$ or $\bar{B}^0 \rightarrow \bar{f}$ and the corresponding paths involving mixing: $B^0 \rightarrow \bar{B}^0 \rightarrow f$ or $\bar{B}^0 \rightarrow B^0 \rightarrow \bar{f}$. Final states such as $f = J/\psi K_S$ provide examples in which one quark subprocess is dominant. In this case one measures $\sin 2\beta$ with negligible corrections. For $f = \pi^+ \pi^-$, one would measure $\sin 2\alpha$ only if the direct decay were dominated by a “tree” amplitude (the quark subprocess $b \rightarrow u\bar{u}d$). With contamination from the penguin subprocess $b \rightarrow d$ expected to be about 30% in amplitude, one must measure decays to other $\pi\pi$ states (such as $\pi^\pm \pi^0$ and $\pi^0 \pi^0$) to sort out amplitudes [56]. In decays to CP eigenstates, one must determine the flavor of the decaying B at time of production.

2. “*Self-tagging*” decays involve final states f such as $K^+ \pi^-$ which can be distinguished from their CP-conjugates \bar{f} . A CP-violating rate asymmetry arises when two weak amplitudes a_i with weak phases ϕ_i and strong phases δ_i ($i = 1, 2$) interfere:

$$\begin{aligned} A(B \rightarrow f) &= a_1 e^{i(\phi_1 + \delta_1)} + a_2 e^{i(\phi_2 + \delta_2)} \quad , \\ A(\bar{B} \rightarrow \bar{f}) &= a_1 e^{i(-\phi_1 + \delta_1)} + a_2 e^{i(-\phi_2 + \delta_2)} \quad . \end{aligned} \quad (30)$$

The weak phase changes sign under CP-conjugation, while the strong phase does not. The rate asymmetry is then

$$\begin{aligned} \mathcal{A}(f) &\equiv \frac{\Gamma(f) - \Gamma(\bar{f})}{\Gamma(f) + \Gamma(\bar{f})} \\ &= \frac{2a_1 a_2 \sin(\phi_1 - \phi_2) \sin(\delta_1 - \delta_2)}{a_1^2 + a_2^2 + 2a_1 a_2 \cos(\phi_1 - \phi_2) \cos(\delta_1 - \delta_2)} \quad . \end{aligned} \quad (31)$$

The two amplitudes must have different weak *and* strong phases in order for a rate asymmetry to be observable. The CKM theory predicts the weak phases, but no reliable estimates of strong phases exist. We shall note some ways to avoid this problem.

C. Decays to CP eigenstates

The interference between direct and mixing terms in B decays to CP eigenstates modulates the exponential decay (see, e.g., [57]):

$$\frac{d\Gamma(t)}{dt} \sim e^{-\Gamma t} (1 \mp \text{Im} \lambda_0 \sin \Delta m t), \quad (32)$$

where the upper sign refers to B^0 decays and the lower to \bar{B}^0 decays. Δm is the mass splitting, and λ_0 expresses the interference of decay and mixing amplitudes. For $f = J/\psi K_S$, $\lambda_0 = -e^{-2i\beta}$, while for $f = \pi^+ \pi^-$, $\lambda_0 \simeq e^{2i\alpha}$ only to the extent that penguin amplitudes can be neglected in comparison with the dominant tree

contribution. The time integral of the modulation term is

$$\int_0^\infty dt e^{-\Gamma t} \sin \Delta m t = \frac{1}{\Gamma} \frac{x}{1+x^2} \leq \frac{1}{\Gamma} \cdot \frac{1}{2}, \quad (33)$$

where $x \equiv \Delta m/\Gamma$. This expression is maximum for $x = 1$, and 96% of maximum for the observed value $x \simeq 0.76$.

The CDF Collaboration [58] “tags” neutral B mesons at the time of their production and measures the decay rate asymmetry in $B^0 (\overline{B}^0) \rightarrow J/\psi K_S$. This asymmetry arises from the phase 2β characterizing the two powers of V_{td} in the B^0 - \overline{B}^0 mixing amplitude. The tagging methods are of two main types. In “opposite-side” methods, since strong interactions produce b and \bar{b} in pairs, one learns the initial flavor of a decaying B from the “other” b -containing hadron produced in association with it. “Same-side” methods [59] utilize the fact that a B^0 tends to be associated more frequently with a π^+ , and a \overline{B}^0 with a π^- , somewhere nearby in phase space.

Electron-positron collisions provide B mesons in pairs at the c.m. energy of the $\Upsilon(4S)$ resonance, just above threshold, in states of negative charge-conjugation eigenvalue. It then becomes necessary to distinguish the vertices of the decaying and tagging B 's from one another when studying CP eigenstates. If t and t' denote the decay and tagging proper times, the asymmetry for decay to a CP eigenstate will be proportional to $\sin \Delta m(t-t')$, which vanishes when integrated over all times (see, e.g., [24] or [62]). The BaBar and BELLE results were obtained using asymmetric e^+e^- collisions, with typical vertex separations of about 250 μm and 200 μm . PEP-II, constructed in the ring of the old PEP machine, collides 9 GeV electrons with 2.7 GeV positrons, while KEK-B, constructed in the TRISTAN tunnel, collides 8.5 GeV electrons with 3.5 GeV positrons. In symmetric collisions the $\Upsilon(4S)$ is produced at rest and the proper path length of a decaying B is only about 30 μm .

TABLE III. Samples reported in July 2000 by BaBar and BELLE Collaborations relevant to measurement of $\sin 2\beta$.

Collab.	Final state	Number	No. tagged
BaBar	$J/\psi K_S \rightarrow J/\psi \pi^+ \pi^-$	121	85 (50 B^0 , 35 \overline{B}^0)
	$J/\psi K_S \rightarrow J/\psi \pi^0 \pi^0$	19	12 (7 B^0 , 5 \overline{B}^0)
	$\psi' K_S \rightarrow J/\psi \pi^+ \pi^-$	28	23 (13 B^0 , 10 \overline{B}^0)
	Total	168	120
BELLE	CP-odd modes	92	52 (40 $J/\psi K_S$)
	$J/\psi K_L$	102	42
	$J/\psi \pi^0$	10	4
	Total	204	98

Both BaBar and BELLE used tags based on leptons and kaons from B decays. BaBar also used two neural net methods. The samples reported by the summer of 2000 [52,53] are shown in Table III.

The CDF result and ones from OPAL [60] and ALEPH [61] utilizing B 's produced in the decays of the Z^0 are compared with those from BaBar and BELLE in Table IV. The average [24] corresponds to the $\pm 1\sigma$ rays plotted in Fig. 6. There is no contradiction (yet!) with the allowed region, but we look forward eagerly to reduced errors from BaBar and BELLE. New results are due to be presented in February of 2001.

D. “Self-tagging” decays

A typical “self-tagging” mode suitable for the study of “direct” CP violation is $B^0 \rightarrow K^+ \pi^-$. The tree amplitude [Fig. 7(a)] involves the quark subprocess $\bar{b} \rightarrow \bar{s} u \bar{u}$ with CKM factor $V_{ub}^* V_{us}$ (weak phase γ). The penguin amplitude [Fig. 7(b)] $\bar{b} \rightarrow \bar{s}$ with intermediate u, c, t quarks has CKM factor $V_{tb}^* V_{ts}$ or $V_{cb}^* V_{cs}$ (weak phase π or 0), depending on how the unitarity of the CKM matrix is used. The relative weak phase between the tree and penguin amplitudes thus is non-zero, and direct CP violation can arise if the relative strong phase $\delta_T - \delta_P$ also is non-zero. The interpretation of a rate difference $\Gamma(B^0 \rightarrow K^+ \pi^-) \neq \Gamma(\overline{B}^0 \rightarrow K^- \pi^+)$ requires independent information on $\delta_T - \delta_P$.

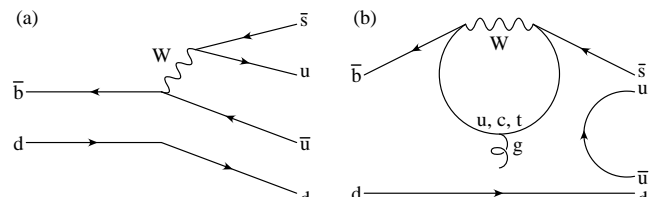

FIG. 7. Contributions to $B^0 \rightarrow K^+ \pi^-$. (a) Color-favored “tree” amplitude $\sim V_{ub}^* V_{us}$; (b) “penguin” amplitude $\sim V_{tb}^* V_{ts}$.

TABLE IV. Values of $\sin 2\beta$ implied by recent measurements of the CP-violating asymmetry in $B^0 \rightarrow J/\psi K_S$.

Experiment	Value
OPAL [60]	$3.2_{-2.0}^{+1.8} \pm 0.5$
CDF [58]	$0.79_{-0.44}^{+0.41}$
ALEPH [61]	$0.84_{-1.04}^{+0.82} \pm 0.16$
BaBar [52]	$0.12 \pm 0.37 \pm 0.09$
BELLE [53]	$0.45_{-0.44-0.09}^{+0.43+0.07}$
Average	0.49 ± 0.23

If one measures both a CP-violating asymmetry and a rate ratio such as $\Gamma(B \rightarrow K^\pm \pi^\mp)/\Gamma(B^\pm \rightarrow K\pi^\pm)$ or $\Gamma(B^\pm \rightarrow K^\pm \pi^0)/\Gamma(B^\pm \rightarrow K\pi^\pm)$, one can eliminate the strong phase difference and solve for γ [63–65]. One must deal with electroweak penguins (which also affected the interpretation of ϵ'/ϵ). One proposal (see the first of Refs. [63]) to extract γ from the rates for $B^+ \rightarrow (\pi^0 K^+, \pi^+ K^0, \pi^+ \pi^0)$ and the charge-conjugate processes was flawed by the neglect of these contributions, which are important [66]. However, they can be calculated [65], so that measurements of the rates for these processes can yield useful information on γ .

A necessary condition for the observability of direct CP asymmetries based on the interference of two amplitudes, one weaker than the other, is that one must be able to detect processes at the level of the absolute square of the weaker amplitude [67]. Let the weak phase difference $\Delta\phi$ and the strong phase difference $\Delta\delta$ both be near $\pm\pi/2$ (the most favorable case). Then the rate asymmetry \mathcal{A} in Eq. (31) has magnitude

$$|\mathcal{A}| = \mathcal{O}\left(\frac{2A_1 A_2}{A_1^2 + A_2^2}\right) \simeq \frac{2A_2}{A_1} \quad \text{for } A_2 \ll A_1. \quad (34)$$

Define a rate based on the square of each amplitude: $N_i = \text{const. } |A_i|^2$. Then $|\mathcal{A}| \simeq 2\sqrt{N_2/N_1}$.

The statistical error in \mathcal{A} is based on the total number of events. For $A_2 \ll A_1$, one has $\delta\mathcal{A} \simeq 1/\sqrt{N_1}$. Then the significance of the asymmetry (in number of standard deviations) is

$$\left|\frac{\mathcal{A}}{\delta\mathcal{A}}\right| \sim \mathcal{O}(2\sqrt{N_2}). \quad (35)$$

Thus (aside from the factor of 2) one must be able to see the *square of the weaker amplitude* at a significant level in order to see a significant asymmetry due to A_1 – A_2 interference.

In searching for direct CP asymmetries one thus considers B decays with at least two amplitudes having an expected weak phase difference, with a large enough rate that the smaller amplitude alone would be detectable, and with a good chance for a strong phase difference.

Many branching ratios for charmless B decays are one to several parts in 10^5 . Rates associated with the subdominant amplitudes are expected to be $\lambda^2 \simeq 1/20$ of these. Thus when sensitivities to branching ratios of a few parts in 10^7 are reached, searches for direct CP asymmetries will take on great significance.

Two processes whose rates favor a weak phase γ exceeding 90° are $B^0 \rightarrow \pi^+ \pi^-$ and $B^0 \rightarrow K^{*+} \pi^-$ [65,68,69], which favor destructive and constructive tree-penguin interference, respectively. A fit to these and other processes in the second of Refs. [69] finds $\gamma = (114_{-23}^{+24})^\circ$, grazing the allowed region of Fig. 6 but inconsistent with some more restrictive fits [25]. Since the upper bound on γ is set by the limit on B_s – \bar{B}_s mixing, $\Delta m_s > 15 \text{ ps}^{-1}$, such mixing should be visible soon. There is a hint of a signal at $\sim 17 \text{ ps}^{-1}$ [29].

The Tevatron and the LHC will produce many neutral B 's decaying to $\pi^+ \pi^-$, $K^\pm \pi^\mp$, and $K^+ K^-$ [70]. Each of these channels has particular advantages.

1. *The decays $B^0 \rightarrow K^+ K^-$ and $B_s \rightarrow \pi^+ \pi^-$* should be suppressed unless these final states are “fed” by rescattering from other channels [71].

2. *The decays $B^0 \rightarrow \pi^+ \pi^-$ and $B_s \rightarrow K^+ K^-$* can yield γ via time-dependence measurements [72].

3. *A recent proposal for measuring γ* [73] utilizes the decays $B^0 \rightarrow K^+ \pi^-$, $B^+ \rightarrow K^0 \pi^+$, $B_s \rightarrow K^- \pi^+$, and the corresponding charge-conjugate processes. The $B^0 \rightarrow K^+ \pi^-$ and $B_s \rightarrow K^- \pi^+$ peaks are well separated from one another and from $B^0 \rightarrow \pi^+ \pi^-$ and $B_s \rightarrow K^+ K^-$ kinematically [70].

The proposal of Ref. [73] is based on the observation that $B \rightarrow K\pi$ decays involve tree (T) and penguin (P) amplitudes with relative weak phase γ and relative strong phase δ . The decays $B^\pm \rightarrow K\pi^\pm$ are expected to be dominated by the penguin amplitude (there is no tree contribution except through rescattering from other final states), so this channel is not expected to display any CP-violating asymmetries. The prediction $\Gamma(B^+ \rightarrow K^0 \pi^+) = \Gamma(B^- \rightarrow \bar{K}^0 \pi^-)$ thus will check the assumption that rescattering effects can be neglected. A typical amplitude is given by $A(B^0 \rightarrow K^+ \pi^-) = -[P+T e^{i(\gamma+\delta)}]$, where the signs are associated with phase conventions for states [74]. Defining

$$\left\{ \begin{array}{l} R \\ A_0 \end{array} \right\} \equiv \frac{\Gamma(B^0 \rightarrow K^+ \pi^-) \pm \Gamma(\bar{B}^0 \rightarrow K^- \pi^+)}{2\Gamma(B^+ \rightarrow K^0 \pi^+)}, \quad (36)$$

$$\left\{ \begin{array}{l} R_s \\ A_s \end{array} \right\} \equiv \frac{\Gamma(B_s \rightarrow K^- \pi^+) \pm \Gamma(\bar{B}_s \rightarrow K^+ \pi^-)}{2\Gamma(B^+ \rightarrow K^0 \pi^+)}, \quad (37)$$

and $r \equiv T/P$, $\tilde{\lambda} \equiv V_{us}/V_{ud}$, one finds

$$R = 1 + r^2 + 2r \cos \delta \cos \gamma,$$

$$R_s = \tilde{\lambda}^2 + (r/\tilde{\lambda})^2 - 2r \cos \delta \cos \gamma, \quad (38)$$

$$A_0 = -A_s = -2r \sin \gamma \sin \delta. \quad (39)$$

The sum of R and R_s allows one to determine r . Using R , r , and A_0 , one can solve for both δ and γ . The prediction $A_s = -A_0$ checks the flavor SU(3) assumption on which these relations are based. An error of 10° on γ seems feasible with forthcoming Tevatron data.

Recent upper limits on CP-violating asymmetries in B decays to light-quark systems [75], defined as

$$\mathcal{A}_{CP} \equiv \frac{\Gamma(\bar{B} \rightarrow \bar{f}) - \Gamma(B \rightarrow f)}{\Gamma(\bar{B} \rightarrow \bar{f}) + \Gamma(B \rightarrow f)}, \quad (40)$$

are shown in Table V. No significant asymmetries have been seen, but sensitivities adequate to check the maximum predicted values [76] $|\mathcal{A}_{CP}^{K^+ \pi^-}| \leq 1/3$ are being approached.

TABLE V. CP-violating asymmetries in decays of B mesons to light quarks.

Mode	Signal events	\mathcal{A}_{CP}
$K^+\pi^-$	80^{+12}_{-11}	-0.04 ± 0.16
$K^+\pi^0$	$42.1^{+10.9}_{-9.9}$	-0.29 ± 0.23
$K_S\pi^+$	$25.2^{+6.4}_{-5.6}$	$+0.18 \pm 0.24$
$K^+\eta'$	100^{+13}_{-12}	$+0.03 \pm 0.12$
$\omega\pi^+$	$28.5^{+8.2}_{-7.3}$	-0.34 ± 0.25

VII. THE ROLE OF CHARM

A. Mixing and CP violation

The dominant decay modes of the neutral charmed mesons D^0 and \overline{D}^0 are to states of negative and positive strangeness, respectively, and not to CP eigenstates. Thus D^0 - \overline{D}^0 mixing induced by shared final states is expected to be small. Short-distance contributions to mixing also are expected to be small. Thus, in contrast to the case of neutral kaons and B mesons, one expects small mass splittings, $\Delta m/\Gamma \ll 1$, and, in contrast to neutral kaons, also small width differences. The degree to which cancellations among contributions of intermediate states such as $\pi^+\pi^-$, K^+K^- , and $K^\pm\pi^\mp$ to mixing suppress such effects further is a matter of debate [77]. If any rate difference is expected, it would be in the direction favoring a slightly greater rate for the CP-even mass eigenstate.

CP violation in the charm sector is expected to be small in the Standard Model. It is also easy to look for, since D mesons are easier to produce than B mesons and the Standard Model background is low.

Recent interesting studies of mixing by the CLEO [78] and FOCUS [79] Collaborations hint at the possibility of non-zero values of Δm , $\Delta\Gamma$, or both, but are not yet statistically compelling. No evidence for mixing is found by the Fermilab E791 Collaboration [80]. It may be necessary to invoke large final-state phase differences in order to reconcile the CLEO and FOCUS results [81]. No CP-violating asymmetries have been seen in charmed meson decays at the level of several percent [80,82].

B. Spectroscopy

A wide variety of excited $cq\bar{q}$ and $c\bar{q}$ states are accessible at CLEO and FOCUS. The $cq\bar{q}$ states are providing unique insights into baryon spectroscopy [83–85], while the $c\bar{q}$ states [86,87], are important sources of information about the corresponding $b\bar{q}$ states, useful for “same-side” tagging of neutral B mesons.

VIII. THE FUTURE

A. Envisioned measurements

Future CP studies involve a broad program of experiments with kaons, charmed and B mesons, and neutrinos.

1. *Rare kaon decays:* Measurement of the branching ratio for $K_L \rightarrow \pi^0\nu\bar{\nu}$ at the required sensitivity ($\mathcal{B} \simeq 3 \times 10^{-3}$) is foreseen at Brookhaven National Laboratory [88] and the Fermilab Main Injector [89]. A Fermilab proposal [90] seeks to acquire enough events of $K^+ \rightarrow \pi^+\nu\bar{\nu}$ to measure $|V_{td}|$ to a precision of 10%.

2. *Charmed mesons:* While great strides have been taken in the measurement of mass and lifetime differences for CP eigenstates of the neutral charmed mesons D^0 , [78,79], it would be worth while to follow up present hints of nonzero effects. Both electron-positron colliders and hadronic experiments devoted to future B studies may also have more to say about mixing, lifetime differences, and CP violation for charmed mesons.

3. *B production in symmetric e^+e^- collisions:* Although asymmetric e^+e^- colliders are now taking data at an impressive rate, the CLEO Collaboration is continuing with an active program. It will be able to probe charmless B decays down to branching ratios of 10^{-6} . It may be able to detect the elusive $B^0 \rightarrow \pi^0\pi^0$ mode, whose rate will help pin down the penguin amplitude’s contribution and permit a determination of the CKM phase α [56]. Other final states of great interest at this level include VP and VV , where P, V denote light pseudoscalar and vector mesons. A useful probe of rescattering effects [71] is the decay $B^0 \rightarrow K^+K^-$. This decay is expected to have a branching ratio of only a few parts in 10^8 if rescattering is unimportant, but could be enhanced by more than an order of magnitude in the presence of rescattering from other channels. A challenging but crucial channel is $B^+ \rightarrow \tau^+\bar{\nu}_\tau$, whose rate will provide information on the combination $f_B|V_{cb}|$. Rare decays such as $B \rightarrow X\ell^+\ell^-$ and $B \rightarrow X\nu\bar{\nu}$ will probe the effects of new particles in loops.

4. *B production in asymmetric e^+e^- collisions:* The BaBar and Belle detectors have made a start at the measurement of $\sin 2\beta$ in $B^0 \rightarrow J/\psi K_S$. The moving center-of-mass facilitates both flavor tagging and improvement of signal with respect to background. These machines will make possible a host of time-dependent studies in such decays as $B \rightarrow \pi\pi$, $B \rightarrow K\pi$, etc., and their impressive luminosities will eventually add significantly to the world’s tally of detected B ’s.

5. *Hadronic B production:* The strange B ’s cannot be produced at the $\Upsilon(4S)$ which will dominate the attention of e^+e^- colliders for some years to come. Hadronic reactions at high energies will produce copious b ’s incorporated into nonstrange, strange, and charmed mesons, and baryons. A measurement of the strange- B mixing parameter Δm_s is likely to be made soon. B_s decays provide valuable information on CKM phases and CP vio-

lation, as in $B_s \rightarrow K^+K^-$ [72]. The width difference expected between the CP-even and CP-odd eigenstates of the B_s system [54,55] should be visible in the next round of experiments.

6. *Neutrino studies:* The magnitudes and phases in the CKM matrix are connected with the quark masses themselves, whose pattern we will not understand until we have mapped out a similar pattern for the leptons. We will learn much about neutrino masses and mixings from forthcoming experiments at the Sudbury Neutrino Observatory [91], Borexino [92], K2K [93], and Fermilab (BooNE and MINOS) [94].

B. A likely parameter space

Our knowledge of the Cabibbo-Kobayashi-Maskawa is likely to improve over the next few years [95,96]. With $\sin(2\beta)$ measured in $B^0 \rightarrow J/\psi K_S$ decays to an accuracy of ± 0.06 (the BaBar goal with 30 fb^{-1} [62]), errors on $|V_{ub}/V_{cb}|$ reduced to 10%, strange- B mixing bounded by $x_s = \Delta m_s/\Gamma_s > 20$ (the present bound is already better than this!), and $\mathcal{B}(B^+ \rightarrow \tau^+\nu_\tau)$ measured to $\pm 20\%$ (giving $f_B|V_{ub}|$, or $|V_{ub}/V_{td}|$ when combined with $B^0-\overline{B}^0$ mixing), one finds the result shown in Fig. 8.

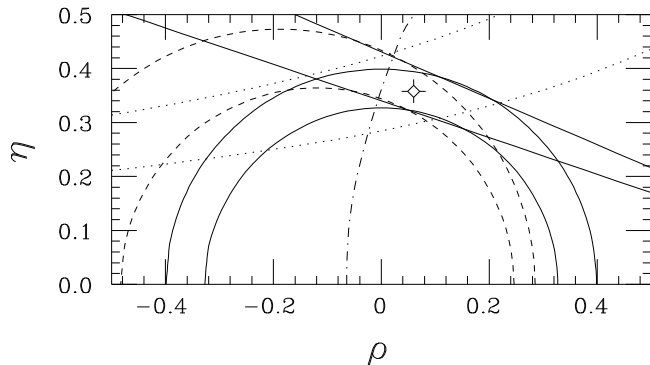

FIG. 8. Plot in (ρ, η) of anticipated constraints on CKM parameters in the year 2003. Solid curves: $|V_{ub}/V_{cb}|$; dashed lines: constraint on $|V_{ub}/V_{td}|$ by combining measurement of $\mathcal{B}(B^+ \rightarrow \tau^+\nu_\tau)$ with $B^0-\overline{B}^0$ mixing; dotted lines: constraint due to ϵ_K (CP-violating $K^0-\overline{K}^0$ mixing); dash-dotted line: limit due to x_s ; solid rays: measurement of $\sin 2\beta$ to ± 0.06 .

The narrow range of (ρ, η) increases the chance that any non-standard physics will show up as a contradiction among various measurements, most likely by providing additional contributions to $B^0-\overline{B}^0$ mixing [97] but possibly directly affecting decays [98].

C. Baryon number of the Universe

The number of baryons in the Universe is much larger than the corresponding number of antibaryons. Sakharov proposed [99] three requirements for this preponderance

of matter over antimatter: (1) an epoch in which the Universe was not in thermal equilibrium, (2) an interaction violating baryon number, and (3) CP (and C) violation. The observed baryon asymmetry is not explained directly by the CP violation in the CKM matrix; the effects are too small, requiring some new physics. Two examples are the following:

1. *Supersymmetry*, in which each particle of spin J has a “superpartner” of spin $J \pm 1/2$, affords many opportunities for introducing new CP-violating phases and interactions which could affect particle-antiparticle mixing [100].

2. *Neutrino masses at the sub-eV level* can signal large right-handed neutrino Majorana masses, exceeding 10^{11} GeV [101]. Lepton number (L), violated by such masses, can be reprocessed into baryon number (B) by $B-L$ conserving interactions at the electroweak scale [102]. New CP-violating interactions must exist at the high mass scale if lepton number is to be generated there. These interactions could be related to CKM phases [103]. If this alternative is correct, it will be important to understand the leptonic analogue of the CKM matrix!

D. Surprises ahead?

The CKM theory of CP violation in neutral kaon decays has passed a crucial test. The parameter ϵ'/ϵ is nonzero, and has the expected order of magnitude. Tests using B mesons, including the observation of a difference in rates between $B^0 \rightarrow J/\psi K_S$ and $\overline{B}^0 \rightarrow J/\psi K_S$, are just around the corner. Progress in “tagging” neutral B ’s and rich information from measurements of many B decay rates will round out the picture.

If B decays do not provide a consistent set of CKM phases in the next few years, we will re-examine other proposed sources of CP violation. Most of these, in contrast to the CKM theory, predict neutron and electron dipole moments very close to their present experimental upper limits. If, however, the CKM picture remains self-consistent, we should ask about the origin of the CKM phases and the associated quark and lepton masses. It is probably time to start anticipating this possibility, given the resilience of the CKM picture since it was first proposed nearly 30 years ago.

I am looking forward to a surprise such as one encountered many years ago when exploring a small cave in Pennsylvania. We had entered it in the afternoon and thought we had seen all its rooms, when I came upon another chamber with ghostly stalactites silhouetted against the darkness behind them. A breeze of warm air signaled that I was actually looking outside, with the “stalactites” the faintly glowing night sky, and the dark spaces the shadows of pine trees. Such a “perception shift” does not come often, but is a welcome source of wonder.

IX. ACKNOWLEDGMENTS

It is a pleasure to thank Adriano Natale and Rogério Rosenfeld for the invitation to attend the Brazilian Meeting of Particles and Fields and for their wonderful hospitality in Sao Paulo and Sao Lourenço, and Patrick Roudeau for constructive correspondence. This work was supported in part by the United States Department of Energy under Grant No. DE FG02 90ER40560.

* Invited talk presented at XXI Brazilian National Meeting on Particles and Fields, Sao Lourenço, Minas Gerais, October 23–26, 2000, proceedings to be published in a special issue of the Brazilian Journal of Physics. Enrico Fermi Institute Report No. EFI 01-01, hep-ph/0101033.

- [1] J. L. Rosner, in *Particle Physics and Cosmology: 2nd Tropical Workshop*, edited by Jose F. Nieves (New York, American Institute of Physics, 2000), pp. 283–304.
- [2] J. H. Christenson, J. W. Cronin, V. L. Fitch, and R. Turlay, *Phys. Rev. Lett.* **13**, 138-140 (1964).
- [3] J. Schwinger, *Phys. Rev.* **91**, 713-728 (1953); *Phys. Rev.* **94**, 1362-1384 (1954); G. Lüders, *Kong. Danske Vid. Selsk., Matt-fys. Medd.* **28**, No. 5, 1-17 (1954); *Ann. Phys. (N.Y.)* **2**, 1-15 (1957); W. Pauli, in *Niels Bohr and the Development of Physics*, edited by W. Pauli (Pergamon, New York, 1955), pp. 30-51.
- [4] M. Kobayashi and T. Maskawa, *Prog. Theor. Phys.* **49**, 652-657 (1973).
- [5] N. Cabibbo, *Phys. Rev. Lett.* **10**, 531-532 (1963).
- [6] S. M. Barr, in *TASI 94: CP Violation and the Limits of the Standard Model*, Boulder, CO, 29 May – 24 June 1994, edited by J. F. Donoghue (World Scientific, River Edge, NJ, 1995), pp. 87-111.
- [7] G. D. Rochester and C. C. Butler, *Nature* **160**, 855-857 (1947).
- [8] M. Gell-Mann, *Phys. Rev.* **92**, 833-834 (1953); “On the Classification of Particles,” 1953 (unpublished); M. Gell-Mann and A. Pais, in *Proceedings of the 1954 Glasgow Conference on Nuclear and Meson Physics*, edited by E. H. Bellamy and R. G. Moorhouse (Pergamon, London and New York, 1955); M. Gell-Mann, *Nuovo Cim.* **4**, Suppl. 848-866 (1956); T. Nakano and K. Nishijima, *Prog. Theor. Phys.* **10**, 581-582 (1953); K. Nishijima, *Prog. Theor. Phys.* **12**, 107-108 (1954); *Prog. Theor. Phys.* **13**, 285–304 (1955).
- [9] M. Gell-Mann and A. Pais, *Phys. Rev.* **97**, 1387-1389 (1955).
- [10] K. Lande, E. T. Booth, J. Impeduglia, and L. M. Lederman, *Phys. Rev.* **103**, 1901-1904 (1956).
- [11] T. D. Lee, R. Oehme, and C. N. Yang, *Phys. Rev.* **106**, 340-345 (1957); L. D. Landau, *Nucl. Phys.* **3**, 127-131 (1957).
- [12] B. Winstein, in *Festi-Val – Festschrift for Val Telegdi*, ed. by K. Winter (Elsevier, Amsterdam, 1988), pp. 245-265.
- [13] L. Wolfenstein, *Phys. Rev. Lett.* **13**, 562-564 (1964).
- [14] For reviews, see, e.g., R. G. Sachs, *The Physics of Time Reversal Invariance* (University of Chicago Press, Chicago, 1988); K. Kleinknecht, in *CP Violation*, edited by C. Jarlskog (World Scientific, Singapore, 1989), pp. 41-104; J. L. Rosner, in *Testing the Standard Model* (Proceedings of the 1990 Theoretical Advanced Study Institute in Elementary Particle Physics, Boulder, Colorado, 3–27 June, 1990), edited by M. Cvetič and P. Langacker (World Scientific, Singapore, 1991), pp. 91-224; B. Winstein and L. Wolfenstein, *Rev. Mod. Phys.* **63**, 1113-1148 (1992); G. C. Branco, L. Lavoura, and J. P. Silva, *CP Violation* (Oxford, 1999); I. I. Bigi and A. I. Sanda, *CP Violation* (Cambridge, 2000).
- [15] J. L. Rosner, *Am. J. Phys.* **64**, 982-985 (1996).
- [16] V. A. Kostelecký and Á. Roberts, Indiana University preprint IUHET 428, hep-ph/0012381 (unpublished).
- [17] J. L. Rosner and S. A. Slezak, *Am. J. Phys.* **69**, 44-49 (2001).
- [18] J. D. Bjorken and S. L. Glashow, *Phys. Lett.* **11**, 255-257 (1964); Y. Hara, *Phys. Rev.* **134**, B701-B704 (1964); Z. Maki and Y. Ohnuki, *Prog. Theor. Phys.* **32**, 144-158 (1964); S. L. Glashow, J. Iliopoulos, and L. Maiani, *Phys. Rev. D* **2**, 1285-1292 (1970).
- [19] Fermilab E288 Collaboration, S. W. Herb *et al.*, *Phys. Rev. Lett.* **39**, 252-255 (1977); W. R. Innes *et al.*, *Phys. Rev. Lett.* **39**, 1240-1242,1640(E) (1977).
- [20] CDF Collaboration, F. Abe *et al.*, *Phys. Rev. D* **50**, 2966-3026 (1994); **51**, 4623-4637 (1994); **52**, 2605-2609 (1995); *Phys. Rev. Lett.* **73**, 225-231 (1994); **74**, 2626-2631 (1995); D0 Collaboration, S. Abachi *et al.*, *Phys. Rev. Lett.* **72**, 2138-2142 (1994); **74**, 2422-2426 (1995); **74**, 2632-2637 (1995); *Phys. Rev. D* **52**, 4877-4919 (1995).
- [21] L. Wolfenstein, *Phys. Rev. Lett.* **51**, 1945-1947 (1983).
- [22] M. Gell-Mann and M. Lévy, *Nuovo Cim.* **16**, 705-725 (1960).
- [23] J. L. Rosner, Enrico Fermi Institute Report No. EFI 2000-42, hep-ph/0011184. To be published in Proceedings of Beauty 2000, Kibbutz Maagan, Israel, September 13–18, 2000, edited by S. Erhan, Y. Rozen, and P. E. Schlein, *Nucl. Inst. Meth. A*, 2001.
- [24] J. L. Rosner, Enrico Fermi Institute Report No. EFI 2000-47, hep-ph/0011355. To be published in *Flavor Physics for the Millennium* (Proceedings of the TASI-2000 Summer School, Boulder, CO, June 5–30, 2000), edited by J. L. Rosner (World Scientific, Singapore, 2001).
- [25] F. Gilman, K. Kleinknecht, and Z. Renk, mini-review on pp. 110-114 of Particle Data Group, C. Caso *et al.*, *Eur. Phys. J. C* **15**, 1-878 (2000); A. Ali and D. London, DESY report DESY-00-026, hep-ph/0002167, in *Proceedings of the 3rd Workshop on Physics and Detectors for DAPHNE*, Frascati, Italy, Nov. 16–19, 1999, edited by S. Bianco *et al.* (INFN, 1999), pp. 3–23; S. Stone, Conference Summary, Beauty 2000, hep-ex/0012162, to be published in Proceedings of Beauty 2000 [23]; M. Ciuchini *et al.*, Orsay preprint LAL 00-77, hep-ex/0012308, to be submitted to JHEP.

- [26] CLEO Collaboration, J. P. Alexander *et al.*, CLEO-CONF 00-3, presented at Osaka Conference XXX International Conference on High Energy Physics, Osaka, Japan, July 27 – August 2, 2000.
- [27] A. F. Falk, in *Proceedings of the XIXth International Symposium on Lepton and Photon Interactions*, Stanford, California, August 9–14 1999, edited by J. Jaros and M. Peskin (World Scientific, Singapore, 2000), Electronic Conference Proceedings **C990809**, 174 (2000).
- [28] C. Sachrajda, to be published in *Proceedings of Beauty 2000* [23].
- [29] D. Abbaneo, presented at Conference on Heavy Quarks at Fixed Target, Rio de Janeiro, Oct. 9–19, 2000, hep-ex/0012010. Current world averages for nonstrange and strange neutral B mixing amplitudes may be found in <http://www.cern.ch/LEPBOSC/>.
- [30] J. L. Rosner, *Phys. Rev. D* **42**, 3732-3740 (1990).
- [31] Particle Data Group, C. Caso *et al.*, *Eur. Phys. J. C* **15**, 1-878 (2000).
- [32] V. Lubicz, Invited Talk at the XX *Physics in Collision Conference*, June 29 – July 1, 2000, Lisbon, Portugal, Univ. of Rome III report RM3-TH/00-15, hep-ph/0010171.
- [33] Bose statistics forbid a spinless $\pi\pi$ state with $I = 1$.
- [34] A. J. Buras, M. Jamin, and M. E. Lautenbacher, *Phys. Lett. B* **389**, 749-756 (1996).
- [35] See the articles on ϵ'/ϵ by A. J. Buras, S. Bertolini, R. Gupta, G. Martinelli, and W. A. Bardeen in *Kaon Physics*, edited by J. L. Rosner and B. Winstein (University of Chicago Press, 2001).
- [36] Fermilab E731 Collaboration, L. K. Gibbons *et al.*, *Phys. Rev. Lett.* **70**, 1203-1206 (1993); *Phys. Rev. D* **55**, 6625-6715 (1997).
- [37] CERN NA31 Collaboration, G. D. Barr *et al.*, *Phys. Lett. B* **317**, 233-242 (1993).
- [38] Fermilab E832/KTeV Collaboration, A. Alavi-Harati *et al.*, *Phys. Rev. Lett.* **83**, 22-27 (1999).
- [39] NA48 Collaboration, G. D. Barr *et al.*, presented at CERN seminar by A. Ceccucci, Feb. 29, 2000 (unpublished). Follow the links on <http://www.cern.ch/NA48/> for a copy of the transparencies.
- [40] G. Buchalla and A. J. Buras, *Nucl. Phys.* **B548**, 309-327 (1999); G. Buchalla, in *Kaon Physics* [35].
- [41] A. F. Falk, A. Lewandowski, and A. A. Petrov, Cornell Univ. report CLNS-00-1707, hep-ph/0012099.
- [42] Brookhaven E787 Collaboration, S. Adler *et al.*, *Phys. Rev. Lett.* **84**, 3768-3770 (2000).
- [43] H. B. Greenlee, *Phys. Rev. D* **42**, 3724-3731 (1990).
- [44] Fermilab E-799-II/KTeV Collaboration, A. Alavi-Harati *et al.*, preprint hep-ex/0011093 ($\pi^0 e^+ e^-$), *Phys. Rev. Lett.* **84**, 5279-8282 (2000) ($\pi^0 \mu^+ \mu^-$).
- [45] P. Ko, *Phys. Rev. D* **44**, 139-165 (1991).
- [46] Fermilab E-799-II/KTeV Collaboration, A. Alavi-Harati *et al.*, *Phys. Rev. D* **61**, 072006 (2000).
- [47] Fermilab E-799-II/KTeV Collaboration, A. Alavi-Harati *et al.*, *Phys. Rev. Lett.* **84**, 408-411 (2000).
- [48] NA48 Collaboration, A. Lai *et al.*, *Phys. Lett. B* **496**, 137-144 (2000).
- [49] KTeV Collaboration, G. Breese Quinn, Ph. D. Thesis, University of Chicago, May, 2000 (unpublished).
- [50] CLEO Collaboration, D. E. Jaffe *et al.*, Cornell University report CLNS-98-1587, hep-ex/0009037 (unpublished).
- [51] Fermilab E756 Collaboration, K. B. Luk *et al.*, *Phys. Rev. Lett.* **85**, 4860 (2000).
- [52] BaBar Collaboration, reported by D. Hitlin at Osaka Conf. [26], hep-ex/0011024.
- [53] BELLE Collaboration, reported by H. Aihara at Osaka Conf. [26], hep-ex/0010008.
- [54] M. Beneke, G. Buchalla, and I. Dunietz, *Phys. Rev. D* **54**, 4419-4431 (1996).
- [55] D. Becirevic *et al.*, *Eur. Phys. J. C* **18**, 157-166 (2000).
- [56] M. Gronau and D. London, *Phys. Rev. Lett.* **65**, 3381-3384 (1990).
- [57] I. Dunietz and J. L. Rosner, *Phys. Rev. D* **34**, 1404-1417 (1986).
- [58] CDF Collaboration, T. Affolder *et al.*, *Phys. Rev. D* **61**, 072005 (2000).
- [59] M. Gronau, A. Nippe, and J. L. Rosner, *Phys. Rev. D* **47**, 1988-1993 (1993); M. Gronau and J. L. Rosner, *Phys. Rev. Lett.* **72**, 195-198 (1994); *Phys. Rev. D* **49**, 254-264 (1994); Technion report TECHNION-PH-2000-27, hep-ph/0010238, *Phys. Rev. D* **63**, 0540XX (2001).
- [60] OPAL Collaboration, K. Ackerstaff *et al.*, *Eur. Phys. J. C* **5**, 379-388 (1998).
- [61] ALEPH Collaboration, R. Barate *et al.*, *Phys. Lett. B* **492**, 259-274 (2000).
- [62] *The BaBar Physics Book: Physics at an Asymmetric B Factory*, edited by P. F. Harrison and H. R. Quinn, SLAC Report SLAC-504, 1998.
- [63] M. Gronau, J. Rosner and D. London, *Phys. Rev. Lett.* **73**, 21-24 (1994); M. Gronau and J. L. Rosner, *Phys. Rev. Lett.* **76**, 1200-1203 (1996); *Phys. Rev. D* **57**, 6843-6850 (1998); A. S. Dighe, M. Gronau, and J. L. Rosner, *Phys. Rev. D* **54**, 3309-3320 (1996); A. S. Dighe and J. L. Rosner, **54**, 4677-4679 (1996); M. Gronau and D. Pirjol, *Phys. Lett. B* **449**, 321-327 (1999); *Phys. Rev. D* **61**, 013005 (2000).
- [64] R. Fleischer, *Phys. Lett. B* **365**, 399-406 (1996); *Phys. Rev. D* **58**, 093001 (1998); R. Fleischer and T. Mannel, *Phys. Rev. D* **57**, 2752-2759 (1998); A. J. Buras, R. Fleischer, and T. Mannel, *Nucl. Phys.* **B533**, 3-24 (1998); R. Fleischer and A. J. Buras, *Eur. Phys. J. C* **11**, 93-109 (1999); A. J. Buras and R. Fleischer, *Eur. Phys. J. C* **16**, 97-104 (2000).
- [65] M. Neubert and J. L. Rosner, *Phys. Lett. B* **441**, 403-409 (1998); *Phys. Rev. Lett.* **81**, 5076-5079 (1998); M. Neubert, *JHEP* **9902**, 014 (1999).
- [66] N. G. Deshpande and X.-G. He, *Phys. Rev. Lett.* **74**, 26-29 (1995); **74**, 4099(E) (1995); O. F. Hernández, D. London, M. Gronau, and J. L. Rosner, *Phys. Rev. D* **52**, 6374-6382 (1995).
- [67] G. Eilam, M. Gronau, and J. L. Rosner, *Phys. Rev. D* **39**, 819-824 (1989).
- [68] M. Gronau and J. L. Rosner, *Phys. Rev. D* **61**, 073008 (2000).
- [69] X.-G. He, W.-S. Hou, and K.-C. Yang, *Phys. Rev. Lett.* **83**, 1100-1103 (1999); W.-S. Hou, J. G. Smith, and F. Würthwein, preprint hep-ex/9910014 (unpublished).
- [70] F. Würthwein and R. Jesik, talks for Working Group 1

- presented at Workshop on B Physics at the Tevatron – Run II and Beyond, Fermilab, February 2000 (unpublished).
- [71] B. Blok, M. Gronau, and J. L. Rosner, *Phys. Rev. Lett.* **78**, 3999-4002 (1997); **79**, 1167 (1997); A. Falk, A. L. Kagan, Y. Nir, and A. A. Petrov, *Phys. Rev. D* **57**, 4290-4300 (1998); M. Gronau and J. L. Rosner, *Phys. Rev. D* **57**, 6843-6350 (1998); **58**, 113005 (1998); R. Fleischer, *Phys. Lett. B* **435**, 221-232 (1998); *Eur. Phys. J. C* **6**, 451-470 (1999).
- [72] R. Fleischer, *Phys. Lett. B* **459**, 306-320 (1999); *Eur. Phys. J. C* **16**, 87-95 (2000). See also I. Dunietz, *Proceedings of the Workshop on B Physics at Hadron Accelerators*, Snowmass, CO, 1993, pp. 83–96; D. Pirjol, *Phys. Rev. D* **60**, 054020 (1999).
- [73] M. Gronau and J. L. Rosner, *Phys. Lett. B* **482**, 71-76 (2000).
- [74] M. Gronau, O. F. Hernández, D. London and J. L. Rosner, *Phys. Rev. D* **50**, 4529-4543 (1994).
- [75] CLEO Collaboration, S. Chen *et al.*, *Phys. Rev. Lett.* **85**, 525-529 (2000).
- [76] M. Gronau and J. L. Rosner, *Phys. Rev. D* **59**, 113002 (1999).
- [77] H. Georgi, *Phys. Lett. B* **297**, 353-357 (1992); L. Wolfenstein, *Phys. Lett. B* **164**, 170-172 (1985); *Phys. Rev. Lett.* **75**, 2460-2461 (1995); J. Donoghue, E. Golowich, B. R. Holstein, and J. Trampetić, *Phys. Rev. D* **33**, 179-183 (1986).
- [78] CLEO Collaboration, R. Godang *et al.*, *Phys. Rev. Lett.* **84**, 5038-5042 (2000).
- [79] FOCUS Collaboration, J. M. Link, *et al.*, *Phys. Lett. B* **485**, 62-70 (2000); Fermilab preprint FERMILAB-PUB-00-341-E, hep-ex/0012048.
- [80] Fermilab E791 Collaboration, presented by A. J. Schwartz, Univ. of Cincinnati report UCTP-112-00, hep-ex/0012006 (unpublished); J. A. Appel, hep-ex/0002022, in *Proceedings of the 3rd Workshop on Physics and Detectors for DAPHNE* [25], pp. 231–247.
- [81] A. F. Falk, Y. Nir, and A. A. Petrov, *JHEP* **12**, 019 (1999); S. Bergmann, Y. Grossman, Z. Ligeti, Y. Nir and A. A. Petrov, *Phys. Lett. B* **486**, 418-425 (2000); I. I. Bigi and N. G. Uraltsev, *Nucl. Phys.* **B592**, 92-106 (2000).
- [82] See, e.g., FOCUS Collaboration, J. M. Link *et al.*, *Phys. Lett. B* **491**, 232-239 (2000); **495**, 443(E) (2000).
- [83] CLEO Collaboration, D. Cronin-Hennessy *et al.*, Cornell University report CLNS 00-1695, hep-ex/0010035.
- [84] CLEO Collaboration, M. Artuso *et al.*, Cornell University report CLNS 00-1698, hep-ex/0010080.
- [85] CLEO Collaboration, S. E. Csorna *et al.*, Cornell University report CLNS 00-1702, hep-ex/0012020.
- [86] CLEO Collaboration, S. Anderson *et al.*, *Nucl. Phys.* **A663**, 647-650 (2000).
- [87] FOCUS Collaboration, presented by F. L. Fabbri at Osaka Conf. [26], hep-ex/0011044; presented by C. Ricciardi, *Nucl. Phys.* **A663**, 651-654 (2000).
- [88] KOPIO Collaboration, in *Rare Symmetry Violating Processes*, proposal to the National Science Foundation, October 1999, and Brookhaven National Laboratory Proposal P926 (unpublished).
- [89] KAMI Collaboration, Fermilab Proposal P804 (unpublished).
- [90] CKM Collaboration, Fermilab Proposal P905.
- [91] SNO Collaboration, presented by R. van de Water in *Particle Physics and Cosmology: 2nd Tropical Workshop* [1], pp. 193-200.
- [92] See the description of this experiment at <http://almime.mi.infn.it/>
- [93] Super-Kamiokande Collaboration, presented by M. Vagins in *Particle Physics and Cosmology: 2nd Tropical Workshop* [1], pp. 122-192.
- [94] NuTeV Collaboration, presented by J. Conrad in *Particle Physics and Cosmology: 2nd Tropical Workshop* [1], pp. 331-340; M. Shaevitz, *ibid.*, pp. 105-121.
- [95] J. L. Rosner, *Nucl. Phys. B Proc. Suppl.* **73**, 29-42 (1999).
- [96] P. Burchat *et al.*, Report of the NSF Elementary Particle Physics Special Emphasis Panel on B Physics, July, 1998 (unpublished).
- [97] See, e.g., C. O. Dib, D. London, and Y. Nir, *Int. J. Mod. Phys. A* **6**, 1253-1266 (1991); M. Gronau and D. London, *Phys. Rev. D* **55**, 2845-2861 (1997).
- [98] Y. Grossman and M. P. Worah, *Phys. Lett. B* **395**, 241-249 (1997); Y. Grossman, G. Isidori, and M. P. Worah, *Phys. Rev. D* **58**, 057504 (1998).
- [99] A. D. Sakharov, *Pis'ma Zh. Eksp. Teor. Fiz.* **5**, 32-35 (1967) [*JETP Lett.* **5**, 24-27 (1967)].
- [100] M. P. Worah, *Phys. Rev. D* **56**, 2010-2018 (1997); *Phys. Rev. Lett.* **79**, 3810-3813 (1997); M. Carena, M. Quiros, A. Riotto, I. Vilja, and C. E. M. Wagner, *Nucl. Phys.* **B503**, 387-404 (1997); M. P. Worah, in *Kaon Physics* [35].
- [101] P. Ramond, in *Particle Physics and Cosmology: 2nd Tropical Workshop* [1], pp. 75-90.
- [102] G. 't Hooft, *Phys. Rev. Lett.* **37**, 8-11 (1976); M. Fukugita and T. Yanagida, *Phys. Lett. B* **174**, 45-47 (1986); M. A. Luty, *Phys. Rev. D* **45**, 455-465 (1992); M. Plümacher, *Zeit. Phys. C* **74**, 549-559 (1997); W. Buchmüller and M. Plumacher, *Phys. Lett. B* **389**, 73–77 (1996); **431**, 354-362 (1998); *Phys. Rep.* **320**, 329–339 (1999).
- [103] J. L. Rosner, in *The Albuquerque Meeting* (Proceedings of the 8th Meeting, Division of Particles and Fields of the American Physical Society, Aug. 2–6, 1994, The University of New Mexico), edited by S. Seidel (World Scientific, Singapore, 1995), pp. 321-350; M. P. Worah, *Phys. Rev. D* **53**, 3902-3912 (1996).