

PM/95-31
June 1995

Residual New Physics Effects in e^+e^- and $\gamma\gamma$ Collisions¹

F.M. Renard

Physique Mathématique et Théorique, CNRS-URA 768,
Université de Montpellier II, F-34095 Montpellier Cedex 5.

Contribution to 17th International Symposium on Lepton-Photon
Interactions, Beijing, Aug. 1995

Abstract

We present a set of studies concerning the description of New Physics (NP) effects characterized by a scale much higher than the electroweak scale. We show that both present experimental results and several types of theoretical considerations about the Standard Model (SM) and NP suggest a hierarchy among the sectors in which NP manifestations should appear. We concentrate on residual effects described by effective lagrangians involving bosonic and/or heavy quark fields. For each operator we propose an unambiguous definition of the NP scale given by the energy at which unitarity is saturated. We also consider the possible existence of Higher Vector Bosons. We then study the tests realizable at present and future colliders. We start from the analysis of the high precision tests at Z peak, discussing separately the constraints obtained from the light fermionic sector and those due to the $b\bar{b}$ sector. We then consider the process $e^+e^- \rightarrow f\bar{f}$ at higher energies (LEP2 and NLC) and we propose the "Z peak subtracted representation" which allows to automatically take into account Z peak constraints and to describe several types of NP effects at any other energy. Applications to various NP effects (Higher Vector Bosons, Technicolour resonances, Anomalous Gauge Boson couplings) are given. We then concentrate on several bosonic processes, $e^+e^- \rightarrow W^+W^-$, HZ , $H\gamma$, and $\gamma\gamma$ collisions producing boson pairs or a single Higgs. We study the sensitivities to the various operators involved in the effective lagrangian and we propose ways to disentangle them. The NP scales which can be felt vary from a few TeV at LEP2 up to 200 TeV in single H production at NLC.

¹Partially supported by the EC contract CHRX-CT94-0579.

1 Introduction

New Physics (NP) is a generic word designing unknown dynamical features that would solve all problems and deficiencies of the Standard Model (SM). The nature of NP is an opened question. Extensions of SM by a gauge group, extensions of the minimal scalar Higgs sector, Supersymmetry, alternative descriptions of mass generation, Grand Unified schemes and other new concepts (superstrings),.... are popular examples.

Present experiments, in particular the high precision tests performed at Z peak and at low energies have excluded a modification of the SM structure of the light leptons and quarks at a few per mille level[1]. This can be interpreted by saying that NP is characterized by a scale Λ_{NP} much larger than M_Z , at least in this light fermionic sector. On another hand the most acute theoretical problem of SM concerns the mass generation mechanism[2], i.e. the scalar sector which generates the longitudinal W_L , Z_L states as well as the heavy (t , b) quark sector. These facts are driving us to the search for NP manifestations in these latter sectors.

We shall stick to the assumption that Λ_{NP} is higher than the energies reachable by present and nearby future experiments, so that no new particles can be produced. The only NP manifestations should then consist in modifications of the interactions among usual particles that are called residual effects. The net result is the appearance of modified SM couplings among usual particles, of departures from the SM values of the standard gauge couplings, and the existence of new coupling forms. They are described by an effective lagrangian \mathcal{L}_{eff} corresponding to the integration of all heavy (of order Λ_{NP}) degrees of freedom. The form, a priori unknown, of \mathcal{L}_{eff} is restricted by general principles like Lorentz and $U(1)_{EM}$ invariance and by the dimension of the operators used to construct it. In practice the high value of the NP scale should favor the $dim = 6$ operators[3]. Each operator is associated to a coupling constant and we have shown [4], [5],[6], that its value is related to the energy at which unitarity is saturated. This energy value can be considered as an unambiguous definition of the NP scale as it should correspond to the threshold for new particle creation.

Further assumptions can reduce the number of operators. Recently it has been advocated [7] that in order to preserve all "good features" of the SM, a broken gauge invariance scenario has to be kept. Before Symmetry Breaking (SB) applies, L_{eff} should be $SU(2) \times U(1)$ gauge invariant. When the dimension is limited as mentioned above, this is an important restriction, otherwise it is always possible to write any Lorentz and $U(1)_{EM}$ invariant lagrangian into an $SU(2) \times U(1)$ gauge invariant one by taking suitable combinations of scalar fields with other fields[8]. At this point let us however notice that there exist possibilities of extended gauge invariant pictures which do not fall into this class of structures. At low energies they induce explicit SB breaking. See for example the so-called strong $SU(2)_V$ extensions[9]. For simplicity we shall not consider these possibilities in this report.

We have also studied [10],[6], how \mathcal{L}_{eff} is generated by specific NP structures, for example when one integrates out the effects of new heavy fermions or new heavy bosons. We have observed that it seems easier to generate stronger anomalous couplings for Higgs

bosons than for gauge bosons. A hierarchy is then appearing for NP effects which puts ahead the scalar sector, followed by the gauge boson sector and the heavy quark sector and finally the light quark sector which is already very strongly constrained by present experiments.

Another possible manifestation of NP in the bosonic sector is through the existence of higher vector bosons. The effects of a higher Z' are of two kinds, direct modifications of the Z couplings through $Z - Z'$ mixing and addition of Z' exchange diagrams, that we shall also describe in an effective way as a modification of the SM amplitudes for photon and Z exchange. We have recently reexamined both of these effects [11], [12], [13].

After shortly presenting, in Section 2, the tools that we used for treating these various NP manifestations, I discuss in Section 3 the tests that can be done at present and future colliders with the expected sensitivities to each type of effect and I present, in Section 4, the landscape of NP which comes as an output.

2 Higher Vector Bosons and Effective Lagrangians

a) Higher Neutral Vector Bosons Z'

The existence of Higher Vector Bosons is predicted in various extensions of the SM (E_6 grand unified schemes, Right-Left symmetry) or alternatives (compositeness inspired schemes). No direct production has yet occurred (a limit of the order of $M_V > 500\text{GeV}$ has been set at Fermilab[14]).

We are interested in the indirect limits that can be set on neutral vector bosons (generically called Z') in e^+e^- collisions. They come in two ways. Firstly, a Z' exchange diagram can be added to the γ and Z one in e^+e^- annihilation into fermion pairs. Its effect will directly depend on the vector and axial couplings of the Z' and on its mass $M_{Z'}$. We have shown [13] that this effect can be described as a modification of the initial and final γ, Z couplings and treated together with the 1-loop description of the SM amplitude at any q^2 . I shall discuss the results in Section 3.

However the Z' may be only weakly coupled to fermion-antifermion. This arises in several alternative models for mass generation (Technicolour, Compositeness, $SU(2)_V$ extensions,...). In this case their existence can be searched through their bosonic couplings (W^+W^-) or through several types of modifications they may induce on γ, W, Z properties. For example $Z - Z'$ mixing through loop effects or through genuine mass-mixing can modify Z couplings. As they have been very accurately measured at LEP1, strong constraints on the mixing angle θ_M has been established [11]. We shall come back to these quantitative limits in Section 3.

b) Effective Lagrangian in the Bosonic Sector

Following the assumption that the strongest NP residual effects lie in the bosonic sector, and that they are characterized by a high scale, we have concentrated our study on operators of $dim = 6$, $SU(2) \times U(1)$ gauge invariant and involving only W, Z, γ and H . The full list involves 17 operators[15], [6]. They have been first classified according to the

way they affect the various sectors. Eight non blind operators, 4 CP-conserving ones \mathcal{O}_{DW} , \mathcal{O}_{DB} , \mathcal{O}_{BW} , $\mathcal{O}_{\Phi 1}$ and 4 CP-violating ones $\overline{\mathcal{O}}_W$, $\overline{\mathcal{O}}_{W\Phi}$, $\overline{\mathcal{O}}_{B\Phi}$, $\overline{\mathcal{O}}_{BW}$ affect the light fermionic sector and are severely constrained by Z peak as well as low energy measurements. Two superblind ones $\mathcal{O}_{\Phi 2}$, $\mathcal{O}_{\Phi 3}$, do not affect fermions neither pure gauge bosons couplings but only Higgs couplings to themselves or to gauge bosons, and are therefore difficult to observe experimentally. We shall concentrate on the seven blind ones which are not affecting the light fermions but produce anomalous gauge boson couplings and anomalous Higgs-gauge boson couplings. We shall also consider $\mathcal{O}_{\Phi 2}$ which can affect the process $e^+e^- \rightarrow HZ$. This set of eight operators is listed below.

The first one produce only anomalous gauge boson couplings

$$\mathcal{O}_W = \frac{1}{3!} \left(\vec{W}_\mu^\nu \times \vec{W}_\nu^\lambda \right) \cdot \vec{W}_\lambda^\mu \quad (1)$$

The next two ones produce both anomalous gauge boson couplings and anomalous Higgs-gauge boson couplings

$$\mathcal{O}_{W\Phi} = i (D_\mu \Phi)^\dagger \vec{\tau} \cdot \vec{W}^{\mu\nu} (D_\nu \Phi) \quad , \quad (2)$$

$$\mathcal{O}_{B\Phi} = i (D_\mu \Phi)^\dagger B^{\mu\nu} (D_\nu \Phi) \quad , \quad (3)$$

whereas the four other ones produce anomalous Higgs couplings but no pure gauge-boson couplings.

$$\mathcal{O}_{UW} = \frac{1}{v^2} \left(\Phi^\dagger \Phi - \frac{v^2}{2} \right) \vec{W}^{\mu\nu} \cdot \vec{W}_{\mu\nu} \quad , \quad (4)$$

$$\mathcal{O}_{UB} = \frac{4}{v^2} \left(\Phi^\dagger \Phi - \frac{v^2}{2} \right) B^{\mu\nu} B_{\mu\nu} \quad , \quad (5)$$

$$\overline{\mathcal{O}}_{UW} = \frac{1}{v^2} (\Phi^\dagger \Phi) \vec{W}^{\mu\nu} \cdot \widetilde{\vec{W}}_{\mu\nu} \quad , \quad (6)$$

$$\overline{\mathcal{O}}_{UB} = \frac{4}{v^2} (\Phi^\dagger \Phi) B^{\mu\nu} \widetilde{B}_{\mu\nu} \quad (7)$$

The last two ones are CP-violating. We shall also consider the superblind operator

$$\mathcal{O}_{\Phi 2} = 4 \partial_\mu (\Phi^\dagger \Phi) \partial^\mu (\Phi^\dagger \Phi) \quad , \quad (8)$$

Its effect is to induce a wave function renormalization to the Higgs field. Note also that $\mathcal{O}_{\Phi 2}$, \mathcal{O}_W , \mathcal{O}_{UW} and $\overline{\mathcal{O}}_{UW}$ are custodial $SU(2)_c$ invariant.

The effective lagrangian will be written

$$\begin{aligned} \mathcal{L}_{NP} = & \lambda_W \frac{g}{M_W^2} \mathcal{O}_W + \frac{f_B g'}{2M_W^2} \mathcal{O}_{B\Phi} + \frac{f_W g}{2M_W^2} \mathcal{O}_{W\Phi} + \\ & d \mathcal{O}_{UW} + \frac{d_B}{4} \mathcal{O}_{UB} + \bar{d} \overline{\mathcal{O}}_{UW} + \frac{\bar{d}_B}{4} \overline{\mathcal{O}}_{UB} + \frac{f_{\Phi 2}}{v^2} \mathcal{O}_{\Phi 2} \quad , \quad (9) \end{aligned}$$

This NP lagrangian is often written elsewhere as

$$L = \Sigma_i \frac{\bar{f}_i}{\Lambda_{NP}^2} O_i \quad (10)$$

Λ_{NP} being the NP scale. However in absence of a well defined NP dynamics, the normalization of Λ_{NP} is not well defined, and in phenomenological analyses it has to be fixed to a certain value (often taken as $1TeV$) before discussing the magnitude of the \bar{f}_i .

We have defined[4] a phenomenological scale which is free of this ambiguity. For $dim > 4$ operators the amplitudes grow with the energy so that we define a scale $\Lambda_{th}(f_i)$ as the value of the energy at which the unitarity limit is reached for a given operator, the lagrangian being now written as

$$L = \Sigma_i f_i O_i \quad (11)$$

This scale Λ_{th} has precisely the physical meaning of the NP scale Λ_{NP} as it should precisely be the energy value corresponding to the threshold for new particle production (which cures the unitarity saturation). So in the following we shall identify these two scales and for each operator we shall refer to $\Lambda_{NP} \equiv \Lambda_{th}(f_i)$. It is also the energy at which \mathcal{L}_{eff} ceases to be meaningful. So for each operator \mathcal{O}_i , each value of f_i is associated to a Λ_{NP} through a well-defined relation. An example extracted from the results obtained in [4] for the operator \mathcal{O}_W with the normalization in eqs.(1),(9) is

$$\Lambda_{th}(\lambda_W) = \sqrt{19 \frac{M_W^2}{|\lambda_W|}} \quad (12)$$

It shows in particular that the sensitivity to low values of f_i means a sensitivity to high scales Λ_{NP} .

c) Effective Lagrangian for the Heavy Quark Sector

Contrarily to the case of the light fermionic sector, the heavy quark sector (t, b) has not yet been tested with high accuracy. At LEP1, the recent measurements of the $Zb\bar{b}$ width show room for non standard effects at the few percent level (as opposed to the per mille level in the light sector)[1]. The heavy top ($m_t \simeq 2M_W$) may precisely open a window on the mass generation mechanism. Anomalous top properties reflect in the $Zb\bar{b}$ coupling through the 1-loop correction to this vertex. In the SM case a large effect proportional to $(m_t/M_Z)^2$ is already appearing. NP effects involving the top can also be similarly enhanced. If the mass generation mechanism is at the origin of these effects, we expect that the corresponding effective lagrangian involves at least one t_R field. We have done[16] a classification of all such $dim = 6$, $SU(2) \times U(1)$ gauge invariant operators and we found 28 ones, 14 of them involving t_R fields. We concentrated on these 14 ones that consist in 7 two-quark operators and 7 four-quark ones.

Four-quark operators

$$\mathcal{O}_{qt} = (\bar{q}_L t_R)(\bar{t}_R q_L) \quad (13)$$

$$\mathcal{O}_{qt}^{(8)} = (\bar{q}_L \vec{\lambda} t_R)(\bar{t}_R \vec{\lambda} q_L) \quad , \quad (14)$$

$$\mathcal{O}_{tt} = \frac{1}{2}(\bar{t}_R \gamma_\mu t_R)(\bar{t}_R \gamma^\mu t_R) \quad , \quad (15)$$

$$\mathcal{O}_{tb} = (\bar{t}_R \gamma_\mu t_R)(\bar{b}_R \gamma^\mu b_R) \quad , \quad (16)$$

$$\mathcal{O}_{tb}^{(8)} = (\bar{t}_R \gamma_\mu \vec{\lambda} t_R)(\bar{b}_R \gamma^\mu \vec{\lambda} b_R) \quad , \quad (17)$$

$$\begin{aligned} \mathcal{O}_{qq} = & (\bar{t}_R t_L)(\bar{b}_R b_L) + (\bar{t}_L t_R)(\bar{b}_L b_R) \\ & - (\bar{t}_R b_L)(\bar{b}_R t_L) - (\bar{b}_L t_R)(\bar{t}_L b_R) \quad , \end{aligned} \quad (18)$$

$$\begin{aligned} \mathcal{O}_{qq}^{(8)} = & (\bar{t}_R \vec{\lambda} t_L)(\bar{b}_R \vec{\lambda} b_L) + (\bar{t}_L \vec{\lambda} t_R)(\bar{b}_L \vec{\lambda} b_R) \\ & - (\bar{t}_R \vec{\lambda} b_L)(\bar{b}_R \vec{\lambda} t_L) - (\bar{b}_L \vec{\lambda} t_R)(\bar{t}_L \vec{\lambda} b_R) \quad . \end{aligned} \quad (19)$$

Two-quark operators

$$\mathcal{O}_{t1} = (\Phi^\dagger \Phi)(\bar{q}_L t_R \tilde{\Phi} + \bar{t}_R \tilde{\Phi}^\dagger q_L) \quad , \quad (20)$$

$$\mathcal{O}_{t2} = i \left[\Phi^\dagger (D_\mu \Phi) - (D_\mu \Phi^\dagger) \Phi \right] (\bar{t}_R \gamma^\mu t_R) \quad , \quad (21)$$

$$\mathcal{O}_{t3} = i (\tilde{\Phi}^\dagger D_\mu \Phi)(\bar{t}_R \gamma^\mu b_R) - i (D_\mu \Phi^\dagger \tilde{\Phi})(\bar{b}_R \gamma^\mu t_R) \quad , \quad (22)$$

$$\mathcal{O}_{Dt} = (\bar{q}_L D_\mu t_R) D^\mu \tilde{\Phi} + D^\mu \tilde{\Phi}^\dagger (\overline{D_\mu t_R} q_L) \quad , \quad (23)$$

$$\mathcal{O}_{tW\Phi} = (\bar{q}_L \sigma^{\mu\nu} \vec{\tau} t_R) \tilde{\Phi} \cdot \vec{W}_{\mu\nu} + \tilde{\Phi}^\dagger (\bar{t}_R \sigma^{\mu\nu} \vec{\tau} q_L) \cdot \vec{W}_{\mu\nu} \quad , \quad (24)$$

$$\mathcal{O}_{tB\Phi} = (\bar{q}_L \sigma^{\mu\nu} t_R) \tilde{\Phi} B_{\mu\nu} + \tilde{\Phi}^\dagger (\bar{t}_R \sigma^{\mu\nu} q_L) B_{\mu\nu} \quad , \quad (25)$$

$$\mathcal{O}_{tG\Phi} = \left[(\bar{q}_L \sigma^{\mu\nu} \lambda^a t_R) \tilde{\Phi} + \tilde{\Phi}^\dagger (\bar{t}_R \sigma^{\mu\nu} \lambda^a q_L) \right] G_{\mu\nu}^a \quad . \quad (26)$$

We temporarily (the obtention of unitarity constraints is in progress [17]) define the lagrangian in this sector as

$$\mathcal{L} = \sum_i \frac{\bar{f}_i}{\Lambda_{NP}^2} \mathcal{O}_i \quad , \quad (27)$$

Λ_{NP} being the NP scale and \bar{f}_i the dimensionless coupling of the operator \mathcal{O}_i . The effects in Z peak physics has been studied in [16] and reported in Section 3. The analysis of the effects in direct top production is in progress[17].

3 Tests at present and future colliders

We now successively report on the results obtained with the above tools for the present LEP/SLC range and beyond (LEP2 and NLC).

3a. The Light l,q Sector at LEP1/SLC

It is important to discuss how far the high precision tests done at Z peak with fermionic processes can be used to test the bosonic sector. In order to achieve this goal it is essential to use a description of the Z exchange processes which is sufficiently general in order to account for possible NP effects but also in order to cover in an accurate way the SM radiative correction effects. For this reason the usual description [18] of the effective Z exchange amplitude in $e^+e^- \rightarrow f\bar{f}$ has been somewhat generalized [19].

The charged leptonic processes $e^+e^- \rightarrow Z \rightarrow l^+l^-$ is described by the usual two parameters $\epsilon_1^l, \bar{s}_l^2$ that can be experimentally measured through two "good" observables, the leptonic Z width Γ_l , and A_l taken as the polarized asymmetry A_{LR} or the τ asymmetry or through the unpolarized forward-backward asymmetry $A_{FB,l} = \frac{3}{4}A_l^2$.

The light quark processes $e^+e^- \rightarrow Z \rightarrow q\bar{q}$ are described assuming universality for the first two families, i.e. $u = c$ and $d = s$. In this case we have defined 4 parameters $\epsilon_1^{u,d}, \bar{s}_{u,d}^2$ (actually in [19] we have frequently used their combinations called $\delta_{u,d}^{(1)}$ and $\delta'_{u,d}$). They could in principle be determined by the four observables $\Gamma_{u,d}$ or $\Gamma_{c,s}$ and $A_{u,d}$ or $A_{c,s}$. In practice the situation is slightly less simple as one can measure in an accurate way only Γ_4 or the combination D defined in [20] and at a weaker level maybe also Γ_c .

Asymmetry factors A_q are involved in the forward-backward asymmetries $A_{FB,q} = \frac{3}{4}A_l A_q$ but can only be measured with a sufficient accuracy through polarized e^\pm beams[21] with $A_{FB}^{pol(q)} = \frac{3}{4}A_q$ for $q=c$ and at a weaker accuracy for $q=s$.

Constraints on Higher Vector Bosons and on anomalous interactions in the bosonic sector have been established on the basis of these Z peak measurements.

In the case of $Z - Z'$ mixing effects, model-independent constraints have been obtained [11], [12] on the product of the mixing angle θ_M by the fermionic Z' couplings. For specific models (like E_6 or LR symmetry, or alternative models) in which these Z' couplings are fixed, upper limits have been found for θ_M that lie at the few per mille level, see Table 1a.

Table 1a: Upper bounds on the mixing angle θ_M .							
Ψ		η		χ		LR	
-0.007	+0.002	-0.012	+0.005	-0.010	+0.002	-0.005	+0.002

In some "constrained" cases this mixing angle is related to the ratio $M_Z^2/M_{Z'}^2$, and in Table 1b the limits have been translated into lower limits for $M_{Z'}$ [11], [12].

Table 1b: Lower bounds for Z' masses in TeV					
η	χ	LR	Y	$Y_L(\lambda_Y^2 = 1/4)$	Z^*
0.6	0.6	1.1	1.1	1.7	1.1

Concerning the effective bosonic lagrangian, I will just recall that the four non blind operators $\mathcal{O}_{DW}, \mathcal{O}_{DB}, \mathcal{O}_{BW}, \mathcal{O}_{\Phi 1}$ contribute directly (at tree level) to the ϵ_i parameters. Consequently the constraints on the coupling constants are very strong[7], [15], i.e.

$$|\bar{f}_i \frac{M_Z^2}{\Lambda_{NP}^2}| \lesssim O(10^{-2} \text{ to } 10^{-3}) \quad (28)$$

when one treats these operators one by one.

Blind operators affect the LEP1 parameters only at 1-loop. This raises the usual technical problems of loop computations with effective (non renormalizable) lagrangians[22]. About this point we have just noticed the fact that the domain of integration corresponding to the divergent part may correspond to a strong coupling regime (and even overpass the unitarity limit) so that non-perturbative effects should in principle be taken into account. This weakens the power of the constraints that has been derived from perturbative analyses. Nevertheless they give an orientation. In any case, because of the loop factor $\frac{\alpha}{4\pi}$ the constraints are much weaker than in the case of nonblind operators

$$|\bar{f}_i \frac{M_Z^2}{\Lambda_{NP}^2}| \lesssim O(1 \text{ to } 10^{-1}) \quad (29)$$

for example[15]

$$|\lambda_W| \lesssim 0.6 \quad . \quad (30)$$

Through unitarity relations [4] this limit corresponds to a rather low NP scale of 0.35 TeV and this illustrates the point just mentioned above about the limit of validity of the 1-loop constraints.

We have also computed[16] the leading contributions at 1-loop of the anomalous top interactions described in Section 2 to the ϵ_i parameters. In fact only 4 operators \mathcal{O}_{t2} , \mathcal{O}_{Dt} , $\mathcal{O}_{tW\Phi}$, $\mathcal{O}_{tB\Phi}$ in this list contribute here and the result, for $\Lambda_{NP} = 1TeV$, is

$$-0.3 \lesssim \bar{f}_{t2} \lesssim +0.3 \quad -1.1 \lesssim \bar{f}_{Dt} \lesssim +1.1 \quad , \quad (31)$$

$$-0.27 \lesssim \bar{f}_{tW\Phi} \lesssim +0.47 \quad -0.27 \lesssim \bar{f}_{tB\Phi} \lesssim +0.43 \quad , \quad (32)$$

which constitutes already very stringent constraints on this sector.

3b. The Heavy Quark Sector at LEP1/SLC

In this sector the only process available at Z peak is $e^+e^- \rightarrow Z \rightarrow b\bar{b}$. It is described by two additional parameters [23] that we identify through the departures from universality with the two first families:

$$\delta g_{Vb} = \delta g_{Vd} + \delta g_{Vb}^{Heavy} \quad (33)$$

$$\delta g_{Ab} = \delta g_{Ad} + \delta g_{Ab}^{Heavy} \quad (34)$$

that can be determined through the two new observables

$$\Gamma_b = \Gamma_d[1 + \delta_{bV}] \quad A_b = A_d[1 + \eta_b] \quad (35)$$

measurable through

$$R_b = \frac{\Gamma_b}{\Gamma_{had}} \quad A_{FB}^{pol(b)} = \frac{3}{4}A_b \quad (36)$$

The parameters δ_{bV} and η_b are essentially representing the left-handed and the right-handed types of NP corrections [23]. These corrections can appear from various sources

(anomalous heavy quark couplings, anomalous gauge boson couplings, anomalous Higgs couplings, new particle exchanged like charged Higgses and supersymmetric partners,.....). We have shown that various models lie on different trajectories in the δ_{bV}, η_b plane. See Fig. 2-6 of [23].

Recently we have computed the leading contributions to the $Zb\bar{b}$ vertex of the operators describing the anomalous gauge boson and top interactions listed in Section 2. In the case of anomalous gauge boson interactions only 2 operators, namely $\mathcal{O}_{W\Phi}$ and $\mathcal{O}_{B\Phi}$, contribute at this level [24]. So this process provides an interesting way of disentangling them from the whole set of blind operators.

In the case of anomalous top interactions, among the 14 operators only seven of them contribute and the results are summarized in Table 2, where the blanks indicate no contribution from the corresponding operator.

Operator	$\epsilon_1^{(NP)}$	$\epsilon_3^{(NP)}$	$\delta_{bv}^{(NP)}$	$\eta_b^{(NP)}/\delta_{bv}^{(NP)}$
\mathcal{O}_{qt}			$-2.1 \times 10^{-3} f_{qt}$	0.068
$\mathcal{O}_{qt}^{(8)}$			$-1.1 \times 10^{-2} \bar{f}_{qt}^{(8)}$	0.068
\mathcal{O}_{t2}	$-1.1 \times 10^{-2} \bar{f}_{t2}$		$2.1 \times 10^{-3} \bar{f}_{t2}$	0.068
\mathcal{O}_{Dt}	$-2.8 \times 10^{-3} \bar{f}_{Dt}$		$-4.8 \times 10^{-3} \bar{f}_{Dt}$	0.068
\mathcal{O}_{qq}			$1.7 \times 10^{-5} \bar{f}_{qq}$	0.03
$\mathcal{O}_{qq}^{(8)}$			$9.1 \times 10^{-5} \bar{f}_{qq}^{(8)}$	0.03
\mathcal{O}_{tb}			$-2.3 \times 10^{-3} \bar{f}_{tb}$	-2.068
$\mathcal{O}_{tW\Phi}$		$-6.0 \times 10^{-3} \bar{f}_{tW\Phi}$		
$\mathcal{O}_{tB\Phi}$		$-6.6 \times 10^{-3} \bar{f}_{tB\Phi}$		

We remark that the operators \mathcal{O}_{qt} , $\mathcal{O}_{qt}^{(8)}$, \mathcal{O}_{t2} and \mathcal{O}_{Dt} give purely left-handed contributions, whereas on the contrary, the operator \mathcal{O}_{tb} generates a pure right-handed one. Finally, \mathcal{O}_{qq} and $\mathcal{O}_{qq}^{(8)}$ generate only anomalous magnetic moment-type couplings for both, $Zb\bar{b}$ and $\gamma b\bar{b}$ couplings.

The results presently available on Γ_b alone from LEP and SLC [1], leading to

$$\delta_{bV}^{(NP)} = (+1.93 \pm 1.08) \times 10^{-2} \quad . \quad (37)$$

give the constraints for $\Lambda_{NP} = 1TeV$

$$-15 \lesssim \bar{f}_{qt} \lesssim -4 \quad -3 \lesssim \bar{f}_{qt}^{(8)} \lesssim -0.7 \quad -6 \lesssim \bar{f}_{Dt} \lesssim -2 \quad +4 \lesssim \bar{f}_{t2} \lesssim +15 \quad , \quad (38)$$

$$-14 \lesssim \bar{f}_{tb} \lesssim -4 \quad 0.5 \times 10^{+3} \lesssim \bar{f}_{qq} \lesssim 2 \times 10^{+3} \quad 10^{+2} \lesssim \bar{f}_{qq}^{(8)} \lesssim 4 \times 10^{+2} \quad . \quad (39)$$

The very loose limit on \bar{f}_{qq} and $\bar{f}_{qq}^{(8)}$ is due to the presence of an m_b/m_t factor for the effect of this type of magnetic coupling called $\delta\kappa^Z$ in [16]. It corresponds to a $\delta\kappa^Z$ value of the order of 0.1. We have looked whether it could be possible to measure separately

the magnetic $\gamma b\bar{b}$ and $Zb\bar{b}$ couplings by performing measurements outside the Z peak. An analysis[16] of the process $e^+e^- \rightarrow b\bar{b}$ going through photon and Z exchange showed us that an accuracy of one percent below the Z peak would allow the determination of $\delta\kappa^\gamma$ at the same level of 0.1 .

The most interesting result in Table 2 is given by its last column which indicates that the ratio $\eta_b^{(NP)}/\delta_{bv}^{(NP)}$ provides a very strong signature for discriminating between the left-handed, right-handed and the anomalous magnetic $Zb\bar{b}$ vertex. Note that if a single operator dominates, the ratio $\eta_b^{(NP)}/\delta_{bv}^{(NP)}$ is independent of the magnitude of its coupling and depends only on the nature of the induced $Zb\bar{b}$ vertex.

It should be stressed that the large and negative $\eta_b^{(NP)}/\delta_{bv}^{(NP)}$ ratio would be a rather peculiar signature of the \mathcal{O}_{tb} operator. This result would be orthogonal to the expectations for the minimal supersymmetric SM. Here, in fact, the trend would be that of positive $\eta_b^{(NP)}$ (of order one percent) for positive $\delta_{bv}^{(NP)}$. However, this prediction would be necessarily accompanied by the discovery of suitably light supersymmetric particles, like *e.g.* a light chargino and/or a light neutral Higgs.

4 $e^+e^- \rightarrow f\bar{f}$ at LEP2 and NLC

We were then interested in the following question. Having as an input the result of the high precision tests at Z peak, is it still possible to find or to constrain NP effects from the fermionic channels $e^+e^- \rightarrow f\bar{f}$ at higher energies? The answer is "Yes" because NP effects should grow when the energy increases towards the NP scale, whereas SM contributions should decrease (because of unitarity constraints).

We have established a method for treating this situation that we called in [25]

The Z-peak Subtracted Representation. The main idea is that of expressing the various effects in the form of a once-subtracted dispersion integral, and of fixing the necessary subtraction constants by suitable model-independent LEP 1 results. In this way, we are led to a compact "representation" of all observables (cross sections, FB asymmetries, polarization asymmetries,...) which presents two main advantages. The first one is to express the New Physics contributions through convergent integrals. The second one is that LEP 1 constraints (M_Z and all Z partial widths), as well as $\alpha(0)$, are automatically incorporated in the expressions of the observables.

For example, the cross section for muon production $\sigma_\mu(q^2)$, at cm energy $\sqrt{q^2}$, at one loop level takes the form

$$\begin{aligned} \sigma_\mu^{(1)}(q^2) \simeq & \left(\frac{4}{3}\pi q^2\right) \left\{ \left[\frac{\alpha}{q^2}\right]^2 \left[1 + 2\tilde{\Delta}\alpha(\mathbf{q}^2)\right] \right. \\ & \left. + \frac{1}{[(q^2 - M_z^2)^2 + M_z^2\Gamma_z^2]} \left[\frac{3\Gamma_\ell}{M_z}\right]^2 \left[1 - 2\mathbf{R}(\mathbf{q}^2) - \frac{16(1 - 4s_1^2)c_1s_1}{(1 + \tilde{v}_\ell^2(M_z^2))}\mathbf{V}(\mathbf{q}^2)\right] \right\} \end{aligned} \quad (40)$$

where in the three combinations

$$\tilde{\Delta}\alpha(\mathbf{q}^2) \equiv \mathcal{R}e(\tilde{F}_\gamma(0) - \tilde{F}_\gamma(q^2)) \quad (41)$$

$$\mathbf{R}(\mathbf{q}^2) = \tilde{I}_z(q^2) - \tilde{I}_z(M_Z^2) \quad (42)$$

$$\mathbf{V}(\mathbf{q}^2) = \mathcal{R}e \left[\tilde{F}_{\gamma z}(q^2) - \tilde{F}_{\gamma z}(M_Z^2) \right] \quad (43)$$

respectively associated to photon exchange, Z exchange and their interference, a “subtraction” at the Z peak has been performed. Other $e^+e^- \rightarrow f\bar{f}$ processes are treated in a similar way and involve the same types of combinations with an index (ef), see [13].

The departures from 1-loop SM predictions appear in these three Z-subtracted combinations. We have considered several classes of models (Technicolour type, Anomalous gauge boson couplings, Higher vector boson Z'), computed their contributions to these functions and obtained the expressions of the various observables at LEP2 and NLC. Depending on the number of basic parameters of the models, typical relations among these various functions have been established. Three examples are given below, for the Technicolour-type of models [26]

$$V^{TC}(q^2) \equiv \left(\frac{1 - 2s_1^2}{2s_1c_1} \right) \left(\frac{q^2 - M_Z^2}{q^2} \right) \left(\frac{M_V^2}{M_V^2 - M_Z^2} \right) \tilde{\Delta}\alpha^{TC}(q^2) \quad , \quad (44)$$

for anomalous gauge boson couplings [25]

$$\tilde{\Delta}\alpha^{AGC}(q^2) \equiv - \left(\frac{q^2}{q^2 - M_Z^2} \right) \left[R^{AGC}(q^2) + \frac{2s_1^2 - 1}{c_1s_1} V^{AGC}(q^2) \right] \quad , \quad (45)$$

and for general Z' exchange [13]

$$[V^{Z'}(q^2)]^2 \equiv - \left(\frac{q^2 - M_Z^2}{q^2} \right) R^{Z'}(q^2) \tilde{\Delta}\alpha^{Z'}(q^2) \quad . \quad (46)$$

We have then translated them in the form of trajectories in the space of the observables. As one can see from Fig.1a-b this should allow a clear disentangling of these classes of models. In Fig.1c,d we have illustrated how various types of Z' models distribute inside the 2-dimensional space of $\sigma(e^+e^- \rightarrow \mu^+\mu^-)$ and A_{FB}^μ .

In [13] trajectories in the space of other observables (including hadronic ones) have also been obtained.

5 $e^+e^- \rightarrow W^+W^-$ at LEP2 and NLC

This process is known since a long time to be the first place for testing the gauge couplings γWW and ZWW [27]. After several other studies in the past, a model independent analysis has been recently made[29]. It involves the seven possible forms for anomalous 3-boson couplings, consistent with Lorentz and $U(1)_{EM}$ invariances. A methodology has been proposed[28], [29], [30], [31] for disentangling these various forms by using the W angular distribution and the W spin density matrices measurable through the decay

distributions into fermion pairs. Discovery limits for individual couplings and contour plots for the multiparameter cases have been obtained.

If we now stick to the assumptions about NP explained in the introduction, and restrict to CP-conserving $dim = 6$ operators, only three independent operators \mathcal{O}_W , $\mathcal{O}_{B\Phi}$ and $\mathcal{O}_{W\Phi}$ appear. They contribute to five of the γWW and ZWW anomalous couplings, namely δ_Z , x_γ , x_Z , λ_γ and λ_Z , satisfying the relations [8], [32]

$$x_Z = -\frac{s}{c}x_\gamma \quad (47)$$

$$\lambda_\gamma = \lambda_Z \quad (48)$$

At LEP2 the sensitivity to these couplings is expected to be at the level of 10^{-1} . At NLC the sensitivity is expected to increase according to the scaling law \sqrt{sL} where s is the square of the e^-e^- energy and L the luminosity of the machine. For example at 1 TeV with $80fb^{-1}$ one should reach a sensitivity of the order of 10^{-3} .

Using the unitarity relations [4] this means that NP scales of about 1.5 TeV should be reached for these operators at LEP2. At a 1TeV NLC they reach about 10 TeV.

6 Production HZ and $H\gamma$ at LEP2 and NLC

If the Higgs mass is low enough, the first possibility of doing tests of Higgs boson properties will be offered by LEP2 (and later on by NLC) with $e^+e^- \rightarrow HZ$ and $e^+e^- \rightarrow H\gamma$. The SM allows for $e^+e^- \rightarrow Z \rightarrow HZ$ at tree level and for $e^+e^- \rightarrow \gamma, Z \rightarrow H\gamma$ at 1-loop level. We have concentrated[33] our analysis to NP effects due to the five operators \mathcal{O}_{UB} , \mathcal{O}_{UW} , $\overline{\mathcal{O}}_{UB}$, $\overline{\mathcal{O}}_{UW}$ and $\mathcal{O}_{\Phi 2}$ which create anomalous HZZ , $HZ\gamma$ and $H\gamma\gamma$ couplings. The effects of the other operators should be already largely constrained through the $e^+e^- \rightarrow W^+W^-$ channel. The search of NP should proceed by doing precision measurements of HZ production and by looking for signals of $H\gamma$ production, the SM rate for this second process being apparently too small to be observable.

The precision tests of $e^+e^- \rightarrow HZ$ that we propose [33] should consist in measuring accurately the angular distribution $d\sigma/d\cos\theta$ and the Z spin density matrix elements through the dependence in the azimuthal angle ϕ_f between the Z production plane and the $Z \rightarrow f\bar{f}$ decay plane (f being a charged lepton or a b quark). Four azimuthal asymmetries A_{14} , A_{12} , A_{13} and A_8 respectively associated to the $\cos\phi_f$, $\sin\phi_f$, $\sin 2\phi_f$ and $\cos 2\phi_f$ dependences are especially suitable for this search. With these five observables it is in principle possible to disentangle the effects of the five NP operators.

At LEP2, the number of events would be too small (about 200 raw ones) to allow for such a detailed analysis. Only $d\sigma/d\cos\theta$ will be measurable (see Fig.2a,b) and will give a meaningful constraint on one combination of NP couplings namely $d_{ZZ} = dc_W^2 + d_B s_W^2$ and $|f_{\phi 2}|$. Assuming $m_H = 80GeV$ at $192GeV$ the sensitivity limit is $d = 0.015$ or $d_B = 0.04$ which corresponds through unitarity relations to NP scales of 14 and 5 TeV respectively. In the case of $\mathcal{O}_{\Phi 2}$ the observability limit is $|f_{\phi 2}| \simeq 0.01$, which means $\Lambda_{NP} \simeq 6 - 7TeV$. This is not too bad for a first exploration of the Higgs sector!

At NLC, for example at 1TeV with a few thousands of events, see Fig.2c, the sensitivity now reaches $|f_{\phi 2}| \simeq 0.004$, $|d| \simeq 0.005$, $|d_B| \simeq 0.015$ corresponding to NP scales of 10 , 40 , 8 TeV respectively. The disentangling of the five couplings is now conceivable through the study of the azimuthal asymmetries, which depend on four other combinations of $|f_{\phi 2}|$, $d_{\gamma Z} = s_W c_W (d - d_B)$ and the CP-violating ones \bar{d}_{ZZ} and $\bar{d}_{\gamma Z}$. This should be possible down to the percent level, see Fig.2d,e,f and [33].

A preliminary analysis of $H\gamma$ production is in progress [33]. The angular distribution $d\sigma/d\cos\theta$ of this process is sensitive to a new combination of couplings $d_{\gamma\gamma} = ds_W^2 + d_B c_W^2$. So it can be used to disentangle d from d_B without going through the difficult analysis of the Z spin density matrix. Only the search for CP-violating effects would then motivate it.

7 Tests in $\gamma\gamma$ collisions

New possibilities for testing the bosonic sector will be offered at high energy e^+e^- colliders. Through the laser backscattering method [34] intense and high energetic photon beams will be available. For our purpose two types of processes will be interesting, boson pair production and single Higgs production in $\gamma\gamma$ collisions.

a) Boson pair production in $\gamma\gamma$ collisions

We have considered[35] the following five processes $\gamma\gamma \rightarrow W^+W^-$, $\gamma\gamma \rightarrow ZZ$, $\gamma\gamma \rightarrow \gamma Z$, $\gamma\gamma \rightarrow \gamma\gamma$, and also $\gamma\gamma \rightarrow HH$. They are sensitive to the seven operators \mathcal{O}_W , $\mathcal{O}_{W\Phi}$, $\mathcal{O}_{B\Phi}$, \mathcal{O}_{UW} , \mathcal{O}_{UB} , $\bar{\mathcal{O}}_{UW}$, $\bar{\mathcal{O}}_{UB}$. The first three of them induce anomalous triple gauge boson couplings, while the remaining four create anomalous CP conserving and CP violating Higgs couplings.

We have shown[35] that the p_T distribution of one of the final boson B_3 and B_4 provides a convenient way of looking for NP effects. The process $\gamma\gamma \rightarrow W^+W^-$ receives a tree level contribution from SM, and NP contribution from the seven operators. The processes $\gamma\gamma \rightarrow ZZ$ and $\gamma\gamma \rightarrow HH$ receive no tree level SM contribution but NP contributions from six operators (\mathcal{O}_W is excluded). The two processes $\gamma\gamma \rightarrow \gamma\gamma$ and γZ also receive no tree level contribution from SM but NP contributions from only the four operators \mathcal{O}_{UW} , \mathcal{O}_{UB} , $\bar{\mathcal{O}}_{UW}$, $\bar{\mathcal{O}}_{UB}$, typical of the scalar sector.

We have studied the sensitivity to each of these operators in the various channels and the ways to disentangle their effects. See Fig.3a-d.

Table 3 summarizes the observability limits (lower bounds for the couplings leading to observable effects) expected for each operator by assuming that for W^+W^- production a departure of 5% as compared to the SM prediction in the high p_T range, will be observable. Combining these bounds with the unitarity relations [4] we obtain the upper bounds on the related NP scale which are indicated in parentheses in Table 3. The luminosities assumed for a 0.5, 1, 2 TeV collider are 20, 80, 320 fb^{-1} respectively.

Table 3: Observability limits based on the W^+W^- channel to the anomalous couplings and the related NP scales Λ_{NP} (TeV).

	\mathcal{O}_W		\mathcal{O}_{UW} or $\overline{\mathcal{O}}_{UW}$		\mathcal{O}_{UB} or $\overline{\mathcal{O}}_{UB}$		$\mathcal{O}_{B\Phi}$ or $\mathcal{O}_{W\Phi}$	
$2E_e(\text{TeV})$	$ \lambda_W $	Λ_{NP}	$ d $ or $ \bar{d} $	Λ_{NP}	$ d_B $ or $ \bar{d}_B $	Λ_{NP}	$ f_B $ or $ f_W $	Λ_{NP}
0.5	0.04	1.7	0.1	2.4	0.04	4.9	0.2	1.8, 1
1	0.01	3.5	0.04	5.5	0.015	9	0.05	3.5, 2
2	0.003	6.4	0.015	17	0.005	17	0.015	6.5, 3.6

At 2 TeV, in the case of the operators \mathcal{O}_{UB} , \mathcal{O}_{UW} , $\overline{\mathcal{O}}_{UB}$, $\overline{\mathcal{O}}_{UW}$ slightly better limits could in principle be obtained by using the $\gamma\gamma \rightarrow ZZ$ process. Demanding for example that the NP contribution to this process reaches the level of the SM result for $\gamma\gamma \rightarrow ZZ$ [36], we can decrease the limiting value for the couplings $|d|$ (or $|\bar{d}|$) and $|d_B|$ (or $|\bar{d}_B|$) down to 0.01 and 0.003 respectively. This means that a 2 TeV collider is sensitive to NP scales of about 20 TeV. A more precise analysis using realistic uncertainties for the detection of the ZZ channel and taking into account the interference between the SM and the NP contributions, could probably improve these limits. This is left for a future work.

We also found[35] that complete disentangling is possible by analyzing final spin states, i.e. separating $W_T(Z_T)$ from $W_L(Z_L)$ states. Identification of CP violating terms requires full W or Z spin density matrix reconstruction from their decay distributions[31, 33] or analyses with linearly polarized photon beams[37].

b) Single Higgs production in $\gamma\gamma$ collisions

We now show[38] that single Higgs production in $\gamma\gamma$ collisions through laser backscattering should provide the best way to look for New Physics (NP) effects inducing anomalous Higgs couplings. The Standard contribution to $\gamma\gamma \rightarrow H$ only occurs at 1-loop. With the high luminosities expected at linear e^+e^- colliders, a large number of Higgs bosons should be produced. The sensitivity to anomalous $H\gamma\gamma$ couplings is therefore very strong. NP contributions to this coupling only arises through the four operators \mathcal{O}_{UB} , \mathcal{O}_{UW} , $\overline{\mathcal{O}}_{UB}$ and $\overline{\mathcal{O}}_{UW}$.

We have first studied[38] the sensitivity of the production cross section $\sigma(\gamma\gamma \rightarrow H)$ for the typical NLC energies. With the aforementioned designed luminosities, one gets a few thousands of Higgs bosons produced in the light or intermediate mass range, see Fig.4a,b for the case of a 1 TeV NLC. Assuming conservatively an experimental detection accuracy of about 10% on the production rate, one still gets an observability limit of the order of 10^{-3} , 4.10^{-3} , 3.10^{-4} , 10^{-3} for d , \bar{d} , d_B and \bar{d}_B respectively. The corresponding constraints on the NP scale derived on the basis of the unitarity relations [4], are then very high, i.e. 200, 60, 60 and 30 TeV respectively.

The disentangling of the four operators \mathcal{O}_{UB} , \mathcal{O}_{UW} , $\overline{\mathcal{O}}_{UB}$ and $\overline{\mathcal{O}}_{UW}$ is possible by considering the Higgs decay branching ratios. Concerning this, we remark that $H \rightarrow b\bar{b}$ is not affected by the aforementioned seven purely bosonic operators describing NP. Neither $H \rightarrow WW$, ZZ are particularly sensitive to such an NP, since it is masked by strong tree

level SM contributions. On the other hand, the processes $H \rightarrow \gamma\gamma$ and $H \rightarrow \gamma Z$ who receive tree level contributions from the above anomalous couplings and only one loop ones from SM, are most sensitive to NP. Thus their ratio to the dominant Higgs decay mode, which depending on the Higgs mass may either be the $b\bar{b}$ or the WW, ZZ modes, provide a very sensitive way to further help disentangling among the CP conserving operators \mathcal{O}_{UB} and \mathcal{O}_{UW} . This way, using $H \rightarrow \gamma\gamma$ or $H \rightarrow \gamma Z$, couplings even weaker than 10^{-3} could be observable. For comparison we note that the corresponding sensitivity limit from $H \rightarrow WW, ZZ$ is at the 10% level.

Most spectacular for the disentangling of the various operators seem to be the ratios WW/ZZ and $\gamma\gamma/\gamma Z$, shown in Fig.5a,b. The first one, which is applicable in the intermediate and high Higgs mass range, allows to disentangle \mathcal{O}_{UB} from \mathcal{O}_{UW} down to values of the order of 10^{-1} , whereas the second one, applicable in the light Higgs case, is sensitive to couplings down to the 10^{-3} level or less.

Note that these properties are independent of the production modes and can be used for disentangling anomalous Higgs couplings in any other process.

The identification of CP-violating terms is not directly possible except for the remark that, contrarily to the CP-conserving terms, there can be no interference with the tree level SM contributions. Thus a CP violating interaction cannot lower the value of the widths through a destructive interference. A direct identification of CP violation requires either an analysis of the W or Z spin density matrix through their fermionic decay distributions [31, 33], or the observation of a suitable asymmetry with linearly polarized photon beams [37].

8 Concluding words

High precision measurements at Z peak on the one hand, technical problems and deficiencies of SM as well as dynamical models for NP residual effects on the other hand, suggest a hierarchy among the sectors where NP manifestations should first appear. This hierarchy favors the scalar sector and at a lower level the gauge sector and the heavy quark sector. The light fermionic sector should be disfavored.

According to this hierarchy and to several dynamical and symmetry properties we have classified the operators used to construct the effective lagrangian representing the NP effects at energies much below the NP scale. We have established unambiguous relations between the coupling constants and the NP scale through unitarity constraints. We have shown how higher Z' vector bosons effects can be integrated into modified photon and Z exchange amplitudes.

We have then examined the search for such effects at present and future colliders. We have first looked at virtual effects of NP in $e^+e^- \rightarrow f\bar{f}$. We have analyzed LEP1/SLC high precision tests in the various sectors in order to give model independent constraints on Z' couplings and other virtual NP effects due to, for example, residual bosonic and residual heavy quarks interactions described by effective lagrangians. We have established a method for representing $e^+e^- \rightarrow f\bar{f}$ at high q^2 , taking automatically into account Z

peak results in all observables. We have applied it to LEP2 and NLC energy ranges for several types of virtual NP effects (Technicolour type of resonances, anomalous gauge couplings, general type of Z') and we have shown that each model is characterized by a trajectory in the space spanned by the departures from SM predictions to the usual observables. So a clear disentangling of the models should be possible.

We have then concentrated on tree level effects of the effective lagrangian in the pure bosonic sectors and their tests at LEP2 and NLC in e^+e^- and $\gamma\gamma$ collisions. We have shortly discussed previous works on the search for anomalous 3-boson couplings in $e^+e^- \rightarrow W^+W^-$. We have presented new results on $e^+e^- \rightarrow HZ, H\gamma$ and the tests that these processes provide for anomalous $HZZ, HZ\gamma$ and $H\gamma\gamma$ couplings. If the Higgs is light enough, very sensible results could already be obtained at LEP2 and then, at NLC, a complete disentangling should be possible. Through laser backscattering method, the processes $\gamma\gamma \rightarrow W^+W^-, ZZ, Z\gamma, \gamma\gamma$ and HH allow to test 3-boson, 4-boson and Higgs-gauge boson couplings. The most powerful tests of $H\gamma\gamma$ will however be available through single Higgs production in $\gamma\gamma \rightarrow H$. Independently of the Higgs production process, ratios of Higgs decay widths can be used to disentangle the operators involved. The ratio $H \rightarrow \gamma\gamma/H \rightarrow \gamma Z$ has been shown to be especially sensitive even for very low couplings.

The landscape for these future tests is the following. At present, from LEP1/SLC the value of the NP scale which can be reached through virtual effects of blind operators is of the order of 0.35 TeV. The process $e^+e^- \rightarrow W^+W^-$ will allow a direct access to 3-gauge boson couplings up to an NP scale of about 1.5 TeV at LEP2 and 10 TeV at NLC. The processes $e^+e^- \rightarrow HZ, H\gamma$ will test the Higgs-gauge boson couplings up to 5-14 TeV at LEP2 and 10-50 TeV at NLC. Finally at NLC with the laser induced $\gamma\gamma$ collisions one should reach scales in the 10 TeV range with $\gamma\gamma \rightarrow VV$ but in the 100 TeV range with the single Higgs production process $\gamma\gamma \rightarrow H$. This range of scales covers a large domain of theoretical models of NP. This can let us hope that we will learn a lot about the origin of gauge symmetry breaking and the mass generation mechanism.

Acknowledgements: This report is based on several works done in collaboration with D. Comelli, G.J. Gounaris, J. Layssac, J.E. Paschalis, G. Tsirigoti, N.D. Vlachos and C. Verzegnassi. We especially thank Jacques Layssac for his help in the preparation of the figures.

References

- [1] D. Schaile, presented at the 27th Int. Conf. on High Energy Phys., Glasgow (1994). J. Erler and P. Langacker, Univ of Pennsylvania preprint UPR-0632T (1994).
- [2] J. Gunion, H. Haber, G. Kane and S. Dawson, The Higgs Hunter's guide, Addison-Wesley, Reading 1990.
- [3] W. Buchmüller and D. Wyler, Nucl. Phys. **B268** (1986) 621; C.J.C. Burgess and H.J. Schnitzer, Nucl. Phys. **B228** (1983) 454; C.N. Leung, S.T. Love and S. Rao Z. Phys. **C31** (1986) 433.
- [4] G.J. Gounaris, J. Layssac and F.M. Renard, Phys. Lett. **B332** (1994) 146 .
- [5] G.J. Gounaris, J. Layssac, J.E. Paschalis and F.M. Renard, Montpellier preprint PM/94-28, Z. Phys. C66(1995)619.
- [6] G.J. Gounaris, F.M. Renard and G. Tsirigoti, Phys. Lett. B350(1995)212.
- [7] A. De Rújula, M.B. Gavela, P. Hernandez and E. Masso, Nucl. Phys. **B384** (1992) 3.
- [8] G.J. Gounaris and F.M. Renard, Z. Phys. **C59** (1993) 133.
- [9] J.L. Kneur and D. Schildknecht, Nucl. Phys. **B357** (357) 1991; J.L. Kneur, M. Kuroda and D. Schildknecht, Phys. Lett. **B262** (93) 1991 . M. Bilenky *et.al.* , Phys. Lett. **B316** (1993) 345
- [10] G.J. Gounaris, F.M. Renard and G. Tsirigoti, Phys. Lett. **B338** (1994) 51 .
- [11] J. Layssac, F.M. Renard and C. Verzegnassi, Phys. Lett. **B287** (1992) 267 , Z. Phys. **C53** (1992) 97.
- [12] J. Layssac, F.M. Renard and C. Verzegnassi, contribution to the LEP2 workshop (1995).
- [13] F.M. Renard and C. Verzegnassi, preprint PM/95-35 (1995).
- [14] CDF Collaboration, Abe et al., FERMILAB-PUB-94-198-E (1994).
- [15] K. Hagiwara, S. Ishihara, R. Szalapski and D. Zeppenfeld, Phys. Lett. **B283** (1992) 353 and Phys. Rev. **D48** (1993) 2182.
- [16] G.J. Gounaris, F.M. Renard and C. Verzegnassi, Preprint PM/94-44 and THES-TP 95/01, hep-ph/9501362n to appear in Phys. Rev. D.
- [17] G.J. Gounaris et al, in preparation.

- [18] G. Altarelli, R. Barbieri, F. Caravaglios, Phys. Lett. **B314** (357) 1993 ; M. Peskin and T. Takeuchi, Phys. Rev. **D46** (381) 1992; B.W. Lynn, M.E. Peskin and R. Stuart in "Physics at LEP", J. Ellis and R. Peccei eds., CERN 86-02 (1986), Vol 1; HollikM. Consoli and W. Hollik in "Physics at LEP I", G. Altarelli, R. Kleiss, C. Verzegnassi eds. CERN 89-09 (1989).
- [19] J. Layssac, F.M. Renard and C. Verzegnassi, Phys. Rev. **D49** (1994) 3650.
- [20] F.M.Renard and C.Verzegnassi, Phys. Lett. **B260** (1991) 225
- [21] A.Blondel, B.W.Lynn, F.M. Renard and C. Verzegnassi, Nucl. Phys. **B304** (438) 1988.
- [22] C.P. Burgess and D. London, Phys. Rev. **D48** (1993) 4337.
- [23] D. Comelli, F.M. Renard and C. Verzegnassi, Phys. Rev. **D50** (1994) 3076.
- [24] F.M. Renard and C. Verzegnassi, Phys. Lett. **B345** (1995) 500 .
- [25] F.M. Renard and C. Verzegnassi, CERN-TH.7485/94 to appear in Phys.Rev.
- [26] J. Layssac, F.M. Renard and C. Verzegnassi, Phys. Rev. **D49** (1994) 2143.
- [27] K.J.F. Gaemers and G.J. Gounaris, Z. Phys. **C1** (1979) 259; K. Hagiwara, R. Peccei, D. Zeppenfeld and K. Hikasa, Nucl. Phys. **B282** (1987) 253.
- [28] G.J.Gounaris et al, in Proc. of the Workshop on e^+e^- Collisions a 500 GeV: The Physics Potential, DESY 92-123B(1992), p.735, ed. P.Zerwas; M.Bilenky et al, **B419** (1994) 240.
- [29] M. Bilenky, J.L. Kneur, F.M. Renard and D. Schildknecht, Nucl. Phys. **B409** (1993) 22 and **B419** (1994) 240.
- [30] G. Gounaris, J. Layssac, G. Moulataka and F.M. Renard, Int. J. Mod. Phys. **A8** (1993) 3285.
- [31] G.J. Gounaris, D. Schildknecht and F.M. Renard, Phys. Lett. **B263** (1993) 143 .
- [32] C. Grosse-Knetter, I. Kuss and D. Schildknecht, Z. Phys. **C60** (1993) 375.
- [33] G. Gounaris, F.M. Renard and N.D. Vlachos, preprint PM/95-30, THES-TP 95/08.
- [34] I. Ginzburg et al, Nucl. Instrum. Methods **205**(1983)47; **219**(1984)5.
- [35] G.J. Gounaris, J. Layssac and F.M. Renard, preprint PM/95-11, THES-TP 95/06.
- [36] G.V. Jikia, Nucl. Phys. **B405** (1993) 24; D.A. Dicus and C. Kao, Phys. Rev. **D49** (1995) 1265; M.S. Berger, Phys. Rev. **D48** (1993) 5121.

- [37] M. Krämer, J. Kühn, M.L. Stong and P.M. Zerwas, Z. Phys. **C64** (1994) 21.
- [38] G.J. Gounaris and F.M. Renard, preprint PM/95-20, THES-TP 95/07.

Figure Captions

Fig.1 Trajectories in the space of relative departures from SM for leptonic observables in $e^+e^- \rightarrow \mu^+\mu^-$ for various types of models.

- (a) 3-dimensional trajectories for general Z'
- (b) Technicolour models (TC) and anomalous gauge couplings (AGC)
- (c) 2-dimensional trajectories for specific Z' models, $E_6(-1 < \cos\beta < +1)$, $RL(\sqrt{\frac{2}{3}} < \alpha_{RL} < \sqrt{2})$
- (d) compositeness inspired Y, Y_L, Z^* models.

Fig.2 HZ production at LEP2 and NLC for $m_H = 80\text{GeV}$.

- (a) Cross section for $e^+e^- \rightarrow HZ$ versus e^+e^- total energy for SM and NP contributions due to $\mathcal{O}_{UB}, \mathcal{O}_{UW}$, and $\mathcal{O}_{\Phi 2}$.
- (b) Angular distribution of $e^+e^- \rightarrow HZ$ versus $|\cos\theta|$ at 192 GeV, SM and NP contributions due to $\mathcal{O}_{UB}, \mathcal{O}_{UW}$, and $\mathcal{O}_{\Phi 2}$. The number of events obtained with an integrated luminosity of 300pb^{-1} is also indicated.
- (c) Angular distribution of $e^+e^- \rightarrow HZ$ versus $|\cos\theta|$ at NLC(1 TeV), SM and NP contributions due to $\mathcal{O}_{UB}, \mathcal{O}_{UW}$, and $\mathcal{O}_{\Phi 2}$. The number of events obtained with an integrated luminosity of 80fb^{-1} is also indicated.
- (d) Azimuthal asymmetry A_{14} for $Z \rightarrow b\bar{b}$, versus total e^+e^- energy, SM and NP contributions due to \mathcal{O}_{UW} .
- (e) Azimuthal asymmetry A_{12} for $Z \rightarrow b\bar{b}$, versus total e^+e^- energy, SM and NP contributions due to $\overline{\mathcal{O}}_{UW}$.
- (f) Azimuthal asymmetry A_{13} versus total e^+e^- energy, SM and NP contributions due to $\overline{\mathcal{O}}_{UW}$.

Fig.3 Sensitivity of the transverse momentum (p_T) distribution $d\sigma/dp_T$ at 1 TeV for various operators.

- (a) \mathcal{O}_W in $\gamma\gamma \rightarrow W^+W^-$.
- (b) $\mathcal{O}_{B\Phi}$ and $\mathcal{O}_{W\Phi}$ in $\gamma\gamma \rightarrow W^+W^-, ZZ, HH$.
- (c) \mathcal{O}_{UW} and $\overline{\mathcal{O}}_{UW}$ in $\gamma\gamma \rightarrow W^+W^-, ZZ, \gamma Z, \gamma\gamma, HH$.
- (d) \mathcal{O}_{UB} and $\overline{\mathcal{O}}_{UB}$ in $\gamma\gamma \rightarrow W^+W^-, ZZ, \gamma Z, \gamma\gamma, HH$.

Fig.4 Cross sections for Higgs production in $\gamma\gamma$ collisions from laser backscattering at a 1 TeV e^+e^- linear collider. The expected number of events per year for an integrated luminosity of 80fb^{-1} , is also indicated.

- (a) Standard prediction (solid line), with $d = +0.01$ (long dashed), $d = -0.01$ (dashed - circles), $d = +0.005$ (short dashed), $d = -0.005$ (dashed), $d = +0.001$ (dashed - stars), and $d = -0.001$ (dashed - boxes).
- (b) Standard prediction (solid line), with $\bar{d} = 0.01$ (long dashed), $\bar{d} = 0.001$ (short dashed), $\bar{d} = 0.005$ (dashed).

Fig.5 Ratios of Higgs decay widths for $m_H = 0.2\text{TeV}$ versus coupling constant values,

- (a) $\Gamma(H \rightarrow WW)/\Gamma(H \rightarrow ZZ)$,
 - (b) $\Gamma(H \rightarrow \gamma\gamma)/\Gamma(H \rightarrow \gamma Z)$,
- with $d > 0$ (solid), $d < 0$ (short dashed), $d_B > 0$ (dashed), $d_B < 0$ (long dashed), \bar{d} (dashed-circles), \bar{d}_B (dashed-stars).

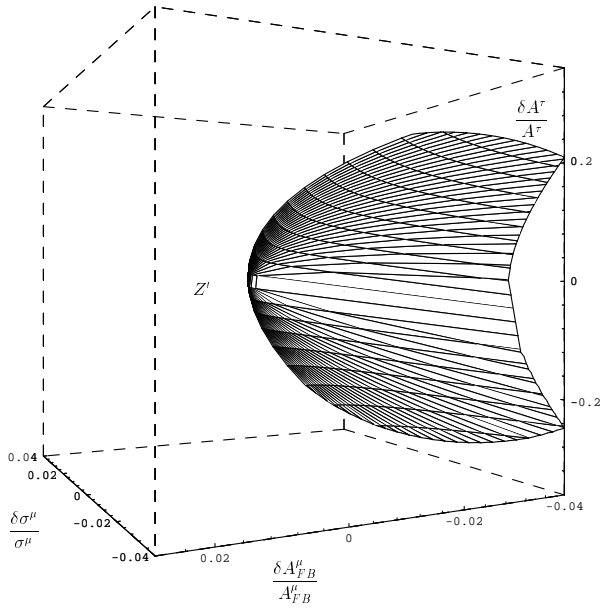

Fig 1a

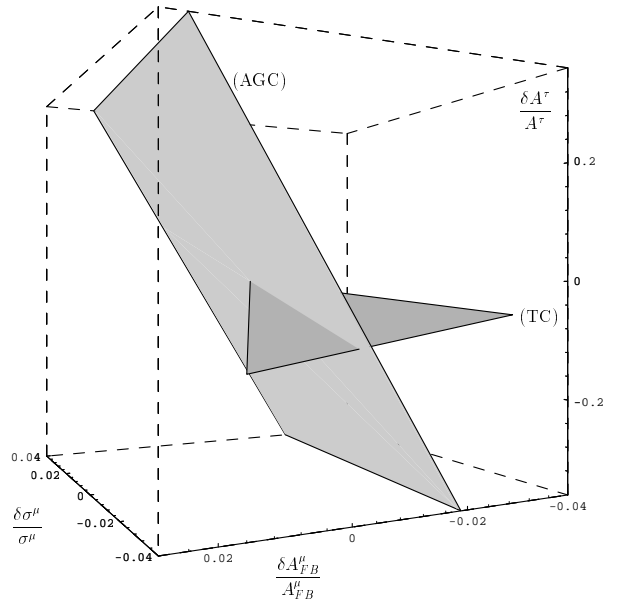

Fig 1b

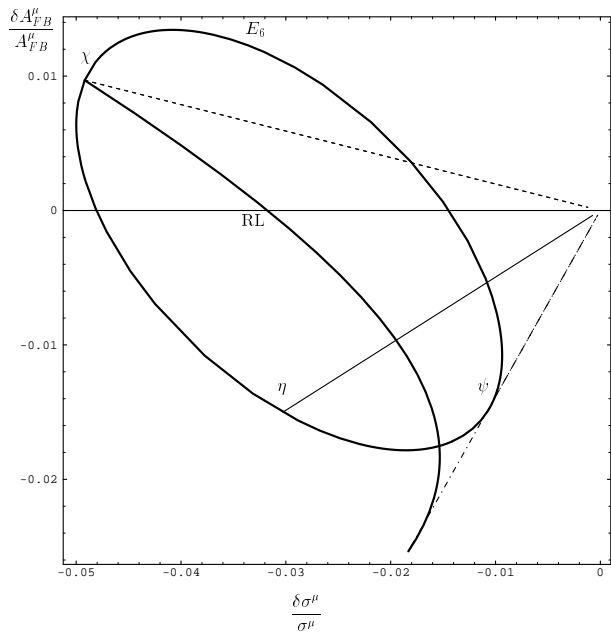

Fig 1c

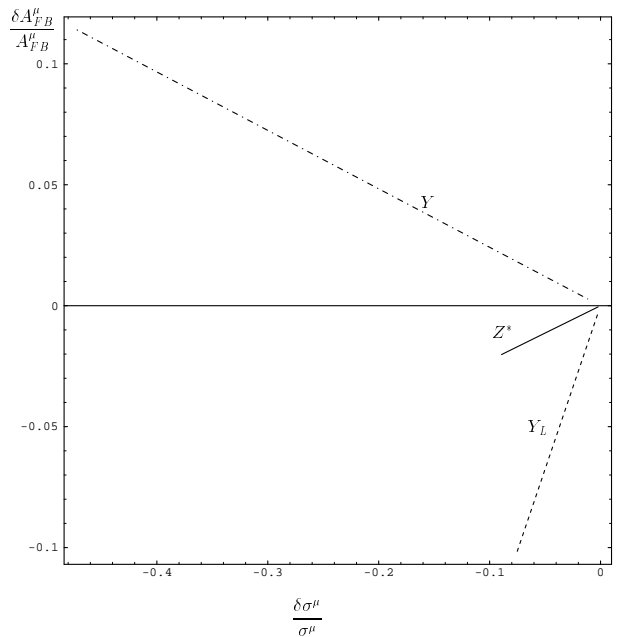

Fig 1d

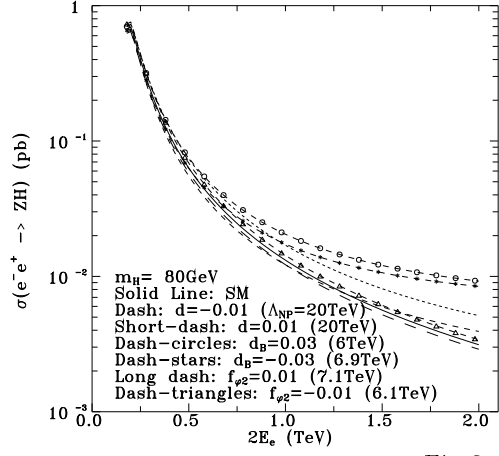

Fig 2a

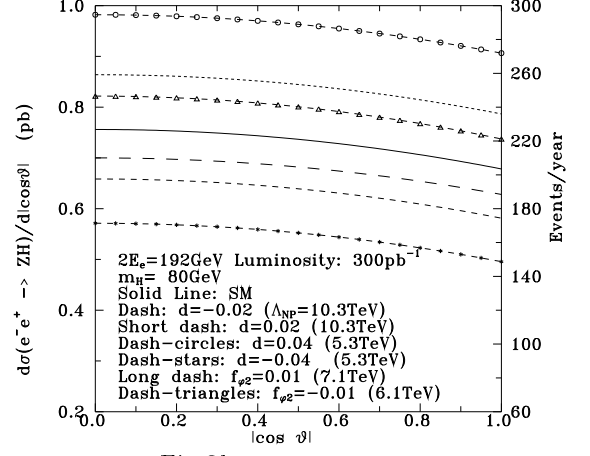

Fig 2b

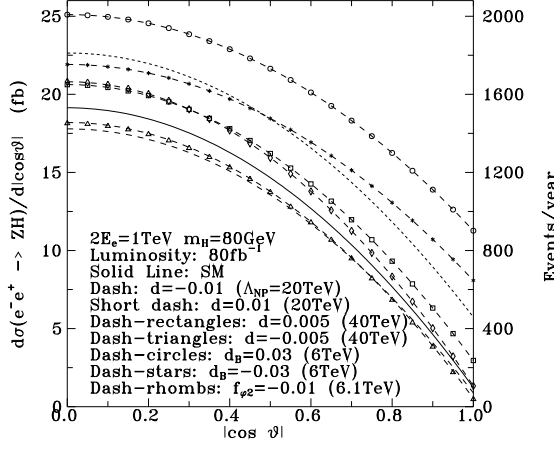

Fig 2c

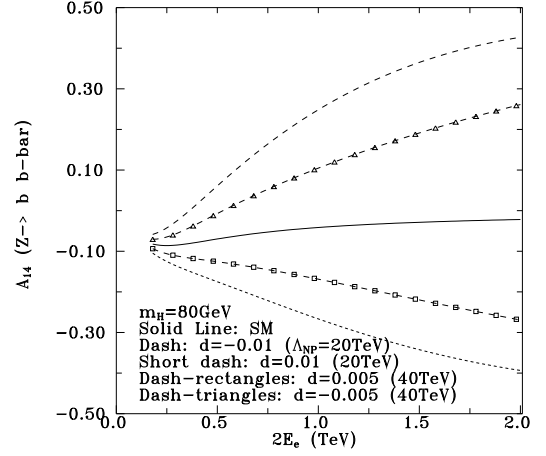

Fig 2d

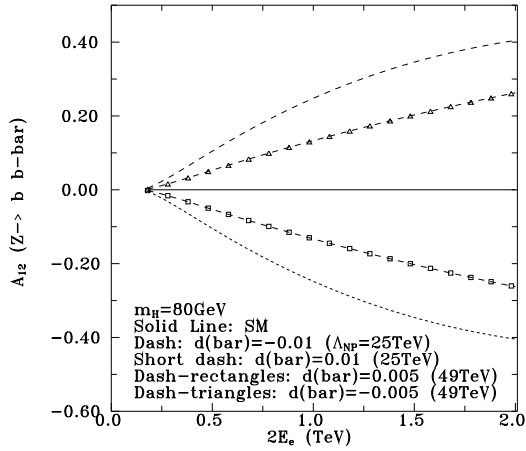

Fig 2e

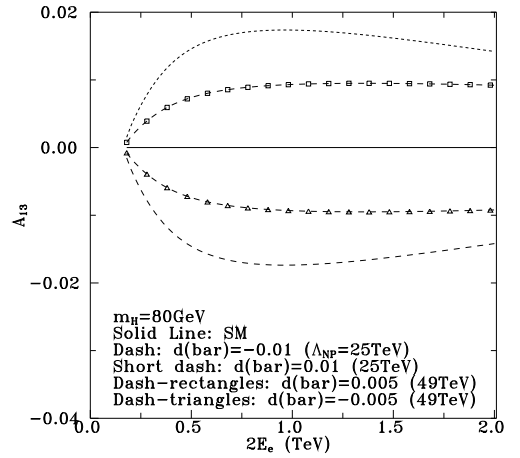

Fig 2f

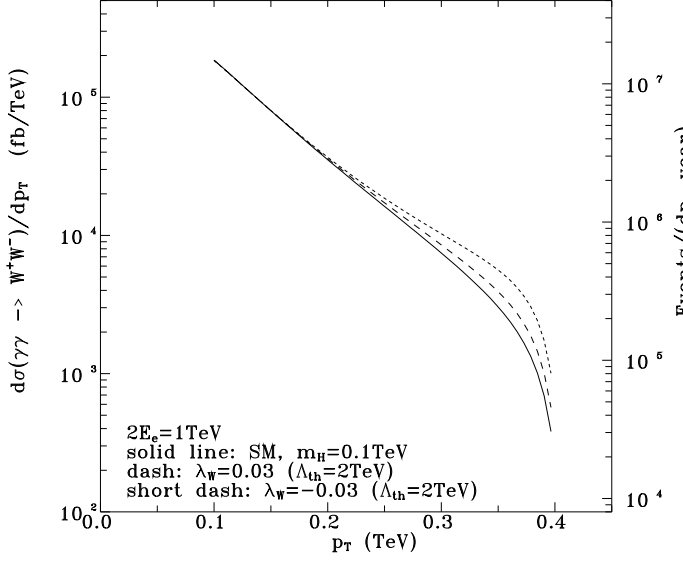

Fig 3a

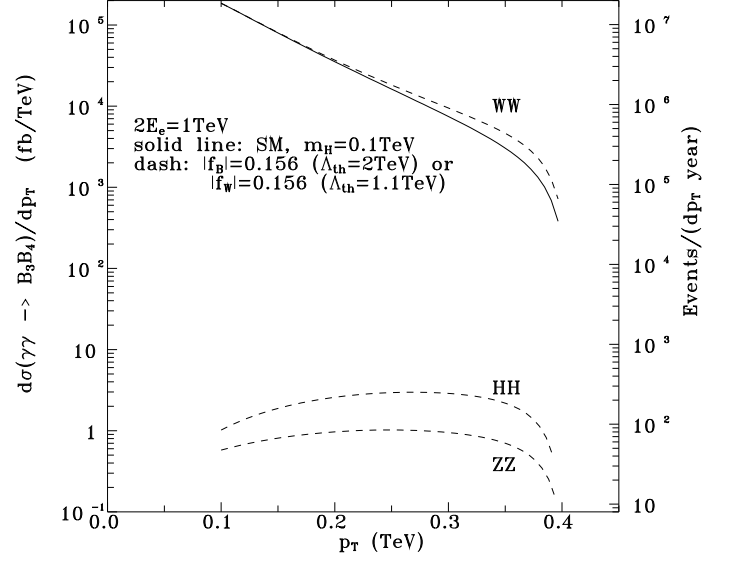

Fig 3b

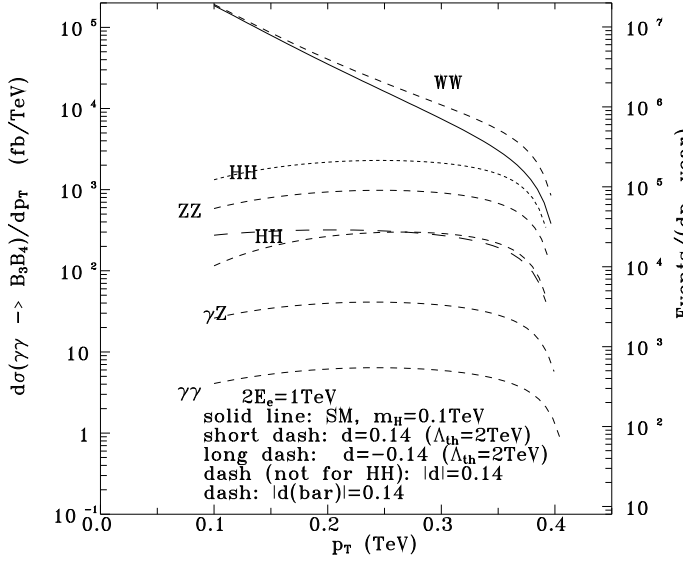

Fig 3c

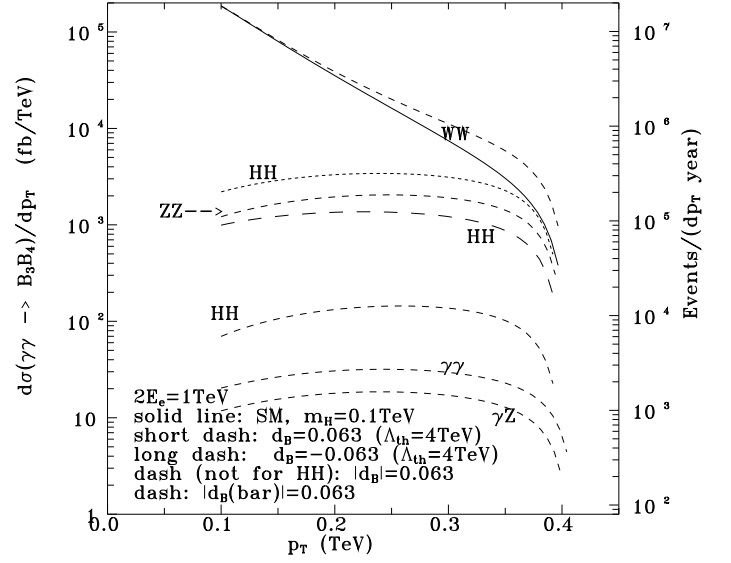

Fig 3d

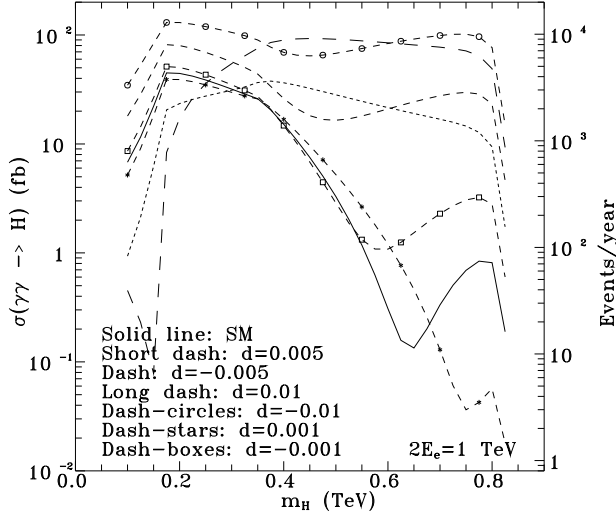

Fig 4a

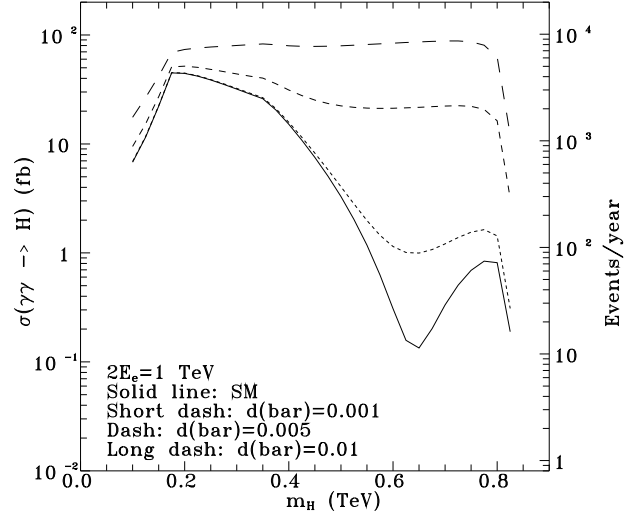

Fig 4b

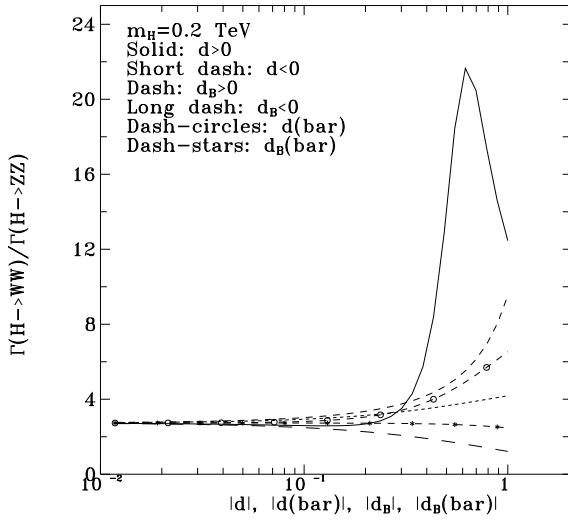

Fig 5a

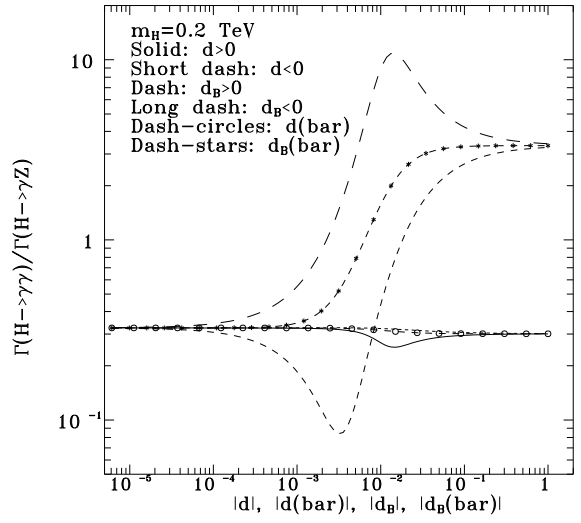

Fig 5b