

A singularity at the criticality for the free energy in percolation

Yu Zhang

June 2, 2018

Abstract

Consider percolation on the triangular lattice. Let $\kappa(p)$ be the free energy at the zero field. We show that

$$|\kappa'''(p)| \leq |p - p_c|^{-1/3+o(1)} \text{ if } p \neq p_c.$$

Furthermore, we show that there is a sequence $\epsilon_n \downarrow 0$ such that

$$\kappa'''(p_c + \epsilon_n) \leq -\epsilon_n^{-1/3+o(1)} \text{ and } \kappa'''(p_c - \epsilon_n) \geq \epsilon_n^{-1/3+o(1)}.$$

Note that these inequalities imply that $\kappa(p)$ is not third differentiable. This answers affirmatively a conjecture, asked by Sykes and Essam a half century ago, whether $\kappa(p)$ has a singularity at the criticality.

1 Introduction and statement of results.

Consider site percolation on the triangular lattice. We may realize the triangular lattice with vertex set \mathbf{Z}^2 . For a given $(x, y) \in \mathbf{Z}^2$, its nearest six neighbors are defined as $(x \pm 1, y)$, $(x, y \pm 1)$, $(x + 1, y + 1)$, and $(x - 1, y - 1)$. Edges between neighboring or adjacent vertices therefore correspond to vertical or horizontal displacements of one unit, or diagonal displacements between the two nearest vertices along lines making angles $\pi/4$ and $5\pi/4$ with the positive X -axis. Note that each site is the center of a hexagon in its dual graph. Each site or hexagon is independently *occupied* with probability p and *vacant* with probability $1 - p$. The corresponding probability measure on the configurations of occupied and vacant vertices is denoted by P_p . We also denote by E_p the expectation with respect to P_p . A path from u to v is a sequence $(v_0, \dots, v_i, v_{i+1}, \dots, v_n)$ with adjacent vertices v_i and v_{i+1} or hexagons sharing an edge ($0 \leq i \leq n - 1$) such that $v_0 = u$ and $v_n = v$. A circuit is a path with distinct vertices v_i ($1 \leq i \leq n$) except $v_0 = v_n$. A path is called occupied or vacant if all of its vertices or hexagons are occupied or vacant. The occupied cluster of the vertex x , $\mathbf{C}(x)$, consists of all vertices or hexagons that are connected to x by an occupied path. $\mathbf{C}(x)$ is an empty set if x is vacant. For any collection A of vertices, $|A|$ denotes the cardinality of A . We choose $\mathbf{0}$ as the origin. The *percolation probability* is

$$\theta(p) = P_p(|\mathbf{C}(\mathbf{0})| = \infty),$$

and the critical probability is

$$p_c = \sup\{p : \theta(p) = 0\}.$$

AMS classification: 60K35.

Key words and phrases: percolation, free energy, singularity, power laws, critical exponents.

It has been proved (see chapter 3 in Kesten (1982)) that for site percolation on the triangular lattice

$$p_c = 0.5. \tag{1.1}$$

We denote the cluster distribution by

$$\theta_n(p) = P_p(|\mathbf{C}(\mathbf{0})| = n).$$

By analogy with the Ising model, we introduce the *magnetization function* as

$$M(p, h) = 1 - \sum_{n=0}^{\infty} \theta_n(p) e^{-nh} \text{ for } h \geq 0.$$

By setting $h = 0$ in the magnetization function,

$$M(p, 0) = \theta(p).$$

Using term-by-term differentiation, we also have

$$\lim_{h \rightarrow 0^+} \frac{\partial M(p, h)}{\partial h} = E_p(|\mathbf{C}(\mathbf{0})|; |\mathbf{C}(\mathbf{0})| < \infty) = \chi^f(p).$$

$\chi^f(p)$ is called the *mean cluster size*. The *free energy* $F(p, h)$ is defined by

$$F(p, h) = h(1 - \theta_0(p)) + \sum_{n=1}^{\infty} \frac{1}{n} \theta_n(p) e^{-hn} \text{ for } h > 0.$$

If we differentiate with respect to h , we find

$$\frac{\partial F(p, h)}{\partial h} = M(p, h).$$

For $h > 0$, the free energy is infinitely differentiable with respect to p . The zero-field free energy $F(p, 0)$ is a more interesting subject of study. By our definition,

$$F(p, 0) = E_p(|\mathbf{C}(\mathbf{0})|^{-1}; |\mathbf{C}(\mathbf{0})| > 0). \tag{1.2}$$

Grimmett (1981) discovered that the zero-field free energy also coincides with the *number of clusters per vertex*. Let us define the number of clusters per vertex as follows. Note that any two vertices $x, y \in B(n) = [-n, n]^2$ are said to be connected in $B(n)$ if either $x = y$ or there exists an occupied path γ in $B(n)$ connecting x and y . Let M_n be the number of occupied clusters in $B(n)$. By a standard ergodic theorem (see Theorem 4.2 in Grimmett (1999)), the limit

$$\lim_{n \rightarrow \infty} \frac{1}{|B(n)|} M_n = \kappa(p) \text{ a.s. and } L_1 \tag{1.3}$$

exists for all $0 \leq p \leq 1$. Let $K_n = E_p(M_n)$. Thus,

$$\lim_{n \rightarrow \infty} \frac{1}{|B(n)|} K_n(p) = \kappa(p).$$

$\kappa(p)$ is called the number of clusters per vertex. Grimmett (1981) proved that

$$\kappa(p) = F(p, 0). \quad (1.4)$$

Sykes and Essam were perhaps the first to introduce the number of clusters per vertex in 1964, and they tried to use it to compute p_c . They explored a beautiful geometric argument in their paper to show

$$\kappa(p) - \kappa(1-p) = p - 3p^2 + 2p^3. \quad (1.5)$$

Sykes and Essam argued that phase transition in percolation must be manifested by a singularity at the critical value p_c . If p_c is indeed the only singularity of $\kappa(p)$, then (1.5) implies that $p_c = 0.5$. For many years, the singularity criterion of Sykes and Essam has offered a tantalizing approach to the famous problem that $p_c = 0.5$. Kesten used another method in 1980 to show $p_c = 0.5$ (see Kesten (1982)). However, until the present paper, there was no proof of a singularity at p_c for the free energy function.

We would like to mention some progress for $\kappa(p)$ throughout the years. It has been ruled out that $\kappa(p)$ has another singularity on p for $p \neq p_c$. In other words, $\kappa(p)$ is analytic for $p \neq p_c$ (see chapter 9 in Kesten (1982)). On the other hand, it has also been proved (see chapter 9 in Kesten (1982)) that $\kappa(p)$ is twice differentiable at p_c . This tells us that $\kappa(p)$ is a very smooth function. Indeed, the smoothness of $\kappa(p_c)$ might tell us why the singularity at p_c is difficult to prove. The main result obtained here is to understand the behavior of κ at the critical point. If p_c is indeed a singularity of $\kappa(p)$, then it is natural to ask about the behavior of the singularity. Physicists believe that the zero-field free energy is not third differentiable. It is believed that the behavior of percolation functions can be described in terms of critical exponents as p approaches p_c . For $\kappa(p)$, it is conjectured that there exists an exponent α such that

$$\kappa'''(p) \approx |p - p_c|^{-1-\alpha}. \quad (1.6)$$

It is not known even among physicists how strong they expect such an asymptotic “ \approx ” relation to be, and it is for this reason that we shall use the logarithmic relation. More precisely, $f(p) \approx g(p)$ or $f_n \approx g_n$ means

$$\log g(p)/\log f(p) \rightarrow 1 \text{ as } p \rightarrow p_c \text{ or } \log f_n/\log g_n \rightarrow 1 \text{ as } n \rightarrow \infty.$$

The exponent α is called the *heat exponent*, and (1.6) is called the *power law* for the free energy. Numerical computations indicate $\alpha = -2/3$. In addition to this power law, it is also widely believed that the exponents satisfy the following so-called *scaling laws*. To be more specific, we need to introduce all the other critical exponents and power laws. We denote the *correlation length* by

$$\xi^{-1}(p) = \lim_{n \rightarrow \infty} \left\{ -\frac{1}{n} \log P_p(\mathbf{0} \rightarrow \partial B(n), |\mathbf{C}(\mathbf{0})| < \infty) \right\} \text{ if } p \neq p_c,$$

and the *probability on the tail* of $|\mathbf{C}(\mathbf{0})|$ at p_c by

$$\pi(n) = P_{p_c}(n \leq |\mathbf{C}(\mathbf{0})| < \infty),$$

where $\partial B(n)$ is the surface of the box $B(n)$ and $A \rightarrow B$ means that there exists an occupied path from some vertex of A to some vertex of B for any sets A and B .

The power laws are introduced as follows:

$$\theta(p) \approx (p - p_c)^\beta \text{ for } p > p_c,$$

$$\begin{aligned}\chi^f(p) &\approx (p_c - p)^{-\gamma} \text{ for } p \neq p_c, \\ \xi(p) &\approx |p_c - p|^{-\nu} \text{ for } p \neq p_c,\end{aligned}\tag{1.7}$$

$$\pi(n) \approx n^{-1/\rho} \text{ for } n \geq 1,\tag{1.8}$$

$$\kappa'''(p) \approx |p - p_c|^{-1-\alpha} \text{ for } p \neq p_c.\tag{1.9}$$

Numerical computations indicate that

$$\beta = \frac{5}{36}, \gamma = \frac{43}{18}, \nu = \frac{4}{3}, \rho = \frac{91}{5}.$$

In addition to the power laws, it is also widely believed that the exponents satisfy the following so-called scaling laws:

$$\alpha = 2 - 2\nu,\tag{1.10}$$

$$\beta = \frac{2\nu}{\rho + 1},\tag{1.11}$$

$$\gamma = 2\nu \frac{\rho - 1}{\rho + 1}.\tag{1.12}$$

In particular, (1.10) is called a *hyper scaling* relation. Moreover, let us introduce k -arm paths. Consider the annulus

$$A(m, n) = \{B(n) \setminus B(m)\} \cup \{\partial B(m)\} \text{ for } m < n.$$

Let $\mathcal{Q}_k(b, m, n)$ be the event that there exist i disjoint occupied paths and j disjoint vacant paths with $i + j = k$ for all $i, j \geq 1$ from $b + \partial B(m)$ to $b + \partial B(n)$ inside $A(m, n)$. We call them *k-arm paths*. For simplicity, let $\mathcal{Q}_k(m, n) = \mathcal{Q}_k(\mathbf{0}, m, n)$. If $b \in B(n)$, let $\mathcal{Q}_k(b, n)$ be the k -arm paths from b to $\partial B(n)$. Let $\mathcal{Q}_4(n) = \mathcal{Q}_4(\mathbf{0}, n)$ for simplicity. It is believed by Aizenman, Dulpantier, and Alharony (1999) that

$$P_{0.5}(\mathcal{Q}_k(m, n)) = \left(\frac{m}{n}\right)^{(k^2-1)/12+o(1)}\tag{1.13}$$

for fixed m as $n \rightarrow \infty$. In fact, it is more important to show (1.13) when $k = 1$ and $k = 4$. Fortunately, by using the Schramm-Loewner evolution (SLE) argument and Smirnov's scaling limit on the triangular lattice, (1.13) was proved (see Lawler, Schramm, and Werner (2002) and Smirnov and Werner's Theorem 4 (2001)) for $k = 1$ and $k = 4$. More precisely, on the triangular lattice,

$$P_{0.5}(\mathcal{Q}_4(m, n)) = \left(\frac{m}{n}\right)^{5/4+o(1)} \text{ and } P_{0.5}(\mathcal{Q}_1(m, n)) = \left(\frac{m}{n}\right)^{5/48+o(1)}.\tag{1.14}$$

For the other two-dimensional lattices, it has been shown that there exists $\delta > 0$ such that

$$P_{p_c}(\mathcal{Q}_4(m, n)) \leq \left(\frac{m}{n}\right)^{1+\delta} \text{ and } P_{p_c}(\mathcal{Q}_1(m, n)) \leq \left(\frac{m}{n}\right)^\delta.\tag{1.15}$$

In particular, Kesten, Sidoravicius, and Zhang (1998) showed that (1.14) holds for $k = 5$ for all the two-dimensional lattices without using an SLE approach. Indeed, they showed that there exist C_1 and C_2 such that

$$C_1 \left(\frac{m}{n}\right)^2 \leq P_{0.5}(\mathcal{Q}_5(m, n)) \leq C_2 \left(\frac{m}{n}\right)^2.\tag{1.16}$$

In this paper, C and C_i are positive constants independent of n , m , and k and p . They also change from appearance to appearance. When we need to indicate that C depends on a particular parameter, for example, α , we will write $C = C(\alpha)$.

It is interesting to point out that $(k^2 - 1)/12$ is always a positive integer if $k \geq 5$ is a prime number. However, not only prime number k satisfies that $(k^2 - 1)/12$ is an integer. For example, if $k = 35$, then $(k^2 - 1)/12$ is an integer. It might be easier to show (1.13) when $(k^2 - 1)/12$ is an integer as Kesten, Sidoravicius, and Zhang did in (1.16). On the other hand, two-arm path and three-arm path power laws in the half space are well understood. Let $\mathcal{H}_k(m, n)$ be the event that there are i -disjoint occupied paths and j disjoint vacant paths in the upper half space with $i + j = k$ from $\partial B(m)$ to $\partial B(n)$ for $i, j \geq 1$. It is believed that

$$P_{0.5}(\mathcal{H}_k(m, n)) = \left(\frac{m}{n}\right)^{k(k+1)/6+o(1)}. \quad (1.17)$$

It has been proved (see Higuchi, Takei, and Zhang (2012)) that (1.17) holds for $k = 2$ and $k = 3$ and for all the two-dimensional lattices. We know that (1.14) together with an argument of Kesten (see Corollaries 1 and 2 in Kesten (1987)) imply that all the power laws and scaling relations hold except possibly for (1.6). Here we will give the following theorem to discuss the power laws concerning for the free energy function.

Theorem. *For percolation on the triangular lattice,*

$$|\kappa'''(p)| \leq |p - 0.5|^{-1/3+o(1)} \text{ if } p \neq 0.5.$$

Furthermore, we show that there is a sequence $\epsilon_n \downarrow 0$ such that

$$\kappa'''(0.5 + \epsilon_n) \leq -\epsilon_n^{-1/3+o(1)} \text{ and } \kappa'''(0.5 - \epsilon_n) \geq \epsilon_n^{-1/3+o(1)}.$$

Remarks. 1. The theorem implies that $\kappa(p)$ is not third differentiable.
 2. The requirement of the proof for the triangular lattice in the theorem is (1.14) and Lemma 6. If one can show them on the other lattices, then the theorem will work on those lattices.
 3. We only show that there is a sequence ϵ_n ; we are unable to show that for any ϵ_n the theorem holds. However, we can do a little better estimate than the lower bound in the theorem. In the proof of the lower bound in section 6, we can show that if $L(p_2)/L(p_1) \geq M$ for some $M > 0$ and for $p_1 < p_2 < 0.5$, then

$$\frac{\kappa''(p_2) - \kappa''(p_1)}{p_2 - p_1} \geq (p_2 - p_1)^{-1/3+o(1)}.$$

Acknowledgments. The author would like to thank Harry Kesten for many fruitful conversations, and he would also like to thank Geoffrey Grimmett for his many comments.

2 Preliminaries.

In this section, we introduce a few basic properties and estimates of site percolation in the triangular lattice. Most results are obtained from Kesten (1982) and (1987). For any $u = (u_1, u_2) \in \mathbf{Z}^2$, let

$\|u\| = \max\{u_1, u_2\}$. For $u, v \in \mathbf{Z}^2$, let $d(u, v) = \|u - v\|$. Given a finite connected graph G , as we defined in section 1, a vertex $u \notin G$ but adjacent to G is called the *boundary vertex* of G . We denote by ∂G the boundary vertices of G . If a vertex $v \in \partial G$, and there is an infinite path from v without using G , then v is called the *exterior boundary* vertex. We denote by ΔG all the exterior boundary vertices of G . We introduce a topology result (see Lemma 2.23 in Kesten (1982) or Proposition 11.2 in Grimmett (1999)).

Lemma 1. *If G is a finite cluster, then $\Delta(G)$ is a circuit containing G in its interior. Furthermore, $\Delta(G)$ is the smallest vacant circuit containing G in its interior if G is occupied.*

Now we define occupied and vacant crossings in a box. A left-right (respectively, top-bottom) occupied crossing of $B(n)$ is an occupied path in $B(n)$ that joins some vertex on the left (respectively upper) side of $B(n)$ to some vertex on the right (respectively, lower) side of $B(n)$ but uses no vertices in the boundary of $B(n)$. Similarly, we may define a vacant crossing on $B(n)$. We denote the occupied and the vacant crossing probabilities of $B(n)$ by

$$\sigma(p, n) = P_p(\exists \text{ a left-right occupied crossing of } B(n)) \text{ and}$$

$$\sigma^*(p, n) = P_p(\exists \text{ a top-bottom vacant crossing of } B(n)).$$

We need to show that the vacant crossing and occupied crossing probabilities of squares are bounded away from zero when p is near p_c . To make this precise, we first define (see (1.21) in Kesten (1987))

$$L(p) = \min\{n : \sigma(p, n) \geq 1 - \epsilon_0\} \text{ for } p > p_c \text{ and } L(p) = \min\{n : \sigma^*(p, n) \geq \epsilon_0\} \text{ for } p < p_c, \quad (2.1)$$

where ϵ_0 is some small but strictly positive number whose precise value is not important. The important property is that ϵ_0 can be chosen such that there exists a constant δ for which

$$\sigma(p, n) \geq \delta \text{ and } \sigma^*(p, n) \geq \delta$$

uniformly in $n \leq L(p)$. $L(p)$ is also called the correlation length, and it is proved (see Corollary 2 in Kesten (1987)) that

$$L(p) \asymp \xi(p), \quad (2.2)$$

where $f(p) \asymp g(p)$ or $f_n \asymp g_n$ means

$$f(p)/g(p) = O(1) \text{ and } f_n/g_n = O(1).$$

By (1.14) and Kesten's Corollaries 1 and 2, for all $p \neq 0.5$,

$$L(p) \asymp \xi(p) \approx |0.5 - p|^{-4/3}. \quad (2.3)$$

On the other hand, it is known (see chapter 11 in Grimmett (1999)) that for any n there exists $C > 0$ such that

$$\sigma(0.5, n) \asymp \sigma^*(0.5, n) \asymp C.$$

If $p \neq 0.5$ and $n \leq L(p)$, Kesten's Theorem 1 and Lemma 8 (1987) show that $P_p(\mathcal{Q}_l(n))$ has the same decay rate as $P_{0.5}(\mathcal{Q}_l(n))$ for $l = 1$ and $l = 4$. Together with his Lemmas 4 and 7, it shows that $P_p(\mathcal{Q}_l(m, n))$ has the same decay rate as $P_{0.5}(\mathcal{Q}_l(m, n))$ for $l = 1$ and $l = 4$. Here we summarize his

results as the following Lemma.

Lemma 2. (Kesten (1987)). *If $m \leq n \leq L(p)$,*

$$P_p(\mathcal{Q}_1(m, n)) \asymp P_{0.5}(\mathcal{Q}_1(m, n)) \text{ and } P_p(\mathcal{Q}_4(m, n)) \asymp P_{0.5}(\mathcal{Q}_4(m, n)).$$

Thus by Lemma 2 and (1.14), for $m < n \leq L(p)$,

$$P_p(\mathcal{Q}_4(m, n)) = \left(\frac{m}{n}\right)^{5/4+o(1)}.$$

It is well known that the size of an occupied cluster decays exponentially (see Theorem 6.10 in Grimmett (1999)) when $p < p_c$:

$$C_1 n^{-1} \exp(-\xi^{-1}(p)n) \leq P_p(\mathbf{0} \rightarrow \partial B(n)) \leq C_2 n \exp(-\xi^{-1}(p)n).$$

By using (2.1) and (2.2), we obtain the following better estimate.

Lemma 3. *If $p < p_c$, then there exist C_i for $i = 1, 2$ such that for any $n \geq L(p)$,*

$$C_1 \frac{L(p)}{n} \exp(-L^{-1}(p)n) \leq P_p(\mathbf{0} \rightarrow \partial B(n)) \leq C_2 \frac{n}{L(p)} \exp(-L^{-1}(p)n).$$

Proof. Let $\beta(n) = P_p(\mathbf{0} \rightarrow \partial B(n))$. For $m \geq L(p)$, we may divide the parameter of $\partial B(m)$ into $m/L(p)$ segments such that each one has a length $L(p)$. For each segment, by using (2.1) and the RSW lemma, there is an occupied circuit surrounding it with a positive probability. Then we use the exact proof of (6.21) in Grimmett (1999) to show

$$\beta(n+m) \leq C_1(m/L(p))\beta(m)\beta(n). \tag{2.4}$$

The same method, together with (6.27) in Grimmett (1999), implies that

$$\beta(n+m) \geq C_2(L(p)/m)\beta(m)\beta(n). \tag{2.5}$$

So together with (2.2), Lemma 3 follows from (2.4),(2.5), and the same proof of Theorem 5.10 in Grimmett (1999). \square

By Lemmas 2 and 3, if $p \leq 0.5$, for all $m < n$,

$$P_p(\mathcal{Q}_4(m, n)) \leq \left(\frac{m}{n}\right)^{5/4+o(1)}. \tag{2.6}$$

By (2.24) in Kesten (1987), we have for a large M ,

$$P_p(B(L(p)) \rightarrow \partial B(ML(p))) \leq C \exp(-C_1 M). \tag{2.7}$$

By using (2.7), we have the following lemma.

Lemma 4. *If $p < 0.5$, for $m \geq 1$,*

$$\sum_{i \geq mL(p)} iP_p(B(L(p)) \rightarrow \partial B(i)) \leq CL^2(p) \exp(-C_1 m).$$

Proof. By (2.7),

$$\begin{aligned} \sum_{i \geq mL(p)} iP_p(B(L(p)) \rightarrow \partial B(i)) &\leq \sum_{k=m}^{\infty} \sum_{kL(p) \leq i \leq (k+1)L(p)} iP_p(B(L(p)) \rightarrow \partial B(i)) \\ &\leq 4CL^2(p) \sum_{k=m}^{\infty} (k+1)^2 \exp(-C_1 k) \leq C_2 L^2(p) m^2 \exp(-C_1 m) \leq C_2 L^2(p) \exp(-C_3 m). \end{aligned}$$

Lemma 4 follows. \square

Kesten in his Lemma 8 (1987) showed the following estimate:

$$L^2(p)P_p(Q_4(L(p))) \asymp (0.5 - p)^{-1}. \quad (2.8)$$

For convenience, we reselect $L(p)$ such that

$$L^2(p)P_p(Q_4(L(p))) = (0.5 - p)^{-1}. \quad (2.9)$$

In the following sections, we always assume that (2.9) holds for $L(p)$. Given four-arm paths in a square $B(n)$ and four-arm paths in an annulus $A(n, m)$ for $n < m$, one of major estimates (see Lemma 4 and Lemma 6 in Kesten (1987)) is to reconnect them by costing a constant probability independent of n and m . It is a more general argument than the RSW lemma since the RSW only reconnects the occupied or vacant paths. This connection is called the *reconnection lemma*.

Reconnection lemma. (Kesten (1987)). *If $n \leq L(p)$ and $n \leq m$ for $p \leq 0.5$, there exists C (independent of n, m) such that*

$$P_p(Q_4(n)P_p(Q_4(n, m))) \leq CP_p(Q_4(m)).$$

Another lemma (see Kesten's Lemma 7 (2.58) (1987)) as the following lemma is useful when we estimate the pivotals in a square box.

Lemma 5. (Kesten (1987)). *For $p < 0.5$ and for j with $2^{j+1} \leq 2^k \leq L(p)$, there exists $\xi > 0$ (independent of p) such that*

$$2^{2j} P_p(Q_4(2^j)) \asymp \sum_{b \in B(2^{j-1})} P_p(Q_4(b, B(2^j))) \leq C(0.5 - p)^{-1} 2^{-\xi(k-j)}.$$

Garban, Pete, and Schramm (2013) introduced a scaling limit when p is near p_c . Let A and B be the connected vertex sets in a square S such that ∂A and ∂B consist of four-piece boundaries ∂A_i and ∂B_i for $i = 1, 2, 3, 4$. A and B are called *quad*. We consider $\alpha_i(p) = \lambda L(p) \partial A_i$ for $i = 1, 2, 3, 4$ and $\beta_i(p) = \lambda L(p) \partial B_i$ for p near p_c . Let $\mathcal{Q}_4(\cup_{i=1}^4 \alpha_i(p), \cup_{i=1}^4 \beta_i(p))$ be the event that there are four-arm paths

from $\alpha_i(p)$ to $\beta_i(p)$ inside $L(p)S$. With this definition, Garban, Pete, and Schramm (see Theorem 9.5, (2013)) showed the following lemma. Here we want to remark that in their Theorem 9.5, they showed that four-arm paths are from $\alpha_i(p)$ to the four-piece boundaries of $L(p)\partial S$. The same proof of their argument can be adapted to show our situation. In fact, the key to the proof depends on their scaling limit theorem in Lemma 2.9 (2010). It shows that these four-arm paths have to be well separated from $\cup_{i=1}^4 \alpha_i(p)$ to the four boundaries of $\lambda L(p)B$. With the same decomposition, the four-arm paths are also well separated from $\cup_{i=1}^4 \alpha_i(p)$ to $\cup_{i=1}^4 \beta_i(p)$. The remaining estimates also work for our situation. Furthermore, they also investigated the limit behavior, but we do not need this strong argument here.

Lemma 6. (Garban, Pete, and Schramm (2003)). *For each $0 < \lambda < \infty$, there exists $\gamma(\lambda)$ such that*

$$\lim_{p \rightarrow 0.5} P_p \left(\mathcal{Q}_4(\cup_{i=1}^4 \alpha_i(p), \cup_{i=1}^4 \beta_i(p)) \right) = \gamma(\lambda).$$

3 Derivative of $K_n(p)$ by finding its pivotal.

The derivative of $K_n(p)$ in the triangular lattice is much more complicated than the derivative in the square lattice (see Zhang (2011)) since each vertex has six neighbors. Let us define for $v \in B(n)$, $N_n(v)$ as the number of distinct occupied clusters in $B(n)$, obtained after setting v to be vacant, which contains a neighbor of v . It follows from (5.5) in Aizenman, Kesten, and Newman (1987) or Theorem 4.3 in Grimmett (1981) that

$$\frac{dK_n(p)}{dp} = \sum_{v \in B(n)} E_p(1 - N_n(v)). \quad (3.1)$$

Note that there is no infinite occupied cluster in $[0, 0.5]$, so by (3.1) and a standard ergodic theorem (see Dunford and Schwartz Theorem VIII 6.9 (1958)),

$$\kappa'(p) = \lim_{n \rightarrow \infty} |B(n)|^{-1} \frac{dK_n(p)}{dp} = 1 - \lim_{n \rightarrow \infty} E_p(N_n(\mathbf{0})). \quad (3.2)$$

Note also that $N_n(\mathbf{0})$ is neither increasing nor decreasing, so to take another derivative, we simply need to fix the configurations of vertices adjacent to the origin. There are six vertices, denoted by b_i for $i = 1, 2, 3, 4, 5, 6$, adjacent to the origin. We will try to fix the configurations of these six vertices. Let \mathcal{E} be the event that there are at least two occupied vertices in $\{b_1, b_2, b_3, b_4, b_5, b_6\}$, and they are separated by vacant vertices. For example, b_1 and b_3 are occupied and the others are vacant. On \mathcal{E}^C , $N_n(\mathbf{0})$ (either zero or one) does not depend on the configurations outside of $\{\mathbf{0}, b_1, b_2, b_3, b_4, b_5, b_6\}$. We may divide \mathcal{E}^C into \mathcal{E}_0^C or \mathcal{E}_1^C : all $\{b_1, b_2, b_3, b_4, b_5, b_6\}$ are vacant or only one connected occupied cluster is among them, respectively. Thus,

$$E_p(N_n(\mathbf{0}); \mathcal{E}^C) = P_p(\mathcal{E}_1^C) = f(p) \quad (3.3)$$

for a polynomial $f(p)$ with a degree not more than 6.

We divide \mathcal{E} into a few disjoint configurations. We denote by \mathcal{E}_{AB} the event, for $A, B \subset \{b_1, b_2, b_3, b_4, b_5, b_6\}$, that A and B are occupied vertex sets separated by two vacant vertex sets A' and B' in $\{b_1, b_2, b_3, b_4, b_5, b_6\}$. In addition, A, B, A', B' are adjacent individually in vertices $\{b_1, b_2, b_3, b_4, b_5, b_6\}$. For example, $A = \{b_1\}$,

$A' = \{b_2, b_3\}$, $B = \{b_4, b_5\}$, and $B' = \{b_6\}$. We also denote by $\mathcal{E}_{1,3,5}$ or $\mathcal{E}_{2,4,6}$ the events that b_1 , b_3 , and b_5 , or b_2 , b_4 , and b_6 are occupied and the others are vacant, respectively. Thus, by (3.3) and symmetry,

$$\begin{aligned} & E_p(N_n(\mathbf{0})) \\ &= \sum_{A,B} E_p(N_n(\mathbf{0}) \mid \mathcal{E}_{AB}) f_{AB}(p) + E_p(N_n(\mathbf{0}) \mid \mathcal{E}_{1,3,5}) f_{1,3,5}(p) + E_p(N_n(\mathbf{0}) \mid \mathcal{E}_{2,4,6}) f_{2,4,6}(p) + f(p) \\ &= \sum_{A,B} E_p(N_n(\mathbf{0}) \mid \mathcal{E}_{AB}) f_{AB}(p) + 2E_p(N_n(\mathbf{0}) \mid \mathcal{E}_{1,3,5}) f_{1,3,5}(p) + f(p), \end{aligned}$$

where the first sum takes all possible A and B and $f_{AB}(p) = P_p(\mathcal{E}_{AB})$, $f_{1,3,5}(p) = P_p(\mathcal{E}_{1,3,5})$, and $f_{2,4,6}(p) = P_p(\mathcal{E}_{2,4,6})$ are polynomials with degrees less than 6. Therefore,

$$\begin{aligned} \frac{dE_p(N_n(\mathbf{0}))}{dp} &= \sum_{A,B} \frac{dE_p(N_n(\mathbf{0}) \mid \mathcal{E}_{AB})}{dp} f_{AB}(p) + \sum_{A,B} E_p(N_n(\mathbf{0}) \mid \mathcal{E}_{AB}) f'_{AB}(p) \\ &+ 2 \frac{dE_p(N_n(\mathbf{0}) \mid \mathcal{E}_{1,3,5})}{dp} f_{1,3,5}(p) + 2E_p(N_n(\mathbf{0}) \mid \mathcal{E}_{1,3,5}) f'_{1,3,5}(p) + f'(p). \end{aligned} \quad (3.4)$$

After taking this derivative, the first sum and the third term in the right side of (3.4) play the most important roles. Let us focus on a term in the first sum in the right side of (3.4): $dE_p(N_n(\mathbf{0}) \mid \mathcal{E}_{AB})/dp$ for fixed sets A and B . Note that

$$E_p(N_n(\mathbf{0}) \mid \mathcal{E}_{AB}) = P_p(N_n(\mathbf{0}) \geq 2 \mid \mathcal{E}_{AB}) + P_p(N_n(\mathbf{0}) \geq 1 \mid \mathcal{E}_{AB}) = P_p(N_n(\mathbf{0}) = 2 \mid \mathcal{E}_{AB}) + 1$$

and $\{N_n(\mathbf{0}) \geq 2 \mid \mathcal{E}_{AB}\} = \{N_n(\mathbf{0}) = 2 \mid \mathcal{E}_{AB}\}$ is a decreasing event for the configurations on $B(n)$ except for the origin and its neighbors. By Russo's formula, if $\{N_n(\mathbf{0}) = 2 \mid \mathcal{E}_{AB}\}(b)$ is the event that b is a pivotal site (see Fig. 1.1 and the definition for a pivotal in Kesten (1982)), then

$$\begin{aligned} \frac{dE_p(N_n(\mathbf{0}) \mid \mathcal{E}_{AB})}{dp} &= - \sum_{b \in B(n), b \neq \mathbf{0}} P_p(\{N_n(\mathbf{0}) = 2 \mid \mathcal{E}_{AB}\}(b)) \\ &= - \sum_{b \in B(n), b \neq \mathbf{0}} P_p(\{N_n(\mathbf{0}) = 1 \text{ or } 2 \text{ if } b \text{ is occupied or vacant}\} \mid \mathcal{E}_{AB}), \end{aligned} \quad (3.5)$$

where $b \neq \mathbf{0}$ means that $b \neq \mathbf{0}$ is not adjacent to $\mathbf{0}$. Let $\mathbf{C}_n(A)$ be the occupied cluster by assuming A is occupied in $B(n) \setminus \{\mathbf{0}\}$ on \mathcal{E}_{AB} , and let $\Delta \mathbf{C}_n(A)$ be the sites of the exterior boundary of $\mathbf{C}_n(A)$. We can rewrite $\{N_n(\mathbf{0}) = 1 \text{ or } 2 \text{ if } b \text{ is occupied or vacant}\} \mid \mathcal{E}_{AB}$ as

$$\mathcal{D}_{AB}(b, n) = \{\mathbf{C}_n(A) \cap \mathbf{C}_n(B) = \emptyset, b \in \Delta \mathbf{C}_n(A) \cap \Delta \mathbf{C}_n(B)\}. \quad (3.6)$$

Now we need to write $\mathcal{D}_{AB}(b, n)$ into occupied and vacant paths. Let (see Fig. 1.5 and Fig. 1.6)

$$\begin{aligned} \bar{\mathcal{R}}_{AB}(b, n) &= \\ &\{\exists \text{ disjoint occupied paths } r_2 \text{ and } r_4 \text{ in } B(n) \setminus \mathbf{0} \text{ from } A \text{ and } B \text{ to two neighbors of } b; \\ &\quad \exists \text{ a vacant } r_3 \text{ on } B(n) \setminus \mathbf{0} \text{ inside } S(r_2, r_4, b) \text{ from } A' \text{ or } B' \text{ to a neighbor of } b; \exists \text{ a vacant path } \\ &\quad r_1 \text{ inside } B(n) \setminus \mathbf{0} \text{ from } B' \text{ or } A' \text{ to a neighbor of } b \text{ but outside the closure of } S(r_2, r_4, b) \text{ or} \\ &\quad \exists \text{ disjoint vacant paths } r_5 \text{ and } r_6 \text{ inside } B(n) \setminus \mathbf{0} \text{ from } B' \text{ and from a neighbor of } b \text{ to } \partial B(n), \\ &\quad \text{but outside the closure of } S(r_2, r_4, b), \text{ and } \exists \text{ an occupied path from } r_2 \text{ or } r_4 \text{ to } \partial B(n)\}, \end{aligned}$$

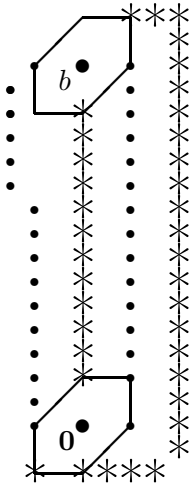

Fig. 1.1

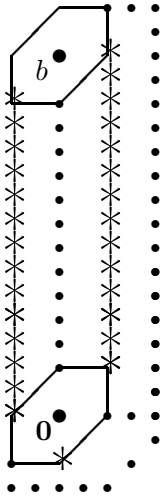

Fig. 1.2

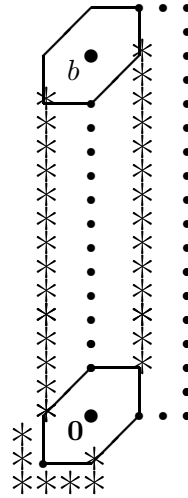

Fig. 1.3

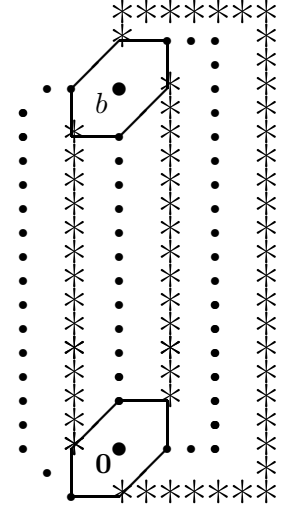

Fig. 1.4

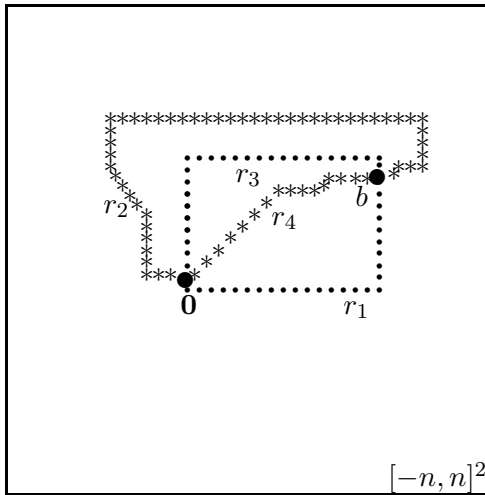

Fig. 1.5

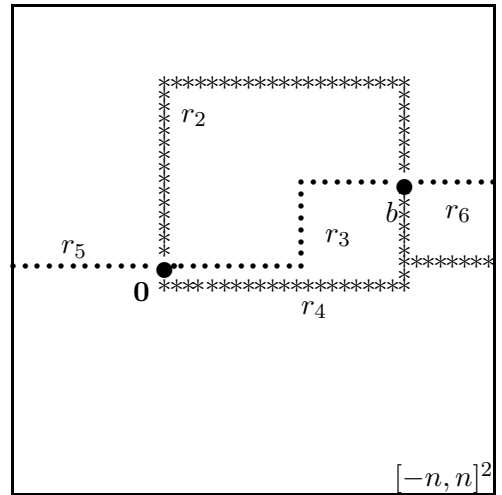

Fig. 1.6

Figure 1: *Fig. 1.5 is event $\mathcal{R}(b, n)$. Fig. 1.5 and Fig. 1.6 are the two situations of $\bar{\mathcal{R}}(b, n)$. In Fig. 1.6, since r_1 does not exist, we have an occupied path separating r_5 and r_6 . Fig. 1.1 shows that b is a pivotal for $P_p(N(\mathbf{0}) = 2 \mid \mathcal{E}_{AB})$. Fig. 1.2 and Fig. 1.4 show that b is a pivotal for $P_p(N(\mathbf{0}) = 3 \mid \mathcal{E}_{1,3,5})$. Figs. 1.2, 1.3, and Fig. 1.4 show that b is a pivotal for $P_p(N(\mathbf{0}) \geq 2 \mid \mathcal{E}_{1,3,5})$. The solid dotted-paths are vacant, and the $*$ -paths are occupied.*

where $S(r_2, r_4, b)$ is the open set enclosed by the circuit $r_2 \cup \mathbf{0} \cup r_4 \cup b$ and a path from A means the path starting from a neighbor of A .

A pivotal for a positive or a negative event related to four-arm paths around the pivotal is well understood (see Lemma 8 in Kesten (1987)). The following lemma is a pure topology argument to tell the relation between the right side of (3.5) and the occupied and vacant paths in $\bar{\mathcal{R}}_{AB}(b, n)$. It is easy to be convinced by graphs (see Figs. 1.1–1.6), but it is tedious to show it. So we omit the proof.

Lemma 7. *For a fixed disjoint A and B in $\{b_1, b_2, b_3, b_4, b_5, b_6\}$ and $b \neq \mathbf{0}$,*

$$\{N_n(\mathbf{0}) = 1 \text{ or } 2 \text{ if } b \text{ is occupied or vacant} \mid \mathcal{E}_{AB}\} = \bar{\mathcal{R}}_{AB}(b, n).$$

Let

$$P_{p,AB}(\cdot) = P_p(\cdot \mid \mathcal{E}_{AB}).$$

Note that $\bar{\mathcal{R}}_{AB}(b, n)$ does not depend on the configurations of $\mathbf{0}$, A , A' , B , and B' , so it follows from Lemma 7 that

$$\frac{dE_p(N_n(\mathbf{0}) \mid \mathcal{E}_{AB})}{dp} = - \sum_{b \in B(n), b \neq \mathbf{0}} P_{p,AB}(\bar{\mathcal{R}}_{AB}(b, n)) = - \sum_{b \in B(n), b \neq \mathbf{0}} P_p(\bar{\mathcal{R}}_{AB}(b, n)). \quad (3.7)$$

When we estimate the upper bound of the third derivative of $\kappa(p)$, we only need to deal with the following simpler event (see Fig. 1.1 and Fig. 1.5). For fixed vertex b inside $B(n)$, let

$$\begin{aligned} \mathcal{R}_{AB}(b, n) = & \\ & \{\exists \text{ disjoint occupied paths } r_2 \text{ and } r_4 \text{ in } B(n^2) \text{ from } A \text{ and } B \text{ to two neighbors of } b; \\ & \exists \text{ a vacant path } r_3 \text{ on } B(n^2) \text{ inside } S(r_2, r_4, b) \text{ from } A' \text{ or } B' \text{ to a neighbor of } b; \\ & \exists \text{ path } r_1 \text{ inside } B(n^2) \text{ from } B' \text{ or } A' \text{ to a neighbor of } b \text{ but outside the closure of } S(r_2, r_4, b)\}. \end{aligned}$$

We use $B(n^2)$ in the definition of $\mathcal{R}_{AB}(b, n)$ since we need paths to be far away from $\partial B(n^2)$. For each n , let

$$R_{AB}(p, n) = \sum_{b \in B(n), b \neq \mathbf{0}} P_p(\mathcal{R}_{AB}(b, n)).$$

Since there is no infinite occupied cluster, the existence of an occupied path from the origin to $\partial B(n)$ is unlikely to occur. In other words, we can use $\mathcal{R}_{AB}(b, n)$ to replace $\bar{\mathcal{R}}_{AB}(b, n)$ without losing too much. More precisely, we show the following lemma.

Lemma 8. *For each A and B , $\frac{dE_p(N_n(\mathbf{0}) \mid \mathcal{E}_{AB})}{dp}$ and $R_{AB}(p, n)$ converge uniformly on $[0, 0.5]$ such that*

$$- \lim_{n \rightarrow \infty} \frac{dE_p(N_n(\mathbf{0}) \mid \mathcal{E}_{AB})}{dp} = \lim_{n \rightarrow \infty} R_{AB}(p, n). \quad (3.8)$$

Furthermore, if $p_0 < 0.5$, for $i \geq 2$

$$- \lim_{n \rightarrow \infty} \frac{d^i E_p(N_n(\mathbf{0}) \mid \mathcal{E}_{AB})}{dp^i} = \lim_{n \rightarrow \infty} \frac{d^{i-1} R_{AB}(p, n)}{dp^{i-1}} \text{ converges uniformly on } [0, p_0]. \quad (3.9)$$

Proof. We first show that $\sum_{b \in B(n), b \neq \mathbf{0}} P_p(\bar{\mathcal{R}}_n(b, n))$ converges uniformly on $[0, 0.5]$. For each A and B ,

$$\begin{aligned} \sum_{b \in B(n), b \neq \mathbf{0}} P_p(\bar{\mathcal{R}}_{AB}(b, n)) &\leq \sum_{i=1}^{n+1} \sum_{\substack{b \in B(n), \\ \|b\|=i}} P_p(\bar{\mathcal{R}}_{AB}(b, n)) \\ &= \sum_{i=1}^{n/2} \sum_{\substack{b \in B(n), \\ \|b\|=i}} P_p(\bar{\mathcal{R}}_{AB}(b, n)) + \sum_{i=n/2}^{n+1} \sum_{\substack{b \in B(n), \\ \|b\|=i}} P_p(\bar{\mathcal{R}}_{AB}(b, n)). \end{aligned}$$

We denote by I and II the two sums above. We estimate I first. By the definition of $\bar{\mathcal{R}}_{AB}(b, n)$, we know that if $\{\bar{\mathcal{R}}_{AB}(b, n)\}$ occurs for $i \leq n/2$, then $\mathcal{Q}_4(\mathbf{0}, 2, i/4)$ and $\mathcal{Q}_4(b, 0, i/4)$ occur independently (see Figs. 1.5 and 1.6). By (2.6), note that there are at most Ci choices for b when $\|b\| = i$, so

$$I = \sum_{i=1}^{n/2} \sum_{\substack{b \in B(n), \\ \|b\|=i}} P_p(\bar{\mathcal{R}}_{AB}(b, n)) \leq C \sum_{i=1}^{n/2} ii^{-5/2+o(1)}. \quad (3.10)$$

Therefore, I converges uniformly on $[0, 0.5]$. Now we estimate II . If $\{\bar{\mathcal{R}}_{AB}(b, n)\}$ occurs for $n \geq i \geq n/2$, then $\mathcal{Q}_4(\mathbf{0}, 2, n/4)$ and $\mathcal{Q}_4(b, 0, (n-i)/4)$ occur independently. By (2.6),

$$II \leq \sum_{i=n/2}^n \sum_{\substack{b \in B(n), \\ \|b\|=i}} P_p(\bar{\mathcal{R}}_{AB}(b, n)) \leq \sum_{i=n/2}^n nCn^{-5/4+o(1)}(n-i)^{-5/4+o(1)}. \quad (3.11)$$

Thus, by using the integral test, II goes to zero as $n \rightarrow \infty$ uniformly on $[0, 0.5]$. Therefore, by (3.7) and the estimates for I and II above,

$$\frac{dE_p(N_n(\mathbf{0}) \mid \mathcal{E}_{AB})}{dp} \text{ converges uniformly on } [0, 0.5]. \quad (3.12)$$

Note that for $p \leq 0.5$ and a fixed b ,

$$R_{AB}(p, n) \leq \sum_{b \in B(n^2), b \neq \mathbf{0}} P_p(\bar{\mathcal{R}}_{AB}(b, n^2)) \text{ and } \lim_{n \rightarrow \infty} P_p(\mathcal{R}_{AB}(b, n)) = \lim_{n \rightarrow \infty} P_p(\bar{\mathcal{R}}_{AB}(b, n)), \quad (3.13)$$

so for A and B , by (3.7) and the estimates for I and II above, $R_{AB}(p, n)$ converges uniformly and (3.8) holds.

It remains to show (3.9). For a finite n , $R_{AB}(p, n)$ is i -th differentiable for any $i \geq 1$ and $p \leq p_0 < 0.5$. By the definition of $\mathcal{R}_{AB}(b, n)$, on $\mathcal{R}_{AB}(b, n)$, there is an occupied path from A to b . By Lemma 3 and the same proof of (6.108) in Grimmett (1999),

$$\frac{d^{i-1} \sum_{b \in B(n)} P_p(\mathcal{R}_{AB}(b, n))}{dp^{i-1}} \text{ converges uniformly on } [0, p_0]. \quad (3.14)$$

By (3.14), $R_{AB}^{(i-1)}(p, n)$ converges uniformly on $[0, p_0]$ for $p \leq p_0 < 0.5$ and for $i \geq 2$. Thus, (3.9) follows. \square

We will introduce a few estimates for $R_{AB}(p, n)$ as the following lemma.

Lemma 9. For any A and B , if $p \leq 0.5$, $m = L(p)$ and $n \geq 2m$, then

$$CL^{-2}(p)(0.5 - p)^{-2} \leq R_{AB}(p, n) - R_{AB}(p, m). \quad (3.15)$$

In particular, if $\delta L(p) = m$ and $n \geq 2m$ for a small $\delta > 0$, then there exists C (independent of p , m , and n) such that

$$R_{AB}(p, n) - R_{AB}(p, m) \leq C\delta^{-1/2+o(1)}L^{-2}(p)(0.5 - p)^{-2}. \quad (3.16)$$

Furthermore, if $m = ML(p)$ and $n \geq 2m$ for a large $M \geq 1$, then there exist C_1 and C_2 (independent of p , M , m , and n) such that

$$R_{AB}(p, n) - R_{AB}(p, m) \leq C_1 \exp(-C_2 M)L^{-2}(p)(0.5 - p)^{-2}. \quad (3.17)$$

Proof. Note that event \mathcal{E}_{AB} only depends on the configurations of A , A' , B , and B' , so

$$P_{p,AB}(\mathcal{Q}_4(i) \mid \mathcal{E}_{AB}) = P_{p,AB}(\mathcal{Q}_4(i)) \asymp P_p(\mathcal{Q}_4(i)). \quad (3.18)$$

By (3.18), and the reconnection lemma,

$$P_p^2(\mathcal{Q}_4(i/4)) = C_1 P_{p,AB}^2(\mathcal{Q}_4(i/4)) \leq C_2 P_{p,AB}(\mathcal{Q}_4(i/4) \cap \mathcal{Q}_4(b, 0, i/4)) \leq C_3 P_p(\mathcal{R}_{AB}(b, i)).$$

Thus, there exist C_i for $i = 1, 2$ such that

$$C_1 P_p^2(\mathcal{Q}_4(i/4)) \leq P_p(\mathcal{R}_{AB}(b, i)) \leq C_2 P_p^2(\mathcal{Q}_4(i/4)). \quad (3.19)$$

So by (3.19), (2.9), and, the reconnection lemma, if $m = L(p)$, by summing all b with $\|b\| = i \geq L(p)$ and all $i \leq 2L(p)$,

$$R_{AB}(p, n) - R_{AB}(p, m) \geq \sum_{i=L(p)}^{2L(p)} iP_p^2(\mathcal{Q}_4(i)) \asymp L^2(p)P_p^2(\mathcal{Q}_4(L(p))) \asymp L^{-2}(p)(0.5 - p)^{-2}. \quad (3.20)$$

So (3.15) in Lemma 9 is proved.

If $m = \delta L(p)$,

$$R_{AB}(p, n) - R_{AB}(p, m) = \sum_{m \leq \|b\| \leq L(p)} \mathcal{R}_{AB}(b, n) + \sum_{L(p) \leq \|b\|} \mathcal{R}_{AB}(b, n). \quad (3.21)$$

By the same estimate of (3.20) and Lemma 4,

$$\sum_{L(p) \leq \|b\|} \mathcal{R}_{AB}(b, n) \leq CP_p^2(\mathcal{Q}_4(L(p))) \sum_{i \geq L(p)} iP_p(B(L(p)) \rightarrow B(i)) \asymp L^{-2}(p)(0.5 - p)^{-2}. \quad (3.22)$$

If $m = \delta L(p)$, then the first sum in the right side of (3.21) satisfies that

$$\sum_{m \leq \|b\| \leq L(p)} \mathcal{R}_{AB}(b, n) \leq C \sum_{k=1}^{\delta^{-1}} \sum_{km \leq i \leq (k+1)m} iP_p^2(\mathcal{Q}_4(i)) \leq C \sum_{k=1}^{\delta^{-1}} m^2(k+1)P_p^2(\mathcal{Q}_4(km)). \quad (3.23)$$

By using the reconnection lemma to extend four-arm paths in $\mathcal{Q}_4(km)$ to the boundary of $B(L(p))$ in (3.23) and by (1.14),

$$\begin{aligned} \sum_{m \leq \|b\| \leq L(p)} \mathcal{R}_{AB}(b, n) &\leq C\delta^{-1/2+o(1)} L^2(p) P_p^2(\mathcal{Q}_4(L(p))) \sum_{k=1}^{\infty} (k+1) k^{-5/2+o(1)} \\ &\asymp \delta^{-1/2+o(1)} L^{-2}(p) (0.5-p)^{-2}. \end{aligned} \quad (3.24)$$

Thus, (3.16) in Lemma 9 follows from (3.23) and (3.24).

Now we show (3.17) in Lemma 9. If $\|b\| \geq ML(p)$, by the same estimate of (3.24),

$$R_{AB}(p, n) - R_{AB}(p, m) \leq C P_p^2(\mathcal{Q}_4(L(p))) \sum_{i=ML(p)}^{\infty} i P_p(\partial B(L(p))) \rightarrow \partial B(i). \quad (3.25)$$

Applying Lemma 4 and (2.9) in (3.25),

$$R_{AB}(p, n) - R_{AB}(p, m) \leq C_1 \exp(-C_2 M) L^{-2}(p) (0.5-p)^2. \quad (3.26)$$

Therefore, (3.17) follows from (3.26). \square

Now we focus on the third term in the right side of (3.4). Note that

$$\begin{aligned} E_p(N_n(\mathbf{0}) \mid \mathcal{E}_{1,3,5}) &= P_p(N_n(\mathbf{0}) \geq 3 \mid \mathcal{E}_{1,3,5}) + P_p(N_n(\mathbf{0}) \geq 2 \mid \mathcal{E}_{1,3,5}) + P_p(N_n(\mathbf{0}) \geq 1 \mid \mathcal{E}_{1,3,5}) \\ &= P_p(N_n(\mathbf{0}) = 3 \mid \mathcal{E}_{1,3,5}) + P_p(N_n(\mathbf{0}) \geq 2 \mid \mathcal{E}_{1,3,5}) + 1, \end{aligned} \quad (3.27)$$

so

$$\frac{dE_p(N_n(\mathbf{0}) \mid \mathcal{E}_{1,3,5})}{dp} = \frac{dP_p(N_n(\mathbf{0}) = 3 \mid \mathcal{E}_{1,3,5})}{dp} + \frac{dP_p(N_n(\mathbf{0}) \geq 2 \mid \mathcal{E}_{1,3,5})}{dp}. \quad (3.28)$$

For each $b \in B(n)$ with $b \not\sim \mathbf{0}$ (on b_1, b_2, b_3 , which are occupied), let (see Fig. 1.2 and Fig. 1.4)

$\mathcal{R}_3(b, n) =$
 $\{\exists$ disjoint occupied paths r_2 and r_4 in $B(n^2)$ from b_1 and b_3 , or b_1 and b_5 , or b_3 and b_5
to neighbors of b , \exists a vacant path r_1 from b_2 , or b_6 , or b_4 to a neighbor of b , and \exists a vacant
path r_3 from b_4 and b_6 , or b_2 and b_4 , or b_2 and b_6 to a neighbor of b ; or \exists three occupied
and three vacant paths from b_1, b_2, b_3 and b_2, b_4, b_6 to neighbors of b , all paths in $B(n^2) \setminus \{\mathbf{0}\}$,

and (see Figures 1.3-1.4)

$\mathcal{R}_2(b, n) =$
 $\{\exists$ disjoint vacant paths r_1 and r_3 from b_2 and b_6 , or b_2 and b_4 , or b_4 and b_6
to neighbors of b , \exists an occupied path r_2 from b_1 , or b_3 , or b_5 to a neighbor of b , and
 \exists an occupied path r_4 from b_3 and b_5 , or b_1 and b_5 , or b_1 and b_3 to a neighbor of b ; or
 \exists three vacant paths from b_1, b_2, b_3 and b_2, b_4, b_6 to neighbors of b , all paths in $B(n^2) \setminus \{\mathbf{0}\}$.

We also let

$$R_2(p, n) = \sum_{b \in B(n), b \neq \mathbf{0}} P_p(\mathcal{R}_2(b, n)) \text{ and } R_3(p, n) = \sum_{b \in B(n), b \neq \mathbf{0}} P_p(\mathcal{R}_3(b, n)). \quad (3.29)$$

Comparing $\mathcal{R}_{AB}(b, n)$ with $\mathcal{R}_2(b, n)$ and $\mathcal{R}_3(b, n)$ (comparing Fig. 1.1 with Fig. 1.2, Fig. 1.3, and Fig. 1.4), there are at least four-arm paths from both $\mathbf{0}$ and b among these three events. In fact, if there are six-arm paths from both $\mathbf{0}$ and b in Fig. 1.4, the probability estimate is much smaller than the four-arm case when p is near 0.5. So the four-arm case dominates the six-arm case. With this observation, when we take a higher derivative for $E_p(N_n(\mathbf{0}))$, we always do the same computations in the analysis of $\mathcal{R}_{AB}(b, n)$, $\mathcal{R}_2(b, n)$, and $\mathcal{R}_3(b, n)$. Therefore, to avoid repeating the similar proofs many times later, we would rather only deal with the detailed estimates for the higher derivative for $P_p(\mathcal{R}_{AB}(b, n))$, but omit the detailed proofs for the others.

Using the same arguments in Lemma 7 and (3.5) and in Lemma 8, we can show that

$$\lim_{n \rightarrow \infty} \frac{-dP_p(N_n(\mathbf{0}) = 3 \mid \mathcal{E}_{1,3,5})}{dp} = \lim_{n \rightarrow \infty} R_3(p, n) \text{ and } \lim_{n \rightarrow \infty} \frac{-dP_p(N_n(\mathbf{0}) \geq 2 \mid \mathcal{E}_{1,3,5})}{dp} = \lim_{n \rightarrow \infty} R_2(p, n) \quad (3.30)$$

and both limits in (3.30) converge uniformly on $[0, 0.5]$. Thus, by (3.30),

$$\lim_{n \rightarrow \infty} \frac{dE_p(N_n(\mathbf{0}) \mid \mathcal{E}_{1,3,5})}{dp} = - \lim_{n \rightarrow \infty} [R_2(p, n) + R_3(p, n)], \quad (3.31)$$

and the limit converges uniformly on $[0, 0.5]$. By (3.2), (3.4), Lemma 8, and (3.31) for all $p \in [0, 0.5]$,

$$\begin{aligned} \kappa''(p) &= - \lim_{n \rightarrow \infty} \frac{dE_p(N_n)}{dp} \\ &= - \lim_{n \rightarrow \infty} \sum_{A,B} \frac{dE_p(N_n(\mathbf{0}) \mid \mathcal{E}_{AB})}{dp} f_{AB}(p) - \lim_{n \rightarrow \infty} \sum_{A,B} E_p(N_n(\mathbf{0}) \mid \mathcal{E}_{AB}) f'_{AB}(p) \\ &\quad - \lim_{n \rightarrow \infty} 2 \frac{dE_p(N_n(\mathbf{0}) \mid \mathcal{E}_{1,3,5})}{dp} f_{1,3,5}(p) - \lim_{n \rightarrow \infty} 2E_p(N_n(\mathbf{0}) \mid \mathcal{E}_{1,3,5}) f'_{1,3,5}(p) - f''(p) \\ &= \lim_{n \rightarrow \infty} \left[\sum_{A,B} f_{AB}(p) R_{AB}(b, n) + 2f_{1,3,5}(p) \sum_{i=2,3} R_i(p, n) \right] \\ &\quad - \lim_{n \rightarrow \infty} \left[\sum_{A,B} E_p(N_n(\mathbf{0}) \mid \mathcal{E}_{AB}) f'_{AB}(p) + 2E_p(N_n(\mathbf{0}) \mid \mathcal{E}_{1,3,5}) f'_{1,3,5}(p) \right] - f''(p). \end{aligned} \quad (3.32)$$

For simplicity, let

$$\begin{aligned} G_p(n) &= \left[\sum_{A,B} f_{AB}(p) R_{AB}(p, n) + 2f_{1,2,3}(p) \sum_{i=2,3} R_i(p, n) \right] \\ &\quad - \left[\sum_{A,B} E_p(N_n(\mathbf{0}) \mid \mathcal{E}_{AB}) f'_{AB}(p) + 2E_p(N_n(\mathbf{0}) \mid \mathcal{E}_{1,3,5}) f'_{1,3,5}(p) \right] - f''(p). \end{aligned}$$

Thus, by Lemma 8, (3.31), and (3.32),

$$\lim_{n \rightarrow \infty} G_p(n) = \kappa''(p) \text{ converges uniformly on } [0, 0.5]. \quad (3.33)$$

Furthermore, by the same argument of the estimate in Lemma 8, if $p \leq p_0 < 0.5$, for $i \geq 2$, then

$$-\lim_{n \rightarrow \infty} \frac{d^i E_p(N_n(\mathbf{0}) \mid \mathcal{E}_{1,3,5})}{dp^i} = \lim_{n \rightarrow \infty} [R_2^{(i-1)}(p, n) + R_3^{(i-1)}(p, n)] \text{ converges uniformly on } [0, p_0]. \quad (3.34)$$

By Lemma 8 and (3.34),

$$\kappa^{(i)}(p) = \lim_{n \rightarrow \infty} G_p^{(i-2)}(n) \text{ uniformly on } [0, p_0]. \quad (3.35)$$

By the same argument of Lemma 9, if $m = L(p)$ and $n \geq 2m$, then for $i = 2, 3$

$$CL^{-2}(p)(0.5 - p)^{-2} \leq R_i(p, n) - R_i(p, m). \quad (3.36)$$

Similarly to (3.16) and (3.17) for $R_{AB}(p, n) - R_{AB}(p, m)$, if $m = \delta L(p)$, then

$$\sum_{i=2,3} [R_j(p, n) - R_j(p, m)] \leq C\delta^{-1/2+o(1)}L^{-2}(p)(0.5 - p)^{-2}, \quad (3.37)$$

and if $m = ML(p)$, then

$$\sum_{i=2,3} [R_j(p, n) - R_j(p, m)] \leq C \exp(-C_1 M)L^{-2}(p)(0.5 - p)^{-2}. \quad (3.38)$$

By the definition, if $n \geq m \asymp L(p)$ on \mathcal{E}_{AB} , then $N_n(\mathbf{0}) - N_m(\mathbf{0}) \geq 1$ implies that there are four-arm paths from A, A', B, B' to $\partial B(m)$. Similarly, on $\mathcal{E}_{1,3,5}$, there are also four-arm paths from the origin to $\partial B(m)$. By this observation, (2.3), and (1.14),

$$\begin{aligned} & \left| \sum_{A,B} E_p(N_n(\mathbf{0}) \mid \mathcal{E}_{AB})f'_{AB}(p) - \sum_{A,B} E_p(N_m(\mathbf{0}) \mid \mathcal{E}_{AB})f'_{AB}(p) \right| \\ & + \left| 2E_p(N_n(\mathbf{0}) \mid \mathcal{E}_{1,3,5})f'_{1,3,5}(p) - E_p(N_m(\mathbf{0}) \mid \mathcal{E}_{1,3,5})f'_{1,3,5}(p) \right| \\ & \leq CP_p(\mathcal{Q}_4(L(p))) \leq C(0.5 - p)^{5/3+o(1)}. \end{aligned} \quad (3.39)$$

Note that $(0.5 - p)^{5/3+o(1)}$ is much smaller than $L^{-2}(p)(0.5 - p)^{-2}$, so by using Lemma 9, (3.36), and (3.39), for $G_n(p)$, if $m = L(p)$ for p near 0.5 from below, then for all $n \geq 2m$,

$$CL^{-2}(p)(0.5 - p)^{-2} \leq G_n(p) - G_m(p). \quad (3.40)$$

If $m = \delta L(p)$, by Lemma 9, (3.37), and (3.39),

$$G_p(n) - G_p(m) \leq C\delta^{-1/2+o(1)}L^{-2}(p)(0.5 - p)^{-2}. \quad (3.41)$$

If $m = ML(p)$, by Lemma 9, (3.38), and (3.39),

$$G_p(n) - G_p(m) \leq C \exp(C_1 M)L^{-2}(p)(0.5 - p)^{-2}. \quad (3.42)$$

4 The third derivatives for $\kappa(p)$.

By (3.33) and (3.35) for any $p \leq p_0 < 0.5$,

$$\begin{aligned}
\kappa'''(p) &= \lim_{n \rightarrow \infty} \left[\sum_{A,B} f_{AB}(p) R'_{AB}(p, n) + 2f_{1,2,3}(p) \sum_{i=2,3} R'_i(p, n) \right] \\
&+ \lim_{n \rightarrow \infty} \left[2 \sum_{A,B} f'_{AB}(p) R_{AB}(p, n) + 4f'_{1,2,3}(p) \sum_{i=2,3} R_i(p, n) \right] \\
&- \lim_{n \rightarrow \infty} \left[\sum_{A,B} E_p(N_n(\mathbf{0}) \mid \mathcal{E}_{AB}) f''_{AB}(p) + 2E_p(N_n(\mathbf{0}) \mid \mathcal{E}_{1,3,5}) f''_{1,3,5}(p) \right] + f'''(p). \tag{4.1}
\end{aligned}$$

It follows from Lemma 8 that for all $p \leq 0.5$ that

$$\begin{aligned}
&\left| 2 \sum_{A,B} f'_{AB}(p) R_{AB}(p, n) + 4f'_{1,2,3}(p) \sum_{i=2,3} R_i(p, n) \right| + \\
&\left| \sum_{A,B} E_p(N_n(\mathbf{0}) \mid \mathcal{E}_{AB}) f''_{AB}(p) + 2E_p(N_n(\mathbf{0}) \mid \mathcal{E}_{1,3,5}) f''_{1,3,5}(p) \right| + f'''(p) \text{ is uniformly bounded.} \tag{4.2}
\end{aligned}$$

Thus, we only need to estimate the first two sums in the right side of (4.1).

Lemma 10. *If $n \geq L(p)$, then there exists C such that*

$$\left| \sum_{A,B} f_{AB}(p) R'_{AB}(p, n) + 2f_{1,2,3}(p) \sum_{i=2,3} R'_i(p, n) \right| \leq CL^{-2}(p)(0.5 - p)^{-3}.$$

Proof. We first focus on $R'_{AB}(p, n)$ for fixed A and B . Note that $\mathcal{R}_{AB}(b, n)$ is neither increasing nor decreasing, so we have to introduce the following more general Russo's formula. If \mathcal{A} is increasing and \mathcal{B} is decreasing, then (see Lemma 1 in Kesten (1987))

$$\begin{aligned}
\frac{dP_p(\mathcal{A} \cap \mathcal{B})}{dp} &= \sum_u P_p(u \text{ is pivotal for } \mathcal{A} \text{ not for } \mathcal{B}, \text{ and } \mathcal{B} \text{ occurs}) \\
&- \sum_u P_p(u \text{ is pivotal for } \mathcal{B} \text{ not for } \mathcal{A}, \text{ and } \mathcal{A} \text{ occurs}). \tag{4.3}
\end{aligned}$$

We need to divide $\mathcal{R}_{AB}(b, n)$ into the intersection of an increasing and a decreasing events. We denote by $\mathcal{R}_{AB}^+(b, n)$ the event that there are two disjoint occupied paths r_2 and r_4 from the two vertices of A and B to two neighbor vertices of b , respectively. We also denote by $\mathcal{R}_{AB}^-(b, n)$ the event that there are two disjoint vacant dual paths r_1 and r_3 from the two vertices of A' and B' to the two neighbor vertices of b , respectively. We decompose

$$\mathcal{R}_{AB}(b, n) = \mathcal{R}_{AB}^+(b, n) \cap \mathcal{R}_{AB}^-(b, n). \tag{4.4}$$

By the new Russo's formula (see Fig. 2),

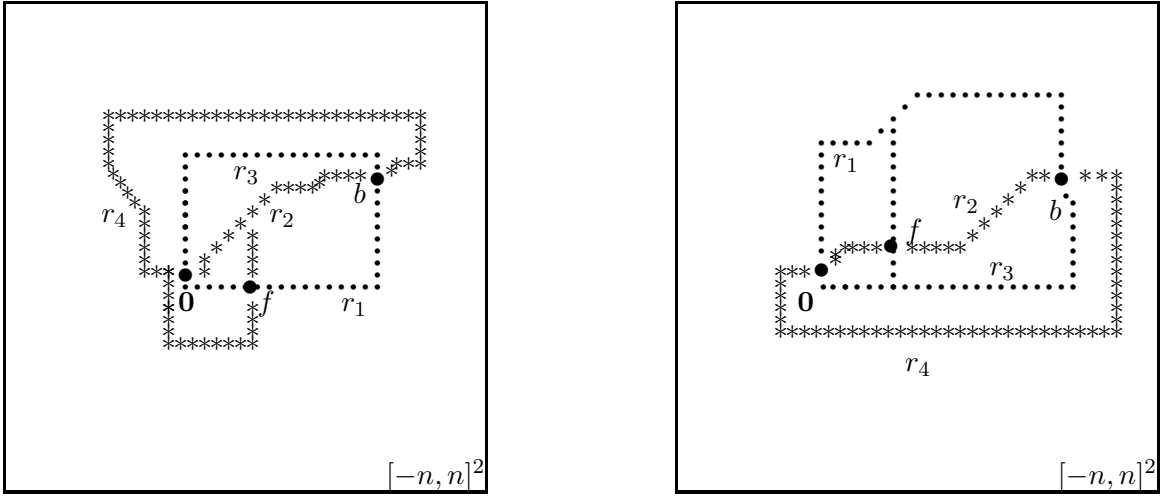

Figure 2: The left figure shows that f is a pivotal for $\mathcal{R}_{AB}^-(b, n)$, and the right one shows that f is a pivotal for $\mathcal{R}_{AB}^+(b, n)$, where the $*$ -paths are occupied and the solid circle-paths are vacant.

$$\begin{aligned}
R'_{AB}(p, n) &= \sum_b \sum_f P_p(f \text{ is a pivotal for } \mathcal{R}_{AB}^+(b, n) \text{ not for } \mathcal{R}_{AB}^-(b, n), \text{ and } \mathcal{R}_{AB}^-(b, n) \text{ occurs}) \\
&\quad - \sum_b \sum_f P_p(f \text{ is a pivotal for } \mathcal{R}_{AB}^-(b, n) \text{ not for } \mathcal{R}_{AB}^+(b, n), \text{ and } \mathcal{R}_{AB}^+(b, n) \text{ occurs}) \\
&= \sum_b \sum_f P_p(\mathcal{R}_{AB}^+(b, f, n)) - \sum_b \sum_f P_p(\mathcal{R}_{AB}^-(b, f, n)) = I - II, \tag{4.5}
\end{aligned}$$

where the first sum above is taken over all sites $b \in B(n)$ for $b \not\sim \mathbf{0}$, and all sites f for $f \neq b$ and $f \not\sim \mathbf{0}$ in $B(n^2)$, and

$$\begin{aligned}
\mathcal{R}_{AB}^+(b, f, n) &= \{f \text{ is a pivotal for } \mathcal{R}_{AB}^+(b, n) \text{ not for } \mathcal{R}_{AB}^-(b, n), \text{ and } \mathcal{R}_{AB}^-(b, n) \text{ occurs}\}, \\
\mathcal{R}_{AB}^-(b, f, n) &= \{f \text{ is a pivotal for } \mathcal{R}_{AB}^-(b, n) \text{ not for } \mathcal{R}_{AB}^+(b, n), \text{ and } \mathcal{R}_{AB}^+(b, n) \text{ occurs}\}. \tag{4.6}
\end{aligned}$$

Let us focus on $\mathcal{R}_{AB}^+(b, f, n)$. By the same analysis in Lemma 7 (see Fig. 2, right), on $\mathcal{R}_{AB}^+(b, f, n)$, f has to stay on $r_2 \cup r_4$, so by the definition of $\mathcal{R}_{AB}^+(b, f, n)$,

$$b \in B(n) \text{ and } f \in B(n^2). \tag{4.7}$$

Moreover, on $\mathcal{R}_{AB}^+(b, f, n)$, there are either two vacant paths r_5 and r_6 from the two neighbors of f to r_1 and r_3 , or there is at least an occupied path from $\mathbf{0}$ or b to $\partial B(n^2)$. Similarly, on $\mathcal{R}_{AB}^-(b, f, n)$, there are either two occupied paths r_7 and r_8 from the two neighbors of f to r_2 and r_4 (see Fig. 2, left), or there is at least an occupied path from f to $\partial B(n^2)$. If there is a long occupied path from A or B to $\partial B(n^2)$ for $n \geq L(p)$ and for $p < 0.5$, by Lemma 3, we can show that

$$P_p(\mathcal{R}_{AB}^+(b, f, n)) \leq \exp(-L(p)). \tag{4.8}$$

Note that $\exp(-L(p))$ is much smaller than $L^{-2}(p)(0.5-p)^{-3}$, so we may now assume that on $\mathcal{R}_{AB}^+(b, f, n)$ there are two vacant paths r_5 and r_6 from the two neighbors of f to r_1 and r_3 , and on $\mathcal{R}_{AB}^-(b, f, n)$ there

are two occupied paths r_7 and r_8 from the two neighbors of f to r_2 and r_4 (see Fig. 2). We divide this assumption into case A for the event that $\|f\| \geq L(p)$ or $\|b\| \geq L(p)$, and case B for the remaining case.

Let us focus on case B, both $\|b\| \leq L(p)$ and $\|f\| \leq L(p)$. As we discussed above, on case B, there are four-arm paths from neighbors of each $\mathbf{0}, b$, and f for $b, f \in B(L(p))$, to the other two vertices (see Fig. 2). The main job is to estimate these four-arm paths. By the locations of f and b and symmetry, we may deal with $d(\mathbf{0}, f) \geq d(\mathbf{0}, b) \geq d(b, f)$ without loss of generality. We construct three squares (see Fig. 3): $f + B(d(\mathbf{0}, f)/2)$, $B(d(\mathbf{0}, f)/2)$, and $b + B(d(b, f)/2)$. As we mentioned above, on $\mathcal{R}_{AB}^+(b, f, n)$ and on case B, f has to stay on $r_2 \cup r_4$ and there are two vacant dual paths r_5 and r_6 from the two neighbors of f to r_1 and r_3 , respectively. In other words,

$$\mathcal{R}_{AB}^+(b, f, n) \subset \mathcal{Q}_4(d(\mathbf{0}, f)/2) \cap \mathcal{Q}_4(f, 0, d(\mathbf{0}, f)/2) \cap \mathcal{Q}_4(b, 0, d(b, f)/2). \quad (4.9)$$

Note that these three kinds of four-arm paths may not be disjoint, so we need to decompose them to occur disjointly by dividing them into the following two cases (see Fig. 3):

- (i) $d(b, f) < d(\mathbf{0}, f)/4$ (see Fig. 3, left) and
- (ii) $d(b, f) \geq d(\mathbf{0}, f)/4$ (see Fig. 3, right).

In case B (ii), $d(b, f) \geq d(\mathbf{0}, f)/4$ implies that

$$\mathcal{Q}_4(d(\mathbf{0}, f)/8) \cap \mathcal{Q}_4(f, 0, d(\mathbf{0}, f)/8) \cap \mathcal{Q}_4(b, 0, d(b, f)/8) \quad (4.10)$$

occurs in disjoint three squares. By translation invariance and (1.14),

$$\begin{aligned} & \sum_{\text{case B (ii)}} P_p(\mathcal{R}_{AB}^+(b, f, n)) \\ & \leq 4 \sum_{\text{case B (ii)}} P_{p,AB}(\mathcal{Q}_4(d(\mathbf{0}, f)/8) \cap \mathcal{Q}_4(f, 0, d(\mathbf{0}, f)/8) \cap \mathcal{Q}_4(b, 0, d(b, f)/8)) \\ & \leq C \sum_{\text{case B (ii)}} P_p^2(\mathcal{Q}_4(d(\mathbf{0}, f)/8)) P_p(\mathcal{Q}_4(b, 0, d(b, f)/8)) \\ & \leq C \sum_{j=1}^{L(p)} j P_p^2(\mathcal{Q}_4(j/8)) \sum_{i=1}^j i P_p(\mathcal{Q}_4(i/8)) \text{ (sum all } f \text{ and } b \text{ with } d(b, f) \leq d(\mathbf{0}, f)) \\ & \leq C_1 \sum_{j=1}^{L(p)} j j^{-5/2+o(1)} \sum_{i=1}^j i i^{-5/4+o(1)} \\ & \leq C_1 \sum_{j=n}^{L(p)} j^{-3/2+o(1)} \sum_{i=1}^j i^{-1/4+o(1)} \leq C_2 L^{1/4+o(1)}(p) = (0.5 - p)^{-1/3+o(1)}, \end{aligned} \quad (4.11)$$

where the first sum in the left side of (4.11) is taken over all f and b on case B (ii) and number 4 in the first inequality is the cost of the symmetric terms.

The exponent in (4.11) is correct. It seems much harder to get rid of $o(1)$ in the right side of (4.11). To do it, we start at the fourth inequality from (4.11) to focus on

$$\sum_{j=1}^{L(p)} j P_p^2(\mathcal{Q}_4(j/8)) \sum_{i=1}^j i P_p(\mathcal{Q}_4(i/8)) \asymp \sum_{j=1}^{L(p)} j P_p^2(\mathcal{Q}_4(j)) \sum_{i=1}^j i P_p(\mathcal{Q}_4(i)). \quad (4.12)$$

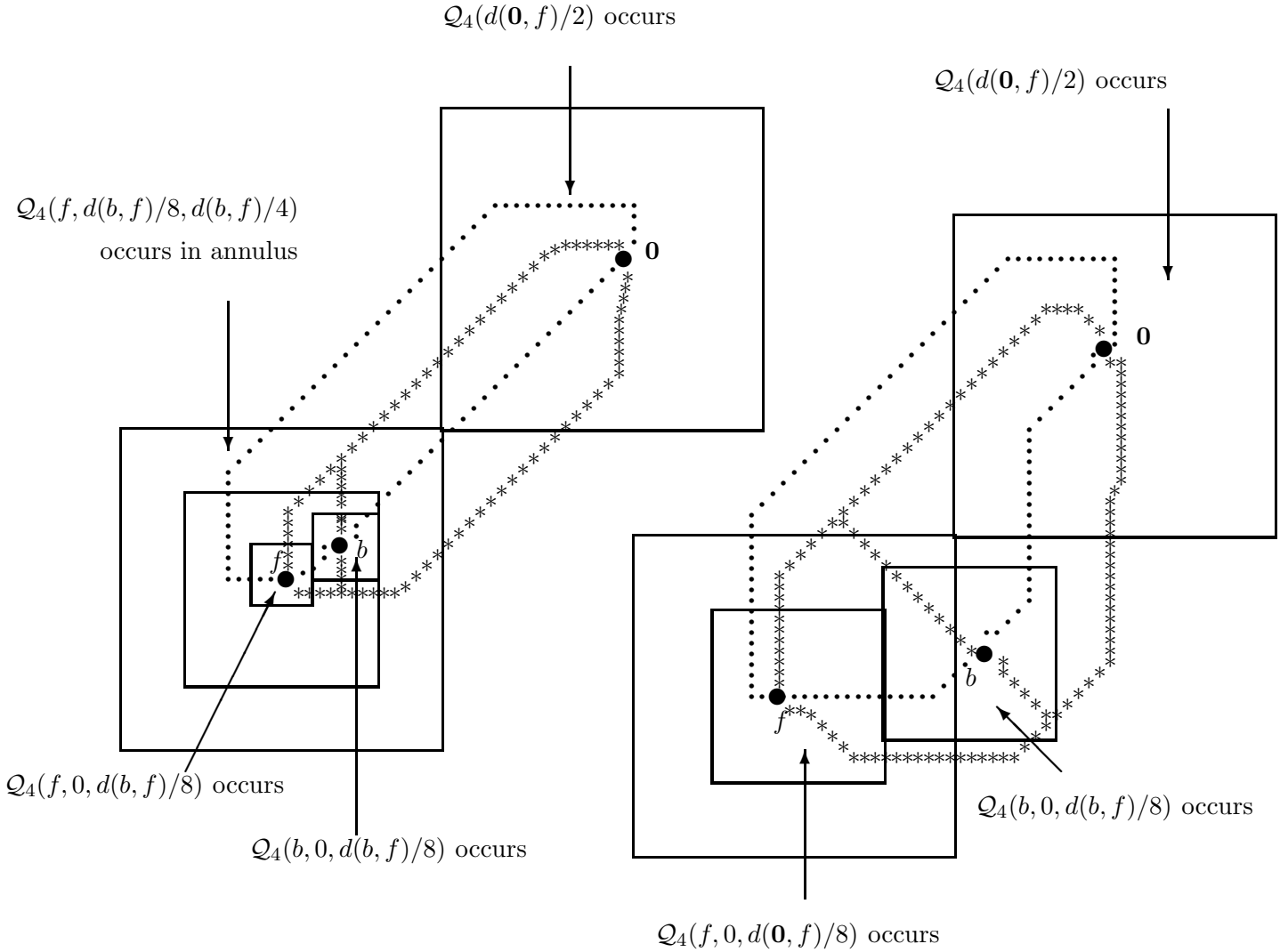

Figure 3: We assume that $d(\mathbf{0}, f) \geq d(\mathbf{0}, b) \geq d(b, f)$ in this figure, and we focus on case B. On the left side, we deal with case B (i): $d(f, b) \leq d(\mathbf{0}, f)/4$. We can see that $\mathcal{Q}_4(d(\mathbf{0}, f)/8) \cap \mathcal{Q}_4(f, 0, d(b, f)/8) \cap \mathcal{Q}_4(f, d(b, f)/8, d(b, f)/4) \cap \mathcal{Q}_4(b, 0, d(b, f)/8)$ occurs disjointly. Note that $\mathcal{Q}_4(f, d(b, f)/8, d(b, f)/4)$ is the event that there are four-arm paths between the annulus $f + B(d(f, b)/4) \setminus B(d(f, b)/8)$. On the right side, we deal with case B (ii): $d(f, b) > d(\mathbf{0}, f)/4$. We see that $\mathcal{Q}_4(d(\mathbf{0}, f)/8) \cap \mathcal{Q}_4(b, 0, d(b, f)/8) \cap \mathcal{Q}_4(f, 0, d(\mathbf{0}, f)/8)$ occurs disjointly, where the $*$ -paths are occupied and the solid dotted-paths are vacant.

Note that by the reconnection lemma, there exists C independent of n and m such that

$$\sum_{j=n}^{2n} jP_p^2(\mathcal{Q}_4(j)) \sum_{m/2 \leq i \leq m} iP_p(\mathcal{Q}_4(i)) \leq Cn^2P_p^2(\mathcal{Q}_4(n))m^2P_p(\mathcal{Q}_4(m)). \quad (4.13)$$

By (4.13), if we take $n = L(p)$, by the reconnection lemma, (1.14), and (2.9) (by extending the four-arm length twice to $\partial B(n)$),

$$\begin{aligned} & \sum_{n/2 \leq j \leq n} jP_p^2(\mathcal{Q}_4(j)) \sum_{n/4 \leq i \leq n/2} iP_p(\mathcal{Q}_4(i)) \leq C(n/2)^2P_p^2(\mathcal{Q}_4(n/2))(n/2)^2P_p(\mathcal{Q}_4(n/2)) \\ & \leq C_12^{-4}2^{15/4+o(1)}L^4(p)P_p^3(\mathcal{Q}_4(L(p))) \leq C_22^{-1/4+o(1)}L^{-2}(p)(0.5-p)^{-3}, \end{aligned} \quad (4.14)$$

where $2^{o(1)}$ is just a constant, but we may use it for the unique notations in (4.17). If $n = L(p)$, we iterate by using (4.14),

$$\begin{aligned} & \sum_{n/2^k \leq j \leq n/2^{k-1}} jP_p^2(\mathcal{Q}_4(j))^2 \sum_{n/2^{k+1} \leq i \leq n/2^k} iP_p(\mathcal{Q}_4(i)) \\ & \leq C(L(p)/2^k)^4P_p^3(\mathcal{Q}_4(L(p)/2^k)) \leq C_12^{-k/4+o(1)}L^{-2}(p)(0.5-p)^{-3}, \end{aligned} \quad (4.15)$$

where $o(1)$ will go to zero as $k \rightarrow \infty$. By Lemma 5, and the second sum estimate in (4.13), for each $k \geq 1$, there exist constants C and C_1 (independent of k and p) such that

$$\sum_{i \leq L(p)/2^{k-1}} iP_p(\mathcal{Q}_4(i)) \leq C \sum_{L(p)/2^k \leq i \leq L(p)/2^{k-1}} iP_p(\mathcal{Q}_4(i)) \leq C_1 \sum_{L(p)/2^{k+1} \leq i \leq L(p)/2^k} iP_p(\mathcal{Q}_4(i)). \quad (4.16)$$

By (4.16) and (4.15), for $2^l = L(p)$ and $n = L(p)$, the sum in the right side of (4.12) can be estimated such that

$$\begin{aligned} & \sum_{j=1}^{L(p)} jP_p^2(\mathcal{Q}_4(j)) \sum_{i=1}^j iP_p(\mathcal{Q}_4(i)) \leq \sum_{k=0}^l \sum_{n/2^k \leq j \leq n/2^{k-1}} jP_p^2(\mathcal{Q}_4(j)) \sum_{i \leq n/2^{k-1}} iP_p(\mathcal{Q}_4(i)) \\ & \leq C \sum_{k=1}^l \sum_{n/2^k \leq j \leq n/2^{k-1}} jP_p^2(\mathcal{Q}_4(j)) \sum_{n/2^{k+1} \leq i \leq n/2^k} iP_p(\mathcal{Q}_4(i)) \\ & \leq C_1L^{-2}(p)(0.5-p)^{-3} \sum_{k=1}^{\infty} 2^{-k/4+o(1)} \leq C_2L^{-2}(p)(0.5-p)^{-3}. \end{aligned} \quad (4.17)$$

Thus, by (4.17) and the fourth inequality of (4.11), we have

$$\sum_{\text{case B (ii)}} P_p(\mathcal{R}_{AB}^+(b, f, n)) \leq CL^{-2}(p)(0.5-p)^{-3}. \quad (4.18)$$

Similarly, we have

$$\sum_{\text{case B (ii)}} P_p(\mathcal{R}_{AB}^-(b, f, n)) \leq CL^{-2}(p)(0.5-p)^{-3}. \quad (4.19)$$

Also, by the same expanding method in (4.17) for $n = L(p)$,

$$\sum_{i=1}^{L(p)} iP_p(\mathcal{Q}_4(i)) \leq C(0.5-p)^{-1}. \quad (4.20)$$

(4.20) can also follow from the second inequality in Lemma 5.

Now we focus on case B (i). Recall that $\mathcal{Q}_4(f, m, n)$ is the event such that there are four-arm paths from $f + [-m, m]^2$ to $f + \partial[-n, n]^2$ (an annulus). Thus, on case B (i) (see Fig. 3, left), $\mathcal{Q}_4(d(\mathbf{0}, f)/2) \cap \mathcal{Q}_4(f, 0, d(\mathbf{0}, f)/2) \cap \mathcal{Q}_4(b, 0, d(b, f)/2)$ implies

$$\mathcal{Q}_4(d(\mathbf{0}, f)/8) \cap \mathcal{Q}_4(f, 0, d(b, f)/8) \cap \mathcal{Q}_4(b, 0, d(b, f)/8) \cap \mathcal{Q}_4(f, d(b, f)/8, d(b, f)/4) \quad (4.21)$$

occurs in the different squares and in the annulus. Therefore, if we sum all $b \in \partial B(i)$ for $i \leq j$ and all $f \in \partial B(j)$ for $j \leq L(p)$, by translation invariance, there exist C_i for $i = 1, 2$ such that

$$\begin{aligned} & \sum_{\text{case B (i)}} P_p(\mathcal{R}_{AB}^+(b, f, n)) \\ & \leq 4 \sum_{\text{case B (i)}} P_{p, AB}(\mathcal{Q}_4(d(\mathbf{0}, f)/2) \cap \mathcal{Q}_4(f, 0, d(\mathbf{0}, f)/2) \cap \mathcal{Q}_4(b, 0, d(b, f)/2)) \\ & \leq C \sum_{\text{case B (i)}} P_p(\mathcal{Q}_4(d(\mathbf{0}, f)/8)) P_p(\mathcal{Q}_4(b, 0, d(b, f)/8)) P_p(\mathcal{Q}_4(f, 0, d(b, f)/8)) P_p(\mathcal{Q}_4(f, d(b, f)/8, d(b, f)/4)) \\ & \leq C_1 \sum_{j=1}^{L(p)} \sum_{i=1}^j j P_p(\mathcal{Q}_4(j/8)) i P_p(\mathcal{Q}_4(i/8)) P_p(\mathcal{Q}_4(i/8)) P_p(\mathcal{Q}_4(i/8, j/8)). \end{aligned} \quad (4.22)$$

We first use the reconnection lemma to connect four-arm paths in $B(i/8)$ and four-arm paths in annulus $A(i/8, j/8)$ to have

$$P_p(\mathcal{Q}_4(i/8)) P_p(\mathcal{Q}_4(i/8, j/8)) \leq C P_p(\mathcal{Q}_4(j/8)). \quad (4.23)$$

By using the same estimate of (4.18) in (4.22) together with (4.23),

$$\sum_{\text{case B (i)}} P_p(\mathcal{R}_{AB}^+(b, f, n)) \leq C L^{-2}(p) (0.5 - p)^{-3}. \quad (4.24)$$

The same estimate of (4.24) also implies that

$$\sum_{\text{case B (i)}} P_p(\mathcal{R}_{AB}^-(b, f, n)) \leq C L^{-2}(p) (0.5 - p)^{-3}. \quad (4.25)$$

We now focus on case A. By symmetry, we only deal with $d(\mathbf{0}, f) \geq d(\mathbf{0}, b) \geq d(b, f)$. Thus, on case A, $d(\mathbf{0}, f) \geq L(p)$. We may divide case A into case A (i) such that $d(\mathbf{0}, b) > L(p)$, $d(\mathbf{0}, f) > L(p)$, and $d(b, f) \geq L(p)$; or case A (ii) such that $d(\mathbf{0}, b) \leq L(p)$ and $d(\mathbf{0}, f) \geq L(p)$; or case A (iii) such that $d(\mathbf{0}, b) \geq L(p)$ and $d(b, f) \leq L(p)$. We deal with case A (ii) first. We may assume that $d(\mathbf{0}, f) = i \geq 2L(p)$; otherwise, we may treat it as case B. By the same analysis in case (B) (i) (see Fig. 3, left, for reference),

$$\sum_{\text{case A (ii)}} P_p(\mathcal{R}_{AB}^+(b, f, n)) \leq C \sum_{j \geq L(p)} j P_p^2(\mathcal{Q}_4(j)) \sum_{i \leq L(p)} i P_p(\mathcal{Q}_4(i)). \quad (4.26)$$

Note that

$$P_p(\mathcal{Q}_4(j/2)) \leq P_p(\mathcal{Q}_4(L(p)/2)) P_p(B(L(p)/2 \rightarrow \partial B(j/2)),$$

so by using (4.20), Lemma 4, and (2.9) in (4.26),

$$\begin{aligned}
& \sum_{\text{case A (ii)}} P_p(\mathcal{R}_{AB}^+(b, f, n)) \\
& \leq C(0.5 - p)^{-1} P_p^2(\mathcal{Q}_4(L(p))) \left[\sum_{k=1}^{\infty} \sum_{kL(p) \leq j \leq (k+1)L(p)} j P_p(B(L(p)/2) \rightarrow \partial B(j)) \right]^2 \\
& \leq C(0.5 - p)^{-1} P_p^2(\mathcal{Q}_4(L(p))) L^2(p) \left[\sum_{k=1}^{\infty} (k+1)^2 \exp(-Ck) \right] \\
& \leq C_1(0.5 - p)^{-3} L^{-2}(p). \tag{4.27}
\end{aligned}$$

By symmetry and the same argument of (4.27),

$$\sum_{\text{case A (iii)}} P_p(\mathcal{R}_{AB}^+(b, f, n)) \leq C_1(0.5 - p)^{-3} L^{-2}(p). \tag{4.28}$$

The same estimate of (4.28) can also be applied to show that

$$\sum_{\text{case A (ii) or (iii)}} P_p(\mathcal{R}_{AB}^-(b, f, n)) \leq C_1(0.5 - p)^{-3} L^{-2}(p). \tag{4.29}$$

Finally, we deal with case A (i). By symmetry, we may assume that $d(\mathbf{0}, b) = i \leq d(\mathbf{0}, f) = j$ and $d(b, f) \geq d(\mathbf{0}, b)$. In this case, if $\mathcal{R}_{AB}^+(b, f, n)$ occurs, then

$$\mathcal{Q}_4(i/2) \cap \mathcal{Q}_4(b, 0, i/2) \cap \mathcal{Q}_4(f, 0, j/2)$$

occurs disjointly. In addition, there are two four-arms between the two annuli $b + A(L(p)/2, i/2)$, and between $f + A(L(p)/2, j/2)$, respectively. Thus, by (2.5) and Lemma 4,

$$\begin{aligned}
& \sum_{\text{in case A (i)}} P_p(\mathcal{R}_{AB}^+(b, f, n)) \\
& \leq P_p^3(\mathcal{Q}_4(L(p)/2)) \sum_{i=L(p)/2}^{\infty} i P_p(B(L(p)/2 \rightarrow B(i/2))) \sum_{j=L(p)/2}^{\infty} j P_p(B(L(p)/2 \rightarrow B(j/2))) \\
& \leq C_1 P_p^3(\mathcal{Q}(L(p))) (L(p))^4 \left[\sum_{k=1}^{\infty} (k+1)^2 \exp(-Ck) \right]^2 \\
& \leq C_2(0.5 - p)^{-3} L^{-2}(p). \tag{4.30}
\end{aligned}$$

The same estimate also applies, that

$$\sum_{\text{in case A (i)}} P_p(\mathcal{R}_{AB}^-(b, f, n)) \leq C_1(0.5 - p)^{-3} L^{-2}(p). \tag{4.31}$$

With these observations in cases A–B, we can show Lemma 10. By using (4.5), (4.8), (4.18), (4.19), (4.24), (4.25), (4.27), (4.28), (4.29), (4.30), and (4.31), if $n \geq L(p)$,

$$|I - II| \leq C(0.5 - p)^{-3} L^{-2}(p). \tag{4.32}$$

Therefore, if $n \geq L(p)$, by using (4.32) for all possible A, B ,

$$\left| \sum_{A,B} R'_{AB}(p, n) \right| \leq C(0.5 - p)^{-3} L^{-2}(p). \quad (4.33)$$

If $n \geq L(p)$, the same argument can be adapted to show that

$$\left| \sum_{j=2,3} R'_j(p, n) \right| \leq C(0.5 - p)^{-3} L^{-2}(p). \quad (4.34)$$

Thus, Lemma 10 follows. \square

If we take $n = \delta L(p)$, by replacing $L(p)$ with $\delta L(p)$ in Lemma 10 case B, we can show the following lemma.

Lemma 11. *If $p < 0.5$ and $n \leq \delta L(p)$ for some small $\delta > 0$, then*

$$\left| \sum_{AB} R'_{AB}(p, n) \right| \leq \delta^{1/4+o(1)} L^{-2}(p) (0.5 - p)^{-3}.$$

5 A tight one-sided estimate for $G_{p_1}(L(p_2)) - G_{p_2}(L(p_2))$.

Recall the definition of $G_p(n)$ in section 3. We know that $G_p(n)$ converges uniformly to $\kappa''(p)$ on $[0, 0.5]$. We select a sequence $\{p_j\}$ for $j = 1, 2, \dots$ such that $p_j \uparrow 0.5$. In addition, p_j is selected such that for some large $M > 2$,

$$\iota(0.5 - p_j) \leq p_{j+1} - p_j \text{ and } \frac{L(p_{j+1})}{L(p_j)} = M, \quad (5.1)$$

where ι is a constant uniformly for all j and M . The existence of such a sequence in (5.1) can be proved as follows. In fact, by the reconnection lemma, (1.14), and (2.9), we have

$$(0.5 - p_j) = (0.5 - p_{j+1}) M^{3/4+o(1)}. \quad (5.2)$$

So

$$(0.5 - p_j)(1 - M^{-3/4+o(1)}) = (p_{j+1} - p_j), \quad (5.3)$$

and there is ι uniformly for all i and M . Now we show the following lemma.

Lemma 12. *For any small $\nu > 0$ and large M , there exists j_0 such that for all $j \geq j_0$ with $\{p_j\}$ defined in (5.1)*

$$G_{p_{j-1}}(L(p_j)) - G_{p_j}(L(p_j)) \leq \nu L^{-2}(p_j) (0.5 - p_j)^{-2}.$$

The proof of Lemma 12 is long and based on the following four lemmas. For any large t , note that

$$\begin{aligned}
& G_{p_{t-1}}(L(p_t)) - G_{p_t}(L(p_t)) \\
= & \sum_{A,B} [R_{AB}(p_{t-1}, L(p_t))f_{AB}(p_{t-1}) - R_{AB}(p_t, L(p_t))f_{AB}(p_t)] \\
+ & \sum_{j=1,2} [R_j(p_{t-1}, L(p_t))f_{1,3,5}(p_{t-1}) - R_j(p_t, L(p_t))f_{1,3,5}(p_t)] \\
- & \sum_{A,B} \left[E_{p_{t-1}}(N_{L(p_t)}(\mathbf{0}) \mid \mathcal{E}_{AB})f'_{AB}(p_{t-1}) - E_{p_t}(N_{L(p_t)}(\mathbf{0}) \mid \mathcal{E}_{AB})f'_{AB}(p_t) \right] \\
- & 2 \left[E_{p_{t-1}}(N_{L(p_{t-1})}(\mathbf{0}) \mid \mathcal{E}_{1,3,5})f'_{1,3,5}(p_{t-1}) - E_{p_t}(N_{L(p_t)}(\mathbf{0}) \mid \mathcal{E}_{1,3,5})f'_{1,3,5}(p_t) \right] - [f''(p_{t-1}) - f''(p_t)]. \quad (5.4)
\end{aligned}$$

By Lemma 8, for any constant C ,

$$\sum_{A,B} E_p(N_{CL(p)}(\mathbf{0}) \mid \mathcal{E}_{AB})f'_{AB}(p) + 2E_p(N_{CL(p)}(\mathbf{0}) \mid \mathcal{E}_{1,3,5})f'_{1,3,5}(p) + f''(p)$$

is uniformly differentiable on $[0, 0.5]$, so there exists C_1 independent of t such that

$$\begin{aligned}
& \left| \sum_{A,B} [E_{p_{t-1}}(N_{L(p_t)}(\mathbf{0}) \mid \mathcal{E}_{AB})f'_{AB}(p_{t-1}) - E_{p_t}(N_{L(p_t)}(\mathbf{0}) \mid \mathcal{E}_{AB})f'_{AB}(p_t)] \right| + |f''(p_{t-1}) - f''(p_t)| \\
& + 2 \left| [E_{p_{t-1}}(N_{L(p_t)}(\mathbf{0}) \mid \mathcal{E}_{1,3,5})f'_{1,3,5}(p_{t-1}) - E_{p_t}(N_{L(p_t)}(\mathbf{0}) \mid \mathcal{E}_{1,3,5})f'_{1,3,5}(p_t)] \right| \leq C_1(p_t - p_{t-1}). \quad (5.5)
\end{aligned}$$

Note also that by (2.9) and (5.1),

$$L^{-2}(p_t)(0.5 - p_t)^{-2} = (0.5 - p_t)^{1/3+o(1)} = C(p_t - p_{t-1})^{1/3+o(1)}, \quad (5.6)$$

which is much larger than $C(p_t - p_{t-1})$ when p_{t-1} is near 0.5. Thus, the first two sums in (5.4) dominate the others. Let us focus on the first sum in (5.4). For fixed A and B , we divide

$$\begin{aligned}
& R_{AB}(p_{t-1}, L(p_t))f_{AB}(p_{t-1}) - R_{AB}(p_t, L(p_t))f_{AB}(p_t) \\
= & [R_{AB}(p_{t-1}, L(p_t)) - R_{AB}(p_t, L(p_t))]f_{AB}(p_{t-1}) + R_{AB}(p_t, L(p_t))[f_{AB}(p_{t-1}) - f_{AB}(p_t)]. \quad (5.7)
\end{aligned}$$

Note that $f_{AB}(p)$ is a polynomial with a degree not more than 6 and, by Lemma 8, $R_{AB}(p_t, L(p_t))$ is uniformly bounded, so there is a constant C (independent of t) such that for all t

$$|R_{AB}(p_t, L(p_t))[f_{AB}(p_{t-1}) - f_{AB}(p_t)]| \leq C(p_t - p_{t-1}). \quad (5.8)$$

By (5.6) and (5.8), the first difference in the right side of (5.7) dominates the other. Now we need to focus on the first difference in the right side of (5.7). We divide $\|b\| \leq \epsilon L(p_t)$ or otherwise for a small number ϵ and show the following lemma.

Lemma 12.1. *For any $\epsilon > 0$,*

$$|R_{AB}(p_{t-1}, \epsilon L(p_t)) - R_{AB}(p_t, \epsilon L(p_t))| \leq M^{3/4+o(1)} \epsilon^{1/4+o(1)} L^{-2}(p_t)(0.5 - p_t)^{-2}$$

for all t (independent of ϵ).

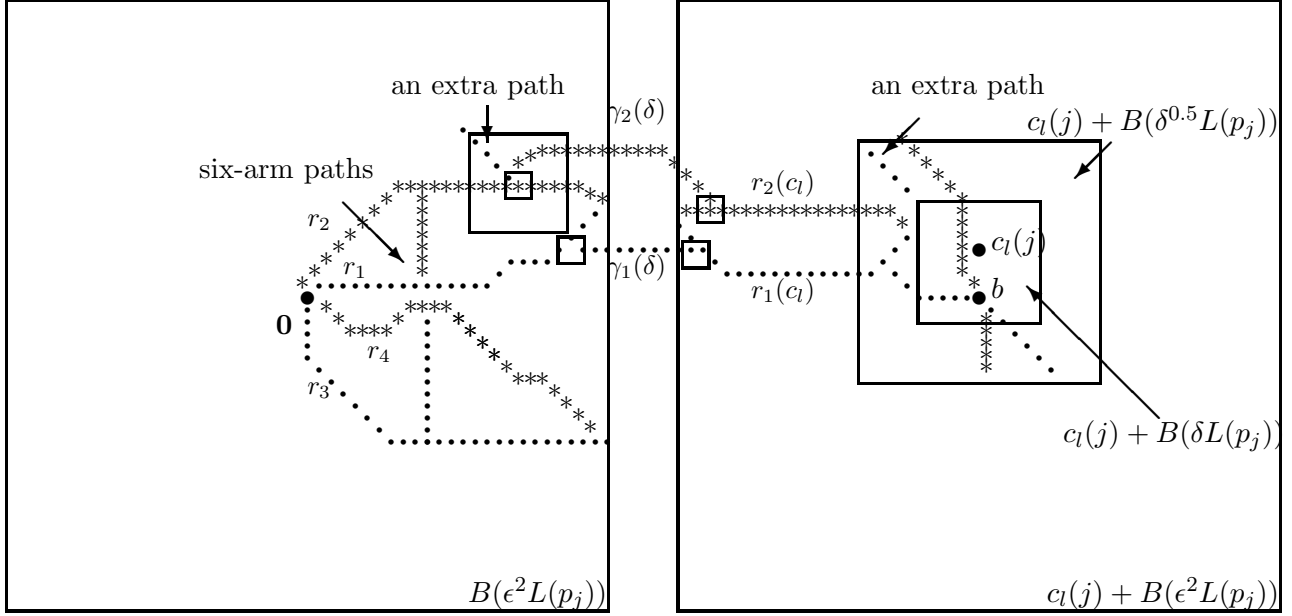

Figure 4: In Fig. 4, we show how to decompose $\mathcal{R}(b, L(p_j))$ into $\mathcal{T}(b, \Gamma(c_l, \delta, \epsilon^2 L(p_j)))$ and $\mathcal{S}(\Gamma(c_l, \delta, \epsilon^2 L(p_j)))$. The areas enclosed by r_1 and r_2 (from A, A' to $\partial B(\epsilon^2 L(p_j))$), r_3 and r_4 (from B, B' to $\partial B(\epsilon^2 L(p_j))$), and $r_1(c_l)$ and $r_2(c_l)$ (from $c_l(j) + \partial B(\delta L(p_j))$ to $c_l(j) + \partial B(\epsilon^2 L(p_j))$) are β_1 , β_2 , and $\beta_1(c_l)$, respectively. Each path has a three-arm property. These areas are regular with a large probability. We demonstrate that r_1 and r_4 are not separated from each other, as indicated in Fig. 4. So there are six-arm paths from a $\delta^{0.5} L(p_j)$ -square with a size up to $\epsilon L(p_j)$. $\gamma_1(\delta)$ and $\gamma_2(\delta)$ (γ_3 and γ_4 are not available) are two paths from $\beta_1(\delta)$ to $\beta_1(c_l, \delta)$, respectively. We show that if $\gamma_2(\delta)$ cannot reach r_2 , then there is an extra vacant path from a $\delta L(p_j)$ -square with size $O(\delta^{0.5} L(p_j))$. Furthermore, if the four-arm paths from b do not connect respective to $r_i(c_l)$ for $i = 1, 2, 3, 4$, inside $c_l(j) + B(\delta^{0.5} L(p_j))$, then there is an extra path or there are six-arm paths in the annulus $c_l(j) + A(\delta L(p_j), \delta^{0.5} L(p_j))$. The $*$ -paths are occupied, and the solid dotted-paths are vacant.

Proof. By the mean value theorem, (5.1) and (5.2), and Lemma 11, there exist $\xi \in (p_{t-1}, p_t)$ such that

$$\begin{aligned}
& |R_{AB}(p_{t-1}, \epsilon L(p_t)) - R_{AB}(p_t, \epsilon L(p_t))| \\
& \leq |R'_{AB}(\xi, \epsilon M L(p_{t-1}))|(p_t - p_{t-1}) \leq (\epsilon M)^{1/4+o(1)} L^{-2}(\xi) (0.5 - \xi)^{-3} (p_t - p_{t-1}) \\
& \leq (M\epsilon)^{1/4+o(1)} L^{-2}(p_{t-1}) (0.5 - p_{t-1})^{-2} = M^{3/4+o(1)} \epsilon^{1/4+o(1)} L^{-2}(p_t) (0.5 - p_t)^{-2}.
\end{aligned} \tag{5.9}$$

Lemma 12.1 follows from (5.9). \square

We denote by

$$R_{AB}^+(\epsilon, p_t, L(p_t)) = R_{AB}(p_t, L(p_t)) - R_{AB}(p_t, \epsilon L(p_t))$$

for a small number ϵ . Now we focus on the difference in $R_{AB}^+(\epsilon, p_{j-1}, L(p_j)) - R_{AB}^+(\epsilon, p_j, L(p_j))$ for large j . In the following estimates, we need many topology discussions. They are tedious and need many pages to state. However, they are easy to understand by graphs. So we omit many detailed proofs but indicate them in Fig. 4. We consider the sequence $\{p_j\}$ defined in (5.1). For a small δ (much smaller than ϵ^9 and M^{-2}), we divide $B(L(p_j))$ into equal sized sub-squares with side length $\delta L(p_j)$. Note that there are at

most $4\delta^{-2}$ such squares. We denote them by $\{h(c_l)\}$ with the center $c_l = c_l(j)$ of each square. We may also view this division by the following way. We divide $[-1, 1]^2$ by $4\delta^{-2}$ squares with equal side length δ . We may denote by $\{\sigma_l\}$ for the centers of these squares. Thus,

$$c_l(j) = L(p_j)\sigma_l. \quad (5.10)$$

We pick a center $c_l(j)$ with $\|c_l(j)\| = \tau L(p_j)$ for some constant $\epsilon \leq \tau \leq 1$. Let us consider $\|c_l\| = L(p_j)$ with $\tau = 1$ for simpler notations but without loss of generality. We consider four-arm paths $\Omega_4(\epsilon^2 L(p_j))$ from A, A', B, B' to $\partial B(\epsilon^2 L(p_j))$ in $B(L^2(p_j))$. We name them r_i for $i = 1, 2, 3, 4$. We may select them, still denoted by r_i , such that the vertex sets enclosed (including the boundaries) by r_1 and r_2 , and r_3 and r_4 , are the smallest, respectively (see Fig. 4). We denote the enclosed sets by β_i for $i = 1, 2$. We call them *inner-most* paths. By Kesten's Proposition 2.3 (see Kesten (1982)), $\{\beta_i = \Gamma_i\}$ only depends on the configurations of Γ_i . We call this property the *independent property*. Let

$$\beta_i(\delta, \epsilon^2 L(p_j)) = \{h(c_l) : h(c_l) \cap \beta_i \neq \emptyset\}.$$

By the independent property, $\{\beta_i(\delta, \epsilon^2 L(p_j)) = \Gamma_i(\delta, \epsilon^2 L(p_j))\}$, for fixed $\delta L(p_j)$ -squares $\Gamma_i(\delta, \epsilon^2 L(p_j))$, only depends on the configurations in $\Gamma_i(\delta, \epsilon^2 L(p_j))$. On the other hand, by Proposition 2.3 again (see Kesten (1982)), for each $v \in r_1$, besides two vacant paths from v along r_1 to the origin and to $\partial B(\epsilon^2 L(p_j))$, there is also an occupied path from v to r_2 (see Fig. 4). We call this property the *three-arm property* for r_1 . Similarly, there are three-arm properties for r_i for $i = 2, 3, 4$. By the three arm property and the same proof in Proposition 2.3 (see Kesten (1982)), we know that $\{\beta_i(\delta, \epsilon^2 L(p_j)) = \Gamma_i(\delta, \epsilon^2 L(p_j))\}$ and $\{\beta_i(\delta, \epsilon^2 L(p_j)) = \Gamma'_i(\delta, \epsilon L(p_j))\}$ are disjoint for different $\Gamma_i(\delta, \epsilon^2 L(p_j))$ and $\Gamma'_i(\delta, \epsilon^2 L(p_j))$. We call this property the *unique property*.

We want to mention that $\beta_1(\delta, \epsilon^2 L(p_j))$ and $\beta_2(\delta, \epsilon^2 L(p_j))$ should be well separated, called *regular*, except near the origin with a large probability. More precisely, we say $\beta_1(\delta, \epsilon^2 L(p_j))$ and $\beta_2(\delta, \epsilon^2 L(p_j))$ are regular if

$$d(\beta_1(\delta, \epsilon L(p_j)) \cap A(\delta^{0.7} \epsilon^2 L(p_j), \epsilon^2 L(p_j)), \beta_2(\delta, \epsilon^2 L(p_j)) \cap A(\delta^{0.7} \epsilon^2 L(p_j), \epsilon^2 L(p_j))) \geq \delta^{0.5} \epsilon^2 L(p_j).$$

In other words, $\beta_1(\delta, \epsilon^2 L(p_j))$ and $\beta_2(\delta, \epsilon^2 L(p_j))$ have no a common $\delta^{0.5} L(p_j)$ -square in annulus $A(\delta^{0.7} \epsilon^2 L(p_j), \epsilon^2 L(p_j))$. If $\beta_1(\delta, \epsilon^2 L(p_j))$ and $\beta_2(\delta, \epsilon^2 L(p_j))$ are non-regular, then there is a $\delta^{0.5} L(p_j)$ -square containing both $\beta_1(\delta, \epsilon^2 L(p_j))$ and $\beta_2(\delta, \epsilon^2 L(p_j))$. If this square is not near the boundary of $B(\epsilon^2 L(p_j))$, by the three arm property for both $\beta_1(\delta, \epsilon^2 L(p_j))$ and $\beta_2(\delta, \epsilon^2 L(p_j))$, there are six-arm paths from this $\delta^{0.5} L(p_j)$ -square up to a size of $O(\epsilon^2 L(p_j))$ (see Fig. 4). Note that if this $\delta^{0.5} \epsilon^2 L(p_j)$ -square is near the boundary of $B(\epsilon^2 L(p_j))$, then there are four-arm paths from the $\delta^{0.5} L(p_j)$ -square in the half space, also with a size up to $O(\epsilon^2 L(p_j))$. In the four-arm case, $\Omega_4(\epsilon^2 L(p_j)/2)$ occurs and there are four-arm paths in the half space from a $\delta^{0.5} L(p_j)$ -square next to the boundary of $B(\epsilon^2 L(p_j))$ with a size of $O(\epsilon^2 L(p_j)/2)$. Thus, by (1.17), if $\delta \leq \epsilon^8$, there exists $\eta_1 > 0$ such that

$$\begin{aligned} & P_q \left(\beta_1(\delta, \epsilon^2 L(p_j)) \text{ and } \beta_2(\delta, \epsilon^2 L(p_j)) \text{ are non-regular in the four-arm case} \right) \\ & \leq CP_q \left(\Omega_4(\epsilon^2 L(p_j)/2) \right) \delta^{-0.5} \left[(\delta^{0.5} L(p_j)) / (\epsilon^2 L(p_j)) \right]^3 \leq C\delta^{\eta_1} P_q \left(\Omega_4(\epsilon^2 L(p_j)) \right) \end{aligned} \quad (5.11)$$

for $q = p_{j-1}$ or $q = p_j$. Similarly, note that by (1.16) and the BK inequality, the exponent of the six-arm paths is larger than two, so we can show the same estimate for the six-arm case. We may define

$$\mathcal{T}(\delta, \epsilon^2 L(p_j)) = \Omega_4(\epsilon^2 L(p_j)) \cap \left\{ \beta_1(\delta, \epsilon^2 L(p_j)) \text{ and } \beta_2(\delta, \epsilon^2 L(p_j)) \text{ are regular} \right\}.$$

Thus, by the discussions above,

$$P_q(\mathcal{T}(\delta, \epsilon^2 L(p_j))) \leq P_q(\Omega_4(\epsilon^2 L(p_j))) \leq P_{p_j}(\mathcal{T}(\delta, \epsilon^2 L(p_j))) + \delta^m P_q(\Omega_4(\epsilon^2 L(p_j))). \quad (5.12)$$

By the unique property, we have

$$P_q(\mathcal{T}(\delta, \epsilon^2 L(p_j))) = \sum_{i=1,2} \sum_{\Gamma_i(\delta, \epsilon^2 L(p_j))} P_q \left(\mathcal{T}(\delta, \epsilon^2 L(p_j)), \beta_i(\delta, \epsilon^2 L(p_j)) = \Gamma_i(\delta, \epsilon^2 L(p_j)) \right), \quad (5.13)$$

where the second sum takes over all possible regular $\delta L(p_j)$ -squares $\Gamma_i(\delta, \epsilon^2 L(p_j))$.

We may replace the origin by $c_l(j)$ and redefine all corresponding events by replacing A, A', B, B' in the boundary of $h(c_l)$ (see Fig. 4). More precisely, we define four-arm paths $r_i(c_l)$ from $h(c_l)$ to $c_l + \partial B(\epsilon^2 L(p_j))$ for $i = 1, 2, 3, 4$ in $B(L^2(p_j))$. We also select $r_i(c_l)$ as the inner-most paths and define $\beta_i(c_l)$, $\beta_i(c_l, \delta, \epsilon^2 L(p_j))$, and fixed sets $\Gamma_i(c_l, \delta, \epsilon^2 L(p_j))$ for $i = 1, 2$ the same as the definitions of β_i , $\beta_i(\delta, \epsilon^2 L(p_j))$, and $\Gamma_i(\delta, \epsilon^2 L(p_j))$. Let $\Omega_4(c_l, \epsilon^2 L(p_j))$ be the event of the existence of $r_i(c_l)$. We can also define $\beta_i(c_l, \delta, \epsilon^2 L(p_j))$ to be regular and

$$\mathcal{T}(c_l, \delta, \epsilon^2 L(p_j)) = \Omega_4(c_l, \epsilon^2 L(p_j)) \bigcap_{i=1,2} \{ \beta_1(c_l, \delta, \epsilon^2 L(p_j)) \text{ and } \beta_2(c_l, \delta, \epsilon^2 L(p_j)) \text{ are regular} \}.$$

Similarly, by (5.12),

$$P_q \left(\mathcal{T}(c_l, \delta, \epsilon^2 L(p_j)) \right) \leq P_q \left(\Omega_4(c_l, \epsilon^2 L(p_j)) \right) \leq P_q \left(\mathcal{T}(c_l, \delta, \epsilon^2 L(p_j)) \right) + (\delta^m) P_q \left(\Omega_4(c_l, \epsilon^2 L(p_j)) \right). \quad (5.14)$$

We denote by

$$\begin{aligned} \mathcal{T}(\beta(c_l, \delta, \epsilon^2 L(p_j))) &= \mathcal{T}(\delta, \epsilon^2 L(p_j)) \cap \mathcal{T}(c_l, \delta, \epsilon^2 L(p_j)), \\ \beta(c_l, \delta, \epsilon^2 L(p_j)) &= \bigcap_{i=1,2} \beta_i(\delta, \epsilon^2 L(p_j)) \cap \beta_i(c_l, \delta, \epsilon^2 L(p_j)), \end{aligned}$$

and

$$\Gamma(c_l, \delta, \epsilon^2 L(p_j)) = \bigcup_{i=1,2} \Gamma_i(\delta, \epsilon^2 L(p_j)) \cup \Gamma_i(c_l, \delta, \epsilon^2 L(p_j)). \quad (5.15)$$

By the unique property, we have

$$P_q(\mathcal{T}(\beta(c_l, \delta, \epsilon^2 L(p_j)))) = \sum_{\Gamma(c_l, \delta, \epsilon^2 L(p_j))} P_q \left(\mathcal{T}(\Gamma(c_l, \delta, \epsilon^2 L(p_j))), \beta(c_l, \delta, \epsilon^2 L(p_j)) = \Gamma(c_l, \delta, \epsilon^2 L(p_j)) \right), \quad (5.16)$$

where the sum is taken for all possible regular $\Gamma(c_l, \delta, \epsilon^2 L(p_j))$ and $\mathcal{T}(\Gamma(c_l, \delta, \epsilon^2 L(p_j)))$ is the event of $\mathcal{T}(\beta(c_l, \delta, \epsilon^2 L(p_j)))$ on $\beta(c_l, \delta, \epsilon^2 L(p_j)) = \Gamma(c_l, \delta, \epsilon^2 L(p_j))$. Recall σ_l defined in (5.10). Thus, for any j , the number of choices of $c_l(j)$ is δ^{-2} . Also, for each $\delta L(p_j)$ -square $h(c_k(j))$ in $\Gamma(c_l(j), \delta, \epsilon^2 L(p_j))$, it corresponds to a unique δ -square with the center at σ_k in $[-1, 1]^2$. If we collect all these δ -squares together, it consists of a δ^2 -square set $\rho(\sigma_l, \delta, \epsilon)$ in $[-1, 1]^2$. We have

$$\rho(\sigma_l, \delta, \epsilon) L(p_j) = \Gamma(c_l(j), \delta, \epsilon^2 L(p_j)). \quad (5.17)$$

Note that the number of choices in $\{\rho(\sigma_l, \delta, \epsilon)\}$ is also finite.

For each $b \in h(c_l)$, if $\mathcal{R}_{AB}(b, L(p_j))$ occurs, then there are four-arm paths $r_i(c_l)$ since $b \in h(c_l)$. We denote by $\mathcal{T}(b, \beta(c_l, \delta, \epsilon^2 L(p_j)))$ if $\mathcal{T}(\beta(c_l, \delta, \epsilon^2 L(p_j)))$ occurs, and the four-arm paths from b connect to $r_i(c_l)$ inside $c_l + B(\delta^{0.5} L(p_j))$ (see Fig. 4). We denote by γ_i four-arm innermost paths from r_i to $r_i(c_l)$

for $i = 1, 2, 3, 4$ outside $\cup_{i=1,2}\beta_i \cup \beta_i(c_l)$ but inside $B(L^2(p_j))$ (see Fig. 4) if they exist. We also denote by $\gamma_i(\delta)$, sub-paths of γ_i , the four-arm paths from $\cup_{i=1,2}\beta_i(\delta, \epsilon^2 L(p_j))$ to $\cup_{i=1,2}\beta_i(c_l, \delta, \epsilon^2 L(p_j))$ (see Fig. 4). Let $\mathcal{S}(\beta(c_l, \delta, \epsilon^2 L(p_j)))$ be the event that $\gamma_i(\delta)$ exists for $i = 1, 2, 3, 4$. On $\mathcal{R}_{AB}(b, L(p_j))$, the four-arm paths from b may not connect $r_i(c_l)$ inside $c_l + B(\delta^{0.5} L(p_j))$. In this case, there are six-arm paths (see Fig. 4) from $c_l + B(\delta L(p_j))$ to $c_l + B(\delta^{0.5} L(p_j))$. On the other hand, on $\mathcal{R}_{AB}(b, L(p_j))$, if $\gamma_i(\delta)$ does not exist for some i , then there is an occupied or a vacant path from $\beta_1 \cup \beta_2$ to $h_l(c_l)$ disjoint to $r_i(c_l)$. We also have six-arm paths from $c_l + B(\delta^{0.5} L(p_j))$ to $c_l + B(\epsilon^2 L(p_j))$. By the BK inequality, the one-arm path estimate in (1.15), and the reconnection lemma, there exists $\eta_2 > 0$ such that

$$\begin{aligned} P_q(\mathcal{R}_{AB}(b, L(p_j))) &\leq (1 + \delta^{\eta_2}) \sum_{\Gamma(c_l, \delta, \epsilon^2 L(p_j))} P_q \left(\mathcal{T}(b, \Gamma(c_l, \delta, \epsilon^2 L(p_j))) \cap \mathcal{S}(\Gamma(c_l, \delta, \epsilon^2 L(p_j))) \right) \\ &= (1 + \delta^{\eta_2}) P_q \left(\mathcal{T}(b, \beta(c_l, \delta, \epsilon^2 L(p_j))) \cap \mathcal{S}(\beta(c_l, \delta, \epsilon^2 L(p_j))) \right) \end{aligned} \quad (5.18)$$

where $\mathcal{T}(b, \Gamma(c_l, \delta, \epsilon^2 L(p_j)))$ and $\mathcal{S}(\Gamma(c_l, \delta, \epsilon^2 L(p_j)))$ are the same events on $\beta(c_l, \delta, \epsilon^2 L(p_j)) = \Gamma(c_l, \delta, \epsilon^2 L(p_j))$. On $\mathcal{S}(\Gamma(c_l, \delta, \epsilon^2 L(p_j)))$, r_i and $\gamma_i(\delta)$ may not connect to each other. If so, note that some of vertices of r_i and $\gamma_i(\delta)$, and of $r_i(c_l)$ and $\gamma_i(\delta)$, are in the same $\delta L(p_j)$ -squares, so by Lemma 1 and the assumption of regularity, we can show that there is an extra occupied path or vacant path (see Fig. 4) from the $\delta L(p_j)$ -squares with a length $\delta^{0.5} L(p_j)$ outside $\beta(c_l, \delta, \epsilon^2 L(p_j))$ to block the connection of $\gamma_i(\delta)$ and r_i or $\gamma_i(\delta)$ and $r_i(c_l)$. By the independent property, the one-arm estimate in (1.15), and the reconnection lemma,

$$\begin{aligned} &P_q \left(\mathcal{T}(b, \beta(c_l, \delta, \epsilon^2 L(p_j))) \cap \mathcal{S}(\beta(c_l, \delta, \epsilon^2 L(p_j))) \right) \\ &= \sum_{\Gamma(c_l, \delta, \epsilon^2 L(p_j))} P_q \left(\mathcal{T}(b, \Gamma(c_l, \delta, \epsilon^2 L(p_j))) \cap \mathcal{S}(\Gamma(c_l, \delta, \epsilon^2 L(p_j))) \right) \leq (1 + \delta^{\eta_2}) P_q(\mathcal{R}_{AB}(b, L(p_j))). \end{aligned} \quad (5.19)$$

By the independent property again, note that $\gamma_i(\delta)$ is outside $\Gamma(c_l, \delta, \epsilon^2 L(p_j))$, so

$$\begin{aligned} &\sum_{\Gamma(c_l, \delta, \epsilon^2 L(p_j))} P_q \left(\mathcal{T}(b, \Gamma(c_l, \delta)) \cap \mathcal{S}(\Gamma(c_l, \delta, \epsilon^2 L(p_j))) \right) \\ &= \sum_{\Gamma(c_l, \delta, \epsilon^2 L(p_j))} P_q \left(\mathcal{T}(b, \Gamma(c_l, \delta)) \right) P_q \left(\mathcal{S}(\Gamma(c_l, \delta, \epsilon^2 L(p_j))) \right). \end{aligned} \quad (5.20)$$

For fixed $\Gamma(c_l(j), \delta, \epsilon^2 L(p_j))$, let $P_q(\mathcal{S}(\Gamma(c_l, \delta, \epsilon^2 L(p_j)))) = S_q(\Gamma(c_l(j), \delta, \epsilon^2 L(p_j)))$ for simplicity. We know that $\Gamma_1(\delta, \epsilon^2 L(p_j)) \cup \Gamma_2(\delta, \epsilon^2 L(p_j))$ and $\Gamma_1(c_l(j), \delta, \epsilon^2 L(p_j)) \cup \Gamma_2(c_l(j), \delta, \epsilon^2 L(p_j))$ are quads in $B(L^2(p_j))$. By Lemma 6, for fixed σ_l and $\rho(\sigma_l, \delta, \epsilon)$, there exists a constant $\alpha_1(\sigma_l, \rho(\sigma_l, \delta, \epsilon))$ such that

$$\lim_{j \rightarrow \infty} S_{p_j} \left(\Gamma(c_l(j), \delta, \epsilon^2 L(p_j)) \right) = \alpha_1(\sigma_l, \rho(\sigma_l, \delta, \epsilon)). \quad (5.21)$$

By (5.21), we can show the following lemma.

Lemma 12.2. *For each $\mu > 0$, there exists j_0 such that for all $j \geq j_0$, for all $k \geq 1$, for all τ , for all σ_l , and for all $\rho(\sigma_l, \delta, \epsilon)$,*

$$1 - \mu \leq \frac{S_{p_j}(\Gamma(c_l(j), \delta, \epsilon^2 L(p_j)))}{S_{p_{j+k}}(\Gamma(c_l(j+k), \delta, \epsilon^2 L(p_{j+k})))} \leq 1 + \mu,$$

where $\Gamma(c_l(j), \delta, \epsilon^2 L(p_j)) = L(p_j)\rho(\sigma_l, \delta, \epsilon)$.

Proof. By the regular assumption and the RSW lemma, the limit $\alpha_1(\sigma_l, \rho(\sigma_l, \delta, \epsilon))$ in (5.21) is bounded away from zero. Note that this lower bound depends on δ , but it is uniformly bounded in j, k , and τ (here our $\tau = 1$) since $\tau \leq 1$. Note also that the numbers of choices of $c_l(j)$ and of $\Gamma(c_l(j), \delta, \epsilon^2 L(p_j))$ are finite (dependent of δ , but not j) in the sense of (5.10) and (5.17), so Lemma 12.2 follows from (5.21). \square

By Lemma 6 again,

$$\lim_{j \rightarrow \infty} S_{p_{j-1}} \left(\Gamma(c_l(j), \delta, \epsilon^2 L(p_j)) \right) = \alpha_2(\sigma_l, \rho(\sigma_l, \delta, \epsilon)). \quad (5.22)$$

By the same proof of Lemma 12.2 using the limit in (5.22), we have for all $j \geq j_0$, for all $k \geq 1$, for all τ , for all σ_l , and for all $\rho(\sigma_l, \delta, \epsilon)$,

$$1 - \mu \leq \frac{S_{p_{j-1}}(\Gamma(c_l(j), \delta, \epsilon^2 L(p_j)))}{S_{p_{j+k-1}}(\Gamma(c_l(j+k), \delta, \epsilon^2 L(p_{j+k})))} \leq 1 + \mu. \quad (5.23)$$

Lemma 12.2 tells the ratio of two probabilities of the four-arm paths for p_j and in p_{j+1} in the different distances. Here we also need to know the ratio of the four-arm paths for p_j and in p_{j+1} in the same distance.

Lemma 12.3. *For any $\mu_1 > 0$, there exists a large j_1 such that for all $j \geq j_1$, for all τ , for all σ_l , and for all $\rho(\sigma_l, \delta, \epsilon)$,*

$$\frac{S_{p_{j-1}}(\Gamma(c_l(j), \delta, \epsilon^2 L(p_j)))}{S_{p_j}(\Gamma(c_l(j), \delta, \epsilon^2 L(p_j)))} \leq 1 + \mu_1,$$

where $\Gamma(c_l(j), \delta, \epsilon^2 L(p_j)) = L(p_j)\rho(\sigma_l, \delta, \epsilon)$.

Proof. By Lemma 12.2, there exists $C_1 = C_1(\delta)$ such that for all k ,

$$\frac{S_{p_j}(\Gamma(c_l(j), \delta, \epsilon^2 L(p_j)))}{S_{p_{j+k}}(\Gamma(c_l(j+k), \delta, \epsilon^2 L(p_{j+k})))} \leq C_1. \quad (5.24)$$

Now we claim that for large M and smaller δ , and for all $k \geq 1$,

$$\frac{S_{p_{k+1}}(\Gamma(c_l(k+1), \delta, \epsilon^2 L(p_{k+1})))}{S_{p_{k+1}}(\Gamma(c_l(k), \delta, \epsilon^2 L(p_k)))} \leq 1. \quad (5.25)$$

We shall show that (5.25) implies Lemma 12.3. To see it, we first show that there exists $j_1 \geq j_0$ such that for a fixed σ_l and a fixed $\rho(\sigma_l, \delta, \epsilon)$,

$$\frac{S_{p_{j_1-1}}(\Gamma(c_l(j_1), \delta, \epsilon^2 L(p_{j_1})))}{S_{p_{j_1}}(\Gamma(c_l(j_1), \delta, \epsilon^2 L(p_{j_1})))} \leq 1 + \mu_1. \quad (5.26)$$

If (5.26) does not hold, then for some μ_1 and for all large $k \geq j_0$,

$$\frac{S_{p_{k-1}}(\Gamma(c_l(k), \delta, \epsilon^2 L(p_k)))}{S_{p_k}(\Gamma(c_l(k), \delta, \epsilon^2 L(p_k)))} \geq 1 + \mu_1. \quad (5.27)$$

Thus, by (5.27), for all m ,

$$\prod_{k=m+1}^{2m} \frac{S_{p_{k-1}}(\Gamma(c_l(k), \delta, \epsilon^2 L(p_k)))}{S_{p_k}(\Gamma(c_l(k), \delta, \epsilon^2 L(p_k)))} \geq (1 + \mu_1)^{m-1}. \quad (5.28)$$

By (5.28), (5.25), and (5.24),

$$C_1 \geq \frac{S_{p_m}(\Gamma(c_l(m), \delta, \epsilon^2 L(p_m)))}{S_{p_{2m}}(\Gamma(c_l(2m), \delta, \epsilon^2 L(p_{2m})))} \geq (1 + \mu_1)^{m-1}. \quad (5.29)$$

The contradiction from taking large m in (5.29) tells us that (5.26) holds. By Lemma 12.2, (5.23), and (5.26) for all large $k \geq 1$ and the j_1 in (5.26),

$$\begin{aligned} & \frac{S_{p_{j_1+k-1}}(\Gamma(c_l(j_1+k), \delta, \epsilon^2 L(p_{j_1+k})))}{S_{p_{j_1+k}}(\Gamma(c_l(j_1+k), \delta, \epsilon^2 L(p_{j_1+k})))} \\ &= \left[\frac{S_{p_{j_1+k-1}}(\Gamma(c_l(j_1+k), \delta, \epsilon^2 L(p_{j_1+k}))) / S_{p_{j_1-1}}(\Gamma(c_l(j_1), \delta, \epsilon^2 L(p_{j_1})))}{S_{p_{j_1+k}}(\Gamma(c_l(j_1+k), \delta, \epsilon^2 L(p_{j_1+k}))) / S_{p_{j_1}}(\Gamma(c_l(j_1), \delta, \epsilon^2 L(p_{j_1})))} \right] \cdot \left[\frac{S_{p_{j_1-1}}(\Gamma(c_l(j_1), \delta, \epsilon^2 L(p_{j_1})))}{S_{p_{j_1}}(\Gamma(c_l(j_1), \delta, \epsilon^2 L(p_{j_1})))} \right] \\ &\leq \frac{(1 + \mu)}{(1 - \mu)} (1 + \mu_1). \end{aligned} \quad (5.30)$$

Thus, (5.26) holds for all large $j \geq j_1$ by using (5.30) for a fixed σ_l and $\rho(\sigma_l, \delta, \epsilon)$. Note that there are finite as many σ_l and $\rho(\sigma, \delta, \epsilon)$, so Lemma 12.3 follows if we take j_1 large.

It remains to show (5.25). By the same proof (5.19),

$$\begin{aligned} & S_{p_{k+1}}(\Gamma(c_l(k+1), \delta, \epsilon^2 L(p_{k+1}))) = P_{p_{k+1}}(\mathcal{S}(\Gamma(c_l(k+1), \delta, \epsilon^2 L(p_{k+1})))) \\ &\leq \left(1 + (M\delta L(p_j) / \epsilon^2 L(p_j))^{\eta_2}\right) P_{p_{k+1}}(\mathcal{S}(\Gamma(c_l(k+1), \delta, \epsilon^2 L(p_k)))) \end{aligned} \quad (5.31)$$

where $\mathcal{S}(\Gamma(c_l(k+1), \delta, \epsilon^2 L(p_k)))$ is the event by considering two squares $B(\epsilon^2 L(p_k))$ and $c_l(k+1) + B(\epsilon^2 L(p_k))$. On $\{\mathcal{S}(\Gamma(c_l(k+1), \delta, \epsilon^2 L(p_k)))\}$, there are four-arm paths from $\Gamma(c_l(k+1), \delta, \epsilon^2 L(p_k))$ to $\partial B(L(p_k))$ and $c_l(k+1) + \partial B(L(p_k))$, respectively. In addition, $\mathcal{Q}_4(L(p_k), L(p_{k+1}))$ occurs. These three kinds of four-arm paths are in different areas. We move the starting point of the four-arm paths from $c_l(k+1)$ to $c_l(k)$ and reconnect them such that $\{\mathcal{S}(\Gamma(c_l(k), \delta, \epsilon^2 L(p_k)))\}$ occurs. By translation invariance and the reconnection lemma, it costs a constant probability to reconnect them. Thus by these observations together with (5.31), if M is large and δ is much smaller than ϵM^{-1} , by (1.14),

$$\begin{aligned} & S_{p_{k+1}}(\Gamma(c_l(k+1), \delta, \epsilon^2 L(p_{k+1}))) = P_{p_{k+1}}(\mathcal{S}(\Gamma(c_l(k+1), \delta, \epsilon^2 L(p_{k+1})))) \\ &\leq C \left(1 + (\epsilon^{-2} M \delta)^{\eta_2}\right) P_{p_{k+1}}(\mathcal{S}(\Gamma(c_l(k), \delta, \epsilon^2 L(p_k)))) P_{p_{k+1}}(\mathcal{Q}_4(L(p_k), L(p_{k+1}))) \\ &\leq C \left(1 + (\epsilon^{-2} M \delta)^{\eta_2}\right) P_{p_{k+1}}(\mathcal{S}(\Gamma(c_l(k), \delta, \epsilon^2 L(p_k)))) M^{-5/4+o(1)} \\ &\leq S_{p_{k+1}}(\Gamma(c_l(k), \delta, \epsilon^2 L(p_k))). \end{aligned} \quad (5.32)$$

So (5.25) follows. \square

Now we consider $j \geq \max\{j_0, j_1\}$ for j_0 and j_1 defined in Lemmas 12.2 and 12.3. By (5.18), (5.19), Lemma 12.3, and (5.20), for each $b \in B(L(p_j))$,

$$\begin{aligned}
& P_{p_{j-1}}(\mathcal{R}(b, L(p_j))) - P_{p_j}(\mathcal{R}(b, L(p_j))) \\
\leq & \sum_{\Gamma(c_l(j), \delta, \epsilon^2 L(p_j))} P_{p_{j-1}}(\mathcal{T}(b, \Gamma(c_l(j), \delta, \epsilon^2 L(p_j)))) S_{p_{j-1}}(\Gamma(c_l(j), \delta, \epsilon^2 L(p_j))) \\
& - \sum_{\Gamma(c_l(j), \delta, \epsilon^2 L(p_j))} P_{p_j}(\mathcal{T}(b, \Gamma(c_l(j), \delta, \epsilon^2 L(p_j)))) S_{p_j}(\Gamma(c_l(j), \delta, \epsilon^2 L(p_j))) + \delta^{\eta_2} P_{p_j}(\mathcal{R}(b, L(p_j))). \\
\leq & \sum_{\Gamma(c_l(j), \delta, \epsilon^2 L(p_j))} P_{p_{j-1}}(\mathcal{T}(b, \Gamma(c_l(j), \delta, \epsilon^2 L(p_j)))) S_{p_j}(\Gamma(c_l(j), \delta, \epsilon^2 L(p_j))) - \\
& - \sum_{\Gamma(c_l(j), \delta, \epsilon^2 L(p_j))} P_{p_j}(\mathcal{T}(b, \Gamma(c_l(j), \delta, \epsilon^2 L(p_j)))) S_{p_j}(\Gamma(c_l(j), \delta, \epsilon^2 L(p_j))) + (3\delta^{\eta_2} + \mu_1) P_{p_j}(\mathcal{R}(b, L(p_j))). \quad (5.33)
\end{aligned}$$

We need to couple two probability measures $P_{p_{j-1}}(\cdot)$ and $P_{p_j}(\cdot)$ together. Let $\{X(v) : v \in \mathbf{Z}^2\}$ be independent random variables with uniform distribution on $[0, 1]$. v is occupied or vacant if $X(v) < p$ or $X(v) \geq p$. We simply use $\mathbf{P}(\cdot)$ to be the probability measure. With this coupling, let $\{\mathcal{T}(p_k, b, \beta(c_l(j), \delta, \epsilon^2 L(p_j)))\}$ and $\{\mathcal{S}(p_m, \beta(c_l(j), \delta, \epsilon^2 L(p_j)))\}$ be the events of $\{\mathcal{T}(b, \beta(c_l(j), \delta, \epsilon^2 L(p_j)))\}$ and $\{\mathcal{S}(\beta(c_l(j), \delta, \epsilon^2 L(p_j)))\}$ with p_k -occupied and $(1 - p_k)$ -vacant configurations in $\beta(c_l(j), \delta, \epsilon^2 L(p_j))$ and p_m -occupied and $(1 - p_m)$ vacant configurations outside $\beta(c_l(j), \delta, \epsilon^2 L(p_j))$. Note that by the unique property, these configurations are uniquely determined. In particular, we may replace $\beta(c_l(j), \delta, \epsilon^2 L(p_j))$ with $\Gamma(c_l(j), \delta, \epsilon^2 L(p_j))$ in the above two events when $\beta(c_l(j), \delta, \epsilon^2 L(p_j)) = \Gamma(c_l(j), \delta, \epsilon^2 L(p_j))$. Thus, by the independent property in (5.20) and the unique property,

$$\begin{aligned}
& \sum_{\Gamma(c_l(j), \delta, \epsilon^2 L(p_j))} P_{p_{j-1}}(\mathcal{T}(b, \Gamma(c_l(j), \delta, \epsilon^2 L(p_j)))) S_{p_j}(\Gamma(c_l(j), \delta, \epsilon^2 L(p_j))) \\
= & \sum_{\Gamma(c_l(j), \delta, \epsilon^2 L(p_j))} \mathbf{P}(\mathcal{T}(p_{j-1}, b, \Gamma(c_l(j), \delta, \epsilon^2 L(p_j))) \cap \mathcal{S}(p_j, \Gamma(c_l(j), \delta, \epsilon^2 L(p_j)))) \\
= & \mathbf{P}(\mathcal{T}(p_{j-1}, b, \beta(c_l(j), \delta, \epsilon^2 L(p_j))) \cap \mathcal{S}(p_j, \beta(c_l(j), \delta, \epsilon^2 L(p_j))))). \quad (5.34)
\end{aligned}$$

Furthermore, let $\Omega_4(B[p_k, 0], B[p_k, c_l], B[p_m, 0, c_l], \epsilon^2 L(p_j))$ be the event that there are four-arm p_k -paths r_i from A, A', B, B' to $\partial B(\epsilon^2 L(p_j))$, and four-arm p_k -paths $r_i(b)$ from b to $c_l + \partial B(\epsilon^2 L(p_j))$ for $i = 1, 2, 3, 4$, respectively. In addition, there are four-arm p_m -paths γ_i in $B(L^2(p_j))$ from r_i to $r_i(b)$. By the same proofs of (5.18) and (5.19) (to discuss p_j -paths outside $\beta(c_l(j), \delta, \epsilon^2 L(p_j))$ rather than p_{j-1} -paths),

$$\begin{aligned}
& \mathbf{P}(\Omega_4(B[p_{j-1}, 0], B[p_{j-1}, c_l], B[p_j, 0, c_l], \epsilon^2 L(p_j))) \\
\leq & \mathbf{P}(\mathcal{T}(p_{j-1}, b, \beta(c_l(j), \delta, \epsilon^2 L(p_j))) \cap \mathcal{S}(p_j, \beta(c_l(j), \delta, \epsilon^2 L(p_j)))) (1 + \delta^{\eta_2}) \\
\leq & \mathbf{P}(\Omega_4(B[p_{j-1}, 0], B[p_{j-1}, c_l], B[p_j, 0, c_l], \epsilon^2 L(p_j))) (1 + \delta^{\eta_2})^2. \quad (5.35)
\end{aligned}$$

By (5.33), (5.34), and (5.35),

$$\begin{aligned}
& P_{p_{j-1}}(\mathcal{R}(b, L(p_j))) - P_{p_j}(\mathcal{R}(b, L(p_j))) \\
\leq & \mathbf{P}(\Omega_4(B[p_{j-1}, 0], B[p_{j-1}, c_l], B[p_j, 0, c_l], \epsilon^2 L(p_j))) - \mathbf{P}(\Omega_4(B[p_j, 0], B[p_j, c_l], B[p_j, 0, c_l], \epsilon^2 L(p_j))) \\
& + (5\delta^{\eta_2} + \mu_1) P_{p_j}(\mathcal{R}(b, L(p_j))). \quad (5.36)
\end{aligned}$$

Note that

$$\mathbf{P}(\Omega_4(B[p_j, 0], B[p_j, c_l], B[p_j, 0, c_l], \epsilon^2 L(p_j))) = P_{p_j}(\mathcal{R}(b, L(p_j))).$$

Now we show the following lemma.

Lemma 12.4. *With the definitions above,*

$$\begin{aligned} & \mathbf{P}\left(\Omega_4(B[p_{j-1}, 0], B[p_{j-1}, c_l], B[p_j, 0, c_l], \epsilon^2 L(p_j))\right) - \mathbf{P}\left(\Omega_4(B[p_j, 0], B[p_j, c_l], B[p_j, 0, c_l], \epsilon^2 L(p_j))\right) \\ & \leq \epsilon^{3/2+o(1)} M^{3/4+o(1)} P_{p_j}(\mathcal{R}(b, L(p_j))). \end{aligned}$$

Proof. The proof is almost the same as for Lemma 11 and Lemma 12.1. So we only outline the proof. In fact, we only need to account for the pivotals of the four-arm p -paths of $\{\Omega_4(B[p, 0], B[p, c_l], B[p_j, 0, c_l], \epsilon^2 L(p_j))\}$ inside $B(\epsilon^2 L(p_j))$ and inside $c_l(j) + B(\epsilon^2 L(p_j))$ when we take the derivative of $\mathbf{P}(\Omega_4(B[p, 0], B[p, c_l], B[p_j, 0, c_l], \epsilon^2 L(p_j)))$ in p . By the same proof of Lemma 11, (1.14), and (2.9), the upper bound of this derivative is

$$\begin{aligned} & C(\epsilon^2 L(p))^2 P_p\left(\Omega_4(\epsilon^2 L(p))\right) \mathbf{P}\left(\Omega_4(B[p, 0], B[p, c_l], B[p_j, 0, c_l], \epsilon^2 L(p_j))\right) \\ & \leq C\epsilon^{3/2+o(1)}(0.5-p)^{-1} \mathbf{P}\left(\Omega_4(B[p, 0], B[p, c_l], B[p_j, 0, c_l], \epsilon^2 L(p_j))\right). \end{aligned} \quad (5.37)$$

Let $\{\Omega_4(B[0], B[c_l], \epsilon^2 L(p_j))\}$ be the event that there are four-arm paths from A, A', B, B' to $B(\epsilon^2 L(p_j))$ and four-arm paths from b to $c_l(j) + B(\epsilon^2 L(p_j))$, respectively. In addition, let $\{\Omega_4(\partial B[0], \partial B[c_l], \epsilon^2 L(p_j))\}$ be the event that there are four-arm paths from $\partial B(\epsilon^2 L(p_j))$ to $c_l + \partial B(\epsilon^2 L(p_j))$ inside $B(L^2(p_j))$. Note that above two events are independent since the paths are in the different areas. Thus,

$$\begin{aligned} & \mathbf{P}\left(\Omega_4(B[p, 0], B[p, c_l], B[p_j, 0, c_l], \epsilon^2 L(p_j))\right) \\ & \leq P_p\left(\Omega_4(B[0], B[c_l], \epsilon^2 L(p_j))\right) P_{p_j}\left(\Omega_4(\partial B[0], \partial B[c_l], \epsilon^2 L(p_j))\right). \end{aligned} \quad (5.38)$$

By the mean value theorem (the same proof of Lemma 12.1), (5.36), (5.37), (5.38), (5.1), (5.2), Lemma 2, and the reconnection lemma, there exists $\xi \in (p_{j-1}, p_j)$ such that

$$\begin{aligned} & \mathbf{P}\left(\Omega_4(B[p_{j-1}, 0], B[p_{j-1}, c_l], B[p_j, 0, c_l], \epsilon^2 L(p_j))\right) - \mathbf{P}\left(\Omega_4(B[p_j, 0], B[p_j, c_l], B[p_j, 0, c_l], \epsilon^2 L(p_j))\right) \\ & \leq \epsilon^{3/2+o(1)}(0.5-\xi)^{-1}(p_j-p_{j-1})P_\xi\left(\Omega_4(B[0], B[c_l], \epsilon^2 L(p_j))\right) P_{p_j}\left(\Omega_4(\partial B[0], \partial B[c_l], \epsilon^2 L(p_j))\right) \\ & \leq C\epsilon^{3/2+o(1)}M^{3/4+o(1)}P_{p_j}\left(\Omega_4(B[0], B[c_l], \epsilon^2 L(p_j))\right) P_{p_j}\left(\Omega_4(\partial B[0], \partial B[c_l], \epsilon^2 L(p_j))\right) \\ & \leq C_1\epsilon^{3/2+o(1)}M^{3/4+o(1)}P_{p_j}(\mathcal{R}(b, L(p_j))). \end{aligned} \quad (5.39)$$

Lemma 12.4 follows from (5.39). \square

Proof of Lemma 12. By (5.35) and Lemma 12.4, there exists j_0 such that for all $j \geq j_0$ and for b with $\|b\| \geq \epsilon L(p_{j+1})$,

$$P_{p_{j-1}}(\mathcal{R}(b, L(p_j))) - P_{p_j}(\mathcal{R}(b, L(p_j))) \leq C\left(\epsilon^{3/2+o(1)}M^{3/4+o(1)} + \delta^{\eta_2} + \mu_1\right) P_{p_j}(\mathcal{R}(b, L(p_j))). \quad (5.40)$$

We sum all possible b with $\|b\| \geq \epsilon L(p_j)$ to have

$$R_{AB}^+(\epsilon, p_{j-1}, L(p_{j+1})) - R_{AB}^+(\epsilon, p_j, L(p_j)) \leq C\left(\epsilon^{3/2+o(1)}M^{3/4+o(1)} + \delta^{\eta_2} + \mu_1\right) R_{AB}^+(\epsilon, p_j, L(p_j)). \quad (5.41)$$

By Lemma 9 (3.16) and (5.41),

$$R_{AB}^+(\epsilon, p_{j-1}, L(p_j)) - R_{AB}^+(\epsilon, p_j, L(p_j)) \leq C \left(\epsilon^{3/2+o(1)} + \delta^{\eta_2} + \mu_1 \right) \epsilon^{-1/2+o(1)} L^{-2}(p_j) (0.5 - p_j)^{-2}. \quad (5.42)$$

For any $\nu > 0$ and any M , we take ϵ small such that $CM^{3/4+o(1)}\epsilon^{1/4+o(1)} \leq \nu$, where the C is the constant in (5.42). For this $\epsilon^{1/4+o(1)}$, by (5.42), we take δ and μ_1 small and then j_0 large such that for all A, B and for all $j \geq j_0$,

$$\sum_{AB} \left[R_{AB}^+(\epsilon, p_{j-1}, L(p_j)) - R_{AB}^+(\epsilon, p_j, L(p_j)) \right] \leq 2\nu L^{-2}(p_j) (0.5 - p_j)^{-2}. \quad (5.43)$$

Therefore, by Lemma 12.1 and (5.43),

$$\sum_{AB} [R_{AB}(p_{j-1}, L(p_j)) - R_{AB}(p_j, L(p_j))] \leq 3\nu L^{-2}(p_j) (0.5 - p_j)^{-2}. \quad (5.44)$$

Similarly, for ν ,

$$\sum_{i=1,2} [R_i(p_{j-1}, L(p_j)) - R_{i=1,2}(p_j, L(p_j))] \leq \nu L^{-2}(p_j) (0.5 - p_j)^{-2}. \quad (5.45)$$

So it follows from (5.5), (5.7), (5.8), (5.44) and (5.45) that for any small $\nu > 0$, there exists j_0 such that for all $j > j_0$,

$$G_{p_{j-1}}(L(p_j)) - G_{p_j}(L(p_j)) \leq \nu L^{-2}(p_j) (0.5 - p_j)^{-2}. \quad (5.46)$$

Lemma 12 follows from (5.46). \square

6 Proof of theorem.

6.1 Proof of the upper bound of the theorem.

By (4.1), (4.2), Lemma 10, and (2.3),

$$|\kappa'''(p)| \leq CL^{-2}(p) (0.5 - p)^{-3} \leq (0.5 - p)^{-1/3+o(1)}. \quad (6.1)$$

If $p > 0.5$, by (1.5), we still have (6.1). Therefore, the upper bound of the theorem follows.

6.2 Proof of the lower bound of the theorem.

Now we focus on the lower bound of the theorem. By Lemma 12, for $\nu > 0$ small, there is j_0 such that for all $j \geq j_0$,

$$G_{p_j}(L(p_j)) - G_{p_{j-1}}(L(p_{j-1})) \geq -\nu L^{-2}(p_j) (0.5 - p_j)^{-2}. \quad (6.2)$$

By (3.33), we take $n \geq L^2(p_j)$ large such that

$$\left| \kappa''(p_j) - G_{p_j}(n) \right| \leq \exp(-L(p_j)) \quad \text{and} \quad \left| \kappa''(p_{j-1}) - G_{p_{j-1}}(n) \right| \leq \exp(-L(p_j)). \quad (6.3)$$

Thus,

$$\begin{aligned}
& \kappa''(p_j) - \kappa''(p_{j-1}) = \\
& \left[\kappa''(p_j) - G_{p_j}(n) \right] + \left[G_{p_{j-1}}(n) - \kappa''(p_{j-1}) \right] + \left[G_{p_j}(n) - G_{p_j}(L(p_j)) \right] \\
& + \left[G_{p_j}(L(p_j)) - G_{p_{j-1}}(L(p_j)) \right] + \left[-G_{p_{j-1}}(n) + G_{p_{j-1}}(L(p_j)) \right] \\
& = I + II + III + IV + V,
\end{aligned} \tag{6.4}$$

where I, II, III, IV, V are the differences in the five square brackets in (6.4). By (6.3) and (2.3),

$$|I| \leq (0.5 - p_j)^2 \text{ and } |II| \leq (0.5 - p_j)^2. \tag{6.5}$$

By (3.40), there exists C independent of ν and M such that

$$III = G_{p_j}(n) - G_{p_j}(L(p_j)) \geq CL^{-2}(p_j)(0.5 - p_j)^{-2}. \tag{6.6}$$

By (6.2) and (5.2), for any $\nu > 0$, if $j \geq j_0$,

$$IV = G_{p_j}(L(p_j)) - G_{p_{j-1}}(L(p_j)) \geq -\nu L^{-2}(p_j)(0.5 - p_j)^{-2}. \tag{6.7}$$

By (3.42) and (5.1), for a large M ,

$$|V| \leq C_1 \exp(-M)L^{-2}(p_{j-1})(0.5 - p_{j-1})^{-2} \leq C_1 M \exp(-M)L^{-2}(p_j)(0.5 - p_j)^{-2}. \tag{6.8}$$

If we choose M large and ν small, III will dominate the others. Together with (6.4)–(6.8), there exists $C = C(M, \nu)$ such that

$$\kappa''(p_j) - \kappa''(p_{j-1}) \geq CL^{-2}(p_j)(0.5 - p_j)^{-2}. \tag{6.9}$$

By the mean value theorem and (6.9) and (5.3), there exist $\xi \in (p_{j-1}, p_j)$ and C_1 (dependent of M) such that

$$\kappa'''(\xi) \geq CL^{-2}(p_j)(0.5 - p_j)^{-2}(p_j - p_{j-1}) \geq C_1 L^{-2}(p_{j-1})(0.5 - p_{j-1})^{-3}. \tag{6.10}$$

By (5.1) and (6.10), for all $p_{j-1} \leq \xi \leq p_j$, there exists $C_2 = C_2(M, \nu)$ (independent of ξ) such that

$$(0.5 - p_{j-1})^{-3} \geq C_2(0.5 - \xi)^{-3} \text{ and } L^{-2}(p_{j-1}) \geq L^{-2}(\xi). \tag{6.11}$$

Therefore, by (6.10) and (6.11), there exists C_3 (for fixed large M and small ν , but independent of ξ_j) such that for some $\xi_j \in (p_{j-1}, p_j)$,

$$\kappa'''(\xi_j) \geq C_3 L^{-2}(\xi_j)(0.5 - \xi_j)^{-3} \geq C_3(0.5 - \xi_j)^{-1/3+o(1)}. \tag{6.12}$$

We have a sequence $\xi_i \in (p_{j-1}, p_j)$ such that (6.12) holds. If $p > 0.5$, by (1.5) we still have a sequence $\{\xi_j\}$ with $\xi_j \geq 0.5$ such that

$$\kappa'''(\xi_j) \leq -C(0.5 - \xi_j)^{-1/3+o(1)}. \tag{6.13}$$

So the two inequalities in the lower bounds of the theorem follow from (6.12) and (6.13). \square

References

- Aizenman, M., Dulpantier, B. and Alharony, A. (1999). Path-crossing exponents and the external perimeter in 2D percolation. *Phy. Rev. Lett.* **63**, 817–835.
- Aizenman, M., Kesten, H. and Newman, C. (1987). Uniqueness of the infinite cluster and continuity of connectivity functions for short and long range percolation. *Comm. Math. Phys.* **111**, 503–532.
- Dunford, N. and Schwartz, T. (1958). *Linear operators*. **1**, Wiley-Interscience, New York.
- Garban, C., Pete, G. and Schramm, O. (2010). Pivotal, cluster and interface measures for critical planar percolation. *arXiv*: 1008.1378v1.
- Garban, C., Pete, G. and Schramm, O. (2013). The scaling limits of near-critical and dynamical percolation. *arXiv*: 1305.5526v2.
- Grimmett, G. (1981). On the differentiability of the number of clusters per vertex in percolation model. *J. Lond. Math. Soc. (2)* **23**, 372–384.
- Grimmett, G. (1999). *Percolation*. Springer-Verlag, New York.
- Higuchi, Y., Takei, M. and Zhang, Y. (2012). Scaling relations for two-dimensional Ising percolation. *J. Stat. Phys.* **148**, 777–799.
- Kesten, H. (1982). *Percolation Theory for Mathematicians*. Birkhauser, Boston.
- Kesten, H. (1987). Scaling relations for 2D-percolation. *Comm. Math. Phys.* **109**, 109–156.
- Kesten, H., Sidoravicius, V. and Zhang, Y. (1998). Almost all words are seen in critical site percolation on the triangular lattice. *Electron. J. Probab.* **3** no. 10, 75pp.
- Kesten, H. and Zhang, Y. (1987). Strict inequalities for some critical exponents in two dimensional percolation. *J. Stat. Phys.* **46**, 1031–1055.
- Lawler, G. F., Schramm, O. and Werner, W. (2002) One-arm exponent for critical 2D percolation. *Electron. J. Probab.* **7**, 13pp.
- Smirnov, S. (2001). Critical percolation in the plane: conformal invariance, Cardy’s formula, scaling limits. *CR. Acad. Sci. I-Math.* **333**, 239–244.
- Smirnov, S. and Werner, W. (2001). Critical exponent for two dimensional percolation. *Math. Res. Lett.* **8**, 729–744.
- Sykes, M. F., and Essam, J. W. (1964). Exact critical percolation probabilities for site and bond problems in two dimensions. *J. Math. Phys.* **5**, 1117–1127.
- Zhang, Y. (2011). A derivative formula for the free energy function *J. Stat. Phys.* **146**, 466–473.

Yu Zhang
Department of Mathematics
University of Colorado
Colorado Springs, CO 80933
yzhang3@uccs.edu