

Point-Contact Spectroscopy

Translation from the russian edition: Moskwa, Izdatelstwo "Znanije", Serija "Fizika", N12, (1989)

Yu. G. Naidyuk, I. K. Yanson

B. Verkin Institute for Low temperature Physics and Engineering
National Academy of Sciences of Ukraine,
61103 Kharkiv, Ukraine

February 2, 2008

Abstract

The history is described of how one of the most commonly used electric circuit components, an ordinary electric contact, has become a powerful tool for the physicists to study various mechanisms of electron scattering in metals. The physical principles of spectroscopy of quasi-particle excitations in metals by means of point contacts (PCs) whose dimensions range from only a few to tens of nanometers are presented in a popular form.

PACS 73.40.Jn

Contents

1	Introduction	1
2	Contacts Around Us	2
3	Electrons and Phonons	3
4	Waste recovery	6
5	What happens inside the contact	7
6	Some theoretical fundamentals	9
7	Procedures for PCs creating	11

8	How to measure the second derivative	13
9	Point contact instead of reactor	14
10	Study of electron-phonon interaction	15
11	Magnons and excitons	16
12	From pure metals to alloys and compounds	18
13	Contact heating	20
14	Electrical fluctuations in PCs	24
15	PCs in a high-frequency electromagnetic field	25
16	Study of PCs on semimetals and semiconductors	26
17	Spectroscopy of superconductor	28
18	New trends of research	29
19	Conclusion	31
1	1 Introduction	
9	The most interesting events and phenomena both in everyday life and science are those which should be characterized by the prefix 'super'. This is usually the	

case when the objects in question are under extreme conditions. Thus, on the verge of XX century, a great impression was made, for example, by the discovery of all-penetrating invisible X-rays or the phenomenon of resistance loss (superconductivity) in some metals at low temperatures. Today the problem of controlled thermonuclear fusion is constantly kept in the focal point. Its solution, however, involves heating and confinement of plasma at a superhigh temperature of hundreds million degrees.

As to the solid state physics, one of the aspects of which is dealt with in this booklet, the most striking results have been obtained when studying superpure and perfect or highly disordered (amorphous), high-quality laminated structures and other compounds of complex composition. In the first place, the greatest achievements are gained if the substance under investigation undergoes the extreme affects of a high magnetic field, low and super low temperatures, extra high pressure or electromagnetic radiation.

If all the events described above are associated with the prefix "super", how to make them compatible with the word "point" used in our case ? It becomes clearer if one deciphers the word "point" as super small, i.e. a point contact (PC) stands for a contact between two substances over a very small area. A question arises, how small is that area and what it can be compared with. Naturally, a lower bound is set by the interatomic spacing in a solid, an upper bound being less clearly defined to within one micrometer. Since in this case we are interested in the current passage through such contacts, the term "super" can be also employed to estimate the density of current. Thus the current densities of 10^9 to 10^{10} A/cm² are achieved in PCs without substantial heating, though bulk conductors would momentarily evaporate under these conditions.

The other word, spectroscopy, probably, does not require any detailed explanation. In a more general sense, spectroscopy is a method of measuring the energy spectrum of a given object. For example, when analyzing the emission or absorption spectra of an atom, one can determine the positions of its energy levels. A spectrum of different collective excitations also exists in solids since the atoms are united into a single ensemble. Such expressions as the energy spec-

trum of electrons, phonons, magnons, etc., are well-known in the solid-state physics. Therefore, the term "point-contact spectroscopy" can be interpreted as a method of measuring the elementary excitation spectra in conductive solids with the aid of PCs of super small size. In this method, the contact itself seems to play the role of analytical instrument, a certain kind of spectrometer.

The point-contact spectroscopy has proved to be a comparatively simple, available and highly informative method. Within the last decade, very impressive results have been obtained in this rapidly developing field by physicists in many countries of the world, as will be described below.

2 Contacts Around Us

In our everyday life, we permanently deal with different electric contacts by means of which current from the source is transmitted to the user and distributed over the circuit. Undoubtable, in number of cases the operation of electrical appliances depends on reliable contacts connecting different sections of electric circuits. Consequently, the requirements for trouble free and stable operation of the contacts are growing from day to day. This problem has become especially topical due to the rapid growth of microelectronics when the number of separate elements per unit volume has increased by a factor of tens of thousands.

From the very inception of electrical engineering, researchers began to study the electric properties of contacts between conductors. The results of these activities were summed up by the German scientist R.Holm in his basic work "Electric Contacts Handbook" published in 1961. Scientists and engineers have noticed that the electrical resistance of two pieces of metal tightly pressed to each other is appreciable higher than could be expected assuming that the electric conductivity at contact is the same as that inside the conductors. The following reasons have been advanced. The first one is connected with the fact that any real surface, even when polished mirror-like, has some microscopic irregularities, as a result of which in the contact region the electrodes come in contact only at separate sections. Hence, the

true contact area can be considerably smaller than the apparent size of contact. The other reason is that the surfaces of metallic electrodes are always coated with a thin layer of oxides or other compounds adsorbed by atoms from the air, organic molecules and other 'dirt'. All these substances, as a rule, possess either dielectric or semiconductor properties. As a result of it a direct electric contact is far less than the total area of mechanical contact between two conductors. Current will not flow in those places where the dielectric film is sufficiently thick; if the film thickness does not exceed a few nanometers, part of the current will pass due to the tunneling effect; metallic conductivity will be effected only at the part of contact area which is free from film and 'dirt' because of their damage or absence. No matter how simple the contact between two electrodes may look, the real picture can be rather complicated.

The interest in the study of small-size contacts is connected not only with their technical applications. They proved to be a most sensitive tool in the hands of scientists. Thus, in the middle of sixties Academician Yu. V. Sharvin from the Institute of Physical Problems of the Russian Academy of Sciences proposed to make experiments in which PCs were used to inject electrons into thin metallic plates. Then a magnetic field was applied, the injected beam was focused on the opposite surface of the plate where the second similar contact was placed to act as a detector. By changing the magnetic field intensity and relative positions of contacts on the sample surface, one can observe the focusing of electrons both along and across the field lines. As to the later case, such experiments were first made by V. S. Tsoi at the Institute of Solid-State Physics of the Russian Academy of Sciences. The detector was capable of registering both the electrons emitted directly by the injector and those once or repeatedly reflected from the surface. The results of such studies yielded helpful information on the Fermi surface geometry and electron scattering by the sample boundary. However, to describe further investigations more substantially, we will present some fundamentals of the electronic theory of metals in the next chapter.

3 Electrons and Phonons

An atom is known to possess a definite set of energy levels at which the electrons reside. When the atoms combine to form a solid, the wave functions (or orbits for simplicity) of the valence electrons of neighboring atoms overlap. Thus, the electrons can move along a crystal, i.e. they actually become collective and are no longer bound to a definite atom. According to the quantum picture, the product of particle energy uncertainty $\delta\varepsilon$ and the lifetime in a particular state $\delta\tau$ is a constant proportional to the Planck's constant \hbar , i.e. $\delta\varepsilon\delta\tau \simeq \hbar$. Therefore, the lifetime $\delta\tau$ of an electron on a stationary atomic orbit is large, and thus the energy uncertainty $\delta\varepsilon$ is small, i.e. the energy level is narrow enough. The valence electrons in a solid are no longer bound with specific atoms, $\delta\tau$ becomes the smaller, the closer are the ions and the easier it is for the electrons to pass from one site to another. As a result of it the value of $\delta\varepsilon$ increases respectively and the atomic energy levels become the energy bands $\delta\varepsilon$ wide. If a substance consists of N atoms, this band will contain N energy levels at which all the collective electrons reside.

In the quantum mechanics, the microparticle behavior depends on whether they have an integer (0, 1, 2, ...) or half-integer ($1/2$, $3/2$, $5/2$, ...) spin. A spin is a quantum characteristics of a particle which is associated with its intrinsic angular momentum. The number of particles being in the same state with the same energy is unlimited for those with an integer spin named bosons. On the contrary, only one particle with a half-integer spin, a fermion, can exist in a state with similar parameters. Electrons are fermions with a $1/2$ spin, as a result of which only two electrons with opposite spins can be located at the same energy level. According to this principle, at a temperature close to absolute zero all the electrons cannot reside at the minimum energy level and are forced to successively fill the higher-lying energy levels in the allowed band. Coming back to the band in a monovalent solid consisting of N atoms comprising N states, it becomes clear that this band can hold N collective electrons starting from the minimum energy level (band bottom) and up to the half-height (Fig. 1). The highest level occupied by electrons at

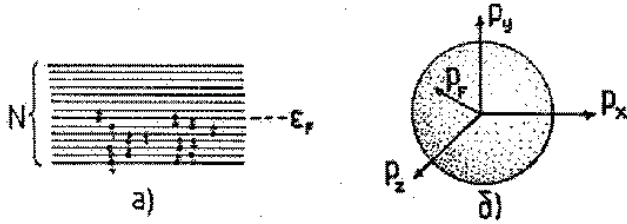

Figure 1: a) Electron distribution over the energy levels in a solid consisting of N atoms on condition that each atom gives away one electron into the conduction band. According to the Pauli principle, each level can accommodate two electrons with opposite spins, then the conduction band will be half-full and Fermi level separating the filled states from the free ones passes in the middle of the band. b) The Fermi surface for free electron gas in a solid in the momentum space. At $T = 0$ it is an isoenergetic surface separating the filled electron states from the free ones. In real metals the Fermi surface is close to a sphere only in some alkali metals, in the other it has more complicated topology and can consist of several parts. The geometrical characteristics of the Fermi surface, its shape, curvature, extreme crosssections values determine the main electronic properties of metals, thus enabling reconstruction of its form from the experimental data.

$T = 0$ was called the Fermi level, and the energy of this level - the Fermi energy ϵ_F which corresponds to the Fermi momentum ¹ $p_F = (2m_{el}\epsilon_F)^{1/2}$. In the momentum space, the Fermi level is an isoenergetic surface (Fermi-surface) which separates the occupied states from the vacant ones. For the case of the isotropic dispersion law, when the energy depends only on the momentum magnitude, but not on its direction, the Fermi surface is a sphere with the radius p_F (Fig. 1(b)).

The electrons can move within the lattice, the number of particles moving, for example, from right

¹It should be noted that the electron behavior in a lattice is quite different from that in a vacuum. In fact, one cannot consider a separate electron in a solid, but rather refer to electron-like excitations, i.e. quasi-particles with a charge similar to that of a free electron and a close mass. This is why the dispersion law includes the effective mass value. Further on we shall use the term 'electrons' implying thesequasi-particles.

to left, being exactly equal to the number of those moving in the opposite direction, while the state of the system remains unchanged due to the quantum-mechanical indistinguishability of the particles. To create current in the crystal, it is necessary to transfer part of electrons into a state in which they can move under the action of the field. Since the number of atoms in a solid is about 10^{22} per 1 cm^3 and the Fermi energy is 1 to 10 eV or 10^4 to 10^5 K , the distance between the nearby levels proves to be very small, equal to $\epsilon_N \simeq 10^{-21}$ to 10^{-22} eV or 10^{-17} to 10^{-18} K . Thus, the electrons residing at the Fermi level under the action of the field move to the nearest free higher lying level separated by an extremely small energy gap of about 10^{-18} K , i.e. can easily increase their energy or accelerate. Such substances with unfilled electron band readily conduct the electric current and are metals. As to the dielectrics, their bands are filled and, as a rule, the nearest vacant band is separated by an energy gap of a few electron-volts. This is possible when two electrons of each atom enter the band. Now the electrons cannot change their states under the action of the field as in this case they have to "jump over" a large energy gap and there will be no current. Note that the contribution into conduction is made only by the electrons residing near the Fermi level while the lower-lying ones cannot change their states since the higher lying levels are occupied. Therefore, all the kinetic properties of conductors are mainly determined by a small group of electrons residing near the Fermi level in a layer with a width about the thermal smearing $k_B T$.

Now we will try to obtain an expression for calculating the conductivity of metals. The current density j can be written as a product of average velocity of ordered electrons motion $\langle v \rangle$, their density n and charge e : $j = ne\langle v \rangle$. In a field with the intensity E an electron acquires acceleration $a = F/m = eE/m$, whence $\langle v \rangle$ can be estimated as $\langle v \rangle \simeq a\tau = eE\tau/m$, where τ is the mean free time of electrons between their scattering by impurities, defects, phonons, etc. As a result, the current density can be written as $j = ne^2\tau E/m = E/\rho$, where $\rho = m/ne^2\tau$ is the resistivity of metal. It can be seen that the current in metals is proportional to the applied field, i.e. the well-known Ohm's law holds. Let us rewrite the ex-

pression for ρ in the form

$$\rho = m/ne^2\tau = mv_F/ne^2\tau v_F = p_F/ne^2l \quad (1)$$

where v_F is the Fermi velocity, $l = v_F\tau$ is the mean free path (mfp) of electrons. It evidently follows from Eq. (1) that the less is the mfp of electrons in the lattice, the higher is its resistance.

On which factors does the mfp depend? It has been already mentioned that the electrons are scattered by the impurity atoms, defects, sample surface, etc. At first glance, it appears that electrons should rather "stumble" on ions in the lattice. However, it turns out that according to the laws of quantum mechanics the electrons are scattered only by thermal vibrations of atoms - the phonons. In a strictly periodical perfect lattice at $T = 0$ the electrons move without collisions as if they do not notice the ionic framework. This is another consequence of the fact the properties of conduction electrons in a solid differ but radically from those of free electrons in the vacuum.

The probability of electrons scattering is proportional to the frequency of their collisions, i.e. to the inverse relaxation time τ^{-1} . Considering all the scattering mechanisms as independent ones, the total probability of scattering under the actions of all factors will be equal to the sum of separate probabilities $\tau^{-1} = \tau_i^{-1} + \tau_p^{-1} + \tau_e^{-1} + \dots$, or, which is the same, $\rho = \rho_i + \rho_p + \rho_e + \dots$ as $\tau^{-1} \sim \rho$. Here ρ_i , ρ_p and ρ_e are resistivity associated with the scattering by impurities and defects (i), by phonons (p), by electrons (e). We have obtained the so-called Matthiessen rule according to which the total electrical resistivity is the sum of contributions due to separate scattering mechanisms.

We will be more interested in the term ρ_p determining the resistivity due to the electron-phonon interaction. First of all, we must make clear what a phonon is. The vibrations of lattice atoms can be presented in the form of excitation waves propagating in a crystal. It is appropriate here to draw on the analogy with waves on the surface of water. A float immersed in the water will move up and down during the wave propagation, i.e. it will vibrate. Thus, the vibrations

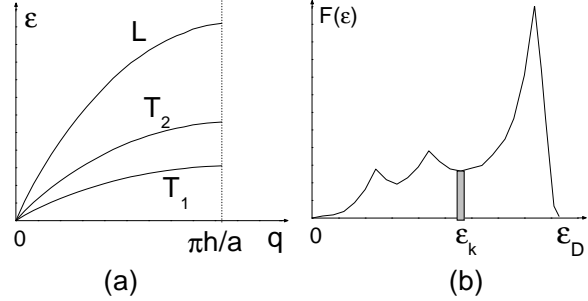

Figure 2: a) Phonon dispersion law in metals with one atom per unit cell. Two lower curves correspond to the transverse vibration of atoms with two polarization, the upper curve corresponds to the longitudinal vibrations, compression-extension waves. b) Typical phonon spectrum for a solid. The boundary Debye energy ε_D is determined by the maximum possible frequency of atom vibrations in the lattice. As a rule, the maxima associated with low group velocity phonons $v \sim d\varepsilon/dq \rightarrow 0$. In Fig. 2(a) it corresponds to the phonons with maximum momentum $q_{max} = \pi\hbar/a$.

of atoms in a solid are described in the language of waves. According to the quantum mechanical dualism, each wave can be compared to a particle and the thermal vibrations of lattice atoms can be described in terms of quasiparticles - the phonons. The wave vector of the wave k corresponds to the momentum of particle $^2q = \hbar k$. In such a model the electrons scattering by thermal vibrations of the lattice can be considered as the interaction of quasi-particles, electrons and phonons, making use of the familiar laws of conservation of energy and momentum.

The energy of phonon ε_{ph} , as well as that of electron, depends on its momentum. The dispersion law for phonons, i.e. the ε_{ph} dependence on q , is more complicated than for electrons for which the formula $\varepsilon = p^2/2m_{eff}$ gives a fairly good approximation. It is not easy to describe this law analytically over the whole range from 0 to q_{max} and it is usually obtained

²Since the wavelength λ of atom vibrations in the lattice cannot be smaller than the interatomic distance a , namely $\lambda_{min} = 2a$, the maximum momentum of phonons is $q_{max} = \hbar k_{max} = \hbar 2\pi/\lambda_{min} = \hbar\pi/a$. For metals $q_{max} \sim p_F$.

experimentally. Besides, the phonon dispersion law depends not only on the value of q but also on its direction. Fig. 2(a) shows the dispersion curves for metals with one atom in the unit cell and one direction in a crystal. A more convenient and more often used characteristics of phonons in a solid is the so-called phonon spectrum $F(\varepsilon)$. This dependence reflects the phonon density of states or, in more detail, indicates which part of phonons has the particular energy. Fig. 2(b) shows the typical form of the $F(\varepsilon)$ curve in a crystal. The first two maxima are generally due to transverse vibrations of atoms in two perpendicular directions (polarizations) while the third maximum is due to more energized longitudinal vibrations since their excitation in a crystal causes the compression and extension waves. As is seen from Fig. 2(a) there exists a maximum energy of phonons, or in the wave language, the boundary (Debye) frequency of vibrations $\omega_{max}(\hbar\omega_{max} = \varepsilon_{max})$. The Debye frequency expressed in degrees is close to so-called Debye temperature. It has a very simple physical meaning: This is a temperature at which the whole vibrational spectrum of metal, up to the highest-energy phonons, is excited.

The phonon spectrum is an important characteristic of a solid. It enables determination of thermal characteristics of the lattice, the heat capacity and heat conductivity, plays a decisive role in kinetic phenomena stipulated by the electron-phonon interaction.

4 Waste recovery

Such a heading would be most suitable for popular-scientific literature on economy or ecology. It occurs, however, that sometimes the "waste" can be utilized in scientific research as well. Turning closer to the point, we will first describe one of wonderful phenomena - the tunneling effect. One of the paradoxical predictions of quantum mechanics which appeared at the beginning of this century was the possibility of microparticle penetration through a potential barrier. In the common language it would mean that, for example, a ball strikes against a wall and passes through it without causing any injuries. This phenomenon

was called tunneling, naturally bearing in mind that no hole is left after the particle passage. The probability of tunneling is the higher, the smaller are the thickness and height of potential barrier (wall thickness and hardness) to be overcome. The tunneling effect was immediately used to explain such microcosm phenomenon as α -decay of radioactive nuclei. However, the most striking manifestation of tunneling could be observed in solid-state physics of the last sixties.

Let us see what will occur when a potential difference is applied to two metallic plates arranged like in a capacitor and then the interplate distance is gradually decreased. Let the plate potential be not very high to avoid electric breakdown or suppose they are in vacuum. It turns out that at a certain plate separation when they are not yet in contact, current appears due to electrons tunneling through the gap, which in this case serves as a potential barrier. The interplate distance at which these effects arise proves to be very small, not greater than a few nanometers (10^{-9} m). It is rather difficult to create and stationarily maintain such a vacuum gap between conductors³, therefore physicists first took a different line. The gap between two evaporated films of metal was formed from dielectric oxides, one being oxidized before evaporating the other. The oxide layer on a metal, as a rule, is few nanometers thick and serves as a good and strong dielectric. This structure was called a sandwich or a tunneling contact. The latter proved to be interesting not only due to the observation of the tunneling effect, but also as a tool of physical research.

When two metal come in contact, their Fermi levels coincide for otherwise the electrons would transfer from the metal with a higher energy to the metal with a lower one. If a voltage V (Fig. 3) is applied to the tunneling contact, the Fermi level will shift with respect to one another by the value eV . The electrons

³It should be noted that in the beginning of eighties it became possible to make precision instruments where tunneling proceeds through a vacuum or air gap between a flat surface and a sharp needle. As the tunneling current strongly depends on the amount of gap, by moving the needle over the surface and simultaneously approaching it to or withdrawing it from the sample at constant tunneling current, one can take surface relief with a superhigh resolution (not worse than 10^{-10} m). Such instruments were called tunneling scanning microscopes.

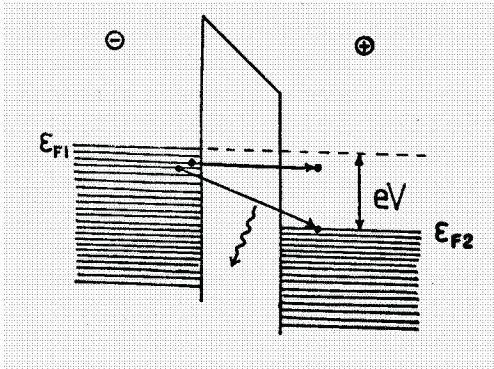

Figure 3: Energy scheme of the tunnelling contact formed between two metals separated by a thin layer of dielectric to which the potential difference V is applied. Two possible channels of electron tunnelling are shown: the elastic one with energy conservation and inelastic with energy loss and phonons or molecules excitation in the barrier or on its surface.

residing on the left can tunnel into the right metal as there are free states on the right. The Ohm's law holds in such a contact even at not very high current voltages. The situation slightly differs if in the process of tunneling the electron changes its energy after the interaction with, for example, molecules adsorbed on the dielectric layer surface, phonons in the bulk metal or in oxides separating the metals. After the energy loss an electron tunnels to other states, i.e. it obtains a wide choice of places to get to. Such processes will result in the tunneling current increase and deviations from the Ohm's law. Such correction is small and for its exact observation one can usually plot not current-voltage characteristics but their derivatives which make it possible to determine the energy of quasi-particles or excited molecules interacting with electrons. This method of study was called tunneling spectroscopy and has been widely used in solid-state physics. The most complicated thing in this technique is to create a thin dielectric layer between the metals. If the oxidation is strong, the layer will be thick and the tunneling current negligibly small. If one tries to reduce the oxidation time, the appearance of 'holes' becomes possible, i.e. the dielectric film will be discontinuous and conductivity

will be stipulated not by tunneling but by current flowing through the metallic shorts. Such contacts are naturally to be rejected for they are no good for tunneling investigations.

One of the authors (I. K. Yanson) has been engaged with the problems of tunneling spectroscopy for a long period of time. At a certain stage he paid attention to this rejected tunneling contacts with metallic shorts "wasted" from the tunneling measurements. It turned out that the current-voltage characteristics of shorted-out contacts also displayed deviations from the Ohm's law. In contrast to the tunneling contacts where current increased more rapidly than linearly, i.e. the contact resistance decreased with the increase of the voltage, in shorted-out samples the resistance increased. One day, while investigating a shorted-out tunneling contact made of lead, the scientist found out that the second derivative of its current-voltage characteristics looked amazingly similar to the phonon density of states in this metal (Fig. 4). It could not happen accidentally since when shorting out this contact by current pulses, i.e. increasing the constriction dimensions, the picture did not change and the maxima retained their positions. Later on this was checked on shorted-out contacts from other metals: copper, silver, gold, tin, etc. Similar pictures were observed in all cases: the second derivative of the current-voltage characteristics reminded of the phonon density of states in metals under investigation.

5 What happens inside the contact

The question arises why the above-mentioned shorts revealed such spectroscopic properties, what kind they are and what size they have. One may suppose that in shorted out tunneling contacts the size of 'holes' is comparable to the dielectric thickness, that is a few nanometers. But the size of a metallic constriction can be determined more precisely by its resistance.

Consider PC model in the form of a thin, electron-opaque partition with a hole d (Fig. 5(a)). The ex-

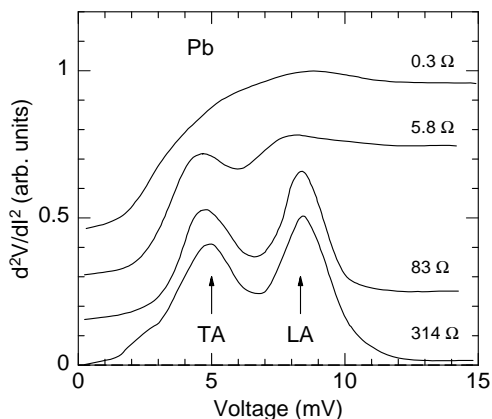

Figure 4: Second derivatives of current-voltage characteristics of a shorted out tunnelling contact of lead recorded with its resistance decrease from 314 to 0.3 Ohm. The spectral maxima correspond to those of the phonon density of states in Pb marked by arrows.

pression for the resistance of such contact proved to be dependent on the ratio of its size d and the electron mfp l . The case of $l \ll d$ was considered by the famous physicist J. Maxwell already at the end of the XIX century. The resistance of such contacts with large diameters or contacts formed by metals with short electron mfp is expressed rather simply as $R_M = \rho/d$. In the case of the reverse ratio, when $l \gg d$, the so-called ballistic regime of the electrons flight is realized, i.e. they pass through an orifice along rectilinear trajectories. In this case, as was shown by Yu. V. Sharvin in the middle of sixties, $R = 16\rho l/3\pi d^2$. The expression for contact resistance at random l/d ratio was obtained in 1966 by G. Wexler

$$R = \Gamma\rho/d + 16\rho l/3\pi d^2 \quad (2)$$

Here the value of Γ varies from 0.7 to 1 with the decrease of l/d ratio from ∞ to zero. It can be seen that the Wexler formula is actually the algebraic sum of two resistances, those of Maxwell and Sharvin.

Let us evaluate the size of lead contact mentioned in the previous chapter. The contact resistance was 314 Ω and from Eq. (2) we will find that its diameter is about 2 nm or 20 \AA , i.e. it is really close to the

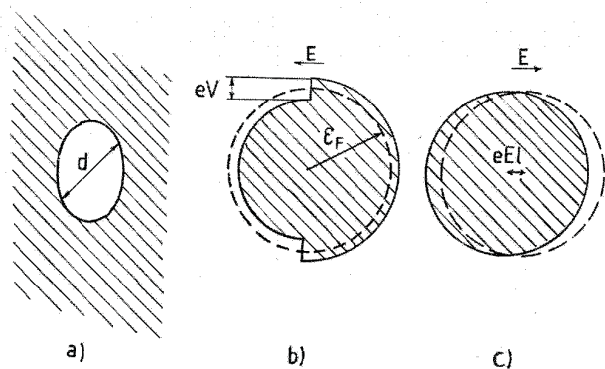

Figure 5: a) Model of PC in the form of a thin electron-non-transparent screen separating two metallic half-spaces with the orifice diameter d . b) Central section of the Fermi surface in the center of PC to which the voltage V is applied. c) The same in a homogeneous conductor with the electric field intensity E . here under the field effect the whole fermi surface is shifted by eEl (l is the electron mfp) which is much smaller than eV .

thickness of oxide ⁴.

We have already considered the factors responsible for the mfp l , but to compare it with the contact size one should find its absolute value. In metals at low temperatures, in the absence of phonons and other quasi-particle excitations, l is determined by scattering due to various lattice defects: impurities, dislocations, sample boundaries. In extremely pure and perfect single-crystalline samples at helium temperatures mfp may reach fantastic values of tens and hundreds thousands of interatomic distances, i.e. be measured in millimeters. With the increase of temperature and phonons excitation, the electron mfp decreases due to scattering by phonons. At this time l can reduce to tens of nanometers.

It was noticed in the initial experiments on the investigation of PCs that the spectrum was most distinctly visible for contacts with higher resistance whose size was of a few nanometers, respectively. At the same time, the spectral features smeared and

⁴When calculating, the value of ρl was set equal to $10^{-11}\Omega\text{cm}^2$ and $\rho \sim 10^{-6}\Omega\text{cm}$. These values can be used for most metals.

gradually disappeared in the case of large-size low-resistance contacts (Fig. 4). It became clear that distinct features were observed in samples for which the electron mfp was greater than the contact size, or when the electrons flew through contacts along the ballistic trajectories.

If the electrons flow through the contact without scattering, the contact resistance is expressed by the Sharvin formula, the current-voltage characteristics will be linear, its second derivative will be equal to zero and, naturally, there will be no spectrum. The situation changes if we take into account that part of electrons are scattered by phonons in the contact neighborhood. According to the calculations, the probability of this scattering is proportional to d/l_{e-ph} , where l_{e-ph} is the length of electron-phonon interaction. At low temperatures, when the number of phonons is small, the processes of excitation (generation) of phonons by electrons near the constriction predominate. As a result of it part of electrons will not get into the hole and the total current will decrease. This means that the contact resistance will rise due to the electron-phonon interaction, thus causing deviations from the Ohm's law and the signal appearance in the second derivative.

Qualitative considerations are also appropriate here. At the increase of voltage by ΔV , the change of resistance ΔR will be proportional to the probability $G(\varepsilon)$ of excitation by electrons in the contact zone of a phonon with the energy ε , i.e. $\Delta R \propto G(\varepsilon)\Delta V$ or, taking into account that $R \propto \Delta V/\Delta I$, we shall evaluate the second derivative as $d^2V/dI^2 \propto \Delta R/\Delta V \propto G(\varepsilon)$. Thus, the second derivative of the current-voltage characteristics reflects the probability of phonons emission $G(\varepsilon)$. The latter, in its turn, is proportional to the phonon density of states $F(\varepsilon)$ multiplied by the so-called square of the electron-phonon interaction $\alpha_{PC}^2(\varepsilon)$ taking into account the "force" of electrons interaction with one or another group of phonons and the contact geometry. Therefore we can write

$$d^2V/dI^2 \propto G(\varepsilon) = \alpha_{PC}^2(\varepsilon)F(\varepsilon) \quad (3)$$

This expression was later rigorously substantiated in theoretical works described below. It turned out that

the $\alpha^2(\varepsilon)$ dependence is "smoother" function of energy compared with $F(\varepsilon)$, so the shape and peculiarities (maxima, minima) of d^2V/dI^2 are to a greater extent dictated by the phonon spectrum behavior. Now it is clear why the spectra for lead and other metals remind us the phonon density of states.

6 Some theoretical fundamentals

The theory of point-contact spectroscopy has been developed by I. O. Kulik and his coworkers A. N. Omelyanchuk and R. I. Shekhter. Their principal result was rigorous derivation of the expression for d^2V/dI^2 of PC in the ballistic regime and its relation to the function $F(\varepsilon)$. A model chosen for PC was an orifice in a thin opaque to electrons partition separating two metallic half-spaces (Fig. 5(a)). Later on it has been demonstrated that the result is noncritical with respect to the contact geometry. The expression obtained theoretically has the form

$$\frac{d^2V}{dI^2} \simeq -\frac{d^2I}{dV^2} \propto \langle K \rangle^{-1} d^3 N(\varepsilon_F) G(\varepsilon) \quad (4)$$

where $\langle K \rangle$ is the PC geometry factor equal to 0.25 for the orifice model, d is the contact diameter, $N(\varepsilon_F)$ is the electron density of states at the Fermi surface.

The nonequilibrium function of electrons distribution in the center of contact is shown in Fig. 5(b). When voltage is applied to the contact, the electrons are separated into two groups arriving from the right and the left regions, correspondingly. Maximum energies of these groups at $T = 0$ differ precisely by the amount of eV . It becomes important that the energy difference between any two states of electrons at the Fermi surface is equal to eV or zero. It is this circumstance that enables us to use PCs as an unusual energy "probe" to determine the energies of other quasi-particles.

Fig. 5 shows that the electrons distribution function in PC differs but greatly from a similar one in the case of current flowing through a homogeneous sample. In this case it is impossible to impart a considerable excess energy to the electrons that is comparable to the energy of Debye phonons. It turns

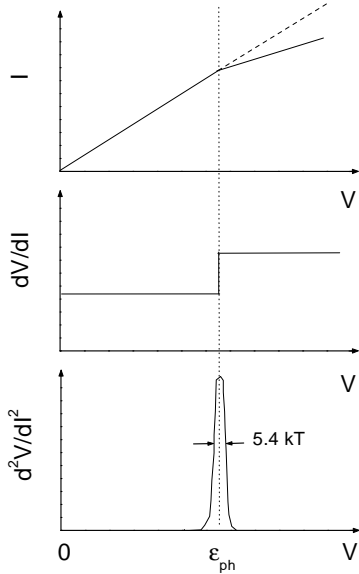

Figure 6: Current-voltage characteristics $I(V)$, its first and second derivatives for PC of hypothetical metal in which all phonons have the same energy ε_{ph} . The peak in the second derivative will have the width $5.4k_B T$ due to the Fermi level smearing (see Chapter 8).

out that for the electron energy acquired in the electric field to reach the characteristic phonon energies, the current energy should exceed 10^9 A/cm². Such current densities in the bulk metal are unattainable because of the Joule heating and melting. It is not the case with PCs as due to their small size the heat is quickly 'sucked off' into the cold bulk metal. In other words, the contact area remains cold as a result of a large mfp of phonons compared with the contact side: the phonons have time enough to depart and transfer their energy into the surrounding medium.

For better understanding of scattering processes in PC, consider the case of a certain hypothetical metal in which only the phonons with the same energy ε_{ph} are present. If the electrons passing through the orifice have the excess energy $eV < \varepsilon_{ph}$ they are unable to excite the phonons and the electron trajectories are straight lines without scattering. The contact resistance is precisely equal to the Sharvin's one, and

the current-voltage characteristics will be rectilinear (Fig. 6). When the electrons obtain the energy ε_{ph} , they begin to excite phonons, scatter, and will not get into the orifice, so the current through the contact will build up with voltage more slowly than in the absence of scattering. It is clear that the current-voltage will have a break at this point. The differential resistance $R_d = dV/dI$ dependence will make a step, and the second derivative d^2V/dI^2 will display a sharp peak at a specific energy (Fig. 6). If the metal possesses several groups of phonons with definite energies, then the d^2V/dI^2 curve will have a maximum for each of them. In the general case at continued phonon spectrum the second derivative of the current-voltage characteristics will be similar to this curve.

As has been already mentioned, d^2V/dI^2 does not merely reflect the phonon spectrum but is proportional to the probability $G(\varepsilon)$ of emission of phonon with the energy ε . The $G(\varepsilon)$ function is generally called the PC spectral function of the electron-phonon interaction. In the case of conductors, the transport and thermodynamic functions of the electron-phonon interaction are also distinguished. The former is connected with the current flow in metals, the latter determinates the effective mass, velocity, and electron density of states changes due to the electron-phonon interaction.

The PC spectral function $G(\varepsilon)$ introduced by analogy with the above ones is a variety of transport function of the electron-phonon interaction and differs by a stronger dependence on the angle of electrons scattering in the contact. In the orifice model this dependence is determined by the expression $(1 - \theta/\tan \theta)$, where θ is the scattering angle of electron momentum. It is seen that at $\theta = \pi$, when the electron reverses its motion direction this expression diverges, i.e. such processes give maximum contribution into the PC spectrum and are most significant. This essentially distinguishes the situation in contacts from scattering in a homogenous conductor resulting in normal resistance or from electron-phonon interaction responsible for superconductivity. In the former case the scattering efficiency increases with the angle as $(1 - \cos \theta)$, in the latter case it is independent of the angle at all. Thus, all the functions in question can

be written in the form of Eq.(4), but with different $\alpha^2(\varepsilon)$ dependencies.

7 Procedures for PCs creating

We have already mentioned one of the techniques used to obtain micro contacts in the tunneling structures. The schematic representation of a contact with a short in the dielectric layer is shown in Fig.7a. Such a conducting bridge often appears spontaneously as a result of metallic dendrites intergrowth through weak spots or defects of the dielectric film. The bridge can be created artificially by means of mechanical loads causing the oxide film damage or by means of electric breakdown. In the former case use is made of a sharp needle creating high local stresses, in the latter case the electric voltage is raised up to the level exceeding the breakdown value at the weakest spot of the dielectric. The latter case resembles electric microwelding when metal is instantaneously melted in the constriction and is purified from foreign inclusions. Certainly depending on the film material, dielectric interlayer properties, magnitude and duration of the current pulse, the degree of structure perfection and the purity of metal in the constriction can vary in a wide range. Using the film technology, one can obtain rather small PCs only of a few nanometers with sufficiently high mechanical stability and vibration resistance.

However, the fabrication of film PCs involves rather awkward technique of vacuum deposition of metals. Besides, the structure of metal in the films is usually less perfect than in the bulk samples. That is why the creation of pressure contacts between bulk electrodes gave an impetus to the development of research in this field. A pressure contact of the needle-anvil type is shown in Fig.7b. It is obtained by gradually approaching two electrodes directly in liquid helium by means of precision mechanism. Generally, the radius of curvature of the needle tip is a few nanometers. Before measurement the electrodes are processed mechanically, then chemically or electrochemically, to obtain clean unperturbed surfaces of required shape. At this time the surface is coated by a thin film of oxide or other non-conductive com-

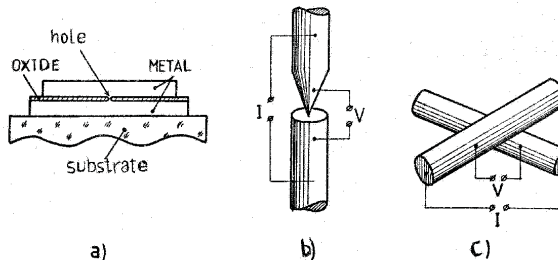

Figure 7: Method of PC preparation a) A film of metal is deposited in vacuum onto a dielectric substrate, a thin dielectric layer is formed on the film by oxidation or other methods, on top of this layer the second film of metal is deposited. The technology is selected in such a way that contacts should be formed spontaneously in the process of preparation or as a result of subsequent mechanical or electrical effects. b) "Needle-anvil" method: a specially processed metallic electrode in the form of thin needle is slightly pressed to the flat surface of the other electrode by means of precision mechanism. Here one can control the resistance or size of contact, decrease or increase them. c) Shear method - the contact is formed by slightly bringing together the edges of two electrodes which can have random shapes and then by shifting one electrode along the other. As a result, contacts can be obtained in many places and due to the shear stresses the metal deformations and contaminations near the constriction are less than in the preceding case.

pound. Due to the dielectric layer, at the first light touch of electrodes the contact conductivity is often of the tunneling character, i.e. the contact resistance decreases with the increase of voltage. A metallic bridge appears at the increase of pressing force either as a result of dielectric cracking or of breakdown by the current pulse. The presence of dielectric film on the electrode is necessary to stiffen the whole structure. In this case the mechanical contact area is much greater than the size of metallic constriction.

In the needle-anvil configuration, the metal in the contact area is obviously deformed and polluted with pressed-in oxide residues, as well as with various impurities absorbed on the surface. Better results are obtained if the pressure contacts are created by the technique shown in Fig.7c. In this instance the elec-

trodes are brought together till touching, then they are shifted relative to one another in the plane of their crossing. As a result of it, the deformation of metal here is much less while the oxide and surface impurities are carried out of the contact area. Thus, constrictions are formed in those places where the cleaned areas of electrodes come in contact. With this technique, the samples can take the form of small bulk cylinders or blocks of metal, as well as films deposited on dielectric rods. By shifting the electrodes independently in the mutually perpendicular directions or rotating them about their axes, one can change the places of contact and obtain a number of shorts with different resistances within the same measurement cycle.

The point-contact spectroscopy would be impossible if the characteristics to be measured were critically dependent on the constriction geometry which cannot be controlled due to the small size of short. However, experience has shown that if the contacts were chosen properly by means of experimental criteria, the reproducibility of PC spectra is not worse than in tunneling spectroscopy where this choice is generally accepted. Let us formulate the quality criteria of PCs which meet the requirements of the theoretical clear orifice model, the orifice being much smaller than the electron mfp. We shall take a PC spectrum of one of simple metals, sodium (Fig. 8) as an example.

1. For pure metals, the contact resistance is within 1 to 100 Ω and the constriction has the metallic conductivity, i.e. its resistance increases with the increase of voltage so that $d^2V/dI^2 > 0$ over the whole energy range.
2. Sharp peaks or other distinct features are observed in the second derivative (PC spectrum) at the energies from zero to the Debye one $\varepsilon_D \simeq \hbar\omega_{max}$ reproduced for different contacts of the particular metal. For the energies $eV > \varepsilon_D$ the spectrum assumes a certain constant value called the background. The background parameter $\gamma = B/A$ (Fig. 8) should be small enough, different for each metal, but as a rule not greater than 0.5.

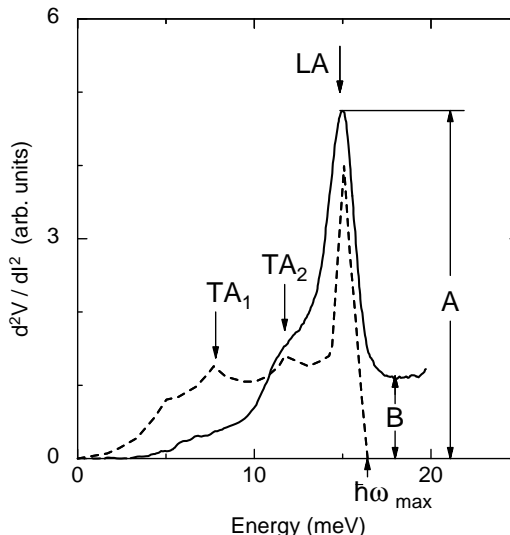

Figure 8: Point-contact spectrum of one of simple metals, Na (solid curve). The curve clearly reveals three features due to the electron excitations of phonons in two transverse (TA) and one longitudinal (LA) branches. Comparing the spectrum with the phonon density of the states (dashed curve) one can see that in this case electrons interaction with transversely polarized phonons is considerably suppressed which is due to the closed Fermi surface of this metal.

3. Relative variation of differential resistance within the spectrum should be maximum (from ones to tens per cent) at minimum γ . The initial portion of the d^2V/dI^2 curve at the energies $eV \ll \varepsilon_D$ is smooth and has no features.

The above attributes make it possible, judging by the form of the PC spectrum, to estimate the contact suitability for further investigations of the electron-phonon interaction function. Applying these criteria to the spectra shown in Fig. 4, one can see that they are satisfied by curves 1 and 2.

8 How to measure the second derivative

One of the widely used methods of measuring the current-voltage characteristics derivatives is the modulation technique. It consists in the following. Besides the measuring direct current I , the sample is supplied with a definite frequency ω ac current. In this case the contact voltage can be presented as a Taylor series

$$\begin{aligned}
 V(I + i \cos(\omega t)) &= V(I) + \\
 + \frac{dV}{dI} i \cos(\omega t) + \frac{1}{2} \frac{d^2V}{dI^2} i^2 \cos^2(\omega t) + \dots &= V(I) + \\
 + \frac{dV}{dI} i \cos(\omega t) + \frac{1}{4} \frac{d^2V}{dI^2} i^2 (1 + \cos(2\omega t)) + \dots & \quad (5)
 \end{aligned}$$

If the current i is sufficiently small, the higher-order in i terms can be neglected. It can be seen that the signal measured at the frequency ω will be proportional to the first derivative dV/dI of the current-voltage characteristics, while at the frequency 2ω it will be proportional to the second derivative d^2V/dI^2 . The next problem is to measure this weak voltage at the frequency ω and 2ω . This is achieved by a spectrometer whose schema is shown in Fig. 9. The sample (1) is held in a cryostat with liquid helium which is immersed into an outer cryostat with liquid nitrogen to reduce the heat input and coolant evaporation. Connected to the sample are four wires, a pair of which serves as an electric circuit, through which the contact is supplied with direct current from the source (2) and the alternating signal from the harmonic voltage generator (3). The direct voltage V created at the sample by current I is applied to the X-coordinate of the recorder (6) by means of the other pair of wires. This pair is also used for measuring the ac voltage of the second harmonic of modulating signal which requires a special circuit for its amplification and separation from noise. The circuit comprises the filter (4) and lock-in amplifier (5). When registering this signal, proportional to d^2V/dI^2 , the filter is tuned to resonance to a required frequency 2ω . The filter also serves for matching the low-resistance sample with the high-resistance input of the amplifier.

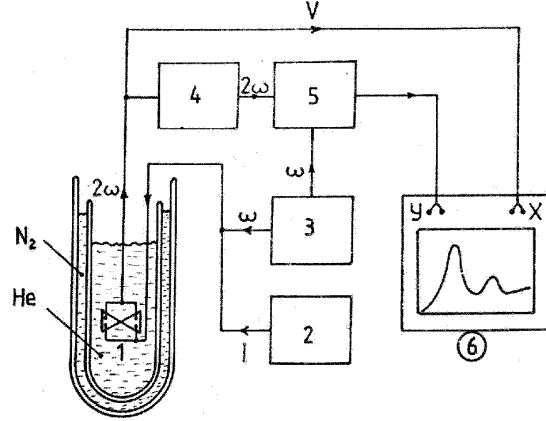

Figure 9: Schema of the spectrometer: 1 - sample, 2 - DC source, 3 - AC source, 4 - filter, 5 - lock-in amplifier, 6 - plotter.

Besides, the amplifier receives a 2ω generator signal used as a reference voltage. As a result of it, not only the signal is amplified but also the required frequency is separated. The voltage is converted into the direct one and applied to the Y-coordinate of the recorder. Thus, when a linearly increasing current from source (2) passes through the sample, the recorder will automatically record the second derivative of the current-voltage characteristics as a function of voltage.

As is seen from Eq.(5) the signal at the frequency 2ω is proportional to the square of the modulating current or first harmonic voltage amplitude V_ω . Therefore, it seems there are no special problems in measuring this signal by merely increasing the alternating component V_ω . However, it cannot be made arbitrarily large as the ac voltage amplitude determines the instrumental resolution of this technique. Exact calculations indicate that an infinitely narrow spectral feature when measuring d^2V/dI^2 by the modulation technique will be smeared to form a bell-shaped maximum $1.7V_\omega$ wide. In real experiments, the value of V_ω is as a rule not greater than a few millivolts, and in separate cases it can be equal to several tens of millivolt. In this case the value of measured signal which characterizes the nonlinearity

of current-voltage characteristics associated with the electron-phonon interaction is of the order of microvolts. At the same time the measuring circuit sensitivity is two orders of magnitude higher which makes it possible to reliably register the PC spectra.

It should be also noted that the point-contact spectroscopy resolution is dependent on the temperature T due to the Fermi level smearing by about $k_B T$. Therefore, to obtain distinct spectral features, the condition $k_B T \ll \varepsilon_D$ should be satisfied, i.e. measurements should be taken at temperatures considerably lower than the Debye ones. Under the action of the instrumental and temperature factors, the resulting resolution is expressed by

$$\delta = [(5.4k_B T/e)^2 + (1.7V_\omega)^2]^{1/2} \quad (6)$$

Generally, measurements are taken in liquid helium at a temperature of 1.5 to 4.2 K and modulating signal of 0.3 to 1.5 mV. As a result of it, the resolution calculated by Eq.(6) is 0.9 to 2.9 mV or, expressed in degrees, 10 to 34 K. This is at least an order of magnitude below the Debye temperatures of typical metals which enables obtaining a sufficiently detailed spectrum of electron-phonon interaction.

9 Point contact instead of reactor

Obviously, the headline of this section is rather advertising than true to life. A long time will pass till a nuclear reactor can be replaced by a competitive source of energy or research tool. Our headline is used in the sense that PC can compete with the reactor in certain fields of solid-state physics. We shall consider the experimental techniques of phonons investigation in metals and the determination of phonon spectrum.

One of the principal methods used for determining the phonon dispersion law $\varepsilon(q)$ is the study of neutron scattering in a crystal. The source of neutrons is usually a reactor. For this purpose use is made of the so-called thermal neutrons with the energy of 30 meV or 3000 K and, respectively, the de Broglie wavelength comparable to the lattice constant. Knowing the momentum and energy of incident neutrons, then measuring their energy and momentum after scattering,

on the basis of conservation laws one can determine the energy and momentum of phonon by which the neutron was scattered. Thus one obtains the dispersion curves shown in Fig.2a. Since the law of phonons dispersion in a crystal is anisotropic, the dispersion is more often measured only for few principal crystallographic directions as the measuring procedure itself is rather long and requires a powerful source of neutrons. To obtain a phonon spectrum, one needs the dispersions in the lattice, then one should calculate all the phonons whose energy falls within the interval from ε_k to $\varepsilon_k + \Delta\varepsilon = \varepsilon_{k+1}$ (where $\varepsilon \leq \varepsilon_D$ and $\Delta\varepsilon \ll \varepsilon_D$), then plot this value (Fig.2b). Then repeat this procedure for the next interval from ε_{k+1} to $\varepsilon_{k+1} + \Delta\varepsilon$, etc. The less the interval $\Delta\varepsilon$, the more accurate is the $F(\varepsilon)$ curve. But, as mentioned above, it takes a long time to measure the dispersion curves, and they are available only for several principal crystallographic directions in the lattice. To obtain the dispersion law for a maximum number of directions, use is made of theoretical calculations describing the lattice thermal vibrations. The formulas employed for this purpose include the parameters which have definite values for one or another solid. These parameters are found by fitting the theoretically calculated dispersion curves to the experimental ones. The obtained parameters make it possible to calculate the dispersion curves for any direction and, therefore, to calculate the energy of phonons with any momentum value both in magnitude and direction, and to plot the $F(\varepsilon)$ curve. The required calculations are rather bulky, voluminous and need the use of a powerful computer. Besides, the result depends on the model selected, i.e. on how accurately the theory takes into account the real processes of atoms interaction in the lattice. In principle, it is possible to obtain the information on the phonon density of states in a more direct "modelless" way. For some metals one can use the one-phonon incoherent scattering of neutrons when the directly measured scattering cross-section of neutrons with a specific energy is proportional to the phonon density of states. However, the latter technique is not suitable for all metals and does not have high resolution.

How can the point-contact spectroscopy be of any help here and how can it substitute the reactor? We

1	ПЕРИОДИЧЕСКАЯ СИСТЕМА ЭЛЕМЕНТОВ						VII	VIII		
	I	II	III	IV	V	VI				
2	Li	Be								
3	Na	Mg	Al							
4	K				V	Cr	Mn	Fe	Co	Ni
	Cu	Zn	Ga		As					
5					Nb	Mo	Tc	Ru	Rh	Pd
	Ag	Cd	In	Sn	Sb					
6					Ta	W	Re	Os	Ir	Pt
	Au		Tl	Pb	Bi					
7										
		Pr			Gd	Tb		Ho		

Figure 10: Mendeleev’s periodic table containing only those elements which have been studied by point-contact spectroscopy (until 1988).

have demonstrated that the form of electron-phonon interaction function $G(\varepsilon)$ is dictated by the phonon density of states. It turns out that for practically all metals under investigation the spectrum extrema are stipulated by their presence in $F(\varepsilon)$. Moreover, for some metals, mainly polyvalent ones, such as Pb, In, Sn, Mg, Be, etc., these two dependencies $G(\varepsilon)$ and $F(\varepsilon)$ practically coincide in form. Therefore, the point-contact spectroscopy can be referred to as a new method of phonon spectroscopy in metals. It should be mentioned that the PC experiments are simple and accessible for any physical laboratory. One should only have liquid helium for low temperature measurements and ordinary electronic engineering equipment. It is noteworthy that PCs can be created by means of very small amounts of a substance, a few cubic millimeters of which being sufficient. It becomes especially important for studying rare substances available only in small quantities.

To date, the PC spectra have been obtained for almost four tens of pure metals indicated in Fig. 10. If we drop the rare-earth elements, we have to measure yet of about ten metals, basically highly active alkali-earth and alkali ones. By means of point-contact spectroscopy, it became possible to refine the positions of extrema and other features of the $F(\varepsilon)$ function. For a number of metals it was possible to determine the shape of the whole curve, i.e. to find out

the number of maxima, their positions with respect to energy and relative intensities.

10 Study of electron-phonon interaction

It has already been mentioned that the spectral function $G(\varepsilon)$ is a kind of transport function of the electron-phonon interaction. By comparing $G(\varepsilon)$ with phonon spectra for various metals, one can study the Fermi surface effect on the dynamics of electron-phonon interaction. Thus, in alkali metals Na and K the Fermi surface is practically a sphere. At such an isoenergetic surface, it is difficult for electrons to interact with transversely polarized phonons. In fact, the features associated with scattering by transverse (T) phonons are strongly suppressed in the PC spectra of sodium (Fig. 8) and potassium. On the contrary, the Fermi surface in noble metals is open which is favorable for interaction with transverse phonons, so in the PC spectra of copper (Fig. 12), gold, silver the peaks corresponding to these phonons prevail. Finally, in the polyvalent non-transition metals: lead, tin, magnesium, beryllium (Fig. 12), etc., the Fermi surface is of intricate configuration and few phonons of one or another polarization are released. In this case the $G(\varepsilon)$ function shape is closed to the dependence of phonon densities of state, i.e. one can assume that the parameter $\alpha^2(\varepsilon)$ in the formula (3) is weakly dependent on energy.

On the other hand, the electron-phonon interaction function itself is of fundamental importance. It determines the properties of metals stipulated by the electron-phonon interaction, in particular the possibility of superconducting transition, as well as various kinetic parameters characterizing the charge and energy transfer. The point-contact spectroscopy yields detailed information on the relative force of electrons binding with some groups of phonons, e.g. with those transversely or longitudinally polarized. Thus, it becomes clear which phonons play more important role in various processes. For normal non-superconducting metals, the study of PC spectra is the only experimental technique which enables direct

measurement of energy dependence of the spectral function of electron-phonon interaction.

11 Magnons and excitons

From the very childhood we have used to metals breaking down into magnetic and nonmagnetic ones without thinking on the nature of such difference. This classification of metals has been explained in terms of quantum theory. Generally speaking, magnetism is a purely quantum-mechanical phenomenon that cannot be explained in the framework of classical theory. As one of the well-known physicist said, if the Planck constant had gone to zero, there would have been no science of magnetism.

As is known from the atomic physics, an electron has its moment of momentum, the spin. Besides, an electron in an atom has an orbital magnetic moment due to the motion about the nucleus. To determine the total magnetic moment of an atom, one should consider its electronic structure. If the atoms with a magnetic moment are united in a lattice, it is not enough to make the whole material magnetic. Everything will depend on the actual interaction of moments in which the so-called exchange forces play an important role. These forces arise due to quantum indistinguishability of particles and the Pauli principle. The exchange forces are not connected with direct interaction of spin magnetic moments which is weak but are dependent on their relative positions. The exchange interaction just makes the magnetic moments of separate atoms feel one another and line up in a certain way: in parallel or in antiparallel direction. In the former case we obtain a ferromagnet, in the latter case antiferromagnet.

Consider, for example, a ferromagnetic metal in which the magnetic moments of atoms have the same direction. Let for some reason, for example due to thermal vibrations, one atom reverse the direction of its moment. Then the neighboring atom will be affected by a force tending to change over the direction of its magnetic moment too, etc. Hence, a wave of magnetic moment reversals will pass through the crystal. This wave was called the spin wave. The spin reversal events in magnetic materials are usually con-

sidered in the language of spin waves convenient for the theory. According to the quantum mechanical principle of dualism, the waves can be substituted by quasi-particles and, by analogy with a phonon, the spin oscillation wave was called a magnon.

Thermal vibrations "rock" the magnetic moments and with the increase of temperature the number of atoms with reversed spins, or, in other words, the number of magnons increases. When the energy of thermal vibrations becomes equal to that of exchange interactions, there will be no ordering of magnetic moments and the magnetic metal will become nonmagnetic. The temperature at which it occurs was called the Curie temperature Θ_c . The latter is similar to the Debye temperature for phonons: there can be no magnons with the energy above $k_B\Theta_c$ in metal.

Magnons are quasi-particles similar to phonons. They carry heat, scatter the conduction electrons, i.e. affect the kinetic properties of metals. Therefore, it is quite reasonable to suppose that the electrons scattering by magnons or, more precisely, the magnons excitation by electrons in a PC should cause non-linearity of current-voltage characteristics, as is the case with phonons, and the PC spectrum will display the features associated with the electron-magnon interaction. Indeed, such features were registered when investigating the PC spectra of rare-earth metals Gd, Tb, Ho which are ferromagnetics at low temperatures. A question arises why rare-earth metals were investigated but not less exotic well-known ferromagnetics, such as Fe, Ni, Co. The matter is that in these metals the Curie temperature, and consequently the energy of magnons, is considerably greater than those of phonons. At this time it turns out that the electron-phonon interaction essentially decreases the electrons mfp and the ballistic regime in a contact is disturbed before reaching the energy of characteristic magnon frequencies. On the contrary, in the above mentioned rare-earth metals the Curie temperature is less than the Debye temperature and the electron-magnon interaction features show up at lower energies than the phonon ones.

In a solid, the conduction electrons can also interact with other elementary excitation or "-ons". Let us dwell on one of such quasi-particles, an exciton, representing the electronic excitation in a crystal

of semiconductor or dielectric. As a result of interatomic interaction, an exciton propagates over a crystal in the form of a wave without carrying charge or mass. Excitons are most intensively emitted from semiconductors and dielectrics where they present a bound state of the conduction electron and hole. However, there exist some exciton-like excitations in metals as well.

Thus, in the compound PrNi_5 the main nine-fold degenerated state of Pr^{3+} ion is split by the intracrystalline electric field of lattice atoms into six energy levels, three of which remain doubly degenerate, the other three presenting a separate level of energy (see diagram in Fig. 11. When the Pr^{3+} ion is excited, it can reside in one of the higher-lying states, for example Γ_{5A} , in which it has a magnetic moment. Such an excited state is transmitted from ion to ion, i.e. it can be treated as a magnetic exciton. The processes of Pr^{3+} ions excitation by electrons should obviously cause the PC spectrum features at corresponding energies.

At low temperatures, the Pr^{3+} ion is in the ground state Γ_4 with minimum free energy. When the ion is excited, it can move to the above-mentioned level Γ_{5A} , as well as to the higher-energy levels Γ_3 and Γ_{5B} . Other transition to the levels Γ_1 and Γ_6 are forbidden by the selection rules. However, in an external magnetic field this exclusion is lifted (it remains only for one high-symmetrical direction along the hexagonal axis), and the Zeeman splitting of spin-degenerate levels occurs (see Fig. 11).

The processes of Pr^{3+} ion excitation by electrons, as a result of which the ion moves to a higher-lying level, bring about their inelastic scattering and manifest themselves in the PC spectrum as peaks at the corresponding energies. In the zero field the PrNi_5 spectrum distinctly reveals three features associated with the transitions shown in Fig. 11(lower panel). The most intensive peak corresponds to the Pr^{3+} ion excitation to the state Γ_{5A} . Evidently, these processes will make maximum contribution into the resistance of this substance. The probability of other transitions and, respectively, their influence on electric conductivity and other kinetic and thermodynamic properties of PrNi_5 is appreciable less. These are the simplest qualitative conclusions that can be

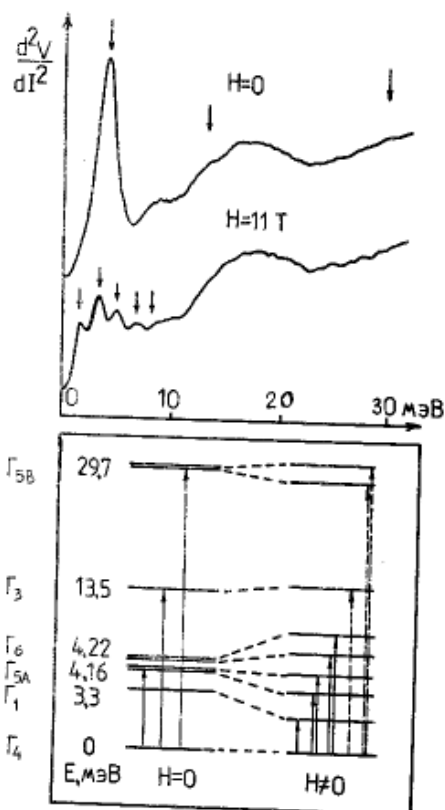

Figure 11: Above: Point-contact spectrum of PrNi_5 in a zero magnetic field and in a field of 11 Tesla. Arrows indicate the peculiarities due to the Pr^{3+} ion transitions between the energy levels split by the intracrystalline field. Below: scheme of the Pr^{3+} energy levels in the intracrystalline electric field and their additional splitting in the external magnetic field. Arrows indicate the allowed transitions marked on the PC spectra. The transitions marked by dashed lines are weakly probable in the magnetic field and are not visible on the spectra.

made directly from the form of PrNi₅ PC spectrum.

The probability of transition to previously forbidden levels manifests itself in the magnetic field and Zeeman splitting of the remaining degenerate levels occurs. Consequently, the PC spectra should change when the magnetic field is switched on, which can be seen in Fig. 11 (upper panel). An especially noticeable evolution occurs with most intensive maximum. Here, together with the peak splitting at 4 meV, one can see additional features connected with the transitions to the levels Γ_6 and Γ_1 . Hence, instead of one maximum several maxima appear in the magnetic field. Note that these features can be distinctly observed only in a sufficiently high magnetic field. Thus, for example, the amount of splitting evaluated by the formula $E = 2g\mu H$ (where g is Lande factor, μ is the Bohr magneton) should be greater than the resolution of this technique which is about 1 meV. As a result of it, the magnetic field amplitude should exceed 4-5 Tesla and the higher the amplitude, the more distinct are the features. That is why PrNi₅ was studied in a field of up to 21 Tesla, while the figure, by way of example, shows the spectrum for an intermediate field.

It should be noted that measurements were carried out on single-crystalline samples of PrNi₅ for three principal crystallographic directions, which made it possible to detect also the anisotropy of Zeeman splitting. When doing so, we for the first time obtained the experimental data on the exact positions of levels the transitions to which are forbidden in zero field. These data were used for comparison with theoretical calculations which allowed us to determine the parameters characterizing the intracrystalline field in a particular compound. The above results can serve as an example of how new data were obtained by point-contact spectroscopy which enabled the construction of a quantitative model of the intracrystalline effects influence on the PrNi₅ properties.

12 From pure metals to alloys and compounds

In principle, any energy-dependent mechanism of electrons scattering in metals can be studied by means of point-contacts. To put it in another way, the processes influencing the inelastic mfp of electrons in the lattice will be reflected in the point-contact spectra. This can be easily proved using the already mentioned Wexler formula (2) for the contact resistance. The second term in this formula, the Sharvin resistance, is a constant for the product of ρl is constant. The Maxwell resistance can be rewritten as $R_M = \rho l/d (1/l)$ where the first cofactor is also constant and the second $1/l$, is energy-dependent if there exist the electron scattering processes affecting the electron mfp, i.e. $l = l(\varepsilon) = l(eV)$. For the second derivative of the current-voltage characteristics we shall write $d^2V/dI^2 \sim R dR/dV$. Substituting instead of R its expression from Eq.(2) we obtain that

$$d^2V/dI^2 \sim \rho l/d d/dV [1/l(eV)] \quad (7)$$

Thus, the second derivative will have extrema at those energies at which the mfp of electrons changes rapidly. In the case of electron-phonon scattering the electron mfp considerably decreases at those energies at which there exist a large number of phonons, i.e. at the phonon spectrum maxima. That is why a peak can be expected in this place of d^2V/dI^2 .

It has been previously noted that the spectral regime is realized only in very small contacts, such that the electron mfp should exceed the constriction size. There are two mfp of electrons in conductors: the elastic mfp l_e after passing which the electron changes its momentum or direction of motion, and the inelastic mfp l_i at which the electron changes its energy, l_e is independent of the excess energy of electrons and, according to Eq.(7), should not affect the point-contact spectrum form. A question arises whether the point-contact spectroscopy is possible if the elastic mfp becomes less than the short size. This question is not idle since many alloys and compounds have rather small l_e . The positive answer makes it possible to apply the point-contact spectroscopy technique not only to pure metals whose number, though

large, is limited, but also to practically unlimited collection of more or less complex alloys or compounds of different metals. It turned out that the technique works under less strict conditions, namely if the inelastic relaxation length during the diffusion motion of electrons in the contact l_D which in the case of alloys is determined by $l_D = (l_e l_i/3)^{1/2}$ is greater than the size of contact. The condition $d \ll l_D$ can in many cases be satisfied for PCs made of complex substances and the spectral information on electron scattering mechanisms can be obtained. The regime at which the condition $l_e \ll d \ll l_D$ is met was called the diffusion regime. In this case, as was shown by theorists, the proportionality between d^2V/dI^2 and the spectral function $G(\varepsilon)$ is preserved, only in the right-hand part of Eq.(4) an additional factor appears that is proportional to the l_e/d ratio and leads to the decrease of point-contact spectrum intensity, for $l_e/d \ll 1$.

If impurities are introduced into a perfect lattice, it will cause the decrease of elastic electron mfp $l_i < l_e, d$, which is the smaller, the higher concentration of the impurity. At this time the point-contact spectra will not change at low impurity concentrations (up to several per cent), only their absolute intensities drop. A more interesting case is when the mass m_i of the impurity atom substantially differs from the mass M of lattice atoms. Thus, for example, if $m_i \ll M$, there arise the so-called local oscillations of the impurity atom with a frequency higher than the maximum one of the host lattice vibrations. At the inverse relation $m_i \gg M$, the quasi-local oscillations with a frequency essentially lower than the Debye one appear in the spectrum of lattice frequencies. It can be readily understood qualitatively if we recall that the frequency of oscillator (pendulum) oscillations is inversely proportional to the square of its mass. It appears that the electrons scattering by local and quasi-local oscillations occurs inelastically, i.e. with the change of energy. Hence, the peculiarities connected with such oscillations can be expected in the point-contact spectra.

Fig.12 shows the spectrum of beryllium, as well as the CuBe alloy containing 4.2 atomic percent of Be. One can see that an additional feature has appeared in the d^2V/dI^2 curve. This feature cannot be

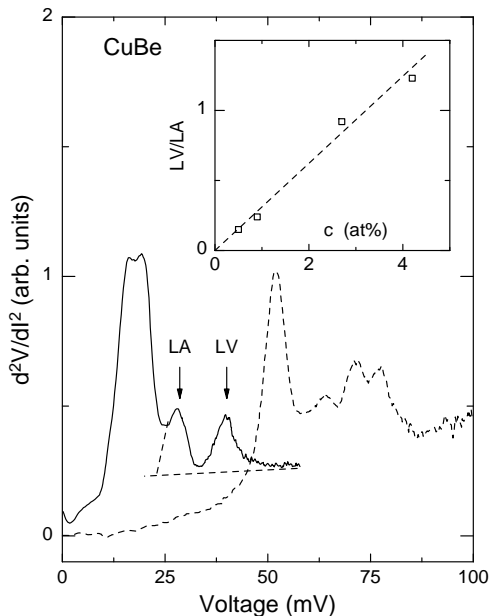

Figure 12: Point-contact spectrum of copper alloy with 4.2 at.% of beryllium. It is seen that in the Cu spectrum (between 0 and 30 mV) has developed a new maximum (LV) at 40 mV which is absent both in the spectrum of pure copper and beryllium (dashed curve). It is connected with local vibrations of the Be atoms in the Cu lattice. Inset shows increasing of LV maximum intensity relative to LA phonon peak in Cu with beryllium content rise.

found either in the spectrum of copper or in that of beryllium. This is exactly the band of local oscillations. In this case the impurity atoms are seven times lighter than the copper ones. Another example of an alloy with quasi-local oscillations is magnesium with the admixture of lead atoms. Here the difference in masses is 8.5 times. The point-contact spectra of this alloy also reveal a feature that could be expected in the region of energies essentially lower than the Debye one.

The other impurities which strongly scatter the electrons are the atoms of rare-earth metals of iron group which retain their magnetic properties when added to a normal metal. The electrons scattering by such elementary magnetics in a bulk conductor causes an abnormal for metals rise of resistance at

low temperatures known as Kondo effect. PC has proved to be a very sensitive indicator for detecting magnetic impurities in metal. Thus, when adding only 0.01% of iron or manganese atoms to copper, the point-contact spectrum will display distinct additional features in the energy range 1-2 meV which are connected with the electrons scattering by localized magnetic moments. One can evaluate the number of impurity atoms getting into the contact area at the above concentration $c = 10^{-4}$. The total number of atoms in a constriction with size d will be V/θ , where $V \simeq d^3$ and θ is the volume per atom. The number of impurity atoms N_i is estimated as a value of the order of cV/θ . For copper $\theta = 1.17 \times 10^{-23} \text{cm}^3$, and the size of PCs in question is about 1 to $2 \times 10^{-6} \text{cm}$. Therefore, we obtain the value of N_i equal to 8-70 atoms. It is of interest that the PC area contains a measurable number of atoms whose effect is, however, noticeable in the measured characteristics. Thus, we can say that the point-contact spectroscopy is a unique method of studying the electrons scattering by single microscopic centers.

13 Contact heating

So far we consider PCs whose dimensions are small in comparison with the electron mfp. As has been shown, in this case a highly nonequilibrium function of electrons distribution is realized and there exist two groups of electrons whose energies differ by eV . Relaxation of such a nonequilibrium state leads to the excitation of quasi-particles with the energy $\varepsilon \leq eV$ and to the nonlinearity point-contact current-voltage characteristics which contains spectral information about the energy distribution of quasi-particles under investigation. It turned out that even in the case of small elastic mfp the spectroscopic capabilities of contacts remain. For this purpose it is only necessary that the diffusion length of energy relaxations should be greater than the size of constriction. It is of interest what will happen if the elastic and inelastic lengths will be considerably smaller than the size of contact. In other words, what will happen if the contact dimensions are large or when studying the substances with sufficiently short relaxation lengths. It

appears that in such constrictions the flow of current of the required density leads to conventional Joule heating. The heat removal from such large contacts with small mfp is less efficient than in the ballistic regime. Since in metals the heat removal from the hot region to the bulk of the sample is principally effected by the conduction electrons, it can be shown that when the Wiedemann-Franz law holds, the voltage drop at the contact and the metal temperature at the center T_{pc} are related as

$$(k_B T_{pc})^2 = (k_B T_0)^2 + (eV)^2/4L \quad (8)$$

where T_0 is the measurement temperature, L is the Lorentz number. If measurements are taken at low temperatures, i.e. $T=0$, the contact temperature will be linearly dependent on its voltage $k_B T_{pc} = eV/2\sqrt{L}$. Substitute the known Lorentz number and obtain that $T_{pc} \simeq 3.2 \text{ K/mV}$, i.e. a voltage of 1 mV raises the temperature at the contact center by 3.2 degrees. The situation seems paradoxical: the samples are at a temperature of liquid helium, but if we apply to the contact a voltage of only 100 mV or 0.1 V, the temperature of the contact becomes higher than the room temperature. Is it possible and how to verify this conclusion? Yes, it is, and rather simply. If we take the above-mentioned ferromagnetic metals, at the Curie temperature the transition from ferromagnetic into paramagnetic state occurs. As a result of it, an inflection appears in the electrical resistivity curve, i.e., magnons and associated scattering disappear. As noted above, the contact resistance is expressed by the Maxwell formula $R_M = \rho/d$, so when reaching the Curie temperature in the contact, its resistance curve will have features similar to that of $\rho(T)$. These peculiarities, which must show up still definitely in the second derivative of current-voltage characteristics $d^2V/dI^2 \simeq dR/dV$. Such features of the point-contact spectrum for ferromagnetic metals were observed at voltages equal, for example for Ni, to about 200 mV. This corresponds, according to Eq.(8), to the known Curie temperature of nickel equal to 630 K (Fig.13). When adding beryllium atoms to Ni, T_c of this alloy decreases and the feature of d^2V/dI^2 also shifts to the region of lower voltages in full agreement with the above formula. This testifies of the fact that, actually, the temperature reached

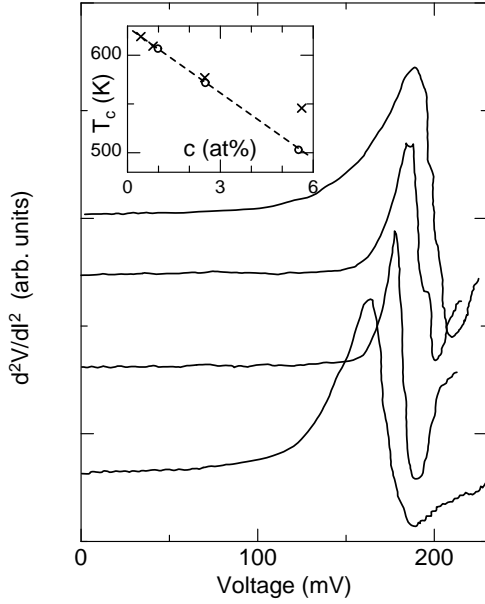

Figure 13: Second derivative for PCs of nickel (upper curve) and its alloys with beryllium $\text{Ni}_{1-x}\text{Be}_x$ $x \simeq 0.01, 0.03, 0.06$ (bottom curves) far above the phonon energies. The observed sharp features are due to the near-contact metal transition from the ferromagnetic state to the paramagnetic one when heating by current up to the Curie temperature. The shift of features towards smaller voltages (see inset) when adding beryllium to nickel is due to the Curie temperature decrease in the alloy and proceeds according to Eq.(8).

at the contact center causes the metal transition from the magnetic to the nonmagnetic state.

The criterion of thermal regime is also the dependence of the above anomaly position on the bath temperature T_0 . At this time it can be observed without making measurements in helium. The anomalies were found out for nickel contacts at room temperature, only they were shifted towards smaller voltages. It follows from Eq. (8) that the required temperature in the contact is reached at the lower voltages, the higher the measurement temperature T_0 . Thus, all kinds of d^2V/dI^2 anomalies, if they are of thermal nature, will shift over the voltage scale depending on the measurement temperature. At the same time the

spectral features of d^2V/dI^2 do not change their positions with temperature, they only broaden according to Eq. (6).

One of the straightforward and easy-to-grasp examples of the experimental evidence of temperature increase inside the contact was its critical voltage observation. This critical voltage cannot be exceeded no matter how the current rises. The nature of this phenomenon consists in that each metal has the so-called "softening" temperature, about one-third of the melting one, at which the metal readily lends itself to plastic deformation. When the contact voltage reaches the corresponding "softening" value, under the action of pressing force the contact spot will increase or the contact resistance will decrease, so that at the current build-up a certain critical voltage cannot be exceeded. This was observed for many metals with different melting temperatures in which they correlated with the contact critical voltages.

In the above thermal regime, the current-voltage characteristics nonlinearity is governed by the temperature dependence of resistivity, as the contact resistance is $\rho(T)/d$ and its temperature is voltage-dependent. This enables obtaining the $\rho(T)$ behavior by low-temperature measurements of the contact resistance as a function of voltage, i.e. without direct measurements of $\rho(T)$. The advantages of this technique are the possibility of direct measurements $d\rho(T)/dT$ derivatives proportional to dR/dV or d^2V/dI^2 , the possibility of using small quantities of substances, the absence of need in the systems for controlling and stabilizing the sample temperatures. The above technique was called modulation temperature spectroscopy since when measuring the current-voltage characteristics the sample is supplied with a low modulation voltage and the contact temperature in the thermal limit is changed (modulated) in step with the voltage. Note that in this case the contact size has no upper bound and the result is independent of the constriction geometry. It is only necessary that the heat should be removed from the contact mainly by electrons.

Another convincing proof of metal heating inside the contact in the thermal regime was the detection and explanation of current-voltage characteristics asymmetry in a number of heterocontacts de-

pending on the applied voltage polarity. Consider an electric circuit comprising a heterocontact formed between different metals and a potentiometer connected to it by two wires. Let the sample temperature be T_0 , the instrument is kept at room temperature T_{room} and the wires have the temperature gradient from T_{room} to T_0 . This will cause the electron diffusion from a hotter end to a colder one and the appearance of thermoelectromotive force ⁵. However, the gradient exists only in wires which are identical and equal quantities of electrons per unit time will arrive at the cold ends of wires. The potentials will be the same and the outside device will read the voltage (potential difference) equal to zero. The situation will change if the contact region will heat up and the temperature will become other than T_0 . A similar diffusion of electrons from the hot region to the cold one will start in metals making up the heterocontact. As the metals are different, in one of them the diffusion will proceed faster than in the other. As a result of it, the potentials at cold ends will differ and the device will read some potential difference due to thermoelectromotive force. To describe the thermoelectric phenomena quantitatively, we will introduce the Seebeck coefficient S . It indicates, for example, what potential difference will exist at the ends of a conductor if a temperature difference of one degree is maintained between them. If one knows S of each metal in a heterocontact, one can calculate the potential difference between the cold ends of metals making up the heterocontact. The potential at one end will be $S_1(T_{PC} - T_0)$, at the other end it will be $S_2(T_{PC} - T_0)$ and the potential difference registered by the outside instrument will be $(S_1 - S_2)(T_{PC} - T_0)$. To be more precise, we shall note that the above considerations are valid if the coefficient S is temperature-independent. Otherwise, the sample under study should have been divided into small sections at which the temperature difference is sufficiently small to treat S as a constant, and then to sum up the thermoemf of all these sections. This actually implies integration and finally one can write

⁵In real metals the thermoelectric phenomena are connected not only with the electron diffusion but also with more complicated processes, such as phonon drag, etc., which should not be necessarily taken into account in this consideration.

the well-known formula $V_{temf} = \int_{T_0}^{T_{PC}} (S_1 - S_2)dT$ to determine the thermoemf in a contact of two metals.

What will be the effect of thermoemf when measuring point-contact characteristics of heterocontacts in the thermal regime? The answer is rather obvious: it causes the asymmetry of current-voltage characteristics depending on the polarity of voltage applied to the contact. The reason of it is as follows. In one polarity denoted by, say (+), the voltage applied to the contact will coincide with V_{temf} and add to it while in the other polarity denoted by (-) the applied voltage will be subtracted. As a consequence, at current I through the contact, its voltage in the former polarity will be $V^{(+)} = IR_{PC} + V_{temf}$, and in the latter polarity $V^{(-)} = IR_{PC} - V_{temf}$, where R_{PC} is the contact resistance at zero voltage. Thus, the resistance dependence in one polarity $R^{(+)} = V^{(+)} / I = R_{PC} + V_{temf} / I$ will differ from the other one $R^{(-)} = V^{(-)} / I = R_{PC} - V_{temf} / I$ and will cause the asymmetry of current-voltage characteristics. This asymmetry can be more clearly observed on the current-voltage characteristics derivative, for example differential resistance $R_D = dV/dI$. Here, by analogy, we shall write $R_D^{(+)} - R_D^{(-)} = 2dV_{temf}/dI = 2d/dI \int_{T_0}^{T_{PC}} (S_1 - S_2)dT \simeq 2R_{PC}d/dV \int_{T_0}^{T_{PC}} (S_1 - S_2)dT$. As mentioned above, in the thermal regime there exists a linear relation $k_B T = eV/2L^{1/2}$ between the contact temperature (at $T_0 \ll T_{PC}$) and voltage. That is why the above expression can be simplified after substituting the differentiation variable V by T as

$$\frac{R_D^{(+)} - R_D^{(-)}}{R_{PC}} = \frac{e}{k_B \sqrt{L}} [S_1(T_{PC}) - S_2(T_{PC})] \quad (9)$$

Thus, the asymmetry of differential resistance of heterocontacts in the thermal regime is proportional to the Seebeck coefficients difference of the contacting metals. A more rigorous theory which appeared later on confirmed this qualitative analysis.

The current-voltage characteristics asymmetry of heterocontacts is especially clearly defined in substances with short mfp and large Seebeck coefficients. These systems include heavy fermion compounds, Kondo lattices, intermediate-valence systems. The measurements of current-voltage charac-

teristics asymmetry in such conductors may give information of thermoemf behavior therein. For this purpose one should use the second electrode of normal metal whose Seebeck coefficients are considerably smaller than in the above compounds, i.e. $S_1 \gg S_2$. Hence, the R_D asymmetry will be directly proportional to the Seebeck coefficient (see Eq. (9)) in the substance under study. This is of not only the academic interest, for it can be used for analyzing the S behavior in the sample, especially when studying substances available in small quantities for which the traditional methods of determining the Seebeck coefficient are hard to apply.

We have considered the cases of contact heating under the action of transport current. Naturally, this does not exhaust all thermal effects which are interesting when investigating PCs. Another important trend is the study of heat conductivity in shorts when instead of (or together with) the potential difference a temperature gradient is applied to the contact. Theoretical treatment of heat transfer through PC in the ballistic regime brought about a rather unexpected result. The second derivative of the heat flux versus voltage proved to be directly related to the electron-phonon interaction function. It is not that simple to measure this derivative and it has not yet been done experimentally.

However, some studies confirm the specific features of heat conductivity in PCs. One of the contacts making electrodes was attached to a heat exchanger while the other was held in vacuum. Both electrodes carried miniature pickups to check the electrode temperatures depending on the contact voltage. The temperature was found to rise slightly with voltage in each electrodes, this temperature being different for various polarities. When the temperature difference versus voltage curve was plotted, it was close in shape to the electron-phonon interaction function of the contacting metals. Therefore, the above experiments evidence the electron-phonon interaction effect on the heat conductivity of PCs and confirms, though not directly, some theoretical conclusions. It should be noted that the measured temperature difference has a finer structure that can be related to the peculiarities of phonon scattering and enables their investigation.

Now let us see what happens if a contact is affected only by the temperature gradient. Let one electrode be held at helium temperature T_0 and the other at T , the inequality $T_0 < T$ being held. In this case the heat will be transferred from the heated part through a constriction to the colder part. In other words, phonons will propagate from the hot place where their number is large to the cold place where their number is smaller. The electron diffusion will proceed in the same direction, thus causing the emf. However, when the contact is formed by electrodes of the same metal, as stated previously, the potentiometer connected to the ends of electrodes should read zero voltage. Nevertheless, an experiment made according to this scheme demonstrated that this not quite the case. Even if the contact is homogeneous and the electrodes are maintained at different temperatures, a potential difference will develop between their ends. This occurs because in this case there is a circuit of homogeneous in composition but strongly geometrically inhomogeneous materials due to PC where kinetic processes are specific. Thus, for example, the flow of phonons directed from the hot part to the cold one drags⁶ the electrons. This causes thermal emf of the so-called phonon drag. It is "hard" for the phonons to drag the electrons through the bottleneck of PC and the drag thermoelectromotive force is suppressed⁶. In the case concerned total thermoemf will be written as a difference between the bulk and contact contribution. The latter is strongly suppressed in the contact, so only the bulk contribution remains. Hence, the potentiometer connected to the sample leads will read the voltage to a higher extent governed by the drag thermal emf. This offers probably a unique possibility of measuring the absolute coefficient of thermal emf in a material-homogeneous electric circuit.

⁶As shown by theoretical treatment, the diffusion part of thermal emf will be also suppressed in PC, but less than associated with drag.

14 Electrical fluctuations in PCs

Noises present an important problem in science and technology since they dictate the sensitivity of existing radio-electronic devices which, in its turn, limits the magnitude and accuracy of measurements, the quality of processing various signals. The investigation of sources and nature of noise makes it possible not only to measure it, but also to suppress it, thus increasing the signal-to-noise ratio for particular measurements or devices.

What is noise? It is an unwanted voltage or current of fluctuation nature generated by the electronic device or some circuit component. If this voltage is applied to an audio-frequency amplifier, this voltage gives rise to a hiss in the loudspeaker. Hence the name "noise" which is applied to such fluctuation processes, though in most cases we do not actually hear it.

What are the current or voltage fluctuations due to? First of all, the current carriers in a conductor are in constant motion. As a result of it, fluctuation emf appears at the conductor ends. At each particular moment of time this emf will have a definite value, but averaged over a longer time it will be equal to zero. This noise was called thermal or Nyquist noise, while the average square emf $\langle V_n^2 \rangle$ arising at the resistance R and temperature T in the frequency range Δf can be written as $4k_B TR \Delta f$. The other type of noise is connected with the discreteness of current carrier charge. Thus, for example, the events of electron flying out of the cathode (emitter) of electronic tube (transistor) form a sequence of independent events, occur at random times and lead to the so-called shot noise. At this time $\langle V_n^2 \rangle \propto eIR/C$, e being the electron charge, C the system capacity, i.e. the shot noise is proportional to the current.

In an impurity-free semiconductor electrons and holes can appear and disappear at random due to their generation and recombination. This also causes fluctuation emf in the sample called generation-recombination noise.

One more source of noise attracted attention first in the electron vacuum tubes. It was attributed to

the average emission rate alteration causing microscopic current fluctuations. The emission rate alteration can be treated as some effect of collective interaction of electrons, as a result of which such oscillations or flicker of current occur. This noise is known as flicker noise. It is also characterized by the fact that the spectral power of flicker noise density $S_V = \langle V_n^2 \rangle / \Delta f$ is frequency dependent close to the $1/f$ law, that is why it is also called $1/f$ noise. The nature of this noise is not quite clear to date. Different models are suggested, particularly recently the flicker noise in solids has been explained in terms of two-level system which serve as elementary disorder carriers in the crystal lattice.

The noise in electric contacts was studied rather in detail. In 1969 Hooze obtained an empirical formula for the spectral density of contact noise at the frequency f : $S_V = \alpha V^2 / Nf$ where α is a constant, N is the total number of charge carriers in the contact. The latter value can be found from the formula $N = nv$ where v is the constriction volume, n is the carriers concentration. v can be easily estimate from the resistance $v \simeq d^3 = (\rho/R)^3$ using the Maxwell formula mentioned above. As a result we will obtain a more convenient expression for S_V , viz.

$$S_V \simeq \frac{R^3 V^2}{n \rho^3 f}$$

The spectral densities of noise have been also measured for PCs. Thus, for the thermal regime of current flow it was show that $S_V \sim V^t$ where $t \simeq 2$ at contact voltages up to a few millivolts, whereas at higher voltages S_V exponentially increases. The latter fact is attributed to highly nonequilibrium state of electrons and phonons in the vicinity of the contact when the characteristic phonon energies are reached. The S_V dependence on the sample resistance also appeared close to R^3 . Consequently, the noise behavior in PCs under thermal regime has no peculiarities compared to those already known.

However, the study of S_V dependence for contacts in the ballistic regime yielded some new unusual information. It turned out that in PC with $l_e, l_i \gg d$ the spectral density of noise does not increase monotonously but consists of a number of ex-

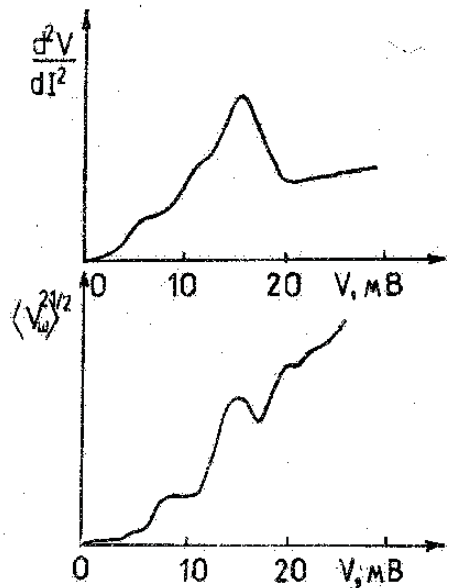

Figure 14: Above: point-contact spectrum of a tin contact recorded at the temperature 4.2 K. Below: "noise" spectrum for the given contact. In addition to the monotonic growth of noise, the curve display a number of maxima and minima attributed to the peculiarities of electron-phonon interaction in the contact.

trama, both maxima and minima (Fig. 14). In this case the minima positions in $\langle V_n^2 \rangle$ at $eV > \varepsilon_D$ corresponded to the energy of multiphonon scattering of electrons. It was suggested that such multiphonon generation in the constriction corresponds to the establishment of some coherent (ordered) regime of phonon emission at the realization of which the noise decreases. For the energies $eV < \varepsilon_D$ the $\langle V_n^2 \rangle$ also has some minima attributed to the one-phonon normal electron scattering in the coherent regime. It turned out that the positions of minima correspond to the energy at which the phonon dispersion curves cross the Brillouin zone boundary, i.e. the wave vector of phonons is maximum and their velocity is minimum. The latter circumstance promotes the accumulation of phonons in the vicinity of contact and the establishment of coherent regime of emission. On the other

hand, the positions of maxima in $\langle V_n^2 \rangle$ at $eV < \varepsilon_D$ coincide with the minimum energy of phonons for which the scattering with Umklapp is possible. Such scattering correspond to the Bragg reflection of the electron wave from the atomic plane in the lattice. At this time the electron momentum changes by the inverse lattice vector $2\pi\hbar/a$, i.e. equal to the double maximum momentum of phonon. The above processes are non-correlated because not only phonons but the lattice as a whole participate in the electron scattering events and the noise increases. The observed reproducibility of extrema position on the curve $\langle V_n^2 \rangle$ for contacts of different resistance and their relation to the characteristic phonon energies more precisely to the singular points of the phonon dispersion curves, makes it possible to speak about the noise spectroscopy of separate groups of phonons in metals.

15 PCs in a high-frequency electromagnetic field

For a considerably long time PCs have been used in microwave engineering as detectors, mixers and harmonic signal sources. Such contacts are formed by means of thin wire pressed against a smooth metal surface. The wire serves as a kind of antenna through which the high-frequency current penetrates in the bulk of the contact. As is already known, the current-voltage characteristics of PCs deviate from the Ohm law both in the ballistic and thermal regimes. This is why the contact is a nonlinear element and possesses the above detecting and other properties. However, the physics of processes proceeding in the contact under the action of microwave irradiation is of considerable interest.

The first thing done by researchers was to analyze the form of current-voltage characteristics derivatives at high frequencies. The experimental technique in this case differs a little from that described in Chapter 8 and used for audio frequencies. As is seen from Eq. (7), in addition to the signal proportional to d^2V/dI^2 at the frequency 2ω , there is a dc signal of the second derivative. To detect this constant

component of d^2V/dI^2 , the microwave signal is modulated by means of some chopper. For example, use is often made of a rotating disc with holes to pass radiation. Then, using a circuit similar to that described in Chapter 8, the signal proportional to d^2V/dI^2 is separated at the chopping frequency.

Naturally, the PC resistance is much lower than that of the surrounding medium, so when microwave field is applied, a high-frequency current will appear in the constriction and will play the role of modulation signal. Therefore, for a contact in the ballistic regime one can measure the second derivative proportional to the electron-phonon interaction function, but only at high frequencies. Such experiments were carried out and showed that the d^2V/dI^2 obtained in this way was identical to the second derivative recorded at low frequency. Distinctions appeared when the frequency became as high as giga- and tera hertz or the period of oscillation reached $10^{-9} - 10^{-12}$ s. Here d^2V/dI^2 began to change: first the background level decreased, then, at still higher frequencies, the spectral features began to broaden. These change in d^2V/dI^2 curve can be understood if we compare the microwave signal period with times of quasi-particles relaxation in the contact. Thus, the electron-phonon scattering occurs within 10^{-13} to 10^{-14} s which can be readily obtained dividing the mfp the Fermi velocity of electron. The phonon-electron scattering processes are as many times slower as sound (phonon) velocity is smaller than the Fermi one and are characterized by times 10^{-9} to 10^{-10} s. They also affect the point-contact spectrum causing the presence of phonon component background therein. Consequently, when the irradiation frequency approaches 10^9 Hz that is comparable with the frequency of phonon-electron relaxation, the phonon reabsorption processes will slow down because they will not be able to trace rapid oscillations of the electron gas under the action of emf induced by external radiation. As a result the background level in the d^2V/dI^2 curve recorded at microwave frequency should decrease. With further frequency increase to the level comparable with the frequency of electron-phonon interaction (in this case the energy quantum of radiation is comparable to the phonon energies) the processes in the contact should

be considered in terms of corpuscular theory as the absorption and emission of phonons under the action of radiation quanta. As a result of it further increase of frequency will cause smearing of d^2V/dI^2 phonon spectral features and the appearance of satellites at higher frequencies.

When passing to the thermal regime, the nonlinearity of point-contact conduction is connected with the effect of heating. In this case the characteristic time is determined by thermal relaxation processes in the contact. It depends on the contact size d , specific heat capacity c , heat conduction of material λ and can be evaluated by the formula $\tau = cd^2/\lambda$. At characteristic size of contact 10^{-8} m, heat capacity and heat conductivity of metals the value of τ is about 10^{-9} s. Therefore, in the frequency range 10^9 Hz and higher the d^2V/dI^2 curve should change its form as compared with that obtained at low frequencies. This is caused by the fact that at the frequencies above those of thermal relaxation the contact temperature no longer traces the modulating high-frequency current. As a result the possibilities of temperatures modulation spectroscopy described in Chapter 13 are limited by the above frequency.

Thus, the study of contact conductivity at high frequencies makes it possible to clear out the nature of various non-stationary processes in metals, to determine the time of phonon-electron collision, to elucidate the quantum limit effect in detecting for the ballistic regime. In the thermal regime it enable the investigation of thermal relaxation processes in small-size conductor.

16 Study of PCs on semimetals and semiconductors

The distinctive features of substances relating to semimetal and semiconductor is, first of all, low concentration of charge carriers as compared with common metal. Thus, in typical semimetals, bismuth, antimony and arsenic, it changes from 3×10^{17} (Bi) to 2×10^{20} (As) per 1 cm^3 , whereas in metals it is $10^{22} - 10^{23}$. In semiconductors these value can be still lower by several orders of magnitudes.

Accordingly, the Fermi energy decreases from several electron-volts in metals to millielectron-volts in semimetals. Secondly, the effective mass of charge carriers in semimetals, due to the peculiarities of their band structure, can be more than an order of magnitude lower than its value in common conductors. The latter, together with low Fermi energy, causes the increase of the de Broglie wavelength in semimetals up to tens of nanometers, i.e. it becomes comparable with the contact dimensions. Thirdly, small effective mass leads to the fact that the Larmor radius of electron trajectory decreases to hundreds of nanometers already in an easily attainable magnetic field about 1 Tesla. Thus, an interesting situation is created in semimetals when all the above lengths become comparable with the constriction dimension. This leads to the influence of quantum interference effects on the conductivity of contact since due to a large wavelength the quasi-particles can no longer be considered as point ones and their wave properties should be also taken into account. Besides, the magnetic field effect on the charge carrier trajectories in the vicinity of the contact should be appreciable, which will also affect the characteristics being measured. Thus, for example, under the field effect we observed transformation of the electron-phonon interaction spectrum in antimony: the change of intensity, half-width and energy position of maxima depending on the relation between the Larmor radius of carriers and their mfp and contact size.

On the other hand, a number of antimony contact displayed the change of spectrum sign, i.e., d^2V/dI^2 became negative but the extrema due to the electron-phonon interaction were retained. Such contacts were distinguished by small elastic mfp which was of the same order as the de Broglie wavelength. As a result, due to the quantum interference of electron waves, the current carriers are localized and the system conductivity decreases. The electron-phonon interaction processes destroy localization and increase conductivity which corresponds to the decrease of differential resistance and, consequently, to the negative sign of d^2V/dI^2 . This mechanism is most effective at the energies with many phonons, i.e. at the phonon spectrum maxima. Finally, under the localization regime for the above contacts the recorded spectrum shape

will be close to the common one as if turned upside down. As stated above, this interesting effect was observed for contacts made of antimony which provide to be sufficiently convenient and workable material for making shorts.

Let us dwell on the point-contact study of semiconductors where so far only the first steps are made. Note that this problem is much greater tackled theoretically than experimentally where the investigation can be counted on the fingers of one hand. The matter is that the above technology of making PCs between metals is not well suitable for semiconductors. This is due to the much stronger sensitivity of the surface properties of semiconductors to deformation, pressure, imperfect structure, impurities which are always present to some extent when the contact is formed mechanically. Even a perfect surface is a "defect" relative to the bulk material because the boundary atoms on the one hand interact with the like ones, and on the other hand interact with the atoms of the surrounding medium. In this way the surface state appear on the atomically pure surface of the semiconductor whose energy levels lie in the forbidden zone (Tamm or Schottky levels). In real crystals, along with the above levels, the additional ones appear due to the impurities, defects, adsorbed atoms, etc. The density of such levels depends on surface boundary and can vary in wide range. The presence of surface energy levels result in the formation of near-surface layer of the space charge whose thickness is determined by the screening distance r_S ⁷ depending on the carriers concentration. At this time layer with the main carriers concentration other than in the bulk appears on the surface. As a result of it, when mechanically contacting two semiconductors, the point-contact properties will be to large extent determined by the surface layer properties and differ from the bulk ones. To avoid it, the lattices should perfectly coincide during the mechanical contact which hardly probable. For this reason the char-

⁷In conductor, the electron gas screens separate charges whose radius of action is in this case limited by the distance r_S depending on electron concentration as $r_S \sim n^{-1/2}$. In metals the screening distance is only a few decimal fractions of Å, while in semiconductors it can reach tens and hundreds of Å.

acteristics of semiconductor PCs strongly vary from contact to contact and are poorly reproducible, thus impeding the studies. Nevertheless, attempts to advance in this direction are continued. Thus, technique of creating micro-constrictions has been implemented in semiconductor heterocontacts. Two-dimensional micro-constrictions less than one micron in size have been obtained by electron-beam lithography.

17 Spectroscopy of superconductor

So far we considered the current-voltage characteristics of contacts formed by normal metals. However, at low temperatures many metals and alloys become superconducting. It should be noted that researchers began to study contacts between two superconductors long before the advent of point-contact spectroscopy. To tell the truth, the scientists were more interested in the properties of superconducting condensate formed by Cooper pairs. To break pair, it should be given some energy equal to or greater than the energy gap ⁸ in the electron density of states equal not more than several millielectron-volts. The current-voltage characteristics of superconducting contacts first of all reveal the features connected with the presence of the energy gap. Such features were studied by many experiments in all simple superconducting metals.

A question arises whether the phonon features will show up in the second derivatives of current-voltage characteristics of superconducting contacts, i.e. whether the point-contact spectroscopy of superconducting state is possible. The answer proved to be positive. For simple superconducting metals (Pb, Sn) it was demonstrated that the point-contact spectra taken below the temperature of superconducting

transition T_c displayed the features associated with the electron-phonon interaction. At this time the form of the spectrum practically coincide with similar dependence for the same contacts in the normal state. Only at the energies low compared with the Debye one there appear sharp features due to the energy gap manifestation. But they do not greatly distort the electron-phonon interaction spectrum since the phonons are located at higher energies.

At the first sight it seems that point-contact spectroscopy in the superconducting state yield no new information. However, not all the metals, especially alloys and compounds with high critical parameters: superconducting transition temperature, critical magnetic field, can be studied at low temperatures in the normal state. Therefore, the principal possibility of the point-contact spectroscopy application for investigation the superconductors considerably extends its scope of use to the study of the high-temperature superconductors.

It is noteworthy that the point-contact spectroscopy of superconductors has offered new opportunities. It turned out that in some metals and alloys whose point-contact spectra in the normal state do not display any spectral features due to the short electron mfp, in the superconducting state there appear peaks arranged in the region of characteristic phonon frequencies. This was found out experimentally when measuring contacts of Nb, Ta, Nb₃Sn, NbSe₂. The nature of these features is somewhat different from that in the ballistic contact. They are connected with the influence of nonequilibrium phonons generated by electrons on the superconducting properties of metal near the constriction. The phonons with small group velocities more slowly emerge from the contact vicinity, cause local overheating and decrease of the energy gap. Therefore, at these energies features will appear in the current-voltage characteristics derivative. This makes it possible to carry out the spectroscopy of "slow" phonons which correspond to the flattening of dispersion curves where $d\varepsilon/dq$ tends to zero (see Fig. 2a).

⁸In common superconductors the electrons interact via phonon and form the so-called Cooper pairs which ensure a non-dissipative charge transfer. As the pairs are Bose-particles with the spin equal to zero, they are all "condensed" at Fermi level. The energy required for breaking a pair is equal to the energy gap arising in the electron density of states in superconductor at the Fermi level. The energy gap value, as well as those of critical temperature and other parameters, is one of the most important superconductor characteristics.

18 New trends of research

In the preceding chapters we discussed the possibilities of point-contact spectroscopy when studying mainly simple metals and some alloys. It was shown that this technique makes it possible to obtain detailed (spectroscopic) information on the mechanisms of electron scattering in conductor. At the same time the recent advances of solid-state physics are associated with the synthesis and study of new classes of compounds. These include the heavy-fermion and mixed-valence systems, so-called Kondo lattices, new high-temperature superconductors and many others. Naturally, the most promising trends in point-contact spectroscopy are also connected with their study.

The substances in question are noted for the fact that the conventional band scheme proceeding from the concept of free electrons in the conduction band and the localized nearly atomic states of lower-lying shells is not suitable for their description. In these substances the inner shells near the Fermi level lose their stability and their electrons acquire a partially band character. As a result the electron density of states strongly increases and can have a sharp maximum near the Fermi level. In a number of cases the presence of such narrow maximum in Kondo lattices is attributed to many-particle Abrikosov-Suhl resonance caused by the interaction between localized f- or d-electrons and conducting electrons. A high increase of the electron density of states corresponds to the appearance of electrons with a larger effective mass. In simple terms, these conduction electrons are not fully "untied" from the atoms and their field-effect motion is more hindered. The presence of such electrons stipulates the unusual properties of these materials.

Theoretical treatment of the kinetic properties of such substances is based on taking into account their electronic spectrum peculiarities near the Fermi level. It is impeded by the absence of direct experimental data on the electron density of states in a narrow layer on the Fermi surface. The scientists were tempted by the idea to use PC for recording the energy spectra not only of phonons but also of electrons.

A number of research groups abroad are investigating the compounds with heavy fermions and interme-

diante valence in heterocontact with normal metal. It was discovered that for the substances with a maximum electron density of states $N(\varepsilon)$ near the Fermi energy ε_F the point-contact differential resistance $R_D(V)$ curve has deep minimum at $V = 0$. At the same time, a sharp maximum of R_D at $V = 0$ appears in the substances with a low density of states or with gap, i.e. $N(\varepsilon) = 0$ at $\varepsilon_F - \Delta < \varepsilon < \varepsilon_F + \Delta$ where 2Δ is the gap width. It also appeared that the widths of $R_D(V)$ maxima or minima is close to the assumed widths of $N(\varepsilon)$ features. This suggested the possibility of registering the $N(\varepsilon)$ features near the Fermi level in such substances using the point-contact spectroscopy. However, not everything is so simple in this problem. Firstly, the electron mfp in the systems under consideration are small enough and one should take into account the thermal effects occurring in PCs. Secondly, there is not microscopic theory that allows for the effect of electronic spectrum peculiarities on the point-contact kinetic phenomena. The experiments carried out by other groups showed, however, that the thermal regime is realized in the contacts of such materials and that the main non-linearity of the current-voltage characteristics is determined by the temperature-dependent part of substance resistance. Thus, for example, the $R_D(V)$ behavior for contacts made of number of heavy-fermion compounds, such as CeCu_2Si_2 , UPt_3 , UBe_{13} and others, precisely duplicates the $\rho(T)$ dependence in bulk material. Thus, the relation of V and T in a contact, typical on the thermal regime, is evident. Besides, it was shown that one should be very careful when treating the result obtained on heterocontacts⁹ between a normal metal and specific substances, for here one should also successively take into account the thermoelectrical effects considered in Chapter 13.

There is probably only one convincing example of how the authors managed to obtain well-defined spectral features in the point-contact spectra of intermediate-valence compound CeNi_5 . Such substances contain rare-earth atoms with partially filled 4f shell and +3 valence. Since the ion states with

⁹This experimental geometry is often used since the above compounds are frequently rather small samples and cannot be adequately shaped, so it is simple to make a needle of another material.

filled or empty shell are most stable, the state Ce^{3+} will compete with the state Ce^{4+} when the f-shell in cerium is empty. Thus, the Ce^{3+} ions in the compound $CeNi_5$ can also exist in the Ce^{4+} state, giving out the excess electron. As a result, there is constant competition between these two state, Ce^{3+} and Ce^{4+} , so the valence of Ce ions is between 3 and 4 is called intermediate. There exists a model according to which the energy levels of the Ce^{3+} and Ce^{4+} states are arranged near the Fermi level but on the opposite sides, thus increasing the density of state at the corresponding energies. The electrons take part in the transitions between these states or levels with difference valence. These transitions affect the conductivity of substance and should be observed on the point-contact spectra. Actually, among with the phonon features, the d^2V/dI^2 curves of $CeNi_5$ contacts reveal small maxima in the low energy region. These maxima can be related with scattering by different-valence configuration of the Ce ion. In this case the d^2V/dI^2 curve of $CeNi_5$ -normal metal heterocontact displays a large asymmetry of features in question depending on the voltage polarity. In terms of the model under consideration, this is attributed to the resonance scattering by different-valence state of the Ce ion with allowance for the specific form of the electron distribution function in PC (see Fig. 5b).

On the other hand, there is an alternative approach to the explanation of mentioned features observed in the PC spectra of $CeNi_5$. This approach is connected with taking into account strong spin correlations in this compound. Their important role was indicated by the low temperature behavior of $CeNi_5$ resistance proportional to T^2 attributed to the scattering by spin fluctuation or paramagnons. The latter should lead to the linear dependence of the initial d^2V/dI^2 section that was observed on all curves in the absence of negative "zero-bias" anomaly, which, as noted in Chapter 7, indicates low quality of contacts.

As to the d^2V/dI^2 asymmetry in heterocontacts based on $CeNi_5$, the detailed study on single crystals has demonstrated its greater relation to the thermoelectric effects. This evidence by the fact that the asymmetry corresponds to the thermoemf sign in $CeNi_5$ and its value for the two principal directions correlates with that of the Seebeck coefficient. Thus,

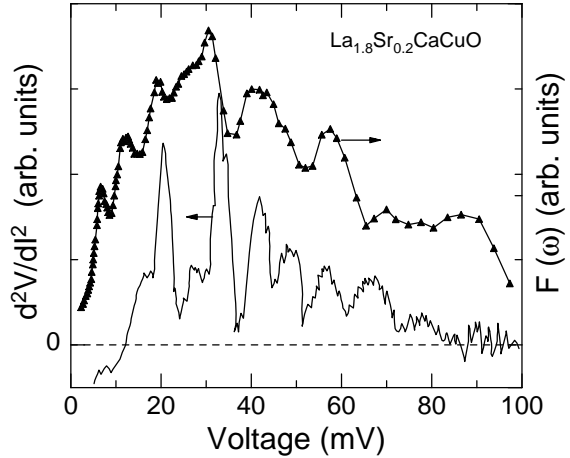

Figure 15: Point-contact spectrum of high-temperature superconductor $La_{1.8}Sr_{0.2}CuO_4$ (solid curve). A number of narrow spectral lines and the spectrum boundary near 80 mV are well defined. The initial spectral part up to 10 mV contain powerful bursts due to the manifestation of the superconductor energy gap not shown in the figure. Neutron phonon density of states (symbols) is shown for comparison.

further investigation of $CeNi_5$ by means of PC will enable better understanding of these interesting systems.

Nevertheless, it should be noted that the discussed possibility of refining the band structure of the compounds under consideration by means of point-contact spectroscopy is of interest due to a high resolution about 1 meV. The traditional X-ray or photoelectron techniques used for the study of band structure operate in significant larger energy scales with resolution not higher than hundreds of millielectronvolts.

The point-contact technique did not stand of the events associated with the discovery of high-temperature superconductors. One of the first compounds of this kind, $La_{1.8}Sr_{0.2}CuO_4$ was studied by means of point-contact spectroscopy. It was rather simple to obtain the point-contact spectrum of phonons (Fig. 15). It was found that it extends up to the energies of about 80 meV and comprises six

sharp peaks corresponding to the phonons with the small group velocities. The electron-phonon interaction estimated by the relative differential resistance increase of PC when the energy rises to ε_D has shown this interaction to be almost the order of magnitude stronger than in common superconductors. Consequently, the superconductivity in the compound in question is more than likely due to the electron-phonon interaction. On the other hand, the analysis of current-voltage characteristics of contact from such superconductors below the critical temperature enables the determination of their energy gap. The information obtained thereat relates to the substance region with the size about the contact diameter directly adjacent to the constriction. This makes it possible to investigate the properties of separate superconducting clusters whose sizes measure only hundreds Å. The knowledge of the contact dimensions enable us to estimate the critical current densities. It turned out that this density reaches 10^8 A/cm^2 in the superconducting clusters investigated by the point-contact spectroscopy, whereas in the bulk sample the critical current density does not exceed 10^3 A/cm^2 . Apparently, the latter fact points to the presence of weak contacts between superconducting granules in such systems. Therefore, PC can be also used as an efficient probe which enables the study of cluster and other polyphase compounds.

It is necessary to note the even growing interest to the study of heterocontacts including those between pure metals. It is clear that the point-contact spectrum of heterocontact between different metals should contain the peculiarities due to one and another electrodes, i.e. as a result the d^2V/dI^2 dependence can be presented as a sum of spectrum from each materials. Such experiments were made soon after obtaining first point-contact spectra. The researchers observed the change the partial contribution into the spectrum from one or another substance for various contacts with different resistances. This was attributed to the fact that the point-contact vicinity can be at random mostly filled with one or another metal. However, theoretical works in this field have demonstrated that the heterocontacts have their own physics. Firstly the intensities of one or another metal spectra in the heterocontacts are in-

versely proportional to the Fermi velocity, i.e. in other words, to the time of electrons transit or interaction in the contact. Secondly, the effects of electron trajectories reflection or refraction appear in the heterocontact (due to the different electron momenta) as is the case when the light passes through the boundary between two media. As a result, as shown by the estimates, it can lead to a considerable change in the metal spectrum both in intensity and shape. The detailed comparison of theoretical calculations with experiments on heterocontacts yields information on the electron scattering at the metals interface.

Besides, the heterocontacts develop a whole number of other interesting effects connected with the observation of spectrum asymmetry¹⁰ depending on the applied voltage polarity. One of such effects detected recently is related to the electron drag in the contact by the nonequilibrium phonons which enable the study of their relaxation processes with the aid of PCs.

19 Conclusion

(Note, it was written 15 years ago.)

The above examples explain the achievements and prospects of the development of point-contact spectroscopy for the study of the electron and phonon system kinetics which determines the main electrical properties of conductors. This technique is becoming a powerful and efficient tool for the study of highly nonequilibrium phenomena in conductors, especially those with limited space dimensions. The latter is of interest for modern microelectronics where the dimensions of separate components are already below the micron range.

Note that the point-contact measurements are also helpful in all the case when one deals with constrictions of different types. Thus, they enable obtaining information on the state of metal in the regions of current concentrations, mean free paths, contact dimensions, etc., i.e. to have some "rated" characteristics of contact, the knowledge of what researcher or engineer is dealing with.

¹⁰In this case the asymmetry is not connected with the thermal emf since the contacts are in the ballistic regime.

The best evidence of the efficiency and importance of work carried out in this field is the wide geography of point-contact spectroscopy research. Thus, in the USSR both the experimental and theoretical studies are extensively carried out at the Institute for Low Temperature Physics and Engineering of the Ukrainian Academy of Sciences, which takes the leading place in the world in this respect. This is the birthplace of the point-contact technique where further fruitful research is under way.

Experimental groups of "point-contact" physicists successfully work in the Kurchatov Institute of Atomic Energy and the Institute of Solid-State Physics of USSR Academy of Sciences. Their principal interests is connected with transition metals and alloys on their base. There are also groups of the theorists dealing with the calculation of the point-contact spectra.

A number of important results have been obtained by Dutch scientists from the University of Nijmegen who, in particular, proposed the "needle-anvil" technique. Now this group has moved to Grenoble, to the Laboratory of High Magnetic fields in the Institute of Solid-State Physics of the Max-Planck Society. The principal attention here is paid to the study of PCs on the base of compounds with rare-earth ions and their behavior in high magnetic fields. The researchers of the University of Cologne (Germany) use PCs for the investigation of heavy-fermion compounds, Kondo lattices and mixed-valence systems. The group from the Higher Technical School (ETH) in Zürich (Swiss) works in the same direction.

The physicists in the USA and Canada are actively working on the theory of point-contact spectroscopy and calculation of point-contact spectra of simple metals. Experimental study of PCs from some semiconductors and pure rare-earth metals are carried out in the Cavendish laboratory in Cambridge (England). At the Institute of Experimental Physics in Kosice (Czecho-Slovakia) scientists are successfully developing various trends in point-contact spectroscopy in close collaboration with the researchers from the Institute for Low Temperature Physics and Engineering of the UkrSSR Academy of Sciences. Recently, the scientists of Japan joined in the point-contact studies. The group in Tokyo and Sendai are engaged

in the point-contact spectroscopy of Kondo lattices. There are number of other places where scientists are not only interested in these technique but are trying to use it. Within the last 15 years of its development, the point-contact spectroscopy, together with the other spectroscopic techniques, has become inseparable part of physical research. More than two hundreds papers on this subject have been already published in the leading physical journals all over the world. The papers devoted to point-contact spectroscopy are presented at practically all conferences dealing with the electronic properties of solid. It is hardly too much to say that the point-contact spectroscopy method has been adopted by physicists all over the world.

Literature

Holm R., Electric contacts handbook. M., Foreign Literature Publishers, 1961 (in Russian).

Kaganov M.I., Electrons, phonons, magnons. M., Nauka, 1979 (in Russian).

Khotkevich A. V. and Yanson I. K., *Atlas of Point Contact Spectra of Electron-Phonon Interaction in Metals*, Kluwer Academic Publisher, Boston, 1995.

Kittel C., *Introduction to Solid State Physics* by John Wiley & Sons, Inc., 1971.

Verkin B.I., Point-contact spectroscopy of metals and alloys, Priroda, No. 10, 1983 (in Russian).

Topical reviews (added)

Duif A., Jansen A. G. M. and Wyder P., J. Phys.: Condens. Matter **1** 3157 (1989).

Jansen A. G. M., van Gelder A. P. and Wyder P., J. Phys. C **13** 6073 (1980).

Naidyuk Yu. G. and Yanson I. K., J. Phys.: Condens. Matter **10** 8905 (1998).

Yanson I. K., Sov. J. Low Temp. Phys. **9** 343 (1983).

Yanson I. K., Sov. J. Low Temp. Phys. **17** 143 (1991).

Yanson I. K. and Shklyarevskii O. I., Sov. J. Low Temp. Phys. **12** 509 (1986).

ФИЗИКА

ПОДПИСНАЯ НАУЧНО-ПОПУЛЯРНАЯ СЕРИЯ



1989/12

Ю. Г. Найдюк

И. К. Янсон

МИКРОКОНТАКТНАЯ СПЕКТРОСКОПИЯ



ЗНАНИЕ

НОВОЕ В ЖИЗНИ, НАУКЕ, ТЕХНИКЕ

Figure 16: Original brochure cover.