

Quantum-state transfer on spin-chain channels with random imperfections

De-Xin Kong¹ and An Min Wang^{1,*}

¹Department of modern physics, University of Science and Technology of China, HeFei, 230026,P.R.China

Abstract

We investigate the quantum-state transfer on spin-chain channels with random imperfections. Through combining the advantages of two known schemes, the dual-rail spin-chain channels[9] and the particular inhomogeneous spin-chain channel[10], we propose a protocol that can avoid the quantum noises introduced by many unnecessary measurements and can enhance the anti-decoherence ability. The results show that our protocol is more efficient to transfer an arbitrary quantum state than the original one. In particular, we discuss the effects of couplings fluctuations and imperfect initialization on both of the improved scheme and original one.

PACS numbers: 03.67.Hk, 05.50.+q, 05.60.Gg, 73.21.Hb

*Electronic address: anmwang@ustc.edu.cn

I. INTRODUCTION

The quantum states transfer from one location to another is necessary in many quantum information processing systems. Therefore, a number of technologies have been developed to accomplish this task. One of the most developed systems is optical system, which is employed to transfers quantum states directly via photons. For example, photons in cavity[2] and in ion traps[3] were used as a variety of information carriers to transfer quantum states from site to site. And also photons could be used to create entanglement between two sites for further teleportation[1]. Even though these optical technologies are very efficient in transferring quantum states through long distance, employing them to transfer quantum states through short distance within a quantum computer or quantum information processing system, may cause some very upsetting interfacing problems (between optical carrier and solid state matter) for engineering the quantum information processing system. However, quantum communication among different parts (the processor and the memory) of a quantum computer is always necessary[4]. The following types of quantum channels are developed to accomplish the task of quantum communication among different parts of a quantum computer.

In principle, both a series of swap gates and the spin chain[5] can be employed to transfer quantum states. However, it is impractical to use a series of swap gates as the quantum channel in reality. In Ref.[5], Sougato Bose suggested that one can use a wire of spins interacting equally with their nearest neighbors as quantum channels to transfer quantum states and entanglement under the free evolution, but this scheme can not transfer quantum states perfectly, and the fidelity of transferring states would decrease with the length of a spin chain. However, In our opinion, the advantages of using the spin chain as quantum channel make this protocol still be a promising technology. These advantages are: avoiding interfacing problems and extremely decreasing external control in the process of transferring states. Because of the above two features, a series of inhomogenous spin chains[6, 7] with engineering coupling constants which can transfer quantum states perfectly, were developed. Although these inhomogenous spin chains can transfer quantum states perfectly, engineering them in experiment is very difficult.

Several other methods have been developed to improve the transfer fidelity of spin-chain channels. Exposing a spin chain system to external modulated magnetic field[8] can also

significantly improve the fidelity of transferring quantum states. In Ref. [13], the authors proposed a protocol that can optimize the fidelity by applying a suitable sequence of two-qubit gates at the receiving end of the chain. This protocol is interesting because the two-qubit gates are simple and can be realized by a simple switchable interaction, but the perfect state transfer requires an infinite number of operations. In addition, parallel spin-chain channels[9] can be used to perform conclusive and arbitrarily perfect quantum-state transfer. Their protocol used only a parallel spin-chain channel composed by two uniform spin chains without interacting with each other, and some local operations and measurements. This scheme is natural and simple, but the high probability of success to perfectly transfer a quantum state definitely implies a large number of measurements and long transferring time, which renders the scheme impractical in experiment, especially for long spin chains—another factor of affecting the efficiency of the protocol. For instance, for $N = 150$ (the number of spins in one of the spin chains), one needs to perform near 30 measurements so that the probability of success can be achieved 90%.

Obviously, because of the limitation of measurement technology, the measurement can generally lead to the departure of resulted states. Here, we call the departure introduced by measurements as quantum noise. In this paper, our aim is to find a way to avoid the quantum noise perhaps introduced by many measurements, but without decreasing the efficiency of quantum-state transfer and losing the scheme's natural and simple feature. Inspired by the work[10] of Antoni Wójcik, et al, who has shown that one can greatly improve the transfer fidelity through the spin-chain channel by modulating the parameter a (the coupling strength of both ends of a spin chain with the other uniform part of the spin chain). Our proposal is to substitute the homogenous spin chains of the original protocol with the spin chains in Ref. [10], and to add some requirements to the original scheme. We also have studied the effects of imperfections caused by couplings fluctuations and imperfect initialization. Another important advantage of this new scheme is that it maintains natural and simple feature.

This paper is organized as follows. In Sec. II, we briefly review the work of [9]. In Sec. III, the improved scheme is studied and advantages of the improved scheme are discussed. In Sec. IV, we mainly study the effects of couplings fluctuations and imperfect initialization to the efficiency of quantum-state transfer and show the improved protocol is more robust to these kinds of imperfections than the original one. Conclusions and discussions are made

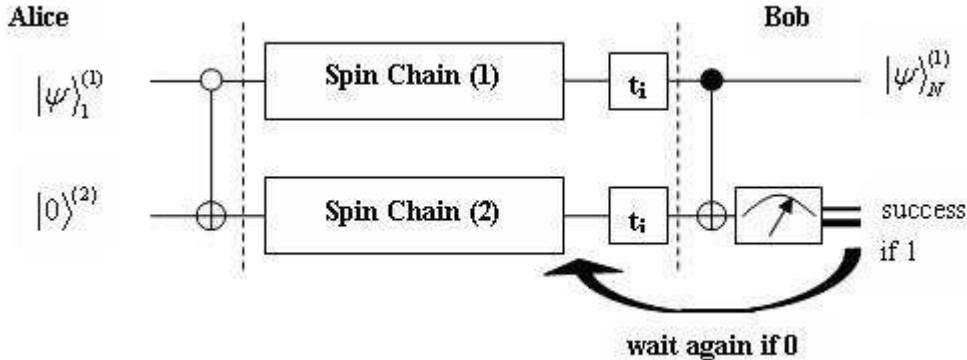

FIG. 1: Quantum circuit of *conclusive* transfer. The first gate at Alice’s qubits represents a NOT gate to the second qubit controlled by the first qubit being zero.

in Sec. V.

II. REVIEW OF THE PREVIOUS WORK[9]

The authors of [9] proposed a protocol for perfect but undetermined quantum communication, which was called *conclusive* transfer, by encoding an arbitrary quantum states into a dural-rail quantum channel composed by two parallel uniform spin chains and by only performing some unitary operations and measurements on the destination of the channel. The schematic figure of the protocol is shown in Fig. 1[9]. The Hamiltonian of the suggested system is

$$H = H^{(1)} \otimes I^{(2)} + I^{(1)} \otimes H^{(2)}, \quad (2.1)$$

where the superscripts (1) and (2) represent the spin chain (1) and (2), respectively, and $H^{(1)}$ and $H^{(2)}$ are the identical Hamiltonians of Heisenberg spin- $\frac{1}{2}$ -chain with equal nearest-neighbor couplings of the spin chain (1) and the spin chain (2)

$$H^{(1)} = H^{(2)} = H_U = -J \sum_{n=1}^N \boldsymbol{\sigma}_n \cdot \boldsymbol{\sigma}_{n+1}, \quad (2.2)$$

respectively. The scheme for conclusive transfer is:

1. *Initialization of the system.* each chain is cooled down to its ground state, by ground state of the Heisenberg ferromagnetic chain we mean that all qubits of the chain are downward representing by $|\mathbf{0}\rangle \equiv |0_1 \dots 0_N\rangle$.

2. *Encoding the quantum state.* the first qubit of spin chain (1) is prepared to be

$$|\psi\rangle^{(1)} \equiv \alpha|\mathbf{0}\rangle + \beta|\mathbf{1}\rangle,$$

where $|\mathbf{n}\rangle$ means that n th qubit is spin-up while all other qubits of a spin chain are spin-down. The first qubit of spin chain (2) is in state $|\psi\rangle^{(2)} = |\mathbf{0}\rangle$. Then Alice applies a NOT gate to the first qubit of the spin chain (2) controlled by the first qubit of the spin chain (1) being zero. The state of the system after the encoding process becomes

$$|\psi(0)\rangle = \alpha|\mathbf{0}\rangle^{(1)} \otimes |\mathbf{1}\rangle^{(2)} + \beta|\mathbf{1}\rangle^{(1)} \otimes |\mathbf{0}\rangle^{(2)}.$$

3. *Free evolution and measurements.* The system encoded with the quantum state evolves freely under the Hamiltonian of (2.1). After the time τ_1 , the state can be written as

$$|\psi(\tau_1)\rangle = \sum_{n=1}^N f_{n,1}(\tau_1)|s(n)\rangle,$$

where $|s(n)\rangle = \alpha|\mathbf{0}\rangle^{(1)} \otimes |\mathbf{n}\rangle^{(2)} + \beta|\mathbf{n}\rangle^{(1)} \otimes |\mathbf{0}\rangle^{(2)}$ and $f_{n,1} \equiv \langle \mathbf{n} | e^{-iH_U t} | \mathbf{1} \rangle$. Then Bob can decode the qubit by applying a C-NOT gate on the N th site of the dual-rail quantum channels controlled by the N th qubit of the spin chain (1). The state thereafter will be

$$|\phi(\tau_1)\rangle = \sum_{n=1}^{N-1} f_{n,1}(\tau_1)|s(n)\rangle + f_{N,1}(\tau_1)|\psi_N^{(1)}\rangle \otimes |\mathbf{N}\rangle^{(2)}, \quad (2.3)$$

where $|\psi_N^{(1)}\rangle \equiv \alpha|\mathbf{0}\rangle^{(1)} + \beta|\mathbf{N}\rangle^{(1)}$. The authors' point is that Bob can justify whether the quantum state $|\psi(0)\rangle$ encoded in the spin chain (1) has been transferred to the N th site qubit of the spin chain (1) by applying a measurement on the N th site qubit of the spin chain (2), if the result of the measurement is “1”, Bob would know that the state $|\psi(0)\rangle$ has been successfully transferred and then terminate the transferring process, if the result is “0”, Bob can conclude that the state $|\psi(0)\rangle$ has not yet been transferred to the N th site. The result “0” does not imply a failure and end of the process of transfer, because, according to the authors' thought, Bob can perform another similar operations on the spin chain (2) after some time τ_2 , since the result “0” of the first measurement did not provide any information about the state $|\psi(0)\rangle$, and therefore, $|\psi(0)\rangle$ is still residing in the spin chain (1). If the outcome is “0” again, Bob can repeat the procedure again and again until the outcome “1” is attained. The

probability of success with only one measurement is $|f_{N,1}(\tau_1)|^2$. It has been proved [9] that the probability of success for perfect state transfer increases with the number of measurements for the uniform Heisenberg spin chain, but can never achieve one.

The protocol is interesting, for perfect state transfer can also be realized by using uniform spin chains which can not perfectly transfer quantum states when $N \geq 4$ [6]. However, to achieve reasonable probability of success for perfect states transfer, this protocol calls for a large number of measurements which also related to the length of the channel, therefore the increase of the length of the channel and of the probability of success would cause the number of measurements and C-NOT operations to increase rapidly. As we all know, the external operations and measurements would definitely cause quantum noises and decoherences, therefore any protocol involved with so many measurements and external operations has little significance in reality. Furthermore, the large number of measurements and operations would take large amount of time, which has no benefits to complete quantum information task.

To avoid these disadvantages of the original dual-rail protocol, we proposed an improved scheme. We will discuss the improved protocol in details in subsequent sections.

III. THE IMPROVED PROTOCOL

One way to avoid the quantum noise introduced by unnecessary operations is to increase the probability of success of the first several measurements, so that the number of operations can decrease significantly. According to the discussion above, after only one measurement, the probability of success for perfect transfer is directly determined by $|f_{N,1}|$, so the efficiency of the original protocol can be improved by increasing $|f_{N,1}|$. A special and simple spin- $\frac{1}{2}$ chain of Heisenberg XY model was proposed and studied in Ref. [10], in which the authors showed that one can significantly increase $|f_{N,1}|$ by adjusting the parameter a . The Hamiltonian of the spin chain studied in [10] is

$$H_{\text{inh}} = \frac{a}{2}(\sigma_1^x \sigma_2^x + \sigma_1^y \sigma_2^y + \sigma_{N-1}^x \sigma_N^x + \sigma_{N-1}^y \sigma_N^y) + \frac{J}{2} \sum_{n=2}^{N-2} (\sigma_n^x \sigma_{n+1}^x + \sigma_n^y \sigma_{n+1}^y) + \sum_{n=1}^N \omega \sigma_n^z, \quad (3.1)$$

where a and J are coupling strength and ω is Larmor spin frequency of every site, and σ^i s ($i=x,y,z$) are Pauli matrices. Since $[\sigma_{\text{tot}}, H_{\text{inh}}] = 0$, where $\sigma_{\text{tot}} = \sum_{n=1}^N \sigma_n^z$, the subspace with single excitation is invariant and the term $\sum_{n=1}^N \omega \sigma_n^z$ just contributes global phase in the

evolution of the system. For simplicity, we set $J = 1$ and $\omega = 0$. Since we find that the transferring fidelity can not be improved when $a > J$, we just set $0 < a < 1$. In the subspace of single excitation, the eigenvalue[10] of H_{inh} is $\Lambda_k = 2 \cos(k)$, where k is a solution of either of the two following equations ($\mu = \pm 1$)

$$\mu \cot(k) \cot^\mu \left(\frac{N-1}{2} k \right) = \frac{a^2}{2-a^2}.$$

The eigenvector $|v^k\rangle$ corresponding to the eigenvalue $2 \cos(k)$ has the following components:

$$\begin{aligned} v_1^k &= \frac{a}{c} \sin(k), \\ v_i^k &= \frac{1}{c} \left\{ \sin[(i+1)k] + (1-a^2) \sin[(i-1)k] \right\} \quad 1 < i < N, \\ v_N^k &= \mu \frac{a}{c} \sin(k), \end{aligned}$$

where the normalization factor c reads

$$c^2 = (N-1) \left(2(1-a^2) \cos^2(k) + \frac{a^4}{2} \right) + 2a^2 - a^4.$$

To increase the value of $|f_{N,1}|$, we substitute the uniform spin chains with the spin chains in Ref.[10], thus the expression of new $f_{N,1}$ is $\langle \mathbf{N} | e^{-iH_{\text{inh}}t} | \mathbf{1} \rangle$, which we denote as $f'_{N,1}$.

Even though the form of analytical solutions of H_{inh} was given in Ref. [10], it is really hard to analytically write out the solutions for large N . To show how the probability of N th site qubit in spin-up state, $P_N = |f'_{N,1}|^2 = |\langle \mathbf{N} | e^{-iH_{\text{inh}}t} | \mathbf{1} \rangle|^2$, is determined by parameters of a and t , we set $N = 5$, for which the analytical expression of P_N can be easily handled and analyzed.

$$P_{N=5} = \frac{1}{4} \frac{\left(\cos(at)a^2 + 2 \cos(at) - a^2 \cos\left(t(a^2+2)^{\frac{1}{2}}\right) - 2 \right)^2}{(a^2+2)^2}.$$

In the function of P_N , the terms “ $(\cos(at)a^2 + 2 \cos(at))$ ” and “ $a^2 \cos(t(a^2+2)^{\frac{1}{2}})$ ” will compete with each other, which causes that the value of P_N would oscillate with the change of values of a and t . In Fig.2, we can see the oscillations. In Ref. [10], the authors showed that this kind of oscillations always exist for other values of N , so the value of P_N can be improved by adjusting the parameter a . The reason [10] for the oscillations is that the change of the parameter a will vary the distribution of the eigenvectors, consequently, can influence the process of state transfer.

With this in mind, our changes on the original protocol [9] will state as follows:

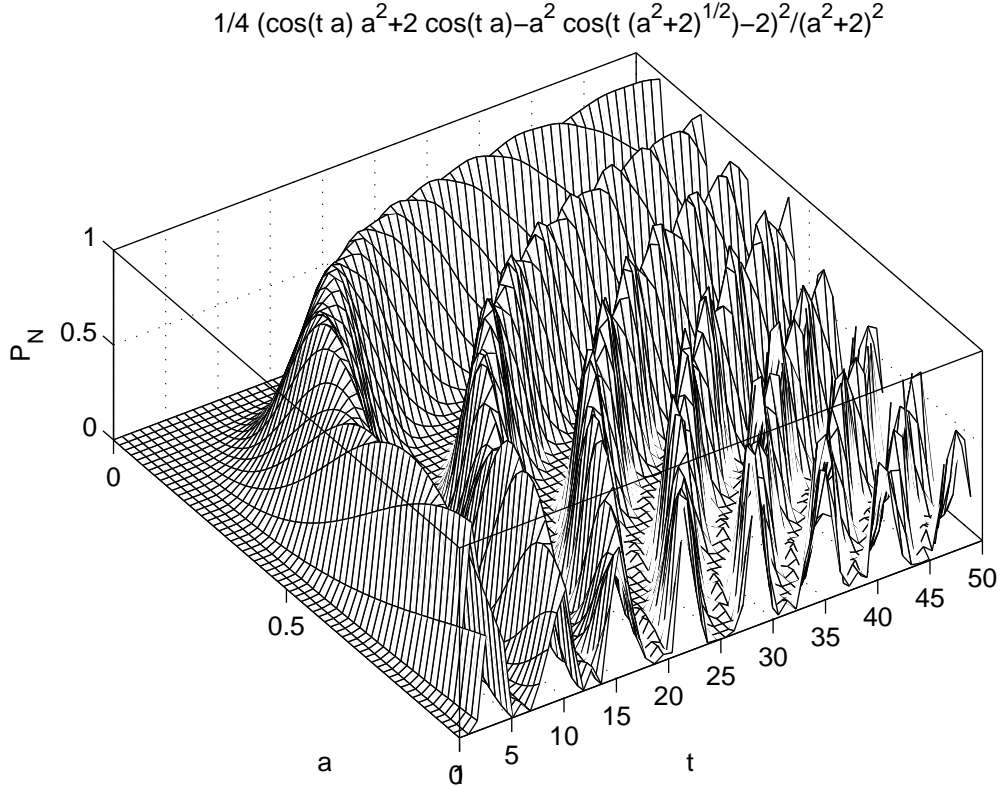

FIG. 2: P_N as a function of parameters a and t for $N = 5$.

1. *Substitution.* Substitute the uniform spin chains in original protocol with the spin chains in Ref.[10]. Then the dural-rail quantum channel is composed by two identical inhomogenous spin chains in Ref.[10] uncoupled with each other.
2. *Adjusting the parameter a .* To make the improved quantum channel be the most efficient, one should choose the specific values of a , which relate with the length of the channel.
3. *Only two measurements allowed.* To decrease or limit the quantum noises introduced by measurements, only two measurements are allowed. We will show that two measurements are sufficient to make the probability of success for perfect transfer to achieve more than 90%, and that the negative effects of extra measurements always outweigh the benefits of them, so if after the result of the second measurement still shows failure of the state transfer, one should cease the process of transferring and initialize the system to restart again.

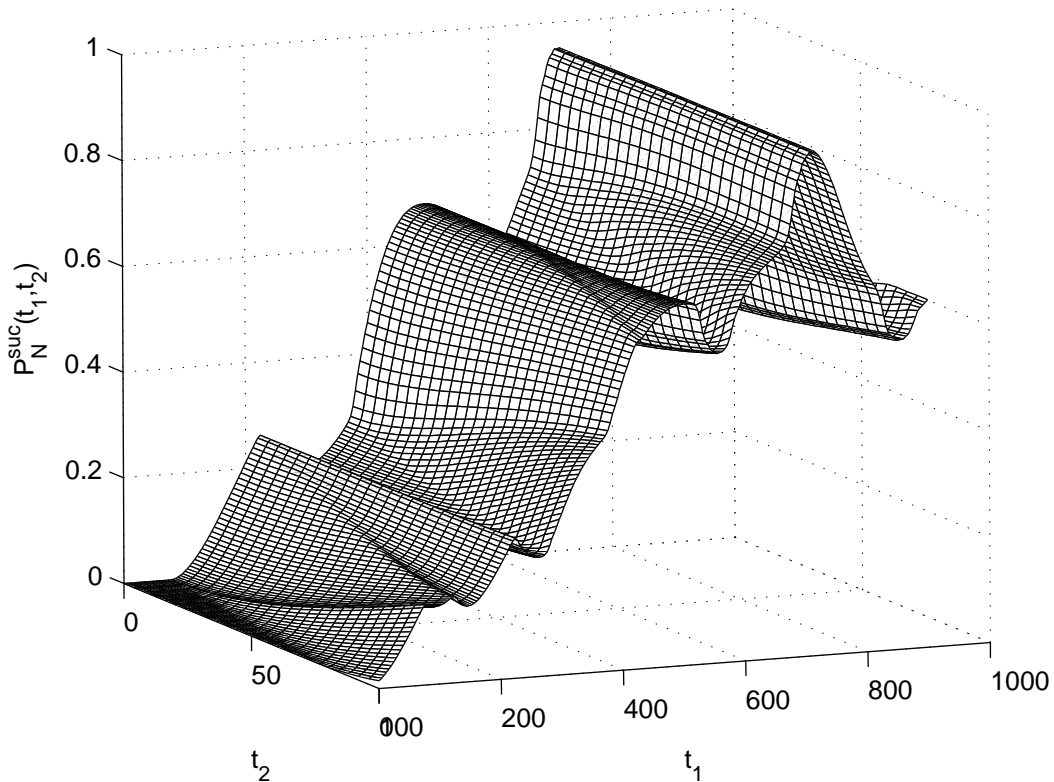

FIG. 3: The dependence of the joint probability of success, $P_N^{suc}(t_1, t_2)$, on the parameters t_1 and t_2 is plotted for $N = 150$ and the parameter of a is set to be 0.05 . The scales of t_1 and t_2 are $[0 \ 900] [\frac{\hbar}{\gamma}]$ and $[0 \ 100] [\frac{\hbar}{\gamma}]$, respectively.

In the following, we will show the dependence of the joint probability of success $P_N^{suc}(t_1, t_2)$ on the values of t_1 and t_2 , where t_1 is the time performing the first measurement, and t_2 is the time interval between the first measurement and the second one. After straightforward calculation, one can get

$$P_N^{suc}(t_1, t_2) = |f'_{N,1}(t_1)|^2 + |f'_{N,1}(t_1 + t_2) - f'_{N,N}(t_2)f'_{N,1}(t_1)|^2, \quad (3.2)$$

where $P_N^{suc}(t_1, t_2)$ is the joint probability of success. In Fig.3, we plotted the the joint probability of success $P_N^{suc}(t_1, t_2)$ as a function of t_1 and t_2 for $N = 150$ and $a = 0.05$. In Fig. 3, one would find that $P_N^{suc}(t_1, t_2)$ is mainly determined by t_1 . This is because that the contribution of the first term in Eq. 3.2 to the probability of success is extremely greater than that of the second term in Eq. 3.2. Since we want to minimize the time of transferring process and maximize the $P_N^{suc}(t_1, t_2)$, in turn, the probability of success for the first measurement

TABLE I: The special cases which we are interested in, for $N = 150, 200, 250, 300$, are listed in this table. The time scales of t_1 and t_2 we consider are $[0 \ 900] [\frac{\hbar}{J}]$ and $[0 \ 100] [\frac{\hbar}{J}]$, respectively. The dimension of time is $[\frac{\hbar}{J}]$, where J is the coupling constant. If J were taken to be $20K \times k_B$, the dimension of time would be 10^{-4}ns .

N	150					200			250			300	
a	0.05	0.07	0.08	0.14	0.41 ~ 0.49	0.06	0.07	0.4 ~ 0.45	0.05	0.06	0.36 ~ 0.44	0.05	0.36 ~ 0.42
t_1	709	411	395	839	81	548	521	106	705	668	131	821	157
t_2	100	49	24	59	7	73	100	8	100	44	8	88	9
P_N^{suc}	0.95	0.92	0.9	0.87	0.88	0.92	0.88	0.88	0.9	0.91	0.86	0.92	0.86

will be very large. Therefore, the significance of the second measurement will be limited. In Ref.[9], it was proved that the joint probability of failure would decrease with the increase of the number of measurements but be impossible to achieve 0. So we can conclude that the significance of extra measurements will be even limited, and by considering the undesired quantum noises that would be introduced by applying these extra measurements, we only allow two measurements in the improved protocol.

If we choose the values of t_1 and t_2 that can maximize $P_N^{suc}(t_1, t_2)$, the maximum of the joint probability of success, denoted by P_{max} , will be a function of N and a . To study the dependence of P_{max} on N , we fix the parameter a . As an example, we set $a = 0.05$. In Fig. 4, we plot the relationship between P_{max} and N for $a = 0.05$. From Fig. 4, we can see that the maximum of joint probability of success, P_{max} dose not monotonously decrease with N but oscillationally decrease with N , and that it is not sensitive to the variation of N . Even though P_{max} can not achieve 90% for some particular N , such as $N = 200$, one can make P_{max} achieve 90% by adjusting the parameter a (in Tab. I).

The requirement of no more than two measurements can also make the probability of success for perfect states transfer achieve about 90% and the transferring time less than 0.1ns. For example, when $N = 150$, $a = 0.05$, $t_1 = 709$ and $t_2 = 100$, the $P_N^{suc}(t_1, t_2)$ can achieve more than 95%, while the original protocol will take 1.3ns to achieve 90%. What we are interested in is to find some special values of a , where $P_N^{suc}(t_1, t_2)$ can be maximized for reasonable time scale in experiment. The numerical results of special cases are listed in Tab.I. The numerical results in Tab.I show that even for large N , the joint probability

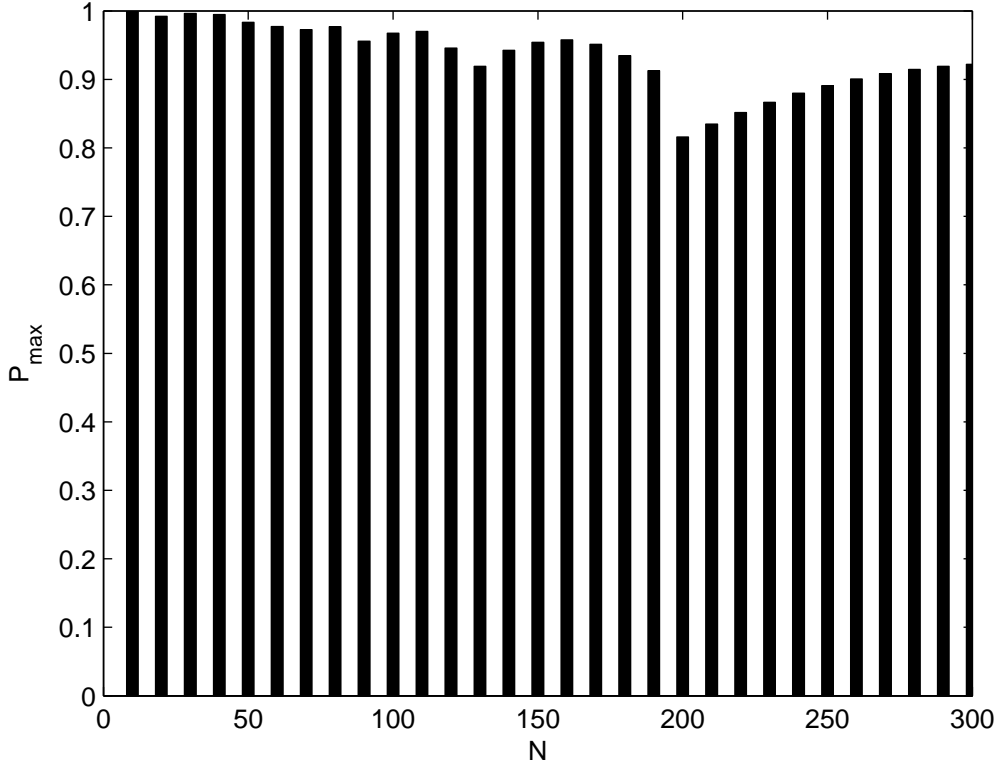

FIG. 4: The dependence of P_{max} on the length of the channel N is plotted. The scales of t_1 and t_2 are $[0\ 900]\ [\frac{\hbar}{7}]$ and $[0\ 100]\ [\frac{\hbar}{7}]$, respectively. The parameter a is fixed on 0.05 .

of success for perfect quantum states transfer can reach about 90% , which is reasonable in experiment. Another fact in Tab. I we want to stress is that when the parameter a is not so small (in the region around 0.4), even though the joint probability of success for perfect transfer is slightly smaller than the case when a is very small (around 0.1), the total transferring time is significantly reduced. This fact can make the improved protocol be adapted to different experimental settings. For example, if the couplings of some system can not be modulated too much, or the decoherence time of other system is very short, the experimental groups can select the specific region they would like to act in. Therefore, the improved protocol can not only improve the efficiency of quantum-state transfer, but also adapt to different experimental settings. Investigating the effects of imperfections is a very important and practical problem, so we discuss this problem in the next section.

IV. THE EFFECTS OF IMPERFECTIONS

Because the improved protocol still use two identical spin chains to form a dual-rail quantum channel, it not only owns all of the advantages of resisting quantum noises, such as decoherences, phase noises and amplitude damping, as discussed in Ref. [9], but is more robust to these quantum noises than the original protocol. Because the total time $t_{tot} = t_1 + t_2$ of the entire transfer process is less than $1000 [\frac{\hbar}{J}]$, which means that the improved protocol only takes less than 0.1ns to transfer an arbitrary quantum state perfectly with a probability of about 90% to succeed. Therefore, the improved protocol can be more robust to these kinds of quantum noises due to the short time it would take to complete the quantum task.

The thermal effect on the process of transferring quantum states is another kind of interesting problems in reality. However, the thermal excitations can be prevented by applying an uniform strong magnetic field to the chains [9]. Therefore, the thermal effect can be neglected in this case.

Here, we discuss the effects of two kind of specific imperfection on the probability of success. One kind of imperfection is the couplings fluctuations caused by the limit of experimental technology of engineering spin chains. Another kind of imperfection is caused by imperfect initialization of the spin chains. Due to the limitation of experimental technology of initializing the spin system, this kind of imperfection can happen in the process of initializing the spin chains. Therefore, discussing the effects of these two kinds of imperfections on both the improved protocol and the original one has much significance. In the following, we will show that the improved protocol is more robust to the two kinds of imperfections than the original one.

A. The effect of imperfect couplings

In Ref. [12], Daniel Burgarth and Sougato Bose studied the effect of couplings fluctuations introduced by the interaction between the spin chain and the spin bath, to the state transfer in single spin-chain channel. The results are interesting. Here, we discuss the effect of imperfect couplings caused by the limitation of experimental technology, such as the accuracy of distance between adjacent spins and the fluctuations of intermediate material's density, to the dual-rail spin-chain channels. To show the advantages of the improved scheme, we

also compare the effects of imperfect couplings to the two schemes.

Because of the limit of experimental technology of engineering spin chains, it is impossible to engineer each of the couplings to the theoretical value, so the couplings fluctuation is very common. As we discussed above, both of the improved scheme and the original one require two identical spin chains, so someone may believe that the slight difference between the two spin chains caused by couplings fluctuation will be lethal to the scheme of dual-rail quantum channels. However, this is not the case [11]. In Ref. [11], the authors showed that one can also accomplish the conclusive transfer with two different spin chains.

In this section, we show the dependence of the probability of success for perfect transfer on the parameter a with considering the couplings fluctuations, so that the advantage of the improved protocol can be displayed on resisting the couplings fluctuations.

When considering the couplings fluctuations, the Hamiltonians of the chains are given by

$$H_{\text{inh}}^{(1)} = \frac{a}{2}(1 + \delta_1^{(1)})(\sigma_1^x \sigma_2^x + \sigma_1^y \sigma_2^y) + \frac{a}{2}(1 + \delta_{N-1}^{(1)})(\sigma_{N-1}^x \sigma_N^x + \sigma_{N-1}^y \sigma_N^y) + \frac{J}{2} \sum_{n=2}^{N-2} (1 + \delta_n^{(1)})(\sigma_n^x \sigma_{n+1}^x + \sigma_n^y \sigma_{n+1}^y) + \sum_{n=1}^N \omega \sigma_n^z, \quad (4.1)$$

$$H_{\text{inh}}^{(2)} = \frac{a}{2}(1 + \delta_1^{(2)})(\sigma_1^x \sigma_2^x + \sigma_1^y \sigma_2^y) + \frac{a}{2}(1 + \delta_{N-1}^{(2)})(\sigma_{N-1}^x \sigma_N^x + \sigma_{N-1}^y \sigma_N^y) + \frac{J}{2} \sum_{n=2}^{N-2} (1 + \delta_n^{(2)})(\sigma_n^x \sigma_{n+1}^x + \sigma_n^y \sigma_{n+1}^y) + \sum_{n=1}^N \omega \sigma_n^z, \quad (4.2)$$

where $\delta_n^{(i)}$ are uniformly distributed uncorrelated random numbers in the interval $[-\Delta, \Delta]$. It is reasonable to require the experimental precision Δ less than 0.01. In the following discussion, we just set $\Delta = 0.01$.

To illustrate the advantage of the improved protocol on resisting this kind of quantum noise, only considering the probability of success after performing the first measurement is enough. Because the two spin chains are different, each of the spin chains will evolve respectively after encoded the quantum state to the dual-rail spin-chain channel. Generally speaking, $f'_{N,1}^{(1)}(t) \neq f'_{N,1}^{(2)}(t)$, where $f'_{N,1}^{(1)}(t) = \langle \mathbf{N} | e^{-iH_{\text{inh}}^{(1)}t} | \mathbf{1} \rangle$ and $f'_{N,1}^{(2)}(t) = \langle \mathbf{N} | e^{-iH_{\text{inh}}^{(2)}t} | \mathbf{1} \rangle$. However, $|f'_{N,1}^{(1)}(t)|$ intersects with $|f'_{N,1}^{(2)}(t)|$ many times [11], so to make the receiver's measurements unbiased with respect to the initial state (necessary requirement for conclusive transfer), the receiver has to perform CNOT operation and measurement to the N th site of spins at time τ [11], where

$$|f'_{N,1}^{(1)}(\tau)| = |f'_{N,1}^{(2)}(\tau)|. \quad (4.3)$$

Because the phase of $f'_{N,1}^{(1)}(\tau)$ is different with that of $f'_{N,1}^{(2)}(\tau)$, when the receiver obtain “1” after the measurement, he has to apply a phase operation to correct the phase error.

We first search specific cases that satisfy Eq. (4.3), for $0 < a < 1$ and $0 < t < 1000$, then find out the maximal probability of success for specific value of a . In Fig. 5, we show the relationship between the maximal probability of success and the parameter a , and we also plot dependence of the times at which the maximal probability of success is achieved on the parameter a .

From Fig. 5, we can see that one can also achieve high probability of success by modulating the parameter a , even considered the couplings fluctuations, and it is possible to take little time to achieve high probability of success for some specific values of a , such as $a = 0.11, 0.54$. To accomplish the conclusive transfer, one need to determine the modulus of $f'_{N,1}^{(1)}(t)$ and $f'_{N,1}^{(2)}(t)$ by the method of tomography [11], rather than precisely measuring every coupling. The precise requirement to the times at which the receiver should measure can be relaxed by measuring at times where not only the probability amplitudes are similar, but also their slope [11].

Even though the advantages of the improved scheme can be displayed in the specific example (Fig. 5), we also examined 20 sets of random samples of fluctuations and calculated the average probability of success. The dependence of the average probability of success, P_{ave} , on the parameter a is plotted in Fig. 6. The results showed us that by modulating the parameter a , one can significantly improve the probability of success.

B. The effect of imperfect initialization

The imperfections caused by imperfect initialization of the system are common in reality, because memory effects and defects usually exist in quantum operation systems. In the following sections, we discuss two specific cases of this kind of imperfection, random single excitation and collective excitation.

1. The imperfection of probabilistic single excitation

By random single excitation we mean that only one excitation happens in each spin chain due to the imperfect initialization caused by the defect of experimental settings. We assume

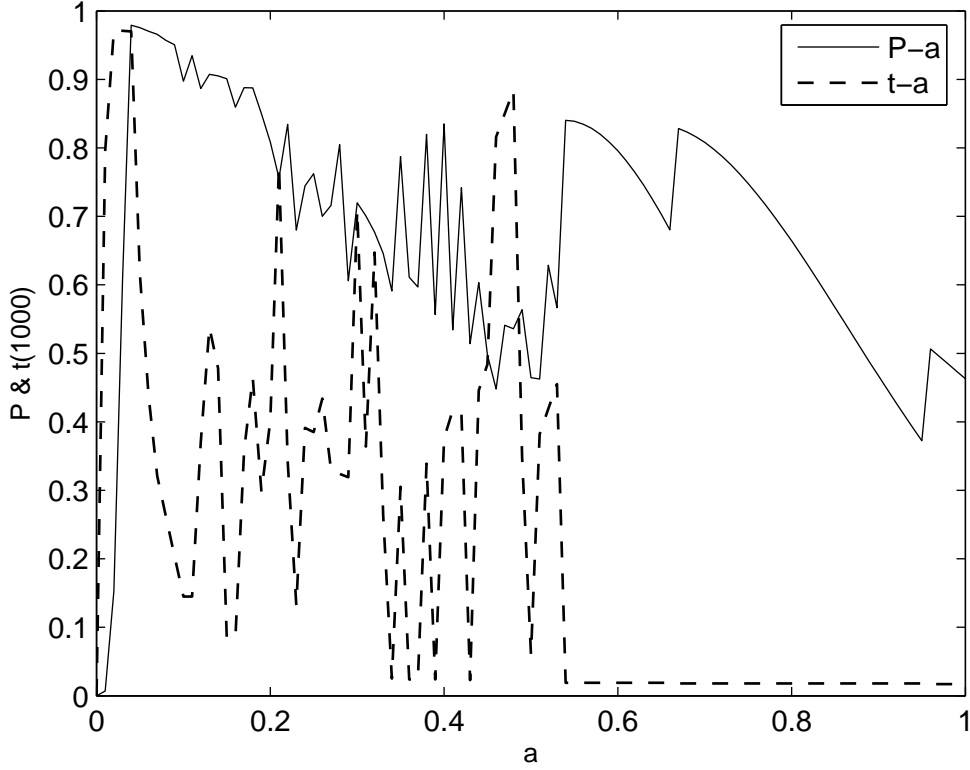

FIG. 5: The dependence of the maximal probability of success (solid line) and of the times at which the maximal probability of success (dashed line) is achieved on the parameter a for $N = 30$. The time scale where we search the points of intersection is set to be less than $1000[\frac{\hbar}{J}]$. The samples of fluctuations, $\{\delta_n^{(1)}\}$ and $\{\delta_n^{(2)}\}$, are chosen to be $\{0.0091, 0.0031, 0.0048, -0.0031, 0.0077, -0.0031, -0.0088, 0.0044, 0.0092, -0.0069, -0.0017, -0.0081, -0.0010, 0.0074, -0.0022, -0.0049, -0.0029, 0.0049, 0.0030, 0.0088, 0.0067, -0.0006, 0.0026, -0.0088, 0.0008, -0.0009, 0.0073, 0.0071, -0.0006\}$ and $\{0.0057, 0.0031, -0.0100, -0.0074, -0.0001, -0.0092, -0.0055, -0.0034, 0.0080, -0.0037, -0.0050, -0.0013, 0.0068, -0.0063, 0.0002, -0.0010, -0.0035, -0.0024, 0.0077, 0.0052, 0.0077, -0.0009, 0.0060, -0.0073, -0.0087, -0.0025, -0.0025, -0.0003, 0.0094\}$, respectively, which are generated by computer.

the two excitations happen on the same site of the two spin chains, respectively. The reason that we make such an assumption is that the experimental environments with which the two spin chains confront are the same. When we consider this kind of noise, the initialized state of the system would be:

$$|\phi\rangle = (\sqrt{1-x}|\mathbf{0}\rangle^{(1)} + \sqrt{x}|\mathbf{m}\rangle^{(1)}) \otimes (\sqrt{1-x}|\mathbf{0}\rangle^{(2)} + \sqrt{x}|\mathbf{m}\rangle^{(2)})$$

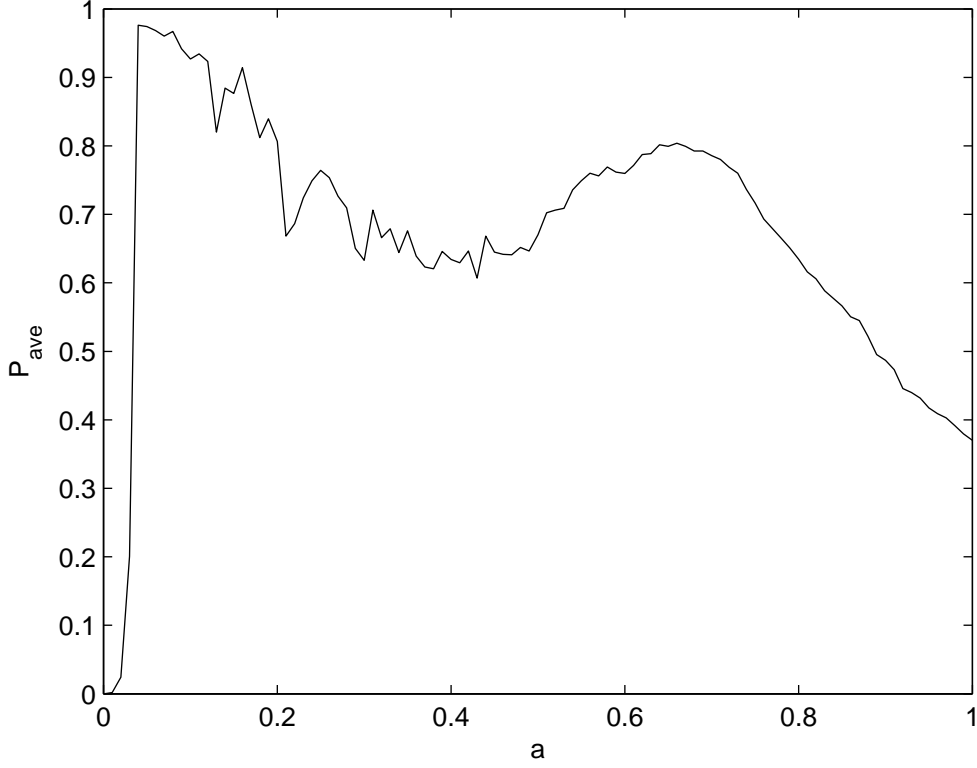

FIG. 6: We study 20 random samples for $N = 30$ and calculate the average probability of success, P_{ave} . The dependence of P_{ave} on the parameter a is plotted. The times are chosen to maximize the probability of success for each sample. All of the random numbers are generated by computer in the interval $[-\Delta, \Delta]$, where $\Delta = 0.01$.

$$= (1-x)|\mathbf{0}\rangle^{(1)}|\mathbf{0}\rangle^{(2)} + \sqrt{x(1-x)}(|\mathbf{0}\rangle^{(1)}|\mathbf{m}\rangle^{(2)} + |\mathbf{m}\rangle^{(1)}|\mathbf{0}\rangle^{(2)}) + x|\mathbf{m}\rangle^{(1)}|\mathbf{m}\rangle^{(2)} \quad (4.4)$$

where x is the probability of happening the random excitation, and m is the site where excitation happens. The second term of Eq. (4.4) represents the situation that the two spin chains are in different states. After encoding the quantum state to the channel, the evolution of spin chain (1) in this term is different (in either amplitude or phase) from that of spin chain (2). Because the main contribution to the probability of success is from the first term of Eq. (4.4), one will either not choose the special times when the amplitudes of spin chain (1) and (2) are intersecting with each other, nor perform phase correction. Therefore, this term will have no contribution to the probability of success. After encoding the quantum state to be transferred to the first sites of the dual-rail quantum channels and

applying corresponding unitary transformation described in the protocol, the state of the system will be

$$|\psi(0)\rangle = (1-x)|s(1)\rangle + x(\alpha|\mathbf{m}\rangle^{(1)}|\mathbf{1m}\rangle^{(2)} + \beta|\mathbf{1m}\rangle^{(1)}|\mathbf{m}\rangle^{(2)}),$$

where $|\mathbf{1m}\rangle$ represents the state of the system with the qubits of site 1 and site m in excited states and all other qubits in ground states. The number of excitations in any single spin chain will conserve in the time evolution, since $[\sigma_{tot}^z, H_{\text{inh}}] = 0$. So after time t , the state of the system would be

$$|\psi(t)\rangle = (1-x) \sum_{n=1}^N f'_{n,1}(t)|s(n)\rangle + x \sum_{n=1}^N \sum_{pq} f'_{n,m}(t) f'_{1m}{}^{pq}(t) (\alpha|\mathbf{n}\rangle^{(1)}|\mathbf{pq}\rangle^{(2)} + \beta|\mathbf{pq}\rangle^{(1)}|\mathbf{n}\rangle^{(2)}), \quad (4.5)$$

where $f'_{n,m}(t) = \langle \mathbf{n} | e^{-iH_{\text{inh}}t} | \mathbf{m} \rangle$, and $f'_{1m}{}^{pq}(t) = \langle \mathbf{pq} | e^{-iH_{\text{inh}}t} | \mathbf{1m} \rangle$. The second term of Eq. (4.5) can be rewrite as:

$$\begin{aligned} & \sum_{n=1}^{N-1} \sum_{\substack{p<q \\ q<N}} f'_{n,m}(t) f'_{1m}{}^{pq}(t) (\alpha|\mathbf{n}\rangle^{(1)}|\mathbf{pq}\rangle^{(2)} + \beta|\mathbf{pq}\rangle^{(1)}|\mathbf{n}\rangle^{(2)}) \\ & + \sum_{\substack{p<q \\ q=N}} f'_{N,m}(t) f'_{1m}{}^{pN}(t) (\alpha|\mathbf{N}\rangle^{(1)}|\mathbf{pN}\rangle^{(2)} + \beta|\mathbf{pN}\rangle^{(1)}|\mathbf{N}\rangle^{(2)}) \\ & + \sum_{n=1}^{N-1} \sum_{\substack{p<q \\ q=N}} f'_{n,m}(t) f'_{1m}{}^{pN}(t) (\alpha|\mathbf{n}\rangle^{(1)}|\mathbf{pN}\rangle^{(2)} + \beta|\mathbf{pN}\rangle^{(1)}|\mathbf{n}\rangle^{(2)}) \\ & + \sum_{\substack{p<q \\ q<N}} f'_{N,m}(t) f'_{1m}{}^{pq}(t) (\alpha|\mathbf{N}\rangle^{(1)}|\mathbf{pq}\rangle^{(2)} + \beta|\mathbf{pq}\rangle^{(1)}|\mathbf{N}\rangle^{(2)}) \end{aligned} \quad (4.6)$$

After performing the C-NOT gate on the N th site of the dual-rail quantum channel, the measurement of the N th qubit of the spin chain (2) would be “0” for the first and second terms of Eq. (4.6) and “1” for the third and forth terms of Eq. (4.6). The result of “0” represents the failure of transfer, which is one of the advantages of dual-rail quantum channels. However, the result of “1” represents both perfect transfer and imperfect transfer, which means that this kind of probabilistic single excitation destroys the greatest advantage—conclusive transfer. For the third term of Eq. (4.6), only when $n = p$, the result of “1” means perfect transfer. While all other terms with measurement of “1” but $n \neq p$, the N th qubit of the spin chain (1) would be in the state of $\rho = |\alpha|^2|0\rangle\langle 0| + |\beta|^2|1\rangle\langle 1|$, which is a mixed state. Therefore, the probability of success of perfect transfer for Eq. (4.5) will be

$$P^{suc}(t) = (1-x)^2 P_0^{suc}(t) + x^2 P_1^{suc}, \quad (4.7)$$

where $P_0^{suc} = |f'_{N,1}(t)|^2$ and $P_1^{suc} = \sum_{n=1}^{N-1} |f'_{n,m}(t)|^2 |f'_{1m}{}^{mN}(t)|^2$.

We just consider the situation with only one measurement permitted, for two reasons, one is that further measurements would introduce more probability of imperfect transfer, and the other one is that the probability of success for perfect transfer is mainly determined by the probability of the result of the first measurement being “1”— $P_0^{suc}(t)$, as discussed above. By considering the situation with only one measurement, the ability to resist this kind of imperfection can be illustrated for the improved protocol. In the following, we study this problem for $N = 30$, the results of which would be applicable to even larger length.

We are interested with the probability of success for perfect transfer $P^{suc}(t)$. This quantity is related with parameters of a , t , m and x . Generally speaking, one can make the probability of happening this kind of single excitation extremely small, but not eliminate it, it would be reasonable to set $x \leq 0.1$ when one study the relationship between the two interesting quantities and the other three parameters. Since the parameter x is small, the probability of success for perfect transfer is mainly determined by the P_0^{suc} . One can set the parameters of a and t to the values that would maximize P_0^{suc} . It would be interesting to study the relationship between the probability of P_1^{suc} and the parameter m , which is the site where the random noise happens. From Fig. 7, we can see that the values of P_1^{suc} are significantly depended on the site where the qubit is in excited state caused by the imperfect initialization. When the noises happen in some particular sites, such as 5, 10, 13, 21, the values of P_1^{suc} are approximately equal to zero. So if one can take some measures to prevent the single excitation to happen on these particular sites, he or she can certainly improve the probability of success for perfect transfer. Another feature of Fig. 7 is that the value of P_1^{suc} is extremely large when $m = N$. This is because when $m = N$, part of the initial state after encoding the quantum state to be transferred to the first site of the quantum channel, is $|\mathbf{1m}\rangle = |\mathbf{1N}\rangle$, which is mirror symmetric about its center. This phenomena directly testify that mirror symmetry is very important to improve the transferring efficiency.

Generally speaking, we do not know which site of the dual-rail quantum channel will be in excited state. Therefore, it is common to assume that the probability of being in excited state for each site is equal since the environment confronted by the two spin chains is uniform. It would be practical and interesting to study the dependence of the average probability of success for perfect transfer on the parameter a , when the transferring time was chosen to maximize the average probability of success for perfect transfer. In the Fig. 8, we can

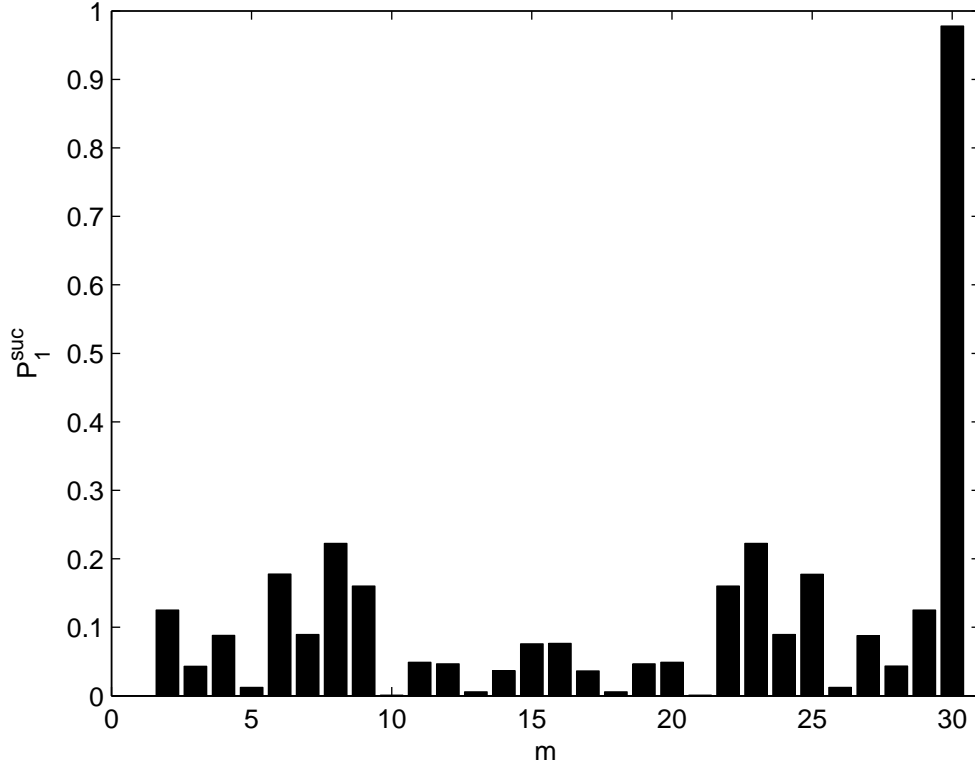

FIG. 7: The dependence of P_1^{suc} on the parameter m is displayed in the figure, for $N = 30, a = 0.06$ and $t = 488[\frac{\hbar}{J}]$.

see that the average probability of success for perfect transfer P_{ave}^{suc} is significantly affected by the changes of the parameter a , therefore, one can improve the average probability of success for perfect transfer by adjusting the parameter a . Numerical calculation shows that when $a = 0.06$, the P_{ave}^{suc} can be maximized and the maximum of the P_{ave}^{suc} is 0.80 , while the maximum of P_{ave}^{suc} is only 0.39 when $a = 1$, which represent the situation of original protocol. Apparently, The probability of success for perfect transfer P_{ave}^{suc} is a quadratic function of x . To completely understand the advantages of the improved protocol, we need to examine the exact relationship between P_{ave}^{suc} and the parameter x for the original protocol and the improved protocol, respectively. In Fig. 9, we can see the advantage of the improved protocol on resisting the probabilistic single excitation. Therefore, the improved protocol will be more robust than the original one to this kind of imperfection, which is introduced by imperfect initialization.

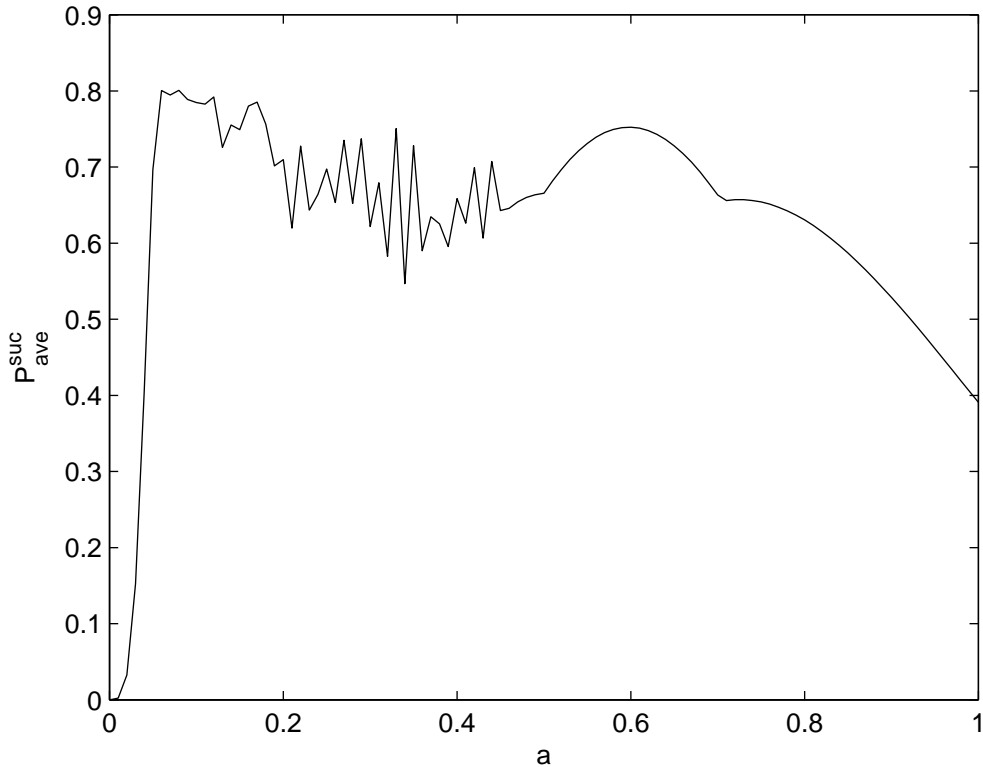

FIG. 8: In this figure, we plot the dependence of the average probability of success for perfect transfer P_{ave}^{suc} on the parameter a for $N = 30$. The transferring time for each a was set to be the values that would maximize P_{ave}^{suc} and the value of x was set to be 0.1 .

2. The imperfection of probabilistic collective excitation

Collective excitation is another common type of imperfection that can happen in spin-chain channels, because this kind of imperfection can also be caused by imperfect initialization resulting from the limitation of experimental settings. Therefore, addressing the collective excitation in this improved scheme has much practical significance.

We just assume the first qubits of the dual-rail spin-chain channel was cooled down to their ground state, since the procedure of encoding the prepared state to the channel will completely eliminate the effect of the imperfection on the first qubits. After considering the collective excitation caused by imperfect initialization, the system, in fact, will be initialized

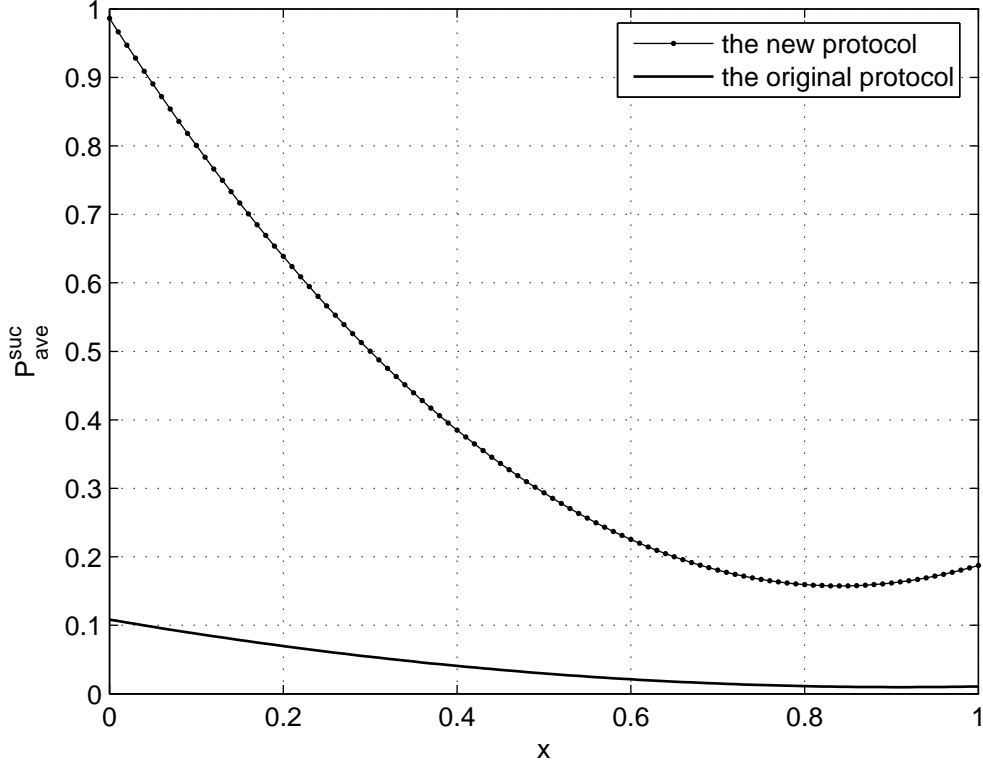

FIG. 9:

In this figure, we plot the dependence of the average probability of success for perfect transfer P_{ave}^{suc} on the parameter x , for the improved protocol (the solid line with dots) and the original protocol (the solid line). For the improved protocol, we set the parameter $a = 0.06$ and $t = 488$, which can maximize P_{ave}^{suc} for $N = 30$.

to the state

$$|\phi\rangle = |0_1\rangle^{(1)} \otimes \prod_{i=2}^N (\sqrt{1-x}|0_i\rangle^{(1)} + \sqrt{x}|1_i\rangle^{(1)}) \otimes |0_1\rangle^{(2)} \otimes \prod_{j=2}^N (\sqrt{1-x}|0_j\rangle^{(2)} + \sqrt{x}|1_j\rangle^{(2)}), \quad (4.8)$$

where x represents the probability of each qubit being in excited state, and $|0_k\rangle^{(c)}$ and $|1_k\rangle^{(c)}$ represents that the k th qubit of spin chain (c) ($c = 1, 2$) is in its ground state and excited state, respectively. When we expand the Eq. (4.8), we would find that it is not necessary to analyze all of the terms, because the terms that represent that the spin chain (1) and the spin chain (2) are in different states have no contribution to the probability of success (for the same reason as discussed in the subsection of probabilistic single excitation). Therefore, we just consider the terms that will contribute to the probability of success. After encoding

the quantum state $|\psi\rangle$ to the first site of spin chain (1) and applying the similar C-NOT operation controlled by the first site of spin chain (1) being “0” to the first sites of the dural-rail channels, the contributing part of the system’s state will become

$$\begin{aligned}
|\psi(0)\rangle &= (1-x)^{N-1}(\alpha|\mathbf{0}\rangle^{(1)}|\mathbf{1}\rangle^{(2)} + \beta|\mathbf{1}\rangle^{(1)}|\mathbf{0}\rangle^{(2)}) \\
&+ x(1-x)^{N-2} \sum_{m=2}^N (\alpha|\mathbf{m}\rangle^{(1)}|\mathbf{1m}\rangle^{(2)} + \beta|\mathbf{1m}\rangle^{(1)}|\mathbf{m}\rangle^{(2)}) \\
&+ x^2(1-x)^{N-3} \sum_{\substack{n=(N-1), \\ p=N \\ n=2, p=3 \\ n < p}} (\alpha|\mathbf{np}\rangle^{(1)}|\mathbf{1np}\rangle^{(2)} + \beta|\mathbf{1np}\rangle^{(1)}|\mathbf{np}\rangle^{(2)}) \\
&+ \dots \\
&+ x^{N-1}(\alpha|\mathbf{23}\dots\mathbf{N}\rangle^{(1)}|\mathbf{123}\dots\mathbf{N}\rangle^{(2)} + \beta|\mathbf{123}\dots\mathbf{N}\rangle^{(1)}|\mathbf{23}\dots\mathbf{N}\rangle^{(2)}), \quad (4.9)
\end{aligned}$$

where $|\mathbf{ij}\dots\mathbf{k}\rangle (i < j < \dots < k)$ represents the state that i th qubit, j th qubit, \dots , and k th qubit are in their excited states, while others are in their ground states. Since the number of excitations are conserved under free evolution, after time t , the state will evolve to

$$\begin{aligned}
|\psi(t)\rangle &= (1-x)^{N-1} \sum_{i=1}^n f'_{i,1}(t) (\alpha|\mathbf{0}\rangle^{(1)}|\mathbf{i}\rangle^{(2)} + \beta|\mathbf{i}\rangle^{(1)}|\mathbf{0}\rangle^{(2)}) \\
&+ x(1-x)^{N-2} \sum_{m=2}^N \sum_{j=1}^N \sum_{r < s} f'_{j,m}(t) f'^{rs}_{1m}(t) (\alpha|\mathbf{j}\rangle^{(1)}|\mathbf{rs}\rangle^{(2)} + \beta|\mathbf{rs}\rangle^{(1)}|\mathbf{j}\rangle^{(2)}) \\
&+ \dots \quad \dots \\
&+ x^{N-1} \sum_{u_1 < \dots < u_{N-1}} f'^{u_1 \dots u_{N-1}}_{23\dots N}(t) \times \\
&\quad (\alpha|\mathbf{u}_1 \dots \mathbf{u}_{N-1}\rangle^{(1)}|\mathbf{123}\dots\mathbf{N}\rangle^{(2)} + \beta|\mathbf{123}\dots\mathbf{N}\rangle^{(1)}|\mathbf{u}_1 \dots \mathbf{u}_{N-1}\rangle^{(2)}), \quad (4.10)
\end{aligned}$$

we can analyze each term of Eq. (4.10) as we analyze Eq. (4.5). After complicated analysis, we can get the probability of success as

$$\begin{aligned}
P_{col}^{suc}(t) &= (1-x)^{2(N-1)} |f'_{N,1}(t)|^2 + x^2(1-x)^{2(N-2)} \sum_{m=2}^N \sum_{j=1}^{N-1} |f'_{j,m}(t)|^2 |f'^{jN}_{1m}(t)|^2 \\
&+ x^4(1-x)^{2(N-3)} \sum_{\substack{p=N, \\ n=2, p=3 \\ n < p}} \sum_{\substack{s=N-1, \\ r=N-2 \\ r < s}} |f'^{rs}_{np}(t)|^2 |f'^{rsN}_{1np}(t)|^2 + \dots \\
&+ x^{2(N-1)} |f'^{12\dots(N-1)}_{23\dots N}(t)|^2. \quad (4.11)
\end{aligned}$$

From Eq. (4.11), we can see that the probability of success for perfect transfer P_{col}^{suc} is the $2(N-1)$ order function of the parameter x . The function’s shape is determined by the coefficient of each term. Since calculating the probability of success P_{col}^{suc} is too difficult for long channels, we just numerically calculated the result of P_{col}^{suc} for $N=4$. The exact results is plotted in Fig. 10. There are two interesting features in Fig. 10. The first one is the symmetry of the curve, which results from the Hamiltonian, because in the subspace with

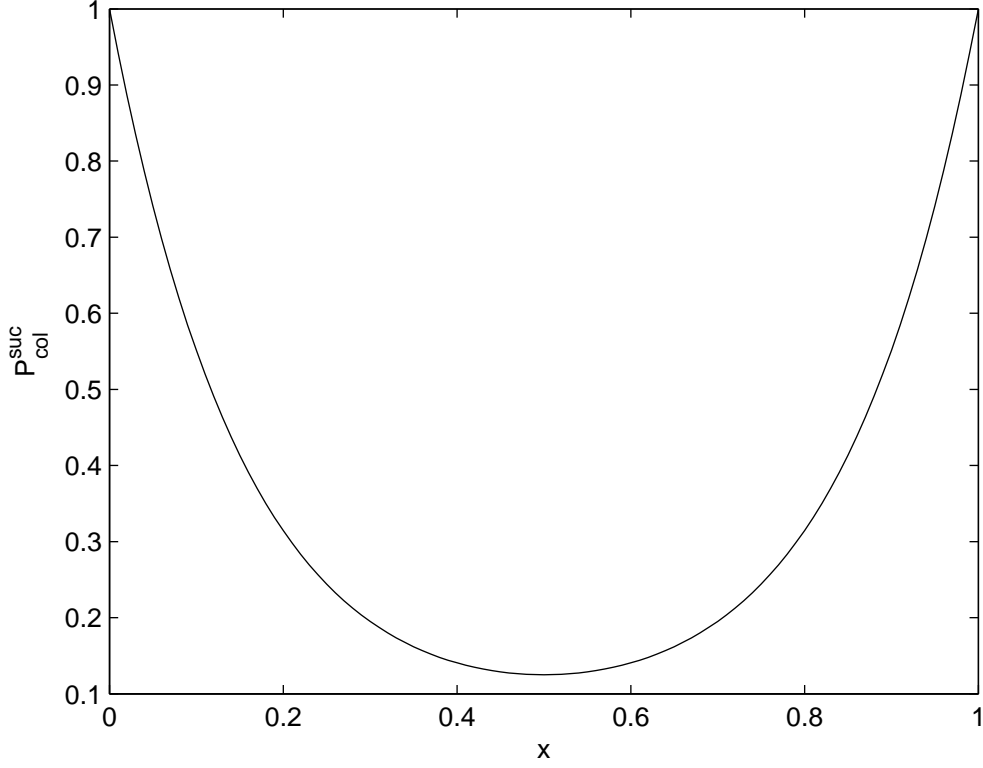

FIG. 10: The dependence of P_{col}^{suc} on the parameter x is plotted for $N = 4$. We set $a = 0.06$ and $t = 18$, which will maximize the P_{col}^{suc} .

μ excitations the Hamiltonian H_{inh} has the same matrix as in the subspace with $N - \mu$ excitations. For example, $f'_{n,m} = f'_{12\dots 0_n \dots N}$. The other one is that P_{col}^{suc} decreases rapidly with the increase of parameter x , when $x < 0.5$. This implies that the effect of collective excitation is much severe, and the effect will exponentially increase with the length of the channel N .

In most cases, the probability of happening collective excitation x is very small, or the spin-chain channels can not complete the quantum communication effectively. Therefore, it is reasonable to assume $x < 0.1$. As a result, we can ignore all the terms in Eq. (4.11) except the first one and the second one, because the terms with higher orders of the parameter x are extremely small compared with the first two terms. In the case of $x < 0.1$, the probability of success will be

$$P_{col}^{suc}(t) = (1 - x)^{2(N-1)} |f'_{N,1}(t)|^2 + x^2 (1 - x)^{2(N-2)} \sum_{m=2}^N \sum_{j=1}^{N-1} |f'_{j,m}(t)|^2 |f'_{1m}{}^j{}^N(t)|^2 \quad (4.12)$$

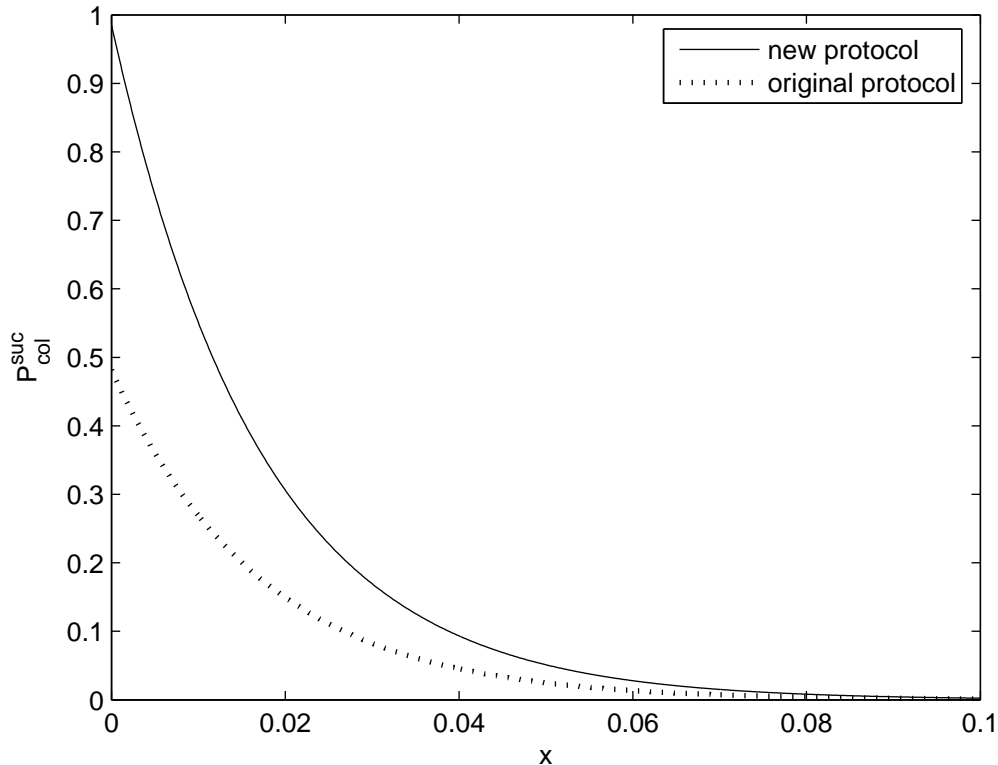

FIG. 11: The effect of collective excitation to the probability of success P_{col}^{suc} is plotted in this figure for the improved protocol (solid line) and the original protocol (dotted line). The length of the channel is chosen to be $N = 30$, and the parameter a is set to be 0.06 for the improved protocol.

The probability of success P_{col}^{suc} in Eq. (4.12) can be calculated even for long channels. In Fig. 11, we numerically calculate the dependence of P_{col}^{suc} on the parameter x for $N = 30$ for both protocols. From Fig. 11, we can see the improved protocol is more robust to collective excitation than the original one.

V. CONCLUSION AND DISCUSSION

In this paper, we successfully find a way to avoid the quantum noise introduced by unnecessary operations for the scheme of [9]. It is to substitute the uniform spin chains used in the original scheme, with the inhomogenous spin chains studied in Ref. [10], so that the number of operations and measurements needed to achieve reasonable probability of success can decrease significantly. Furthermore, the improved scheme not only maintains its

naturality and simplicity, but also greatly improved the efficiency of quantum-state transfer. We carefully studied the dependence of the probability of success for perfect transfer on the parameter a and on the length of channel N . Results show that changing the value of the parameter a can not only improve the probability of success, but also shorten the transferring time, and that the probability of success dose not monotonously decrease with N and is not sensitive to the change of N . Further, we give out the special cases that can greatly improve the probability (achieving about 90%) of success for $N=150, 200, 250$ and 300 , which are considerable large. Finally, we also studied the effects of couplings fluctuations and imperfect initialization. The results show that the improved scheme is more robust to these two kinds of imperfections than the original one. Even the couplings fluctuations happens, the research results show that the conclusive transfer is still possible and that the effect of this kind of imperfection is not lethal to the scheme of dual-rail spin-chain channel. However, the imperfections of probabilistic single excitation and of probabilistic collective excitations, caused by imperfect initialization will destroy the *conclusive* transfer feature of both the improved protocol and the original one, because the measurement result of “1” may also implies the N th site of spin chain (1) is in state $\rho = |\alpha|^2|0\rangle\langle 0| + |\beta|^2|1\rangle\langle 1|$ with very small probability. The effect of probabilistic single excitation is related with m , the site on which the excitation happens. Compared with the probabilistic single excitation, the effect of probabilistic collective excitations is much more severe, and exponentially decrease with the length of the channel N .

Engineering the modulated spin chain[6] that can perfectly transfer quantum states is difficult in experiment. Because the coupling constant between the i th spin and the $(i+1)$ th spin is $J_i = \sqrt{i * (N - i)}$ [6], the ratio of central couplings to the couplings of ends is very large for long spin chains. To engineer a spin chain with coupling constants J_i changing in so large range is very difficult in experiment, and it is hard to maintain the same precision for every couplings in such spin chains.

ACKNOWLEDGEMENT

We acknowledge all the collaborators of our quantum theory group at the Institute for Theoretical Physics of our university. This work was funded by the National Natural Science

- [1] C. H. Bennett and S.J. Wiesner, Phys. Rev. **69**, 2881 (1992); C. H. Bennett, G. Brassard, et al, Phys. Rev. Lett. **70**, 1895 (1993).
- [2] G. R. Guthörlein, M. Keller, K. Hayasaka, W. Lange and H.Walther, Nature(London) **414**, 49 (2001).
- [3] D. Leibfried, B. Demarco, et al, Nature (London) (422),412 (2003); F. Schmidt-Kaler, H. Häffner, et al, Nature (London) **422**, 408 (2003).
- [4] Daniel Burgarth, eprint quant-ph/0706025.
- [5] Sougato Bose, Phys. Rev. Lett. **91**, 207901 (2003).
- [6] Matthias Christandl, Nilanjana Datta, Artur Ekert, and Andrew J. Landahl, Phys. Rev. Lett. **92**, 187902 (2004); Matthias Christandl, Nilajana Datta, Tony C. Dorlas, Artur Ekert, Alastair Kay, and Andrew J. Landahl, Phys. Rev. A **71**, 032312 (2005).
- [7] Christopher Facer, Jason Twamley and James Cresser, Phys. Rev. A **77**, 012334 (2008); Peter Karbach and Joachim Stolze, Phys. Rev. A **72**, 030301(R) (2005); Claudio Albanese, Matthias Christandl, Nilanjana Datta, and Artur Ekert, Phys. Rev. Lett. **93**, 230502 (2004).
- [8] T. Shi, Ying Li, Zhi Song, and Chang-Pu Sun, Phys. Rev. A **71**, 032309 (2005).
- [9] Daniel Burgarth and Sougato Bose, Phys. Rev. A **71**, 052315 (2005).
- [10] Antoni Wójcik, Tomasz Luczak, Pawel Kurzyński, et al, Phys. Rev. A **72**, 034303 (2005).
- [11] Daniel Burgarth and Sougato Bose, New J. Phys. **7**, 135 (2005).
- [12] Daniel Burgarth and Sougato Bose, Phys. Rev. A **73**, 062321 (2006).
- [13] Daniel Burgarth, Vittorio Giovannetti and Sougato Bose, Phys. Rev. A **75**, 062327 (2007).