

Various angle periods of parabolic coincidence fringes in violation of Bell inequality with high-dimensional two-photon entanglement

Hsiao-Chih Huang^{1,2,*}

¹*Institute of Atomic and Molecular Sciences, Academia Sinica, Taipei 106, Taiwan*

²*HC Photonics Corporation, No. 2, Technology Rd. V, Hsinchu 300, Taiwan*

*Email: d93222016@ntu.edu.tw

Abstract: Two quantum states of two half-charge optical vortexes with relative azimuthal angle π are orthogonal, by which two half-charge spiral phase plates with intersection angle π can be used to demonstrate a parabolic coincident fringe in the Bell inequality experiment with high-dimensional two-photon orbital angular momentum entanglement and to thereby obtain a strong Bell parameter of $3\frac{1}{5}$. I theoretically demonstrate various orthogonal relations between two quantum states, each of which is a state with a rotational symmetry superposition made up of n fractional orbital angular momentum states, where $n \in N$. I propose a Bell inequality experiment with two n -section spiral phase plates that have these two quantum states, whereby various angle periods with parabolic coincident fringes $2\pi/n$ and Bell's parameter $3\frac{1}{5}$ in each period can be obtained.

I. INTRODUCTION

Over the past few decades, entangled photon pairs obtained by spontaneously parametric down-conversion (SPDC) [1, 2] have been used to experimentally verify the quantum nonlocality in the violation of the Bell inequality [3]. For two-particle and two-dimensional entanglement, the measured coincidence fringe of the pairs is the square of the sinusoid and Bell's parameter is $2\sqrt{2}$ [4], as proved using photon polarization [5], phase in spatial parity of one-dimensional transverse field (Hermite-Gaussian 10 mode) [6], phase with ghost imaging [7], and orbital angular momentum (OAM) of identical topological charge [8, 9]. In the first three cases, the angle periods of the coincidence fringes are respectively fixed at π , 2π , and π . However, in the last case, the angle periods vary over the range π/m , where m is the topological charge. In this case, the period variable is attributed to the fact that the phase of the photon OAM can vary by m multiples of 2π in an azimuthal rotation cycle [10, 11], whereby m pairs of analyzers that have the property of m -fold rotational symmetry are used [8, 9]. By contrast, the single-value period π in the first case is attributed to the fact that the orientation of photon polarization only varies by π in a rotation cycle, whereby two polarizers, a pair of analyzers of two-fold rotational symmetry, are used. The reasons for those single-value periods in the second and third cases are similar, whereby the respectively vital pair of analyzers are used. A variety of periods should be significant because a large period results in high angle resolution of the coincident fringe, whereas a small period results in a small range requirement of the relative orientation between the two analyzers.

Nevertheless, the OAM entanglement of twin photons obtained by SPDC can have infinite dimensions [12, 13]. The higher dimension indicates that the violation is more robust against noise [14]. Dada *et al.* demonstrated violations of the generalized Bell inequality [15] with two-photon and up to 12-arbitrary-dimensional entanglement by using a setup with two spatial light modulations [16] that are configured by the hologram generation algorithm [17]. Oemrawsingh *et al.* demonstrated a violation of the Clauser-Horne-Shimony-Holt (CHSH) Bell inequality with two-photon and high-dimensional entanglement through two detections with two half-charge spiral phase plates (SPPs), and they obtained the outcomes of the coincidence fringe of the parabola and a strong Bell's parameter of $3\frac{1}{5}$ [18, 19]. One key factor in verifying the quantum nonlocality with a parabolic coincidence fringe is that the quantum state of a light beam with fractional OAM (fractional optical vortex) is the superposition state consisting of numerous optical OAM eigenmodes [20] with a functional weight [21]. However, the periods of both of these coincident fringes are only 2π . In the latter case, the monotonic period is attributable to the rotational asymmetry of the SPP structure.

In this article, I theoretically demonstrate the overlap probability between two quantum states, each of which is a state with a rotational symmetry superposition made up of n fractional OAM states, is n -section parabolas in a cycle round 2π . Various orthogonal relations exist between these two quantum states with charges of $(M - \frac{n}{2}) \bmod n = 0$ and

rotation angles of $\alpha = \pi(2t-1)/n$, $t = 1, 2, \dots, n$. The superposed quantum state has the property of n -fold rotational symmetry and is still the superposition state consisting of numerous optical OAM eigenmodes with functional weights [14]. I propose an experiment to prove the violations of the Bell inequality with high-dimensional two-particle OAM entanglement using an SPDC setup with two analyzers that have these two quantum states; however, the periods of the parabolic coincident fringes vary as $2\pi/n$, and Bell's parameter of $3\frac{1}{5}$ is obtained in each period. Thus, the requirement of small angle range of $2\pi/n$ can be used to prove the quantum nonlocality with high-dimensional two-photon entanglement. These two analyzers consist of two n -section SPPs, and the period variable of parabolic coincident fringes is attributable to the fact that the structure of an n -section SPP has the property of n -fold rotational symmetry.

II. THEORY

An SPP with n edge dislocations, denoted herein as SPP n , is an n -section SPP [22]. The SPP n structure has the property of n -fold rotational symmetry. Figure 1 shows the two cases of $n = 2$ and 4, that is, SPP2 and SPP4, respectively. These are two- and four-section transparent dielectric plates, respectively, whose thicknesses vary linearly with the azimuthal angle ϕ , and therefore, they shift the phases of the incident light fields in two- and four-fold symmetries, respectively. Without loss of generality, two indexes M and α are used to respectively represent the thickness gradient with respect to ϕ and the orientation of the edge dislocation of an SPP n [18, 21]. Owing to the angle repetition for a rotation of 2π , α is bounded by $0 \leq \alpha < 2\pi$. An SPP n can serve as an operator similar to the SPP in the basis set transformation for optical OAM eigenmodes in the Bell inequality experiment [18]. By operating an SPP n operator $\hat{S}_n(\alpha, M)$ on the integer OAM basis $\{|m'\rangle\}$ [23], a new basis $\{|Mn^{(m')}(\alpha)\rangle\}$ is expressed as $\hat{S}_n(\alpha, M)|m'\rangle \equiv |Mn^{(m')}(\alpha)\rangle$. The azimuthal part of a light field with OAM eigenvalue m' after this operation is $\langle\phi|\hat{S}_n(\alpha, M)|m'\rangle = e^{im'\phi}\langle\phi|Mn(\alpha)\rangle$. This is equal to one phase term $e^{im'\phi}$ times the other one $\langle\phi|Mn(\alpha)\rangle$ that has the phase shift structure made from an SPP n . It is readily seen that $|Mn(\alpha)\rangle$ is the quantum state of a light beam that is the exportation by passing a fundamental Gaussian light beam through an SPP n . For $n = 1$, by using an SPP, this is the quantum state of a fractional optical vortex with fractional topological charge M , $|M(\alpha)\rangle$ [21].

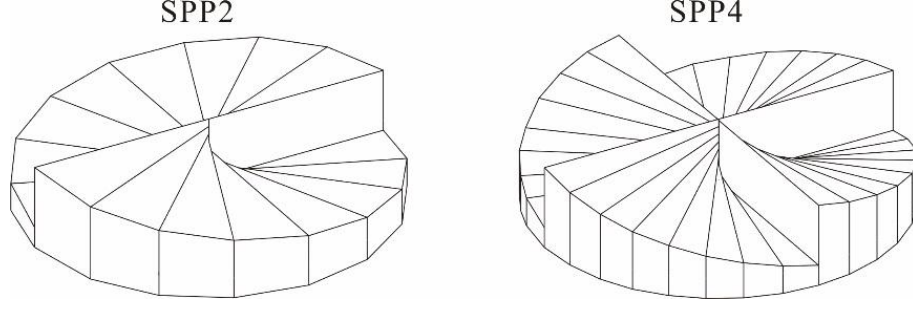

Fig. 1. Schemas of SPP2 and SPP4.

The phase gradients of the helical wavefront with respect to ϕ are invariant for azimuthally superposing fractional optical vortices with identical charges [14] as well as that with integer charge m [24]. The quantum state follows a similar principle; in having identical M , $|Mn(\alpha)\rangle$ with M must be given with the rotational symmetry superposition made up of n fractional OAM states $|M(\alpha)\rangle$ with M by

$$|Mn\rangle = \frac{|Mn'\rangle}{\sqrt{\langle Mn'|Mn'\rangle}}, \quad |Mn'\rangle = \sum_{k=0}^{n-1} \hat{U}\left(2\pi \times \frac{k}{n}\right)|M\rangle, \quad (1)$$

where \hat{U} is the rotation operator, as introduced in Appendix A, and $|Mn'\rangle$ is the unnormalized quantum state, whose field amplitudes with superposition of $n = 2$ and 4 are derived in Appendix B. Along with the structure of SPP n , $|Mn(\alpha)\rangle$ has the property of n -fold rotational symmetry, which is proven theoretically in Appendix C, and the rotational symmetry of the structured light beams with $|M2\rangle$ and $|M4\rangle$ has been verified experimentally in terms of intensity image and phase profile in Ref. 14. $|Mn(\alpha)\rangle$, similar to $|M(\alpha)\rangle$ [20, 21], is a superposition state consisting of numerous optical OAM eigenmodes with functional weights [24], although $|Mn(\alpha)\rangle$ has vanished OAM components as $m' \bmod n$ [14]. A large n implies a large rotational symmetry for both the structure of SPP n and $|Mn(\alpha)\rangle$. Let $\alpha = 0$ and $\{|Mn^{(m)}(0)\rangle\}$ be complete because $\hat{S}_n(\alpha, M)$ is a unitary operator (an invariant field state that is passing through two SPP n s with identical M and n but handedness reversal). $|Mn^{(m)}(\alpha)\rangle$ can be a superposition of these basis states, and α is

equal to the intersection angle between two SPPns. Thus, the decomposition of $|Mn^{(m')}(\alpha)\rangle$ into $\{|Mn^{(m')}(0)\rangle\}$ depends on α . The sum of these projection scalars is equal to the overlap amplitude $\langle Mn(\alpha)|Mn(0)\rangle$, whose modulus square, the overlap probability, is $|\langle Mn(0)|Mn(\alpha)\rangle|^2$. The formulas derived in Appendix D are used to calculate the overlap probability with n .

For $n = 1$, the overlap probability between the quantum state of a light beam with fractional OAM and its rotation state with α is [18]

$$|\langle M(0)|M(\alpha)\rangle|^2 = \left(1 - \frac{\alpha}{\pi}\right)^2 \sin^2(M\pi) + \cos^2(M\pi), \quad 0 \leq \alpha < 2\pi, \quad (2)$$

where Eq. (A3) is used.

The overlap amplitude for $n = 2$ is

$$\langle M2(0)|M2(\alpha)\rangle = \frac{\langle M(0)|M(\alpha)\rangle + \langle M(0)|\hat{U}(\pi)|M(\alpha)\rangle}{1 + \cos(\pi M)}, \quad (3)$$

where Eqs. (B1) and (D3) are used. The $n = 2$ overlap probability is equal to the modulus square of the right hand side of Eq. (3) as

$$\begin{aligned} |\langle M2(0)|M2(\alpha)\rangle|^2 &= \left\{ |\langle M(0)|M(\alpha)\rangle|^2 + |\langle M(0)|\hat{U}(\pi)|M(\alpha)\rangle|^2 \right. \\ &\quad \left. + 2 \operatorname{Re} \left[\langle M(0)|M(\alpha)\rangle \langle M(0)|\hat{U}(\pi)|M(\alpha)\rangle^* \right] \right\} / [1 + \cos(\pi M)]^2. \end{aligned} \quad (4)$$

Let $\beta = \pi$ in Eqs. (D7) and (D5), which are respectively expressed as

$$|\langle M(0)|\hat{U}(\pi)|M(\alpha)\rangle|^2 = \frac{1}{\pi^2} \times \begin{cases} (\alpha^2 - \pi^2) \sin^2(M\pi) + \pi^2, & 0 \leq \alpha < \pi \\ (\alpha - \pi)(\alpha - 3\pi) \sin^2(M\pi) + \pi^2, & \pi \leq \alpha < 2\pi \end{cases} \quad (5)$$

and

$$\begin{aligned} &\operatorname{Re} \left[\langle M(0)|M(\alpha)\rangle \langle M(0)|\hat{U}(\pi)|M(\alpha)\rangle^* \right] \\ &= \frac{1}{4\pi^2} \times \begin{cases} \alpha(\pi - \alpha) \cos(3M\pi) + (4\pi^2 - \pi\alpha + \alpha^2) \cos(M\pi), & 0 \leq \alpha < \pi \\ (2\pi - \alpha)(\alpha - \pi) \cos(3M\pi) + (6\pi^2 - 3\pi\alpha + \alpha^2) \cos(M\pi), & \pi \leq \alpha < 2\pi \end{cases}. \end{aligned} \quad (6)$$

Substituting Eqs. (2), (5), and (6) into Eq. (4) gives

$$\left| \langle M2(0) | M2(\alpha) \rangle \right|^2 = \begin{cases} \left(1 - \frac{2\alpha}{\pi}\right)^2 \sin^2\left(\frac{M\pi}{2}\right) + \cos^2\left(\frac{M\pi}{2}\right), & 0 \leq \alpha < \pi \\ \left(3 - \frac{2\alpha}{\pi}\right)^2 \sin^2\left(\frac{M\pi}{2}\right) + \cos^2\left(\frac{M\pi}{2}\right), & \pi \leq \alpha < 2\pi \end{cases}. \quad (7)$$

The overlap amplitude for $n = 4$ is

$$\begin{aligned} \langle M4(0) | M4(\alpha) \rangle = & \left[\langle M(0) | M(\alpha) \rangle + \langle M(0) | \hat{U}\left(\frac{\pi}{2}\right) | M(\alpha) \rangle + \langle M(0) | \hat{U}(\pi) | M(\alpha) \rangle \right. \\ & \left. + \langle M(0) | \hat{U}\left(\frac{3\pi}{2}\right) | M(\alpha) \rangle \right] / \left[1 + \cos(\pi M) + 2\cos^3\left(\frac{\pi}{2}M\right) \right], \end{aligned} \quad (8)$$

where Eqs. (B2) and (D3) are used. The $n = 4$ overlap probability is equal to the modulus square of the right hand side of Eq. (8) as

$$\begin{aligned} \left| \langle M4(0) | M4(\alpha) \rangle \right|^2 = & \left\{ \left| \langle M(0) | M(\alpha) \rangle \right|^2 + \left| \langle M(0) | \hat{U}(\pi) | M(\alpha) \rangle \right|^2 + \left| \langle M(0) | \hat{U}\left(\frac{\pi}{2}\right) | M(\alpha) \rangle \right|^2 \right. \\ & + \left| \langle M(0) | \hat{U}\left(\frac{3\pi}{2}\right) | M(\alpha) \rangle \right|^2 + 2\operatorname{Re} \left[\langle M(0) | M(\alpha) \rangle \langle M(0) | \hat{U}(\pi) | M(\alpha) \rangle^* \right] \\ & + 2\operatorname{Re} \left[\langle M(0) | M(\alpha) \rangle \langle M(0) | \hat{U}\left(\frac{\pi}{2}\right) | M(\alpha) \rangle^* \right] + 2\operatorname{Re} \left[\langle M(0) | M(\alpha) \rangle \langle M(0) | \hat{U}\left(\frac{3\pi}{2}\right) | M(\alpha) \rangle^* \right] \\ & + 2\operatorname{Re} \left[\langle M(0) | \hat{U}(\pi) | M(\alpha) \rangle \langle M(0) | \hat{U}\left(\frac{\pi}{2}\right) | M(\alpha) \rangle^* \right] + 2\operatorname{Re} \left[\langle M(0) | \hat{U}(\pi) | M(\alpha) \rangle \langle M(0) | \hat{U}\left(\frac{3\pi}{2}\right) | M(\alpha) \rangle^* \right] \\ & \left. + 2\operatorname{Re} \left[\langle M(0) | \hat{U}\left(\frac{\pi}{2}\right) | M(\alpha) \rangle \langle M(0) | \hat{U}\left(\frac{3\pi}{2}\right) | M(\alpha) \rangle^* \right] \right\} / \left[1 + \cos(\pi M) + 2\cos^3\left(\frac{\pi}{2}M\right) \right]^2. \end{aligned} \quad (9)$$

Substituting $\beta = \pi/2$ and $3\pi/2$ in Eq. (D7) gives

$$\left| \langle M(0) | \hat{U}\left(\frac{\pi}{2}\right) | M(\alpha) \rangle \right|^2 = \frac{1}{\pi^2} \times \begin{cases} \left(\alpha + \frac{\pi}{2}\right)\left(\alpha - \frac{3\pi}{2}\right)\sin^2(M\pi) + \pi^2, & 0 \leq \alpha < \frac{3\pi}{2} \\ \left(\alpha - \frac{3\pi}{2}\right)\left(\alpha - \frac{7\pi}{2}\right)\sin^2(M\pi) + \pi^2, & \frac{3\pi}{2} \leq \alpha < 2\pi \end{cases} \quad (10)$$

and

$$\left| \langle M(0) | \hat{U}\left(\frac{3\pi}{2}\right) | M(\alpha) \rangle \right|^2 = \frac{1}{\pi^2} \times \begin{cases} \left(\alpha + \frac{3\pi}{2}\right)\left(\alpha - \frac{\pi}{2}\right)\sin^2(M\pi) + \pi^2, & 0 \leq \alpha < \frac{\pi}{2} \\ \left(\alpha - \frac{\pi}{2}\right)\left(\alpha - \frac{5\pi}{2}\right)\sin^2(M\pi) + \pi^2, & \frac{\pi}{2} \leq \alpha < 2\pi \end{cases}. \quad (11)$$

Substituting $\beta = \pi/2$ and $3\pi/2$ in Eq. (D5) gives

$$\begin{aligned} & \operatorname{Re} \left[\langle M(0) | M(\alpha) \rangle \langle M(0) | \hat{U}\left(\frac{\pi}{2}\right) | M(\alpha) \rangle^* \right] \\ = & \frac{1}{4\pi^2} \times \begin{cases} \left[2(2\alpha^2 - 3\pi\alpha - \pi^2)\sin^2(M\pi) + 4\pi^2 \right] \cos\left(\frac{M\pi}{2}\right) + \pi^2 \sin(2M\pi) \sin\left(\frac{M\pi}{2}\right), & 0 \leq \alpha < \frac{3\pi}{2} \\ \left[2\alpha^2 - 7\pi\alpha + 7\pi^2 \right] \cos\left(\frac{3M\pi}{2}\right) + \left(\frac{7}{2}\pi\alpha - \alpha^2 - 3\pi^2\right) \cos\left(\frac{7M\pi}{2}\right) + \alpha\left(\frac{7}{2}\pi - \alpha\right) \cos\left(\frac{M\pi}{2}\right), & \frac{3\pi}{2} \leq \alpha < 2\pi \end{cases} \end{aligned} \quad (12)$$

and

$$\begin{aligned}
& \text{Re} \left[\langle M(0) | M(\alpha) \rangle \langle M(0) | \hat{U}(\frac{3\pi}{2}) | M(\alpha) \rangle^* \right] \\
&= \frac{1}{4\pi^2} \times \begin{cases} \left[2(2\alpha^2 - \pi\alpha + 3\pi^2) \sin^2(M\pi) + 4\pi^2 \right] \cos(\frac{3M\pi}{2}) + 3\pi^2 \sin(2M\pi) \sin(\frac{3M\pi}{2}), & 0 \leq \alpha < \frac{\pi}{2} \\ \left(2\alpha^2 - 5\pi\alpha + 5\pi^2 \right) \cos(\frac{M\pi}{2}) + \left(\frac{5}{2}\pi\alpha - \alpha^2 - \pi^2 \right) \cos(\frac{5M\pi}{2}) + \alpha \left(\frac{5}{2}\pi - \alpha \right) \cos(\frac{3M\pi}{2}), & \frac{\pi}{2} \leq \alpha < 2\pi \end{cases} .
\end{aligned} \tag{13}$$

Substituting $\beta_1 = \pi$ and $\beta_2 = \pi/2$, $\beta_1 = \pi$ and $\beta_2 = 3\pi/2$, and $\beta_1 = \pi/2$ and $\beta_2 = 3\pi/2$ in Eq. (D8) gives

$$\begin{aligned}
& \text{Re} \left[\langle M(0) | \hat{U}(\pi) | M(\alpha) \rangle \langle M(0) | \hat{U}(\frac{\pi}{2}) | M(\alpha) \rangle^* \right] = \\
& \frac{1}{4\pi^2} \times \begin{cases} \left[4\sin^2(M\pi) \left(\alpha^2 - \frac{\pi}{2}\alpha - \pi^2 \right) + 4\pi^2 \right] \cos(\frac{M\pi}{2}) + \pi^2 \sin(2M\pi) \sin(\frac{M\pi}{2}), & 0 \leq \alpha < \pi \\ \left(2\alpha^2 + 4\pi^2 - 5\pi\alpha \right) \cos(\frac{3M\pi}{2}) + (\alpha - \pi) \left(\frac{3\pi}{2} - \alpha \right) \cos(\frac{7M\pi}{2}) + (3\pi - \alpha) \left(\alpha + \frac{\pi}{2} \right) \cos(\frac{M\pi}{2}), & \pi \leq \alpha < \frac{3\pi}{2}, \\ \left[4\sin^2(M\pi) \left(\alpha^2 - \frac{9}{2}\pi\alpha + 4\pi^2 \right) + 4\pi^2 \right] \cos(\frac{M\pi}{2}) + \pi^2 \sin(2M\pi) \sin(\frac{M\pi}{2}), & \frac{3\pi}{2} \leq \alpha < 2\pi \end{cases} ,
\end{aligned} \tag{14}$$

$$\begin{aligned}
& \text{Re} \left[\langle M(0) | \hat{U}(\pi) | M(\alpha) \rangle \langle M(0) | \hat{U}(\frac{3}{2}\pi) | M(\alpha) \rangle^* \right] = \\
& \frac{1}{4\pi^2} \times \begin{cases} \left[4\sin^2(M\pi) \left(\alpha^2 + \frac{\pi}{2}\alpha - \pi^2 \right) + 4\pi^2 \right] \cos(\frac{M\pi}{2}) + \pi^2 \sin(2M\pi) \sin(\frac{M\pi}{2}), & 0 \leq \alpha < \frac{\pi}{2} \\ \left(2\alpha^2 + 2\pi^2 - 3\pi\alpha \right) \cos(\frac{3M\pi}{2}) + (\pi - \alpha) \left(\alpha - \frac{\pi}{2} \right) \cos(\frac{7M\pi}{2}) + (\alpha + \pi) \left(\frac{5\pi}{2} - \alpha \right) \cos(\frac{M\pi}{2}), & \frac{\pi}{2} \leq \alpha < \pi \\ \left[4\sin^2(M\pi) \left(\alpha^2 - \frac{7\pi}{2}\alpha + 2\pi^2 \right) + 4\pi^2 \right] \cos(\frac{M\pi}{2}) + \pi^2 \sin(2M\pi) \sin(\frac{M\pi}{2}), & \pi \leq \alpha < 2\pi \end{cases}
\end{aligned} \tag{15}$$

, and

$$\begin{aligned}
& \text{Re} \left[\langle M(0) | \hat{U}(\frac{\pi}{2}) | M(\alpha) \rangle \langle M(0) | \hat{U}(\frac{3\pi}{2}) | M(\alpha) \rangle^* \right] = \\
& \frac{1}{4\pi^2} \times \begin{cases} \left[4\sin^2(M\pi) \left(\alpha^2 - \frac{5}{4}\pi^2 \right) + 4\pi^2 \right] \cos(M\pi) + 2\pi^2 \sin(2M\pi) \sin(M\pi), & 0 \leq \alpha < \frac{\pi}{2} \\ \left(\alpha^2 - 2\pi\alpha + \frac{19}{4}\pi^2 \right) \cos(M\pi) + \left(\frac{3\pi}{2} - \alpha \right) \left(\alpha - \frac{\pi}{2} \right) \cos(3M\pi), & \frac{\pi}{2} \leq \alpha < \frac{3\pi}{2} \\ \left[4\sin^2(M\pi) \left(\alpha^2 - 4\pi\alpha + \frac{11}{4}\pi^2 \right) + 4\pi^2 \right] \cos(M\pi) + 2\pi^2 \sin(2M\pi) \sin(M\pi), & \frac{3\pi}{2} \leq \alpha < 2\pi \end{cases} .
\end{aligned} \tag{16}$$

Substituting Eqs. (2), (5), (6), and (10)–(16) into Eq. (9) gives

$$\left| \langle M4(0) | M4(\alpha) \rangle \right|^2 = \begin{cases} \left(1 - \frac{4\alpha}{\pi}\right)^2 \sin^2\left(\frac{M\pi}{4}\right) + \cos^2\left(\frac{M\pi}{4}\right), & 0 \leq \alpha < \frac{\pi}{2} \\ \left(3 - \frac{4\alpha}{\pi}\right)^2 \sin^2\left(\frac{M\pi}{4}\right) + \cos^2\left(\frac{M\pi}{4}\right), & \frac{\pi}{2} \leq \alpha < \pi \\ \left(5 - \frac{4\alpha}{\pi}\right)^2 \sin^2\left(\frac{M\pi}{4}\right) + \cos^2\left(\frac{M\pi}{4}\right), & \pi \leq \alpha < \frac{3\pi}{2} \\ \left(7 - \frac{4\alpha}{\pi}\right)^2 \sin^2\left(\frac{M\pi}{4}\right) + \cos^2\left(\frac{M\pi}{4}\right), & \frac{3\pi}{2} \leq \alpha < 2\pi \end{cases} \quad (17)$$

According to Eqs. (2), (7), and (17), the overlap probability for arbitrary n should be calculated as

$$\left| \langle Mn(0) | Mn(\alpha) \rangle \right|^2 = \frac{[\pi(2t-1) - n\alpha]^2}{\pi^2} \sin^2\left(\frac{M\pi}{n}\right) + \cos^2\left(\frac{M\pi}{n}\right), \quad (18)$$

$$\frac{2\pi}{n}(t-1) \leq \alpha < \frac{2\pi}{n}t, \quad t = 1, 2, \dots, n.$$

This probability generally depends on the integer part of the step index m ; however, it is independent of the topological charge of twin photons m' . In particular, it is independent of m and m' as $n = 1$ [18]. Eq. (18) is a constant function of α as $M \bmod n = 0$, and it is otherwise a parabolic function of α that is repeated between n sections as $M \bmod n \neq 0$. These n -section parabolic functions, similar to previously reported parabolic functions [18], indicates that SPP n rotates the OAM state following through the Hilbert space that is not confined to a two-dimensional subspace. There are orthogonal relations such as $(M - \frac{n}{2}) \bmod n = 0$ at $\alpha = \pi(2t-1)/n$. Equivalently, all the total phase variations in each fold of these superposed quantum states with various n cases are module 2π by π in these orthogonal relations. Two probability functions with $n = 2$ and $n = 4$ are plotted in Fig. 2 for cases of uncorrelated, correlated, and orthogonal relations.

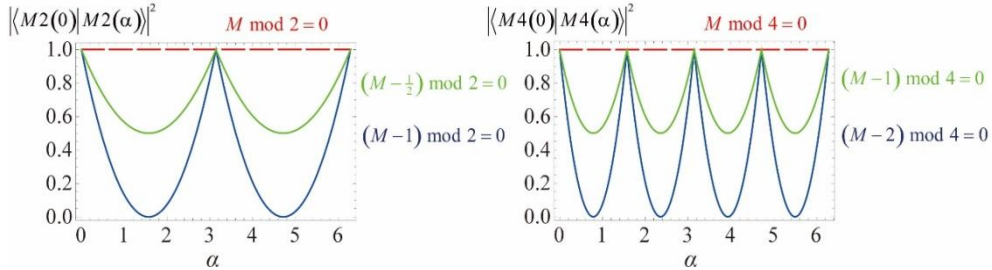

Fig. 2. Various angle periods of overlap probability. Left: three overlap probabilities between a superposed quantum state $|M2(0)\rangle$ and its rotation $|M2(\alpha)\rangle$ in the charges $M \bmod 2 = 0$, $(M - \frac{1}{2}) \bmod 2 = 0$, and $(M - 1) \bmod 2 = 0$, as indicated respectively by red dotted, green, and blue solid curves. The first is a constant, whereas the latter two are parabolic functions of

α down to 0.5 and 0 at $\alpha = \pi/2$ and $3\pi/2$. Right: three overlap probabilities between a superposed quantum state $|M4(0)\rangle$ and its rotation $|M4(\alpha)\rangle$ in the charges $M \bmod 4 = 0$, $(M-1) \bmod 4 = 0$, and $(M-2) \bmod 4 = 0$. The first is a constant, whereas the latter two are parabolic functions of α down to 0.5 and 0 at $\alpha = \pi/4, 3\pi/4, 5\pi/4$, and $7\pi/4$.

III. PROPOSED EXPERIMENT

I propose an experimental setup similar to the one in Figure 2 of Ref. 18 but with the two SPPs with half-integers being replaced by two SPPns with $(M - \frac{n}{2}) \bmod n = 0$ to prove the violations of the Bell inequality with high-dimensional two-particle OAM entanglement. This is a type of SPDC setup. Its generated twin photons in two arms, signal and idler, obey OAM conservation [12] provided that two conditions of the paraxial limit and thin-crystal approximation [25-28]. By choosing a fundamental Gaussian pump beam in an SPDC setup with photon OAM conservation, the normalized coincidence fringe detected by the two photons after passing two SPPns that are intersected by α is equal to the mode overlap probability between two quantum states (Eq. (18)), as also described in Refs. 18 and 19. However, the fringes are n -section parabolas. These expected outcomes with various azimuthal angle periods of parabolic coincident fringes will have a small range of intersection angles in proving quantum nonlocality with high-dimensional two-photon entanglement.

As in the case of two SPPs [18], the CHSH inequality is chosen in my proposed experiment as $S = E(\alpha_s, \alpha_i) - E(\alpha'_s, \alpha_i) + E(\alpha_s, \alpha'_i) + E(\alpha'_s, \alpha'_i) \leq 2$ [4], where s and i denote the signal and idler in the SPDC experiment, respectively. E is expressed as [5, 29]

$$E(\alpha_s, \alpha_i) = \frac{P(\alpha_s, \alpha_i) + P(\alpha_s^\perp, \alpha_i^\perp) - P(\alpha_s, \alpha_i^\perp) - P(\alpha_s^\perp, \alpha_i)}{P(\alpha_s, \alpha_i) + P(\alpha_s^\perp, \alpha_i^\perp) + P(\alpha_s, \alpha_i^\perp) + P(\alpha_s^\perp, \alpha_i)}, \quad (19)$$

where $P(\alpha_s, \alpha_i)$ is the coincidence probability function proportional to $[1 - |\alpha_s - \alpha_i|/(\pi/n)]^2$ in the orthogonal case of $(M - \frac{n}{2}) \bmod n = 0$ and only the modulus of $\alpha_s - \alpha_i$. α_s^\perp and α_i^\perp are the angles of two analyzers for the states orthogonal to the states with setting α_s and α_i , respectively. In this case, there are n pairs of them as $\alpha_s^\perp \equiv \alpha_s + \pi(2t-1)/n$ and $\alpha_i^\perp \equiv \alpha_i + \pi(2t-1)/n$, $t = 1, 2, \dots, n$. As the periodicity in this case is $1/2n$ that in the case of photon polarization entanglement, I use the standard analyzer settings of a previous case [5, 30] divided by $2n$: $\alpha_s = -\pi/4n$, $\alpha'_s = \pi/4n$, $\alpha_i = -\pi/2n$, and $\alpha_i = 0$. Upon substituting these parameters into Eq. (19), Bell's parameter in each of the n -sections can be evaluated as $3\frac{1}{5}$, which is identical to that mentioned in Ref. 18.

IV. CONCLUSION

I have theoretically demonstrated the overlap probability between two quantum states, each of which is a state with a rotational symmetry superposition made up of n fractional OAM states, is n -section parabolas. There are various orthogonal relations between these two quantum states at charges of $(M - \frac{n}{2}) \bmod n = 0$ and relative rotation angle $\alpha = \pi(2t - 1)/n$, $t = 1, 2, \dots, n$. I propose to prove the violations of the Bell inequality with high-dimensional two-particle OAM entanglement in an SPDC experiment with two SPPns where the intersection angle represents various periods of parabolic coincident fringes. The occurring charge of $(M - \frac{n}{2}) \bmod n = 0$ is coincident with the occurrence of the completely destructive interference [24] (cf. Ref. 24, except $M = 1/2$) and maximum phase dislocation degree for a light beam with phase singularity that is characterized with azimuthally symmetric angular positions [14].

APPENDIX A: QUANTUM STATE OF A LIGHT BEAM WITH FRACTIONAL OAM

The quantum state of a light beam with fractional OAM is denoted by $|M(\alpha)\rangle$ [21], where $M = m + \mu$ and the parameter α , bounded by $0 \leq \alpha < 2\pi$, is the angular position of the discontinuity. A function $f_\alpha(\phi)$ is introduced as

$$f_\alpha(\phi) = \begin{cases} 1, & 0 \leq \phi < \alpha \\ 0, & \alpha \leq \phi < 2\pi \end{cases}. \quad (\text{A1})$$

By using Eq. (A1), a definition can be shown as

$$\langle \phi | M(\alpha) \rangle \equiv e^{im\phi} e^{i\mu[\phi + 2\pi f_\alpha(\phi) - \alpha]}. \quad (\text{A2})$$

Based on the completeness relation and Eq. (A2), the overlap amplitude between two states with an intersection angle α is

$$\begin{aligned} \langle M(0) | M(\alpha) \rangle &= \frac{1}{2\pi} \int_0^{2\pi} d\phi e^{i2\pi\mu[f_\alpha(\phi) - f_0(\phi)]} e^{i\mu(0-\alpha)} \\ &= \frac{1}{2\pi} \left[\alpha e^{i(2\pi-\alpha)\mu} + (2\pi-\alpha) e^{-i\alpha\mu} \right]. \end{aligned} \quad (\text{A3})$$

$|M(\alpha)\rangle$ can be decomposed into integer OAM eigenmodes, the probability distribution of which can be obtained by setting $\langle M(0) | = \langle m' |$ in Eq. (A3)

$$c_{m'} [M(\alpha)] = \langle m' | M(\alpha) \rangle = \frac{ie^{i(m-m')\alpha}}{2\pi(M-m')} (1 - e^{i2\pi\mu}). \quad (\text{A4})$$

The state resulting from a unitary operator $\hat{U}(\beta)$ is the effect of the rotation for this quantum state and an additional phase term $e^{-im\beta}$:

$$\hat{U}(\beta) |M(\alpha)\rangle = e^{-im\beta} |M(\alpha \oplus \beta)\rangle, \quad (\text{A5})$$

where the parameter β bounded by $0 \leq \beta < 2\pi$ is the action on the state and $\alpha \oplus \beta = (\alpha + \beta) \bmod 2\pi$ yields a result in the range $[0, 2\pi)$ owing to the 2π modulo. The multiplication of rotation operators has the combination characteristic

$$\hat{U}(\beta_1) \hat{U}(\beta_2) |M(\alpha)\rangle = \hat{U}(\beta_1 \oplus \beta_2) |M(\alpha)\rangle. \quad (\text{A6})$$

Some useful formulas are derived as follows.

$$\langle M(\alpha) | \hat{U}(\beta) | M(\alpha) \rangle = \frac{e^{-im\beta}}{2\pi} \left[\beta e^{i(2\pi-\beta)\mu} + (2\pi-\beta) e^{-i\beta\mu} \right], \quad (\text{A7})$$

where Eqs. (A3) and (A5) are used. The real part of Eq. (A7) is

$$\text{Re} \langle M(\alpha) | \hat{U}(\beta) | M(\alpha) \rangle = \frac{1}{2\pi} \left[\beta \cos(2\pi\mu - \beta M) + (2\pi - \beta) \cos(\beta M) \right]. \quad (\text{A8})$$

By using Eqs. (A4) and (A5),

$$\langle m' | \hat{U}(\beta) | M(\alpha) \rangle = e^{-im\beta} \frac{i e^{i(m-m')(\beta\oplus\alpha)}}{2\pi(M-m')} (1 - e^{i2\pi\mu}). \quad (\text{A9})$$

APPENDIX B: USEFUL FORMULAS FOR QUANTUM STATES WITH SUPERPOSITIONS OF $n = 2$ AND 4

In Eq. (1), the field amplitude of the unnormalized quantum state with $n = 2$ superposition is

$$\begin{aligned} \langle M2' | M2' \rangle &= \left[\langle M | + \langle M | \hat{U}^\dagger(\pi) \right] \left[|M\rangle + \hat{U}(\pi) |M\rangle \right] \\ &= 2 \left[\langle M | M \rangle + \text{Re} \langle M | \hat{U}(\pi) | M \rangle \right] = 2 \left[1 + \cos(M\pi) \right], \end{aligned} \quad (\text{B1})$$

where the unitary property of \hat{U} , $\cos(2\pi\mu - \pi M) = \cos(\pi M - 2\pi m) = \cos(\pi M)$, and Eqs. (A3) and (A8) are used. The field amplitude of the unnormalized quantum state with $n = 4$ superposition in Eq. (1) is

$$\begin{aligned} \langle M4' | M4' \rangle &= \left\{ \left[\langle M | + \langle M | \hat{U}^\dagger\left(\frac{\pi}{2}\right) + \langle M | \hat{U}^\dagger(\pi) + \langle M | \hat{U}^\dagger\left(\frac{3\pi}{2}\right) \right] \right. \\ &\quad \left. \left[|M\rangle + \hat{U}\left(\frac{\pi}{2}\right) |M\rangle + \hat{U}(\pi) |M\rangle + \hat{U}\left(\frac{3\pi}{2}\right) |M\rangle \right] \right\} \\ &= 4 \left[\langle M | M \rangle + \text{Re} \langle M | \hat{U}\left(\frac{\pi}{2}\right) | M \rangle + \text{Re} \langle M | \hat{U}(\pi) | M \rangle + \text{Re} \langle M | \hat{U}\left(\frac{3\pi}{2}\right) | M \rangle \right] \\ &= 4 + 4 \cos(\pi M) + 8 \cos^3\left(\frac{\pi}{2} M\right), \end{aligned} \quad (\text{B2})$$

where the unitary property of \hat{U} , $e^{-i2\pi m} = 1$, and Eqs. (A3), (A6), and (A8) are used.

APPENDIX C: ROTATIONAL SYMMETRY OF $|Mn(\alpha)\rangle$

I describe the order of rotational symmetry for $|Mn(\alpha)\rangle$. For $n = 1$, $|M\rangle$ has the property of least rotational symmetry of one-fold C_1 considering its rotation by $\theta = 2\pi$ as

$$\hat{U}(2\pi) |M\rangle = |M\rangle. \quad (\text{C1})$$

$|M\rangle$ does not have rotational symmetry with order larger than one because of the innate

character of the phase structure of a fractional optical vortex. The rotational symmetry of $|Mn(\alpha)\rangle$, $n > 1$, can be verified by the state with the superposition made up of the original and rotated states. For $n = 2$, $|M2'\rangle \equiv \hat{U}(\pi)|M\rangle + |M\rangle$ from Eq. (1). $|M2'\rangle$ satisfies the least rotational symmetry as

$$\hat{U}(2\pi)|M2'\rangle = |M2'\rangle. \quad (\text{C2})$$

To sum $|M2'\rangle$ and its rotation state with $\theta = \pi$, I have

$$\begin{aligned} \hat{U}(\pi)|M2'\rangle + |M2'\rangle &= \hat{U}(\pi)\hat{U}(\pi)|M\rangle + \hat{U}(\pi)|M\rangle + \hat{U}(\pi)|M\rangle + |M\rangle = \\ 2[\hat{U}(\pi)|M\rangle + |M\rangle] &= 2|M2'\rangle, \end{aligned} \quad (\text{C3})$$

where Eq. (A8) and Eq. (C1) are used. From Eq. (C3),

$$\hat{U}(\pi)|M2'\rangle = |M2'\rangle \quad (\text{C4})$$

Owing to Eqs. (C2) and (C4), $|M2'\rangle$ has the property of rotational symmetry of C_2 .

$|M2'\rangle \equiv \hat{U}(\pi)|M\rangle + |M\rangle$ does not have the rotational symmetry with order larger than two, because $|M\rangle$ does not have rotational symmetry with order larger than one.

For $n = 4$, $|M4'\rangle \equiv |M\rangle + \hat{U}(\frac{\pi}{2})|M\rangle + \hat{U}(\pi)|M\rangle + \hat{U}(\frac{3\pi}{2})|M\rangle$, from Eq. (1). $|M4'\rangle$ satisfies the least rotational symmetry as

$$\hat{U}(2\pi)|M4'\rangle = |M4'\rangle. \quad (\text{C5})$$

To sum $|M4'\rangle$ and its rotation with $\theta = \pi/2$, I have

$$\begin{aligned} |M4'\rangle + \hat{U}\left(\frac{\pi}{2}\right)|M4'\rangle &= |M\rangle + \hat{U}\left(\frac{\pi}{2}\right)|M\rangle + \hat{U}(\pi)|M\rangle + \hat{U}\left(\frac{3\pi}{2}\right)|M\rangle + \\ \hat{U}\left(\frac{\pi}{2}\right)|M\rangle + \hat{U}\left(\frac{\pi}{2}\right)\hat{U}\left(\frac{\pi}{2}\right)|M\rangle &+ \hat{U}\left(\frac{\pi}{2}\right)\hat{U}(\pi)|M\rangle + \hat{U}\left(\frac{\pi}{2}\right)\hat{U}\left(\frac{3\pi}{2}\right)|M\rangle = \\ 2\left[|M\rangle + \hat{U}\left(\frac{\pi}{2}\right)|M\rangle + \hat{U}(\pi)|M\rangle + \hat{U}\left(\frac{3\pi}{2}\right)|M\rangle\right] &= 2|M4'\rangle \end{aligned} \quad (\text{C6})$$

where Eq. (A8) and Eq. (C1) are used. From Eq. (C6),

$$\hat{U}\left(\frac{\pi}{2}\right)|M4'\rangle = |M4'\rangle. \quad (\text{C7})$$

Similarly, to sum $|M4'\rangle$ and its rotations with $\theta = \pi$ and $\theta = 3\pi/2$, I have respectively

$$\hat{U}(\pi)|M4'\rangle = |M4'\rangle, \quad (\text{C8})$$

and

$$\hat{U}\left(\frac{3\pi}{2}\right)|M4'\rangle = |M4'\rangle. \quad (\text{C9})$$

Owing to Eqs. (C5), (C7)-(C9), $|M4'\rangle$ has the property of rotational symmetry of C_4 . Similarly, $|Mn\rangle$ has the property of rotational symmetry of C_n by $\hat{U}(\theta = 2\pi \times t/n)|Mn\rangle = |Mn\rangle$, $t = 1, 2, \dots, n$. The experimental superposition can be performed using a Mach-Zehnder interferometer (MZI) with θ , and it has already been verified experimentally for two light beams whose quantum states are $|M2\rangle$ and $|M4\rangle$ [14].

APPENDIX D: USEFUL FORMULAS FOR $|\langle Mn(\mathbf{0})|Mn(\alpha)\rangle|^2$

α and $\beta \in [0, 2\pi)$.

$$\langle M(0)|\hat{U}(\beta)|M(\alpha)\rangle = \frac{e^{-im\beta}}{2\pi} \times \begin{cases} (\alpha + \beta)e^{i(2\pi - \alpha - \beta)\mu} + (2\pi - \alpha - \beta)e^{-i(\alpha + \beta)\mu}, & \alpha + \beta \leq 2\pi \\ (\alpha + \beta - 2\pi)e^{i(4\pi - \alpha - \beta)\mu} + (4\pi - \alpha - \beta)e^{-i(\alpha + \beta - 2\pi)\mu}, & \alpha + \beta > 2\pi \end{cases} \quad (D1)$$

, where Eqs. (A3) and (A5) are used. There are two expressions in two sections of Eq. (D1). Similarly,

$$\langle M(0)|\hat{U}(2\pi - \beta)|M(\alpha)\rangle = \frac{e^{im\beta}}{2\pi} \times \begin{cases} (2\pi + \alpha - \beta)e^{i(\beta - \alpha)\mu} + (\beta - \alpha)e^{-i(2\pi + \alpha - \beta)\mu}, & \alpha \leq \beta \\ (\alpha - \beta)e^{i(2\pi + \beta - \alpha)\mu} + (2\pi + \beta - \alpha)e^{-i(\alpha - \beta)\mu}, & \alpha > \beta \end{cases} \quad (D2)$$

By Eqs. (D1) and (D2),

$$\langle M(\alpha)|\hat{U}(\beta)|M(0)\rangle^* = \langle M(0)|\hat{U}(2\pi - \beta)|M(\alpha)\rangle, \quad (D3)$$

where the 1-fold rotational symmetry (least rotational symmetry), unitary property of \hat{U} , and Eq. (A5) are used. The product of Eq. (A3) and complex conjugate of Eq. (D1) is

$$\begin{aligned} & \langle M(0)|M(\alpha)\rangle \langle M(0)|\hat{U}(\beta)|M(\alpha)\rangle^* \\ &= \frac{1}{4\pi^2} \times \begin{cases} [\alpha(\alpha + \beta) + (2\pi - \alpha)(2\pi - \alpha - \beta)]e^{i\beta M} + (2\pi - \alpha)(\alpha + \beta)e^{-i(2\pi - \beta)M} \\ + \alpha(2\pi - \alpha - \beta)e^{i(2\pi + \beta)M}, & \alpha + \beta \leq 2\pi \\ [\alpha(\alpha + \beta - 2\pi) + (2\pi - \alpha)(4\pi - \alpha - \beta)]e^{-i(2\pi - \beta)M} + (2\pi - \alpha)(\alpha + \beta - 2\pi)e^{-i(4\pi - \beta)M} \\ + \alpha(4\pi - \alpha - \beta)e^{i\beta M}, & \alpha + \beta > 2\pi \end{cases} \end{aligned} \quad (D4)$$

The real part of Eq. (D4) is

$$\begin{aligned}
& \text{Re} \left[\langle M(0) | M(\alpha) \rangle \langle M(0) | \hat{U}(\beta) | M(\alpha) \rangle^* \right] \\
&= \frac{1}{4\pi^2} \times \begin{cases} \left[4(\alpha^2 + \alpha\beta - 2\pi\alpha - \pi\beta) \sin^2(\pi M) + 4\pi^2 \right] \cos(\beta M) + 2\pi\beta \sin(2\pi M) \sin(\beta M), & \alpha + \beta \leq 2\pi \\ 2(\alpha^2 + \alpha\beta - 4\pi\alpha - \pi\beta + 4\pi^2) \cos[(2\pi - \beta)M] + (2\pi - \alpha)(\alpha + \beta - 2\pi) \cos[(4\pi - \beta)M] \\ + \alpha(4\pi - \alpha - \beta) \cos(\beta M), & \alpha + \beta > 2\pi \end{cases} .
\end{aligned} \tag{D5}$$

By Eq. (D1),

$$\begin{aligned}
& \langle M(0) | \hat{U}(\beta_1) | M(\alpha) \rangle \langle M(0) | \hat{U}(\beta_2) | M(\alpha) \rangle^* \\
&= \frac{e^{-i(\beta_1 - \beta_2)M}}{4\pi^2} \times \begin{cases} 4\sin^2(\pi M) [(\alpha + \beta_1)(\alpha + \beta_2) - \pi(2\alpha + \beta_1 + \beta_2)] + 4\pi^2 \\ + i2\pi(\beta_1 - \beta_2) \sin(2\pi M), & \alpha + \beta_1 \leq 2\pi \text{ and } \alpha + \beta_2 \leq 2\pi \\ [(\alpha + \beta_1)(\alpha + \beta_2 - 2\pi) + (2\pi - \alpha - \beta_1)(4\pi - \alpha - \beta_2)] e^{-i2\pi M} \\ + (2\pi - \alpha - \beta_1)(\alpha + \beta_2 - 2\pi) e^{-i4\pi M} + (\alpha + \beta_1)(4\pi - \alpha - \beta_2) \\ , & \alpha + \beta_1 \leq 2\pi \text{ and } \alpha + \beta_2 > 2\pi \\ [(\alpha + \beta_1 - 2\pi)(\alpha + \beta_2) + (4\pi - \alpha - \beta_1)(2\pi - \alpha - \beta_2)] e^{i2\pi M} \\ + (\alpha + \beta_1 - 2\pi)(2\pi - \alpha - \beta_2) e^{i4\pi M} + (4\pi - \alpha - \beta_1)(\alpha + \beta_2) \\ , & \alpha + \beta_1 > 2\pi \text{ and } \alpha + \beta_2 \leq 2\pi \\ 4\sin^2(\pi M) [(\alpha + \beta_1)(\alpha + \beta_2) - \pi(6\alpha + 3\beta_1 + 3\beta_2 - 8\pi)] + 4\pi^2 \\ + i2\pi(\beta_1 - \beta_2) \sin(2\pi M), & \alpha + \beta_1 > 2\pi \text{ and } \alpha + \beta_2 > 2\pi \end{cases} .
\end{aligned} \tag{D6}$$

There are four expressions in four sections of Eq. (D6). As $\beta_1 = \beta_2 = \beta$, Eq. (D6) becomes

$$\left| \langle M(0) | \hat{U}(\beta) | M(\alpha) \rangle \right|^2 = \frac{1}{4\pi^2} \times \begin{cases} 4(\alpha + \beta)(\alpha + \beta - 2\pi) \sin^2(\pi M) + 4\pi^2, & \alpha + \beta \leq 2\pi \\ 4(\alpha + \beta - 4\pi)(\alpha + \beta - 2\pi) \sin^2(\pi M) + 4\pi^2, & \alpha + \beta > 2\pi \end{cases} .
\end{aligned} \tag{D7}$$

The real part of Eq. (D6) is

$$\begin{aligned}
& \text{Re} \left[\langle M(0) | \hat{U}(\beta_1) | M(\alpha) \rangle \langle M(0) | \hat{U}(\beta_2) | M(\alpha) \rangle^* \right] \\
&= \frac{1}{4\pi^2} \times \left\{ \begin{aligned}
& \left\{ 4 \sin^2(\pi M) [(\alpha + \beta_1)(\alpha + \beta_2) - \pi(2\alpha + \beta_1 + \beta_2)] + 4\pi^2 \right\} \cos[(\beta_1 - \beta_2)M] \\
& + 2\pi(\beta_1 - \beta_2) \sin(2\pi M) \sin[(\beta_1 - \beta_2)M], \alpha + \beta_1 \leq 2\pi \text{ and } \alpha + \beta_2 \leq 2\pi \\
& \left[(\alpha + \beta_1)(\alpha + \beta_2 - 2\pi) + (2\pi - \alpha - \beta_1)(4\pi - \alpha - \beta_2) \right] \cos[(\beta_1 - \beta_2 + 2\pi)M] \\
& + (2\pi - \alpha - \beta_1)(\alpha + \beta_2 - 2\pi) \cos[(\beta_1 - \beta_2 + 4\pi)M] + (\alpha + \beta_1)(4\pi - \alpha - \beta_2) \cos[(\beta_1 - \beta_2)M] \\
& , \alpha + \beta_1 \leq 2\pi \text{ and } \alpha + \beta_2 > 2\pi \\
& \left[(\alpha + \beta_1 - 2\pi)(\alpha + \beta_2) + (4\pi - \alpha - \beta_1)(2\pi - \alpha - \beta_2) \right] \cos[(\beta_1 - \beta_2 - 2\pi)M] \\
& + (\alpha + \beta_1 - 2\pi)(2\pi - \alpha - \beta_2) \cos[(\beta_1 - \beta_2 - 4\pi)M] + (4\pi - \alpha - \beta_1)(\alpha + \beta_2) \cos[(\beta_1 - \beta_2)M] \\
& , \alpha + \beta_1 > 2\pi \text{ and } \alpha + \beta_2 \leq 2\pi \\
& \left\{ 4 \sin^2(\pi M) [(\alpha + \beta_1)(\alpha + \beta_2) - \pi(6\alpha + 3\beta_1 + 3\beta_2 - 8\pi)] + 4\pi^2 \right\} \cos[(\beta_1 - \beta_2)M] \\
& + 2\pi(\beta_1 - \beta_2) \sin(2\pi M) \sin[(\beta_1 - \beta_2)M], \alpha + \beta_1 > 2\pi \text{ and } \alpha + \beta_2 > 2\pi
\end{aligned} \right. .
\end{aligned}$$

(D8)

References

- [1] D. N. Klyshko, A. N. Penin, and B. F. Polkovnikov, JETP lett. **11**, 05 (1970)
- [2] D. C. Burnham, and D. L. Weinberg, Physical Review Letters **25**, 84 (1970)
- [3] J. Bell, Physics **1**, 195 (1964)
- [4] J. F. Clauser, M. A. Horne, A. Shimony, and R. A. Holt, Physical Review Letters **23**, 880 (1970)
- [5] P. G. Kwiat, K. Mattle, H. Weinfurter, A. Zeilinger, A. V. Sergienko, and Y. H. Shih, Physical Review Letters **75**, 4337 (1995)
- [6] T. Yarnall, A. F. Abouraddy, B. E. A. Saleh, and M. C. Teich, Physical Review Letters **99**, 170408 (2007)
- [7] B. Jack, J. Leach, J. Romero, S. Franke-Arnold, M. Ritsch-Marte, S. M. Barnett, and M. J. Padgett, Physical Review Letters **103**, 083602 (2009)
- [8] J. Leach, B. Jack, J. Romero, M. Ritsch-Marte, R. W. Boyd, A. K. Jha, S. M. Barnett, S. Franke-Arnold, and M. J. Padgett, Opt. Express **17**, 8287 (2009)
- [9] R. Fickler, R. Lapkiewicz, W. N. Plick, M. Krenn, C. Schaeff, S. Ramelow, and A. Zeilinger, Science **338**, 640 (2012)
- [10] M. Padgett, J. Courtial, and L. Allen, Phys. Today **57**, 35 (2004)
- [11] A. M. Yao, and M. J. Padgett, Adv. in Opt. and Photon. **3**, 161 (2011)
- [12] A. Mair, A. Vaziri, G. Weihs, and A. Zeilinger, Nature **412**, 313 (2001)
- [13] H. D. Pires, H. C. B. Florijn, and M. P. van Exter, Physical Review Letters **104**, 020505 (2010)
- [14] H.-C. Huang, **1804.09437**, (2018)
- [15] D. Collins, N. Gisin, N. Linden, S. Massar, and S. Popescu, Physical Review Letters **88**, 040404 (2002)
- [16] A. C. Dada, J. Leach, G. S. Buller, M. J. Padgett, and E. Andersson, Nature Phys. **7**, 667 (2011)
- [17] J. Leach, M. R. Dennis, J. Courtial, and M. J. Padgett, New Journal of Physics **7**, 55 (2005)
- [18] S. S. R. Oemrawsingh, A. Aiello, E. R. Eliel, G. Nienhuis, and J. P. Woerdman, Physical Review Letters **92**, 217901 (2004)
- [19] S. S. R. Oemrawsingh, X. Ma, D. Voigt, A. Aiello, E. R. Eliel, G. W. 't Hooft, and J. P. Woerdman, Physical Review Letters **95**, 240501 (2005)
- [20] M. V. Berry, J. Opt. A: Pure. Appl. Opt. **6**, 259 (2004)
- [21] J. B. Gotte, S. Franke-Arnold, R. Zambrini, and S. M. Barnett, J. Mod. Opt. **54**, 1723 (2007)
- [22] S. N. Khonina, A. P. Porfirev, and A. V. Ustinov, Journal of Optics **17**, 125607 (2015)
- [23] L. Allen, M. W. Beijersbergen, R. J. C. Spreeuw, and J. P. Woerdman, Phys. Rev. A **45**, 8185 (1992)

- [24] J. Leach, M. J. Padgett, S. M. Barnett, S. Franke-Arnold, and J. Courtial, *Physical Review Letters* **88**, 257901 (2002)
- [25] H. H. Arnaut, and G. A. Barbosa, *Physical Review Letters* **85**, 286 (2000)
- [26] E. R. Eliel, S. M. Dutra, G. Nienhuis, and J. P. Woerdman, *Physical Review Letters* **86**, 5208 (2001)
- [27] H. H. Arnaut, and G. A. Barbosa, *Physical Review Letters* **86**, 5209 (2001)
- [28] S. Franke-Arnold, S. M. Barnett, M. J. Padgett, and L. Allen, *Phys. Rev. A* **65**, 033823 (2002)
- [29] A. Garuccio, and V. A. Rapisarda, *Nuovo Cimento Soc. Ital. Fis.* **65A**, 269 (1981)
- [30] J. F. Clauser, and M. A. Horne, *Phys. Rev. D* **10**, 526 (1974)