

TO THE ISOTOPY CLASSIFICATION OF MORSE POLYNOMIALS OF DEGREE 3 IN \mathbb{R}^3

V.A. VASSILIEV

ABSTRACT. We introduce a (conjecturally complete) topological invariant of isotopy classes of Morse polynomials $\mathbb{R}^3 \rightarrow \mathbb{R}^1$ of degree 3 with non-degenerate principal homogeneous part, calculate all 36 possible values of this invariant, and realize them all (except one) by real polynomials, at which these values are taken.

We also demonstrate many examples of non-typical adjacencies of multisingularity classes (namely, the pairs of simple function singularities with the sum of the Milnor numbers equal to 8) to singularities of class P_8 , which break the equisingularity of bifurcation sets of functions along the $\mu = \text{const}$ stratum of type P_8 . At the same time, we prove the non-existence of many other such adjacencies.

These results are obtained with the help of a combinatorial computer program formalizing Morse surgeries, local monodromy and the Picard-Lefschetz theory, which I promote and recommend to the readers.

Keywords: real algebraic geometry, Morse function, vanishing cycle, topological invariant

1. INTRODUCTION

1.1. **Preliminary remarks.** In local bifurcation theory, discriminants and caustics (i.e., the sets of functions with a singular zero level set and, respectively, non-Morse critical points), as well as complementary sets of non-degenerate functions, are considered in parallel and in close relation to each other, see e.g. [2], [3]. On the contrary, the classification problem of real polynomials with non-singular zero level sets is very popular since the 16th Hilbert problem, while the similar study of Morse polynomials is in its beginning. For one of first step in this direction, see the works [5], [4] containing some estimates of the numbers of possible topological types of strictly Morse polynomials.

A regular study of isotopy classes of Morse polynomials of degree ≤ 4 in the affine plane, conjecturally containing their complete enumeration, is carried in [12]. Now we go to the next dimension and consider the space of degree 3 polynomials in \mathbb{R}^3 with non-degenerate principal homogeneous parts. This space is divided into two connected subsets according to the number of components of the cubic curves in

2020 *Mathematics Subject Classification.* Primary: 14P99. Secondary: 14Q30, 14B07, 32S15.

This work was supported by the Absorption Center in Science of the Ministry of Immigration and Absorption of the State of Israel .

$\mathbb{R}P^2$ defined by these principal parts. We call the polynomials with one (respectively, two) such components *polynomials of type* Ξ_1 (respectively, Ξ_2).

Each of these two subsets is further separated into several connected components by the variety of non-Morse polynomials. Our main goal is the separation and enumeration of these components.

The principal homogeneous part of any such polynomial can be reduced by a linear transformation of \mathbb{R}^3 to the normal form

$$(1) \quad x^3 + y^3 + z^3 - \lambda xyz, \quad \lambda \neq 3;$$

Indeed, it has this form in a coordinate system such that three lines $\{x = 0\}$, $\{y = 0\}$ and $\{z = 0\}$ in $\mathbb{R}P^2$ are tangent to the curve of zeros of this homogeneous polynomial at three its inflection points. The parameter λ in (1) is above (respectively, below) 3 for polynomials of type Ξ_1 (respectively, Ξ_2). Also we will use the Newton–Weierstrass normal form

$$x^3 + axz^2 + bz^3 - y^2z$$

of these homogeneous parts, where the polynomial $t^3 + at + b$ has one simple real root for polynomials of type Ξ_1 and three roots for Ξ_2 .

1.2. Morse complex. Any polynomial of type Ξ_1 or Ξ_2 has at most eight real critical points: the sum of Milnor numbers of all its critical points in \mathbb{C}^3 is equal to 8.

For all Morse polynomials of type Ξ_1 , the Morse complex defined by its critical points is acyclic. In other words, if A (respectively, B) is a real number below (respectively, above) all real critical values of such a polynomial f , then the relative homology group $H_*(f^{-1}((-\infty, B]), f^{-1}((-\infty, A]))$ is trivial in all dimensions. Indeed, these homology groups are the same for all f from the connected set of type Ξ_1 polynomials, which contains in particular the polynomials

$$(2) \quad x^3 + y^3 + z^3 + \varepsilon(x + y + z),$$

having no real critical points if $\varepsilon > 0$.

For Morse polynomials of type Ξ_2 , the Morse complex has two non-trivial homology groups, $H_1 \simeq H_2 \simeq \mathbb{Z}$, in particular any such polynomial has at least one critical point of Morse index 1 and one of index 2.

The simplest invariant of connected components of the space of Morse polynomials with non-degenerate principal homogeneous part is as follows.

Definition 1. The *passport* of a Morse polynomial $\mathbb{R}^3 \rightarrow \mathbb{R}$ is the set of numbers of its critical points with Morse index 0, 1, 2 and 3.

For example, the passport of the polynomial (2) is equal to $(0, 0, 0, 0)$ if $\varepsilon > 0$ and to $(1, 3, 3, 1)$ if $\varepsilon < 0$.

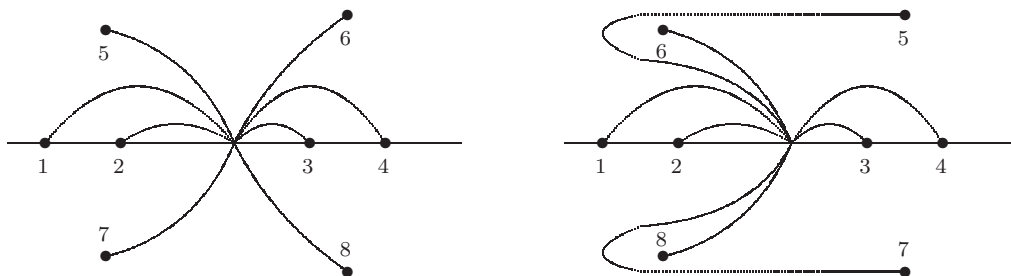

FIGURE 1. Standard systems of paths

We will see below that this invariant is not sufficient to separate all components of the space of degree three Morse polynomials. In the next two subsections we introduce some much stronger invariants.

1.3. Virtual morsifications and set-valued invariants.

Definition 2. A polynomial $\mathbb{R}^3 \rightarrow \mathbb{R}$ is *generic* if its principal homogeneous part defines a smooth curve in $\mathbb{C}P^2$, the polynomial is *strictly Morse* in \mathbb{C}^3 (i.e. it has only Morse critical points, all of whose critical values are different), and additionally all its critical values are not equal to 0.

If f is a generic polynomial of degree 3, then the set $V_f \equiv f^{-1}(0) \subset \mathbb{C}^3$ is a smooth complex surface homotopy equivalent to the wedge of eight two-dimensional spheres (see e.g. [7], [2]). The homology group $H_2(V_f)$ is generated by *vanishing cycles* (see [2], [8]) defined by some paths in \mathbb{C} , connecting the non-critical value 0 with all critical values of f . We choose these paths and the orientations of vanishing cycles in some standard way, see §V.1.6 of [8] or [10]. However, if the number of pairs of non-real critical values is greater than 1 then the choice of these systems of paths is not unique, see Fig. 1.

Definition 3. A *virtual Morse function* associated with a degree 3 generic Morse polynomial $f : (\mathbb{C}^3, \mathbb{R}^3) \rightarrow (\mathbb{C}, \mathbb{R})$ is a collection of its topological data consisting of

- the 8×8 matrix of intersection indices in V_f of canonically ordered and oriented 2-dimensional vanishing cycles $\Delta_i \in H_2(V_f)$ corresponding to all critical values of f ,
- the string of eight intersection indices in V_f of these vanishing cycles with the naturally oriented set of real points, $V_f \cap \mathbb{R}^3$;
- the string of *parities* of Morse indices of all real critical points of f , ordered by the increase of their critical values, and
- the number of negative real critical values of f .

See the matrix (10) on page 14 for a sample virtual Morse function of type Ξ_1 with six real critical points.

Remark 1. This definition differs from the one used in [12] in one place: we use here only the parities of Morse indices, and not these indices themselves.

If the number of pairs of imaginary critical values is greater than 1 then there can be more than one virtual Morse function associated with the same real polynomial.

Definition 4. *Elementary surgeries* of virtual Morse functions include six transformations of their data, modeling the generic topological surgeries of the corresponding real Morse polynomials, namely

- 1, 2 collision of two neighboring real critical values (after which corresponding two critical points either meet and go into the complex domain, or change the order in \mathbb{R}^1 of their critical values),
- 3, 4 collision of two complex conjugate critical values at a point of the line \mathbb{R}^1 (after which corresponding critical points of f_λ either meet at a real point and come to the real space, or miss one another, while the imaginary parts of their critical values change their signs),
- 5, 6 jumps of real critical values up or down through 0;
and additionally
- 7 specifically virtual transformations within the classes of virtual Morse functions associated with the same real Morse polynomials, caused by changes of standard systems of paths going from 0 to imaginary critical values (see Fig. 1).

Any of these surgeries changes the virtual Morse data in a unique way. The explicit formulas for them are given in §V.8 of [8]. These changes are called the *virtual surgeries* of virtual Morse functions.

Unfortunately, there is no absolute coincidence between virtual and real surgeries. Namely, if the critical values of a real function can collide then the intersection index of corresponding vanishing cycles necessarily satisfies some conditions. For example, if the collision of two complex conjugate critical values happens in a real point not separated from 0 by other critical values then this intersection index should be either 0 (and then the corresponding critical points miss each other) or ± 1 (and then these critical points come into the real domain, and the parities of their Morse indices can be predicted by the sign of this index ± 1). Dealing with virtual Morse functions and surgeries, we accept these *necessary* conditions on the intersection indices also as *sufficient*, and allow the appropriate virtual surgery any time when the intersection index is equal to 0, 1 or -1 .

However, there is no guarantee that the critical values of a real polynomial indeed can be collided by a one-parametric deformation any time when some of these conditions are satisfied. For example, if the intersection index of two cycles is equal to 0, it does not guarantee that these cycles can be geometrically separated by homotopies. So, the world of virtual Morse functions and their virtual surgeries is not a complete reflection of the real one; still it gives a lot of useful information on its real analog.

Definition 5. An (abstract) *virtual Morse function* of type Ξ_1 or Ξ_2 is any collection of data obtained from a virtual function associated with a real polynomial of this type by an arbitrary chain of virtual surgeries.

A *virtual component* of the set of all virtual Morse functions of type Ξ_1 or Ξ_2 is any subset of this set, all whose elements can be obtained from each other by chains of surgeries not including the virtual model of the collision of critical points, i.e. surgeries 1 and 3 from Definition 4 (but including surgeries 2 and 4, i.e. the collision of critical values not related with the collision of corresponding critical points).

Proposition 1. *The set of all virtual Morse functions of type Ξ_1 or Ξ_2 contains all virtual Morse functions associated with any real polynomials of this type.*

If two real Morse polynomials belong to the same connected component of the set of Morse polynomials, then any virtual Morse functions associated with them belong to the same virtual component.

The first statement follows from the connectedness of the spaces of all polynomials of type Ξ_1 or Ξ_2 : any two real Morse polynomials from each of them can be connected by a path in this space intersecting the variety of non-Morse polynomials in finitely many points corresponding to standard surgeries. The second statement follows immediately from the construction. \square

Definition 6. The *set-valued invariant* of a generic real Morse polynomial is the entire virtual component of an arbitrary virtual Morse function associated with it.

The invariant *Card* of a generic real Morse polynomial is the cardinality of this virtual component.

In the most interesting and complicated case of polynomials, all whose critical points are real. The set-valued invariant has the following more transparent interpretation.

1.4. *D-graph invariant.* The matrix of intersection indices $\langle \Delta_i, \Delta_j \rangle$ of vanishing cycles $\Delta_i, \Delta_j \in H_2(V_f)$ can be depicted by the *Coxeter-Dynkin graph* (see e.g. [2], [8]). Its vertices correspond to these vanishing cycles, and the i th and j th vertices are connected by $\langle \Delta_i, \Delta_j \rangle$ solid segments if this intersection index is positive, and by $-\langle \Delta_i, \Delta_j \rangle$ dashed segments if it is negative.

Definition 7. The *D-graph* of a generic Morse polynomial, all of whose critical points are real, is the Coxeter-Dynkin graph of corresponding vanishing cycles, all whose edges are oriented from the vertex corresponding to a critical point with the greater critical value to that with the lower value; all vertices corresponding to critical points with even (respectively, odd) Morse indices are depicted by black (respectively, white) circles, and after all the numbering of vertices of the Coxeter-Dynkin graph (assumed in its definition) is forgotten.

See Figs. 2–6 and 8–11 on pages 10–12 and 16–18 below for examples of D -graphs. Obviously, the D -graph of a Morse polynomial with only real critical points is determined by the associated virtual Morse function.

Proposition 2 (see [12]). *1. In the case of polynomials with only real critical values, the D -graph invariant is equivalent to the set-valued invariant of Definition 6: any two real Morse polynomials have equal values of one of these invariant if and only if they have equal values of the other.*

2. The elements of any virtual component containing virtual Morse functions with only real critical points are in 1-1 correspondence with continuations of the partial order of vertices of the corresponding D -graph (defined by the orientation of its edges) to the complete order. \square

All virtual components of the set of virtual Morse functions of types Ξ_1 and Ξ_2 have been enumerated by the computer program working in the terms of virtual functions and surgeries. This program is described in Chapter V of [8] (the specific details related with the study of components of the space of Morse polynomials are outlined in [12]) and is available by [13].

Namely, there are 20 virtual components of type Ξ_1 and 16 of type Ξ_2 . In §§ 2, 3 we describe the results of this calculation and realize (in all cases except for only one) these virtual components by real polynomials associated with some their elements. The D -graphs of the found virtual components turned out to be a powerful hint for constructing these realizing examples.

In what follows we mark with the sign \otimes the statements obtained by computer calculations.

Main Conjecture. *1. There are exactly 20 (respectively, 16) connected components of the space of Morse polynomials of class Ξ_1 (respectively, Ξ_2); all of them are separated by the set-valued invariant of Definition 6.*

2. For any complete order of vertices of a D -graph, compatible with the partial order defined by the orientation of its edges, there exists a strictly Morse polynomial of corresponding type Ξ_1 or Ξ_2 with this D -graph invariant, for which this complete order coincides with the order of corresponding critical values in \mathbb{R} . In particular, the number of connected components of the set of strictly Morse polynomials within the class of Morse polynomials with this D -graph is estimated from below by its Card invariant.

1.5. Splitting of function singularities of P_8 type. A large part of our examples is related with polynomials of type Ξ_1 or Ξ_2 having two real critical points, the sum of whose Milnor numbers is equal to eight. These polynomials have an interpretation in the singularity theory of smooth functions as obstructions to the equisingularity of bifurcation sets along $\mu = \text{const}$ strata. Indeed, let f be a polynomial of class Ξ_1 or Ξ_2 with such a pair of critical points. These critical points are necessarily *simple* in the terminology of [2], because all singularities with Milnor number below eight

are simple. The one-parametric family of polynomials

$$t^3 f(t^{-1}x, t^{-1}y, t^{-1}z), \quad t \rightarrow +0,$$

all of which have the same homogeneous part of degree 3, tends then to a function with singularity of type P_8 at the origin (defined by this homogeneous polynomial).

The set $\{P_8\}$ of functions with P_8 singularities has the same codimension in the space of all functions, as the set of functions having two simple critical points with the sum of Milnor numbers equal to eight. Therefore the functions of class P_8 , which can be approached by the latter set, constitute a subset of positive codimension in the entire set $\{P_8\}$. This property is invariant under the equivalences of function germs, therefore it is satisfied for only finitely many values of the module λ of the normal form (1). Therefore the stratification of the function space (according to the singularity types of their critical points) behaves at these points of the set $\{P_8\}$ in some exceptional way compared to the generic points of this set.

At the same time, the analysis of the list of D-graphs provided by the computer calculation allows us to prove the absence of many such splittings of P_8 singularities (or, equivalently, of polynomials of type Ξ_1 or Ξ_2 with certain pairs of critical points). We will prove below the following two theorems.

Theorem 1. *There exist polynomials of type Ξ_1 having the following pairs of real critical points:*

- (1) $D_4^+ + D_4^+$,
- (2) $D_4^- + D_4^-$,
- (3) $E_6 + A_2$,
- (4) $D_5 + A_3$.

There do not exist polynomials of type Ξ_1 having the following pairs of real critical points:

- (1) $A_5 + A_3$,
- (2) $A_4 + D_4^+$,
- (3) $D_6^+ + A_2$.

Conjecture 1. *There exist also polynomials of type Ξ_1 with a pair of real critical points of type A_4 .*

Theorem 2. *There exist polynomials of type Ξ_2 having the following pairs of real critical points:*

- (1) $A_5 + A_3$,
- (2) $D_5 + A_3$.

There do not exist polynomials of type Ξ_2 having the following pairs of real critical points:

- (1) $D_4^+ + D_4^+$,
- (2) $A_4 + A_4$,

- (3) $A_4 + D_4^+$,
- (4) $D_4^- + D_4^-$,
- (5) $E_6 + A_2$,
- (6) $D_6^+ + A_2$.

Remark 2. In addition to Theorems 1 and 2, the polynomials of classes Ξ_1 or Ξ_2 with multisingularities $D_4^- + D_4^+$, $D_4^- + A_4$ and $D_6^- + A_2$ are prohibited by the Euler characteristic consideration. Indeed, by § 1.2 the sum of local indices of the gradient vector field at all critical points of any polynomial of class Ξ_1 or Ξ_2 is equal to 0. These local indices for D_{2k}^- singularities are equal to 2 or -2 depending on their quadratic parts, and are equal to 0 for D_{2k}^+ and A_{2k} .

Almost all D-graphs realized below are related with some such polynomials with a pair of critical points, the sum of whose Milnor numbers is equal to eight. These D-graphs split somehow into Coxeter–Dynkin graphs of these critical points. A very similar splitting of the D-graph of Fig. 6 (see page 12) into two graphs of type A_4 is the source of Conjecture 1.

But the most intriguing is the D-graph of Fig. 10 containing in an analogous way the Dynkin graph  of a non-existing singularity.

1.6. **Involution.** The involution

$$(3) \quad f(x, y, z) \mapsto -f(-x, -y, -z)$$

acts on both spaces Ξ_1 and Ξ_2 preserving the sets of Morse polynomials and the principal homogeneous parts.

In the case of Morse polynomials with only real critical points, the D-graphs of two polynomials related by this involution are obtained from one another by reversing the orientations of all edges and changing the colors of all vertices.

Also, this involution can be uniquely extended to the set of abstract virtual Morse functions. It preserves the intersection indices of vanishing cycles and reverses the order of critical values and the origin in \mathbb{R} .

1.7. **Independent perturbations of critical points.** We say that two function germs (φ, a) and (ψ, b) are *equivalent*, if there is a local diffeomorphism $T : (\mathbb{R}^3, a) \rightarrow (\mathbb{R}^3, b)$ of the argument space such that $\varphi \equiv \psi \circ T$ in a neighborhood of the point a .

The space of all polynomials of class Ξ_1 (respectively, Ξ_2) is a versal deformation of an arbitrary polynomial of class P_8^1 (respectively, P_8^2). Therefore for any polynomial of this class having several critical points, any collection of its perturbations in the neighborhoods of these points can be realized (up to a set of local equivalences in these neighborhoods) by a common perturbation of our polynomial in the corresponding class Ξ_1 or Ξ_2 .

TABLE 1. Numbers of virtual Morse functions of Ξ_1 type

No. of real points	0	2	4	6	8	Total
No. of virtual functions	297	390	515	1512	3789	6503

2. POLYNOMIALS OF TYPE Ξ_1

Proposition 3. *There are exactly 6503 virtual Morse functions associated with generic real polynomials $\mathbb{R}^3 \rightarrow \mathbb{R}$ of type Ξ_1 or obtained from such associated virtual Morse functions by chains of virtual surgeries. The numbers of these virtual Morse functions with different numbers of real critical points are shown in Table 1. \circledast*

The sets of these virtual Morse functions will be considered in the next five subsections.

Remark 3. It is not surprising that the number of virtual Morse functions with exactly k real critical points is always divisible by $k + 1$: any such virtual function is accompanied by k others, which differ from it only by the number of the negative critical values. Moreover, the same is obviously true for all values of the Card invariant.

2.1. Polynomials with eight critical points.

Proposition 4. *The set of all 3789 virtual Morse functions of class Ξ_1 with eight real critical points consists of exactly seven virtual components:*

- one of cardinality 54 with D-graph shown in Fig. 2;
- two of cardinality 432: the D-graph of one of them is shown in Fig. 3, and that of the other is obtained from it by the involution from §1.6;
- one of cardinality 72 with D-graph shown in Fig. 4;
- two of cardinality 783: the D-graph of one of them is shown in Fig. 5, and that of the other is obtained from it by the involution from §1.6;
- one of cardinality 1233 with D-graph shown in Fig. 6.

\circledast

In the rest of this subsection we realize all these D-graphs except for the last one by real polynomials.

2.1.1. Realization of Figs. 2–4. The homogeneous polynomial

$$(4) \quad x^3 - xy^2 + z^3$$

is of type Ξ_1 , i.e. its zero curve in $\mathbb{R}P^2$ consists of one component. Indeed, its perturbation by adding εz , $\varepsilon > 0$, has no real critical points, which is impossible for Ξ_2 polynomials, see § 1.2. On the other hand, it is easy to check that it has an isolated singularity at the origin.

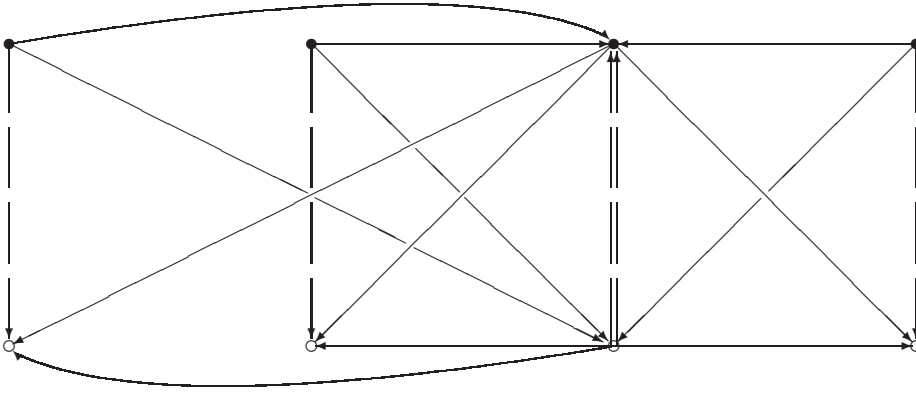
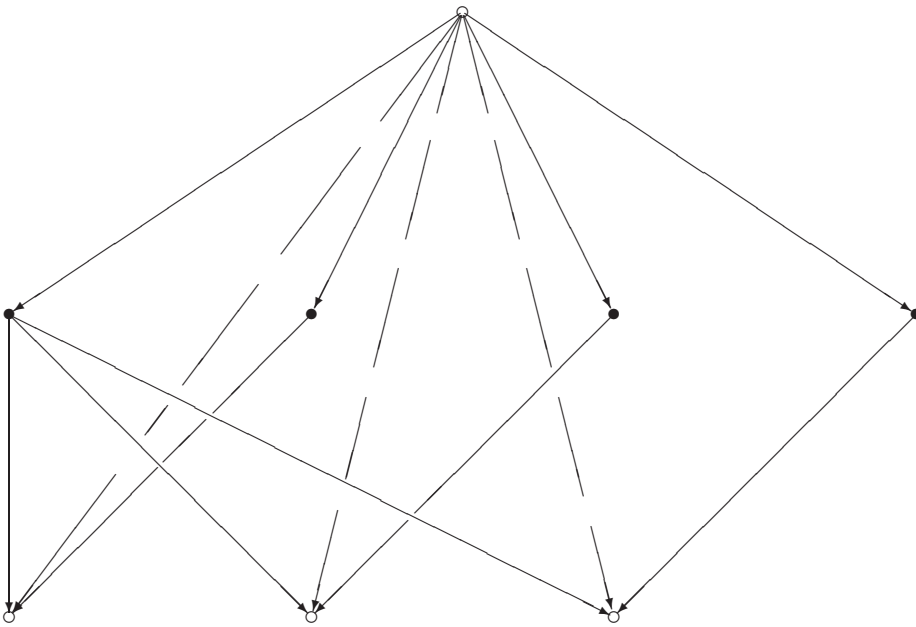
FIGURE 2. $D_4^- + D_4^-$, Card = 54FIGURE 3. Other side of $D_4^- + D_4^-$, and also of $E_6 + A_2$; Card = 432

Another its perturbation,

$$(5) \quad x^3 - xy^2 + z^3 - 3\epsilon z, \quad \epsilon > 0,$$

has two critical points of the class D_4^- . In a neighborhood of one of them our polynomial is equivalent to

$$(6) \quad x^3 - xy^2 - 2\epsilon^{3/2} + \tilde{z}^2,$$

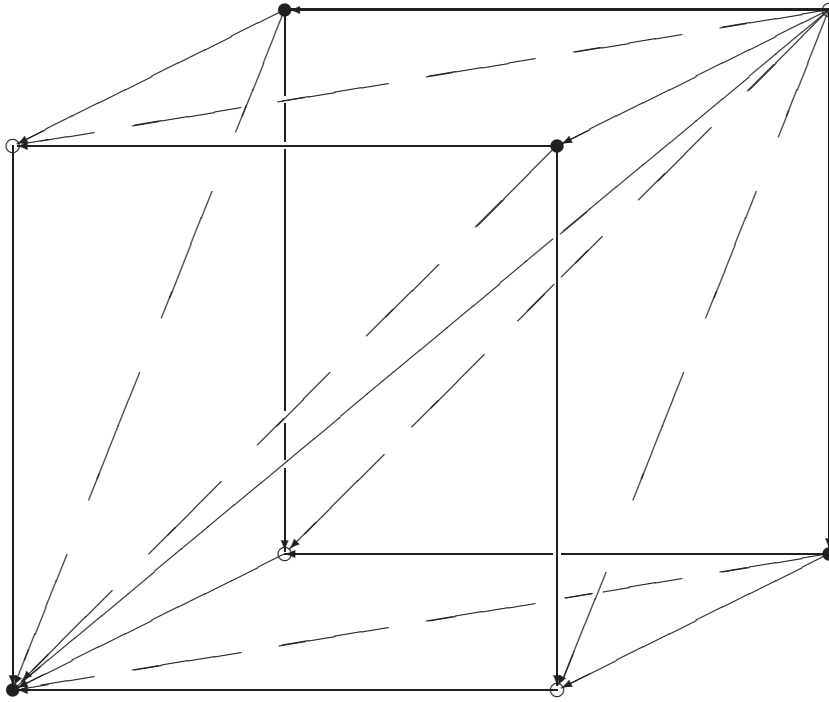

FIGURE 4. $D_4^+ + D_4^+$ and $D_5 + A_3$, and the last side of $D_4^- + D_4^-$; Card = 72

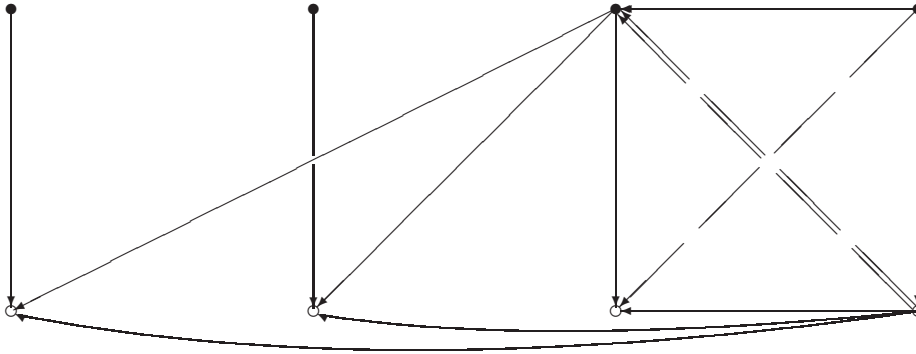

FIGURE 5. $783 E_6 + A_2$, Card = 783

and in a neighborhood of the other to

$$(7) \quad x^3 - xy^2 + 2\varepsilon^{3/2} - \tilde{z}^2.$$

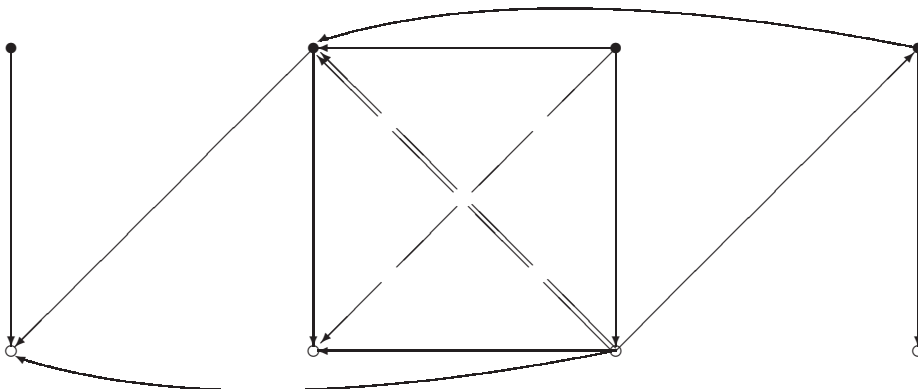



FIGURE 6. 1233 Virtual Morse function with Card = 1233, conjecturally related with the multisingularity $A_4 + A_4$

Each of these two critical points can be further split by a small perturbation to four Morse critical points. These points arising from the critical point of type (6) are three points of Morse index 1 and one point of Morse index 0 or 2 depending on the perturbation. The points arising from the critical point of type (7) are three points with Morse index 2 and one point of index 1 or 3. So, combining properly these perturbations we can obtain Morse polynomials with any of four passports $(0, 4, 4, 0)$, $(0, 3, 4, 1)$, $(1, 3, 3, 1)$, and $(1, 4, 3, 0)$.

Proposition 5. *The D-graphs of these four polynomials with passports $(0, 4, 4, 0)$, $(0, 3, 4, 1)$, $(1, 3, 3, 1)$, $(1, 4, 3, 0)$ are respectively the D-graphs shown in Figs. 2, 3, 4, and obtained from Fig. 3 by the involution described in §1.6.*

Proof. In all cases, the matrix of intersection indices of four vanishing cycles arising from either of critical points (6) or (7) is depicted by the standard Coxeter–Dynkin

graph  of type D_4 . Therefore, for each of these four polynomials one can separate the set of vertices of the corresponding D-graph into two subsets of cardinality four in such a way that removing all edges connecting vertices from different sub-

sets we split the D-graph into two graphs  (supplied with some orientation of edges and coloring of vertices depending on the choice of perturbations). The D-graphs of Figs. 5 and 6 do not have such splittings.

For each of four D-graphs from Figs. 2, 3, 4 and the up-down reflection of Fig. 3, the desired splitting of the set of its vertices into two graphs of type D_4 is unique, and the correspondence between these D-graphs and four polynomials constructed above follows from the orientation of edges in each of these subgraphs.

2.1.2. *Realization of Fig. 5.* Any polynomial

$$(8) \quad x^2y + y^3 + z^3 + \lambda y^2, \quad \lambda \neq 0,$$

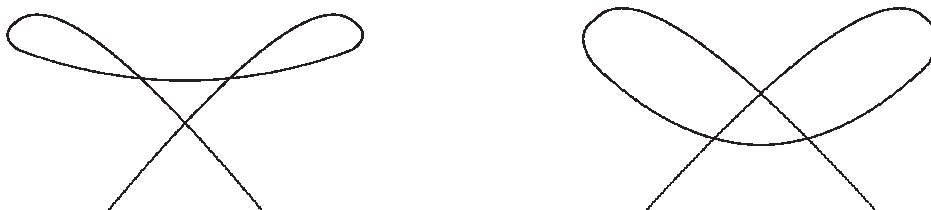
FIGURE 7. Perturbations of E_6 singularity

(which obviously also is of type Ξ_1) has a critical point of type E_6 at the origin, and is there equivalent to the function germ $\tilde{y}^2 - \tilde{x}^4 + z^3$ (if $\lambda > 0$) or $-\tilde{y}^2 + \tilde{x}^4 + z^3$ (if $\lambda < 0$). In both cases such a polynomial has also the critical point $(0, -\frac{2\lambda}{3}, 0)$ of type A_2 , at which it is equivalent to $u^2 - v^2 + z^3 + \frac{4\lambda^3}{27}$. In all cases both these critical points can be simultaneously perturbed as follows: the point of type A_2 splits into one point of Morse index 1 and one of index 2, and the point of type E_6 splits into three Morse points with Morse index 1 and three points of index 2: see Fig. 7 (left) for the corresponding perturbation of the critical point of E_6 type in two variables.

The vertices of the corresponding D-graph admit a splitting into subgraphs with 2 and 6 vertices, which are isomorphic to classical Coxeter–Dynkin graphs of types A_2 and E_6 , and all edges of the D-graph connecting these subgraphs should be directed from A_2 graph to E_6 if $\lambda > 0$ or from E_6 to A_2 if $\lambda < 0$. Among all D-graphs provided by Proposition 4, only the one from Fig. 5 satisfies this property corresponding to $\lambda < 0$, and only the D-graph obtained from this one by the involution described in § 1.6 satisfies this property for $\lambda > 0$. So, these two D-graphs also are realized.

Remark 4. The critical point of type E_6 of the polynomial (8) has also another real perturbation, see Fig. 7 (right). Using this perturbation for the cases of positive and negative λ in (8), we obtain new realizations of the D-graphs shown in Fig. 3 and in its antipode.

2.2. Polynomials with six critical points.

Proposition 6. *The set of all 1512 virtual Morse functions of type Ξ_1 with exactly six real critical points splits into five virtual components: one of cardinality 28, two of cardinality 112 and two of cardinality 630. \otimes*

Let us realize these components. The polynomial

$$(9) \quad x^3 - 3\epsilon x + y^3 - 3\epsilon y + z^3$$

of type Ξ_1 has four critical points of type A_2 . At one of them it is equivalent (up to adding constant functions) to $u^2 + v^2 + z^3$, at another one to $-u^2 - v^2 + z^3$, and at two remaining to $u^2 - v^2 + z^3$. We can perturb these critical points independently, splitting arbitrary three of them into pairs of real critical points, and the remaining

one into two imaginary critical points. Depending on the choice of this remaining point, we get polynomials with passports $(1, 2, 2, 1)$, $(0, 2, 3, 1)$ and $(1, 3, 2, 0)$. The sets of polynomials of two last types are mapped one into the other by the involution (3).

Further, we can take the polynomial (8) and perturb its critical points independently in such a way that the point of type A_2 turns into two imaginary critical points, and the point of type E_6 splits as previously into three real Morse points of index 1 and three points of index 2. Then we for any $\lambda \neq 0$ in (8) obtain a Morse polynomial with passport $(0, 3, 3, 0)$; these polynomials corresponding to negative and positive values of λ are moved into each other by the involution (3).

Proposition 7. *The virtual Morse functions associated with polynomials constructed in the previous paragraph from the polynomials (8) with positive and negative values of λ belong to different virtual components.*

Proof. Such a polynomial can be obtained by a single Morse surgery (namely, the change of the decomposition of the critical point of type A_2) from the polynomial described by D-graph of Fig. 5. In particular, the data of its virtual Morse function (the intersection matrices, the strings of intersection indices with the set of real points, and the strings of parities of their real critical points) can be easily calculated and are as follows:

$$(10) \quad \begin{array}{|cccccccc|} \hline -2 & 0 & 0 & 1 & 0 & 0 & 0 & -1 \\ 0 & -2 & 0 & 1 & 0 & 1 & 1 & 0 \\ 0 & 0 & -2 & 1 & 1 & 0 & 1 & 0 \\ 1 & 1 & 1 & -2 & 0 & 0 & -1 & 1 \\ 0 & 0 & 1 & 0 & -2 & 0 & 0 & 0 \\ 0 & 1 & 0 & 0 & 0 & -2 & 0 & 0 \\ 0 & 1 & 1 & -1 & 0 & 0 & -2 & -1 \\ -1 & 0 & 0 & 1 & 0 & 0 & -1 & -2 \\ \hline 1 & 1 & 1 & 0 & -2 & -2 & -1 & -1 \\ \hline o & o & o & e & e & e & & \\ \hline \end{array}$$

with the number of negative critical values equal to 4.

The computer says us that the virtual component of this virtual function consists of 630 elements. Upon an additional request, it finds all virtual Morse functions in this component such that

- (1) the number of non-zero intersection indices $\langle \Delta_i, \Delta_j \rangle$ with $i < j \leq 6$ (i.e., corresponding to real critical points) is at most 5;
- (2) the number of non-zero intersection indices $\langle \Delta_i, \Delta_j \rangle$ with $i \leq 6$ and $j \in \{7, 8\}$ (i.e., with Δ_i corresponding to a real critical point and Δ_j to imaginary one) is at most 5;
- (3) the number of negative critical values is at most 4.

It turns out that there are exactly six virtual Morse functions in this component satisfying all these conditions, and for all of them the number of negative critical values is equal to exactly four. But the involution from §1.6 preserves two first conditions and permutes negative and positive critical values. In particular it moves all these six virtual Morse functions to functions, which also satisfy the first two conditions but have two negative critical values. Therefore these virtual Morse functions cannot belong to the same virtual component, and two real polynomials associated with them are separated by the set-valued invariant. \square

2.3. Polynomials with four critical points.

Proposition 8. *The set of all 515 virtual Morse functions of type Ξ_1 with exactly four real critical points splits into four virtual components: one of cardinality 30, two of cardinality 60, and one of cardinality 365. \otimes*

Let us realize them. In the polynomial (9) we can split arbitrary two critical points of type A_2 into pairs of real Morse critical points, and remaining two into pairs of imaginary points. Depending on the choice of these A_2 points, the resulting polynomials have passports $(1, 1, 1, 1)$, $(1, 2, 1, 0)$, $(0, 1, 2, 1)$, and $(0, 2, 2, 0)$.

2.4. Polynomials with two critical points.

Proposition 9. *The set of all 390 virtual Morse functions of type Ξ_1 with exactly two critical points splits into three virtual components: two of cardinality 102 and one of cardinality 186. \otimes*

In the perturbation (9) we can split three critical points of type A_2 into pairs of imaginary critical points, and only one into a pair or real Morse critical points. Depending on the choice of this point of type A_2 , the obtained polynomials have passports $(1, 1, 0, 0)$, $(0, 1, 1, 0)$ or $(0, 0, 1, 1)$.

The first and the third cases are obviously symmetric to one another, in particular have the same value of invariant Card.

2.5. Polynomials with no critical points.

Proposition 10. *There is only one virtual component of virtual Morse functions of type Ξ_1 without real critical points. It consists of 297 virtual Morse functions. \otimes*

The corresponding real component can be represented by the polynomial (2), $\varepsilon > 0$.

3. POLYNOMIALS OF TYPE Ξ_2

Proposition 11. *There are exactly 9174 virtual Morse functions associated with generic real polynomials $\mathbb{R}^3 \rightarrow \mathbb{R}$ of type Ξ_2 or obtained from them by chains of virtual surgeries. The numbers of virtual Morse functions with different numbers of real critical points are shown in Table 2. \otimes*

TABLE 2. Numbers of virtual Morse functions of Ξ_2 type

No. of real points	0	2	4	6	8	Total
No. of virtual functions	0	255	650	1897	6372	9174

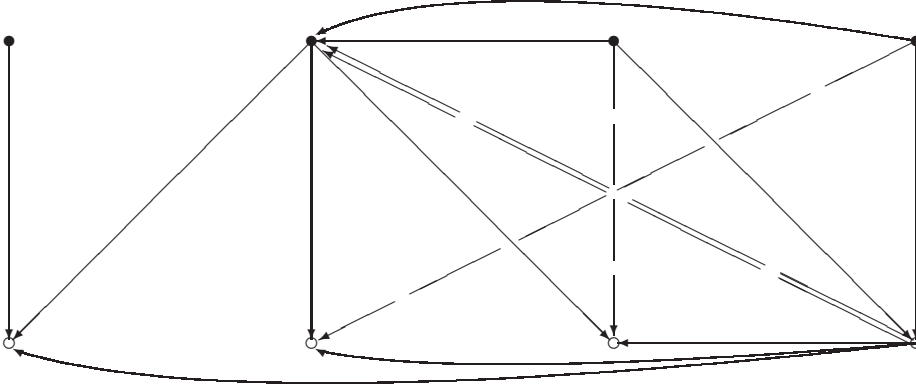
FIGURE 8. $D_5 + A_3$, Card = 324

3.1. Polynomials with eight critical points.

Proposition 12. *The set of all 6372 virtual Morse functions of class Ξ_2 with eight real critical points consists of exactly eight virtual components:*

- one of cardinality 324 with D -graph shown in Fig. 8,
- one of cardinality 504 with D -graph shown in Fig. 9,
- one of cardinality 945 with D -graph shown in Fig. 10,
- one of cardinality 1413 with D -graph shown in Fig. 11,

and four more components of the same four cardinalities with D -graphs obtained from these ones by the involution described in § 1.6. \otimes

3.1.1. *Realization of D -graph of Fig. 8.* For any $\lambda \neq 0$, consider the polynomial

$$(11) \quad x^3 - xz^2 - y^2z + \lambda x^2$$

of type Ξ_2 . Its principal quasihomogeneous part at the origin,

$$(12) \quad \lambda x^2 - xz^2 - y^2z \equiv \lambda \left(x - \frac{z}{2\lambda} \right)^2 - \frac{1}{4\lambda} z^4 - y^2z,$$

is of type D_5 . For $\lambda > 0$ this critical point can be split into three real Morse critical points with Morse index 1 and two points with index 2: see Fig. 12(left) for the zero level set of the corresponding splitting of a D_5 singularity of a function in two variables. The intersection indices of the standard basic vanishing cycles related with these points can be calculated by Gusein-Zade–A’Campo method [1], [6] and

FIGURE 9. Other side of $D_5 + A_3$, Card = 504

FIGURE 10. Card = 945

are depicted by the standard Dynkin graph of D_5 singularity: see the bottom left part of Fig. 12.

For $\lambda < 0$ this D_5 point analogously splits into three critical points of Morse index 2 and two critical points of index 1.

In addition, the polynomial (11) has a critical point with Milnor number 3 and coordinates $(-\frac{2\lambda}{3}, 0, 0)$. In the local coordinates $\tilde{x} \equiv x + \frac{2\lambda}{3}$, y and z centered at

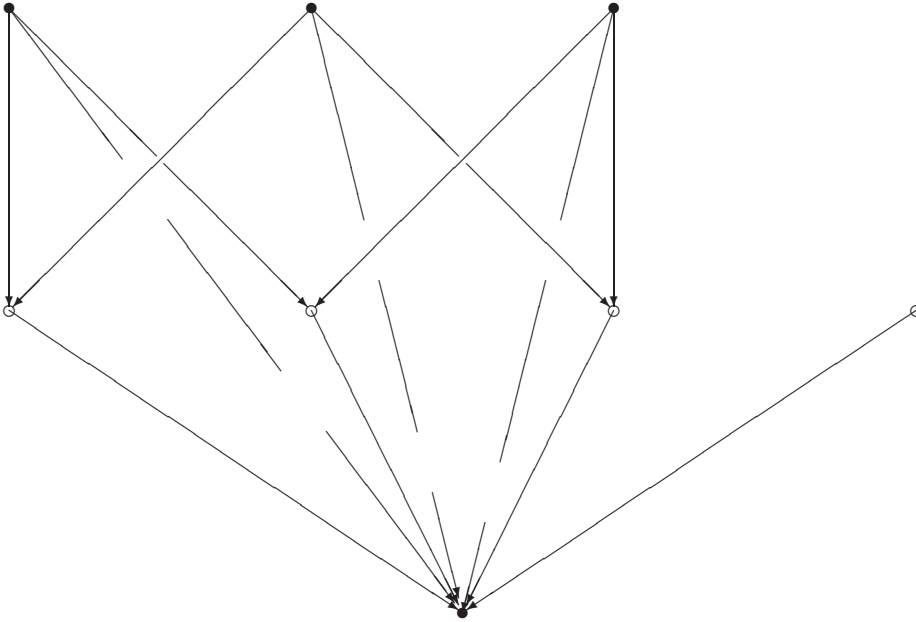
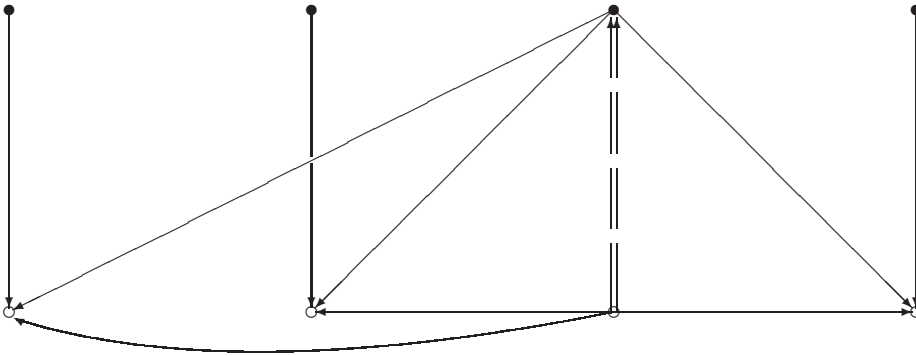
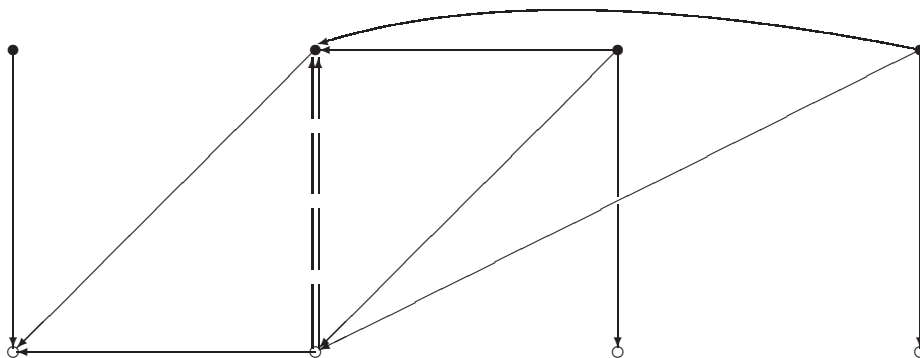
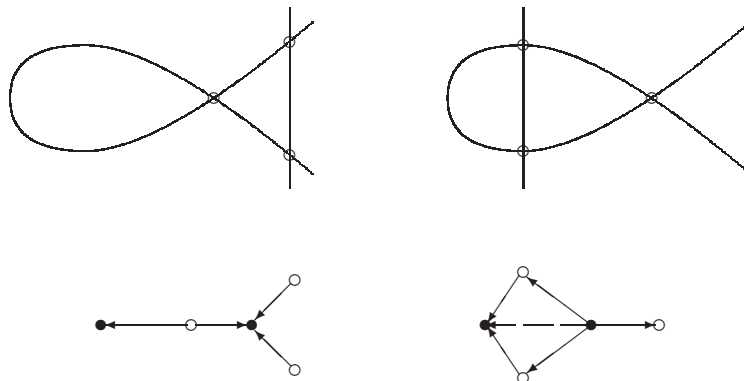
FIGURE 11. $A_5 + A_3$, Card = 1413FIGURE 12. Morsifications of D_5 singularities

this point it is equal to

$$\frac{4\lambda^3}{27} - \lambda\tilde{x}^2 + \frac{2\lambda}{3}z^2 + \tilde{x}^3 - \tilde{x}z^2 - y^2z.$$

The principal quasihomogeneous part of its non-constant part is

$$-\lambda\tilde{x}^2 + \frac{2\lambda}{3}z^2 - y^2z \equiv -\lambda\tilde{x}^2 + \frac{2\lambda}{3}\left(z - \frac{3}{4\lambda}y^2\right)^2 - \frac{3}{8\lambda}y^4,$$

so the germ of our polynomial at this point is locally equivalent to

$$\frac{4\lambda^3}{27} + \lambda(-\tilde{x}^2 + \tilde{z}^2 - \tilde{y}^4).$$

For $\lambda > 0$ it can be split by a small perturbation of our polynomial into two critical points with Morse index 2 and one point with Morse index 1; for $\lambda < 0$ vice versa.

Let us perturb both critical points of the polynomial (11) simultaneously in the described way. For any choice of $\lambda \neq 0$ in (11), the passport of the resulting polynomial is equal to $(0, 4, 4, 0)$. Two Morse polynomials constructed in this way for opposite values of λ can be transformed into one another by the involution (3).

Proposition 13. *The D-graph of the Morse polynomial just constructed is shown in Fig. 8 if $\lambda > 0$, or is obtained from it by the involution described in § 1.6 if $\lambda < 0$.*

Proof. By Proposition 12, D-graph of this polynomial for $\lambda > 0$ must be one of four D-graphs of Figs. 8–11, or of four D-graphs obtained from them by the involution described in § 1.6. By the construction of this polynomial, the set of vertices of this D-graph can be split into two subsets of cardinalities 5 and 3 in such a way that removing all edges with endpoints in different subsets we obtain two separate graphs, namely the canonical Coxeter-Dynkin graphs of types D_5 and A_3 ; moreover all the removed edges are directed from the A_3 -graph to D_5 -graph. The D-graph shown in Fig. 8 admits such a splitting, and the remaining seven D-graphs do not, therefore our polynomial realizes exactly this D-graph. By exactly the same reasons, our polynomial with $\lambda < 0$ realizes the D-graph obtained from Fig. 8 by the involution of § 1.6. \square

3.1.2. *Realization of Fig. 9.* We can perturb the critical point of type D_5 of the polynomial (11) with $\lambda > 0$ in a different way compared with the previous paragraph, see Fig. 12 (right), splitting it into three Morse critical points with Morse index 1, one point with index 0 and one point with index 2. The corresponding Coxeter-Dynkin graph is shown in the right bottom part of Fig. 12.

Perturbing also the A_3 critical point as previously, we obtain a polynomial with passport $(1, 4, 3, 0)$.

Analogously to the proof of Proposition 13, the D-graph of this polynomial can be only the one shown in Fig. 9, and the D-graph of the similar polynomial with $\lambda < 0$ is obtained from Fig. 9 by the involution of § 1.6.

3.1.3. *Realization of Fig. 10.* The D-graph of Fig. 10 is realized in [9]. Namely, consider the polynomial

$$(13) \quad x^3 - xz^2 + y^2z + \lambda z^2$$

of type Ξ_2 . It has a critical point of type E_6 at the origin, and additionally two Morse critical points with Morse indices equal to 1 and 2. The critical values at the last two points are equal to one another and to λ^3 . For $\lambda > 0$, this polynomial has the form $u^3 - v^4 + w^2$ in some local coordinates at the origin. This its critical point can be split into three Morse points with Morse index 1 and three points with index 2. The intersection matrix of vanishing cycles of the corresponding Morse polynomial is calculated in §7 of [9] and is indeed equal to one given by the Coxeter-Dynkin graph of Fig. 10.

Remark 5. These data calculated by hands in [9] are the initial data for entire our computer calculations in the case Ξ_2 .

3.1.4. *Realization of Fig. 11.* Consider the polynomial

$$(14) \quad f = x^3 - 4xz^2 + \frac{80}{27}z^3 - y^2z + z(x - z).$$

It is of type Ξ_2 . Indeed, the polynomial $t^3 - 4t + \frac{80}{27}$ is positive at $t = 0$ and $t \rightarrow +\infty$, but is negative at $t = 1$ and $t \rightarrow -\infty$.

This polynomial (14) has critical points at the origin and at the point $(\frac{1}{4}, 0, \frac{3}{8})$. Its Taylor decomposition in the local coordinates $\tilde{x} \equiv x - \frac{1}{4}, y$ and $\tilde{z} \equiv z - \frac{3}{8}$ at the latter point is equal to

$$-\frac{1}{64} + \frac{3}{4} \left(\tilde{x} - \frac{4}{3}\tilde{z} \right)^2 - \frac{3}{8}y^2 + \tilde{x}^3 - 4\tilde{x}\tilde{z}^2 + \frac{80}{27}\tilde{z}^3 - y^2\tilde{z}.$$

The substitution $X = \tilde{x} - \frac{4}{3}\tilde{z}$ turns it to the form

$$-\frac{1}{64} + \frac{3}{4}X^2 - \frac{3}{8}y^2 + X \left(X^2 + 4X\tilde{z} + \frac{4}{3}\tilde{z}^2 \right) - y^2\tilde{z}.$$

The principal quasihomogeneous part of this function germ (less the constant $-\frac{1}{64}$) is equal to

$$\frac{3}{4}X^2 - \frac{3}{8}y^2 + \frac{4}{3}X\tilde{z}^2 \equiv \frac{3}{4} \left(X + \frac{8}{9}\tilde{z}^2 \right)^2 - \frac{3}{8}y^2 - \frac{16}{27}\tilde{z}^4,$$

so it is of type A_3 . A small perturbation can split this critical point into two Morse critical points with Morse index 2 and one with Morse index 1.

Further, it is easy to calculate that the multiplicity of the system of equations $df = 0$ at the origin (i.e. the Milnor number of f at this point) is at least 5. Indeed, this system contains the equation $\frac{\partial f}{\partial y} \equiv -2yz = 0$. Substituting its solution $z = 0$ to the other two equations, we get a system, all whose four solutions are placed at the origin; also the result of the substitution of the solution $y = 0$ has at least one solution there.

On the other hand, the Milnor number of f at the origin is also at most 5, because the sum of Milnor numbers of all critical points in \mathbb{C}^3 of any polynomial of type Ξ_2 is equal to 8. The rank of this critical point is obviously equal to 2, hence this is a point of type A_5 . The Morse critical points obtained by any its morsification can have only Morse indices 1 and 2 because the quadratic part of f has signature $(1, 1)$. The number of all critical points with even Morse indices of any morsification of f is equal to the number of such points with odd indices (because the total index of the vector field $\text{grad } f$ in \mathbb{R}^3 is equal to 0), therefore any splitting of this A_5 singularity into five Morse critical points has three points with Morse index 1 and two points of index 2.

Proposition 14. *The D-graph of the obtained Morse polynomial is shown in Fig. 11.*

Proof. Among all four D-graphs shown in Figs. 8–11 and their involutions described in § 1.6, only the D-graph of Fig. 11 admits a splitting of the set of its vertices into the subsets of cardinalities 5 and 3 in such a way that the interior subgraphs of these subsets are of types A_3 and A_5 , and additionally all edges of the D-graph connecting these subsets are directed from the A_5 subset to A_3 . \square

3.2. Polynomials with six critical points.

Proposition 15. *The set of all 1897 virtual Morse functions of type Ξ_2 with exactly six real critical points splits into four virtual components: two of cardinality 140, one of cardinality 665 and one of cardinality 952. \otimes*

Let us realize these components. We can perturb the critical point of type D_5 of the polynomial (11) with $\lambda > 0$ into a Morse polynomial having two critical points with Morse index 1, one point of index 2 or 0 for our choice, and two imaginary critical points (see e.g. [11], §4.3). Perturbing also the point of type A_3 of the same polynomial into three real Morse critical points (two of which necessarily have Morse index 2 and the third one has index 1), we obtain (depending on the previous choice) polynomials with passports $(0, 3, 3, 0)$ and $(1, 3, 2, 0)$. The involution (3) turns the second of them into a polynomial with passport $(0, 2, 3, 1)$.

Further, take the polynomial (14) and split by a small perturbation its critical point of type A_5 as previously (i.e. into three points of Morse index 1 and two points of index 2), and the point of type A_3 into a single real point of index 2 and two imaginary points. The passport of the obtained polynomial is $(0, 3, 3, 0)$.

Proposition 16. *Two polynomials with passport $(0, 3, 3, 0)$ constructed in the previous two paragraphs have different values of invariant $Card$, in particular belong to different components of the set of Morse polynomials.*

Proof. In both cases, these polynomials are obtained by a single Morse surgery (i.e. a collision of two real critical points) from the polynomials with eight real critical points, whose D-graphs are shown in Figs. 8 and 11. The data of the virtual Morse functions associated with these polynomials follow by the standard formulas (implemented in our program) from the similar data of the initial polynomials. Namely, these data (for some choice of merged real critical points) are shown by the following matrices supplemented by the information that all real critical values are

negative:

-2	0	0	0	1	0	1	0	-2	0	-2	0	1	1	1	1
0	-2	0	1	1	1	1	-1	0	-2	0	0	1	0	0	0
0	0	-2	0	1	0	0	-1	-2	0	-2	0	1	1	1	1
0	1	0	-2	0	0	0	0	0	0	0	-2	0	1	0	0
1	1	1	0	-2	0	-1	1	1	1	1	0	-2	0	0	0
0	1	0	0	0	-2	-1	1	1	0	1	1	0	-2	0	0
1	1	0	0	-1	-1	-2	0	1	0	1	0	0	0	-2	-1
0	-1	-1	0	1	1	0	-2	1	0	1	0	0	0	-1	-2
1	-1	1	0	0	0	0	0	0	1	0	1	0	0	-1	-1
<i>o</i>	<i>o</i>	<i>o</i>	<i>e</i>	<i>e</i>	<i>e</i>			<i>e</i>	<i>o</i>	<i>o</i>	<i>o</i>	<i>e</i>	<i>e</i>		

Substituting them as initial data into our program enumerating the elements of virtual components, we get the answer that the first of them belongs to the virtual component of cardinality 665, and the second one to the virtual component of cardinality 952. \square

3.3. Polynomials with four critical points.

Proposition 17. *The set of all 650 virtual Morse functions of type Ξ_2 with exactly four real critical points splits into three virtual components: two of cardinality 90 and one of cardinality 470. \otimes*

To realize them, we can modify the first construction (dealing with polynomial (11)) from the previous subsection 3.2 and split the A_3 singularity into a single Morse critical point with Morse index 2 and two imaginary critical points. Behaving with the point of type D_5 as previously, we obtain polynomials with passports $(0, 2, 2, 0)$ and $(1, 2, 1, 0)$. Using the involution (3) we turn the second of these polynomials into one with passport $(0, 1, 2, 1)$.

3.4. Polynomials with two critical points.

Proposition 18. *The set of virtual Morse functions of type Ξ_2 with only two real critical points consists of only one virtual component of cardinality 255. \otimes*

To realize this component, take the starting polynomial (13) of the realization of Fig. 10 and perturb its point of type E_6 in such a way that all critical points in its neighborhood move into the complex domain.

3.5. Polynomials with no critical points. There are no such polynomials of class Ξ_2 , see § 1.2. This fact is confirmed also by our program, see Proposition 11.

Conjecture 2. *There are no polynomials of type Ξ_2 having simultaneously points of local minima and local maxima.*

Indeed, this is true for all polynomials of this type constructed above.

4. PROOF OF THEOREMS 1 AND 2

Proof of Theorem 1. The polynomials of type Ξ_1 with pairs of real critical points $D_4^+ + D_4^+$, $D_4^- + D_4^-$ and $E_6 + A_2$ are constructed in § 2.1. It is easy to check that any polynomial

$$x^3 + xz^2 - y^2z + \lambda x^2, \quad \lambda \neq 0,$$

has two critical points of types D_5 and A_3 , cf. § 3.1.1.

On the other hand, none of D-graphs shown in Figs. 2–6 can be split into two subgraphs, whose interior edges form canonical Coxeter–Dynkin graphs of types A_5

and A_3 , or A_4 and the canonical Dynkin graph  of D_4^+ singularity, or A_2

and the canonical Dynkin graph  of D_6^+ singularity in such a way that all edges of the initial D-graph connecting the vertices of different subgraphs are directed from one of these subgraphs to the other. \square

Proof of Theorem 2. Polynomials of type Ξ_2 with pairs of real critical points of types $D_5 + A_3$ and $A_5 + A_3$ are constructed in §§ 3.1.1 and 3.1.4.

On the other hand, if a polynomial of type Ξ_2 has two critical points of type D_4^+ , then each of these critical points can be removed by a small perturbation, and we get a polynomial without critical points at all, which contradicts § 1.2. Therefore there are no such polynomials. The same argument prohibits polynomials of type Ξ_2 with multisingularities $A_4 + A_4$, $A_4 + D_4^+$, $E_6 + A_2$ and $D_6^+ + A_2$.

Further, none of D-graphs shown in Figs. 8–11 can be split into two subgraphs, whose interior edges form canonical Coxeter–Dynkin graphs of type D_4 , in such a way that all edges of the initial D-graph connecting the vertices of different subgraphs are directed from one of these subgraphs to the other. This prohibits the polynomials of class Ξ_2 with two critical points of type D_4^- .

REFERENCES

- [1] N. A'Campo, *Le groupe de monodromie du déploiement des singularités isolées de courbes planes. I*, Math. Ann. 213 (1975), 1–32.
- [2] V.I. Arnold, S.M. Gusein–Zade, A.N. Varchenko, *Singularities of differentiable maps*, Vols. 1 and 2, Birkhäuser, Basel, 2012.
- [3] V.I. Arnold, *Singularities of caustics and wave fronts*. Vol. 62. Springer Science & Business Media, 2001.
- [4] V.I. Arnold, *Topological classification of Morse functions and generalisations of Hilbert's 16-th problem // Math. Phys., Anal. and Geom.* 2007. V. 10, N 3. P. 227–236.
- [5] V.I. Arnold, *Topological classification of Morse polynomials*, Proc. Steklov Inst. Math., 268 (2010), 32–48.
- [6] S.M. Gusein–Zade, *Intersection matrices for some singularities of functions of two variables*, Funct. Anal. Appl. 8:1 (1974), 10–13.
- [7] J. Milnor, *Singular points of complex hypersurfaces*, Princeton University Press, 1968.
- [8] V.A. Vassiliev, *Applied Picard–Lefschetz theory*, AMS, Providence, RI, 2002, xii+324 pp.

- [9] V.A. Vassiliev, *Local Petrovskii lacunas close to parabolic singular points of the wavefronts of strictly hyperbolic partial differential equations*, Sbornik: Mathematics, 207:10 (2016), 1363–1383, arXiv: 1607.04042
- [10] V.A. Vassiliev, *Complements of discriminants of real parabolic function singularities*, Moscow Mathematical Journal, 23:3 (2023), 401–432 , arXiv: 2208.10929
- [11] V. A. Vassiliev, *Complements of discriminants of simple real function singularities*, to appear in Israel J. of Mathematics, arXiv: 2109.12287
- [12] V.A. Vassiliev, *To the rigid isotopy classification of Morse polynomials of degree 4 in \mathbb{R}^2* , 2023, 32 pp., arXiv: 2311.11113
- [13] A program enumerating real morsifications of isolated real function singularities. <https://drive.google.com/file/d/1tu4qOfmcsMkQCmwFAStYOYgb-K1R5xG3/view?usp=sharing>

WEIZMANN INSTITUTE OF SCIENCE, REHOVOT, ISRAEL
Email address: victor.vasilyev@weizmann.ac.il