

Mim-Width is paraNP-complete

Benjamin Bergougnoux   

LIS, Aix-Marseille Université, France

Édouard Bonnet   

CNRS, ENS de Lyon, Université Claude Bernard Lyon 1, LIP UMR 5668, Lyon, France

Julien Duron   

ENS de Lyon, Université Claude Bernard Lyon 1, LIP UMR 5668, Lyon, France

Abstract

We show that it is NP-hard to distinguish graphs of linear mim-width at most 1211 from graphs of sim-width at least 1216. This implies that MIM-WIDTH, SIM-WIDTH, ONE-SIDED MIM-WIDTH, and their linear counterparts are all paraNP-complete, i.e., NP-complete to compute even when upper bounded by a constant. A key intermediate problem that we introduce and show NP-complete, LINEAR DEGREE BALANCING, inputs an edge-weighted graph G and an integer τ , and asks whether $V(G)$ can be linearly ordered such that every vertex of G has weighted *backward* and *forward* degrees at most τ .

1 Introduction

While it was shown shortly after the inception of these parameters by Vatschelle in 2012 [14, 1] that MIM-WIDTH and LINEAR MIM-WIDTH are W[1]-hard [12, 13], whether a slice-wise polynomial (XP) algorithm¹ can compute (or approximate) the (linear) mim-width of an input graph has been raised as an open question repeatedly over the past twelve years [14, 13, 10, 9, 4, 3, 11, 2]. We give a negative answer to this question (at least for some too-good approximation factor), and similarly settle the parameterized complexity of the related sim-width and one-sided mim-width parameters, as well as their linear variants. Indeed we show that all these parameters are paraNP-complete to compute, i.e., NP-complete even when guaranteed to be upper bounded by a universal constant.

► **Theorem 1.** *MIM-WIDTH, SIM-WIDTH, ONE-SIDED MIM-WIDTH, LINEAR MIM-WIDTH, LINEAR SIM-WIDTH, and LINEAR ONE-SIDED MIM-WIDTH are paraNP-complete.*

We show Theorem 1 with a single reduction.

► **Theorem 2.** *There is a polynomial-time algorithm that takes an input φ of 4-OCC NOT-ALL-EQUAL 3-SAT and builds a graph G^* such that*

- *if φ is satisfiable, then G^* has linear mim-width at most 1211,*
- *if φ is unsatisfiable, then G^* has sim-width at least 1216.*

Theorem 2 indeed implies Theorem 1 as the linear mim-width upper bounds the other five parameters, while the sim-width lower bounds the other five parameters. Our reduction is naturally split into three parts, thereby going through two intermediate problems. The first intermediate problem may be of independent interest (perhaps especially so, its unweighted version), and we were somewhat surprised not to find it already defined in the literature. We call it LINEAR DEGREE BALANCING.

¹ i.e., for any fixed integer k , a polynomial-time algorithm (whose exponent may depend on k) that decides if the (linear) mim-width of the input graph is at most k .

LINEAR DEGREE BALANCING

Parameter: τ

Input: An edge-weighted n -vertex graph H and a non-negative integer τ .

Question: Is there a linear ordering $v_1 \prec v_2 \prec \dots \prec v_n$ of $V(H)$ such that every vertex v_i has weighted degree in $H[\{v_1, \dots, v_i\}]$ and in $H[\{v_i, \dots, v_n\}]$ at most τ ?

We call τ -balancing order of H a linear order over $V(H)$ witnessing that H is a positive instance of LINEAR DEGREE BALANCING.

The three steps. Our reduction starts with a NOT-ALL-EQUAL 3-SAT (NAE 3-SAT for short) instance φ , and goes through an edge-weighted graph (H, ω) , a vertex-partitioned graph (G, \mathcal{P}) , and finally an instance G^* of MIM-WIDTH.

First we prove that LINEAR DEGREE BALANCING is NP-complete even when τ is a constant, and every edge weight is a positive integer. For our purpose, we in fact show something stronger. The first step is a polynomial-time reduction from 4-OCC NAE 3-SAT that maps satisfiable formulas to edge-weighted graphs admitting a τ -balancing order, and unsatisfiable formulas to negative instances of TREE DEGREE BALANCING, a tree variant of LINEAR DEGREE BALANCING, for the larger threshold of $\tau + \gamma$, where γ can grow linearly in τ .

In TREE DEGREE BALANCING, the vertices of H are bijectively mapped to the nodes of a freely-chosen tree T such that for every node t of T and every edge e incident to t , the vertex of H mapped to t has weighted degree at most the given threshold in the cut of H defined by the two connected components of $T - e$. A formal definition is given in Section 3.5.

The second step turns the weighted degree into the maximum (semi-)induced matching at the expense of mapping *subsets* of vertices of G to nodes of T , in a way that the nodes of T jointly hold a prescribed partition \mathcal{P} of $V(G)$. In TREE MIM-BALANCING (resp. TREE SIM-BALANCING), for every edge e of T , the size of a maximum semi-induced (resp. induced) matching in the cut of G defined by e shall remain below the threshold. Their linear variants force T to be a path. See Section 4.1 for formal definitions.

The third step erases the differences between TREE MIM-BALANCING and MIM-WIDTH, and between their respective variants. Intuitively speaking:

- for each part of \mathcal{P} , the corresponding vertices of G^* can be gathered in their own subtree,
- T can be chosen ternary (i.e., every non leaf node has degree 3),
- only the leaves of T need hold a vertex of G^* .

Figure 1 summarizes these three steps.

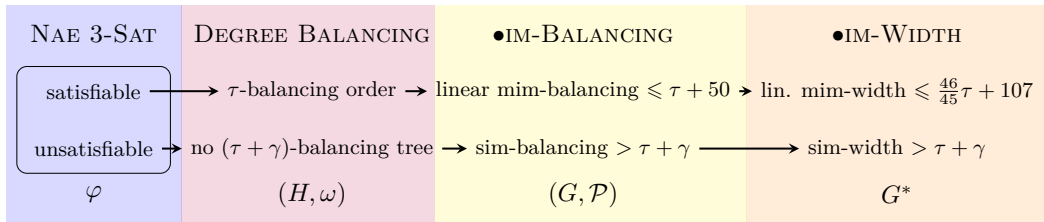

■ **Figure 1** Visual summary of our reduction, split into its three steps.

We now outline each step.

Nae 3-Sat to Degree Balancing. We actually reduce from the positive variant of NAE 3-SAT, where no literal is negated. We design a gadget called *bottleneck sequence* that, given three disjoint sets $X, Y, Z \subset V(H)$, forces all vertices of Y to appear in the order after all the vertices of X , and before all the vertices of Z (or by symmetry after all the vertices of Z ,

and before all the vertices of X). Vertices of Y are in one-to-one correspondence with clauses of φ . Similarly, we have a vertex for each variable of φ . Each *variable* vertex is forced to be placed before X (where it represents being set to true), or after Z (where it represents being set to false). The weights are designed so that a *clause* vertex can tolerate two but not three of its *variable* vertices to be on the same side (before or after it); which exactly captures the semantic of a not-all-equal 3-clause.

The gap between *at most* τ and *at least* $\tau + \gamma + 1$ is obtained by carefully crafting ω . We also add a padding gadget to raise the minimum degree of H , in such a way that only two vertices have low-enough degree to be leaves of T . This forces T to be a path (the only tree with at most two leaves), thus LINEAR DEGREE BALANCING and TREE DEGREE BALANCING to coincide.

Degree Balancing to {Linear M, Tree S}im-Balancing. Every vertex u of H becomes an independent set $S(u)$ of G and a part of \mathcal{P} of size the sum of the weights of edges incident to u . Adjacencies in H become induced matchings in G , whereas non-adjacencies in H become bicliques in G (with some additional twist, see Figure 5). The density of G forces large induced matchings to be mainly incident to a single part $S(u)$. Thus, roughly speaking, the maximum induced matchings in G behave like the degree in H . As the parts $S(u)$ are independent sets, there is in effect no difference between TREE MIM-BALANCING and TREE SIM-BALANCING. The indifference between the tree or the linear variants is inherited from the previous reduction. The actual arguments incur a small additive loss (of 50) in the induced matching size, which is eventually outweighed by γ .

{Linear M, Tree S}im-Balancing to {Linear M, S}im-Width. We design a *part gadget* $\mathcal{G}(u)$ that simultaneously takes care of the three items above Figure 1. Essentially, every part $S(u)$ is transformed into the 1-subdivision P_u of a path on $|S(u)|$ vertices, then duplicated a large (but constant) number of times, concatenated into a single path, and every pair of vertices in different copies are linked by an edge whenever they do not correspond to the same vertex or neighboring vertices in P_u . On the one hand, this may only increase the linear mim-width (compared to the linear mim-balancing) by an additive constant. Following the “spine” of $\mathcal{G}(u)$, one gets a witness of low linear mim-width for G^* from a witness of low linear mim-balancing of (G, \mathcal{P}) .

On the other hand, the dense “path-like” structure of $\mathcal{G}(u)$ ensures that, in an optimal decomposition of G^* , its vertices may as well be placed in order at the leaves of a caterpillar. We thus devise a process that builds a witness of low sim-balancing for (G, \mathcal{P}) from a witness of low sim-width for G^* : We in turn identify an edge e of the branch decomposition of G^* that can support $V(\mathcal{G}(u))$, and in particular $S(u)$, without increasing the width. We then relocate the vertices of $S(u)$ at a vertex subdividing e . Eventually each set $S(u)$ is solidified at a single node of the tree, and we reach the desired witness for TREE SIM-BALANCING.

Remarks and perspectives. It can be noted that we had to develop completely new techniques. Indeed, the known W[1]-hardness [12, 13] relies on the difficulty of actually computing the value of a fixed cut, i.e., solving MAXIMUM INDUCED MATCHING. In some sense, the instances produced there are not difficult to solve (a best decomposition is, on the contrary, suggested by the reduction), but only to evaluate. In any case, as MAXIMUM INDUCED MATCHING is W[1]-hard but admits a straightforward XP algorithm, we could not use the same idea.

We believe that LINEAR DEGREE BALANCING could be explored for its own sake. We emphasize that our techniques could prove useful to show the paraNP-hardness of other parameters based on branch decompositions such as those recently introduced by Eiben et

al. [6], where the *cut function* can combine maximum (semi-)induced matchings, maximum (semi-)induced co-matchings, maximum half-graphs (or ladders). One would then mainly need to tune the gadgets of the second step (see Figure 5) to fit the particular cut function.

We notice that our reduction from 4-OCC NOT-ALL-EQUAL 3-SAT is linear: n -variables instances are mapped to $\Theta(n)$ -vertex graphs. Hence, unless the Exponential-Time Hypothesis (ETH) [7] fails,² no $2^{o(n)}$ -time algorithm can decide if the mim-width (or any of the five variants of mim-width) of an n -vertex graph is at most 1211. Indeed the absence of $2^{o(n)}$ -time algorithm for n -variable 4-OCC NOT-ALL-EQUAL 3-SAT (even POSITIVE 4-OCC NOT-ALL-EQUAL 3-SAT) under the ETH can be derived from the Sparsification Lemma [8] and classic reductions.

Our focus was to handle all the variants of mim-width at once. This made the reduction more technical and degraded the constant upper and lower bounds. Better bounds (than 1211) could be achieved if separately dealing with MIM-WIDTH or with LINEAR MIM-WIDTH. For example, the latter problem essentially only requires the first two steps of the reduction. Still, deciding if the (linear) mim-width of a graph is at most 1 (or any 1-digit constant) remains open. In addition, the question whether an XP $f(\text{OPT})$ -approximation algorithm for MIM-WIDTH (and its variants) exists, for some fixed function f and OPT being the optimum width, remains open.

2 Graph definitions and notation

For i and j two integers, we denote by $[i, j]$ the set of integers that are at least i and at most j . For every integer i , $[i]$ is a shorthand for $[1, i]$.

2.1 Standard graph theory

We denote by $V(G)$ and $E(G)$ the vertex and the edge set, respectively, of a graph G . If G is a graph and $S \subseteq V(G)$, we denote by $G[S]$ the subgraph of G induced by S , and use $G - S$ as a short-hand for $G[V(G) \setminus S]$. If $e \in E(G)$, we denote by $G - e$ the graph G deprived of edge e , but the endpoints of e remain. More generally, if $F \subseteq E(G)$, $G - F$ is the graph obtained from G by removing all the edges of F (but not their endpoints). For $X \subseteq V(G)$, we may denote by $E_G(X)$ the edge set of $G[X]$. We denote the open and closed neighborhoods of a vertex v in G by $N_G(v)$ and $N_G[v]$, respectively. For $S \subseteq V(G)$, we set $N_G(S) := \bigcup_{v \in S} N_G(v) \setminus S$ and $N_G[S] := N_G(S) \cup S$. In every notation with a graph subscript, we may omit it if the graph is clear from the context. A vertex set $S \subseteq V(G)$ covers an edge set $F \subseteq E(G)$ if every edge of F has at least one endpoint in S .

A *cut* of a graph G is a bipartition (A, B) of $V(G)$. The *cut-set* defined by a cut (A, B) , denoted by $E(A, B)$, is $\{uv \in E(G) \mid u \in A, v \in B\}$. We denote by $G[A, B]$ the bipartite subgraph of G with edge set $E(A, B)$. A *matching* is a set of edges that share no endpoints and an *induced matching* of G is a matching M such that every edge of G intersects at most one edge in M . If $A, B \subseteq V(G)$ are two disjoint vertex subsets of G , a *matching between A and B* is a matching where every edge has one endpoint in A and the other endpoint in B . An induced matching in $G[A, B]$ is called a *semi-induced* matching of G between A and B .

² the assumption that there is a $\lambda > 0$ such that n -variable 3-SAT cannot be solved in time $O(\lambda^n)$.

2.2 Mim-width and its variants

A *branch decomposition* or *tree layout* (or simply *layout*) of a graph G is a pair (T, f) where T is a ternary tree (i.e., every internal node of T has degree 3) and f is a bijection from $V(G)$ to the leaves of T . Given two disjoint sets $X, Y \subseteq V(G)$, we denote by $\text{mim}_G(X, Y)$ (resp. $\text{sim}_G(X, Y)$) the maximum number of edges in a semi-induced matching (resp. induced matching) of G between X and Y , and may refer to it as *mim-value* (resp. *sim-value*). An edge e of T *induces* or *defines* a cut (A_e, B_e) of G , where A_e and B_e are the preimages by f of the leaves in the two components of $T - e$.

The *mim-value* (resp. *sim-value*) of (A_e, B_e) is set as $\text{mim}_G(A_e, B_e)$ (resp. $\text{sim}_G(A_e, B_e)$). The *mim-value* (resp. *sim-value*) of the branch decomposition (T, f) is the maximum of $\text{mim}_G(A_e, B_e)$ (resp. $\text{sim}_G(A_e, B_e)$) taken over every edge e of T . Finally, the *mim-width* (resp. *sim-width*) of G is the minimum *mim-value* (resp. *sim-value*) taken over every branch decomposition (T, f) of G .

The *upper-induced matching number* of $X \subseteq V(G)$ is the maximum size of an induced matching of $G - E(V(G) \setminus X)$ between X and $V(G) \setminus X$. The *one-sided mim-width* is defined as above with the *omim-value* of cut (A_e, B_e) , $\text{omim}_G(A_e, B_e)$, defined as the minimum between the upper-induced matching numbers of A_e and of B_e .

The linear variants of these widths and values impose T to be a rooted *full* binary tree (i.e., every internal node has exactly two children) such that the internal nodes form a path.

3 Not-All-Equal 3-Sat to Degree Balancing

Given a graph H edge-weighted by a map $\omega : E(H) \rightarrow \mathbb{N}$, the *weight of a vertex* v of H is the sum of the weights of the edges incident to v . We say that a total order \prec on $V(H)$ is τ -*balancing*, for some non-negative integer τ , if for every vertex $v \in V(H)$ the *left weight* of v , $\sum_{u \in N(v), u \prec v} \omega(uv)$, and the *right weight* of v , $\sum_{u \in N(v), v \prec u} \omega(uv)$, are both at most τ , i.e.,

$$\Delta_{\prec}(v) := \max \left(\sum_{u \in N(v), u \prec v} \omega(uv), \sum_{u \in N(v), v \prec u} \omega(uv) \right) \leq \tau.$$

Constants τ , γ , λ . Henceforth we will use τ and γ as global natural constants. The reduction in this section will also use a constant positive integer λ . For the current section, we need that the following conditions hold.

$$\gamma < \lambda, \quad 3\gamma + 4 < \tau, \quad 2\lambda + \gamma < \tau, \quad 6\lambda \leq \tau. \quad (1)$$

We will not only prove that LINEAR DEGREE BALANCING is paraNP-hard but we will obtain a scalable additive gap. More specifically, we start by showing the following.

► **Theorem 3.** *It is NP-hard to distinguish graphs having a τ -balancing order from graphs having no $(\tau + \gamma)$ -balancing order.*

Eventually we will need that τ and γ are multiples of a constant integer a (which is defined and set to 45 in Section 5). This can simply be achieved by multiplying all edge weights of the forthcoming reduction by a . We will finally set $\tau := 24a = 1080$, $\lambda := 4a = 180$, and $\gamma := 3a = 135$. One can quickly check that these values do respect Equation (1).

3.1 First properties on balancing orders, and bottlenecks

Given a total order \prec on a graph H , we say that a vertex set S is *smaller* (resp. *larger*) than another vertex set U , denoted by $S \prec U$ (resp. $U \prec S$), if for all $s \in S, u \in U$ we have $s \prec u$ (resp. $u \prec s$). When a set S is neither larger nor smaller than a vertex u , we say that S *surrounds* u . We also say that u is *surrounded by* S . Note that if S surrounds two vertices u and v , it surrounds any vertex w with $u \prec w \prec v$.

We begin with a useful observation on the only possible τ -balancing order of a P_3 (i.e., 3-vertex path) with large total weight.

► **Lemma 4.** *For any integer t , and any edge-weighted graph (H, ω) containing a P_3 abc such that $\omega(ab) + \omega(bc) > t$. Then in any t -balancing order of H , $\{a, c\}$ surrounds b .*

Proof. If $\{a, c\} \prec b$ is (resp. $b \prec \{a, c\}$), then the left (resp. right) weight of b is more than t . ◀

We also rely on the following observation, where the induced subgraph of an edge-weighted graph (H, ω) is an induced subgraph of H edge-weighted by the restriction of ω to its edge set.

► **Observation 5.** *Every t -balancing order of (H, ω) is a t -balancing order of any induced subgraph of (H, ω) .*

Our main ingredient here is called *bottleneck*.

► **Definition 6.** *A (τ, γ) -bottleneck on terminals v_1, \dots, v_k is an edge-weighted caterpillar B defined as follows.*

1. *Let $P(B)$ be a $2k$ -vertex path, say $a_1 b_1 a_2 b_2 \dots a_k b_k$, called spine of B and for every $i \in [k]$, we set $\omega(a_i b_i) := \tau$ and $\omega(b_i a_{i+1}) := \gamma + 1$.*
2. *We obtain B by adding to $P(B)$ a leaf v_i adjacent to a_i , satisfying $\gamma + 1 \leq \omega(v_i a_i) \leq \tau - \gamma - 1$ for every $i \in [k]$. This edge is called the attachment of v_i to B .*
3. *The caterpillar B is rooted in b_k .*

The vertex v_1 is called *first terminal* of B . A (τ, γ) -bottleneck is depicted in Figure 2.

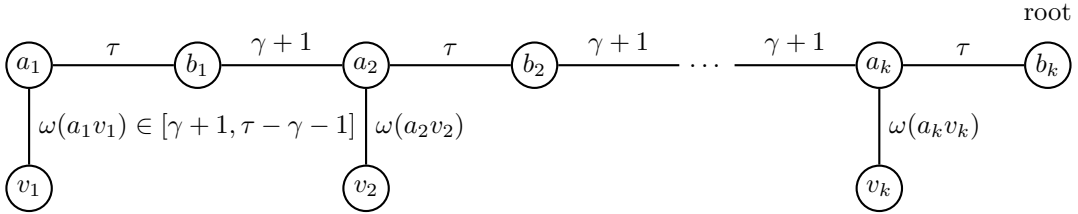

■ **Figure 2** Illustration of a (τ, γ) -bottleneck.

A bottleneck ensures the following.

► **Lemma 7.** *Let \prec be a $(\tau + \gamma)$ -balancing order of a (τ, γ) -bottleneck B on terminals v_1, \dots, v_k . Using the notation of Definition 6, if $a_k \prec b_k$ then $a_1 \prec b_1 \prec a_2 \prec b_2 \prec \dots \prec a_k \prec b_k$, and $v_i \prec a_i$ for each $i \in [k]$. Hence symmetrically, if $b_k \prec a_k$ then $b_k \prec a_k \prec b_{k-1} \prec a_{k-1} \prec \dots \prec b_1 \prec a_1$, and $a_i \prec v_i$ for each $i \in [k]$.*

Proof. Let i be the smallest index such that $a_i \prec b_i \prec a_{i+1} \prec b_{i+1} \prec \dots \prec a_k \prec b_k$. Assume for the sake of contradiction that $i \geq 2$. Since $\omega(a_i b_i) = \tau$ and $\min(\omega(a_i b_{i-1}), \omega(a_i v_i)) \geq \gamma + 1$, it holds that $b_{i-1} \prec a_i$ and $v_i \prec a_i$, by applying Lemma 4 on $b_{i-1} a_i b_i$ and $v_i a_i b_i$.

We have $\omega(a_{i-1}b_{i-1}) + \omega(b_{i-1}a_i) = \tau + \gamma + 1$, so, by Lemma 4 on the P_3 $a_{i-1}b_{i-1}a_i$, $a_{i-1} \prec b_{i-1} \prec a_i$. This contradicts the minimality of i ; thus we have $i = 1$. And in particular, we also have $v_i \prec a_i$ for every $i \in [k]$. ◀

Henceforth every bottleneck is a (τ, γ) -bottleneck. Thus we simply write *bottleneck*.

► **Definition 8.** Given three vertex sets S_1, S_2, S_3 , we call bottleneck sequence on S_1, S_2, S_3 an edge-weighted graph $B(S_1, S_2, S_3)$ obtained by adding

1. for every $i \in \{1, 2\}$, a bottleneck B_i^+ with terminals $S_i \cup \{s_i\}$ where s_i is the first terminal of B_i^+ , and the attachment of s_i is of weight $\gamma + 1$,
 2. for every $i \in \{2, 3\}$, a bottleneck B_i^- with terminals $S_i \cup \{s_i\}$ where s_i is the first terminal of B_i^- and the attachment of s_i is of weight $\gamma + 1$ such that
 3. for every $i \in \{1, 2\}$, the roots of B_i^+ and of B_{i+1}^- are identified as the same vertex, and
 4. for every $i \in \{2, 3\}$, an edge $s_i s_{i+1}$ of weight $\lfloor \frac{\tau + \gamma}{2} \rfloor + 1$,
- with s_1, s_2, s_3 three new vertices.

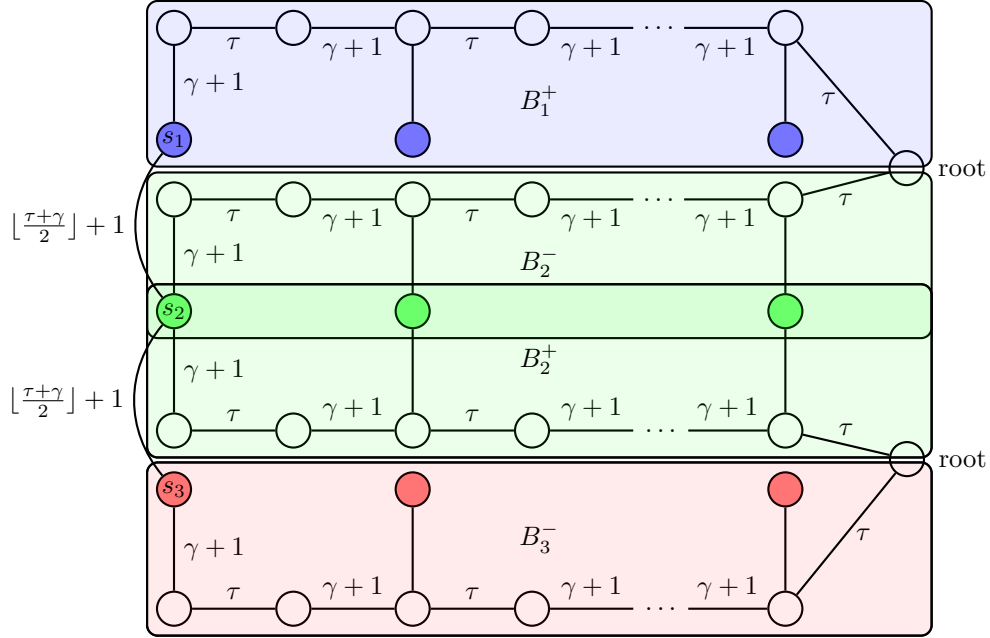

■ **Figure 3** Bottleneck sequence $B(S_1, S_2, S_3)$. Vertices of $S_1 \cup \{s_1\}, S_2 \cup \{s_2\}, S_3 \cup \{s_3\}$ are in red, green, and blue, respectively. As in Figure 2, every edge with an unspecified weight get one in the discrete interval $[\gamma + 1, \tau - \gamma - 1]$.

The next lemma yields the crucial property ensured by bottleneck sequences.

► **Lemma 9.** Any $(\tau + \gamma)$ -balancing order \prec on a bottleneck sequence $B(S_1, S_2, S_3)$ is such that $S_1 \prec S_2 \prec S_3$ or $S_3 \prec S_2 \prec S_1$.

Proof. We keep the notation of Definition 8. Applying Lemma 4 on the P_3 $s_1 s_2 s_3$, we get that either $s_1 \prec s_2 \prec s_3$ or $s_3 \prec s_2 \prec s_1$.

For $i \in \{1, 2\}$, let r_i be the common root of B_i^+ and B_{i+1}^- . Vertex r_i has exactly two neighbors: a vertex $a^+ \in V(B_i^+)$ and a vertex $a^- \in V(B_{i+1}^-)$. By construction $\omega(a^- r_i) = \omega(a^+ r_i) = \tau$, and by Lemma 4 (since $2\tau > \tau + \gamma$), either $a^- \prec r_i \prec a^+$ or $a^+ \prec r_i \prec a^-$. By Lemma 7, this implies that $S_{i+1} \cup \{s_{i+1}\} \prec S_i \cup \{s_i\}$ or $S_i \cup \{s_i\} \prec S_{i+1} \cup \{s_{i+1}\}$.

In particular, $S_1 \prec S_2 \prec S_3$ (if $s_1 \prec s_2 \prec s_3$) or $S_3 \prec S_2 \prec S_1$ (if $s_3 \prec s_2 \prec s_1$). ◀

We conclude the section by defining τ -balancing orders for bottleneck sequences. A *direct order* \prec_{\rightarrow} of a bottleneck B with terminals v_1, \dots, v_k goes as follows:

$$\{v_1, \dots, v_k\} \prec_{\rightarrow} a_1 \prec_{\rightarrow} b_1 \prec_{\rightarrow} a_2 \prec_{\rightarrow} b_2 \prec_{\rightarrow} \dots \prec_{\rightarrow} a_k \prec_{\rightarrow} b_k,$$

where $a_1 b_2 \dots a_k b_k$ is the spine of B rooted in b_k . Note that the order induced by $\{v_1, \dots, v_k\}$ is not specified (and so a given bottleneck on k terminals admits $k!$ different direct orders). A *reverse order* of B , denoted by \prec_{\leftarrow} , is simply defined as the reverse order of a direct order \prec_{\rightarrow} .

A *direct order* $\prec_{\rightarrow}^{\text{seq}}$ of a bottleneck sequence $B(S_1, S_2, S_3)$ is a common (linear) extension of direct orders on B_1^+ and B_2^+ and reverse orders on B_2^- and B_3^- . Note that on any bottleneck sequence, at least one direct order exists since the direct and reverse orders constrain disjoint vertex sets. In particular we have $S_1 \prec_{\rightarrow}^{\text{seq}} S_2 \prec_{\rightarrow}^{\text{seq}} S_3$. We check that any direct order of $B(S_1, S_2, S_3)$ is indeed τ -balancing.

► **Lemma 10.** *A direct order $\prec_{\rightarrow}^{\text{seq}}$ of the bottleneck sequence $B(S_1, S_2, S_3)$ is τ -balancing.*

Proof. Again we use the notation of Definition 8. For each $i \in [3]$, and any vertex $v \in S_i$, v has at most two neighbors: a vertex $t^- \in V(B_i^-)$ and a vertex $t^+ \in V(B_i^+)$. By construction, $t^- \prec_{\rightarrow}^{\text{seq}} v \prec_{\rightarrow}^{\text{seq}} t^+$ and both $\omega(t^-v)$ and $\omega(vt^+)$ are at most $\tau - \gamma - 1 \leq \tau$. For each $i \in [3]$, the vertex s_i has at most four neighbors: s_{i-1} , s_{i+1} , a vertex $t^- \in V(B_i^-)$, and a vertex $t^+ \in V(B_i^+)$. By construction, the left weight of s_i is at most

$$\omega(s_{i-1}s_i) + \omega(t^-s_i) = \left(\left\lfloor \frac{\tau + \gamma}{2} \right\rfloor + 1 \right) + (\gamma + 1) = \frac{\tau}{2} + \frac{3\gamma}{2} + 2 \leq \tau.$$

The last inequality holds since $3\gamma \leq \tau - 4$. The right weight of s_i can be symmetrically upper bounded by τ .

It remains to check the degree property for the vertices in bottleneck spines. For each $i \in \{1, 2\}$, let $a_1 b_1 \dots a_k b_k$ be the spine $P(B_i^+)$. For any $j \in [k]$, vertex a_j has at most three neighbors: b_{j-1} (if it exists), b_j , and some leaf $\ell \in S_i \cup \{s_i\}$. By construction, $\{\ell, b_{j-1}\} \prec_{\rightarrow}^{\text{seq}} a_j \prec_{\rightarrow}^{\text{seq}} b_j$. Hence a_j has left weight at most $(\tau - \gamma - 1) + (\gamma + 1) = \tau$, and right weight τ . Vertex b_j is incident to at most two edges each of weight at most τ (even b_k). By construction, one neighbor of b_j is smaller and its other neighbor is larger. Hence its left and right weights are both upper bounded by τ .

The case of vertices of B_i^- with $i \in \{2, 3\}$ is handled symmetrically. ◀

3.2 Encoding NAE 3-Sat in Linear Degree Balancing

We now describe the reduction from NAE 3-SAT to LINEAR DEGREE BALANCING. We recall that a not-all-equal 3-clause is satisfied if it has at least one satisfied literal and at least one unsatisfied literal. The NAE 3-SAT remains NP-hard if each clause is on exactly three distinct *positive* literals, and every variable appears exactly four times positively (and zero times negatively) [5]. Let φ be any such n -variable NAE 3-SAT instance. As we will only deal with not-all-equal 3-clauses, we say that φ is *satisfiable* whenever it admits a truth assignment that, in each clause of φ , sets a (positive) literal to true and another (positive) literal to false. We will build an edge-weighted graph $H := H(\varphi)$ as follows.

Variables, clauses, and variable-clause incidence. For each variable x of φ , we add a vertex v_x (to $H(\varphi)$), the *vertex* of x . For each clause c of φ we add a vertex v_c , the *vertex* of c . For every clause c and every variable x in c , we add the edge $v_x v_c$ of weight λ . We add two sets of vertices $T = \{t_i : i \in [n]\}$ and $F = \{f_i : i \in [n]\}$, for *true* and *false*. For each t_i

(resp. each f_i), we add a vertex \bar{t}_i (resp. a vertex \bar{f}_i), and the edge $t_i\bar{t}_i$ (resp. $f_i\bar{f}_i$) of weight $\tau - \lambda$. For each $i \in [n]$, let x_i be the i -th variable of φ . We add a vertex \bar{v}_{x_i} , and the edges $v_{x_i}t_i, v_{x_i}f_i, \bar{v}_{x_i}t_i, \bar{v}_{x_i}f_i$ each of weight λ .

Bottleneck sequence $B(T, C, F)$. We then add a bottleneck sequence $B(T, C, F)$ where $C := \{v_c : c \text{ is a clause of } \varphi\}$, with weight $\tau - \lambda$ on every attachment incident to T or F , and weight $\tau - 2\lambda$ on every attachment incident to C . (This is allowed since $\gamma + 1 \leq \tau - 2\lambda \leq \tau - \lambda \leq \tau - \gamma - 1$.) We remind the reader that every attachment of the first terminals of the bottlenecks forming $B(T, C, F)$ has weight $\gamma + 1$. These three first terminals are extra vertices not in T , C , and F .

This could end the construction of H , but we want to impose an extra condition, which will later prove useful. Specifically, we want that all *but two* vertices have weight at least $\tau + \gamma + 1$ (both having weight τ). Let us call H' the edge-weighted graph built so far.

Weight padding. For each vertex $v \in V(H')$ of weight less than $\tau + \gamma + 1$, the *missing weight* of v is defined as $\tau + \gamma + 1$ minus the weight of v . Let p be the sum of missing weights of vertices of H' . Let X and Y be two sets each comprising p new vertices. We add a bottleneck B_L with terminals the vertices of X , and a bottleneck B_R with terminals the vertices of Y . Every attachment to B_L and B_R with an unspecified weight gets weight $\tau - \gamma - 1$. We add a perfect matching between X and Y with every edge of weight $2\gamma + 2$. Finally, for each vertex $v \in V(H')$, we link v by edges of weight 1 to t vertices of X , where t is the missing weight of v . We do so such that every vertex in X has exactly one neighbor in $V(H')$.

This completes the construction of H ; see Figure 4. We observe that H is triangle-free. This fact will significantly simplify some proof in Section 5 (although is not in any way crucial).

We check that the weight padding works as intended.

► **Lemma 11.** *Every vertex of H has weight at least $\tau + \gamma + 1$, except two vertices.*

Proof. By construction, all the vertices with weight less than $\tau + \gamma + 1$ in H' have weight exactly $\tau + \gamma + 1$ in H , while the vertices with weight at least $\tau + \gamma + 1$ in H' have kept the same weight in H . We shall just check the property for vertices in $V(B_L) \cup V(B_R)$.

Note that every vertex of the spines $P(B_R), P(B_L)$ except the two roots have weight at least $\tau + \gamma + 1$. In particular, the last vertices of $P(B_R), P(B_L)$ have weight $2\tau - \gamma - 1$ and this is bigger than $\tau + 2\gamma + 3$ since $3\gamma + 4 < \tau$ from Equation (1). Furthermore, the vertices in X and Y have an attachment of weight $\tau - \gamma - 1$ and are incident to an edge of the matching between X and Y of weight $2\gamma + 2$. Hence any vertex in $X \cup Y$ has weight at least $\tau - \gamma - 1 + 2\gamma + 2 = \tau + \gamma + 1$.

In conclusion, every vertex of H has weight at least $\tau + \gamma + 1$, but the roots of B_L and B_R , which have weight τ . ◀

3.3 Preparatory lemmas

We will make use of the following two lemmas.

► **Lemma 12.** *For any $(\tau + \gamma)$ -balancing order \prec of $H(\varphi)$, for every clause $c = x \vee y \vee z$ of φ , $\{v_x, v_y, v_z\}$ surrounds v_c .*

Proof. Vertex v_c has two attachments of weight $\tau - 2\lambda$. Lemmas 7 and 9 imply that v_c is surrounded by the two vertices it is attached to in $B(T, C, F)$. Assume for the sake of

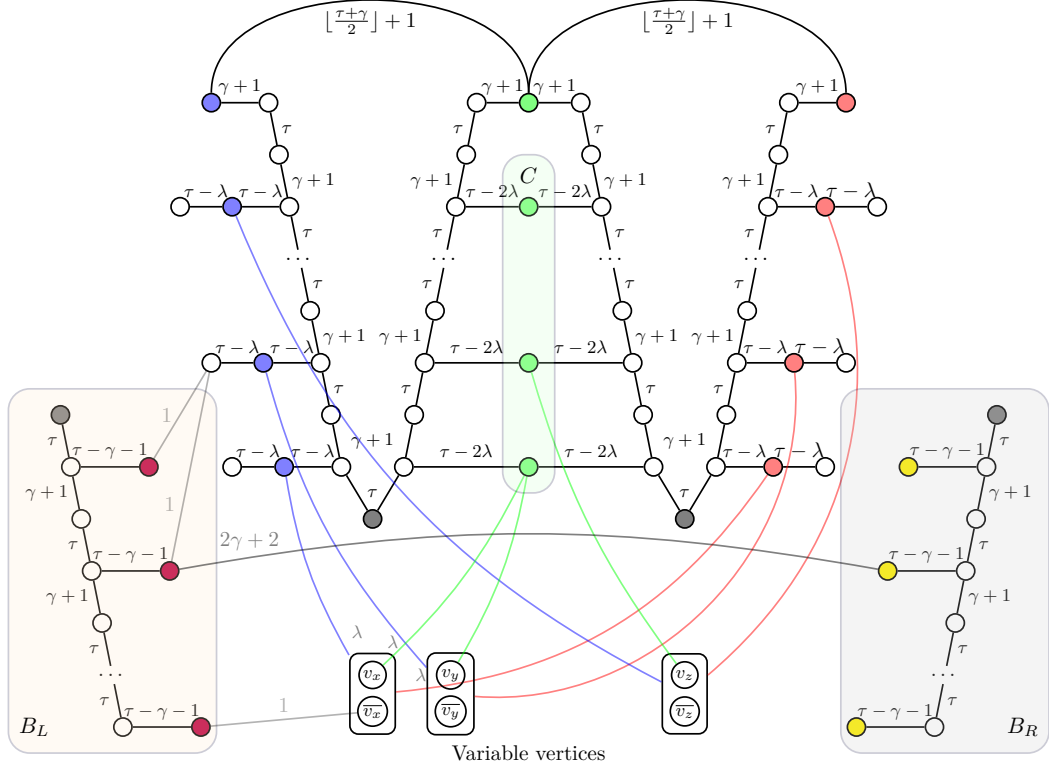

■ **Figure 4** Illustration of (H, ω) . Centered at the top is the bottleneck sequence $B(T, C, F)$. The vertices of X are in purple (left), and the vertices of Y are in yellow (right). The edges incident to the variable vertices that are drawn in blue, green, red all have weight λ . Not to overburden the figure, we have only drew *some* edges of the construction. Only one edge of the matching between X and Y is depicted, and the paddings of \bar{v}_x and of \bar{v}_z are (partially) represented (weight-1 edges toward X). The clause corresponding to the bottommost vertex of C contains x, y and some other variable (not shown), while that of the second bottommost vertex of C contains z (and two other variables). The roots of bottlenecks are in gray. The leftmost and rightmost gray vertices are the only two vertices of weight less than $\tau + \gamma + 1$ (namely τ).

contradiction that v_x, v_y , and v_z are all smaller (resp. larger) than v_c . Then the left weight (resp. right weight) of v_c is at least

$$(\tau - 2\lambda) + \omega(v_x v_c) + \omega(v_y v_c) + \omega(v_z v_c) = \tau + \lambda \geq \tau + \gamma + 1;$$

a contradiction. ◀

► **Lemma 13.** For any $(\tau + \gamma)$ -balancing order \prec of $H(\varphi)$, for any variable x of φ , we either have $v_x \prec C$ or $C \prec v_x$.

Proof. By Lemma 9, either $T \prec C \prec F$ or $F \prec C \prec T$ holds. Up to reversing the order, we can assume without loss of generality that $T \prec C \prec F$.

For each $i \in [n]$, vertex t_i is incident to two edges of weight $\tau - \lambda$: $t_i \bar{t}_i$ and its attachment in $B(T, C, F)$. Since $2\tau - 2\lambda > \tau + \gamma$, Lemma 4 ensures that t_i is surrounded by the other endpoints of both edges. We thus claim that $\{v_{x_i}, \bar{v}_{x_i}\}$ surrounds t_i , where x_i is the i -th variable of φ . Indeed if $\{v_{x_i}, \bar{v}_{x_i}\} \prec t_i$ (resp. $t_i \prec \{v_{x_i}, \bar{v}_{x_i}\}$), the left weight (resp. right

weight) of t_i is at least $\tau - \lambda + 2\lambda = \tau + \lambda > \tau + \gamma$; a contradiction. Similarly $\{v_{x_i}, \overline{v_{x_i}}\}$ surrounds f_i .

As $t_i \prec C \prec f_i$, for $\{v_{x_i}, \overline{v_{x_i}}\}$ to both surround t_i and f_i , it holds that v_{x_i} is smaller than t_i or is larger than f_i . Therefore we indeed have $v_{x_i} \prec C$ or $C \prec v_{x_i}$. ◀

3.4 Correctness of the reduction

We can now show that our reduction performs as announced.

► **Lemma 14.** *If $H(\varphi)$ admits a $(\tau + \gamma)$ -balancing order, then φ is satisfiable.*

Proof. Let \prec be a $(\tau + \gamma)$ -balancing order of $H(\varphi)$. Let the valuation \mathcal{A} set x to true if and only if $v_x \prec C$. This is well defined by Lemma 13. By Lemma 12, for every clause $c = x \vee y \vee z$, vertex v_c is surrounded by $\{v_x, v_y, v_z\}$. Hence \mathcal{A} sets within $\{x, y, z\}$ at least one variable to true and at least one variable to false, thus satisfies c . ◀

► **Lemma 15.** *If φ is satisfiable, then $H(\varphi)$ admits a τ -balancing order.*

Proof. We first give a fixed τ -balancing order \prec_1 of $H[V(B_L) \cup V(B_R)]$ that does not rely on φ being satisfiable. Then we give a τ -balancing order \prec_2 of $H - (V(B_L) \cup V(B_R))$. This order is based on a truth assignment satisfying φ . It will remain to argue that there is a τ -balancing order extending both \prec_1 and \prec_2 . This is done by proving that any extension of \prec_1 to H keeps the left and right weights of vertices in $V(B_L) \cup V(B_R)$ small enough, and by indicating in which order each vertex of X should appear relatively to their unique neighbor in $V(H) \setminus (V(B_L) \cup V(B_R))$.

Construction of \prec_1 . For \prec_1 fix any reverse order on the bottleneck B_L , followed by any direct order on the bottleneck B_R . Observe that, in $H[V(B_L) \cup V(B_R)]$, every vertex v outside $X \cup Y$ satisfies $\Delta_{\prec_1}(v) \leq \tau$ (see the proof of Lemma 10, or Figure 2). Consider the vertex $x \in X$. It has two neighbors: one in $V(B_L)$ and one, say, y in Y . The left weight of x is that of its attachment $\tau - \gamma - 1 \leq \tau$, whereas the right weight of x is $\omega(xy) = 2\gamma + 2 \leq \tau$. The situation is symmetric for the vertices of Y . Hence \prec_1 is a τ -balancing order of $H[V(B_L) \cup V(B_R)]$.

Construction of \prec_2 . Let \mathcal{A} be a variable assignment satisfying φ . We build the order \prec_2 on $H - (V(B_L) \cup V(B_R))$ in the following way:

- we first have all vertices $\overline{t_i}$ for $i \in [n]$,
- followed by all the vertices v_x (resp. $\overline{v_x}$) such that x is set to true (resp. false) by \mathcal{A} ,
- followed by any fixed direct order of $B(T, C, F)$,
- followed by the vertices v_x (resp. $\overline{v_x}$) such that x is set to false (resp. true) by \mathcal{A} ,
- followed by all vertices $\overline{f_i}$ for $i \in [n]$.

We verify that \prec_2 is a τ -balancing order in $H - (V(B_L) \cup V(B_R))$. We let u be a vertex of $H - (V(B_L) \cup V(B_R))$, and prove that $\Delta_{\prec_2}(u) \leq \tau$.

Case u of the form $\overline{t_i}$ or $\overline{f_i}$ for $i \in [n]$. The vertex u is incident to a single edge of weight $\tau - \lambda \leq \tau$.

Case u of the form v_x or $\overline{v_x}$ for some variable x . Let x_i be the i -th variable of φ and c_1, c_2, c_3, c_4 be the four clauses of φ in which x_i appears. Then $u = v_{x_i}$ (resp. $u = \overline{v_{x_i}}$) is incident to six edges (resp. two edges) each of weight λ to $t_i, f_i, v_{c_1}, v_{c_2}, v_{c_3}, v_{c_4}$ (resp. t_i, f_i), thus $\Delta_{\prec_2}(u) \leq 6\lambda \leq \tau$.

Case u of the form t_i or f_i for some $i \in [n]$. The vertex t_i has exactly four neighbors: the vertex \bar{t}_i , the vertex v it is attached to in $B(T, C, F)$, and the two vertices v_{x_i} and \bar{v}_{x_i} . By definition of \prec_2 , we have $\bar{t}_i \prec_2 t_i \prec_2 v$, and either $v_{x_i} \prec_2 t_i \prec_2 \bar{v}_{x_i}$ or $\bar{v}_{x_i} \prec_2 t_i \prec_2 v_{x_i}$. Since $\omega(t_i \bar{t}_i) = \omega(t_i v) = \tau - \lambda$, and $\omega(t_i v_{x_i}) = \omega(t_i \bar{v}_{x_i}) = \lambda$, the left weight and right weight of t_i are both equal to $(\tau - \lambda) + \lambda = \tau$. The situation is symmetric for f_i .

Case u of the form v_c for a clause c . Let $c = x \vee y \vee z$. The vertex v_c is adjacent to exactly five vertices: two vertices, say s_1 and s_2 , it is attached to in the bottleneck sequence $B(T, C, F)$ via an edge of weight $\tau - 2\lambda$, and v_x, v_y, v_z . We have $s_1 \prec_2 v_c \prec_2 s_2$, and since φ is satisfied by \mathcal{A} , there is at most two vertices among v_x, v_y, v_z to the right of v_c , and at most two to its left. Since $\omega(v_c v_x) = \omega(v_c v_y) = \omega(v_c v_z) = \lambda$, the left weight and the right weight of v_c are at most $(\tau - 2\lambda) + 2 \cdot \lambda = \tau$.

Case u in one of the spines of $B(T, C, F)$. Since u has no neighbors outside of the bottleneck sequence, the order \prec_2 acts as $\prec_{\rightarrow}^{\text{seq}}$, and we conclude by Lemma 10.

Extending \prec_1 and \prec_2 . Note that every vertex of X has right weight and left weight at most $\tau - 1$ in \prec_1 , and is adjacent to exactly one vertex outside of $V(B_L) \cup V(B_R)$ with an edge of weight 1. Hence if \prec is any total order extending \prec_1 to $V(H)$, every $v \in V(B_L) \cup V(B_R)$ satisfies $\Delta_{\prec}(v) \leq \tau$. Indeed, vertices in $(V(B_L) \cup V(B_R)) \setminus X$ have no neighbors outside $V(B_L) \cup V(B_R)$.

Let $u \in V(H) \setminus (V(B_L) \cup V(B_R))$, and let s be its weight towards $H - (V(B_L) \cup V(B_R))$. If $s \geq \tau + \gamma + 1$, then u is not adjacent to $V(B_L) \cup V(B_R)$, so any extension \prec of \prec_2 to H keeps $\Delta_{\prec}(u) \leq \tau$. Otherwise, let s_L and s_R be the left weight and right weight of u , respectively (w.r.t. \prec_2). Note that $s_L + s_R = s$. The vertex u has exactly $\tau + \gamma + 1 - s$ neighbors in X , $x_1, \dots, x_{\tau + \gamma + 1 - s}$ via edges of weight 1.

If $s_R > \gamma + 1$, we simply set $x_i \prec u$ for every $i \in [\tau + \gamma + 1 - s]$. The left weight of u in H ordered by \prec is at most $s_L + \tau + \gamma + 1 - s = \tau + \gamma + 1 - s_R \leq \tau$. If instead $s_R \leq \gamma + 1$, we set $x_i \prec u$ for every $i \in [1, \tau - s_L]$, and $u \prec x_i$ for every $i \in [\tau - s_L + 1, \tau + \gamma + 1 - s]$. This is well defined since $\tau - s_L \leq \tau + \gamma + 1 - s$. The left weight of u in H ordered by \prec is at most $s_L + (\tau - s_L) \leq \tau$, and its right weight is $s_R + (\gamma - s + s_L + 1) = \gamma + 1 \leq \tau$. ◀

Theorem 3 is a direct consequence of Lemmas 14 and 15. The reason we “padded the degree” in $H(\varphi)$ will become apparent in the next section. We will observe that when φ is unsatisfiable, not only no linear order can “balance” the degrees, but no tree can either.

3.5 From linear orders to trees

As mim-width is defined via branch decompositions, we adapt the balancing order problem to trees. Consider an edge-weighted graph (H, ω) , and a tree T such that there exists a bijective map $f: V(H) \rightarrow V(T)$. Note that (T, f) is *not* a branch decomposition of H for two reasons: vertices of H are mapped to *all* nodes of T and not merely its leaves, and T is not necessarily a ternary tree (nor a rooted binary tree).

Each edge e of T defines a cut of H , which we denote (A_e, B_e) , where A_e is the preimage by f of one connected component of $T - e$, and B_e , of the other component. We say that (T, f) is a τ -balancing tree of (H, ω) if for any vertex $v \in V(H)$, for any edge $e \in E(T)$ incident to $f(v)$, the sum of the weights of edges (in $E(H)$) incident to v in the cut (A_e, B_e) is at most τ .

TREE DEGREE BALANCING

Parameter: τ

Input: An edge-weighted graph (H, ω) and a non-negative integer τ .

Question: Does (H, ω) admit a τ -balancing tree?

Note that any graph with a τ -balancing order also admits a τ -balancing tree, with T being the path of length $|V(H)|$, and f mapping the vertices of H along T in the τ -balancing order.

► **Theorem 16.** *Given an edge-weighted graph (H, ω) promised to satisfy either one of*

- (H, ω) admits a τ -balancing order or
- (H, ω) does not admit a $(\tau + \gamma)$ -balancing tree,

deciding which outcome holds is NP-hard.

Proof. In the previous reduction, since all the vertices of $H(\varphi)$ but two have degree at least $\tau + \gamma + 1$, any $(\tau + \gamma)$ -balancing tree (T, f) is such that T has at most two leaves, and so T is a path. So in the case when $H(\varphi)$ has no $(\tau + \gamma)$ -balancing order, $H(\varphi)$ has no $(\tau + \gamma)$ -balancing tree. ◀

4 Degree Balancing to Linear Mim-Balancing/Tree Sim-Balancing

In this section, we show how to transfer the degree requirement of DEGREE BALANCING to the induced-matching requirement of MIM- and SIM-BALANCING.

4.1 The Mim-Balancing and Sim-Balancing problems

A *partitioned graph* is a pair (G, \mathcal{S}) where G is a graph and \mathcal{S} is a partition of $V(G)$. A *tree mapping* of a partitioned graph (G, \mathcal{S}) is a pair (T, f) where T is a tree and $f: \mathcal{S} \rightarrow V(T)$ is a bijection from the parts of \mathcal{S} to the vertices of T . When T is a path, we may call (T, f) a *path mapping* of \mathcal{S} .

We say that a cut (A, B) of G is an \mathcal{S} -cut if each set in \mathcal{S} is included in either A or B . Each edge $e \in E(T)$ in a tree mapping (T, f) of (G, \mathcal{S}) defines an \mathcal{S} -cut (A_e, B_e) of G : the union of the parts mapped to each component of $T - e$. The *sim-value* (resp. *mim-value*) of a tree mapping (T, f) of (G, \mathcal{S}) is the maximum taken over every edge $e \in E(T)$ of the maximum size of an induced (resp. semi-induced) matching between A_e and B_e . The *sim-balancing* (resp. *mim-balancing*) of (G, \mathcal{S}) is the minimum sim-value (resp. mim-value) among all possible tree mappings of (G, \mathcal{S}) . Similarly, the *linear sim-balancing* (resp. *mim-balancing*) is the minimum sim-value (resp. mim-value) among paths mappings.

TREE SIM-BALANCING (resp. TREE MIM-BALANCING)

Parameter: τ

Input: A partitioned graph (G, \mathcal{S}) and a non-negative integer τ .

Question: Does (G, \mathcal{S}) admit a tree mapping (T, f) of sim-value (resp. mim-value) τ ?

Note that even when \mathcal{S} is the finest partition $\{\{v\} : v \in V(G)\}$, this problem is not exactly MIM-WIDTH, as f also maps vertices to internal nodes of T , and T has no degree restriction. LINEAR MIM-BALANCING (or LINEAR SIM-BALANCING) is defined analogously except T is forced to be a path. We may use MIM-BALANCING to collectively refer to LINEAR MIM-BALANCING and TREE MIM-BALANCING; and similarly with SIM-BALANCING.

At the end of this section, we will have established the following.

► **Theorem 17.** Let τ, γ be natural numbers satisfying Equation (1) and $\gamma > 50$. Given partitioned graphs (G, \mathcal{S}) such that:

- the linear mim-balancing of (G, \mathcal{S}) is at most $\tau + 50$, or
- the sim-balancing of (G, \mathcal{S}) is at least $\tau + \gamma$,

deciding which of the two outcomes holds is NP-hard.

4.2 Encoding Degree Balancing in Mim/Sim-Balancing

Let (H, ω) be an instance of TREE DEGREE BALANCING with positive and integral weights. We build an instance of TREE MIM-BALANCING $G := G(H, \omega), \mathcal{S} := \mathcal{S}(H, \omega)$, as follows.

Construction of (G, \mathcal{S}) . For every vertex $u \in V(H)$ and every $v \in N_H(u)$, we add an independent set $I(u, v)$ of size $\omega(uv)$ to G . For each vertex $u \in V(H)$, we set

$$S(u) := \bigcup_{v \in N_H(u)} I(u, v).$$

Each $S(u)$ will remain an independent set in G . The partition \mathcal{S} is simply defined as $\{S(u) : u \in V(H)\}$.

We finish the construction by adding two kinds of edges in G , *matching edges* and *dummy edges*. For every pair of disjoint edges uv and xy of H , we add an edge between every vertex of $I(u, v)$ and every vertex of $I(x, y)$. All these edges are called *dummy*. For every $uv \in E(H)$, we add a maximum (perfect) induced matching between $I(u, v)$ and $I(v, u)$. All these edges are called *matching edges*. Observe that $\omega(uv) = \omega(vu)$ (H is undirected), hence $|I(u, v)| = |I(v, u)|$ and the matching between $I(u, v)$ and $I(v, u)$ is indeed perfect. This concludes the construction of (G, \mathcal{S}) ; see Figure 5 for an illustration of the adjacencies between some $S(u)$ and $S(v)$.

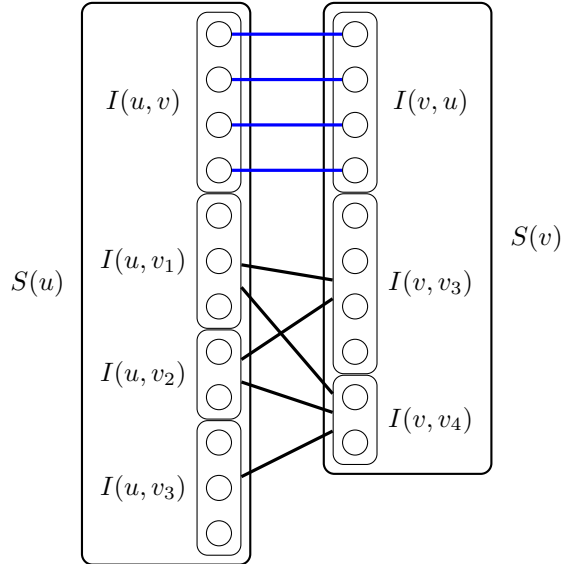

■ **Figure 5** Adjacencies between $S(u)$ and $S(v)$. In this example, u has four neighbors v, v_1, v_2, v_3 , and v has three neighbors u, v_3, v_4 . The matching edges are in blue, the dummy edges are in black (edges between two boxes represent bicliques). Notice the non-edges between $I(u, v_3)$ and $I(v, v_3)$.

We notice that the configuration of the figure actually implies that uvv_3 is a triangle in H , which does not happen in graphs H produced by the previous reduction. However, we

will not use that H is triangle-free in the current section, and Figure 5 shows the general behavior between $S(u)$ and $S(v)$. (For triangle-free graphs H , if $uv \in E(H)$, then there would instead be a biclique between $S(u) \setminus I(u, v)$ and $S(v) \setminus I(v, u)$, and if $uv \notin E(H)$, $I(u, v)$, $I(v, u)$, and the matching edges in between them would simply not exist.)

4.3 Preparatory lemmas

We will now prove some facts about the (semi-)induced matchings of the \mathcal{S} -cuts of G .

► **Lemma 18.** *Let (A, B) be an \mathcal{S} -cut of G . If there is no dummy edge between a vertex of $I(u, v) \subseteq A$ and one from $I(x, y) \subseteq B$, then $u = y$ or $v = x$ or $v = y$.*

Proof. If there is no edge between $I(u, v)$ and $I(x, y)$ in G , then by construction $u = x$ or $u = y$ or $v = x$ or $v = y$. But since (A, B) is an \mathcal{S} -cut that separates $I(u, v)$ from $I(x, y)$, we have $u \neq x$. ◀

► **Lemma 19.** *Let (A, B) be an \mathcal{S} -cut of G . Assume there exists a semi-induced matching $M := \{e_1, \dots, e_m\}$ in G between A and B containing matching edges only. Then a single part of \mathcal{S} covers all the edges of M .*

Proof. Let us denote by $a_i \in A, b_i \in B$ the two endpoints of e_i . Since the edges of M are *matching edges* they are between pairs of sets of the form $I(u, v)$ and $I(v, u)$. Hence, we denote by $I(u_i, v_i) \subseteq A$ the set containing a_i and by $I(v_i, u_i) \subseteq B$ the set containing b_i . Recall that $I(u_i, v_i) \subseteq S(u_i)$ and $I(v_i, u_i) \subseteq S(v_i)$. Thus, as (A, B) is an \mathcal{S} -cut, $S(u_i) \subseteq A$ and $S(v_i) \subseteq B$.

▷ **Claim 20.** For every $i, j \in [m]$, we have $u_i = u_j$ or $v_i = v_j$.

PROOF: Since M is semi-induced, the vertex a_i is not adjacent to b_j , thus $a_i b_j$ is not a dummy edge. By Lemma 18, we have $u_i = u_j$, $v_i = u_j$ or $v_i = v_j$. Since $u_j \in A$ and $v_i \in B$, we have $v_i \neq u_j$. Hence, either $u_i = u_j$ or $v_i = v_j$. ◊

Applying Claim 20 to every pair e_1, e_i for $i \in [m]$, we get that $u_i = u_1$ or $v_i = v_1$ for every $i \in [m]$. If $u_i = u_1$ for all $i \in [m]$, or $v_i = v_1$ for all $i \in [m]$, then $S(u_1)$ or $S(v_1)$ covers M and the lemma holds. Hence, assume there exist $i, j \in [m]$ such that $u_i = u_1$ and $u_j \neq u_1$ and $v_i \neq v_1$ and $v_j = v_1$. Applying Claim 20 to e_i, e_j we get that $u_i = u_j$ or $v_i = v_j$. This implies that $u_j = u_1$ or $v_i = v_1$; a contradiction to the fact $u_j \neq u_1$ and $v_i \neq v_1$. ◀

► **Lemma 21.** *Let (A, B) be an \mathcal{S} -cut of G . If $M := \{a_1 b_1, \dots, a_t b_t\}$ is a semi-induced matching in G between A and B only made of dummy edges, and all the vertices a_i lie in the same part of \mathcal{S} included in A , then $t \leq 6$.*

Proof. Let $S(u)$ be the part of \mathcal{S} including $\{a_1, \dots, a_t\}$. Let us denote by $I(u, v_i) \subseteq A$ the set containing a_i and by $I(x_i, y_i) \subseteq B$ the set containing b_i . By definition of the dummy edges, for every $i \in [t]$, we have

$$v_i \neq x_i \text{ and } u \neq y_i \text{ and } v_i \neq y_i. \quad (2)$$

Let $A_M = \{a_1, \dots, a_t\}$ and $B_M = \{b_1, \dots, b_t\}$. Observe that for every $i \neq j \in [m]$, since M is a semi-induced matching $a_i b_j$ is not a edge of G , by Lemma 18, we have $u = y_j$ or $v_i = x_j$ or $v_i = y_j$, but from Condition (2) we know that $u \neq x_j$. Thus, for every $i \neq j \in [m]$, we have

$$v_i = x_j \text{ or } v_i = y_j. \quad (3)$$

We first prove that any part of \mathcal{S} contains at most two vertices of B_M . Indeed, assume (without loss of generality) that b_1, b_2 and b_3 are all in a single part of \mathcal{S} , i.e., $x := x_1 = x_2 = x_3$. From (3), we have $v_i = x$ or $v_i = y_j$, for every $i \neq j \in [3]$. However, by Condition (2), we get that $v_i \neq x$. Thus, only one disjunct remains: $v_i = y_j$. But then $v_1 = y_2 = v_3 = y_1$, and $v_1 = y_1$ contradicts (2).

Thus, any part of \mathcal{S} contains at most two vertices of B_M . And in particular, for every $i \in [t]$, $|S(v_i) \cap B_M| \leq 2$. For every $i \neq j$, we know from (3) that $v_i = x_j$ or $v_i = y_j$. For a fixed i , only two vertices of B_M can satisfy the first disjunct, thus, we have $v_i = y_j$ for at least $t - 1 - 2 = t - 3$ of the indices $j \in [t] \setminus \{i\}$.

Assume for the sake of contradiction that $t > 6$. We have $2 \cdot (t - 3) > t$, so for every $i, j \in [t]$, $\{k : y_k = v_i\} \cap \{k : y_k = v_j\} \neq \emptyset$, which implies that $v_i = v_j$. Hence since there exist i, k with $y_k = v_i$, and as $v_i = v_k$, we have $v_k = y_k$; contradicting (2). \blacktriangleleft

► Lemma 22. *Let (A, B) be a \mathcal{S} -cut of (G, \mathcal{S}) with a semi-induced matching $\{e_1, \dots, e_m\}$ between A and B . Then at least $m - 50$ edges among $\{e_1, \dots, e_m\}$ are matching edges.*

Proof. Up to reordering, assume that $D := \{e_1, \dots, e_t\}$ are the dummy edges of $\{e_1, \dots, e_m\}$ for some $t \in [m]$. We denote by $a_i \in A, b_i \in B$ the endpoints of e_i , and by $I(u_i, v_i) \subseteq A$ the set containing a_i and by $I(x_i, y_i) \subseteq B$ the set containing b_i .

By definition of the dummy edges, we have that for every $i \in [t]$,

$$v_i \neq x_i \text{ and } u_i \neq y_i \text{ and } v_i \neq y_i. \quad (4)$$

Let us consider the auxiliary directed graph Aux where $V(\text{Aux}) := D$, and $E(\text{Aux})$ contains the arc (e_i, e_j) whenever $y_i = u_j$ or $v_i = x_j$. By Lemma 21, each part of \mathcal{S} contains at most 6 vertices of $\{a_1, \dots, a_t\} \cup \{b_1, \dots, b_t\}$. Therefore, each of the disjuncts $(y_i = u_j$ or $v_i = x_j)$ creates at most 6 outgoing arcs from e_i . Hence Aux has maximum outdegree at most 12. Thus the underlying undirected graph J of Aux is 24-degenerate. Thus J admits an independent set U of size $\lceil |D|/25 \rceil$.

Assume for the sake of contradiction that $t > 50$, hence that $|U| \geq 3$. Without loss of generality, say that $e_1, e_2, e_3 \in U$. Since M is semi-induced, for every $i \neq j \in [t]$, $a_i b_j$ is not a dummy edge, thus by Lemma 18 we have $v_i = x_j$ or $u_i = y_j$ or $v_i = y_j$. But when i and j are restricted to $\{1, 2, 3\}$, there is no arc in Aux between e_i and e_j , so $v_i \neq x_j$ and $u_i \neq y_j$. Hence only the third disjunct can hold. Hence we have $v_1 = y_2 = v_3 = y_1$, and $v_1 = y_1$ contradicts (4). \blacktriangleleft

4.4 Correctness of the reduction

We can now show the correctness of the reduction.

► Lemma 23. *If (G, \mathcal{S}) admits a tree mapping (T, f) of sim-value t , then (H, ω) admits a t -balancing tree.*

Proof. Consider a tree mapping (T, f) of sim-value at most t . We keep the same tree T and define the map $f' : V(H) \rightarrow V(T)$ with $f'(v) := f(S(v))$. We will show that (T, f') is a t -balancing tree of H .

Consider an edge $e \in E(T)$. Let (A_e^H, B_e^H) (resp. (A_e^G, B_e^G)) be the cut in H (resp. in G) defined by e , such that for every $v \in V(H)$, $v \in A_e^H$ if and only if $S(v) \subseteq A_e^G$. Note that (A_e^G, B_e^G) is an \mathcal{S} -cut. Consider a vertex $v \in V(H)$. Up to swapping A_e^H and B_e^H (and A_e^G and B_e^G accordingly), we may assume that $v \in A_e^H$. Consider u_1, \dots, u_p an enumeration of $N_H(v) \cap B_e^H$. Now consider M , the set of all matching edges in G going from $S(v)$ to $S(u_1) \cup \dots \cup S(u_p)$. By construction $|M| = \sum_{i \in [p]} \omega(vu_i)$.

We prove that M is an induced matching between A_e^G and B_e^G . Let us denote by a_1b_1, \dots, a_mb_m the edges of M with $a_i \in S(v)$ for each $i \in [m]$. Note that $a_i \in A_e^G$ and $b_i \in B_e^G$. Since M is made of matching edges, for every $i \in [m]$, there exists a vertex $x_i \in \{u_1, \dots, u_p\}$ such that $b_i \in I(x_i, v)$. Two vertices a_i and a_j are not adjacent since $S(v)$ is an independent set. By construction, b_ib_j is not a dummy edge of G since $b_i \in I(x_i, v)$ and $b_j \in I(x_j, v)$. This is also the case for a_ib_j since $a_i \in I(v, x_i)$ and $b_j \in I(x_j, v)$, and it holds also for a_jb_i by symmetry. As every vertex of G is incident to at most one matching edge, M is indeed an induced matching in G between A_e^G and B_e^G .

Since the sim-value of (T, f) is t , we have $|M| \leq t$, and so $\sum_{i \in [p]} \omega(vu_i) \leq t$. This upper bound was shown for every $e \in E(T)$ and $v \in V(H)$, so (T, f') is a t -balancing tree of H . ◀

► **Lemma 24.** *If H admits a τ -balancing order, then there is a path mapping (P, f) of mim-value at most $\tau + 50$.*

Moreover, for every cut (A_e, B_e) induced by an edge $e \in E(P)$ and every semi-induced matching M between A_e and B_e , M has at most τ matching edges and there exists $u \in V(H)$ such that $S(u)$ covers the matching edges of M .

Proof. Let \prec be a τ -balancing order of H . Let us call $v_1 \prec \dots \prec v_n$ the vertices of H . We define $P := p_1 \dots p_n$ as be the path of order n , and f as the map $S(v_i) \mapsto p_i$. It remains to bound the mim-value of (P, f) .

Consider any $i \in [n - 1]$ and the edge $e = p_ip_{i+1} \in E(P)$, and let (A_e, B_e) the cut of G such that $S(v_1), \dots, S(v_i) \subseteq A_e$, and $S(v_{i+1}), \dots, S(v_n) \subseteq B_e$. Let $M = \{e_1, \dots, e_m\}$ be a semi-induced matching between A_e and B_e . By Lemma 22, one can assume that $M' := \{e_1, \dots, e_{m-50}\}$ contains only matching edges. By Lemma 19, all the edges in M' are incident to a same part, say $S(u)$.

This implies that all edges of M' are of the form a_jb_j with $a_j \in S(u)$ and b_j in some $S(v_j)$ with $uv_j \in E(H)$. By construction of P , we either have $\{v_1, \dots, v_{|M'|}\} \prec u$, or $u \prec \{v_1, \dots, v_{|M'|}\}$. In particular, $|M'|$ is at most the maximum between the left weight and the right weight of u , which is at most τ . Hence $|M| \leq \tau + 50$, and since this applies to any edge of P , the mim-value of (P, f) is at most $\tau + 50$. ◀

5 Mim/Sim-Balancing to Linear Mim-Width/Sim-Width

The next reduction uses two constants $a := 45$ and $b := 6\tau(\tau + \gamma) + 1$. With the announced values of $\tau = 1080$ and $\gamma = 135$, we have $b = 7873201$. We remark that the value of b will not affect the linear mim-width upper bound nor the sim-width lower bound. (The constant b should simply be that large to make our proofs work.)

Let (H, ω) be an instance of TREE DEGREE BALANCING where all edge weights are positive multiples of a and H is triangle-free. We build a graph G^* , such that if H has a τ -balancing order, then the linear mim-width of G^* is at most $\frac{a+1}{a}\tau + 107$; and if H has no $(\tau + \gamma)$ -balancing tree, then the sim-width of G^* is at least $\tau + \gamma$. We construct G^* from the instance $G := G(H), \mathcal{S} := \mathcal{S}(H)$ of TREE MIM-BALANCING from the previous reduction. Remember that $\mathcal{S} = \{S(u) : u \in V(H)\}$.

The main goal of this reduction is to obtain a graph G^* whose sim-width and linear mim-width are related to the the sim-balancing and linear mim-balancing of (G, \mathcal{S}) , respectively. Observe that we cannot simply set $G^* := G$ since a layout (T, f) of G can scatter each $S(u)$ so that for each matching edge xy of G , x and y are placed at leaves of T sharing a neighbor in T . Consequently, the only cuts (A, B) induced by the edges of T with a matching edge

between A and B are rather trivial (A or B is a singleton). Thus, the sim-width of G could be uncontrollably smaller than the sim-balancing of (G, \mathcal{S}) .

To prevent this, we design a gadget $\mathcal{G}(u)$ for each $u \in V(H)$ from b copies of $S(u)$. These gadgets ensure that any tree layout (T, f) of G^* of sim-value at most $\tau + \gamma - 1$ behaves similarly to a tree mapping of (G, \mathcal{S}) in the sense that for every $S(u)$, there is an edge e of T such that both sides of the induced cut (A_e, B_e) contain a copy of $S(u)$. Using this property, we prove that the sim-width of G^* is at least the sim-balancing of (G, \mathcal{S}) .

The final lemma from each of the two last subsections prove Theorem 2 (hence Theorem 1), which we restate here.

► **Theorem 25.** *Let τ, γ, a be natural numbers as previously defined. Given graphs G such that either*

- *the linear mim-width of G is at most $\frac{a+1}{a}\tau + 107$, or*
- *the sim-width of G is at least $\tau + \gamma + 1$,*

deciding which of the two outcomes holds is NP-hard.

One can indeed check that with the announced values for τ, γ, a , we have $\frac{a+1}{a}\tau + 107 = 1211$ and $\tau + \gamma + 1 = 1216$.

5.1 Encoding Mim/Sim-Balancing in Mim/Sim-Width

We start with the description of a gadget for each vertex of H .

Construction of $\mathcal{G}(u)$. For each vertex $u \in V(H)$, the *gadget of u* , denoted by $\mathcal{G}(u)$, is a graph spanned by a path Q_u of length $2b \cdot |S(u)|$ made by *concatenating* b copies of a path P_u . The path P_u is built as follows. Recall that in the graph G , the set $S(u)$ partitions into $I(u, v_1) \uplus \dots \uplus I(u, v_k)$ where $\{v_1, \dots, v_k\} = N_H(u)$. Since all weights are multiples of a , $|I(u, v)|$ is a multiple of a for any edge $uv \in E(H)$. Hence we can write each $I(u, v)$ as a disjoint union $I(u, v, 1) \uplus \dots \uplus I(u, v, a)$ where each $I(u, v, i)$ has size $\frac{|I(u, v)|}{a}$.

We construct the path L_i whose vertex set is $I(u, v_1, i) \cup I(u, v_2, i) \cup \dots \cup I(u, v_k, i)$, and whose vertices occur in this order along L_i . We define L as the concatenation $L_1 L_2 \dots L_a$, i.e., the last vertex of L_i is made adjacent to the first vertex of L_{i+1} , for every $i \in [a - 1]$. The path P_u is obtained from the 1-subdivision of L by adding a vertex adjacent to the last vertex of L_a ; see Figure 6.

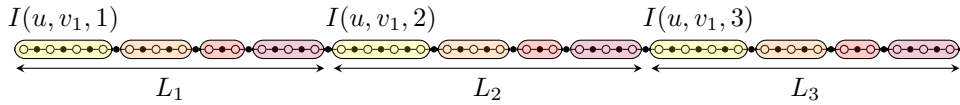

■ **Figure 6** The path P_u for a vertex u with four neighbors v_1, v_2, v_3, v_4 , and $a = 3$. The sizes of $I(u, v_1)$, $I(u, v_2)$, $I(u, v_3)$, $I(u, v_4)$ are 12, 9, 6, 9, respectively; all divisible by a . The labels $I(u, v_1, \bullet)$ and L_\bullet refer to the white vertices, while P_u also comprises the subdivision vertices in black.

We obtain the path Q_u by concatenating b copies $P_u^1, P_u^2, \dots, P_u^b$ of P_u . Note that each vertex x of P_u has b copies x_1, \dots, x_b in Q_u ; for each $y \in \{x, x_1, \dots, x_b\}$, we denote by $\text{Copies}(y)$ the set $\{x_1, \dots, x_b\}$. The gadget $\mathcal{G}(u)$ is obtained from Q_u by adding an edge between every pair of vertices x, y in two distinct P_u^i, P_u^j except if y is in $N_{Q_u}[\text{Copies}(x)]$; see Figure 7.

Construction of G^* . Finally, we construct G^* as follows (based on the vertex set of H , and the edge set of G). For each vertex $u \in V(H)$, we add a gadget $\mathcal{G}(u)$ to G^* . For

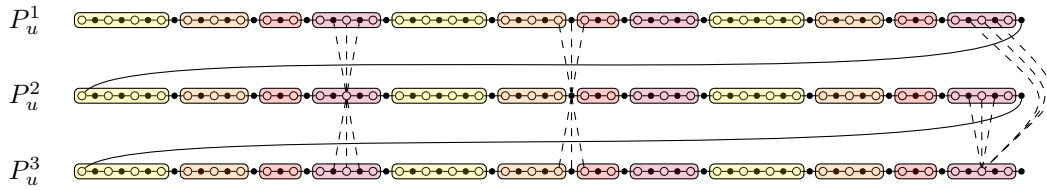

■ **Figure 7** The gadget $\mathcal{G}(u)$ for the path P_u of Figure 6 and $b = 3$. We drew the non-edges between distinct copies of P_u (dashed edges) incident to only three vertices (one subdivision vertex in P_u^2 , and two regular vertices in P_u^2 and P_u^3). Each path P_u^i remains induced in $\mathcal{G}(u)$.

every edge $xy \in E(G)$, we add the biclique between $\text{Copies}(x)$ and $\text{Copies}(y)$ in G^* . If xy is a matching edge of G , the added edges are also said *matching* (see Figure 8). Similarly if xy is a dummy edge, we call the added edges *dummy* (see Figure 9).

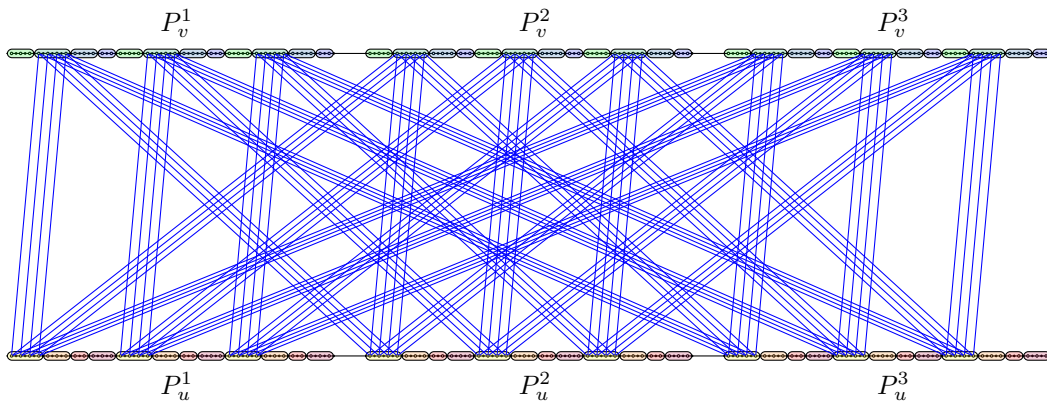

■ **Figure 8** The matching edges between $\mathcal{G}(u)$ and $\mathcal{G}(v)$ (with u and v two adjacent vertices in H).

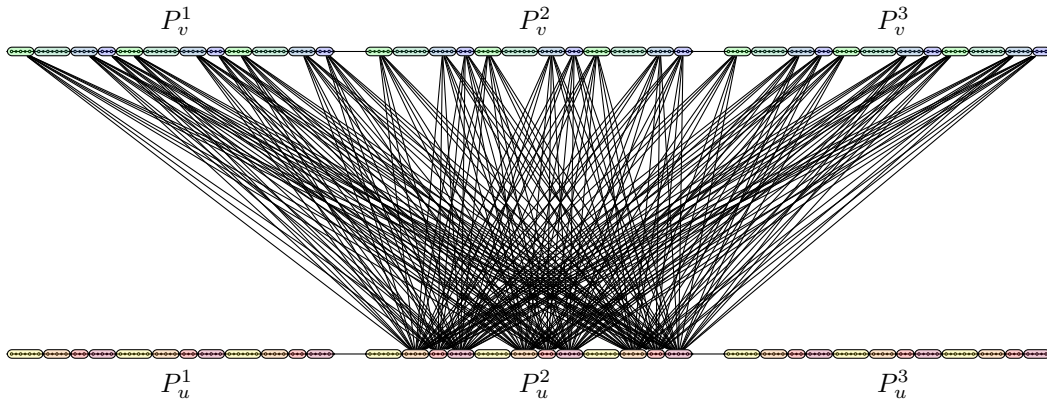

■ **Figure 9** The dummy edges between $\mathcal{G}(u)$ and $\mathcal{G}(v)$ of Figure 8. An edge between two rounded boxes represents a biclique between the corresponding vertices of $I(\bullet, \bullet, \bullet)$ (which excludes the subdivision vertices). We only represented the bicliques incident to P_u^2 (P_u^1 and P_u^3 have the same adjacencies toward $\mathcal{G}(v)$).

5.2 Low linear mim-balancing of $(G, \mathcal{P}) \Rightarrow$ low linear-mim width of G^*

To upper bound the linear mim-width of G^* , we need the next lemma on $\mathcal{G}(u)$. For each vertex u of H , we define the *caterpillar layout* of $\mathcal{G}(u)$ as the *left-aligned* caterpillar (i.e, such that every right child is a leaf) layout with $|V(\mathcal{G}(u))|$ leaves bijectively labeled by $V(\mathcal{G}(u))$, in the order of Q_u from the first vertex of P_u^1 to the last vertex of P_u^b .

► **Lemma 26.** *Let u be a vertex of H , and (C, f) be the caterpillar layout of $\mathcal{G}(u)$. For every cut (A, B) of $\mathcal{G}(u)$ induced by an edge of C , the mim-value of (A, B) is at most 7.*

Proof. Let (A, B) be a cut induced by an edge of C . Since the leaves of C are bijectively mapped f to $V(\mathcal{G}(u))$ in the order of Q_u , there is exactly one edge e_{Q_u} between A and B that belongs to Q_u . Let P_u^i be the copy of P_u such that e_{Q_u} is either an edge of P_u^i or the edge between P_u^{i-1} and P_u^i .

Let M be an induced matching of $\mathcal{G}(u)[A, B]$ of size at least 2. Let X and Y be the endpoints of the edges of M lying in A and B , respectively. Observe that there exists at least one vertex in $X \cup Y$ that is neither on P_u^i nor an endpoint of e_{Q_u} . Indeed, we have two cases to consider:

- Case 1: e_{Q_u} is the edge between P_u^{i-1} and P_u^i . Then, $V(P_u^i)$ is fully included in either A or B , and since the sizes of X and Y are at least 2, it follows that at least one vertex in $X \cup Y$ is neither on P_u^i nor an endpoint of e_{Q_u} .
- Case 2: e_{Q_u} is an edge of P_u^i . Then, since M contains at least two edges and e_{Q_u} is the only edge of P_u^i between A and B , at least one vertex in $X \cup Y$ is not on P_u^i (and thus not an endpoint of e_{Q_u}).

We assume, without loss of generality, that X contains a vertex x that is neither on P_u^i nor an endpoint of e_{Q_u} (we can always swap X and Y). In the following, we prove that x has at most 6 non-neighbors in Y . This is sufficient to prove the lemma as it implies that the size of Y , and thus of M , is at most 7; as desired.

Let P_u^j be the copy of P_u containing x . Observe that we have $i \neq j$ and thus all the vertices of P_u^j belong to A . We denote by x^- and x^+ the neighbors of x in P_u^j (we may have $x^- = x^+$ when x is an endpoint of P_u^j). Since all the vertices of P_u^j belong to A and x is not incident to e_{Q_u} , we have $B \setminus N_{\mathcal{G}(u)}(x) = B \cap (\text{Copies}(x) \cup \text{Copies}(x^-) \cup \text{Copies}(x^+))$. Since P_u^i contains exactly one copy of each vertex among x, x^- and x^+ , it follows that x has at most 3 non-neighbors in $B \cap V(P_u^i)$ and in particular in $Y \cap V(P_u^i)$. It remains to prove that $Y \setminus V(P_u^i)$ contains at most 3 non-neighbors of x . Observe that for each $y \in \{x, x^-, x^+\}$ and every pair of vertices w, z in $(B \cap \text{Copies}(y)) \setminus V(P_u^i)$, we have $N_{\mathcal{G}(u)}(w) \cap A = N_{\mathcal{G}(u)}(z) \cap A$ and thus at most one vertex among w and z can be in Y . We conclude that x has at most 3 non-neighbors in $Y \setminus V(P_u^i)$ and thus $|Y| = |M| \leq 7$. ◀

We can now conclude for this direction of the reduction.

► **Lemma 27.** *If (H, ω) admits a τ -balancing order, then the linear mim-width of G^* is at most $\frac{a+1}{a}\tau + 107$.*

Proof. Suppose that (H, ω) admits a τ -balancing order \prec . By Lemma 24, G admits a path mapping (P, f) of mim-value at most $\tau + 50$. We construct from \prec a caterpillar layout C of G^* , and leverage the mim-value of (P, f) to show that the mim-value of C is at most $\frac{a+1}{a}\tau + 107$.

For every $i \in [|V(H)|]$, we denote by u_i the i -th vertex of H along \prec . We denote by C_i the caterpillar layout of $\mathcal{G}(u_i)$, and we denote by S_i the spine of C_i . We construct a caterpillar layout C of G^* from the disjoint union of $C_1, \dots, C_{|V(H)|}$ by adding an edge

between the last vertex of S_i and the first vertex of S_{i+1} for each $i \in [|V(H) - 1|]$. Let $\mathcal{S}^* := \{V(\mathcal{G}(u)) : u \in V(H)\}$. Let us recall that an \mathcal{S}^* -cut (A, B) is a cut of G^* such that no gadget $\mathcal{G}(u)$ has vertices in both A and B . Observe that a cut induced by an edge e of C is an \mathcal{S}^* -cut if and only if e is an edge between two caterpillars C_i and C_{i+1} .

▷ **Claim 28.** Every \mathcal{S}^* -cut (A, B) induced by an edge of C has mim-value at most $\tau + 50$. Moreover, every semi-induced matching M of G^* between A and B has at most τ matching edges, and there exists $u \in V(H)$ such that $V(\mathcal{G}(u))$ covers the matching edges of M .

PROOF: Let (A, B) be a \mathcal{S}^* -cut induced by an edge e of C . Let $i \in [|V(H) - 1|]$ such that e is the edge between C_i and C_{i+1} . We denote by e_P the i -th edge of P (recall that (P, f) is a path mapping of G) and by $(A_P, B_P) := (A_{e_P}, B_{e_P})$ the cut of G induced by e_P . Let M be a semi-induced matching of G^* between A and B .

We claim that $|M| \leq \text{mim}_G(A_P, B_P)$. Observe that A_P is the union of $S(u_1), \dots, S(u_i)$ and B_P is the union of $S(u_{i+1}), \dots, S(u_{|V(H)|})$. Similarly, A is the union of $\mathcal{G}(u_1), \dots, \mathcal{G}(u_i)$ and B is the union of $\mathcal{G}(u_{i+1}), \dots, \mathcal{G}(u_{|V(H)|})$. For every vertex v of G , we say that v is the *original* of the vertices of G^* in $\text{Copies}(v)$.

Since (A, B) is a \mathcal{S}^* -cut, every edge in $G^*[A, B]$ is between two different gadgets of G^* . By construction of G^* , for every edge xy between two gadgets $\mathcal{G}(u_i)$ and $\mathcal{G}(u_j)$, the vertices x and y are the copies of some vertices in G . Hence, every endpoint of an edge in M has an original in G .

By construction of G^* , for all vertices x and y in G^* with distinct originals w and z in G , we have $xy \in E(G^*)$ if and only if $wz \in E(G)$. Hence, by replacing every edge xy in M by a pair $\{w, z\}$ where w and z are the originals of x and y , respectively, we obtain a semi-induced matching $|M_P|$ between A_P and B_P . Hence, we have $|M| \leq |M_P| \leq \text{mim}_G(A_P, B_P)$. As the mim-value of (P, f) is at most $\tau + 50$, we conclude that the size of M is at most $\tau + 50$.

By Lemma 24, we know that M_P has at most τ matching edges and that there exists $u \in V(H)$ such that $S(u)$ covers the matching edges of M_P . As the copies of the vertices in $S(u)$ are all in $\mathcal{G}(u)$, the vertices in $\mathcal{G}(u)$ cover the matching edges of M . ◊

Next we deal with the cuts of C that are not \mathcal{S}^* -cuts. Let (A, B) be a cut induced by an edge e of C that is not a \mathcal{S}^* -cut. Then, there exists $k \in [|V(H)|]$ such that e is the edge of some caterpillar layout C_k . If a leaf of C_k is incident to e , then A or B is a singleton (containing exactly one vertex in $\mathcal{G}(u_k)$) and $\text{mim}_{G^*}(A, B) \leq 1$. In the remainder of the proof, we assume that e is an edge from the spine of C_k .

Let $M = \{e_1, \dots, e_m\}$ be a semi-induced matching between A and B . By Lemma 26, we can assume that $M' := \{e_1, \dots, e_{m-7}\}$ contains no edge within $\mathcal{G}(u_k)$. We denote by A_k and B_k the sets of vertices of $\mathcal{G}(u_k)$ that are respectively in A and B . Let M_A (resp. M_B) be the sets of edges in M between A and $B \setminus B_k$ (resp. between B and $A \setminus A_k$). Observe that the edges of M_A are traversing the cut $(A \cup B_k, B \setminus B_k)$ which is a \mathcal{S}^* -cut induced by an edge of C . Symmetrically, the edges of M_B are also traversing a \mathcal{S}^* -cut induced by an edge of C . From Claim 28, for each $X \in \{A, B\}$, we know that M_X has at most $\tau + 50$ edges and at most τ matching edges, moreover there exists $v_X \in V(H)$ such that $V(\mathcal{G}(v_X))$ covers the matching edges of M_X . Let $\widehat{M}, \widehat{M}_A$ and \widehat{M}_B be the sets of matching edges from respectively M', M_A and M_B . Since $\widehat{M} = \widehat{M}_A \cup \widehat{M}_B$, and we remove at most 50 edges from M_A and M_B to obtain respectively \widehat{M}_A and \widehat{M}_B , we have

$$|M| \leq |\widehat{M}| + 107. \quad (5)$$

▷ **Claim 29.** There exists $v \in \{v_A, v_B, u_k\}$ such that $V(\mathcal{G}(v))$ covers \widehat{M} .

PROOF: Assume toward a contradiction that the claim is false. As $V(\mathcal{G}(v_A))$ covers \widehat{M}_A but not \widehat{M} , it means that there exists at least one edge e_A in $\widehat{M} \setminus \widehat{M}_A$ not incident to $V(\mathcal{G}(v_A))$. As $e_A \notin \widehat{M}_A$, this edge must be in \widehat{M}_B between A and B_k , so it must be covered by $V(\mathcal{G}(v_B))$. Since $B_k \subseteq V(\mathcal{G}(u_k))$, e_A is a matching edge between $\mathcal{G}(v_B)$ and $\mathcal{G}(u_k)$. Symmetrically, we deduce that there is a matching edge between $\mathcal{G}(v_A)$ and $\mathcal{G}(u_k)$ (because $V(\mathcal{G}(v_B))$ covers \widehat{M}_B but not \widehat{M}). Moreover, as $V(\mathcal{G}(u_k))$ does not cover \widehat{M} , there exists an edge e_{u_k} in \widehat{M} not adjacent to $\mathcal{G}(u_k)$. As A_k and B_k are subsets of $V(\mathcal{G}(u_k))$, e_{u_k} must be in \widehat{M}_A and \widehat{M}_B , so it must be covered by both $V(\mathcal{G}(v_A))$ and $V(\mathcal{G}(v_B))$. So there is at least one matching edge between every pair of gadgets among $\mathcal{G}(v_A)$, $\mathcal{G}(v_B)$ and $\mathcal{G}(u_k)$. From the construction of G^* , it means that there is at least one matching edge between $S(v_A)$, $S(v_B)$ and $S(u_k)$. Recall that a matching edge in G between two parts of $S(u)$, $S(v)$ in \mathcal{S} implies that uv is an edge of H . Consequently, v_A, v_B and u_k induce a triangle in H , a contradiction with H being triangle-free. \diamond

First, suppose that $v_A \neq u_k$ and that $V(\mathcal{G}(v_A))$ covers \widehat{M} . As $v_A \neq u_k$, there is no edge in \widehat{M} between A_k and B (such edges would not be covered by $V(\mathcal{G}(v_A))$). So, we have $\widehat{M} = \widehat{M}_A$ and since $|\widehat{M}_A| \leq \tau$, it follows by Equation (5) that $|M| \leq \tau + 107$. By symmetry, the above holds also when $v_B \neq u_k$ and $V(\mathcal{G}(v_B))$ covers \widehat{M} .

Now, we assume that $V(\mathcal{G}(u_k))$ covers \widehat{M} . We distinguish two cases.

- Case 1: There exists $\ell \in [b]$ such that $V(P_{u_k}^\ell) \subseteq A$ and at least one endpoint x of \widehat{M} is on $P_{u_k}^\ell$. We claim that \widehat{M} has at most 3 edges with endpoints in B_k . Recall that \widehat{M} has only matching edges, so every edge of \widehat{M} is between two distinct gadgets. In particular, the endpoints of \widehat{M} in B_k must be non-neighbors of x and adjacent via \widehat{M} to a vertex in $A \setminus A_k$. Since $V(P_{u_k}^\ell) \subseteq A$, the non-neighborhood of x in B_k is exactly $B_k \cap (\text{Copies}(x) \cup \text{Copies}(x^-) \cup \text{Copies}(x^+))$, where x^- and x^+ are the neighbors of x in $P_{u_k}^\ell$ (possibly with $x^- = x^+$). Thus, the endpoints of \widehat{M} in B_k must be in $\text{Copies}(x) \cup \text{Copies}(x^-) \cup \text{Copies}(x^+)$. However, for each $y \in \{x, x^-, x^+\}$, the vertices in $B_k \cap \text{Copies}(y)$ have the same neighborhood in $A \setminus A_k$. We deduce that \widehat{M} has at most 3 endpoints in B_k . By removing the edges of \widehat{M} with an endpoint in B_k , we obtain \widehat{M}_A which contains at most τ edges. Hence, we have $|\widehat{M}| \leq \tau + 3$ and by Equation (5), it follows that $|M| \leq \tau + 110$.
- Case 2: There exists $\ell \in [b]$ such that $P_{u_k}^\ell$ has vertices in both A and B , and every endpoint of \widehat{M} in $V(\mathcal{G}(u_k))$ is from $P_{u_k}^\ell$. Here, we have to use the balanced distribution of the copies of vertices from $S(u_k)$ along the path $P_{u_k}^\ell$. Recall that \widehat{M} contains only matching edges with one endpoint on $P_{u_k}^\ell$. Thus, for every edge xy of \widehat{M} with x on $P_{u_k}^\ell$, there exists $v \in N_H(u_k)$ such that y is from $\mathcal{G}(v)$; in particular, x and y are the copies of vertices in $I(u_k, v)$ and $I(v, u_k)$, respectively. In this setting, we call xy a $u_k v$ -edge. For each $X \in \{A, B\}$, let $N_H(u_k)^X$ be set of neighbors v of u_k in H such that all the vertices of $\mathcal{G}(v)$ are in X . Notice that each edge in \widehat{M}_X is an $u_k v$ -edge with $v \in N_H(u_k)^X$. For every $u_k v$ -edge xy of \widehat{M} where y is from $\mathcal{G}(v)$, we assume without loss of generality that the vertex y is from P_v^1 . This assumption can be made since the vertices in $\text{Copies}(y)$ have the same neighborhood in $G^*[A, B]$, so we can always replace y in \widehat{M} with its copy in the path P_v^1 . For each $v \in N_H(u_k)$, let $M_{u_k v}$ be the induced matching of size $\omega(u_k v)$ made of the matching edges between $P_{u_k}^\ell$ and P_v^1 . For each $X \in \{A, B\}$, we define M_X^* as the union of the matchings $M_{u_k v}$ over the vertices $v \in N_H(u_k)^X$. By our previous assumption on \widehat{M} , we have $\widehat{M}_A \subseteq M_A^*$ and $\widehat{M}_B \subseteq M_B^*$. As M_A^* contains only matching edges that traverse the \mathcal{S}^* -cut $(A \setminus A_k, B \cup A_k)$, we know that $|M_A^*| \leq \tau$ by Claim 28. Symmetrically, We have $|M_B^*| \leq \tau$.

Recall that from the construction of P_{u_k} , the path $P_{u_k}^\ell$ is the concatenation of a paths P'_1, \dots, P'_a such that for each $i \in [a]$ and $v \in N_H(u_k)$, P'_i contains $\frac{\omega(u_k v)}{a}$ endpoints of $M_{u_k v}$. Let $t \in [a]$ be such that the first vertex of $P_{u_k}^\ell$ in B is from P'_t . Observe that all the vertices from P'_1, \dots, P'_{t-1} belong to A and all the vertices from P'_{t+1}, \dots, P'_a belong to B . Moreover, P'_t is the only path among P'_1, \dots, P'_a that can have vertices in both A and B . Consequently, for every $v \in N_H(u_k)$, the endpoints of $M_{u_k v}$ in A_k lie in P'_1, \dots, P'_t and those in B_k lie in P'_t, \dots, P'_a . So, $M_{u_k v}$ has at most $\omega(u_k v)t/a$ endpoints in A_k and $\omega(u_k v)(a-t+1)/a$ endpoints in B_k . We deduce that:

- M_A has at most $(a-t+1)/a$ endpoints in B_k ,
- M_B has at most t/a endpoints in A_k .

As every edge in \widehat{M}_A is between A and B_k , it follows that $|\widehat{M}_A| \leq \frac{a-t+1}{a}|M_A^*|$. Symmetrically, we have $|\widehat{M}_B| \leq \frac{t}{a}|M_B^*|$. Since the sizes of M_A^* and M_B^* are at most τ , we have

$$|\widehat{M}| = |\widehat{M}_A| + |\widehat{M}_B| \leq \frac{a-t+1}{a}|M_A^*| + \frac{t}{a}|M_B^*| \leq \frac{a+1}{a}\tau.$$

By Equation (5), we get that $|M| \leq \frac{a+1}{a}\tau + 107$.

We conclude that M has at most $\max(\tau + 110, \frac{a+1}{a}\tau + 107) = \frac{a+1}{a}\tau + 107$ edges (since $\tau \geq 3a$). ◀

5.3 Low sim-width of $G^* \Rightarrow$ low sim-balancing of (G, \mathcal{P})

The main argument works as follows. We will prove that in any tree layout of G^* of small sim-value, one can associate to each gadget $\mathcal{G}(u)$ an edge e of the layout, such that a copy of P_u can be found on both sides of the cut defined by e . Since $\mathcal{G}(u)$ is “represented” by any of its copies of P_u , we will use e as where the vertices of $\mathcal{G}(u)$ should be moved to. With this in mind, we gradually build a tree mapping of G from a tree layout of G^* by “relocating” each gadget to the edge it is associated to.

We start with two technical lemmas.

► **Lemma 30.** *Let P_1, \dots, P_k be k paths with $k > t \cdot \max_{i \in [k]} |V(P_i)|$ such that for any $i \neq j \in [k]$ and any $\ell \in [\min(|V(P_i)|, |V(P_j)|) - 1]$, the ℓ -th edge of P_i is mutually induced with the ℓ -th edge of P_j . Then for any cut (A, B) of sim-value at most t , there exists at least one path P_i such that $V(P_i) \subseteq A$ or $V(P_i) \subseteq B$.*

Proof. Let (A, B) be a cut such that every path P_i intersects both A and B . We claim that the mim-value of (A, B) is at least $t + 1$. Observe that for each $i \in [k]$, P_i has at least one edge e_i with one endpoint in A and the other in B . Since $k > t \cdot \max_{i \in [k]} |V(P_i)|$, from the pigeonhole principle, there exists i_1, \dots, i_{t+1} such that the edges $e_{i_1}, \dots, e_{i_{t+1}}$ are the ℓ -th edges of respectively $P_{i_1}, \dots, P_{i_{t+1}}$ for some ℓ . Thus, by assumption, $e_{i_1}, \dots, e_{i_{t+1}}$ form an induced matching, and the sim-value of (A, B) is at least $t + 1$. ◀

► **Lemma 31.** *Let P_1, \dots, P_k be k paths with $k > \lceil \frac{3t}{2} \rceil \cdot \max_{i \in [k]} |V(P_i)|$ such that for any $i \neq j \in [k]$ and any $\ell \in [\min(|V(P_i)|, |V(P_j)|) - 1]$, the ℓ -th edge of P_i is mutually induced with the ℓ -th edge of P_j . Then for any tripartition (A, B, C) of $V(P_1) \cup \dots \cup V(P_k)$ such that the cuts $(A, B \cup C)$, $(B, A \cup C)$ and $(C, A \cup B)$ have sim-value at most t , there exists at least one path P_i such that $V(P_i)$ is included in one set among A , B and C .*

Proof. Let (A, B, C) be a tripartition of $V(P_1) \cup \dots \cup V(P_k)$ such that every path P_i intersects at least two sets among A, B and C . We claim that the sim-value of one cut among $(A, B \cup C)$, $(B, A \cup C)$ and $(C, A \cup B)$ is at least $t + 1$. Observe that for each $i \in [k]$, P_i has at least one edge e_i whose endpoints lie in different sets among A, B and C . Let $r := \lceil \frac{3t}{2} \rceil + 1$. Since $k > \lceil \frac{3t}{2} \rceil \cdot \max_{i \in [k]} |V(P_i)|$, from the pigeonhole principle, there exists i_1, \dots, i_r such that the edges e_{i_1}, \dots, e_{i_r} are the ℓ -th edges of P_{i_1}, \dots, P_{i_r} , respectively, for some ℓ .

Let $S(A, B), S(A, C)$ and $S(B, C)$ be the sets of edges among e_{i_1}, \dots, e_{i_r} whose endpoints lie in $A \cup B, A \cup C$ and $B \cup C$, respectively. As the edges e_{i_1}, \dots, e_{i_r} form an induced matching, and those in $S(A, B) \cup S(A, C)$ are between A and $B \cup C$, we have $\text{sim}(A, B \cup C) \geq |S(A, B)| + |S(A, C)|$. Similarly, we have $\text{sim}(B, A \cup C) \geq |S(A, B)| + |S(B, C)|$ and $\text{sim}(C, A \cup B) \geq |S(A, C)| + |S(B, C)|$. It follows that

$$\text{sim}(A, B \cup C) + \text{sim}(B, A \cup C) + \text{sim}(C, A \cup B) \geq 2(|S(A, B)| + |S(A, C)| + |S(B, C)|).$$

Since $|S(A, B)| + |S(A, C)| + |S(B, C)| = r = \lceil \frac{3t}{2} \rceil + 1$, we have

$$\text{sim}(A, B \cup C) + \text{sim}(B, A \cup C) + \text{sim}(C, A \cup B) \geq 3t + 2.$$

We conclude that the maximum among $\text{sim}(A, B \cup C), \text{sim}(B, A \cup C)$ and $\text{sim}(C, A \cup B)$ is at least $t + 1$. \blacktriangleleft

A *hybrid tree* of a partitioned graph (J, \mathcal{P}) is pair (T, f) where T is a tree and $f: V(J) \rightarrow V(T)$ is a map such that for any node $t \in T$, either $f^{-1}(t) \in \mathcal{P}$ or $|f^{-1}(t)| \leq 1$. As for tree mappings each edge $e \in E(T)$ in a hybrid tree of (J, \mathcal{P}) defines a cut (A_e, B_e) of J : the sets of vertices mapped to each component of $T - e$. The sim-value of the hybrid tree (T, f) is the maximum sim-value of all possible cuts (A_e, B_e) for $e \in E(T)$.

We recall that $\mathcal{S}^* = \{V(\mathcal{G}(u)) : u \in V(H)\}$. We observe that in the instances (H, ω) produced by the first reduction, every vertex has weight at most 2τ . Hence $\max_{u \in V(H)} |V(P_u)| \leq 4\tau$. We set $\alpha := \lceil \frac{b-1}{6\tau} \rceil - 1 = \tau + \gamma - 1$, where b is the constant introduced at the beginning of the section.

► Lemma 32. *Let (T, f) be a hybrid tree of (G^*, \mathcal{S}^*) of sim-value at most α and T subcubic. Then, for any vertex u of H , either*

- *there exists $t \in V(T)$ with $f^{-1}(t) = V(\mathcal{G}(u))$, or*
- *there exists an edge $e \in E(T)$ such that in the cut (A_e, B_e) induced by e in G^* , one can find a copy of P_u in both A_e and B_e .*

Proof. Let u be a vertex of H . If there exists a node $t \in V(T)$ such that $f^{-1}(t) = V(\mathcal{G}(u))$, the statement holds. Hence we may assume that for any node $t \in V(T)$, $|f^{-1}(t) \cap V(\mathcal{G}(u))| \leq 1$.

We build a directed graph Aux whose underlying undirected graph is T , as follows. For any $x, y \in V(\text{Aux}) := V(T)$, the arc $x \rightarrow y$ is in $E(\text{Aux})$ whenever $e := xy \in E(T)$ and, letting (X_e, Y_e) be the cut induced by e in G^* with $f(X_e)$ (resp. $f(Y_e)$) in the component of x (resp. of y) in $T - e$, it holds that Y_e contains a copy of P_u . Informally, the arcs of Aux point toward whole copies of P_u . We shall then simply show that are $x \neq y \in V(\text{Aux})$ such that both $x \rightarrow y$ and $y \rightarrow x$ are in $E(\text{Aux})$.

By construction of G^* , there are $b > 4\alpha\tau \geq \alpha|V(P_u)|$ copies of P_u : P_u^1, \dots, P_u^b . Moreover, observe that for any i, j, ℓ with $i \neq j$ the ℓ -th edges of P_u^i and P_u^j are mutually induced. Hence Lemma 30 ensures that in any cut (X, Y) of G^* , a copy of P_u is included in X or in Y . Thus each edge $xy \in E(T)$ implies that the arc $x \rightarrow y$ or the arc $y \rightarrow x$ is in $E(\text{Aux})$.

Assume, for the sake of contradiction, no edge $xy \in E(T)$ incurs that both $x \rightarrow y$ and $y \rightarrow x$ are in $E(\text{Aux})$. It implies that Aux is an oriented tree, and thus contains a sink (i.e.,

a vertex with no outneighbors), say s . Since T is of maximum degree 3, s has at most three neighbors, say v_1, v_2 and v_3 . If the degree of s is 2 (note that it cannot be less), some v_i may not exist; in which case we set $v_i := s$.

Let us define (V_1, V_2, V_3) the tripartition of $V(G^*) - f^{-1}(s)$ induced by s as follows: V_1, V_2 and V_3 are the subsets of $V(G^*) - f^{-1}(s)$ mapped to the respective components of v_1, v_2 and v_3 in $T - s$ (with $V_i = \emptyset$ if and when $v_i = s$). However, since $|f^{-1}(s) \cap V(\mathcal{G}(u))| \leq 1$ there are $b - 1 > 6\alpha\tau \geq \frac{3}{2}\alpha|V(P_u)|$ copies of P_u lying in $V_1 \cup V_2 \cup V_3$. Hence Lemma 31 ensures that some copy of P_u is included in one of V_1, V_2, V_3 ; a contradiction to s being a sink. \blacktriangleleft

We now define a *grouping* operation on triples (T, f, u) , where (T, f) is a subcubic hybrid tree of (G^*, \mathcal{S}^*) of sim-value smaller than $\frac{2(b-1)}{3 \max_{u \in V(H)} |V(P_u)|}$ (which is still very large compared to $\tau + \gamma$ by definition of b) and $u \in V(H)$, and denote it by $\text{group}(T, f, u)$. If there exists $t \in V(T)$ with $f^{-1}(t) = \mathcal{G}(u)$, then we set $\text{group}(T, f, u) := (T, f)$. Otherwise, Lemma 32 ensures that there is an edge $e \in E(T)$ such that a copy of P_u is in both sides of the cut defined by e . We then define $\text{group}(T, f, u) := (T', f')$, where

- T' is obtained from T by subdividing e , which adds a node, say, t_e , and
- f' satisfies that $f'(x) = f(x)$ whenever $x \notin V(\mathcal{G}(u))$, and $f'(x) = t_e$ otherwise.

Given an edge $e' \in E(T')$, the edge *corresponding* to e' in T is e' if e' is an edge of T , and e if e' is incident to t_e .

We make two observations on the grouping operation.

► **Observation 33.** *For any subcubic hybrid tree (T, f) of (G^*, \mathcal{S}^*) and any $u \in V(H)$, $\text{group}(T, f, u)$ is a subcubic hybrid tree of (G^*, \mathcal{S}^*) .*

► **Observation 34.** *Let (T, f) be a subcubic hybrid tree of (G^*, \mathcal{S}^*) and $u \in V(H)$. Let $(T', f') := \text{group}(T, f, u)$, $e \in E(T)$, and $e' \in E(T')$ corresponds to e in T . Then if (A_e, B_e) and $(A_{e'}, B_{e'})$ are the cuts of G^* defined by e and e' , respectively, we have*

- $A_{e'} \setminus V(\mathcal{G}(u)) = A_e \setminus V(\mathcal{G}(u))$,
- $B_{e'} \setminus V(\mathcal{G}(u)) = B_e \setminus V(\mathcal{G}(u))$,
- $V(\mathcal{G}(u)) \subseteq A_{e'}$ implies that A_e contains a copy of P_u , and
- $V(\mathcal{G}(u)) \subseteq B_{e'}$ implies that B_e contains a copy of P_u .

We can next show that a grouping can only decrease the sim-value.

► **Lemma 35.** *For any subcubic hybrid tree (T, f) of (G^*, \mathcal{S}^*) and any $u \in V(H)$, the sim-value of $\text{group}(T, f, u)$ is at most that of (T, f) .*

Proof. Let $(T', f') := \text{group}(T, f, u)$. Let e' be an edge of T' with $(A_{e'}, B_{e'})$ the cut of G^* defined by e' . Let $e \in E(T)$ be the edge corresponding to e' in T and (A_e, B_e) be the cut of G^* defined by e . By construction of (T', f') , there is a node $t' \in V(T')$ with $f'^{-1}(t') = V(\mathcal{G}(u))$. Hence we can assume without loss of generality that $V(\mathcal{G}(u)) \subseteq A_{e'}$. Consider M' an induced matching between $A_{e'}$ and $B_{e'}$. We will prove that there exists an induced matching M between A_e and B_e with $|M| = |M'|$.

Let $M' := \{a'_1 b'_1, \dots, a'_p b'_p\}$ with $a'_i \in A_{e'}$ and $b'_i \in B_{e'}$ for every $i \in [p]$. We build the matching $M := \{a_1 b_1, \dots, a_p b_p\}$ as follows. By assumption, $B_{e'} \cap V(\mathcal{G}(u)) = \emptyset$, and by Observation 34, we know that $B_e \setminus V(\mathcal{G}(u)) = B_{e'} \setminus V(\mathcal{G}(u))$. Hence $B_{e'} \subseteq B_e$, and so for any $i \in [p]$, we set $b_i := b'_i$. Exploiting the same idea, when $a'_i \notin V(\mathcal{G}(u))$ we have $a'_i \in A_e$, and so we set $a_i := a'_i$. Otherwise we have $a'_i \in V(\mathcal{G}(u))$, but since $V(\mathcal{G}(u)) \subseteq A_{e'}$, Observation 34 ensures that some copy P_u^k of P_u is in A_e . So we set a_i to be the unique vertex in $\text{Copies}(a'_i) \cap V(P_u^k)$. It remains to prove that M is indeed an induced matching.

Assume without loss of generality that $X' := \{a'_1, \dots, a'_t\}$ are exactly the vertices in $\{a'_1, \dots, a'_p\}$ that belongs to $V(\mathcal{G}(u))$. Let $X := \{a_1, \dots, a_t\}$. Observe that by construction we have $V(M') \setminus X' = V(M) \setminus X$ and this set contains no vertex from $\mathcal{G}(u)$. For every $i \in [t]$, since $a_i \in \text{Copies}(a'_i)$, we have $N(a_i) \setminus V(\mathcal{G}(u)) = N(a'_i) \setminus V(\mathcal{G}(u))$. In particular, $N(a_i) \cap (V(M) \setminus X) = N(a'_i) \cap (V(M) \setminus X)$ and thus a_i is adjacent to only $b_i = b'_i$ in $V(M) \setminus X$. Since X contains only the copies in P_u^k of some vertices in G , we know that X induces an independent set. It follows that for each $i \in [t]$, a_i is only adjacent to b_i in $V(M)$. As $V(M') \setminus X' = V(M) \setminus X$, we conclude that M is an induced matching. \blacktriangleleft

We are now equipped to turn hybrid trees G^* into tree mappings of G^* no greater sim-value.

► **Lemma 36.** *If (G^*, \mathcal{S}^*) admits tree layout (T, f) of sim-value at most α , then (G^*, \mathcal{S}^*) admits a tree mapping (T', f') of sim-value at most the sim-value of (T, f) .*

Proof. The tree layout (T, f) is a subcubic hybrid tree by definition. Let $(T_i, f_i)_{i \in [0, n]}$ be the sequences of hybrid trees where $(T_0, f_0) := (T, f)$, and for any $i \in [n]$, we set $(T_i, f_i) = \text{group}(T_{i-1}, f_{i-1}, u_i)$ with $V(H) = \{u_1, \dots, u_n\}$. Lemma 35 ensures that the sim-value of (T_n, f_n) is at most the one of (T, f) . From the definition of the operation group, it follows that for every node t of T_n , we have either $f_n^{-1}(t) \in \mathcal{S}^*$ or $f_n^{-1}(t) = \emptyset$.

Let (T', f') be the hybrid tree obtained by starting from $(T', f') = (T_n, f_n)$ and by doing the following. While there is an edge tt' in T' such that $f'^{-1}(t) \in \mathcal{S}$ and $f'^{-1}(t') = \emptyset$, we contract the edge tt' into a vertex whose preimage is the part $f'^{-1}(t)$. At every iteration, (T', f') remains a hybrid tree of (G^*, \mathcal{S}^*) . It can also be observed that after each iteration, the \mathcal{S}^* -cuts induced by the remaining edges of T' doesn't change. Thus, by repeating this process, the sim-value can only decrease.

At the end of this process, every node of T' has for preimage by f' a unique part of \mathcal{S} . Hence (T', f') is a tree mapping of (G^*, \mathcal{S}^*) . By the argument in the previous paragraphs, its sim-value is at most the sim-value of (T, f) . \blacktriangleleft

We can conclude.

► **Lemma 37.** *Let (T, f) be a tree layout witnessing that the sim-width of G^* is at most $\tau + \gamma$. Then the tree sim-balancing of (G, \mathcal{S}) is at most $\tau + \gamma$.*

Proof. By Lemma 36, there exists a tree mapping (T', f') of (G^*, \mathcal{S}^*) whose sim-value is at most that of (T, f) . We finally observe that (T', g) —with g defined such that $g^{-1}(t) = S(u)$ whenever $f'^{-1}(t) = V(\mathcal{G}(u))$ —is a tree mapping of (G, \mathcal{S}) of sim-value at most that of (T', f') . \blacktriangleleft

References

- 1 Rémy Belmonte and Martin Vatshelle. Graph classes with structured neighborhoods and algorithmic applications. *Theor. Comput. Sci.*, 511:54–65, 2013. URL: <https://doi.org/10.1016/j.tcs.2013.01.011>, doi:10.1016/J.TCS.2013.01.011.
- 2 Benjamin Bergougnoux, Jan Dreier, and Lars Jaffke. A logic-based algorithmic meta-theorem for mim-width. In Nikhil Bansal and Viswanath Nagarajan, editors, *Proceedings of the 2023 ACM-SIAM Symposium on Discrete Algorithms, SODA 2023, Florence, Italy, January 22-25, 2023*, pages 3282–3304. SIAM, 2023. URL: <https://doi.org/10.1137/1.9781611977554.ch125>, doi:10.1137/1.9781611977554.CH125.

- 3 Benjamin Bergougnoux, Tuukka Korhonen, and Igor Razgon. New width parameters for independent set: One-sided-mim-width and neighbor-depth. In Daniël Paulusma and Bernard Ries, editors, *Graph-Theoretic Concepts in Computer Science - 49th International Workshop, WG 2023, Fribourg, Switzerland, June 28-30, 2023, Revised Selected Papers*, volume 14093 of *Lecture Notes in Computer Science*, pages 72–85. Springer, 2023. doi:10.1007/978-3-031-43380-1_6.
- 4 Benjamin Bergougnoux, Charis Papadopoulos, and Jan Arne Telle. Node multiway cut and subset feedback vertex set on graphs of bounded mim-width. *Algorithmica*, 84(5):1385–1417, 2022. URL: <https://doi.org/10.1007/s00453-022-00936-w>, doi:10.1007/S00453-022-00936-w.
- 5 Andreas Darmann and Janosch Döcker. On a simple hard variant of Not-All-Equal 3-Sat. *Theor. Comput. Sci.*, 815:147–152, 2020. URL: <https://doi.org/10.1016/j.tcs.2020.02.010>, doi:10.1016/J.TCS.2020.02.010.
- 6 Eduard Eiben, Robert Ganian, Thekla Hamm, Lars Jaffke, and O-joung Kwon. A unifying framework for characterizing and computing width measures. In Mark Braverman, editor, *13th Innovations in Theoretical Computer Science Conference, ITCS 2022, January 31 - February 3, 2022, Berkeley, CA, USA*, volume 215 of *LIPICs*, pages 63:1–63:23. Schloss Dagstuhl - Leibniz-Zentrum für Informatik, 2022. URL: <https://doi.org/10.4230/LIPICs.ITCS.2022.63>, doi:10.4230/LIPICs.ITCS.2022.63.
- 7 Russell Impagliazzo and Ramamohan Paturi. On the Complexity of k-SAT. *J. Comput. Syst. Sci.*, 62(2):367–375, 2001. doi:10.1006/jcss.2000.1727.
- 8 Russell Impagliazzo, Ramamohan Paturi, and Francis Zane. Which problems have strongly exponential complexity? *J. Comput. Syst. Sci.*, 63(4):512–530, 2001. doi:10.1006/jcss.2001.1774.
- 9 Lars Jaffke, O-joung Kwon, Torstein J. F. Strømme, and Jan Arne Telle. Mim-width III. graph powers and generalized distance domination problems. *Theor. Comput. Sci.*, 796:216–236, 2019. URL: <https://doi.org/10.1016/j.tcs.2019.09.012>, doi:10.1016/J.TCS.2019.09.012.
- 10 Lars Jaffke, O-joung Kwon, and Jan Arne Telle. Mim-Width I. Induced path problems. *Discret. Appl. Math.*, 278:153–168, 2020. URL: <https://doi.org/10.1016/j.dam.2019.06.026>, doi:10.1016/J.DAM.2019.06.026.
- 11 Yota Otachi, Akira Suzuki, and Yuma Tamura. Finding induced subgraphs from graphs with small mim-width. In Hans L. Bodlaender, editor, *19th Scandinavian Symposium and Workshops on Algorithm Theory, SWAT 2024, June 12-14, 2024, Helsinki, Finland*, volume 294 of *LIPICs*, pages 38:1–38:16. Schloss Dagstuhl - Leibniz-Zentrum für Informatik, 2024. URL: <https://doi.org/10.4230/LIPICs.SWAT.2024.38>, doi:10.4230/LIPICs.SWAT.2024.38.
- 12 Sigve Hortemo Sæther and Martin Vatshelle. Hardness of computing width parameters based on branch decompositions over the vertex set. *Electron. Notes Discret. Math.*, 49:301–308, 2015. URL: <https://doi.org/10.1016/j.endm.2015.06.041>, doi:10.1016/J.ENDM.2015.06.041.
- 13 Sigve Hortemo Sæther and Martin Vatshelle. Hardness of computing width parameters based on branch decompositions over the vertex set. *Theor. Comput. Sci.*, 615:120–125, 2016. URL: <https://doi.org/10.1016/j.tcs.2015.11.039>, doi:10.1016/J.TCS.2015.11.039.
- 14 Martin Vatshelle. New width parameters of graphs. 2012.