

Orbifold subfactors from Hecke algebras II

—Quantum doubles and braiding—

DAVID E. EVANS

Department of Mathematics
University of Wales, Swansea
Singleton Park, Swansea SA2 8PP, Wales, U.K.

YASUYUKI KAWAHIGASHI

Department of Mathematical Sciences
University of Tokyo, Komaba, Tokyo, 153, JAPAN
e-mail: yasuyuki@ms.u-tokyo.ac.jp

Abstract

A. Ocneanu has observed that a mysterious orbifold phenomenon occurs in the system of the M_∞ - M_∞ bimodules of the asymptotic inclusion, a subfactor analogue of the quantum double, of the Jones subfactor of type A_{2n+1} .

We show that this is a general phenomenon and identify some of his orbifolds with the ones in our sense as subfactors given as simultaneous fixed point algebras by working on the Hecke algebra subfactors of type A of Wenzl. That is, we work on their asymptotic inclusions and show that the M_∞ - M_∞ bimodules are described by certain orbifolds (with ghosts) for $SU(3)_{3k}$. We actually compute several examples of the (dual) principal graphs of the asymptotic inclusions.

As a corollary of the identification of Ocneanu's orbifolds with ours, we show that a non-degenerate braiding exists on the even vertices of D_{2n} , $n > 2$.

1 Introduction

In the theory of subfactors initiated by V. F. R. Jones in [17], Ocneanu's paragroup theory [30] is fundamental in descriptions of the combinatorial structures arising from subfactors. Ocneanu's construction of the asymptotic inclusions, introduced in [30], has recently caught much attention as a subfactor analogue of the quantum double construction of Drinfel'd in [4]. (See [7], [10], [16], [21], [22], [26], [28], [41] on asymptotic inclusions.)

As noted by Ocneanu, if we start with a subfactor $N \subset M = N \rtimes G$, where N is a hyperfinite II_1 factor with a free action of a finite group G on N , then the resulting asymptotic inclusion $M \vee (M' \cap M_\infty) \subset M_\infty$ gives the tensor category of the quantum double of G as that of the M_∞ - M_∞ bimodules. (See [11, Section 12.8] and [24] for example.) Since a paragroup, arising from a subfactor, is a certain "quantization"

of an ordinary group, Ocneanu's construction of the asymptotic inclusion can be regarded as a subfactor analogue of the quantum double construction. (See [11, Sections 12.6, 12.7, 13.5] for its relation to topological quantum field theory and rational conformal field theory.)

The dual principal graphs of the asymptotic inclusions are hard to compute, in general, while their principal graphs are easy to compute, as in [10], [11, Section 12.6], [31], [32], [33], as long as we know the fusion rule of the M - M bimodules of the original subfactor $N \subset M$. From the above viewpoint of the quantum double, it is the dual principal graph, or the system of its even vertices, strictly speaking, that is more important of the two graphs. (In some sense, the principal graph represents just a double "without quantum". See [11, Section 12.6].) So it would be interesting to have concrete descriptions of the dual principal graphs (or their even vertices) of the asymptotic inclusions of concrete examples of subfactors, other than the ones of the form $N \subset M = N \rtimes G$ arising from genuine groups. Other "easy" examples of subfactors of finite depth arising from actions of finite groups contain subgroup-group subfactors $N = R \rtimes H \subset M = R \rtimes G$ and Wassermann type subfactors $(\mathbf{C} \otimes R)^K \subset (M_n(\mathbf{C}) \otimes R)^K$, where R is the hyperfinite II_1 factor, $H \subset G$ are finite groups acting freely on R , and K acts on $R = \bigotimes_k M_n(\mathbf{C})$ as a product type action. These, however, do not give anything new in the tensor categories of their M_∞ - M_∞ bimodules, because the M - M bimodules of these subfactors are given by the tensor category of \hat{G} and then they give the same M_∞ - M_∞ bimodules as the subfactor $N = R \rtimes H \subset M = R \rtimes G$, as seen from [11, Section 12.6]. In this sense, "classical" subfactors do not give interesting asymptotic inclusions.

The easiest subfactors among "quantum" subfactors are the Jones subfactors $N \subset M$ of type A_n , as introduced in [17]. They are described as $N = \langle e_2, e_3, e_4, \dots \rangle$, $M = \langle e_1, e_2, e_3, e_4, \dots \rangle$, where $\{e_j\}_{j \geq 1}$ is a sequence of projections satisfying the following relations :

$$\begin{aligned} e_j e_k &= e_k e_j, \quad |j - k| \neq 1, \\ e_j e_{j \pm 1} e_j &= \left(4 \cos^2 \frac{\pi}{n+1}\right)^{-1} e_j. \end{aligned}$$

Then it is easy to see that the asymptotic inclusion $M \vee (M' \cap M_\infty) \subset M_\infty$ is given as

$$\begin{aligned} M \vee (M' \cap M_\infty) &= \langle \dots, e_{-2}, e_{-1}, e_1, e_2, \dots \rangle, \\ M_\infty &= \langle \dots, e_{-2}, e_{-1}, e_0, e_1, e_2, \dots \rangle, \end{aligned}$$

where $\{e_j\}_{j \in \mathbf{Z}}$ is a (double-sided) sequence of projections satisfying the same relations as above. The Jones indices of these subfactors were first computed by M. Choda in [2]. It is quite non-trivial to describe the dual principal graphs of these asymptotic inclusions, while the general theory mentioned above gives the principal graphs easily from the fusion rules. Ocneanu has announced a description of the M_∞ - M_∞ bimodules in [36] and at several other conferences.

If we apply the quantum double construction of Drinfel'd to a Hopf algebra already having an R -matrix, then the resulting Hopf algebra is just a "double" of the original

algebra and nothing interesting happens in this procedure. One might suspect we have something similar and not interesting for these asymptotic inclusions of the Jones subfactors, because the Jones subfactors correspond to the quantum groups $\mathcal{U}_q(sl_2)$ in some sense. This, however, is not true. We have a more subtle and interesting situation due to a certain degeneracy condition of the braiding in the sense of Ocneanu [36].

The non-degeneracy condition of this kind was first introduced by Reshetikhin–Turaev [39] in their construction of topological invariants of 3-manifolds realizing the physical prediction of Witten [48]. From the topological viewpoint, this condition is quite natural and it is this non-degeneracy that leads the Turaev–Viro invariant [43] of a 3-manifold being the square of the absolute value of the Reshetikhin–Turaev invariant as in [42]. (See also [36] for an operator algebraic account of this theorem of Turaev.)

Ocneanu has observed that a certain orbifold construction, similar to the orbifold construction in our sense in [8] as simultaneous crossed products, is invoked in the process of the asymptotic inclusions of the Jones subfactors if the above non-degeneracy condition fails. In this paper, we will generalize his construction to the case of the Hecke algebra subfactors of Wenzl [47] and show that this is a general phenomenon in the following sense. The asymptotic inclusion produces a non-degenerate system of bimodules in the sense of Ocneanu [36]. From the viewpoint of [36], we can say that our orbifold construction [8] removes the degeneracy. So if we apply the construction of the asymptotic inclusion to a subfactor having a degenerate system of bimodules, the orbifold construction is invoked automatically in order to remove the degeneracy in the procedure of making the “double”. In this way, we get another series of orbifold subfactors from Hecke algebras of type A as a continuation of our work in [8].

The asymptotic inclusions of the Hecke algebra subfactors are described naturally as follows. The original subfactor of Wenzl is described as $N = \langle g_2, g_3, g_4, \dots \rangle$, $M = \langle g_1, g_2, g_3, g_4, \dots \rangle$, where $\{g_j\}_{j \geq 1}$ is a sequence of the Hecke generators satisfying the relations of the Hecke algebras of type A as in [47]. The series of the commuting squares giving this subfactor is not canonical in the sense of Popa, because this series has a period larger than two. Still, one can identify the asymptotic inclusion of this subfactor as follows, which is similar to the above description of the asymptotic inclusions of the Jones subfactors :

$$\begin{aligned} M \vee (M' \cap M_\infty) &= \langle \dots, g_{-2}, g_{-1}, g_1, g_2, \dots \rangle, \\ M_\infty &= \langle \dots, g_{-2}, g_{-1}, g_0, g_1, g_2, \dots \rangle, \end{aligned}$$

where $\{g_j\}_{j \in \mathbf{Z}}$ is a (double-sided) sequence of the Hecke generators satisfying the same relations. This subfactor was first constructed with a double sided sequence of the Hecke generators by Erlijman [6]. Later it was identified with the asymptotic inclusion of the Hecke algebra subfactor of Wenzl by Goto [15] and Erlijman [7] independently. (Goto’s proof works in a quite general setting, while Erlijman directly works on the Hecke algebras.) So the asymptotic inclusions of the Hecke algebra subfactors have

natural constructions in terms of generators and commuting squares parallel to the case of the Jones subfactors of type A_n .

In Section 2, we explain Ocneanu's basic properties of braiding on a system of bimodules in his sense [36] and its relation to his tube algebras. We continue the study of the tube algebras for the Hecke algebra subfactors of Wenzl [47] in Section 3. This gives the basic properties of the tube algebra and enables us to use Ocneanu's general machinery on asymptotic inclusions and tube algebras in [35] and [10]. The dual principal graphs of the asymptotic inclusions of the Jones subfactors of type A_n are described in Section 4. This covers the case announced by Ocneanu in [36]. These for the Hecke algebra subfactors with indices converging to 9 are dealt with in Section 5. This Section describes our main results. In Section 6, we study a relation between the orbifold phenomena Ocneanu has observed and the orbifold construction in our sense [8] for the $SU(2)_{2k}$ case. In the last Section 7, we study the orbifold construction with braiding in our setting and get a non-degenerate braiding on the even vertices of D_{2n} , $n > 2$.

This work was done at University of Wales, Swansea while the second author visited there on the joint research program of the Royal Society and the Japan Society for Promotion of Sciences. The second author thanks for the financial supports of these Societies. The second author also acknowledges financial support from the Inamori Foundation during this research. We thank Dr. Maxim Nazarov for his kind explanation of the Littlewood–Richardson rule.

2 Braiding and a tube algebra — non-degenerate case —

We start with a finite braided system of bimodules $\mathcal{M} = \{x_i\}_{i \in I}$ in the sense of Ocneanu [36]. (The original references for Ocneanu's theory used in this paper are [30], [31], [32], [33], [34], [35], [36]. See also [9], [10] and [11, Chapter 12].)

An important example of such a system is obtained from the WZW-models $SU(n)_k$ with Ocneanu's surface bimodule construction as in [33], [34], [35]. (See also [10] or [11, Chapter 12].)

We may have such a system from a subfactor $N \subset M$ with finite index and finite depth. Note that even when we have an abstract system of bimodules, we can realize the system as a system of bimodules arising from a single hyperfinite (possibly reducible) subfactor $N \subset M$ of type II_1 finite index and finite depth. This is possible by a minor variation of the construction in [1]. That is, instead of choosing a primary field Φ in page 281 of [1], we choose $\bigoplus_{i \in I} x_i$ as the generator to construct a paragroup. In this way, we get a (possibly reducible) subfactor $N \subset M$ for which the system of the M - M bimodules arising from the subfactor is given by $\mathcal{M} = \{x_i\}_{i \in I}$. (We have learnt this construction from S. Yamagami. See also [9, Section 4] or [11, Section 12.5].) So we may and do assume that our system \mathcal{M} arises from a hyperfinite subfactor $N \subset M$ of type II_1 with finite index and finite depth.

Define the *global index* $[\mathcal{M}]$ of the system by $[\mathcal{M}] = \sum_{x \in \mathcal{M}} [x]$, where $[x]$ denotes the Jones index of the bimodule x . This is also the global index of the subfactor

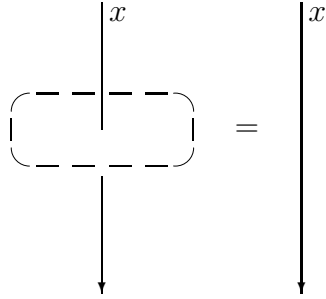

Figure 1: A degenerate element x

$$\text{dashed circle} = \sum_{x \in \mathcal{M}} \frac{[x]^{1/2}}{[\mathcal{M}]} \text{solid circle with arrow } x$$

Figure 2: A killing ring

$N \subset M$ in the sense of Ocneanu [30]. We would like to study the system of the M_∞ - M_∞ bimodules corresponding to the asymptotic inclusion $M \vee (M' \cap M_\infty) \subset M_\infty$ arising from this subfactor $N \subset M$ in the sense of Ocneanu [30]. The construction of this system of the M_∞ - M_∞ bimodules can be regarded as a subfactor analogue of the quantum double construction of Drinfel'd in [4]. (This analogy has been noted by Ocneanu. See [11, Chapter 12] for the basic theory of asymptotic inclusions and this analogy.)

In order to study this system, we work on Ocneanu's tube algebra $\text{Tube } \mathcal{M}$ and study the center of the tube algebra in the sense of [33], [36]. (See also [11, Chapter 12] for tube algebras.)

Recall that an element x in the braided system \mathcal{M} is called *degenerate* in the sense of Ocneanu [36] if it satisfies the identity in Figure 1, where the dashed circle denotes the summation over all the labels $x \in \mathcal{M}$ with coefficient $[x]^{1/2}/[\mathcal{M}]$ as in Figure 2. Such a dashed ring is called a *killing ring* in Ocneanu's terminology.

In this section, we suppose that the braiding on \mathcal{M} is non-degenerate in the sense that 0 is the only degenerate element. (We remark that 0 is always degenerate by definition.) We note that we can use a graphical expression as in [19], [49] for elements in the tube algebra $\text{Tube } \mathcal{M}$ because we have a braided system of bimodules. In the

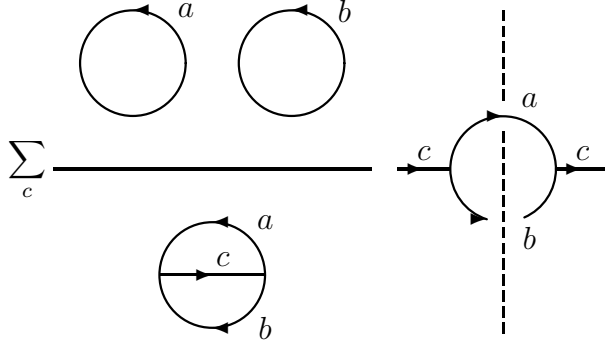

Figure 3: The Ocneanu projection $p_{a,b}$

tube algebra, we define the *Ocneanu projection* $p_{a,b} \in \text{Tube } \mathcal{M}$ for $a, b \in \mathcal{M}$ as in Figure 3. In this picture, the left half is a coefficient represented diagrammatically as in [19], where the horizontal bar represents a fraction, and the right half is an element in the tube algebra $\text{Tube } \mathcal{M}$ where the top and the bottom of the dashed line are identified in the tube picture. The dashed line again denotes the killing ring.

We recall from [19, Section 12.3] that we can perform the graphical operation called a *handle slide* against a killing ring without changing the number or operator represented by the figure. We give an example of a handle slide in Figures 4, 5. In this situation here, we assume that the link components on the right hand side are killing rings. (We remark that we have to regard a diagram of a link as a *framed* link diagram now.) Note that this handle slide is valid regardless of the non-degeneracy condition. (See [19, Section 12.3].)

The following theorem is due to Ocneanu. He presented this theorem and a proof in his talk in the Taniguchi Symposium in Japan in July, 1993. The proof here, except for the last paragraph, is his proof, which we include for the sake of completeness.

Theorem 2.1 *The above element $p_{a,b}$ gives a system of mutually orthogonal minimal central projections in the tube algebra with $\sum_{a,b \in \mathcal{M}} p_{a,b} = 1$.*

Before the proof, note that this system of the minimal central projections describes the system of the M_∞ - M_∞ bimodules and that these bimodules give the even vertices of the dual principal graph of the asymptotic inclusion, by Ocneanu's theorem in [35] (see [10, Theorem 4.3] or [11, Theorem 12.28]).

Proof: First we prove that $p_{a,b}$'s give a system of mutually orthogonal projections. It is clear that each $p_{a,b}$ is self-adjoint, so we will prove that $p_{a,b}p_{a',b'} = \delta_{a,a'}\delta_{b,b'}p_{a,b}$ first. This proof is given as in Figure 6, where we compute $p_{a,b}p_{a',b'}$ graphically. In the first equality, we have used a handle slide. In the third equality, the non-degeneracy assumption implies that the label d should be 0. We next prove that each $p_{a,b}$ is

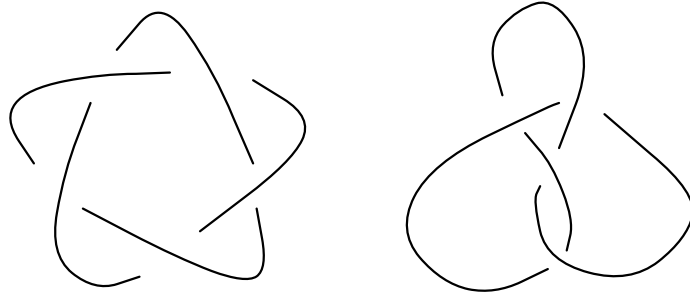

Figure 4: Before a handle slide

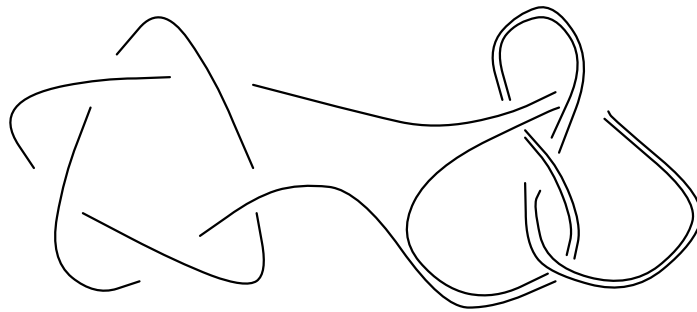

Figure 5: After a handle slide

central. It is enough to prove that $p_{a,b}/([a][b])^{1/2}$ commutes with any element in the tube algebra. This proof is given again graphically. First we compute the product of $p_{a,b}/([a][b])^{1/2}$ and a generic element in the tube algebra as in Figure 7, where the top and the bottom of the generic element labeled with z are identified again, where the top and the bottom of the generic element labeled with z are identified again. We next compute the product in the reverse order as in Figure 8. Then the coefficients in Figures 7 and 8 turn out to be the same, so we have the desired centrality.

The proof of $\sum_{a,b \in \mathcal{M}} p_{a,b} = 1$. is given graphically in Figure 9.

We finally have to show that each $p_{a,b}$ is a minimal central projection. By Ocneanu's theorem mentioned above just before the proof, it is enough to show that the

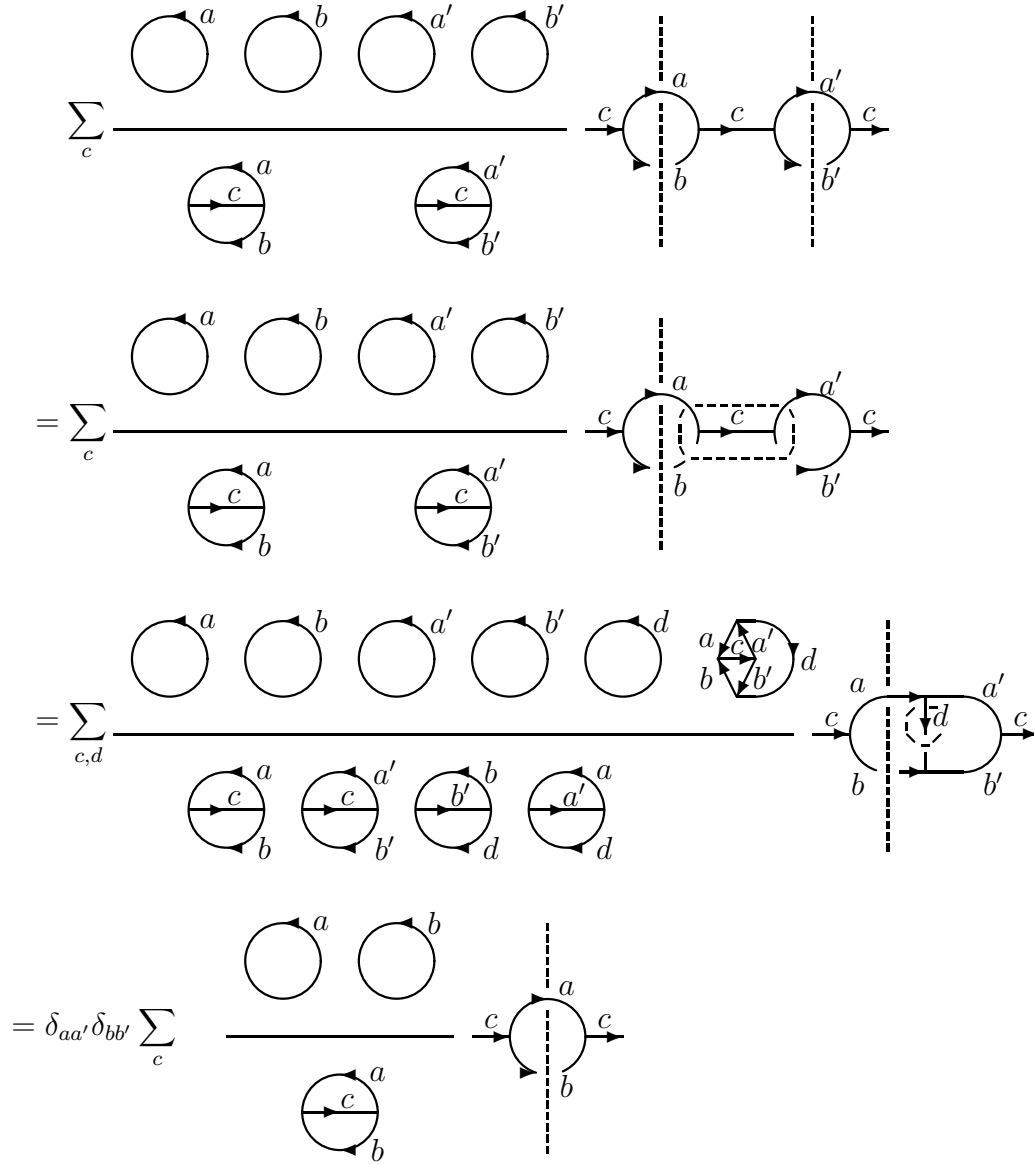

Figure 6: Orthogonality of $p_{a,b}$

corresponding M_∞ - M_∞ bimodules are all irreducible. By the proof of Ocneanu's theorem in [35] (see [10, Theorem 4.3] or [11, Theorem 12.28]), we know that the M_∞ - M_∞ bimodule corresponding to $p_{a,b}$ decomposes as $\bigoplus_{c \in \mathcal{M}} N_{ab}^c B_c$ as an $M \vee (M' \cap M_\infty)$ - M_∞ bimodule after restricting the left action to $M \vee (M' \cap M_\infty)$, where B_c denotes the $M \vee (M' \cap M_\infty)$ - M_∞ bimodule labeled with c . This shows that the Jones index of the M_∞ - M_∞ bimodule corresponding to $p_{a,b}$ is $[a][b]$. Thus if all the bimodules corresponding to $p_{a,b}$ are irreducible, we get the global index equal to $\sum_{a,b \in \mathcal{M}} [a][b]$,

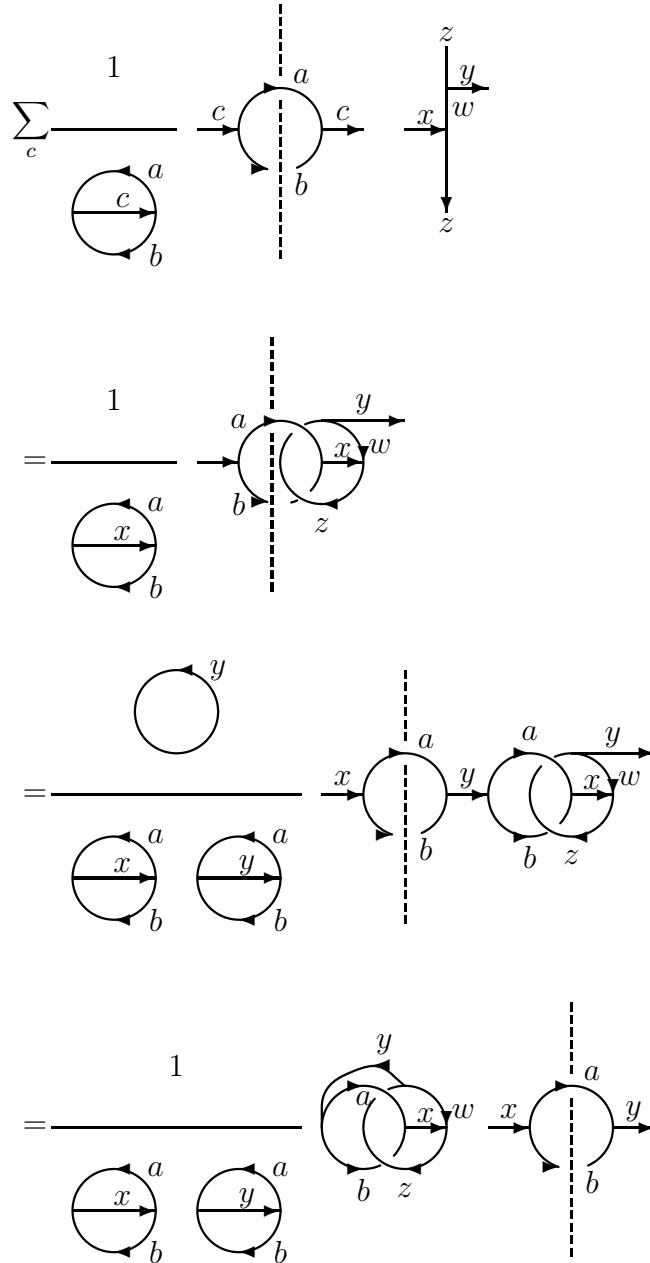

Figure 7: Centrality of $p_{a,b}$ (1)

which is the correct global index. If one or more of the bimodules is reducible, we would get a smaller global index, which is impossible. Thus we conclude that all the bimodules are irreducible. Q.E.D.

We now recall that the principal graph of the asymptotic inclusion $M \vee (M' \cap$

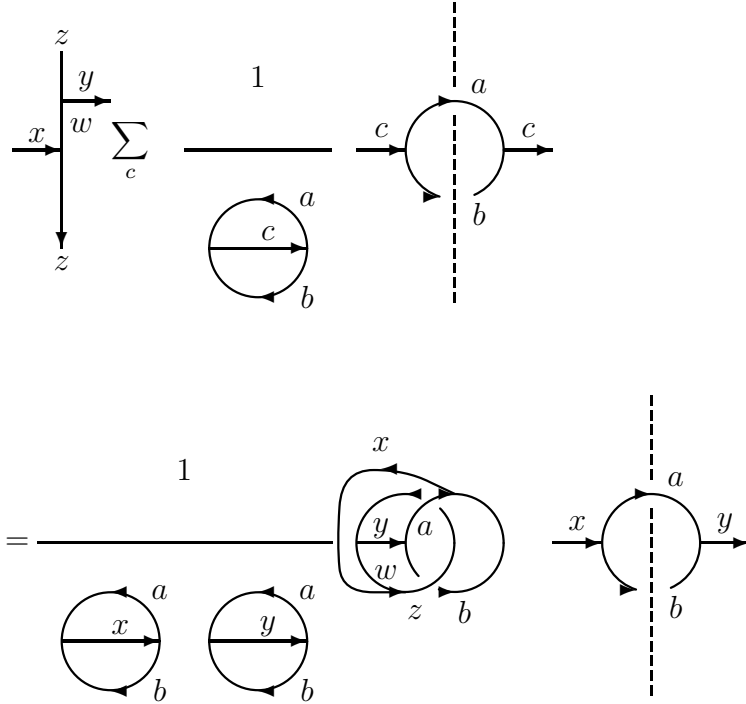

Figure 8: Centrality of $p_{a,b}$ (2)

$M_\infty) \subset M_\infty$ is given by the fusion graph of the original system \mathcal{M} by Ocneanu's theorem in [35] (see [10, Theorem 4.1] or [11, Theorem 12.25]). That is, the set of the odd vertices of the principal graph is labeled with \mathcal{M} , the set of the even vertices is labeled by pairs (a, b) with $a, b \in \mathcal{M}$, and the number of the edges between the odd vertex labeled with c and the even vertex labeled with (a, b) is given by N_{ab}^c , the multiplicity of c in the relative tensor product $a \otimes_M b$. The connected component of this graph containing the even vertices labeled with $(*, *)$ is called the *fusion graph* of the system \mathcal{M} . (See [31], [10, page 220], [11, Section 12.6].)

Combining these pieces of information, we get the following proposition.

Proposition 2.2 *Let $N \subset M$ be a hyperfinite type II_1 subfactor with finite index and finite depth. Suppose that the system of the M - M bimodules arising from this subfactor has a non-degenerate braiding. Then the dual principal graph of the asymptotic inclusion $M \vee (M' \cap M_\infty) \subset M_\infty$ is the fusion graph of the original system, the same as the principal graph.*

Proof: As above, we know that the even vertices of the dual principal graph is labeled with pairs (a, b) for $a, b \in \mathcal{M}$ and the odd vertices with $c \in \mathcal{M}$. It is thus enough to show that the number of the edges connecting the vertices labeled with

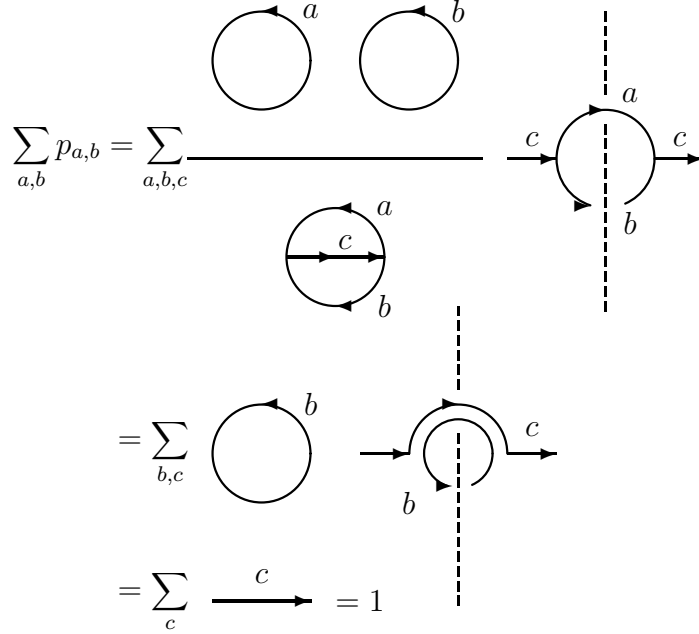

Figure 9: $\sum p_{a,b} = 1$

(a, b) and c is indeed N_{ab}^c . This follows from the above proof of Theorem 2.1.

Q.E.D.

3 Braiding for $SU(n)_k$ and a tube algebra

We now work on the WZW-model $SU(n)_k$. Let $N \subset M$ be the corresponding Wenzl subfactor in [47] constructed as in [1, Section 4]. Note that the fusion rule algebra for the WZW-model $SU(n)_k$ has a natural $\mathbf{Z}/n\mathbf{Z}$ -grading and that the fusion rule subalgebra given by the grade 0 elements corresponds to the fusion rule algebra of the M - M bimodules arising from this subfactor $N \subset M$. (This correspondence also follows from [1, Section 4].) We denote the grading of a primary field a in the model $SU(n)_k$ by $\text{gr}(a) \in \mathbf{Z}/n\mathbf{Z}$. Then this system is often degenerate in the sense of the previous section. Our next aim is to study the asymptotic inclusions for these degenerate cases. Some statements in this Section hold for a general RCFT in the sense of [29] rather than for the WZW-models, so we make a general statement in such a case.

First we have the following general proposition.

Proposition 3.1 *Let \mathcal{M} be a braided system of M - M bimodules. A bimodule $x \in \mathcal{M}$ is degenerate if and only if the bimodule x satisfies the equality in Figure 10 for all $y \in \mathcal{M}$.*

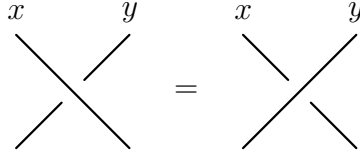

Figure 10: The degeneracy condition

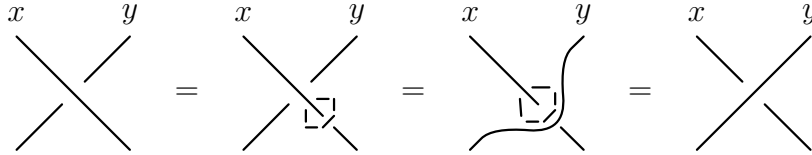

Figure 11: The converse direction

Proof: It is trivial that if we have the equality in Figure 10, then we have the degeneracy condition in Figure 1.

For the converse direction, we use a graphical argument as in Figure 11, where we have used a handle slide against a killing ring. Q.E.D.

We record the following straightforward Lemma just to fix the normalization constants for an RCFT.

Lemma 3.2 *The number represented by Figure 12 is S_{xy}/S_{00} , where S denotes the S -matrix of the RCFT.*

Proof: This is standard. See [49] for example. Q.E.D.

Let \mathcal{M} be a subsystem of an RCFT. (A typical case will be the subsystem of all grade 0 elements in a WZW-model $SU(n)_k$.) We first have the following lemma.

Lemma 3.3 *Let x be an element of the subsystem \mathcal{M} . If we have $S_{0y} = S_{xy}$ for all $y \in \mathcal{M}$, then x is degenerate in \mathcal{M} .*

Proof: This follows from a graphical argument as in Figure 13. Q.E.D.

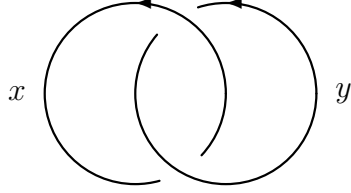

Figure 12: The Hopf link

$$\begin{aligned}
 \sum_y \frac{[y]^{1/2}}{[\mathcal{M}]} \begin{array}{c} x \\ | \\ \bigcirc \\ | \\ y \\ | \\ \end{array} &= \sum_y \frac{[y]^{1/2} S_{xy}}{[\mathcal{M}] S_{x0}} \begin{array}{c} x \\ | \\ \\ | \\ \\ | \\ \end{array} \\
 &= \sum_y \frac{[y]^{1/2} S_{0y}}{[\mathcal{M}] S_{00}} \begin{array}{c} x \\ | \\ \\ | \\ \\ | \\ \end{array} = \begin{array}{c} x \\ | \\ \\ | \\ \\ | \\ \end{array}
 \end{aligned}$$

Figure 13: Degeneracy of x

Lemma 3.4 *Suppose that x is degenerate in \mathcal{M} . Then for all $y \in \mathcal{M}$, we have*

$$\frac{S_{xy}}{S_{00}} = \frac{S_{x0} S_{y0}}{S_{00} S_{00}}. \tag{1}$$

Proof: Suppose that the identity (1) fails for some $y \in \mathcal{M}$. Then we have the graphical relation of Figure 14. This, together with identity of Figure 15 given by the handle slide, gives the identity of Figure 16, which is a contradiction. Q.E.D.

In the rest of this Section, we work on the WZW-model $SU(n)_k$ with $n \mid k$, because it will turn out that this case is a typical degenerate case related to the orbifold construction. Let \mathcal{M} be the subsystem of the WZW-model $SU(n)_k$ consisting of the elements with grading 0. (Note that if n and k are relatively prime, then \mathcal{M} is non-degenerate by [23, Section 2].) In this case, the subsystem $\{x \in \mathcal{M} \mid S_{0x} = S_{00}\}$ of \mathcal{M} is isomorphic to $\mathbf{Z}/n\mathbf{Z}$. (They are called simple currents. See [11, Section 8.8],

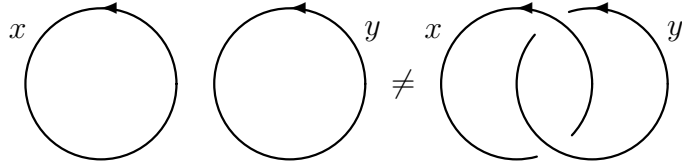

Figure 14:

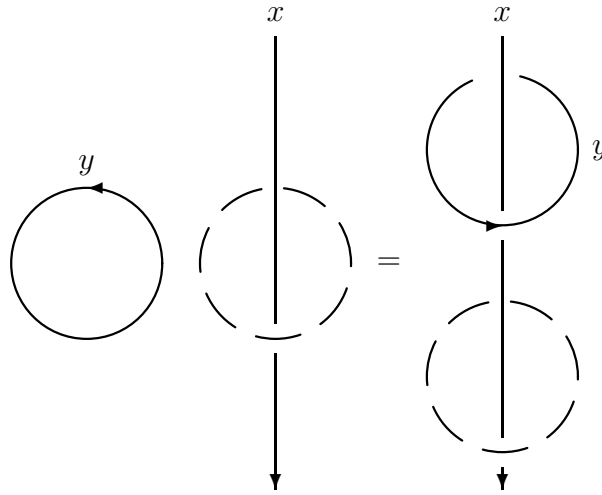

Figure 15:

[12, pages 327, 365] for example.) We choose and fix an element σ in this subsystem of \mathcal{M} so that this subsystem is given as $\{0, \sigma, \sigma^2, \dots, \sigma^{n-1}\}$.

Lemma 3.5 *For σ as above and an arbitrary $y \in \mathcal{M}$, we have $S_{0y} = S_{\sigma y}$.*

Proof: This follows from a standard property of the S -matrix. See [12, (5.5.25)], for example. Q.E.D.

This Lemma, together with Lemma 3.3, shows that any element in

$$\{0, \sigma, \sigma^2, \dots, \sigma^{n-1}\}$$

is degenerate in \mathcal{M} . We next show the converse as follows.

Proposition 3.6 *If $x \in \mathcal{M}$ is degenerate in \mathcal{M} , then*

$$x \in \{0, \sigma, \sigma^2, \dots, \sigma^{n-1}\}.$$

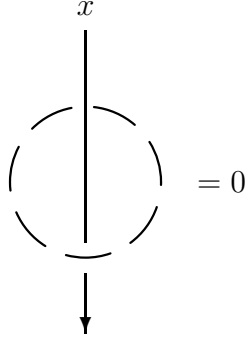

Figure 16:

Proof: For $y \in \mathcal{M}$, let Γ_y be the matrix for the multiplication by y on the entire fusion rule algebra of the model $SU(n)_k$. That is, each entry $(\Gamma_y)_{ab}$ is given by N_{ay}^b for any primary field a, b in the model $SU(n)_k$. We also define a vector v by $v = (S_{yx})_y$ for any primary field y in the model $SU(n)_k$. According to the grading of y , we split the vector v into n pieces and write $v = (v_0, v_1, \dots, v_{n-1})$, where v_j denotes the vector component corresponding to y with $\text{gr}(y) = j$. By the Verlinde identity [45], [11, Section 8.6], we get

$$\Gamma_z v_j = \frac{S_{zx}}{S_{0x}} v_{j+1},$$

where $z \in \mathcal{M}$ and $j \in \mathbf{Z}/n\mathbf{Z}$.

Lemma 3.4 implies that we have $S_{zx} \neq 0$ for any $z \in \mathcal{M}$ with grading 1. Then we get

$$\begin{aligned} \frac{S_{zx}}{S_{0x}} \|v_{j+1}\|_2^2 &= (\Gamma_z v_j, v_{j+1}) \\ &= (v_j, \Gamma_{\bar{z}} v_{j+1}) \\ &= \frac{\overline{S_{\bar{z}x}}}{S_{0x}} \|v_j\|_2^2 \\ &= \frac{S_{zx}}{S_{0x}} \|v_j\|_2^2, \end{aligned}$$

which implies $\|v_j\|_2 = \|v_{j+1}\|_2$. Since this is true for all $j \in \mathbf{Z}/n\mathbf{Z}$ and the matrix S is unitary, we get $\|v_j\|_2 = 1/\sqrt{n}$ for all $j \in \mathbf{Z}/n\mathbf{Z}$. Let w_0 be the vector defined by $(w_0)_y = S_{yx}$ for $y \in \mathcal{M}$. Lemma 3.4 implies that $w_0 = v_0$ and thus $S_{0x} = S_{00}$. This means that the Perron–Frobenius weight of the element x is 1 and thus x is in $\{0, \sigma, \sigma^2, \dots, \sigma^{n-1}\}$, which is the conclusion of the Proposition. Q.E.D.

We now extend the definition of the Ocneanu projection $p_{a,b}$ in Figure 3. Suppose that a, b are primary fields in the model $SU(n)_k$ with $\text{gr}(a) + \text{gr}(b) = 0 \in \mathbf{Z}/n\mathbf{Z}$. Then

the graphical formula in Figure 3 still defines an element in the tube algebra $\text{Tube } \mathcal{M}$ for the subsystem \mathcal{M} of the elements with 0 grading, because we have $\text{gr}(c) = 0$ for any c appearing in Figure 3. Note that $p_{a,b}$ may not be a projection any more. We call this element $p_{a,b}$ an *Ocneanu element*.

Lemma 3.7 *For primary fields a, b as above, the element $p_{a,b}$ is central in the tube algebra $\text{Tube } \mathcal{M}$.*

Proof: The same argument as in Figure 7 works. Q.E.D.

Lemma 3.8 *For primary fields a, b as above, we have $p_{a,b} = p_{\sigma a, \sigma^{n-1} b}$ in the tube algebra $\text{Tube } \mathcal{M}$.*

Proof: First consider $p_{\sigma, \sigma^{n-1}}$. If $c \neq 0$ in Figure 3, then the term corresponding to c is 0. So we have a single term for this Ocneanu element. The degeneracy of σ , proved in Lemmas 3.5 and 3.3, easily implies $p_{\sigma, \sigma^{n-1}} = p_{0,0}$.

Next note that we have $S(x_1 * x_2) S(x_3) = S(x_1) S(x_2 * x_3)$ for $x_1, x_2, x_3 \in H_{S^1 \times S^1}$ as in [10, Theorem 5.1], [11, Theorem 12.29], where S means the action of the S -matrix in $PSL(2, \mathbf{Z})$. (This is a direct analogue of the Verlinde formula [45]. Actually, the formula in Theorem 5.1 in [10] is slightly incorrect because normalizing coefficients are missing there. Theorem 12.29 in [11] is correct.) By Lemma 3.7, we can apply this identity to the Ocneanu elements. Then we have

$$p_{a,b} = p_{a,b} * p_{0,0} = p_{a,b} * p_{\sigma a, \sigma^{n-1} b} = p_{\sigma a, \sigma^{n-1} b}.$$

Q.E.D.

Lemma 3.9 *Let a, b, a', b' be primary fields in the model $SU(n)_k$ with $\text{gr}(a) + \text{gr}(b) = \text{gr}(a') + \text{gr}(b') = 0 \in \mathbf{Z}/n\mathbf{Z}$. We suppose that $(a', b') \neq (\sigma^j a, \sigma^{n-j} b)$ for all $j \in \mathbf{Z}/n\mathbf{Z}$. Then we have $p_{a,b} p_{a',b'} = 0$.*

Proof: We compute $p_{a,b} p_{a',b'}$ as in Figure 6. The computation is the same up to the third line of Figure 6. Then in the third line, the picture represents the value 0 for any choice of d . Thus we have $p_{a,b} p_{a',b'} = 0$. Q.E.D.

Note that we have a unique primary field f with $\sigma f = f$, because $n \mid k$.

Lemma 3.10 *If primary fields a, b as above satisfy $(a, b) \neq (f, f)$, then the element $p_{a,b}$ is a projection in the tube algebra $\text{Tube } \mathcal{M}$.*

Let $P = \{p_{a,b} \mid \text{gr}(a) + \text{gr}(b) = 0 \in \mathbf{Z}/n\mathbf{Z}, (a, b) \neq (f, f)\}$. Then we have $\sum_{p \in P} p + p_{f,f}/n = 1$, which implies that $p_{f,f}/n$ is a central projection.

Proof: Suppose $(a, b) \neq (f, f)$. We compute $p_{a,b}^2$ as in Figure 6. Then in the third line, we have only the terms with d in $\{0, \sigma, \sigma^2, \dots, \sigma^{n-1}\}$. Since $(a, b) \neq (f, f)$, none

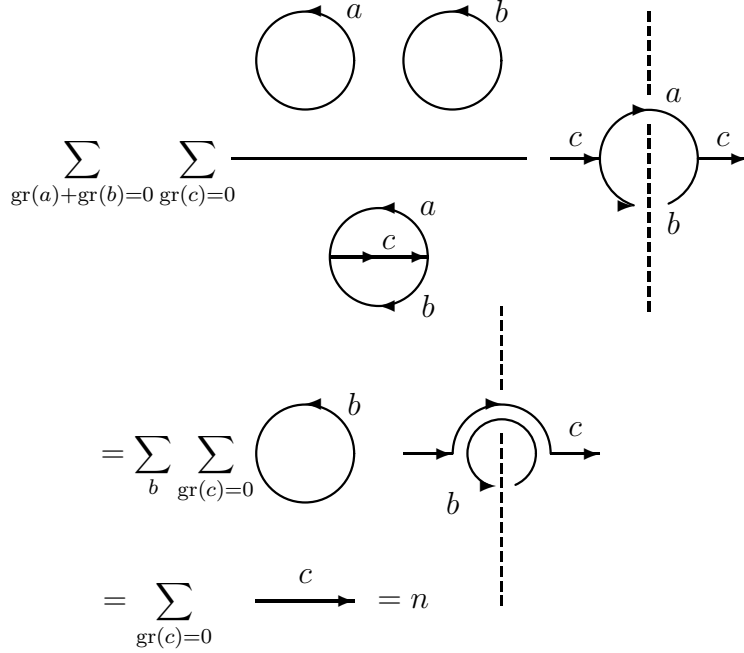

Figure 17: $\sum_{p \in P_0} p = n$

of these d , except for $d = 0$, give a non-zero value. For $d = 0$, we have the original $p_{a,b}$. This shows that $p_{a,b}$ is a projection.

Set $P_0 = \{p_{a,b} \mid \text{gr}(a) + \text{gr}(b) = 0 \in \mathbf{Z}/n\mathbf{Z}\}$. We compute $\sum_{p \in P_0} p$ as in Figure 17. The second equality follows since the entire system of the primary fields in the model $SU(n)_k$ is non-degenerate, which follows from unitarity of the S -matrix. (The coefficient n comes from the ratio of the global indices of \mathcal{M} and the entire system.) This implies $\sum_{p \in P} p + p_{f,f}/n = 1$. The last assertion on $p_{f,f}/n$ now follows from Lemmas 3.9, 3.7, 3.10. Q.E.D.

Lemma 3.11 *If primary fields a, b as above satisfy $(a, b) \neq (f, f)$, then the projection $p_{a,b}$ in the tube algebra $\text{Tube } \mathcal{M}$ is minimal.*

Proof: We define $p_{a,b}^{(c,d)}$ as in Figure 18.

We compute $p_{a,b}^{(c,d)} p_{a,b}^{(d,e)}$ graphically as in Figure 19, where we have used $(a, b) \neq (f, f)$ in the second line. Let $M(a, b)$ be the set of the primary fields c satisfying $p_{a,b}^{(c,c)} \neq 0$. If $c, d \in M(a, b)$, then the computation in Figure 19 shows that $p_{a,b}^{(c,d)} \neq 0$. If $c, d, e \in M(a, b)$, then the computation in Figure 19 also shows that $p_{a,b}^{(c,d)} p_{a,b}^{(d,e)} \neq 0$. We thus have a system of matrix units $\{\lambda_{c,d} p_{a,b}^{(c,d)}\}_{c,d}$ for $p_{a,b}(\text{Tube } \mathcal{M})p_{a,b}$, where $\lambda_{c,d}$ are some positive numbers. This shows that the algebra $p_{a,b}(\text{Tube } \mathcal{M})p_{a,b}$ is a full matrix algebra and thus the central projection $p_{a,b}$ is minimal in the center of the tube algebra $\text{Tube } \mathcal{M}$. Q.E.D.

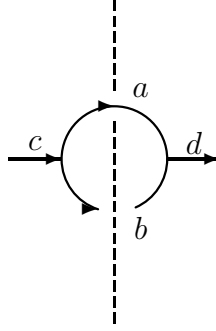

Figure 18: Element $p_{a,b}^{(c,d)}$

Again by Ocneanu's theorem in [35] (see [10, Theorem 4.3] or [11, Theorem 12.28]), we get irreducible M_∞ - M_∞ bimodules corresponding to $p_{a,b}$ with $(a,b) \neq (f,f)$. Note that we have corresponding bimodules even when $\text{gr}(a), \text{gr}(b) \neq 0$. The principal graphs of the asymptotic inclusions are determined only by the primary fields with grading 0, but the dual principal graphs have vertices related to the primary fields with other grading. The primary fields with non-zero grading are the *ghosts* of the system \mathcal{M} in the sense of Ocneanu [36].

We work on the irreducible decompositions of these M_∞ - M_∞ bimodules after restricting the left action to $M \vee (M' \cap M_\infty)$ as follows. This gives partial information about the dual principal graph of the asymptotic inclusion.

Lemma 3.12 *Let a, b be primary fields as above satisfying $(a,b) \neq (f,f)$ and $X_{a,b}$ the irreducible M_∞ - M_∞ bimodule corresponding to the minimal central projection $p_{a,b}$ in Tube \mathcal{M} . If we restrict the left action to $M \vee (M' \cap M_\infty)$, we get a decomposition $X_{a,b} = \bigoplus_{c \in \mathcal{M}} N_{ab}^c X_c$ as a $M \vee (M' \cap M_\infty)$ - M_∞ bimodule, where X_c is the $M \vee (M' \cap M_\infty)$ - M_∞ bimodule corresponding to $c \in \mathcal{M}$.*

Proof: An argument similar to the one in the proof of Theorem 2.1 works.

Q.E.D.

We next work on the case $(a,b) = (f,f)$. We still have an M_∞ - M_∞ bimodule in such a case, though this bimodule might not be irreducible, and we get the following lemma in the same way.

Lemma 3.13 *Let $X_{f,f}$ be the M_∞ - M_∞ bimodule corresponding to the central projection $p_{f,f}/n$ in Tube \mathcal{M} . If we restrict the left action to $M \vee (M' \cap M_\infty)$, we get a decomposition $X_{f,f} = \bigoplus_{c \in \mathcal{M}} N_{ff}^c X_c$ as a $M \vee (M' \cap M_\infty)$ - M_∞ bimodule, where X_c is the $M \vee (M' \cap M_\infty)$ - M_∞ bimodule corresponding to $c \in \mathcal{M}$.*

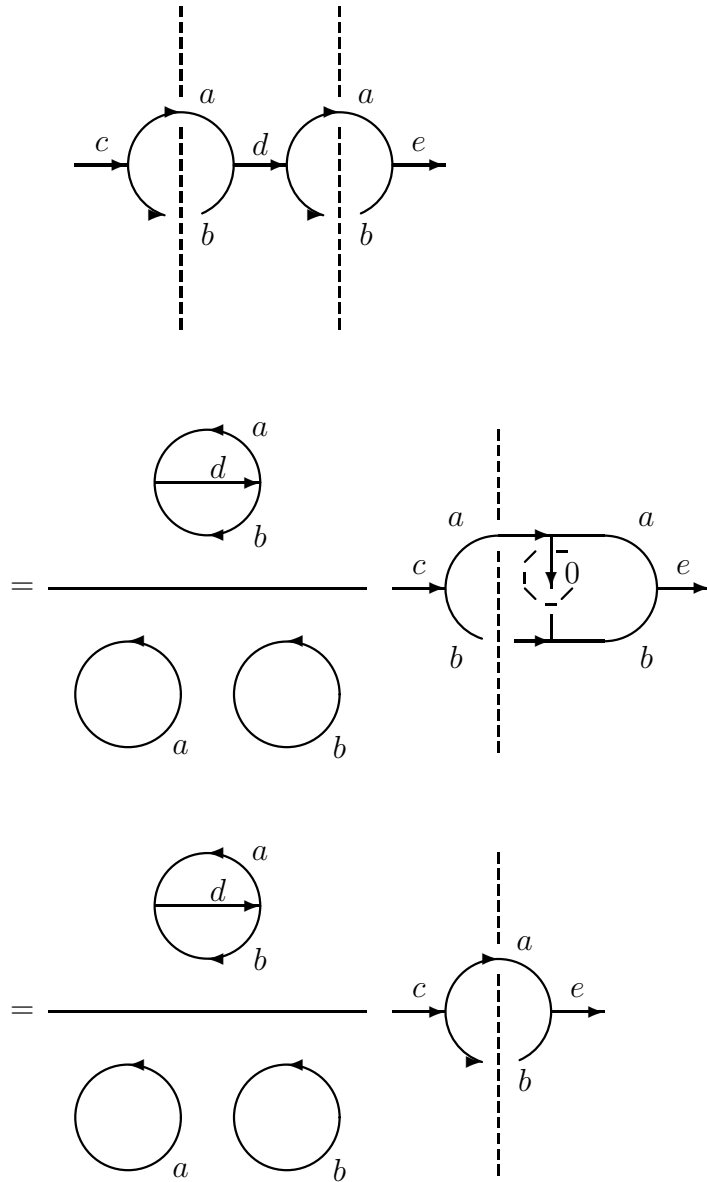

Figure 19: Product $p_{a,b}^{(c,d)} p_{a,b}^{(d,e)}$

Proof: An argument similar to the one in the proof of Theorem 2.1 again works. Q.E.D.

We would like to get a full description of the dual principal graph, but the bimodule $X_{f,f}$ plays a quite subtle role. So we first make the following assumption and later prove that this assumption holds in some cases.

Assumption 3.14 *The M_∞ - M_∞ bimodule $X_{f,f}$ decomposes into n irreducible bimodules and each has the same dimension.*

In this assumption, we mean the square root of the Jones index of the corresponding subfactor of a bimodule by the “dimension” of a bimodule. A. Ocneanu has observed this assumption holds for $SU(2)_{2k}$ and we will prove that this also holds for $SU(3)_{3k}$ in a general framework. We conjecture that this assumption holds for any $SU(n)_{nk}$, but combinatorial complexity has prevented us from proving it, so far.

A simple computation easily gives the following lemma.

Lemma 3.15 *Assumption 3.14 gives the correct global index for the asymptotic inclusion.*

Consider the dual principal graph of the asymptotic inclusion. To each M_∞ - M_∞ or $M \vee (M' \cap M_\infty)$ - M_∞ bimodule, we assign its dimension, as usual. This gives a Perron–Frobenius weight. That is, for an $M \vee (M' \cap M_\infty)$ - M_∞ bimodule corresponding to $c \in \mathcal{M}$, we get $[c]^{1/2}[\mathcal{M}]^{1/2}$ and for an M_∞ - M_∞ bimodule corresponding to $p_{a,b}$ with arbitrary a, b in the model $SU(n)_k$ with $(a, b) \neq (f, f)$, we get $[a]^{1/2}[b]^{1/2}$. We also note that the Perron–Frobenius eigenvalue for this weight is $[\mathcal{M}]^{1/2}$.

Lemma 3.16 *These Perron–Frobenius weights on the $M \vee (M' \cap M_\infty)$ - M_∞ bimodules are compatible with Assumption 3.14.*

Proof: For $c \in \mathcal{M}$, we denote by X_c the corresponding $M \vee (M' \cap M_\infty)$ - M_∞ bimodule. We easily get $[X_c] = [c][\mathcal{M}]$. We can also form a fusion graph using all the primary fields in the model $SU(n)_k$. From the Perron–Frobenius property of this graph, we get

$$n[\mathcal{M}][c]^{1/2} = \sum_{a,b} N_{ab}^c [a]^{1/2}[b]^{1/2},$$

where a, b are arbitrary primary fields in the model $SU(n)_k$. Let L be a set of representatives of the equivalence classes on all the pairs of arbitrary primary fields in the model $SU(n)_k$ excluding (f, f) for the equivalence relation $(a, b) \sim (\sigma^j a, \sigma^{n-j} a)$ with $j \in \mathbf{Z}/n\mathbf{Z}$. Then the right hand side of the equality is equal to

$$n \left(\sum_{(a,b) \in L} N_{ab}^c [a]^{1/2}[b]^{1/2} + N_{ff}^c \frac{[f]}{n} \right),$$

by Assumption 3.14. This gives

$$[\mathcal{M}]^{1/2}[c]^{1/2}[\mathcal{M}]^{1/2} = \sum_{(a,b) \in L} N_{ab}^c [a]^{1/2}[b]^{1/2} + N_{ff}^c \frac{[f]}{n},$$

which is the conclusion, because we have Lemmas 3.12, 3.13.

Q.E.D.

4 Dual principal graphs of the asymptotic inclusions — $SU(2)_k$ case —

With the preliminaries of the previous section, we compute the dual principal graphs of the asymptotic inclusions of the $SU(2)_{2n}$ subfactors, that is, the Jones subfactors of type A_{2n+1} constructed in [17], with $n > 1$. These results were first claimed by Ocneanu. We present a complete proof here, because we will generalize the results in the next Section.

First label the primary fields in $SU(2)_{2n}$ with $0, 1, \dots, 2n$ as usual. Recall that the fusion rule is given as

$$N_{jk}^l = \begin{cases} 1, & \text{if } |j - k| \leq l \leq j + k, j + k + l \in 2\mathbf{Z}, j + k + l \leq 4n, \\ 0, & \text{otherwise.} \end{cases}$$

Note that all the bimodules in \mathcal{M} are labeled with even integers and they are all self-contragredient. The $M \vee (M' \cap M_\infty) - M_\infty$ bimodules arising from the asymptotic inclusion are labeled with $0, 2, \dots, 2n$ and the $M \vee (M' \cap M_\infty) - M \vee (M' \cap M_\infty)$ bimodules are labeled with pairs of even integers $0, 2, \dots, 2n$. This implies that all the $M \vee (M' \cap M_\infty) - M \vee (M' \cap M_\infty)$ bimodules arising from the asymptotic inclusion are also self-contragredient.

On the even vertices of the dual principal graph, we do not know how the $M_\infty - M_\infty$ bimodule corresponding to $p_{n,n}/2$ in Tube \mathcal{M} decomposes into irreducible ones, but the fusion rule as above shows that this bimodule contains exactly one copy of X_0 when we restrict the left action to $M \vee (M' \cap M_\infty)$ by Lemma 3.13. Then Lemma 3.16 implies that the $M_\infty - M_\infty$ bimodule corresponding to $p_{n,n}/2$ is not irreducible and it contains at least one irreducible bimodule whose dimension is half the dimension of this $M_\infty - M_\infty$ bimodule corresponding to $p_{n,n}/2$. Then Lemma 3.15 implies that this $M_\infty - M_\infty$ bimodule corresponding to $p_{n,n}/2$ decomposes into exactly two irreducible bimodules with equal Jones indices and thus Assumption 3.14 holds, because we would have a smaller global index otherwise. We label these two bimodules with $(n, n)_+$ and $(n, n)_-$. We will now determine the dual principal graph of the asymptotic inclusion. By Lemma 3.12, it is enough to determine how the even vertices labeled with $(n, n)_+$ and $(n, n)_-$ are connected to the odd vertices. Since the odd vertex labeled with 0 is connected to one of these two even vertices, we may assume that $(n, n)_+$ is connected to 0.

Lemma 4.1 *The $M_\infty - M_\infty$ bimodules labeled with $(n, n)_\pm$ are self-contragredient.*

Proof: First note that the other $M_\infty - M_\infty$ bimodules are self-contragredient by Lemma 3.8.

We count the number of the paths of length 2 connecting the odd vertex 0 to itself on the principal graph of the asymptotic inclusion, which is the fusion graph of \mathcal{M} , via the contragredient map, because the fusion graph is now connected. By the fusion rule described above, we can go from 0 back to 0 on the principal graph through $(0, 0), (2, 2), \dots, (2n, 2n)$. This implies that the number of the paths is $n + 1$.

We know that the number of paths of length 2 connecting the odd vertex 0 to itself on the dual principal graph of the asymptotic inclusion via the contragredient map is also equal to $n - 1$ by (bi)unitarity of the connection arising from the asymptotic inclusion [30, page 130] (or [11, Section 10.3]).

The M_∞ - M_∞ bimodules labeled with

$$(0, 0) = (2n, 2n), (1, 1) = (2n - 1, 2n - 1), \dots, (n - 1, n - 1) = (n + 1, n + 1)$$

give n paths from 0 back to 0 on the dual principal graph. (Here the equality as in $(0, 0) = (2n, 2n)$ means that the bimodule labeled with $p_{0,0}$ is equal to that with $p_{2n,2n}$ because of Lemma 3.8.) This means that we still have another path from 0 back to 0 on the dual principal graph through the even vertex labeled with $(n, n)_+$.

This means that the M_∞ - M_∞ bimodule labeled with $(n, n)_+$, hence that with $(n, n)_-$, is contragredient to itself. Q.E.D.

We next count the number of paths connecting the odd vertices 0 and 2 on the principal graph of the asymptotic inclusion. (In this kind of counting in the rest of this paper, by a “path” we mean a path of length 2 on the graph via the contragredient map.) Again by the fusion rule, we can go from 0 to 2 on the principal graph through $(2, 2), (4, 4), \dots, (2n - 2, 2n - 2)$. This implies that the number of the paths is $n - 1$.

Again by unitarity, the number of the paths connecting the odd vertices 0 and 2 on the dual principal graph is also equal to $n - 1$. The even vertices labeled with $(1, 1), (2, 2), \dots, (n - 1, n - 1)$ are connected both to the odd vertices 0 and 2 by Lemma 3.12. These already give the correct number of paths, so this fact means that the even vertex $(n, n)_+$ is not connected to the odd vertex 2. Then Lemma 3.13 implies that the even vertex $(n, n)_-$ is connected to the odd vertex 2.

Similarly, we can count the number of paths from 0 to $4, 6, \dots$ on the principal/dual principal graphs with the fusion rule. Then unitarity gives the following description of the dual principal graph.

Theorem 4.2 *Let $N \subset M$ be the subfactor corresponding to $SU(2)_{2n}$. Then the even vertex $(n, n)_+$ of the dual principal graph of the asymptotic inclusion is connected to the odd vertices $0, 4, \dots$. The even vertex $(n, n)_-$ of the dual principal graph is connected to the odd vertices $2, 6, \dots$*

As a corollary of the above description, we get the following, which was announced by Ocneanu in [36, page 41]. Note that this Corollary gives the number of the even vertices of the dual principal graph of the asymptotic inclusions. These are also the dimensions of the Hilbert spaces $H_{S^1 \times S^1}$ in the corresponding topological quantum field theories.

Corollary 4.3 *Let $N \subset M$ be the subfactor corresponding to $SU(2)_k$, that is, the Jones subfactor of type A_{k+1} . Assume $k > 2$. Then the number of the irreducible*

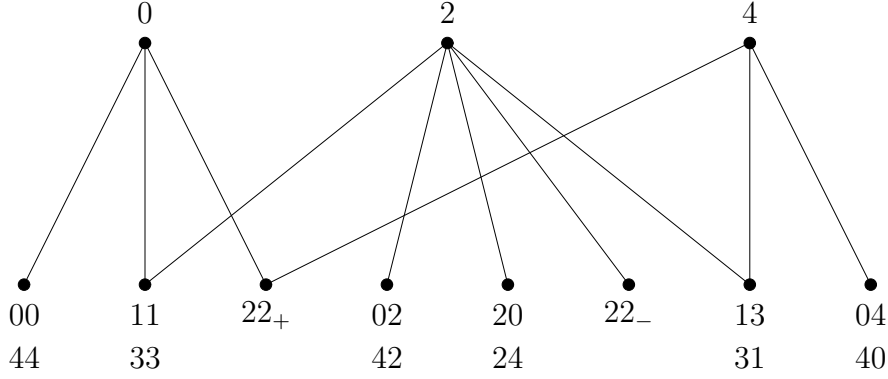

Figure 20: Dual principal graphs for $SU(2)_4, A_5$

M_∞ - M_∞ bimodules arising from the asymptotic inclusion is given as follows.

$$\begin{aligned} & \left(\frac{k+1}{2} \right)^2, & \text{if } k \text{ is odd,} \\ & \frac{k^2}{4} + \frac{k}{2} + 2, & \text{if } k \text{ is even.} \end{aligned}$$

We list some examples of the dual principal graphs. The first one is for $SU(2)_4$, which is the Jones subfactor of type A_5 . It is well known that this subfactor of index 3 is of the form $R \rtimes S_2 \subset R \rtimes S_3$, where S_2 and S_3 are the symmetric groups of order 2 and 3 respectively and these groups act freely on the hyperfinite II_1 factor R . (See [30].) Thus the paragon of the asymptotic inclusion is given by that of the subfactor $R^{S_3 \times S_3} \subset R^{S_3}$, where S_3 is diagonally embedded into $S_3 \times S_3$ and the group S_3 acts freely on R , by Ocneanu's theorem. (See [21, Lemma 2.15], [22, Appendix], [11, Section 12.8].)

So the (dual) principal graphs of the asymptotic inclusion can be described with Ocneanu's theorem on subfactors of the form $R^G \subset R^H$, where G is a finite group acting freely on a II_1 factor R and H is a subgroup of G . (See [25] for this type of computation.) Of course, this method gives the same result as in Figure 20.

A more complicated example of the dual principal graph of the asymptotic inclusion is given in Figure 21.

In the graphs in Figures 20, 21, the vertices labeled with pairs of odd numbers arise, while the original M - M bimodules are labeled with only even numbers. These odd numbers correspond to the ghosts in the terminology of Ocneanu [36].

5 Dual principal graphs of the asymptotic inclusions — $SU(3)_k$ case —

Now we work on the asymptotic inclusions of the $SU(3)_{3k}$ -subfactors and give our main results in this paper. We have to determine how the central projection $p_{f,f}/3$

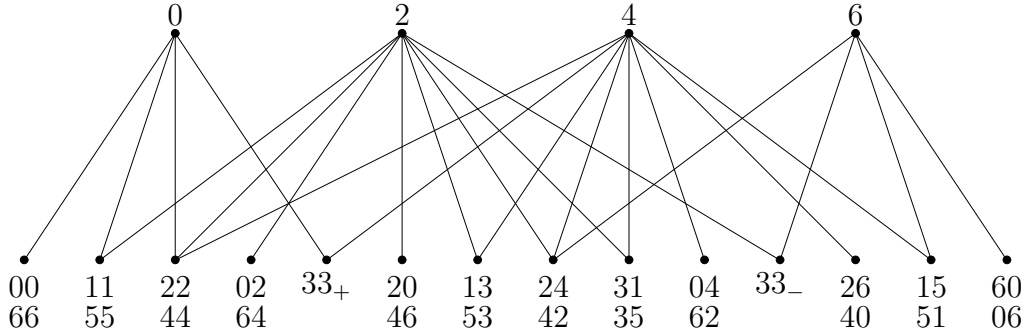

Figure 21: Dual principal graphs for $SU(2)_6, A_7$

decomposes into minimal central projections in the tube algebra $\text{Tube } \mathcal{M}$.

Lemmas 3.13 and 3.16 imply that $p_{f,f}/3$ contains at least one minimal central projection $p_{f,f}^{(0)}$, the dimension of the corresponding irreducible M_∞ - M_∞ bimodule of which is one third of that of the M_∞ - M_∞ bimodule corresponding to $p_{f,f}/3$. This argument also shows that the odd vertex of the dual principal graph labeled with 0 is connected to the even vertex labeled with $p_{f,f}^{(0)}$ with exactly one edge and also that the odd vertex 0 is not connected to the other even vertices arising from the decomposition of $p_{f,f}/3$.

Lemma 5.1 *The irreducible M_∞ - M_∞ bimodule corresponding to $p_{f,f}^{(0)}$ is contragredient to itself.*

Proof: We again count the number of the appropriate paths as in the proof of Lemma 4.1.

We first count the number of the paths connecting the odd vertex 0 to itself on the principal graph of the asymptotic inclusion. Let l be the number of the primary fields in the WZW-model $SU(3)_{3k}$. Then it is easy to see that the number of the primary fields in \mathcal{M} is $(l+2)/3$. By the fusion rule, the number of paths from 0 back to 0 on the principal graph is $(l+2)/3$.

It is also easy to see that the number of paths connecting the odd vertex 0 to itself on the dual principal graph of the asymptotic inclusion without going through the even vertices corresponding to some minimal central projection appearing in the decomposition of $p_{f,f}/3$ is $(l-1)/3$.

These mean that we still have one more path from 0 back to 0 on the dual principal graph, which must go through the even vertex corresponding to $p_{f,f}^{(0)}$. That is, the M_∞ - M_∞ bimodule corresponding to $p_{f,f}^{(0)}$ is self-contragredient. Q.E.D.

Lemma 5.2 *If $c \in \mathcal{M}$ satisfies $N_{ff}^c = 1$, then the odd vertex of the dual principal graph labeled with c is connected to the even vertex labeled with $p_{f,f}^{(0)}$ with exactly one edge.*

Proof: We count the number of appropriate paths again.

The number of paths connecting the odd vertex 0 to itself on the principal graph of the asymptotic inclusion is $\sum_{a \in \mathcal{M}} N_{a\bar{a}}^c$, because the principal graph is the fusion graph which is now connected.

Let l be the number of the edges connecting the odd vertex of the dual principal graph labeled with c and the even vertex labeled with $p_{f,f}^{(0)}$. Lemma 3.12 implies that l is 0 or 1, because $N_{ff}^c = 1$. We next count the number of paths connecting the odd vertex 0 to itself on the dual principal graph of the asymptotic inclusion. This number is equal to $(\sum_a N_{a\bar{a}}^c - N_{ff}^c)/3 + l$, where the summation is over all the primary fields a of the WZW-model $SU(3)_{3k}$.

Since the two numbers are equal, we get

$$\sum_{\text{gr}(a)=1,2} N_{a\bar{a}}^c = 2 \sum_{\text{gr}(a)=1} N_{a\bar{a}}^c = -1 + 3l,$$

which implies that $3l - 1$ is even. That is, we get $l = 1$.

Q.E.D.

As in Section 3, we know that the subsystem $\{x \in \mathcal{M} \mid S_{0x} = S_{00}\}$ of \mathcal{M} is given as $\{0, \sigma, \sigma^2\}$. The above Lemma gives the following.

Corollary 5.3 *Each of the odd vertices of the dual principal graph labeled with $0, \sigma, \sigma^2$ is connected to the even vertex labeled with $p_{f,f}^{(0)}$ with exactly one edge.*

Proof: This follows from the above Lemma, because we have $N_{ab}^c = N_{a\sigma(b)}^{\sigma(c)}$ by [46].

Q.E.D.

We now need some lemmas for the fusion rule of the WZW-model $SU(3)_{3k}$, which has been obtained by Goodman–Wenzl in [14] as a quantum version of the classical Littlewood–Richardson rule. Each primary field is represented by a Young diagram and we denote a primary field by the corresponding Young diagram.

Lemma 5.4 *We have the following fusion rule in the WZW-model $SU(3)_{3k}$.*

$$N_{ff}^{\square} = 1.$$

Proof: By [13], we can apply the fusion rule described in [14]. By the Young–Pieri rule in [14, Proposition 2.6 (a)] and the classical Littlewood–Richardson rule (see [27, Section 1.9], for example), we get the conclusion.

Q.E.D.

Lemma 5.5 *We have the following fusion rule in the WZW-model $SU(3)_{3k}$.*

$$N_{ff}^{\square^{\mathbb{P}}} = 2.$$

Proof: This follows from Lemma 5.4 and

$$\square^3 = \emptyset + \square\square + 2 \square^{\mathbb{P}},$$

because $f \square^3$ contains 6 copies of f .

Q.E.D.

Lemma 5.6 *We have the following identity in the WZW-model $SU(3)_{3k}$.*

$$\sum_{\text{gr}(a)=0} N_{\alpha^3}^a = \sum_{\text{gr}(b)=1} N_{\alpha^3}^b.$$

Proof: Since the level is $3k$, the numbers of the primary fields of grade 0, 1, 2 are $3k(k+1)/2 + 1$, $3k(k+1)/2$, $3k(k+1)/2$ respectively. Recall that the primary fields are arrayed in a triangular picture for $SU(3)_k$ as in Figure 3.8.

We have three primary fields of grade 0 at the three corners of the triangle. The contribution of these terms on the left hand side of the identity in this Lemma is 3. (See [14], [27, Section 1.9], [46] again for the computations of the fusion rule.)

We have $3(k-1)$ primary fields of grade 0 on the three edges of the triangle with three corners excluded. Each term gives a contribution of 3 on the left hand side of the identity, so we get $9(k-1)$ as the total contribution.

We next have $3k^2/2 - 3k/2 + 1$ primary fields of grade 0 inside the triangle. Each term gives a contribution of 6 on the left hand side of the identity, so we get $9k^2 - 9k + 6$ as the total contribution.

The sum of these three contributions is $9k^2$ and this is the number on the left hand side of the identity.

We similarly evaluate the right hand side of the identity.

We have $3k$ primary fields of grade 1 on the three edges of the triangle. Each term gives a contribution of 3 on the right hand side of the identity, so we get $9k$ as the total contribution.

We next have $3k^2/2 - 3k/2$ primary fields of grade 1 inside the triangle. Each term gives a contribution of 6 on the right hand side of the identity, so we get $9k^2 - 9k$ as the total contribution.

The sum of these two contributions is $9k^2$, which is equal to the left hand side.

Q.E.D.

Lemma 5.7 *We have the following identity in the WZW-model $SU(3)_{3k}$.*

$$\sum_{\text{gr}(a)=0} N_{\alpha\bar{\alpha}}^{\alpha\bar{\alpha}} = \sum_{\text{gr}(b)=1} N_{\alpha\bar{\alpha}}^{\alpha\bar{\alpha}} + 1.$$

Proof: Let α be $\alpha\bar{\alpha}$. We next count the number of the paths from the odd vertex 0 to the odd vertex labeled with α on both the principal and the dual principal graphs. The number $\sum_{\text{gr}(a)=0} N_{\alpha\bar{\alpha}}^{\alpha}$ gives the number of the paths on the principal graph.

Let l be the number of the edges connecting the odd vertex α and the even vertex labeled with $p_{f,f}^{(0)}$ on the dual principal graph. By Lemmas 3.13 and 5.4, we know that l is 0 or 1. Lemmas 3.12, 3.13, and 5.4 imply that the number of the paths connecting 0 and α on the dual principal graph is $(\sum_b N_{bb}^{\alpha} - 1)/3 + l$, where the summation is over all the primary fields b in the model $SU(3)_{3k}$.

Since the two numbers of the paths are equal, we get

$$2 \sum_{\text{gr}(a)=0} N_{\alpha\bar{\alpha}}^{\alpha} = \sum_{\text{gr}(b)=1,2} N_{bb}^{\alpha} - 1 + 3l = 2 \sum_{\text{gr}(b)=1} N_{bb}^{\alpha} - 1 + 3l.$$

This implies $l = 1$ because the both sides are even numbers. We then get the conclusion. Q.E.D.

Lemma 5.8 *We have the following identity in the WZW-model $SU(3)_{3k}$.*

$$\sum_{\text{gr}(a)=0} N_{a\bar{a}}^{\square} = \sum_{\text{gr}(b)=1} N_{b\bar{b}}^{\square} - 1.$$

Proof: Recall that we have

$$\square^3 = \emptyset + \square\square\square + 2 \square\square. \quad (2)$$

Lemma 5.6 and Frobenius reciprocity imply

$$\sum_{\text{gr}(a)=0} N_{a\bar{a}}^{\square^3} = \sum_{\text{gr}(b)=1} N_{b\bar{b}}^{\square^3}. \quad (3)$$

We also have the easy identity,

$$\sum_{\text{gr}(a)=0} N_{a\bar{a}}^{\emptyset} = \sum_{\text{gr}(b)=0} N_{b\bar{b}}^{\emptyset} + 1, \quad (4)$$

since the both sides are equal to $3k(k+1)/2 + 1$.

Identities (2), (3), (4) and Lemma 5.7 imply the conclusion. Q.E.D.

Lemma 5.9 *The odd vertex of the dual principal graph labeled with \square is not connected to the even vertex labeled with $p_{f,f}^{(0)}$.*

Proof: We count the number of appropriate paths again.

The number of paths connecting the odd vertex 0 to \square on the principal graph of the asymptotic inclusion is $\sum_{\text{gr}(a)=0} N_{a\bar{a}}^{\square}$ because the principal graph is the fusion graph.

Let l be the number of edges connecting the odd vertex of the dual principal graph labeled with \square to the even vertex labeled with $p_{f,f}^{(0)}$.

The number of paths connecting the odd vertex 0 to \square on the dual principal graph of the asymptotic inclusion is $(\sum_b N_{b\bar{b}}^{\square} - N_{ff}^{\square})/3 + l$. Lemmas 5.5, 5.8 show $l = 0$. Q.E.D.

We finally prove the main theorem in this Section as follows.

Theorem 5.10 *For the subfactor $N \subset M$ arising from the WZW-model $SU(3)_{3k}$, Assumption 3.14 holds.*

Proof: Since we have Lemmas 3.13, 5.5, we have one of the following two cases.

1. We have a minimal central projection $p_{ff}^{(1)}$ majorized by $p_{ff}/3$ such that the odd vertex labeled with \square is connected to the even vertex labeled with $p_{ff}^{(1)}$ on the dual principal graph of the asymptotic inclusion by exactly two edges.

2. We have two minimal central projections $p_{ff}^{(1)}, p_{ff}^{(2)}$ majorized by $p_{ff}/3$ such that the odd vertex labeled with \boxplus is connected to each of the even vertices labeled with $p_{ff}^{(1)}, p_{ff}^{(2)}$ on the dual principal graph of the asymptotic inclusion by exactly one edge.

Suppose that we have Case 1. Lemma 3.16 shows that the dimension of the bimodule corresponding to $p_{ff}^{(1)}$ is equal to that of the bimodule corresponding to $p_{ff}^{(0)}$. Lemma 3.15 implies that the central projection $p_{ff}^{(2)} = p_{ff}/3 - p_{ff}^{(0)} - p_{ff}^{(1)}$ is minimal and the dimension of the bimodule corresponding to $p_{ff}^{(2)}$ is also equal to that of the bimodule corresponding to $p_{ff}^{(0)}$.

Next suppose that we have Case 2. Lemma 3.16 implies that the sum of the dimensions of the bimodules corresponding to $p_{ff}^{(1)}, p_{ff}^{(2)}$ is equal to twice of that of the bimodule corresponding to $p_{ff}^{(0)}$. This shows $p_{ff}/3 = p_{ff}^{(0)} + p_{ff}^{(1)} + p_{ff}^{(2)}$. Then Lemma 3.15 then implies that these two dimensions have to be equal.

In any case, we have a decomposition $p_{ff}/3 = p_{ff}^{(0)} + p_{ff}^{(1)} + p_{ff}^{(2)}$ into minimal central projections and each of the three minimal central projection has the same corresponding dimension. This completes the proof. Q.E.D.

This Theorem implies the following by a simple computation. This Corollary is a generalized version of Corollary 4.3. Again note that this Corollary gives the number of even vertices of the dual principal graph of the asymptotic inclusions and that these are also the dimensions of the Hilbert spaces $H_{S^1 \times S^1}$ in the corresponding topological quantum field theories for the original subfactors.

Corollary 5.11 *Let $N \subset M$ be the subfactor corresponding to $SU(3)_k$ with $k > 2$. Then the number of the irreducible M_∞ - M_∞ bimodules arising from the asymptotic inclusion is given as follows.*

$$\begin{aligned} & \frac{(k+1)^2(k+2)^2}{36}, & \text{if } k \not\equiv 0 \pmod{3}, \\ & \frac{k^4 + 6k^3 + 13k^2 + 12k + 108}{36}, & \text{if } k \equiv 0 \pmod{3}. \end{aligned}$$

As examples, we work out the dual principal graphs for small k such as $k = 3, 6$ in the rest of this Section.

First, we label the primary fields of $SU(3)_3$ as in Figure 22.

Then the principal graph of the asymptotic inclusion of the subfactor corresponding to $SU(3)_3$ is given as the fusion graph as in the upper half of Figure 23. For the dual principal graph, we know the graph except for the edges connected to the three vertices $(99)_0, (99)_1, (99)_2$. From the Perron–Frobenius property, we can determine these edges as in the bottom half of Figure 23. These edges are marked thick.

Since the subfactor corresponding to $SU(3)_3$ has index 4 and is described as $R \rtimes A_3 \subset R \rtimes A_4$, where A_3 and A_4 are the alternating groups of order 3 and 4 respectively and these groups act freely on the hyperfinite II_1 factor R , the paragrass of the asymptotic inclusion is given by that of the subfactor $R^{A_4 \times A_4} \subset R^{A_4}$, where A_4

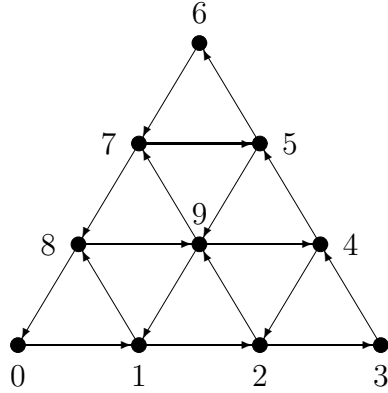

Figure 22: Primary fields for $SU(3)_3$

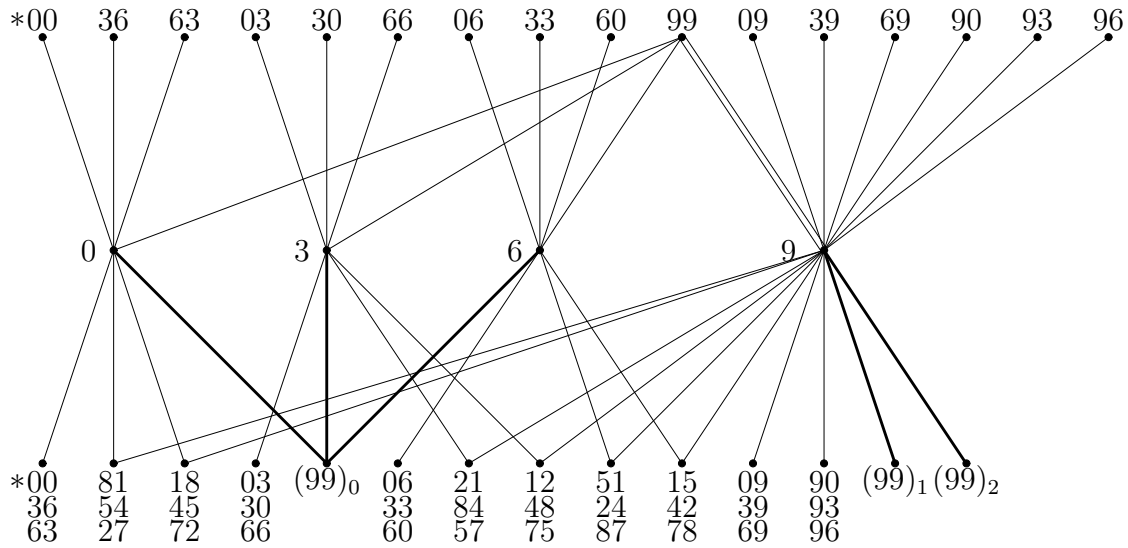

Figure 23: (dual) principal graphs for $SU(3)_3$

is diagonally embedded into $A_4 \times A_4$ and the group A_4 acts freely on R , by Ocneanu's theorem again. (See [21, Lemma 2.15], [22, Appendix], [11, Section 12.8].)

So the (dual) principal graphs of the asymptotic inclusion can be described with Ocneanu's theorem again. (See [25].) Of course, this method gives the same result as in Figure 23.

The next example is $SU(3)_6$. In this case, the system \mathcal{M} has 10 primary fields and thus the principal graph of the asymptotic inclusion has 100 even vertices, and the dual principal graph has 90 even vertices. Since these graphs are too complicated, we draw only the edges concerned with the three even vertices $p_{ff}^{(0)}, p_{ff}^{(1)}, p_{ff}^{(2)}$. Then

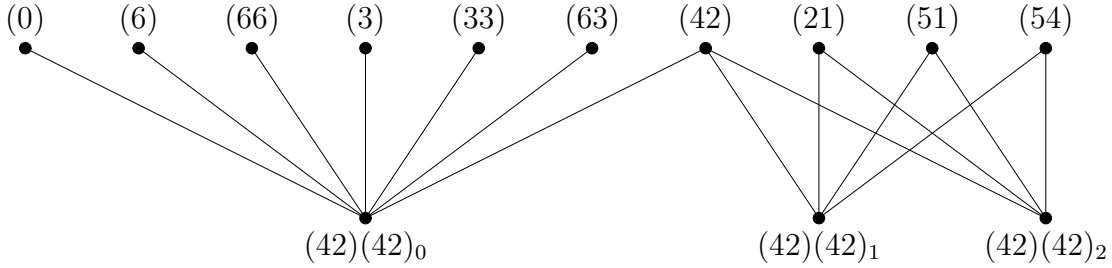

Figure 24: Part of the dual principal graphs for $SU(3)_6$

the Perron–Frobenius property and counting of paths with unitarity gives the graph as in Figure 24. In this Figure, the symbol (lm) denotes the Young diagram with l boxes in the first row and m boxes in the second row.

6 Orbifold subfactors

In Sections 4, 5, we have observed that the even vertices of the dual principal graphs of the asymptotic inclusions are given by merging/splitting of the vertices with symmetries on pairs of the original labels. In the $SU(2)_k$ case, Ocneanu has noticed that this situation is similar to the orbifold construction for subfactors studied by us in [8], [20]. (See also [15], [50].) However, the dual principal graphs we have studied in Sections 4, 5 are *not* orbifold graphs in the sense of [8], [20], [50], because we have merging/splitting of the vertices only for the even vertices. In this Section, we study a relation of this orbifold phenomena of Ocneanu to the orbifold construction in our sense.

Let $N \subset M$ be the Jones subfactor of type A_{4n-3} . That is, it is the hyperfinite type II_1 subfactor corresponding to $SU(2)_{4n-4}$. To avoid disconnectedness of the fusion graph, we assume that $n > 2$. (If $n = 2$, we get a subfactor arising from a free action of a group S_3 , so everything can be studied with classical methods on group actions.) As in [20], we get the orbifold subfactor $P = N \rtimes_{\sigma} \mathbf{Z}/2\mathbf{Z} \subset Q = M \rtimes_{\sigma} \mathbf{Z}/2\mathbf{Z}$ of type D_{2n} , where σ gives a non-strongly-outer action of $\mathbf{Z}/2\mathbf{Z}$ on the subfactor $N \subset M$ in the sense of [3]. (See also [15].)

Let α be the dual action of σ on $P \subset Q$. Then we have $N = P^{\alpha}$ and $M = Q^{\alpha}$, of course. Then the asymptotic inclusion $M \vee (M' \cap M_{\infty}) \subset M_{\infty}$ is described as $Q^{\alpha} \vee (Q' \cap Q_{\infty})^{\alpha} \subset Q_{\infty}^{\alpha}$. Putting $R = (Q \vee (Q' \cap Q_{\infty}))^{\alpha}$, we get $Q^{\alpha} \vee (Q' \cap Q_{\infty})^{\alpha} \subset R \subset Q_{\infty}^{\alpha}$ and $[R : Q^{\alpha} \vee (Q' \cap Q_{\infty})^{\alpha}] = 2$. This intermediate subfactor corresponds to the intermediate subfactor $(M_{\omega})^{\sigma}$ of the central sequence subfactor $N^{\omega} \cap M' \subset M_{\omega}$ described in [21, Section 3], [22, Section 4] in the correspondence of Ocneanu [31, page 42], [22, Theorem 4.1]. (Here ω is a free ultrafilter over \mathbf{N} . See also [11, Theorem 15.32].)

We use the notation $[[M : N]]$ for the global index of $N \subset M$ as in [40]. We easily

get

$$[[M_\infty : M \vee (M' \cap M_\infty)]]/4 = [[Q_\infty : Q \vee (Q' \cap Q_\infty)]]$$

from the description of the principal graph as the fusion graph. Note that $R \subset Q_\infty^\alpha$ is given as the simultaneous fixed point algebras of $Q \vee (Q' \cap Q_\infty) \subset Q_\infty$ by the action α . By looking at α , we can conclude that we have one of the following three cases.

1. $[[M_\infty : R]] = [[M_\infty : M \vee (M' \cap M_\infty)]]/4$.
2. $[[M_\infty : R]] = [[M_\infty : M \vee (M' \cap M_\infty)]]/2$.
3. $[[M_\infty : R]] = [[M_\infty : M \vee (M' \cap M_\infty)]]/8$.

That is, if the action is strongly outer in the sense of [3] and has a trivial Loi invariant, then we get Case 1, if the action is strongly outer and has a non-trivial Loi invariant, then we have Case 2, and if the action is not strongly outer, then we have Case 3. Since the fusion rule algebra of the M_∞ - M_∞ bimodules arising from $R \subset M_\infty$ is a fusion rule subalgebra of those arising from $M \vee (M' \cap M_\infty) \subset M_\infty$ (see [40, Lemma 2.4], for example), we look for a fusion rule subalgebra of that of the M_∞ - M_∞ bimodules arising from the asymptotic inclusion of $N \subset M$.

We first study fusion rule subalgebras of the WZW-model $SU(2)_{2k}$.

Lemma 6.1 *Let \mathcal{N} be a closed subsystem of primary fields under fusion of the WZW-model $SU(2)_{2k}$ labeled as $\{0, 1, 2, \dots, 2k\}$. Then \mathcal{N} is one of the following; $\{0\}$, $\{0, 2k\}$, $\{0, 2, 4, \dots, 2k\}$, $\{0, 1, 2, \dots, 2k\}$*

Proof: It is clear that these four indeed give subsystems.

Suppose that $\mathcal{N} \neq \{0\}$. Let l be the smallest non-zero label appearing in \mathcal{N} . If $l = 1$, $l = 2$, or $l = 2k$, then we clearly have $\mathcal{N} = \{0, 1, 2, \dots, 2k\}$, $\mathcal{N} = \{0, 2, 4, \dots, 2k\}$, $\mathcal{N} = \{0, 2k\}$, respectively. If $2 < l < 2k$, then we would have $N_l^2 = 1$, which implies $2 \in \mathcal{N}$ and thus a contradiction. Q.E.D.

Lemma 6.2 *Let \mathcal{N} be the system of M_∞ - M_∞ bimodules arising from the asymptotic inclusion of the subfactor $N \subset M$ of type A_{4n-3} . Let γ be the global index of this system. Suppose we have a subsystem \mathcal{N}_0 of \mathcal{N} with global index equal to one of $\gamma/2$, $\gamma/4$, $\gamma/8$. Then \mathcal{N}_0 is a subsystem of the M_∞ - M_∞ bimodules labeled with pairs of even numbers as in Section 4 and its global index is $\gamma/2$.*

Proof: It is clear that the subsystem of the M_∞ - M_∞ bimodules labeled with pairs of even numbers has global index $\gamma/2$.

Suppose that \mathcal{N}_0 contains a bimodule labeled with a pair of odd numbers. By taking an appropriate tensor power of this bimodule, we have $(2, 2)$ in this system \mathcal{N}_0 .

We set X be the set of labels of pairs of integers appearing in \mathcal{N}_0 and set $Y = \{l \mid (0, l) \in X\}$. Then Y gives a subsystem of the original WZW-model $SU(2)_{4n-4}$.

By Lemma 6.1, we have four cases for Y . The assumption on the global index forces $Y = \{0, 2, 4, \dots, 4n - 4\}$ and $[\mathcal{N}_0] = \gamma/2$. Then we have the conclusion. Q.E.D.

Let β be the M_∞ - M_∞ bimodule labeled with $(0, 4n - 4) = (4n - 4, 0)$. It is clear that this bimodule has dimension 1. We can apply the orbifold construction for tensor categories as in [51] and get the following Lemma.

Lemma 6.3 *Let $N \subset M$, $P \subset Q$ be as above. Let \mathcal{N}_0 be the system of M_∞ - M_∞ bimodules arising from $R \subset Q_\infty^\alpha = M_\infty$. Let \mathcal{N}_1 be the system of Q_∞ - Q_∞ bimodules arising from the asymptotic inclusion of the subfactor $P \subset Q$ of type D_{2n} . Then the system \mathcal{N}_1 is given as the orbifold construction of \mathcal{N}_0 with β as above.*

Proof: Let \mathcal{N} be the system of M_∞ - M_∞ bimodules arising from the asymptotic inclusion of the subfactor $N \subset M$ of type A_{4n-3} .

Lemma 6.2 implies that $[\mathcal{N}_1] = [\mathcal{N}_0]/2$, which gives the conclusion. Q.E.D.

Theorem 6.4 *Let $N \subset M$ be the Jones subfactor of type A_{4n-3} with $n > 2$. Let \mathcal{N}_0 be the subsystem of M_∞ - M_∞ bimodules arising from the asymptotic inclusion $M \vee (M' \cap M_\infty) \subset M_\infty$ labeled with pairs of even integers as in Section 4.*

Let σ be the outer, non-strongly-outer automorphism of order 2 of $N \subset M$. The system \mathcal{N}_0 is isomorphic to the system of $(M \otimes M)^{\sigma \otimes \sigma}$ - $(M \otimes M)^{\sigma \otimes \sigma}$ bimodules arising from the orbifold subfactor $(N \otimes N)^{\sigma \otimes \sigma} \subset (M \otimes M)^{\sigma \otimes \sigma}$.

Proof: This follows from Lemma 6.3. Q.E.D.

The meaning of the above Theorem is as follows. When we apply the “quantum double” construction to a degenerate system, it is not enough to take a simple “double” to because of degeneracy. Pairs labeled with ghosts appear so that the non-degeneracy is recovered, but then we have too many bimodules and the global index, giving the size of the system, becomes too large. Then the orbifold construction removes this redundancy and the correct global index is realized. The bimodules labeled with pairs of ghosts disappear when we remove an intermediate subfactor of index 2, which is the order of the orbifold construction.

7 Orbifold construction for braiding

Theorem 7.1 *The system of the M - M bimodules arising from a subfactor $N \subset M$ of type D_{2n} , $n > 2$, has a non-degenerate braiding.*

Proof: The system of the Q_∞ - Q_∞ bimodules has a non-degenerate braiding by Ocneanu’s general theory. (See [11, Section 12.7], for example.)

Lemma 6.3 implies that the system given by the orbifold construction on the system $(0, 0), (0, 2), \dots, (0, 4n - 4) = \beta$ with β is a subsystem of the Q_∞ - Q_∞ bimodules. We thus get a braiding naturally. The non-degeneracy is also easy to see, because if have degeneracy, then the degenerate subsystem would give a finite abelian group by [5], which is impossible by $n > 2$. Q.E.D.

Corollary 7.2 *The dual principal graph of the asymptotic inclusion of the hyperfinite II_1 subfactor $N \subset M$ with principal graph D_{2n} is the fusion graph of the system of M - M bimodules.*

Proof: This follows from Theorem 7.1 and Proposition 2.2. Q.E.D.

Remark 7.3 Ocneanu has constructed a braiding on the even vertices of D_{2n} with an entirely different method in [37]. His theory in [37] also shows that his braiding and ours must be the same.

Turaev and Wenzl [44] have worked on a similar construction to our orbifold construction in categories of tangles. In their approach to the Reshetikhin–Turaev type topological quantum field theory [39], they need a certain non-degeneracy and make some construction similar to our orbifold construction to remove the degeneracy. It seems that their construction, in particular, gives a braiding on the even vertices of D_{2n} and we expect that their braiding is also same as ours, but the actual relation is not clear.

The basic idea is that the orbifold construction can be performed when we have some kind of degeneracy and this degeneracy is removed by the orbifold construction.

References

- [1] J. de Boer & J. Goeree, *Markov traces and II_1 factors in conformal field theory*, Comm. Math. Phys. **139** (1991), 267–304.
- [2] M. Choda, *Index for factors generated by Jones’ two sided sequence of projections*, Pac. J. Math. **139** (1989), 1–16.
- [3] M. Choda & H. Kosaki, *Strongly outer actions for an inclusion of factors*, J. Funct. Anal. **122** (1994), 315–332.
- [4] V. G. Drinfel’d, *Quantum groups*, Proc. ICM-86, Berkeley, 798–820.
- [5] S. Doplicher & J. E. Roberts, *A new duality theory for compact groups*, Invent. Math. **98** (1989), 157–218.
- [6] J. Erlijman, *New subfactors from braid group representations*, Ph. D. dissertation at University of Iowa (1995).
- [7] J. Erlijman, *Two-sided braid subfactors and asymptotic inclusions*, preprint 1996.
- [8] D. E. Evans & Y. Kawahigashi, *Orbifold subfactors from Hecke algebras*, Comm. Math. Phys. **165** (1994), 445–484.
- [9] D. E. Evans & Y. Kawahigashi, *From subfactors to 3-dimensional topological quantum field theories and back — a detailed account of Ocneanu’s theory —*, Internat. J. Math. **6** (1995), 537–558.

- [10] D. E. Evans & Y. Kawahigashi, *On Ocneanu's theory of asymptotic inclusions for subfactors, topological quantum field theories and quantum doubles*, Internat. J. Math. **6** (1995), 205–228.
- [11] D. E. Evans & Y. Kawahigashi, *Quantum symmetries on operator algebras*, book manuscript, to appear.
- [12] J. Fuchs, *Affine Lie algebras and quantum groups*, Cambridge University Press, 1992.
- [13] F. Goodman & T. Nakanishi, *Fusion algebras in integrable systems in two dimensions*, Phys. Lett. **B262** (1991), 259–264.
- [14] F. Goodman & H. Wenzl, *Littlewood Richardson coefficients for Hecke algebras at roots of unity*, Adv. Math. **82** (1990), 244–265.
- [15] S. Goto, *Orbifold construction for non-AFD subfactors*, Internat. J. Math. **5** (1994), 725–746.
- [16] S. Goto, *Quantum double construction for subfactors arising from periodic commuting squares*, preprint 1996.
- [17] V. F. R. Jones, *Index for subfactors*, Invent. Math. **72** (1983), 1–15.
- [18] V. Kac, *Infinite dimensional Lie algebras*, Cambridge University Press, 1990.
- [19] L. Kauffman & S. L. Lins, *Temperley–Lieb recoupling theory and invariants of 3-manifolds*, Princeton University Press, Princeton, (1994).
- [20] Y. Kawahigashi, *On flatness of Ocneanu's connections on the Dynkin diagrams and classification of subfactors*, J. Funct. Anal. **127** (1995), 63–107.
- [21] Y. Kawahigashi, *Centrally trivial automorphisms and an analogue of Connes's $\chi(M)$ for subfactors*, Duke Math. J. **71** (1993), 93–118.
- [22] Y. Kawahigashi, *Orbifold subfactors, central sequences and the relative Jones invariant κ* , Internat. Math. Res. Notices (1995), 129–140.
- [23] T. Kohno & T. Takata, *Symmetry of Witten's 3-manifold invariants for $sl(n, \mathbf{C})$* , J. Knot Theory Ramif. **2** (1993), 149–169.
- [24] H. Kosaki, A. Munemasa, & S. Yamagami, *On fusion algebras associated to finite group actions*, to appear in Pac. J. Math.
- [25] H. Kosaki & S. Yamagami, *Irreducible bimodules associated with crossed product algebras*, Internat. J. Math. **3** (1992), 661–676.
- [26] R. Longo & K.-H. Rehren, *Nets for subfactors*, Rev. Math. Phys. **7** (1995), 567–597.

- [27] I. G. Macdonald, *Symmetric functions and Hall polynomials*, Oxford Mathematical Monographs, Oxford University Press, New York, 1995.
- [28] T. Masuda, *An analogue of Longo's canonical endomorphism for bimodule theory and its application to asymptotic inclusions*, to appear in *Internat. J. Math.*
- [29] G. Moore & N. Seiberg, *Classical and quantum conformal field theory*, *Comm. Math. Phys.* **123** (1989), 177–254.
- [30] A. Ocneanu, *Quantized group string algebras and Galois theory for algebras*, in “Operator algebras and applications, Vol. 2 (Warwick, 1987),” *London Math. Soc. Lect. Note Series Vol. 136*, Cambridge University Press, 1988, pp. 119–172.
- [31] A. Ocneanu, “Quantum symmetry, differential geometry of finite graphs and classification of subfactors”, *University of Tokyo Seminary Notes 45*, (Notes recorded by Y. Kawahigashi), 1991.
- [32] A. Ocneanu, *An invariant coupling between 3-manifolds and subfactors, with connections to topological and conformal quantum field theory*, preprint 1991.
- [33] A. Ocneanu, *Operator algebras, 3-manifolds and quantum field theory*, OHP sheets for the Istanbul talk, July, 1991.
- [34] A. Ocneanu, *Lectures at Collège de France*, Fall 1991.
- [35] A. Ocneanu, *Seminar talk at University of California, Berkeley*, June 1993.
- [36] A. Ocneanu, *Chirality for operator algebras*, in “Subfactors” (ed. H. Araki, et al.), *World Scientific* (1994), 39–63.
- [37] A. Ocneanu, *Paths on Coxeter diagrams: From Platonic solids and singularities to minimal models and subfactors*, in preparation.
- [38] S. Popa, *Correspondences*, preprint, 1986.
- [39] N. Yu. Reshetikhin & V. G. Turaev, *Invariants of 3-manifolds via link polynomials and quantum groups*, *Invent. Math.* **103** (1991), 547–597.
- [40] N. Sato, *Two subfactors arising from a non-degenerate commuting square — An answer to a question raised by V. F. R. Jones—*, to appear in *Pac. J. Math.*
- [41] N. Sato, *Two subfactors arising from a non-degenerate commuting square — Tensor categories and TQFT's—*, to appear in *Internat. J. Math.*
- [42] V. G. Turaev, *Topology of shadows*, preprint, 1991.
- [43] V. G. Turaev & O. Y. Viro, *State sum invariants of 3-manifolds and quantum 6j-symbols*, *Topology*, **31** (1992), 865–902.

- [44] V. G. Turaev & H. Wenzl, *Semisimple and modular categories from link invariants*, preprint 1996.
- [45] E. Verlinde, *Fusion rules and modular transformation in 2D conformal field theory*, Nucl. Phys. **B300** (1988), 360–376.
- [46] M. Walton, *Fusion rules of Wess–Zumino–Witten models*, Nucl. Phys. **B340** (1990), 777–789.
- [47] H. Wenzl, *Hecke algebras of type A and subfactors*, Invent. Math. **92** (1988), 345–383.
- [48] E. Witten, *Topological quantum field theory*, Comm. Math. Phys. **117** (1988), 353–386.
- [49] E. Witten, *Gauge theories and integrable lattice models*, Nucl. Phys. B **322** (1989), 629–697.
- [50] F. Xu, *Orbifold construction in subfactors*, Comm. Math. Phys. **166** (1994), 237–254.
- [51] S. Yamagami, *Group symmetries in tensor categories*, preprint 1995.