

Instanton–Like Transitions at High Energies in (1+1) Dimensional Scalar Models

D. T. Son

*Institute for Nuclear Research of the Russian Academy of Sciences,
60th October Anniversary prospect 7a, Moscow 117312*

and

V. A. Rubakov

*Institute for Nuclear Research of the Russian Academy of Sciences,
60th October Anniversary prospect 7a, Moscow 117312*

and

*Department of Physics and Astronomy, Rutgers University,
Piscataway, New Jersey, 08855*

October 1993

Abstract

Instanton-like transitions (“shadow processes”) are considered in (1+1) dimensional models with one scalar field whose potential is a quadratic well with a cliff. The corresponding classical boundary value problem is solved, and the semiclassical transition probabilities are found in a rather wide range of energies and the numbers of initial particles.

1 Introduction

Much effort is being made to understand the high energy behavior of the amplitudes of instanton-like processes. Being suppressed at zero energy by the factor e^{-S_0} , where S_0 is the action of the instanton, these amplitudes exhibit the exponential growth with energy, and, in the leading order of the perturbation theory around the instanton, cross the unitarity bound, typically at the sphaleron mass scale [1]. This observation has led to an exciting speculation that the electroweak baryon-number violating processes can become observable in the TeV energy region [1, 2] (for reviews see refs.[3, 4]).

There are strong arguments implying that the behavior of the instanton-like cross section is exponential,

$$\sigma = \exp \left[-\frac{1}{g^2} F \left(\frac{E}{E_0} \right) \right], \quad (1)$$

where the energy scale E_0 is of the order of the sphaleron mass in the electroweak theory and many other models; the function F is the central object of current studies. Until now, only low energy asymptotics of $F(E/E_0)$ is understood, and a few terms of the corresponding series have been explicitly calculated within the perturbation theory around the instanton [5, 6, 7, 8, 9]. The peculiar form of the cross section suggests that even at energies comparable to the sphaleron mass, where the function F cannot be found by the perturbation theory around the instanton, there might exist a semiclassical-type procedure for calculating the amplitudes. The key problem for such a procedure is the non-semiclassical nature of the two initial hard particles [10].

Recently, several approaches that may allow to overcome this problem have been proposed [11, 12, 13, 14, 15]. One of them [11, 12] is as follows. Instead of considering two-particle scattering, one examines the maximum probability of transitions among all initial states with given energy E and number of initial particles $n = \nu/g^2$, where ν is fixed in the limit $g^2 \rightarrow 0$. In this regime, the total probability indeed has the exponential form (1), where the function F now depends on ν . At finite ν , there exists an entirely semiclassical procedure for calculating the function $F(E/E_0, \nu)$ which, in its final version, is reduced to a well-defined classical boundary value problem [16]. Though not a priori justified, a rather natural assumption is that the limit $\nu \rightarrow 0$ of the function $F(E/E_0, \nu)$ is smooth and its limiting value $F(E/E_0, \nu \rightarrow 0)$ gives at least the upper bound for, and may even coincide with the two-particle function $F(E/E_0)$. The latter conjecture has found substantial support from high-

order perturbative calculations around the instanton [17].

The prescription for the evaluation of the function $F(E/E_0, \nu)$ is as follows (see ref.[16] for details). One searches for a solution to the field equations,

$$\frac{\delta S}{\delta \phi} = 0, \quad (2)$$

on the contour ABCD in the complex time plane which is shown in fig.1, with the following boundary conditions,

$$\begin{aligned} \phi(\mathbf{k}) &= \frac{1}{\sqrt{2\omega_{\mathbf{k}}}}(f_{\mathbf{k}}e^{-i\omega_{\mathbf{k}}t'} + e^{\theta}f_{-\mathbf{k}}^*e^{i\omega_{\mathbf{k}}t'}) \quad \text{when } t' \rightarrow -\infty, \\ \phi(\mathbf{k}) &= \frac{1}{\sqrt{2\omega_{\mathbf{k}}}}(b_{\mathbf{k}}e^{-i\omega_{\mathbf{k}}t} + b_{-\mathbf{k}}^*e^{i\omega_{\mathbf{k}}t}) \quad \text{when } t \rightarrow +\infty, \end{aligned} \quad (3)$$

where T and θ are two free parameters of the field configuration which are related to the energy and the number of initial particles, $t' = t - iT/2$ is the real parameter on the part AB of the contour, and $f_{\mathbf{k}}$ and $b_{\mathbf{k}}$ are arbitrary functions of the spatial momentum \mathbf{k} . In other words, the boundary conditions (3) require that the ratio between the negative- and positive-frequency parts of the asymptotics of the field ϕ is equal to $e^{-\theta}$ in the initial state, and 1 in the final state. The solution to this boundary value problem is complex on the contour of fig.1 (except for $\theta = 0$), but is real on the part CD . It describes the most probable ‘‘microcanonical’’ process among all initial states with energy

$$E = \int d\mathbf{k}\omega_{\mathbf{k}}e^{\theta}f_{\mathbf{k}}^*f_{\mathbf{k}} = \int d\mathbf{k}\omega_{\mathbf{k}}b_{\mathbf{k}}^*b_{\mathbf{k}}$$

and number of particles

$$n = \int d\mathbf{k}e^{\theta}f_{\mathbf{k}}^*f_{\mathbf{k}}.$$

The classical action of the field evaluated along the contour of fig.1, which we will denote by iS (so that S is real and positive for purely Euclidean fields, such as an instanton), satisfies the following relations,

$$2\frac{\partial S}{\partial T} = E, \quad 2\frac{\partial S}{\partial \theta} = n, \quad (4)$$

and the function F is merely the Legendre transform of the double action,

$$\frac{1}{g^2}F(E, n) = 2S - ET - n\theta. \quad (5)$$

Obviously, it satisfies the following relations,

$$\frac{\partial(F/g^2)}{\partial E} = -T, \quad \frac{\partial(F/g^2)}{\partial n} = -\theta. \quad (6)$$

It is likely that the above boundary value problem, because of its complexity, can be solved only by numerical methods, except for the region of low energies, $E \ll E_0$, where F can be found by the perturbation theory around the instanton. However, for the qualitative understanding of the structure of the solution as well as the behavior of the function $F(E/E_0, \nu)$, it is desirable to invent a simple model where the solution and the function F can be found analytically, at least in some non-trivial range of E and n , by techniques different from the usual perturbative expansion around a single instanton.

In this paper we present such a model. We consider a (1+1)-dimensional theory of one scalar field, whose potential has a local minimum at $\phi = 0$, but is unbounded from below. The decay of the false vacuum $\phi = 0$ is described by a bounce configuration [18], which shares many properties of instantons in gauge theories. Making use of this bounce solution, one can consider a “shadow process” [19, 20], i.e. scattering of particles through the formation of a bubble. The shadow process is a direct analog of instanton-induced scattering and it can be treated by the same methods as those used in gauge theories. Though not precisely defined at high energies, the “shadow process” is a good choice for testing the semiclassical technique proposed in ref.[16].

In the model that we will study in this paper, there exists an additional large parameter besides the inverse coupling constant. When this parameter tends to infinity, the potential has the form of a quadratic well with a cliff. In this limit, the boundary value problem is solvable in a rather wide range of E/E_{sph} and ν , and the solution is a non-trivial generalization of the dilute instanton gas. The specific models to be considered in this paper are described by the exponential interaction, $\exp(\lambda\phi)$, and power-like one, ϕ^N , where λ and N are large.

For the two models, the results are qualitatively the same. The periodic instanton, which is the solution to the boundary value problem at $\theta = 0$, can be found in the whole range of energies where it exists, i.e., $0 < E < E_{sph}$. For ν of order 1 the function F can be found for all energies smaller than some critical value $E_{crit}(\nu)$ where the exponential suppression is reduced by a factor of order $\lambda^{-1} \ll 1$ (i.e., at the critical energy $F \sim S_0/\lambda$); the smaller the number of initial particles, the larger the critical energy. For even smaller ν , namely, $\nu \sim \lambda^{-1}$, the approximations made in this paper fail at relatively low energies, where the exponential suppression is reduced

by a factor of order one only. The limit $\nu \rightarrow 0$ is smooth and in the exponential model the function $F(E/E_0)$ coincides with the naively extrapolated one-instanton result, that shows that all higher terms of the perturbative expansion around the instanton vanish. In the power model, the result does not coincide with the one-instanton formula and corresponds to summing up the whole perturbation series, where each term is calculated to the leading order in $1/N$.

The fact that the function $F(E/E_0, \nu)$ can be calculated beyond the perturbation theory is a remarkable feature of our model. Unfortunately, our results for the most interesting case $\nu \rightarrow 0$ are rather limited (we can only trust the reduction of the exponent by a factor $2/3$ and $e^{-1/2}$ in the exponential model and power model, respectively), so they do not tell much on whether the two-particle instanton-like scattering is strong or not at high energies.

One question that can be addressed quantitatively in these models is whether multi-instanton processes become important at those energies when one-instanton amplitudes are still exponentially small. This conjecture [21, 22], that has led to a hypothesis of premature unitarization, is discussed in this paper within the exponential model. For processes with relatively large number of initial particles, which we can safely treat until the exponential suppression is strongly reduced (i.e. until $E = E_{crit}(\nu)$), we find that multi-instanton contributions are more suppressed than single-instanton ones at all energies up to E_{crit} . We think this is a strong argument against the premature unitarization hypothesis.

The paper is organized as follows. Sects. 2 – 5 are devoted to the exponential model. In Sect.2 we describe the exponential model and find the analogs of the sphaleron and the instanton. Sect.3 is the central part of the paper and contains the construction of what we call the “improved dilute instanton gas approximation”. The solution to the boundary value problem is found, and the function F is calculated for the two cases $\nu \sim 1$ and $\nu \sim 1/\lambda$. The periodic instanton solution and multi-instanton contributions are also discussed. In Sect.4 we try to go beyond the improved dilute instanton gas and describe the periodic instanton up to E_{sph} ; unfortunately, we are unable to obtain essentially new information on the processes with small number of initial particles at high energies beyond the improved dilute gas. Sect.5 is devoted to a related problem, namely, induced vacuum decay, which can be also considered as a classical boundary value problem. The exponential suppression of the vacuum decay is not reduced when the number of initial particles is small, up to the energies where our approximation breaks down. The model with ϕ^N interaction with large

N , where our approach requires some modifications, is considered in Sect.6. Sect.7 contains concluding remarks.

2 The model

2.1 Shadow process

The model to be considered in this paper, except for Sect.6, is a (1+1) dimensional theory containing one scalar field ϕ , with the lagrangian

$$L = \frac{1}{2}(\partial_\mu\phi)^2 - V(\phi).$$

The potential $V(\phi)$ has a mass term and an exponential interaction term,

$$V(\phi) = \frac{m^2}{2}\phi^2 - \frac{m^2v^2}{2} \exp\left[2\lambda\left(\frac{\phi}{v} - 1\right)\right]. \quad (7)$$

Note that the interaction term has negative sign, so the potential is unbounded from below at large positive ϕ . The theory contains two massless parameters, v and λ . The parameter $1/v$ is the coupling constant that governs the perturbation theory. The probabilities of semiclassical processes we are interested in are exponential in v : in general, expressions like eq.(1) will have the form

$$\sigma = \exp\left[-F\left(v^2; \frac{E}{E_0}, \nu; \lambda\right)\right] = \exp\left[-v^2 f\left(\frac{E}{E_0}, \nu; \lambda\right)\right],$$

(i.e., $\ln\sigma \propto -v^2$ at fixed E/E_0 and ν), where $E_0 \propto v^2$ and the number of initial particles is $n = v^2\nu$. In this paper we concentrate on the exponent F and make no attempts to estimate the pre-exponential factors. For the semiclassical expansion to be consistent, we take $\lambda \ll v$. On the other hand, λ itself needs not be small, and we assume throughout this paper that $\lambda \gg 1$. So, we take

$$v \gg \lambda \gg 1.$$

The behavior of the potential is shown in fig.2. Due to the large value of the parameter λ , the potential has the form of a quadratic well with a cliff. At $\phi = v$, the mass term and the interaction term in the potential cancel each other, so $V(v) = 0$. When ϕ decreases, the exponential term rapidly decays and becomes negligible as compared to the mass term, so for $(v - \phi) \gg v/\lambda$ the potential reduces to its quadratic

part, $m^2\phi^2/2$. When ϕ is larger than v , the interaction term, however, becomes dominant, and the potential falls down rapidly. The potential has a local minimum, which at large λ is placed almost exactly at $\phi = 0$. This minimum corresponds to the false vacuum, whereas the true vacuum is $\phi = +\infty$.

The decay of the false vacuum is a non-perturbative phenomenon with the exponentially small amplitude, which is typical for quantum tunneling processes. This decay can be described semiclassically by the bounce configuration, which is a solution to the Euclidean field equation with finite action, that obeys the boundary condition $\phi(\infty) = 0$. The action of the bounce determines the exponential suppression factor for the false vacuum decay,

$$\Gamma \sim e^{-S_0}, \quad S_0 \sim v^2.$$

Since the bounce is the analog of the instanton, it is suggested in refs.[19, 20] that theories with unstable vacua may be considered as models for studying instanton-like scattering. Instead of transitions from one vacuum to another induced by particle collisions, one studies “shadow processes”, where both initial and final states refer to the false vacuum $\phi = 0$ but intermediate states contain a bubble of large positive field ($\phi > v$ in our case). The simplest shadow process is one described by the bounce itself, which corresponds to the transition at zero energy from the false vacuum ($\phi = 0$ at $\tau = +\infty$) through some bubble-type configuration ($\phi(x)$ at $\tau = 0$) back to the false vacuum ($\phi(x, -\infty) = 0$). We note in passing that the very definition of the shadow processes is of semiclassical nature, and the notion of the shadow processes may become ambiguous in high energy scattering.

Along with the bounce, there exists another configuration relevant to shadow processes, namely, the critical bubble, which is a static and unstable solution to the field equation with finite energy. The physical significance of the critical bubble is that it is the minimum static energy configuration on the border, in the configuration space, between the false and true vacua: being slightly perturbed, the critical bubble either evolves (in real time) into an expanding domain of a new phase that eventually fills up the whole space, or shrinks down to $\phi = 0$. The critical bubble is the analog of the sphaleron in gauge theories (in particular, its free energy determines the rate of the false vacuum decay at high enough temperatures). In many theories (but not in our model, see below), the sphaleron mass determines the energy scale where the instanton-like amplitudes naively become large. For convenience, we will use the gauge theory terminology and call the critical bubble and bounce by the sphaleron and instanton, respectively.

2.2 Sphaleron

The sphaleron is the static solution to the field equation,

$$\partial_x^2 \phi = m^2 \phi - \lambda m^2 v \exp \left[2\lambda \left(\frac{\phi}{v} - 1 \right) \right]. \quad (8)$$

This equation has the same form as the equation of motion for a classical particle in the upside-down potential $-V(\phi)$ with x playing the role of time. The sphaleron corresponds to the motion of the particle from $\phi = 0$ at $x = -\infty$ to $\phi = v$ at $x = 0$ where it recoils from the wall and goes back to $\phi = 0$ at $x = \infty$. At large λ , when the wall is steep, the recoil occurs in a small interval of “time”, and most of the “time” the particle moves in the region where the nonlinear term in eq.(8) can be neglected and the potential is quadratic. So, outside the nonlinearity region, the sphaleron configuration is

$$\phi = e^{-m|x|}. \quad (9)$$

One can check that the region of nonlinearity, where the exponential term in eq.(8) is comparable with the other terms, is of order

$$x \sim \frac{1}{\lambda m},$$

which is much smaller than m^{-1} . The energy of the sphaleron,

$$E = \int dx \left[\frac{1}{2} (\partial_x \phi)^2 + V(\phi) \right],$$

is then dominated by the contribution from the region where the field is linear, $x \gg (\lambda m)^{-1}$; the contribution of the region of nonlinearity is suppressed by a factor $1/\lambda$. A straightforward calculation gives

$$E_{sph} = mv^2 \quad (10)$$

in the leading order in $1/\lambda$.

The fact that the sphaleron mass comes mostly from the linear region is a specific feature of our model, which allows, in particular, to calculate the momentum distribution and the total number of particles emitted by a sphaleron decaying back into the false vacuum. The field of the decaying sphaleron is linear,

$$\phi(x, t) = \int \frac{dk}{\sqrt{2\pi} \sqrt{2\omega_k}} (b_k e^{-i\omega_k t + ikx} + b_{-k}^* e^{i\omega_k t - ikx}),$$

and, if the sphaleron begins to decay at $t = 0$, obeys the initial conditions $\phi(x, t = 0) = \phi_{sph}(x)$, $\dot{\phi}(x, t = 0) = 0$. One finds from eq.(9)

$$b_k = \frac{1}{\sqrt{\pi}} \frac{mv}{\omega_k^{3/2}}.$$

The total number of particles emitted by the decaying sphaleron is

$$n_{sph} = \int dk b_k^* b_k = \frac{2}{\pi} v^2. \quad (11)$$

As expected, the number of particles is of order v^2 .

2.3 Instanton

The instanton is an $O(2)$ symmetric solution to the Euclidean field equation,

$$\partial_\mu^2 \phi = \frac{\partial^2 \phi}{\partial r^2} + \frac{1}{r} \frac{\partial \phi}{\partial r} = m^2 \phi - \lambda m^2 v \exp \left[2\lambda \left(\frac{\phi}{v} - 1 \right) \right], \quad (12)$$

$$x^\mu = (\tau, x), \quad r = \sqrt{\tau^2 + x^2}.$$

The appropriate mechanical analog is now a particle moving in the potential $-V(\phi)$ with the friction coefficient inversely proportional to “time” r . The motion of the particle begins at some $\phi(0) > v$ with zero velocity and ends at $\phi = 0$ at infinitely large “time”. The initial potential energy is lost at $r = \infty$ because of friction.

We are unable to solve eq.(12) analytically. Nevertheless, by making the following conjecture on the structure of the field configuration we are able to obtain the solution to the leading order in $1/\lambda$. Namely, in analogy with the sphaleron, we assume that the size of the region of the Euclidean space–time where the field is nonlinear, r_0 , is much smaller than the inverse mass, $r_0 \ll m^{-1}$. Outside this nonlinear “core” the field is free, i.e. the nonlinear term in eq.(12) is negligible as compared to the kinetic and mass terms. This outer region $r \gg r_0$ can be in its turn divided into two regions: $r_0 \ll r \ll m^{-1}$ where the mass is unimportant and the field is both free and massless, and $r \gtrsim m^{-1}$ where the field obeys the ordinary massive Klein–Gordon equation. Shortly speaking, we assume that the field shows different behavior in the following three regions,

- (1) $r \lesssim r_0$, where $\partial_\mu^2 \phi = -\lambda m^2 v \exp \left[2\lambda \left(\frac{\phi}{v} - 1 \right) \right]$,

- (2) $r_0 \ll r \ll m^{-1}$, where $\partial_\mu^2 \phi = 0$, and

(3) $r \gtrsim m^{-1}$, where $\partial_\mu^2 \phi = m^2 \phi$.

In the region 2 we will match the two solutions found in the regions 1 and 3 thus obtaining the complete field configuration. We will justify our assumptions a posteriori, and now we construct the solution explicitly.

First, consider the regions 1 and 2, where $r \ll m^{-1}$ and the mass term can be neglected. Since there this no mass scale left over, the equation is scale invariant. In fact, it is the Liouville equation, which in terms of the new variable

$$\chi = -\frac{\lambda}{v}\phi \tag{13}$$

has the form

$$\partial_\mu^2 \chi = \frac{4}{a^2} e^{-2\chi}, \tag{14}$$

where

$$a = \frac{2e^\lambda}{\lambda m}. \tag{15}$$

At the moment we have to consider the $O(2)$ symmetric solution to the Liouville equation,

$$\chi(r) = \ln \left(c + \frac{r^2}{ca^2} \right), \tag{16}$$

where c is an arbitrary constant. Thus in the regions 1 and 2 the field configuration is

$$\phi(r) = -\frac{v}{\lambda} \ln \left(c + \frac{r^2}{ca^2} \right), \tag{17}$$

where c is yet to be determined. Notice that at $r \gg ca$, where $\phi(r) \sim \ln r$, the field is free and massless. This means that the radius r_0 separating the regions 1 and 2 is

$$r_0 = ca. \tag{18}$$

In the regions 2 and 3, i.e. at $r \gg r_0$, the field is linear, $(\partial^2 - m^2)\phi = 0$, so the configuration is given by the $O(2)$ symmetric solution to the Klein–Gordon equation,

$$\phi(r) = \alpha K_0(mr), \tag{19}$$

where α is some constant and K_0 is the modified Bessel function. If $r_0 \ll m^{-1}$, we can match the two solutions, eqs.(17) and (19), in the region 2. We write

$$-\frac{v}{\lambda} \ln \left(\frac{r^2}{ca^2} \right) = -\alpha \left[\ln \frac{mr}{2} + \gamma \right],$$

where we made use that at small (mr), $K_0(mr) = -\ln(mr/2) - \gamma$, where $\gamma = 0.577\dots$ is the Euler constant. Taking into account eq.(15), we find the parameters α and c ,

$$\alpha = \frac{2v}{\lambda},$$

$$c = \lambda^2 e^{-2(\lambda+\gamma)}. \quad (20)$$

So, in the regions 1 and 2, the solution is given by eq.(17), and in the regions 2 and 3 it is determined by eq.(19), with the values of α and c fixed by eq.(20).

It is now straightforward to justify our basic assumption that $r_0 \ll m^{-1}$. We find from eq.(18)

$$r_0 \sim \lambda e^{-\lambda} \frac{1}{m} \quad (21)$$

which is smaller than m^{-1} by an exponential factor $e^{-\lambda}$. So our basic assumptions about the structure of the field are indeed valid with exponential accuracy.

Thus, we have found the instanton by solving separately the field equation in the regions of small and large r and matching the two solutions at intermediate r . The assumptions made on the structure of the instanton solution are self-consistent at large λ . The field configuration consists of an exponentially small core, where ϕ is nonlinear, and a large tail that extends from $r_0 \sim e^{-\lambda} m^{-1}$ to m^{-1} . In fact, it is straightforward to see that in the whole Euclidean space-time our solution satisfies the field equation with the accuracy $e^{-\lambda}$.

Note that the value of the field ϕ at the center of the instanton is finite in the limit $\lambda \rightarrow \infty$,

$$\phi(0) = -\frac{v}{\lambda} \ln c = 2v. \quad (22)$$

The instanton action is dominated by the contribution of the kinetic term in the lagrangian, and comes mostly from the region 2,

$$S_0 = 2\pi \int r dr \frac{1}{2} (\partial_r \phi)^2 = \frac{4\pi v^2}{\lambda} \left(1 - \frac{\ln \lambda}{\lambda} + O(\lambda^{-1}) \right). \quad (23)$$

Recall that we take $v \gg \lambda \gg 1$, so the vacuum decay probability is exponentially small.

2.4 Leading order instanton approximation

In the leading order of the perturbation theory around the instanton, the two-particle cross section at energy E can be found by the technique of ref.[6]. One writes for the

exponent of eq.(1),

$$F(E) = 2S_0 - ET - \int dk R^*(k)R(k)e^{-\omega_k T}, \quad (24)$$

where $R(k)$ is the Fourier component of the asymptotics of the instanton field,

$$\phi(x, \tau) = \int \frac{dk}{\sqrt{2\pi}\sqrt{2\omega_k}} R(k)e^{-\omega_k \tau + ikx}, \quad \tau \rightarrow \infty, \quad (25)$$

and T is related to the energy by the following condition,

$$E = \int dk \omega_k R^*(k)R(k)e^{-\omega_k T}. \quad (26)$$

The Fourier components in eq.(24) can be calculated from eqs.(19) and (20),

$$R(k) = \sqrt{\frac{\pi}{\omega_k}} \frac{2v}{\lambda}.$$

The integrals in eqs.(24) and (26) are then straightforward to evaluate, and for $E \gg E_{sph}$ one obtains the leading order instanton approximation result,

$$F(E) = 2S_0 \left(1 - \frac{1}{\lambda} \ln \frac{E}{E_{sph}} + O\left(\frac{\ln \lambda}{\lambda}\right) \right). \quad (27)$$

Naively, eq.(27) implies that the cross section becomes large at

$$E \sim E_0 = e^\lambda E_{sph}. \quad (28)$$

This scale is much higher than E_{sph} , which is a peculiar feature of our model.

3 Improved dilute instanton gas approximation

3.1 Difficulties of the ordinary dilute instanton gas

At low energies, the classical boundary value problem, eqs.(2) and (3), can be solved by making use of the dilute instanton gas approximation [16, 23]. Typically, the dilute instanton gas approximation breaks down at $E \sim E_{sph}$; this is the case, for example, in the (1+1)-dimensional Abelian Higgs model [16] and the electroweak theory [23]. Let us see, however, that our model is peculiar in this respect: the ordinary dilute instanton gas approximation breaks down at energies much smaller than E_{sph} .

Let us consider, for example, the boundary value problem at $\theta = 0$. In that case the solution is periodic in Euclidean time with the period T [23]. The basic

assumption of the dilute instanton gas approximation is that the Euclidean solution may be represented by the sum of widely separated instantons, which, to the leading order, do not distort each other's interiors. Thus, the periodic instanton field is approximated by the sum

$$\phi(x) = \sum_l \phi_{inst}(x - x_l), \quad (29)$$

where, by periodicity, $x_l = (lT, 0)$ are the positions of the instantons in the chain (there are no anti-instantons in our model).

At first sight, the dilute instanton gas would be a good approximation if T is much larger than the core size r_0 given by eq.(21). However, we will see immediately that this condition is not sufficient for a two-fold reason. First, the field in the center of the instanton, eq.(22), is strong enough, so that the exponential interaction is operative. Therefore, even relatively small distortion of the field due to other instantons may have strong effect on the instanton interior. Second, the field of each instanton falls off rather slowly at $|x - x_l| \ll m^{-1}$, so that neighboring instantons may produce a collective effect on a given instanton.

To establish the region of validity of the dilute gas approximation, let us consider the interior region of an instanton sitting at $x = 0$ and write explicitly its contribution to the sum in eq.(29),

$$\phi(x) = \phi_{inst}(x) + \tilde{\phi}(x), \quad (30)$$

where

$$\tilde{\phi}(x) = \sum_{l \neq 0} \phi_{inst}(x - x_l)$$

is the distortion of the field due to other instantons. For the dilute instanton gas to work, the distortion $\tilde{\phi}$ should not change the field equation considerably. In particular, at $x = 0$ one should have

$$\exp \left[2\lambda \left(\frac{\phi_{inst} + \tilde{\phi}}{v} - 1 \right) \right] \approx \exp \left[2\lambda \left(\frac{\phi_{inst}}{v} - 1 \right) \right],$$

which means

$$\tilde{\phi}(x = 0) \ll \frac{v}{\lambda}. \quad (31)$$

Recalling that, due to eqs.(19) and (20),

$$\phi(x = 0) = \sum_{l \neq 0} \frac{2v}{\lambda} K_0(m|l|T),$$

one finds that eq.(31) is valid only when

$$T \gg m^{-1}.$$

Obviously, this condition is much stronger than the naive estimate $T \gg r_0$. We will see in Sect 3.2 that the corresponding condition on energy is

$$E \ll \frac{E_{sph}}{\lambda^2},$$

so that the ordinary dilute instanton gas approximation breaks down at energies much lower than the sphaleron mass.

3.2 Improved dilute gas

The ordinary dilute instanton gas approximation breaks down long before the instanton cores begin to overlap. One may expect, however, that the picture of well separated instanton-like objects is valid in a wider region of energies, but each instanton is strongly affected by the collective field of the others. When the instanton core is much smaller than the separation between the instantons, this collective field is constant in the instanton interior, so the distorted instanton is still $O(2)$ symmetric. Furthermore, outside the instanton cores, the field is still linear, so that we are still able to make use of the assumptions described in Sect.2.3.

To obtain the solution to the boundary value problem, eqs.(2) and (3), we begin with the region outside the cores. Let the distorted instantons be located at $x = 0$ and $\tau = (\pm T_1 \pm lT, 0)$, $l = 0, 1, 2 \dots$, where T_1 is yet unknown parameter (see fig.3). At $\theta \neq 0$, only two of these instantons (with $l = 0$) have unit strength, while others are fake instantons with strength $\exp(-|l|\theta)$ (cf. ref.[16]). Recall that we are interested in the field on the contour ACD in the complex time plane shown in fig.3, so we are able to ignore interiors of all instantons except for one sitting at $\tau = T_1$.

Thus, the field outside the core is

$$\phi(x, \tau) = \alpha \sum_{l=-\infty}^{l=\infty} e^{-|l|\theta} \left[K_0 \left(m \sqrt{(\tau - T_1 - lT)^2 + x^2} \right) + K_0 \left(m \sqrt{(\tau + T_1 - lT)^2 + x^2} \right) \right], \quad (32)$$

where α is yet unknown constant that may be different from eq.(20). The field (32) automatically satisfies the boundary conditions, eq.(3). The Fourier components of the asymptotics of the field in the initial and final states are

$$f_k = f_k^* = \alpha \sqrt{\frac{\pi}{\omega_k}} \frac{2e^{-\omega_k T/2 - \theta} \cosh(\omega_k T_1)}{1 - e^{-\omega_k T - \theta}},$$

$$b_k = b_k^* = \alpha \sqrt{\frac{\pi}{\omega_k} \frac{e^{-\omega_k T_1} + e^{-\omega_k(T-T_1)-\theta}}{1 - e^{-\omega_k T - \theta}}}. \quad (33)$$

The energy E and the number of initial particles n are related to the parameters T , T_1 and θ as follows,

$$\begin{aligned} E &= \int dk \omega_k e^\theta f_k^* f_k = \pi \alpha^2 \int dk \frac{e^{-\omega T - \theta} (2 \cosh \omega_k T_1)^2}{(1 - e^{-\omega_k T - \theta})^2} \\ &= \int dk \omega_k b_k^* b_k = \pi \alpha^2 \int dk \frac{(e^{-\omega_k T_1} + e^{-\omega_k(T-T_1)-\theta})^2}{(1 - e^{-\omega_k T - \theta})^2}, \end{aligned} \quad (34)$$

$$n = \int dk e^{-\theta} f_k^* f_k = \pi \alpha^2 \int \frac{dk}{\omega_k} \frac{e^{-\omega T - \theta} (2 \cosh \omega_k T_1)^2}{(1 - e^{-\omega_k T - \theta})^2}. \quad (35)$$

In fact, these three relations are consequences of eq.(4) and the condition of equilibrium of forces acting on the instanton sitting at $\tau = T_1$. Eqs.(34) and (35) enable one to express T , T_1 and θ through the energy and number of initial particles, once the value of α is known. Alternatively, one may consider the boundary value problem at given values of T and θ , and relate these parameters to E and n at the very last step. In that case eq.(34) should be used to express T_1 in terms of T and θ .

To find the configuration inside the core, let us first consider the region close to the instanton located at $(T_1, 0)$, but still outside the core. In this region, all terms in the sum (32) are constant with the accuracy r_0/T , except for one that refers to the instanton $(T_1, 0)$. Eq.(32) then reduces to a form that is $O(2)$ symmetric with respect to the point $(T_1, 0)$,

$$\phi(x, \tau) = \alpha \left[K_0 \left(m \sqrt{(\tau - T_1)^2 + x^2} \right) + f \right], \quad (36)$$

where f is a constant that depends on T and θ ,

$$f = 2 \sum_{l=1}^{\infty} e^{-l\theta} K(nmT) + \sum_{l=-\infty}^{\infty} e^{-|l|\theta} K_0(m|lT - 2T_1|). \quad (37)$$

A convenient representation for this constant is

$$f = \int \frac{dk}{2\omega_k} \frac{2e^{-\omega_k T - \theta} + e^{-\omega_k T - \theta + 2\omega_k T_1} + e^{-2\omega_k T_1}}{1 - e^{-\omega_k T - \theta}}. \quad (38)$$

Eq.(36) can be considered as the boundary condition for the Liouville equation that determines the field inside the core. Since this boundary condition is $O(2)$

symmetric, the field inside the core is still given by the $O(2)$ symmetric solution of the Liouville equation (14),

$$\phi(r) = -\frac{v}{\lambda} \ln \left(c + \frac{(\tau - T_1)^2 + x^2}{ca^2} \right), \quad (39)$$

where a is given by eq.(15) and c is some constant that can differ from that of the single instanton, eq.(20). If the core size, which is $r_0 = ca$, is much smaller than both T_1 and $T/2 - T_1$, one can match eqs.(36) and (39) in the region $r_0^2 \ll (\tau - T_1)^2 + x^2 \ll T_1^2$, $(T/2 - T_1)^2$ where ϕ is free and massless. In this way we obtain the values of the parameters c and α ,

$$c = \lambda^2 e^{-2(\lambda + \gamma - f)}, \quad (40)$$

$$\alpha = \frac{2v}{\lambda}. \quad (41)$$

Eqs.(36) – (41) determine the solution to the boundary value problem. For given T and θ , the value of T_1 is determined by eq.(34). The value of f is then given by eq.(38), so that all parameters become known. Outside the cores, the field is exactly the same as in the ordinary dilute instanton gas approximation: the configuration (32) with α given by eq.(41) is precisely the sum of undistorted instanton fields. On the other hand, the size of the core and the field inside the core are modified. Namely, the core size is

$$r_0 = ca = 2\lambda \exp(-\lambda + 2f - 2\gamma) \frac{1}{m}, \quad (42)$$

while the field configuration inside the core is the $O(2)$ symmetric solution of the Liouville equation with the parameter c given by eq.(40).

We will call this procedure the “improved dilute instanton gas approximation”. This approximation is valid provided the core size, eq.(42), is much smaller than T_1 and $T/2 - T_1$,

$$\lambda \exp(-\lambda + 2f) \frac{1}{m} \ll T, (T/2 - T_1).$$

The explicit formulas will be given in Sects. 3.3 and 3.4 where we will also discuss the actual region of validity of the improved dilute instanton gas approximation. We note in passing that at $T \gg m^{-1}$, the improved and ordinary dilute gas approximations coincide. Indeed, in that case all terms on the right hand side of eq.(37) are much smaller than 1, so that $f \ll 1$. The value of the parameter c , eq.(40), is then the same as for an isolated instanton, eq.(20), and the field in the instanton interior is precisely the field of an isolated instanton.

When θ is fixed, and T decreases, the value of f increases. Since f enters the expression for r_0 , eq.(42), in the exponent, the core size increases rapidly when T falls below m^{-1} . At some $T = T_{crit}$ which depends on θ , the core size becomes comparable to the distance between the instantons and our approximation breaks down. We will see that this happens at energies comparable to, or even much larger than the sphaleron mass, depending on the value of θ .

Now let us evaluate the action for our configuration. Since the core is exponentially small, the action comes entirely from the region where the field is linear, so one has (recall that we choose the convention that the action is real and positive for real Euclidean fields)

$$S = -\frac{i}{2} \int dt dx ((\partial_\mu \phi)^2 - m^2 \phi^2), \quad (43)$$

where the integration over time is performed along the contour of fig.3. This contour can be divided into two parts: $(iT/2 - \infty, iT_1)$, and $(iT_1, +\infty)$. In the first part the field is given by the initial state asymptotics, while in the second part it is given by the final state asymptotics. Substituting these asymptotics, eq.(3), into the integral (43), one obtains

$$S = \frac{1}{4} \int dk (f_k^* f_{-k}^* e^{\omega_k(T-2T_1)+2\theta} - f_k f_{-k} e^{-\omega_k(T-2T_1)}) \\ - \frac{1}{4} \int dk (b_k^* b_{-k}^* e^{-2\omega_k T_1} - b_k b_{-k} e^{2\omega_k T_1}).$$

The explicit form of the Fourier components is given by eq.(33), so we find

$$S = \frac{4\pi v^2}{\lambda^2} \int \frac{dk}{2\omega_k} \frac{1 + e^{-\omega_k T - \theta} + e^{-\omega_k T - \theta + 2\omega_k T_1} + e^{-2\omega_k T_1}}{1 - e^{-\omega_k T - \theta}}.$$

Comparing this expression with eq.(38), we obtain

$$S = \frac{4\pi v^2}{\lambda^2} \left(\int \frac{dk}{2\omega_k} + f \right).$$

The integral in this equation diverges logarithmically in the ultraviolet region. However, we have to cut this integral off at the scale $1/r_0$, since eq.(33) is valid only at momenta much lower than $1/r_0$. So, we have

$$S = \frac{4\pi v^2}{\lambda^2} \left(\ln \frac{1}{mr_0} + f \right).$$

Recalling that the core size r_0 is related to f by eq.(42), we obtain finally

$$S = \frac{4\pi v^2}{\lambda} \left(1 - \frac{f}{\lambda} + O\left(\frac{\ln \lambda}{\lambda}\right) \right) \quad (44)$$

It is straightforward to verify that this action as function of T and θ satisfies eq.(4).

To obtain the explicit formulas for the transition probabilities at a given number of initial particles, we have to consider various limiting cases. Since there exists an extra large parameter λ besides the ‘‘coupling constant’’ v , we distinguish the cases $\nu = n/v^2 \sim 1$ and $\nu \sim 1/\lambda$ where n is the number of the initial particles. We will see in what follows that these cases correspond to $\theta \sim 1/\lambda$ and $\theta \sim 1$, respectively. Let us discuss the two regimes in turn.

3.3 $\theta \sim 1/\lambda$

Let us first consider the case of small θ , $\theta \sim 1/\lambda$. At small θ , the condition of energy conservation, eq.(34), implies that $T_1 \approx T/4$. Let us also assume that $T \sim (\lambda m)^{-1}$; we will see that this regime corresponds to $E \sim E_{sph}$. For these values of T and θ , the number of relevant terms in eq.(37) is of order λ , which is large. In other words, there are many fake instantons that determine the solution on the contour of fig.3. For the actual calculation of f , it is more convenient to make use of the integral representation, eq.(38). At $k \ll \lambda m$, the integrand in eq.(38) can be expanded in the following way,

$$\frac{2e^{-\omega_k T - \theta} + e^{-\omega_k T - \theta + 2\omega_k T_1} + e^{-2\omega_k T_1}}{1 - e^{-\omega_k T - \theta}} = \frac{4}{\omega_k T + \theta} - 1 + O(\lambda^{-1}).$$

So, one has

$$f = \int \frac{dk}{2\omega_k} \frac{4}{\omega_k T + \theta} - \int \frac{dk}{2\omega_k}.$$

The second integral on the right side diverges logarithmically in the ultraviolet, and should be cut-off at $k \sim \lambda m$. We obtain

$$f = \frac{2\pi}{mT} f_1(\theta/mT) - \ln \lambda + O(1), \quad (45)$$

where

$$f_1(\beta) = \frac{2 \operatorname{arccosh} \beta}{\pi \sqrt{\beta^2 - 1}}.$$

Note that by our assumptions, $\theta \sim 1/\lambda$, $mT \sim 1/\lambda$, the first term in eq.(45) is of order λ . Analogously, the energy and the number of initial particles are obtained from eqs.(34) and (35),

$$E = \left(\frac{4\pi}{\lambda m T} \right)^2 f_2(\theta/mT) E_{sph}, \quad n = \left(\frac{4\pi}{\lambda m T} \right)^2 f_3(\theta/mT) n_{sph}, \quad (46)$$

where

$$f_2(\beta) = \frac{2}{\pi} \left(\frac{\beta}{\beta^2 - 1} - \frac{\operatorname{arccosh}\beta}{(\beta^2 - 1)^{3/2}} \right),$$

$$f_3(\beta) = \frac{\pi}{2\beta} (f_1(\beta) - f_2(\beta)),$$

and the energy and the number of particles for the sphaleron are given by eqs.(10) and (11). We see that the regime $\theta \sim 1/\lambda$, $mT \sim 1/\lambda$ occurs when the energy E and the number of particles, n , are of the same order of magnitude as the corresponding quantities for the sphaleron, E_{sph} and n_{sph} . Since $n_{sph} \sim v^2$, we conclude that the regime $\theta \sim 1/\lambda$ corresponds to $\nu = n/v^2 \sim 1$.

The exponent for the total probability is then straightforward to evaluate,

$$F = \frac{8\pi v^2}{\lambda} \left(1 - \frac{4\pi}{\lambda m T} f_1(\theta/mT) \right). \quad (47)$$

The condition for the validity of the improved dilute instanton gas approximation is $r_0 \ll T$. Since $T \sim (\lambda m)^{-1}$, and

$$r_0 \sim \lambda \exp(-\lambda + 2f) \frac{1}{m},$$

the approximation is valid if

$$1 - \frac{4\pi}{\lambda m T} f_1(\theta/mT) \gg \frac{1}{\lambda}. \quad (48)$$

Comparing eqs.(47) and (48) we see that we can trust the dilute gas approximation up until the suppression becomes much weaker than the instanton suppression,

$$F \sim \frac{S_0}{\lambda}.$$

In the particular case $\theta = 0$, the field configuration is the periodic instanton that describes the most probable process at given energy E [23] (the maximization over all possible values of the number of initial particles n can be seen from the relation $\frac{\partial F}{\partial n} = -\theta/v^2 = 0$). Since the functions f_1 , f_2 , f_3 are normalized in such a way that $f_1(0) = f_2(0) = f_3(0) = 1$, we have for the periodic instanton

$$\frac{E}{E_{sph}} = \left(\frac{4\pi}{\lambda m T} \right)^2,$$

and the function $F(E)$ can be found explicitly,

$$F(E) = \frac{8\pi v^2}{\lambda} \left(1 - \left(\frac{E}{E_{sph}} \right)^{1/2} \right). \quad (49)$$

The exponent for the probability, $(-F(E))$ for the periodic instanton is shown in fig.4. It increases from $-2S_0$ at low energies to zero at $E = E_{sph}$. The number of particles for the periodic instanton increases with energy,

$$n = \frac{E}{E_{sph}} n_{sph},$$

so that the average energy per particle remains constant. The core size of an individual instanton rapidly increases with energy,

$$r_0 \sim \frac{1}{\lambda m} \exp \left[-\lambda \left(1 - \left(\frac{E}{E_{sph}} \right)^{\frac{1}{2}} \right) \right].$$

Strictly speaking, there is an energy region close to the sphaleron mass where the improved dilute instanton gas approximation does not work. According to eq.(48), this region is

$$1 - \frac{E}{E_{sph}} \sim \frac{1}{\lambda}.$$

We will discuss this region in detail in Sect.4 and show that the behavior (49) indeed persists up to E_{sph} .

Let us now consider the general case $\theta \neq 0$, still assuming $\theta \sim 1/\lambda$. To find the probability of the transition at fixed energy E and number of initial particles n , which are of the order of E_{sph} and n_{sph} , respectively, one finds T and θ from eq.(46) and then substitutes them into eq.(47). The result is presented in fig.5. For a given $n < n_{sph}$ the function $F(E)$ starts from $E = \pi n m / 2$, where $\theta = 0$ and the configuration is just the periodic instanton, and reaches zero at some E_{crit} determined by the condition

$$1 - \frac{4\pi}{\lambda m T} f_1(\theta/mT) = 0. \quad (50)$$

Very close to E_{crit} , however, the improved dilute instanton gas approximation is not reliable, see eq.(48).

In the whole energy interval, F is a monotonically increasing function of energy. As in the case of the periodic instanton, at the point where the approximation breaks down, the function F is of order S_0/λ . The critical energy at which F becomes small, is a function of the number of initial particles: the smaller the number of initial particles, the larger the critical energy.

At $1/\lambda \ll n/n_{sph} \ll 1$, the critical energy can be calculated analytically. In that case one has $\theta/mT \gg 1$, so that one makes use of the asymptotics of f_1 , f_2 and f_3 at

large values of their argument,

$$\begin{aligned} f_1(\beta) &= \frac{2 \ln \beta}{\pi \beta}, \\ f_2(\beta) &= \frac{2}{\pi \beta}, \\ f_3(\beta) &= \frac{\ln \beta}{\beta^2}. \end{aligned}$$

It is then straightforward to express T and θ through E and n from eq.(46) and then obtain the critical energy at which eq.(50) is satisfied and the instanton suppression is strongly reduced. One finds the following exponential dependence,

$$\frac{E_{crit}(n)}{E_{sph}} \sim \exp\left(\frac{\pi^2 n_{sph}}{4 n}\right).$$

Note that we consider $n/n_{sph} \gg 1/\lambda$, so E_{crit} is still much smaller than the energy scale where the two-particle amplitudes naively become large, eq.(28).

3.4 $\theta \sim 1$

In the case $\theta \sim 1$, the sum in eq.(37) is saturated by a finite number of terms. Let us consider the case $mT \ll 1$, which is, of course, of primary interest. Then one can replace the modified Bessel functions in eq.(37) by their values at small argument, $-\ln(mT) + O(1)$, so, to the logarithmic accuracy, one has

$$f = \frac{1 + 3e^{-\theta}}{1 - e^{-\theta}} \ln \frac{1}{mT}. \quad (51)$$

The action, eq.(44), becomes

$$S = S_0 \left(1 - \frac{1}{\lambda} \frac{1 + 3e^{-\theta}}{1 - e^{-\theta}} \ln \frac{1}{mT}\right).$$

We see that the parameter T enters into the action in the combination $\lambda^{-1} \ln(1/mT)$, so in this case it is natural to consider exponentially small T . Let us introduce a new parameter, instead of T ,

$$\kappa = \frac{1}{\lambda} \ln \frac{1}{mT}, \quad (52)$$

and assume that

$$\kappa \sim 1.$$

These values of T correspond to exponentially large energies: indeed, from the relation

$$E = \frac{\partial S}{\partial T} \sim \frac{v^2}{\lambda^2 T}$$

we find that

$$\frac{E}{E_{sph}} \sim e^{\lambda \kappa}. \quad (53)$$

Analogously, the number of initial particles is

$$n = \frac{16\pi^2}{\lambda} \frac{e^{-\theta}}{(1 - e^{-\theta})^2} \kappa n_{sph}. \quad (54)$$

Since both θ and κ are of order 1, eq.(54) implies that the number of initial particles is small,

$$\frac{n}{n_{sph}} \sim \frac{1}{\lambda}.$$

To calculate the function F , one notices that ET is negligible as compared to S . So one has

$$F = 2S - n\theta = 2S_0 \left[1 - \left(\frac{1 + 3e^{-\theta}}{1 - e^{-\theta}} + \frac{4\theta e^{-\theta}}{(1 - e^{-\theta})^2} \right) \kappa \right], \quad (55)$$

where θ and κ as functions of E and n are determined by eqs.(53) and (54). Explicitly,

$$\theta = \operatorname{arccosh} \left(1 + \frac{8\pi^2}{\lambda^2} \frac{n_{sph}}{n} \ln \frac{E}{E_{sph}} \right),$$

and

$$\kappa = \frac{1}{\lambda} \ln \frac{E}{E_{sph}}.$$

According to eqs.(42) and (51), the size of the individual instanton increases with energy,

$$r_0 \propto \exp \left[-\lambda \left(1 - 2 \frac{1 + 3e^{-\theta}}{1 - e^{-\theta}} \kappa \right) \right],$$

while the separation between the instantons decreases,

$$T \propto \exp(-\lambda \kappa).$$

The validity of the improved dilute instanton gas approximation becomes suddenly lost at the energy E_{crit} when

$$\kappa = \kappa_{crit} = \frac{1 - e^{-\theta}}{3 + 5e^{-\theta}}. \quad (56)$$

It follows from eq.(55) that at the critical energy, the function F is smaller than $2S_0$ only by a factor of order 1, contrary to the case $\theta \sim 1/\lambda$ where the reduction of the function F is of order λ^{-1} . Thus, at small number of initial particles, $n/n_{sph} \sim 1/\lambda$, our approximation breaks down when the probability is still exponentially small, with the exponent of order of, but smaller than, the instanton one.

The above formulas simplify considerably in the most interesting case $n/n_{sph} \rightarrow 0$, which occurs in the limit $\theta \rightarrow \infty$. It is clear from eq.(55) that this limit is smooth, and the exponent for the probability is

$$F(E) = 2S_0 \left(1 - \frac{1}{\lambda} \ln \frac{E}{E_{sph}} \right). \quad (57)$$

Surprisingly enough, eq.(57) coincides with the leading order instanton result, eq.(27).

Eq.(57) is reliable at $E < E_{crit}$ where E_{crit} is determined from eq.(56) to be

$$E_{crit} \sim e^{\lambda/3} E_{sph}. \quad (58)$$

This energy is exponentially large in λ , but still much smaller than the scale $E_0 \sim e^\lambda E_{sph}$ set by the leading order calculation. The exponent of the probability at $E \sim E_{crit}$ is numerically smaller than the instanton action,

$$F_{crit} = \frac{2}{3}(2S_0),$$

but the probability is still suppressed exponentially.

Thus, in the most interesting case of small number of initial particles, the improved dilute instanton gas approximation enables one to go beyond the perturbation theory about the instanton, but not very far beyond.

3.5 Multi–instanton amplitudes

The interest in multi–instanton processes in the context of baryon number violation has been raised by the conjecture [21, 22] that the multi–instanton contributions may become essential at energies where the one–instanton amplitude is still small. This conjecture is based on the observation that since the *many* \rightarrow *many* amplitude becomes large at the sphaleron mass, the transition from an initial few–particle state that goes through a chain of *many* \rightarrow *many* processes (fig.6) in principle may become comparable with the one–instanton one at energies larger than the sphaleron mass. This conjecture, that has lead to the premature unitarization hypothesis, is an object of controversial discussion.

In our model, the function F is reliably calculable at energies above E_{sph} . Furthermore, as discussed in Sect.3.3, the case when n is of order of, but smaller than n_{sph} can be treated up to the energy where F becomes parametrically smaller than S_0 . Thus, our model provides a means to test the relevance of multi-instantons above the sphaleron energy. Let us see that the multi-instanton amplitudes are not essential when the one-instanton one is small, and, moreover, the p -instanton amplitude is exponentially smaller than the $(p-1)$ -instanton one, even at energies larger than the sphaleron mass. This will provide a counterexample to the claim of refs.[21, 22].

Consider p -instanton processes at n of order of, but smaller than n_{sph} . The field configuration now consists of $2p$ instantons located at $\pm T_j$, $j = 1, 2, \dots, p$ and an infinite set of fake small instantons at $\pm T_j \pm lT$ with intensities $e^{-|l|\theta}$ (the case $p = 2$ is shown in fig.7). For $\theta \ll 1$, the distances between the instantons are approximately equal, so

$$T_j \approx \frac{2j-1}{4p}T.$$

The value of the parameter f is now

$$\begin{aligned} f &= 2 \sum_{l=1}^{\infty} e^{-l\theta} K_0(lmT) + \sum_{j=2}^p \sum_{l=-\infty}^{\infty} e^{-|l|\theta} K_0(m|lT + T_j - T_1|) \\ &+ \sum_{j=1}^p \sum_{l=-\infty}^{\infty} e^{-|l|\theta} K_0(m|lT + T_j + T_1|) = p \frac{2\pi}{mT_p} f_1(\theta_p/mT_p) - \ln \lambda + O(1), \end{aligned}$$

where T_p and θ_p may differ from their one-instanton values (it is energy and number of initial particles that are fixed). In complete analogy to Sect.3.3, one finds for the energy and number of initial particles

$$E = p^2 \left(\frac{4\pi}{\lambda m T_p} \right)^2 f_2(\theta_p/mT_p), \quad n = p^2 \left(\frac{4\pi}{\lambda m T_p} \right)^2 f_3(\theta_p/mT_p), \quad (59)$$

while the exponential suppression function is

$$F_p = 2pS_0 \left(1 - p \frac{4\pi}{\lambda m T_p} f_1(\theta_p/mT_p) \right). \quad (60)$$

To calculate the function $F_p(E, n)$ one solves eq.(59) with respect to θ_p and T_p and then substitutes their values into eq.(60). From eq.(59) it is clear that for given E and n , the values of T_p and θ_p are p times larger than their values in the one-instanton case. So, the p -instanton function $F_p(E, n)$ is p times larger than the one-instanton suppression function at the same energy and number of initial particles,

$$F_p(E, n) = pF(E, n).$$

We conclude that at those energies when the one–instanton amplitude is exponentially suppressed, all multi–instanton contributions are suppressed even stronger. For a given number of initial particles, the suppression of multi–instantons disappears at the same energy as the suppression of the one–instanton contribution.

4 Beyond the improved dilute instanton gas approximation: periodic instanton

The improved dilute instanton gas approximation breaks down when the size of the core, r_0 , becomes of order of the distance between the instantons, T , so that the instanton cores begin to overlap. At this energy, however, both r_0 and T are much smaller than $1/m$, so one may hope to calculate the exponent for the transition probability in the leading order in $1/\lambda$ beyond the improved dilute gas. Indeed, one may expect the exponential term in the lagrangian to play a role only in a small region of space-time of order r_0 or T ; in that region the mass term may be neglected, and the field obeys the Liouville equation. Outside the non-linearity region, but at distances much smaller than $1/m$, the field is both free and massless, so that the matching of the solutions to the Liouville equation and massive Klein-Gordon equation may still be possible.

It is almost obvious that this procedure should work for periodic instantons at all energies up to E_{sph} : both the improved instanton and the sphaleron have cores whose sizes are indeed smaller than $1/m$. In this section we construct the periodic instantons explicitly in the region of energies where $(E_{sph} - E)/E_{sph} \sim 1/\lambda$, and the improved dilute gas approximation does not work.

Let us first discuss the region of non-linearity where the field obeys the Liouville equation. We do not expect that the solution is $O(2)$ symmetric (obviously, the sphaleron is not), so we have to consider a general solution to the Liouville equation,

$$\chi(z, \bar{z}) = \frac{1}{2} \ln \frac{(1 + f(z)g(\bar{z}))^2}{f'(z)g'(\bar{z})}, \quad (61)$$

where the variable χ is introduced in eq.(13),

$$z = \frac{x + i\tau}{a}, \quad \bar{z} = \frac{x - i\tau}{a}. \quad (62)$$

a is defined in eq.(15) and $f(z)$ and $g(\bar{z})$ are arbitrary functions.

To specify the solution that describes the periodic instanton, we point out first that the ordinary instanton is determined by the functions

$$f(z) = \frac{c}{z}, \quad g(\bar{z}) = \frac{c}{\bar{z}}, \quad (63)$$

that have poles at the position of the instanton. So, we impose the following requirements on the functions relevant for the periodic instanton:

i) periodicity,

$$f\left(z + i\frac{T}{2a}\right) = f(z), \quad g\left(\bar{z} - i\frac{T}{2a}\right) = g(\bar{z});$$

ii) existence of poles at $z, \bar{z} = ilT/2a, l = 0, \pm 1, \pm 2, \dots$ (recall that in the dilute gas approximation, the periodic instanton is a chain of instantons sitting at these points);

iii) regularity of the function χ , eq.(61), everywhere in Euclidean space-time;

iv) reality,

$$g(\bar{z}) = (f(z))^*,$$

ensuring that χ is real in Euclidean space-time.

v) reality of χ also in Minkowski time (on both Minkowskian parts of the contour of fig.1).

These conditions are sufficient to determine f and g . We find

$$f(z) = \frac{B}{\tanh(\mu z)}, \quad g(\bar{z}) = \frac{B}{\tanh(\mu \bar{z})},$$

where

$$\mu = \frac{2\pi a}{T}$$

and B is yet unknown parameter. The field configuration corresponding to this choice is

$$\phi = -\frac{v}{\lambda} \ln \left[\frac{1}{\mu} \left(B \cosh \mu z \cosh \mu \bar{z} + \frac{1}{B} \sinh \mu z \sinh \mu \bar{z} \right) \right]. \quad (64)$$

The values of T (or μ) and B have to be found by matching this solution to the massive free field and requiring that the energy of this solution takes a given value E . The contour plots of the configuration (64) for different values of B is presented in fig.8.

First consider the case $B \ll 1$. At small z, \bar{z} , one has

$$\phi = -\frac{v}{\lambda} \ln \left(\frac{B}{\mu} + \frac{\mu}{B} \bar{z} z \right),$$

which coincides with eq.(16) for $c = B/\mu$. So, B is the diluteness parameter and $B \ll 1$ corresponds to the case of the dilute gas.

In what follows we concentrate on the case $B \sim 1$, when the improved dilute gas approximation is not valid. Let us assume that the period T is small enough, $T \ll 1/m$ (this assumption will be justified a posteriori). Then the field becomes free and massless at $T \ll x \ll 1/m$. Indeed, in this region we have $\mu z \gg 1$ and the configuration (64) is a time-independent solution to the massless free field equation,

$$\phi = -\frac{v}{\lambda} \ln \left[\frac{1}{4\mu} \left(B + \frac{1}{B} \right) \right] - \frac{2v\mu}{\lambda} |x|.$$

We have to match this configuration to the time-independent solution to the massive free equation, $\phi \propto e^{-m|x|}$. This matching results in the following relation,

$$\mu = e^\lambda (1 + O(\lambda^{-1})), \quad (65)$$

and the field outside the core is

$$\phi = ve^{-m|x|}. \quad (66)$$

The above formulas explicitly define the periodic instanton at given period T . At $B = 1$, the field (64) is independent of τ , and describes the core of the sphaleron,

$$\phi = -\frac{v}{\lambda} \ln \left[\frac{1}{\mu} \cosh \mu(z + \bar{z}) \right].$$

The values of the parameter B of order 1 correspond to energies at which the dilute instanton gas approximation does not work, i.e., $1 - E/E_{sph} \sim 1/\lambda$. The period is approximately constant in this energy interval,

$$T = \frac{2\pi a}{\mu} = \frac{4\pi}{\lambda m} (1 + O(\lambda^{-1})). \quad (67)$$

Since T does not change much in this region, we make use of the relation $\partial F/\partial E = T/g^2$, to obtain that eq.(49) is correct, with the accuracy $1/\lambda^2$, at all energies including the region close to the sphaleron mass.

To find the value of B , we make use of the following trick. Let us calculate explicitly the value of F for the configuration (64). We write

$$F = 2S - ET = 2 \int_0^{T/2} dt \int_{-\infty}^{\infty} dx \left(\frac{1}{2} (\partial_\tau \phi)^2 + \frac{1}{2} (\partial_x \phi)^2 + V(\phi) \right)$$

$$\begin{aligned}
& -2 \int_0^{T/2} dt \int_{-\infty}^{\infty} dx \left(-\frac{1}{2}(\partial_\tau \phi)^2 + \frac{1}{2}(\partial_x \phi)^2 + V(\phi) \right) \\
& = 2 \int_0^{T/2} dt \int_{-\infty}^{\infty} dx (\partial_\tau \phi)^2.
\end{aligned}$$

The result of the integration for the actual field, eq.(64), is

$$F = \frac{8\pi v^2}{\lambda^2} \ln \left[\frac{1}{2} \left(B + \frac{1}{B} \right) \right].$$

We now compare this result and eq.(49) and find

$$1 - \frac{E}{E_{sph}} = \frac{2}{\lambda} \ln \left[\frac{1}{2} \left(B + \frac{1}{B} \right) \right]$$

This relation determines the value of B at given energy, so that all parameters of the solution are now defined. Notice that $B \sim 1$ indeed corresponds to $(E_{sph} - E)/E_{sph} \sim 1/\lambda$. Note also that eq.(67) justifies the assumption that $T \ll 1/m$, so our calculation is reliable at all energies up to E_{sph} .

The above procedure for obtaining the relevant classical solution is likely to work at $\theta \sim 1/\lambda$, i.e., for processes with the number of particles of order n_{sph} . Unfortunately, this procedure does not work in the most interesting case $\theta \sim 1$ (i.e., for small number of particles in the initial state): the size of the solution to the Liouville equation very rapidly increases with energy and becomes of order $1/m$ essentially at the same energy as one given by eq.(58). The calculations leading to the latter negative conclusion are not illuminating and we do not present them here.

5 Induced vacuum decay

In this section we briefly discuss a process which is closely related to the shadow processes, namely, the decay of the false vacuum induced by initial particles. The most probable process of the induced vacuum decay at a given energy and number of initial particles is described by the solution to the same boundary value problem, eqs.(2) and (3), but with the condition that the field in the final state (the part CD of the contour of fig.1) describes an expanding bubble with the large value of the scalar field inside. In the dilute gas approximation, the configuration is a chain of instantons located at $(lT, 0)$ with intensities $\exp(-|l|\theta)$ (fig.9). The decay rate is again exponential,

$$\Gamma \sim \exp(-F),$$

where F is calculated according to eq.(5). As is seen from fig.9, the induced vacuum decay can be considered as a half-instanton process.

The solution to the boundary value problem can be obtained, in the improved dilute instanton gas approximation, in a complete analogy to Sect.3. The details of the calculation are not very instructive, so we present here our results for the rates only.

i) In the case $\theta \sim 1/\lambda$, the function $F(E, n)$ of the vacuum decay is exactly half of the function F for the shadow process at the same energy and the same number of particles. The region of validity of the improved dilute gas approximation is also the same.

ii) For parametrically larger θ , $\theta \sim 1$, the formula analogous to eq.(55) reads

$$F = S_0 \left[1 - 2 \frac{e^{-\theta}}{1 - e^{-\theta}} \left(1 + \frac{\theta}{1 - e^{-\theta}} \right) \frac{1}{\lambda} \ln \frac{E}{E_{sph}} \right],$$

where θ is again a function of particle number and energy,

$$\theta = \operatorname{arccosh} \left(1 + \frac{2\pi^2}{\lambda^2} \frac{n_{sph}}{n} \ln \frac{E}{E_{sph}} \right).$$

In the limit $\theta \rightarrow \infty$, all instantons, excluding the central one, can be neglected, and the function F is equal to its zero-energy value, S_0 . So, we find that at energies where the improved dilute gas approximation is valid, the vacuum decay is not enhanced by a small (of order v^2/λ) number of initial particles. The region of validity of the dilute gas again extends to a certain critical energy, that depends on the number of initial particles and is of order

$$E_{crit} \sim e^\lambda E_{sph}$$

in the limit $\theta \rightarrow \infty$, i.e, when the number of initial particles is small.

6 ϕ^N model

In this section we consider another example of the (1+1) dimensional scalar theory with the quadratic potential with a cliff. Namely, we take the scalar potential to have the following form,

$$V(\phi) = \frac{m^2 \phi^2}{2} - \frac{m^2}{2v^N} \phi^{N+2}, \quad (68)$$

where N is a large number playing the role of λ in the potential model. The qualitative behavior of the potential is the same as in the exponential model.

The sphaleron field outside the core is precisely the same as in the exponential model. In particular, the sphaleron energy and the number of particles are given by eqs.(10) and (11), respectively.

The technique developed for the exponential model to describe the instanton and improved dilute instanton gas requires a slight modification in the power model. Let us find out the instanton in this model. The Euclidean field equation has the form

$$\partial_\mu^2 \phi = m^2 \phi - (N + 2) \frac{m^2}{2v^N} \phi^{N+1}. \quad (69)$$

First let us consider the region $r \ll m^{-1}$, where the mass term in the field equation can be neglected. Though the nonlinear term in eq.(69) does not have the exponential form, in this region eq.(69) reduces to the Liouville equation. To see this, let us make the following change of variables

$$\phi = \phi_0 \left(1 - \frac{2\chi}{N} \right), \quad (70)$$

where $\phi_0 = \phi(0)$ is a yet undetermined parameter, and consider only such r for which $\chi(r) \ll N$ (i.e. $1 - \phi(r)/\phi_0 \ll 1$). Eq.(69) obviously reduces to the Liouville equation (recall that $N \gg 1$),

$$\partial_\mu^2 \chi = \frac{4}{r_0^2} e^{-2\chi}, \quad (71)$$

where

$$r_0 = \frac{4}{Nm} \left(\frac{\phi_0}{v} \right)^{-N/2}.$$

The $O(2)$ symmetric solution to eq.(71) obeying the condition $\chi(0) = 0$ is

$$\chi(r) = \ln \left(1 + \frac{r^2}{r_0^2} \right). \quad (72)$$

We now match the solution, eqs.(70),(72), to free massive field at $m^{-1} \gg r \gg r_0$,

$$\phi(r) = \phi_0 \left(1 - \frac{2}{N} \ln \left(1 + \frac{r^2}{r_0^2} \right) \right) = \alpha K_0(mr), \quad (73)$$

and obtain

$$\begin{aligned} \phi_0 &= v e^{1/2}, \quad r_0 \sim m^{-1} e^{-N/4}, \\ \alpha &= \frac{4e^{1/2}v}{N}. \end{aligned}$$

Notice that the size of the instanton core, r_0 , is indeed exponentially smaller than m^{-1} . The instanton action is equal to

$$S_0 = \frac{4\pi ev^2}{N}.$$

Given the instanton field, it is straightforward to evaluate the leading order instanton contribution to the two-particle total cross section for the shadow process. We find

$$F(E)^{leading} = 2S_0 \left(1 - \frac{4}{N} \ln \frac{E}{E_{sph}} \right) \quad (74)$$

so that the energy scale relevant to the two-particle processes is again exponentially large as compared to the sphaleron mass,

$$E_0 \sim E_{sph} e^{N/4}$$

Now let us consider the improved dilute instanton gas. The field outside the instanton core is still given by eq.(32), while the field inside the core is determined by eqs.(70),(72) where $\phi_0 = \phi(0)$ is yet unknown. The analog of the matching condition, eq.(73), is that at $m^{-1} \gg r \gg r_0$ the following relation should hold,

$$\phi(r) = \phi_0 \left(1 - \frac{2}{N} \ln \left(1 + \frac{r^2}{r_0^2} \right) \right) = \alpha(K_0(mr) + f),$$

where f is defined by the same formula as in the case of the exponential model, eq.(38). One obtains

$$\begin{aligned} \phi_0 &= v \exp \left(\frac{1}{2} - \frac{2}{N} f \right), \quad r_0 \sim m^{-1} \exp \left(-\frac{N}{4} + f \right). \\ \alpha &= \frac{4v}{N} \exp \left(\frac{1}{2} - \frac{2}{N} f \right). \end{aligned} \quad (75)$$

It is worth noting that the parameter α depends on f , i.e., on the parameters T and θ , in contrast to the exponential model, where α is constant. So, not only inside the core, but also outside the core the field is sensitive to the distance between the instantons.

In the case $\theta \sim 1/N$, i.e., at $n/n_{sph} \sim 1$, one obtains from eqs.(45), (34), (35) and (75) the following expressions for the energy and the number of initial particles,

$$\begin{aligned} E &= x^2 \exp(1 - x f_1(\beta)) f_2(\beta) E_{sph}, \\ n &= x^2 \exp(1 - x f_1(\beta)) f_3(\beta) n_{sph}, \end{aligned}$$

where

$$x = \frac{8\pi}{NmT}$$

$$\beta = \frac{\theta}{mT}$$

and f_1 , f_2 and f_3 are the same functions as defined in Sect.3. The calculations analogous to those of the exponential model give for the action

$$S = \frac{4\pi ev^2}{N} \exp(1 - x f_1(\beta)),$$

so the function $F = 2S - ET - n\theta$ has the following form,

$$F = \frac{8\pi ev^2}{N} (1 - x f_1(\beta)) \exp(1 - x f_1(\beta)).$$

Though these formulas are slightly more complicated than eqs.(46) and (47), the qualitative behavior of the function $F(E, n)$ is the same as in the case of the exponential model. In other words, the behavior shown in fig.5 is qualitatively correct in the power model as well. The improved instanton gas approximation is valid until the probability becomes parametrically less suppressed as compared to the instanton,

$$F \sim \frac{S_0}{N},$$

in a complete analogy to the exponential model.

In the regime $\theta \sim 1$, i.e., at $n/n_{sph} \sim 1/N$, the interesting energies are exponentially large, so that

$$\frac{1}{N} \ln \frac{E}{E_{sph}} = \kappa \sim 1.$$

The formula analogous to eq.(55) is

$$F = 2S_0 \exp\left(-4 \frac{1 + 3e^{-\theta}}{1 - e^{-\theta}} \kappa\right) \left[1 - \frac{16\theta e^{-\theta}}{(1 - e^{-\theta})^2} \kappa\right],$$

where θ is to be determined from a relation analogous to eq.(54),

$$n = \frac{64\pi^2 e n_{sph}}{N} \frac{e^{-\theta}}{(1 - e^{-\theta})^2} \kappa \exp\left(-4 \frac{1 + 3e^{-\theta}}{1 - e^{-\theta}} \kappa\right).$$

The size of the core is

$$r_0 \sim \frac{1}{m} \exp\left(-\frac{N}{4} + N \frac{1 + 3e^{-\theta}}{1 - e^{-\theta}} \kappa\right).$$

In the limit $\theta \rightarrow \infty$, i.e., $n/n_{sph} \rightarrow 0$, the behavior of the function F is as follows,

$$F = 2S_0 \exp\left(-\frac{4}{N} \ln \frac{E}{E_{sph}}\right) = 2S_0 \left(\frac{E}{E_{sph}}\right)^{-4/N}. \quad (76)$$

Note that in the ϕ^N model, the function $F(E/E_{sph})$ contains higher order terms in $N^{-1} \ln(E/E_{sph})$, in contrast to the exponential model, where all higher terms vanish and the result coincides with the one-instanton expression.

Let us explain the latter result. Recall that in the exponential model only the field inside the instanton core is modified by the presence of other instantons, while the linear tail of an instanton in the chain is the same as that of a single instanton (the parameter α is constant independent of T and θ). If the cores do not overlap, the field configuration outside the cores is the same as in the ordinary dilute instanton gas approximation. The dependence of E and n on T and θ , eqs.(34) and (35), thus coincides with the formulas of the ordinary dilute instanton gas approximation. Since the function F can be recovered from eq.(6), it is not surprising that the improved dilute instanton gas implies the same result for F as the lowest order of the perturbation theory around a single instanton. In the ϕ^N model, on the contrary, the intensity of the linear tail depends on T and θ (see eq.(75)), so the correction to the one-instanton formula for the function F is large.

In the limit $\theta \rightarrow \infty$, the improved dilute gas approximation breaks down at $E_{crit} \sim e^{N/8} E_{sph}$, where $F = 2S_0/\sqrt{e}$. As in the exponential model, the function F is reduced only by a factor of order one ($2/3$ in the exponential model and $e^{-1/2}$ in the power model).

7 Conclusions

In this paper we have found the solution to the classical boundary value problem for certain (1+1) dimensional field theories with the potential having the form of a quadratic potential with a cliff. The presence of an additional large parameter in the model allowed us to deal with energies comparable to or much larger than the sphaleron mass. The solution, which describes the shadow processes, has been found reliably within the improved dilute instanton gas approximation at large energies where the ordinary dilute instanton gas approximation does not work. We have found that for the number of initial particles, n , of order n_{sph} , the function $F(E/E_{sph}, n)$ monotonously decreases from $2S_0$ at $E = 0$ and becomes of order S_0/λ (or S_0/N)

at some E_{crit} , where the improved dilute gas approximation fails. For n of order n_{sph}/λ (or n_{sph}/N in the ϕ^N model), including the limit $n \rightarrow 0$ which is smooth, the improved dilute gas approximation breaks down at energies where the function F is still of order S_0 , and the instanton-like transitions are still suppressed. So, although in our models we can go beyond the ordinary perturbative theory around the instanton, the possibility of large probability of the instanton-like transitions induced by two energetic particles remains an open question even in these models.

The authors are indebted to A.N.Kuznetsov and P.G.Tinyakov for numerous helpful discussions at all stages of this work. We are indebted to T.Banks and V.Petrov for the discussion of the results. V.R. thanks Aspen Center for Physics and Rutgers University for hospitality. The work of D.T.S. is supported in part by the Russian Foundation for Fundamental Research (project 93-02-3812) and by the Wein-gart Foundation through a cooperative agreement with the Department of Physics at UCLA.

References

- [1] A.Ringwald, *Nucl.Phys.* **B330** (1990) 1;
O.Espinosa, *Nucl.Phys.* **B334** (1990) 310.
- [2] L.McLerran, A.I.Vainshtein and M.B.Voloshin *Phys.Rev.* **D42** (1990) 171.
- [3] M.Mattis, *Phys.Rep.* **214** (1992) 159.
- [4] P.G.Tinyakov, *Int.J.Mod.Phys.* **A8** (1993) 1823.
- [5] V.I.Zakharov, *Classical Corrections to Instanton-Induced Amplitudes*, preprint TPI-MINN-90/7-T, 1990; *Nucl.Phys.* **B371** (1992) 637.
- [6] S.Yu.Khlebnikov, V.A.Rubakov and P.G.Tinyakov, *Mod.Phys.Lett.* **A5** (1990) 1983; *Nucl.Phys.* **B350** (1991) 441.
- [7] M.Porrati, *Nucl.Phys.* **B347** (1991) 371.
- [8] V.V.Khoze and A.Ringwald, *Nucl.Phys.* **B355** (1991) 351.
- [9] A.H.Mueller, *Nucl.Phys.* **B364** (1991) 109.
D.I.Diakonov and V.Yu.Petrov, *Baryon Number Non-Conservation in Processes at High Energies*, In: Proceedings of XXVI Winter School, LINP, Leningrad,

1991.
P.B.Arnold and M.P.Mattis, *Mod.Phys.Lett.* **A6** (1991) 2095.
- [10] A.H.Mueller, *Nucl.Phys.* **B348** (1991) 310; **B353** (1991) 44.
- [11] V.A.Rubakov and P.G.Tinyakov, *Phys.Lett.* **B279** (1992) 165.
- [12] P.G.Tinyakov, *Phys.Lett.* **B284** (1992) 410.
- [13] S.Khlebnikov, *Variational approach to multiparticle production*, preprint UCLA/91/TEP/38(1991).
- [14] D.Diakonov and V. Petrov, *Non-perturbative isotropic multi-particle production in Yang-Mills theory*, preprint RUB - TPII - 52/93(1993)
- [15] M.B.Voloshin, *Catalyzed decay of false vacuum in four dimensions*, preprint TPI - MINN - 93/37 - T(1993)
- [16] V.A.Rubakov, D.T.Son and P.G.Tinyakov, *Phys.Lett.* **287B** (1992) 342.
- [17] A.H.Mueller, *Nucl.Phys.* **B401** (1993) 93.
- [18] S.Coleman, *Phys.Rev.* **D15** (1977) 2929;
C.Callan and S.Coleman *Phys.Rev.* **D16** (1977) 1762.
- [19] S.D.H.Hsu, *Phys.Lett.* **B261** (1991) 81.
- [20] M.B.Voloshin, *Nucl.Phys.* **B363** (1991) 425.
- [21] V.Zakharov, *Nucl.Phys* **B353** (1991) 683.
- [22] M.Maggiore and M.Shifman, *Nucl.Phys.* **B365** (1991) 161; **B371** (1991) 177.
- [23] S.Yu.Khlebnikov, V.A.Rubakov and P.G.Tinyakov, *Nucl.Phys.* **B367** (1991) 334.

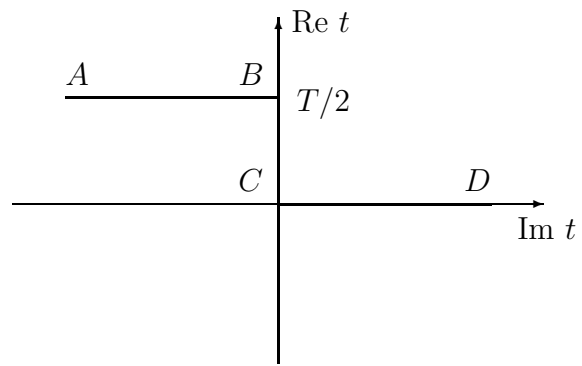

Fig.1

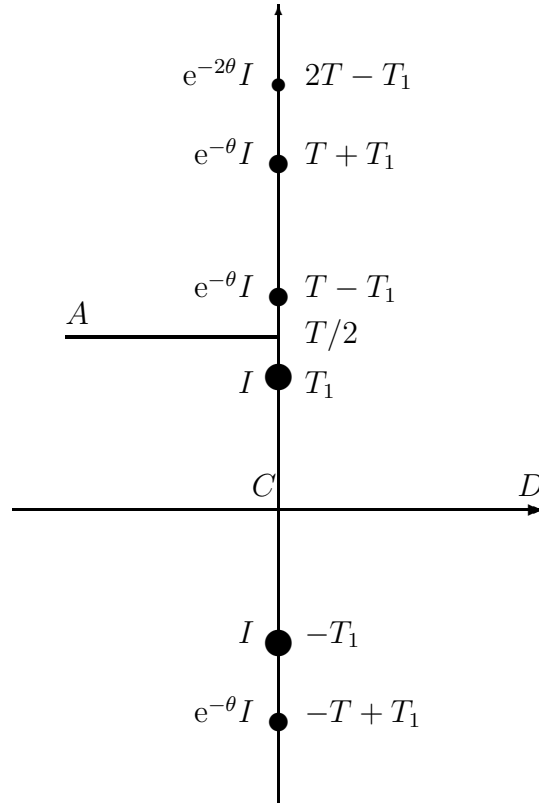

Fig.3

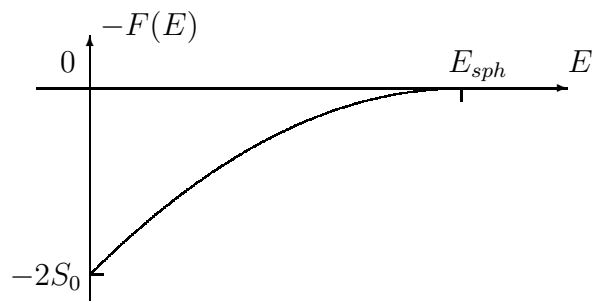

Fig.4

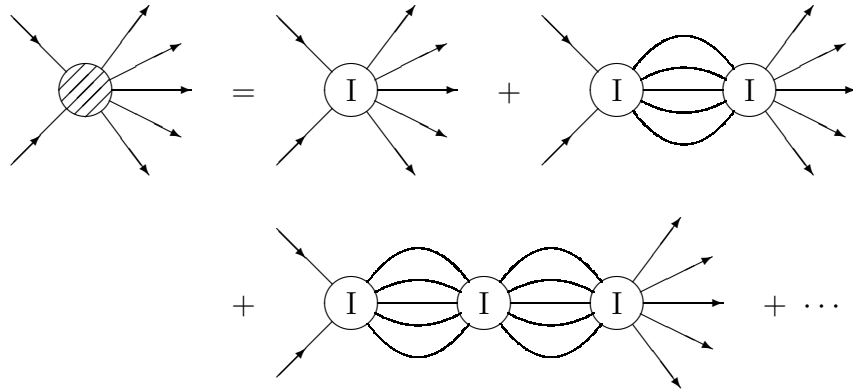

Fig.6

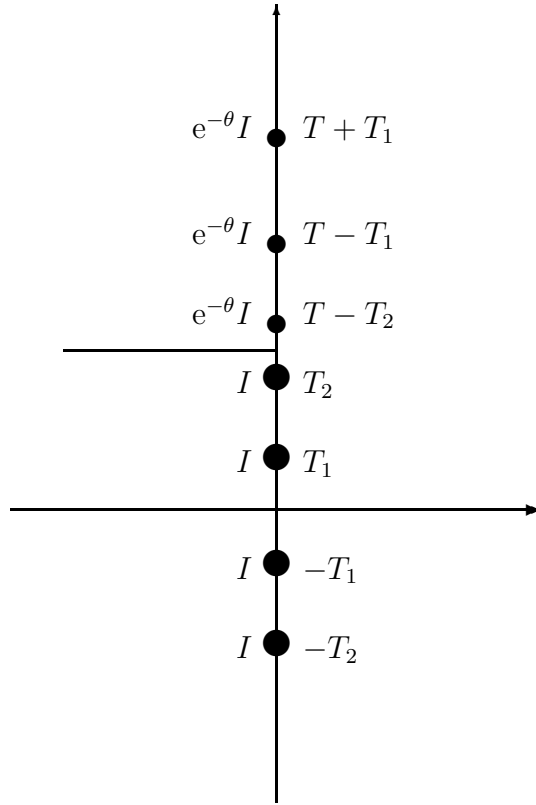

Fig.7

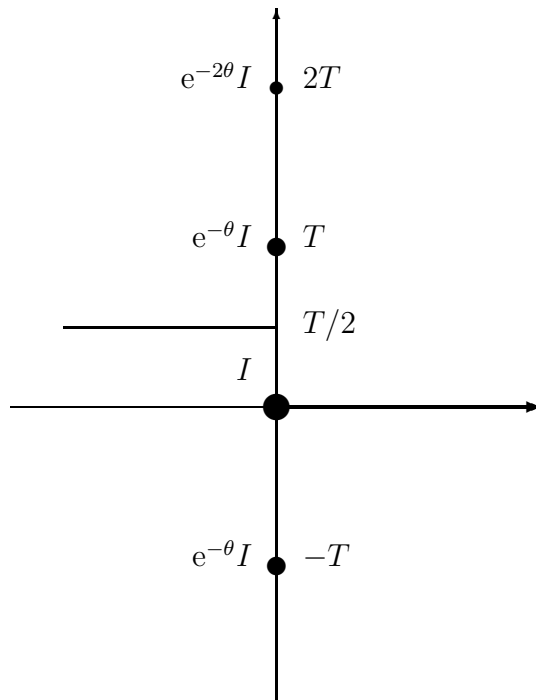

Fig.9

Figure captions:

1. The contour in the complex time plane, on which the boundary value problem is formulated.
2. The potential $V(\phi)$.
3. The schematic plot of the solution to the boundary value problem in the improved dilute instanton gas approximation. I stand for the instanton.
4. The function $F(E)$ for the periodic instanton.
5. The function $F(E, n)$ for $\nu = n/n_{sph} \sim 1$. In the regions where $F \sim S_0/\lambda$, the curves are unreliable.
6. Multi-instanton contributions to $2 \rightarrow many$ amplitudes.
7. The two-instanton solution to the boundary value problem.
8. The contour plots of the periodic instanton solution, eq.(64), for different values of B . Larger B correspond to higher energies. As B increases from 0 ($E = 0$) to 1 ($E = E_{sph}$), the configuration evolves from a chain of instantons to the sphaleron.
9. The configuration describing the induced vacuum decay in the improved dilute instanton gas approximation.

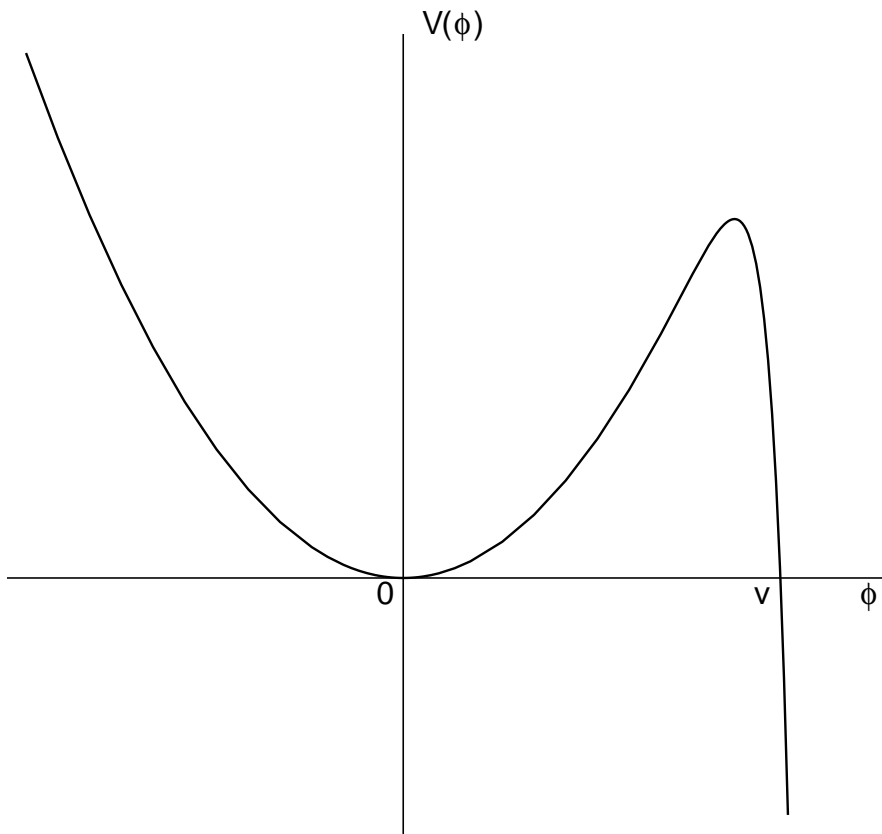

Fig.2

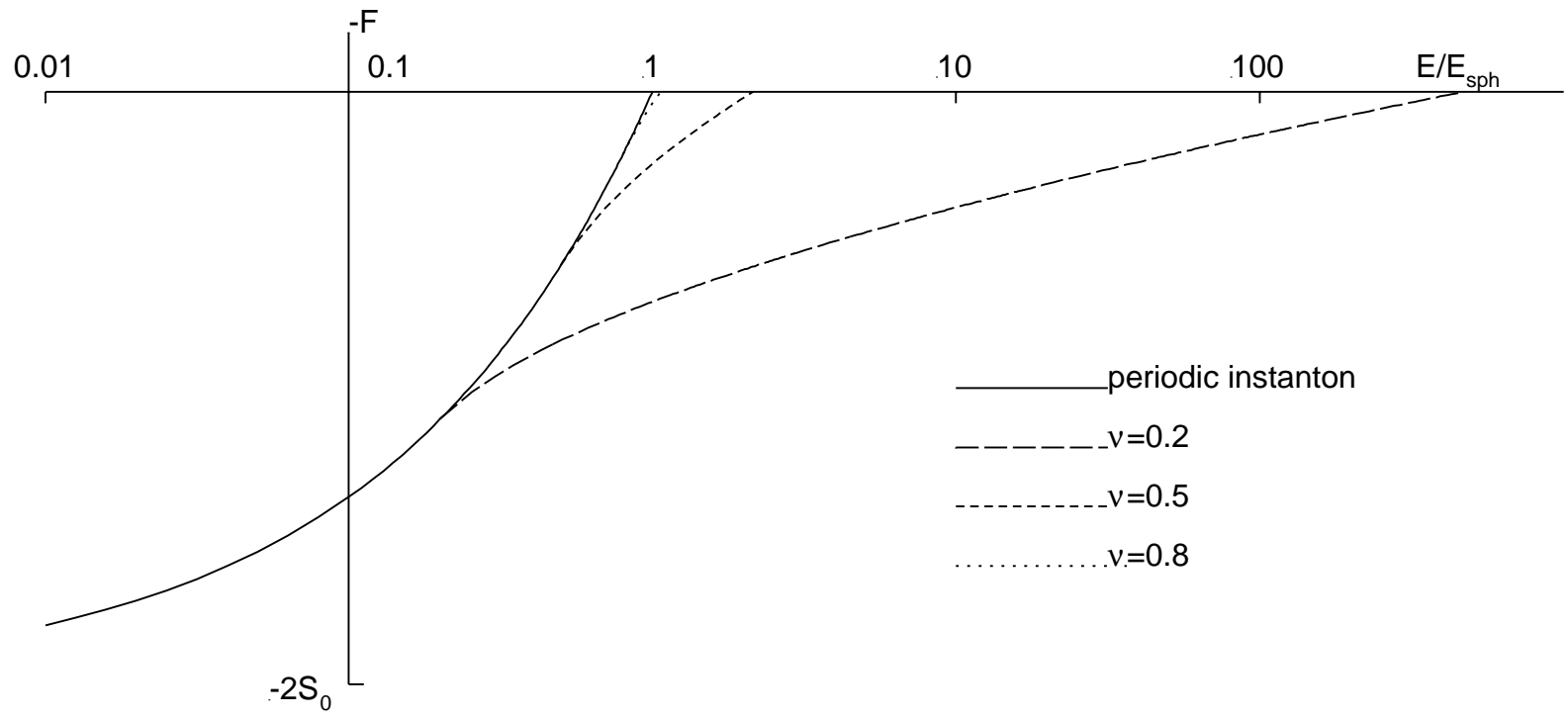
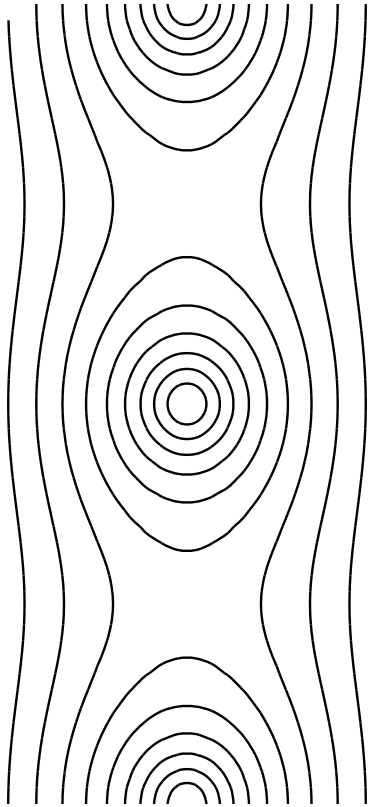
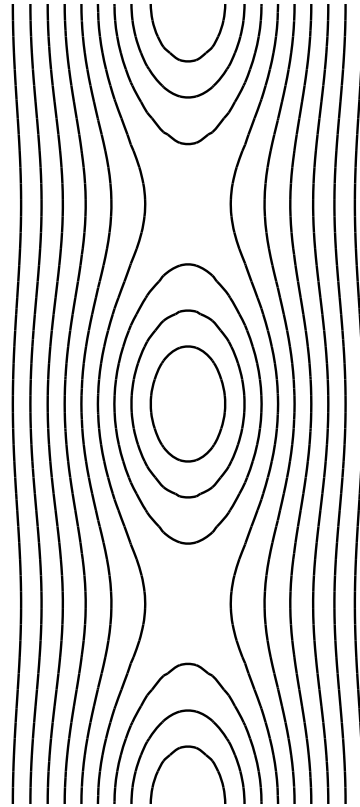

Fig.5



$B=0.2$



$B=0.6$

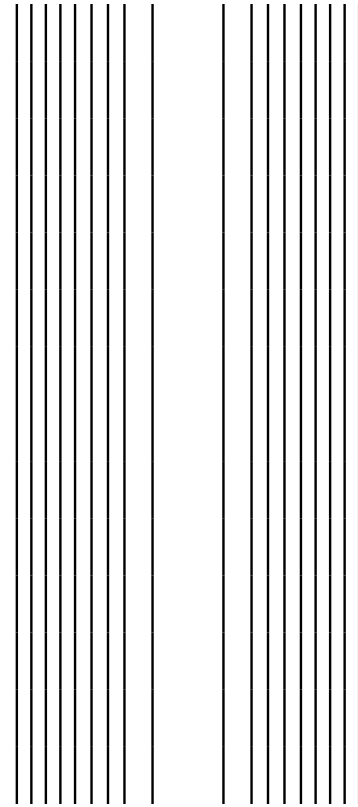

$B=1$

Fig.8