

Ribbon-moves of 2-knots: the Farber-Levine pairing and the Atiyah-Patodi-Singer-Casson-Gordon-Ruberman $\tilde{\eta}$ -invariants of 2-knots

Eiji Ogasa *

ogasa@ms.u-tokyo.ac.jp

Department of Physics, University of Tokyo
Hongo, Tokyo 113, JAPAN

Abstract. Let K and K' be 2-knots. Suppose that K and K' are ribbon-move equivalent. Then there is an isomorphism $\text{Tor}H_1(\tilde{X}_K; \mathbf{Z}) \cong \text{Tor}H_1(\tilde{X}_{K'}; \mathbf{Z})$ as $\mathbf{Z}[t, t^{-1}]$ -modules. Furthermore the Farber-Levine pairing for K is equivalent to that of K' .

Let K be a 2-knot which is ribbon-move equivalent to the trivial knot. Then the Atiyah-Patodi-Singer-Casson-Gordon-Ruberman \mathbf{Q}/\mathbf{Z} -valued $\tilde{\eta}$ -invariants $\tilde{\eta}(K, d)$ for \mathbf{Z}_d is zero. ($d \in \mathbf{N}$ and $d \geq 2$).

1 Ribbon-moves of 2-knots

In this paper we discuss ribbon-moves of 2-knots. In this section we review the definition of ribbon-moves.

An (*oriented*) *2-(dimensional) knot* is a smooth, oriented submanifold K of S^4 which is diffeomorphic to the 2-sphere. We say that 2-knots K_1 and K_2 are *equivalent* if there exists an orientation preserving diffeomorphism $f : S^4 \rightarrow S^4$ such that $f(K_1) = K_2$ and that $f|_{K_1} : K_1 \rightarrow K_2$ is an orientation preserving diffeomorphism. Let $id : S^4 \rightarrow S^4$ be the identity. We say that 2-knots K_1 and K_2 are *identical* if $id(K_1) = K_2$ and that $id|_{K_1} : K_1 \rightarrow K_2$ is an orientation preserving diffeomorphism.

Definition 1.1. Let K_1 and K_2 be 2-knots in S^4 . We say that K_2 is obtained from K_1 by one *ribbon-move* if there is a 4-ball B of S^4 with the following properties.

- (1) $K_1 - (B \cap K_1) = K_2 - (B \cap K_2)$.

This diffeomorphism map is orientation preserving.

- (2) $B \cap K_1$ is drawn as in Figure 1.1. $B \cap K_2$ is drawn as in Figure 1.2.

We regard B as $(\text{a close 2-disc}) \times [0, 1] \times \{t \mid -1 \leq t \leq 1\}$. We put $B_t = (\text{a close 2-disc}) \times [0, 1] \times \{t\}$. Then $B = \cup B_t$. In Figure 1.1 and 1.2, we draw $B_{-0.5}, B_0, B_{0.5} \subset B$.

We draw K_1 and K_2 by the bold line. The fine line denotes $\partial(B_t)$.

$B \cap K_1$ (resp. $B \cap K_2$) is diffeomorphic to $D^2 \amalg (S^1 \times [0, 1])$.

* 1991 Mathematics Subject Classification. Primary 57M25, 57Q45, 57R65

This research was partially supported by Research Fellowships of the Promotion of Science for Young Scientists.

Keyword: 2-knots, ribbon-moves of 2-knots, the $\tilde{\eta}$ -invariants of 2-knots, the Farber-Levine pairing of 2-knots, the Alexander module

$B \cap K_1$ has the following properties: $B_t \cap K_1$ is empty for $-1 \leq t < 0$ and $0.5 < t \leq 1$. $B_0 \cap K_1$ is diffeomorphic to $D^2 \amalg (S^1 \times [0, 0.3]) \amalg (S^1 \times [0.7, 1])$. $B_{0.5} \cap K_1$ is diffeomorphic to $(S^1 \times [0.3, 0.7])$. $B_t \cap K_1$ is diffeomorphic to $S^1 \amalg S^1$ for $0 < t < 0.5$.

$B \cap K_2$ has the following properties: $B_t \cap K_2$ is empty for $-1 \leq t < -0.5$ and $0 < t \leq 1$. $B_0 \cap K_2$ is diffeomorphic to $D^2 \amalg (S^1 \times [0, 0.3]) \amalg (S^1 \times [0.7, 1])$. $B_{-0.5} \cap K_2$ is diffeomorphic to $(S^1 \times [0.3, 0.7])$. $B_t \cap K_2$ is diffeomorphic to $S^1 \amalg S^1$ for $-0.5 < t < 0$.

We do not assume which the orientation of $B \cap K_1$ (resp. $B \cap K_2$) is.

Figure 1.1.

Figure 1.2.

Suppose that K_2 is obtained from K_1 by one ribbon-move and that K'_2 is equivalent to K_2 . Then we also say that K'_2 is obtained from K_1 by one *ribbon-move*.

If K_1 is obtained from K_2 by one ribbon-move, then we also say that K_2 is obtained from K_1 by one *ribbon-move*.

Definition 1.2. 2-knots K_1 and K_2 are said to be *ribbon-move equivalent* if there are 2-knots $K_1 = \bar{K}_1, \bar{K}_2, \dots, \bar{K}_{p-1}, \bar{K}_p = K_2$ ($p \in \mathbf{N}, p \geq 2$) such that \bar{K}_i is obtained from \bar{K}_{i-1} ($1 < i \leq p$) by one ribbon-move.

In this paper we discuss the following problems.

Problem 1.3. Let K_1 and K_2 be 2-knots. Consider a necessary (resp. sufficient, necessary and sufficient) condition that K_1 and K_2 are ribbon-move equivalent.

In [13]the author proved:

Theorem 1.4. ([13])

(1)If 2-knots K and K' are ribbon-move equivalent, then

$$\mu(K) = \mu(K').$$

(2)Let K_1 and K_2 be 2-knots in S^4 . Suppose that K_1 are ribbon-move equivalent to K_2 . Let W_i be arbitrary Seifert hypersurfaces for K_i . Then the torsion part of $\{H_1(W_1) \oplus H_1(W_2)\}$ is congruent to $G \oplus G$ for a finite abelian group G .

(3)Not all 2-knots are ribbon-move equivalent to the trivial 2-knot.

(4)The inverse of (1) is not true. The inverse of (2) is not true.

2 Main results

Theorem 2.1. Let K and K' be 2-knots. Suppose that K and K' are ribbon-move equivalent. Then we have:

(1)There is an isomorphism $\text{Tor}H_1(\tilde{X}_K; \mathbf{Z}) \cong \text{Tor}H_1(\tilde{X}_{K'}; \mathbf{Z})$ as $\mathbf{Z}[t, t^{-1}]$ -modules.

(2)The Farber-Levine pairing on $\text{Tor}H_1(\tilde{X}_K; \mathbf{Z})$ is equivalent to that on $\text{Tor}H_1(\tilde{X}_{K'}; \mathbf{Z})$.

Theorem 2.2. Let K be a 2-knot. Suppose that K is ribbon-move equivalent to the trivial knot. Then $\tilde{\eta}(K, \quad)$ for \mathbf{Z}_d is zero. ($d \in \mathbf{N}$ and $d \geq 2$).

Note. We review the Alexander module in §3. We review the Farber-Levine pairing in §4. We review the Atiyah-Patodi-Singer-Casson-Gordon-Ruberman \mathbf{Q}/\mathbf{Z} -valued $\tilde{\eta}$ -invariants of 2-knots in §5.

3 The Alexander module

See [10][14]for detail.

Let K be a 2-knot $\subset S^4$. Let $N(K)$ be the tubular neighborhood of K in S^4 . Let $\alpha : \pi_1(\overline{S^4 - N(K)}) \rightarrow H_1(\overline{S^4 - N(K)}; \mathbf{Z})$ be the abelianization. Note that any nonzero cycle $x \in H_1(\overline{S^4 - N(K)}; \mathbf{Z})$ is oriented naturally by using the orientation of K and that of S^4 . We define the canonical isomorphism $\beta : H_1(\overline{S^4 - N(K)}; \mathbf{Z}) \rightarrow \mathbf{Z}$ by using these orientations of x . Let \tilde{X}_K^∞ be the covering space associated with $\beta \circ \alpha : \pi_1(\overline{S^4 - N(K)}) \rightarrow \mathbf{Z}$. We call \tilde{X}_K^∞ the *canonical infinite cyclic covering space* of the complement $\overline{S^4 - N(K)}$ of K . Then $H_i(\tilde{X}_K^\infty; \mathbf{Z})$ is regarded as a $\mathbf{Z}[t, t^{-1}]$ -module by using the covering translations $\tilde{X}_K^\infty \rightarrow \tilde{X}_K^\infty$. This $\mathbf{Z}[t, t^{-1}]$ -module $H_i(\tilde{X}_K^\infty; \mathbf{Z})$ is called the *Alexander module*.

4 lk(,) for 2-knots

See [7][11] for detail.

Firstly we review of lk(,) for closed oriented 3-manifolds. Let M be a closed oriented 3-manifold. Let $x, y \in \text{Tor}H_1(M; \mathbf{Z})$. Let n (resp. m) be a natural number. Let n (resp. m) be the order of x (resp. y). Let X (resp. Y) be a circle embedded in M such that $[X] = x$ (resp. $[Y] = y$). Let $X \cap Y = \emptyset$. Then there is an immersion map $f : F \rightarrow M$ such that

- (1) F is an oriented compact surface and ∂F is one circle.
- (2) $f(\text{Int}F)$ is an embedding.
- (3) $f(\partial F) = X$ and $\deg(f|_{\partial F}) = n$.
- (4) $f(\text{Int}F)$ is transverse to Y .

Let $f(F) \cap Y = P_1 \amalg \dots \amalg P_\alpha$. (Note P_i is a point.) We give P_i a signature ε_i by using the orientation of $f(F)$, that of Y , and that of M .

Define $\text{lk}(x, y) = \frac{1}{n} \sum_{i=1}^\alpha \varepsilon_i \in \mathbf{Q}/\mathbf{Z}$.

Proposition. $\text{lk}(y, x) = \text{lk}(x, y)$.

There is an immersion map $g : G \rightarrow M$ such that

- (1) G is an oriented compact surface and ∂G is one circle.
- (2) $g(\text{Int}G)$ is an embedding.
- (3) $g(\partial G) = Y$ and $\deg(g|_{\partial G}) = m$.
- (4) $g(\text{Int}G)$ is transverse to X .
- (5) $\text{Int}F$ is transverse to $\text{Int}G$.

Let $g(G) \cap X = Q_1 \amalg \dots \amalg Q_\beta$. (Note Q_j is a point.) We give Q_j a signature σ_j by using the orientation of $g(G)$, that of X , and that of M . Let $f(\text{Int}F) \cap g(\text{Int}G) = R_1 \amalg \dots \amalg R_\gamma$. (Note R_k is a compact open 1-manifold.) We give R_k a signature τ_k by using the orientation of $g(G)$, that of $f(F)$, and that of M . Then we have:

$$\text{lk}(y, x) = \frac{1}{m} \sum_{j=1}^\beta \sigma_j = \frac{1}{m \cdot n} \sum_{k=1}^\gamma \tau_k = \frac{1}{n} \sum_{i=1}^\alpha \varepsilon_i = \text{lk}(x, y).$$

Secondly we review lk(,) for 2-knots. Let K be a 2-knot. Let \tilde{X}_K^∞ be the canonical infinite cyclic covering space of the complement $\overline{S^4 - N(K)}$ of K . Let $x, y \in \text{Tor}H_1(\tilde{X}_K^\infty; \mathbf{Z})$. We define $\text{lk}(x, y)$.

Let p be the natural projection map $\tilde{X}_K^\infty \rightarrow X$. Let V be a Seifert hypersurface for K . Let V_ξ be one connected component of $p^{-1}(V) = \amalg_{i=1}^\infty V_i$. The natural inclusion map $V_\xi \rightarrow \tilde{X}_K^\infty$ induces the homomorphism $\iota : H_1(V_\xi) \rightarrow H_1(\tilde{X}_K^\infty)$. Theorem 7.3 of [7] and its proof essentially say that $\iota : \text{Tor}H_1(V_\xi) \rightarrow \text{Tor}H_1(\tilde{X}_K^\infty)$ is onto.

Let \hat{V}_ξ be the closed oriented 3-manifold which is obtained from V_ξ by attaching a 3-dimensional 3-handle along ∂V_ξ . The natural inclusion map $V_\xi \rightarrow \hat{V}_\xi$

induces $\gamma : H_1(V_\xi; \mathbf{Z}) \xrightarrow{\cong} H_1(\hat{V}_\xi; \mathbf{Z})$. Then the map $(\iota \circ \gamma^{-1}) : \text{Tor}H_1(\hat{V}_\xi; \mathbf{Z}) \rightarrow \text{Tor}H_1(\tilde{X}_K^\infty; \mathbf{Z})$ is onto. Let $(\iota \circ \gamma^{-1})(x') = x$ and $(\iota \circ \gamma^{-1})(y') = y$. Define $\text{lk}(x, y)$ for the 2-knot K to be $\text{lk}(x', y')$ for the 3-manifold \hat{V}_ξ . Theorem 7.3 of [7] and its proof essentially say that $\text{lk}(x, y)$ for the 2-knot K is independent of the choice of V .

5 $\tilde{\eta}(\quad, \quad)$ of 2-knots

See $\tilde{\eta}(\quad, \quad)$ for [1] [2] [3] [15] for detail.

We firstly define $\tilde{\eta}(\quad, \quad)$ of closed oriented 3-manifolds. (See P.571 of [15].)

Let A be an oriented compact 4-manifold. For d an integer, set $\omega = e^{\frac{2\pi i}{d}}$, and suppose $\phi : A \rightarrow K(\mathbf{Z}_d, 1)$ is a continuous map. Then ϕ corresponds to a class $\phi \in H^1(A; \mathbf{Z}_d) = \text{Hom}(H_1(A; \mathbf{Z}); \mathbf{Z}_d)$ and induces a cyclic cover $\tilde{A} \rightarrow A$ with a specific choice $T : \tilde{A} \rightarrow \tilde{A}$ of a generator of the covering translations. Let $\overline{H}_2(A, \phi) = \omega$ -eigenspace of T_* acting on $H_2(\tilde{A}; \mathbf{C})$. The intersection form on A induces a Hermitian pairing on $H_2(A; \mathbf{C})$; $\langle x \otimes \alpha, y \otimes \beta \rangle = (x \cdot y) \otimes \alpha \bar{\beta}$. Define $\overline{\sigma}(A, \phi) =$ the signature of \langle, \rangle restricted to $\overline{H}_2(A, \phi)$.

Let M be an oriented closed 3-manifold. Let $\psi \in H^1(M; \mathbf{Z}_d)$ be a homomorphism. By bordism theory, $n \cdot (M, \psi) = \partial(W, \phi)$ for a compact oriented 4-manifold W . (See e.g. [6]) Define $\tilde{\eta}(M, \psi) = \frac{1}{n}(\overline{\sigma}(W, \phi) - \sigma(W))$.

Secondly we define $\tilde{\eta}(\quad, \quad)$ of 2-knots. (See [15][16]) Let K be a 2-knot. Take $\tilde{X}_K^\infty, V, V_\xi, \iota : H_1(V_\xi; \mathbf{Z}) \rightarrow H_1(\tilde{X}_K^\infty; \mathbf{Z}), \hat{V}_\xi, \gamma : H_1(V_\xi; \mathbf{Z}) \cong H_1(\hat{V}_\xi; \mathbf{Z})$ as in §4. Let ν be a homomorphism $H_1(\tilde{X}_K^\infty; \mathbf{Z}) \rightarrow \mathbf{Z}_k$.

Then we have

$$H_1(\hat{V}_\xi; \mathbf{Z}) \xrightarrow{\cong} H_1(V_\xi; \mathbf{Z}) \xrightarrow{\iota} H_1(\tilde{X}_K^\infty; \mathbf{Z}) \xrightarrow{\nu} \mathbf{Z}_k$$

Then we have $\nu \circ \iota \circ (\gamma^{-1}) : H_1(\hat{V}_\xi; \mathbf{Z}) \rightarrow \mathbf{Z}_k$. Take $\tilde{\eta}(\hat{V}_\xi, \nu \circ \iota \circ (\gamma^{-1})) \in \mathbf{Q}$. Let π be the natural projection $\mathbf{Q} \rightarrow \mathbf{Q}/\mathbf{Z}$. [15] [16] says that $\pi(\tilde{\eta}(\hat{V}_\xi, \nu \circ \iota \circ (\gamma^{-1})))$ is independent of the choice of V . We define $\tilde{\eta}(K, \nu) \in \mathbf{Q}/\mathbf{Z}$ to be $\pi(\tilde{\eta}(\hat{V}_\xi, \nu \circ \iota \circ (\gamma^{-1})))$.

Note. [4] [3][12] [5] etc. also apply the G-signature theorem and the η -invariants to n -knots ($n = 1, 2, 3, \dots$).

6 Proof of main results

Let X be $\overline{S^4 - N(K)}$. Let V be a Seifert hypersurface for K . Suppose V also denote $\overline{V - N(K)}$. Let $Y = X - V$. Let $V \times [-1, 1]$ be the tubular neighborhood of V in X . Suppose Y also denote $\overline{X - (V \times [-1, 1])}$.

Let \tilde{X}_K^∞ be the canonical infinite cyclic covering space. There is the natural projection map $p : \tilde{X}_K^\infty \rightarrow X$. Let $p^{-1}(Y) = \amalg_{-\infty}^{\infty} Y_i$. Let $p^{-1}(V) = \amalg_{-\infty}^{\infty} V_i$. Let $p^{-1}(V \times [-1, 1]) = \amalg_{-\infty}^{\infty} (V_i \times [-1, 1])$. Let $\partial Y_i = (V_{i-1} \times \{1\}) \amalg (V_i \times \{-1\})$.

There is the Meyer-Vietoris exact sequences of \mathbf{Z} -homology groups:

$$\begin{array}{c} H_i(V \times \{-1, 1\}; \mathbf{Z}) \\ \downarrow f_i \\ H_i(V \times [-1, 1]; \mathbf{Z}) \oplus H_i(Y; \mathbf{Z}) \\ \downarrow g_i \\ H_i(X; \mathbf{Z}) \end{array}$$

and

$$\begin{array}{c} \bigoplus_{j=-\infty}^{\infty} H_i(V_j \times \{-1, 1\}; \mathbf{Z}) \\ \downarrow \tilde{f}_i \\ (\bigoplus_{j=-\infty}^{\infty} H_i(V_j \times [-1, 1]; \mathbf{Z})) \oplus (\bigoplus_{j=-\infty}^{\infty} H_i(Y_j; \mathbf{Z})) \\ \downarrow \tilde{g}_i \\ H_i(\tilde{X}_K^{\infty}; \mathbf{Z}) \end{array}$$

Furthermore the second one is regarded as an exact sequence of $\mathbf{Z}[t, t^{-1}]$ -modules by using the covering translations.

Claim 6.1. *There is an exact sequence of $\mathbf{Z}[t, t^{-1}]$ -modules:*

$$\begin{array}{c} \bigoplus_{j=-\infty}^{\infty} \text{Tor}H_1(V_j \times \{-1, 1\}; \mathbf{Z}) \\ \downarrow \widetilde{f^{\text{tor}}} \\ (\bigoplus_{j=-\infty}^{\infty} \text{Tor}H_1(V_j \times [-1, 1]; \mathbf{Z})) \oplus (\bigoplus_{j=-\infty}^{\infty} \text{Tor}H_1(Y_j; \mathbf{Z})) \\ \downarrow \widetilde{g^{\text{tor}}} \\ \text{Tor}H_1(\tilde{X}_K^{\infty}; \mathbf{Z}) \\ \downarrow \\ 0 \end{array}$$

where $\widetilde{f^{\text{tor}}} = \tilde{f}_1|_{\bigoplus_{j=-\infty}^{\infty} \text{Tor}H_1(V_j \times \{-1, 1\}; \mathbf{Z})}$

and $\widetilde{g^{\text{tor}}} = \tilde{g}_1|_{(\bigoplus_{j=-\infty}^{\infty} \text{Tor}H_1(V_j \times [-1, 1]; \mathbf{Z})) \oplus (\bigoplus_{j=-\infty}^{\infty} \text{Tor}H_1(Y_j; \mathbf{Z}))}$.

Note. P.765 of [7] says that [8] proved $|\text{Tor}H_1(\tilde{X}_K^{\infty}; \mathbf{Z})| < \infty$.

Proof. By using the covering translations, we regard $\bigoplus_{j=-\infty}^{\infty} \text{Tor}H_1(V_j \times \{-1, 1\}; \mathbf{Z})$, $(\bigoplus_{j=-\infty}^{\infty} \text{Tor}H_1(V_j \times [-1, 1]; \mathbf{Z})) \oplus (\bigoplus_{j=-\infty}^{\infty} \text{Tor}H_1(Y_j; \mathbf{Z}))$, and $\text{Tor}H_1(\tilde{X}_K^{\infty}; \mathbf{Z})$ as $\mathbf{Z}[t, t^{-1}]$ -modules. Furthermore we regard $\widetilde{f^{\text{tor}}}$ and $\widetilde{g^{\text{tor}}}$ as homomorphisms of $\mathbf{Z}[t, t^{-1}]$ -modules.

Take V_{ξ} , ι as in §4. Theorem 7.3 of [7] and its proof essentially say that $\iota : \text{Tor}H_1(V_{\xi}) \rightarrow \text{Tor}H_1(\tilde{X}_K^{\infty})$ is onto. Note $\widetilde{g^{\text{tor}}}|_{\text{Tor}H_1(V_{\xi} \times [-1, 1])} = \iota$. Hence $\widetilde{g^{\text{tor}}}$ is onto. Therefore

$$\begin{array}{c} (\bigoplus_{j=-\infty}^{\infty} \text{Tor}H_1(V_j \times [-1, 1]; \mathbf{Z})) \oplus (\bigoplus_{j=-\infty}^{\infty} \text{Tor}H_1(Y_j; \mathbf{Z})) \\ \downarrow \widetilde{g^{\text{tor}}} \\ \text{Tor}H_1(\tilde{X}_K^{\infty}; \mathbf{Z}) \end{array}$$

$$\begin{array}{c} \downarrow \\ 0 \end{array}$$

is exact.

Let $x \in (\oplus_{j=-\infty}^{\infty} \text{Tor}H_1(V_j \times [-1, 1]; \mathbf{Z})) \oplus (\oplus_{j=-\infty}^{\infty} \text{Tor}H_1(Y_j; \mathbf{Z}))$ such that $\widetilde{g^{\text{tor}}}(x) = 0$. Then there is $y \in \oplus_{j=-\infty}^{\infty} \text{Tor}H_1(V_j \times \{-1, 1\}; \mathbf{Z})$ such that $\widetilde{f}_1(y) = x$. Let n be the order of x . Then $\widetilde{f}_1(n \cdot y) = n \cdot x = 0$. We prove that $y \in \oplus_{j=-\infty}^{\infty} \text{Tor}H_1(V_j \times \{-1, 1\}; \mathbf{Z})$ in the following paragraphs.

There is the Meyer-Vietoris exact sequences of \mathbf{Q} -homology groups:
(1)

$$\begin{array}{c} H_i(V \times \{-1, 1\}; \mathbf{Q}) \\ \downarrow f_i^{\mathbf{Q}} \\ H_i(V \times [-1, 1]; \mathbf{Q}) \oplus H_i(Y; \mathbf{Q}) \\ \downarrow g_i^{\mathbf{Q}} \\ H_i(X; \mathbf{Q}) \end{array}$$

and
(2)

$$\begin{array}{c} \oplus_{j=-\infty}^{\infty} H_i(V_j \times \{-1, 1\}; \mathbf{Q}) \\ \downarrow \widetilde{f}_i^{\mathbf{Q}} \\ (\oplus_{j=-\infty}^{\infty} H_i(V_j \times [-1, 1]; \mathbf{Q})) \oplus (\oplus_{j=-\infty}^{\infty} H_i(Y_j; \mathbf{Q})) \\ \downarrow \widetilde{g}_i^{\mathbf{Q}} \\ H_i(\widetilde{X}_K^{\infty}; \mathbf{Q}) \end{array}$$

By using $H_i(X; \mathbf{Q}) \cong H_i(S^1; \mathbf{Q})$ and the sequence (1),

$f_1^{\mathbf{Q}} : H_1(V \times \{-1, 1\}; \mathbf{Q}) \rightarrow H_1(V \times [-1, 1]; \mathbf{Q}) \oplus H_1(Y; \mathbf{Q})$ is isomorphism.

Let $\pi_V : H_1(V \times [-1, 1]; \mathbf{Q}) \oplus H_1(Y; \mathbf{Q}) \rightarrow H_1(V \times [-1, 1]; \mathbf{Q})$ be the natural projection. Let $\pi_Y : H_1(V \times [-1, 1]; \mathbf{Q}) \oplus H_1(Y; \mathbf{Q}) \rightarrow H_1(Y; \mathbf{Q})$ be the natural projection. Suppose that the identity matrix E represents

$\pi_V \circ \{f_1^{\mathbf{Q}}|_{H_1(V \times \{1\}; \mathbf{Q})}\} : H_1(V \times \{1\}; \mathbf{Q}) \rightarrow H_1(V \times [-1, 1]; \mathbf{Q})$,
the identity matrix E represents

$\pi_V \circ \{f_1^{\mathbf{Q}}|_{H_1(V \times \{-1\}; \mathbf{Q})}\} : H_1(V \times \{-1\}; \mathbf{Q}) \rightarrow H_1(V \times [-1, 1]; \mathbf{Q})$,
a matrix A represents

$\pi_Y \circ \{f_1^{\mathbf{Q}}|_{H_1(V \times \{1\}; \mathbf{Q})}\} : H_1(V \times \{1\}; \mathbf{Q}) \rightarrow H_1(Y; \mathbf{Q})$, and
a matrix B represents

$\pi_Y \circ \{f_1^{\mathbf{Q}}|_{H_1(V \times \{-1\}; \mathbf{Q})}\} : H_1(V \times \{-1\}; \mathbf{Q}) \rightarrow H_1(Y; \mathbf{Q})$.

Then $f_1^{\mathbf{Q}} : H_1(V \times \{-1, 1\}; \mathbf{Q}) \rightarrow H_1(V \times [-1, 1]; \mathbf{Q}) \oplus H_1(Y; \mathbf{Q})$ is represented

by

$$P = \begin{pmatrix} E & A \\ E & B \end{pmatrix}.$$

Since $H_i(X; \mathbf{Q}) \cong H_i(S^1; \mathbf{Q})$, $\det P \neq 0$.

We regard $H_i(V_j \times \{-1, 1\}; \mathbf{Q})$, $\oplus_{j=-\infty}^{\infty} H_i(V_j \times [-1, 1]; \mathbf{Q})$, and $\oplus_{j=-\infty}^{\infty} H_i(Y_j; \mathbf{Q})$

as $\mathbf{Q}[t, t^{-1}]$ -modules by using the covering translations. Then $\widetilde{f}_1^{\mathbf{Q}}$ is represented by

$$P(t) = \begin{pmatrix} E & t \cdot A \\ E & B \end{pmatrix}.$$

Note $P(1) = P$. Then $\det P(1) = \det P \neq 0$. Hence $\det P(t) \neq 0$. Hence f_1^Q is injective. Hence we have:

if an element $z \in \bigoplus_{j=-\infty}^{\infty} H_1(V_j \times \{-1, 1\}; \mathbf{Z})$

generates $\mathbf{Z} \subset \bigoplus_{j=-\infty}^{\infty} H_1(V_j \times \{-1, 1\}; \mathbf{Z})$, $f_1(z) \neq 0$. Hence we have:

if $y \in \bigoplus_{j=-\infty}^{\infty} H_1(V_j \times \{-1, 1\}; \mathbf{Z})$

generates $\mathbf{Z} \subset \bigoplus_{j=-\infty}^{\infty} H_1(V_j \times \{-1, 1\}; \mathbf{Z})$, $f_1(n \cdot y) \neq 0$. Therefore

$y \in \bigoplus_{j=-\infty}^{\infty} \text{Tor} H_1(V_j \times \{-1, 1\}; \mathbf{Z})$. Therefore

$$\begin{aligned} & \bigoplus_{j=-\infty}^{\infty} \text{Tor}\{H_1(V_j \times \{-1, 1\}; \mathbf{Z})\} \\ & \quad \downarrow \widetilde{f^{\text{tor}}} \\ & (\bigoplus_{j=-\infty}^{\infty} \text{Tor}\{H_1(V_j \times \{-1, 1\}; \mathbf{Z})\}) \oplus (\bigoplus_{j=-\infty}^{\infty} \text{Tor}\{H_1(Y_j; \mathbf{Z})\}) \\ & \quad \downarrow \widetilde{g^{\text{tor}}} \\ & \text{Tor}\{H_1(\widetilde{X}_K^{\infty}; \mathbf{Z})\} \end{aligned}$$

is exact. This completes the proof of Claim 6.1.

In order to prove our main theorems, we use the (1,2)-pass-moves for 2-knots. See [13] for the (1,2)-pass-moves for 2-knots for detail.

Definition 6.2. Let K_1 and K_2 be 2-knots in S^4 . We say that K_2 is obtained from K_1 by one (1,2)-pass-move if there is a 4-ball $B \subset S^4$ with the following properties. We draw B as in Definition 1.1.

(1) $K_1 - (B \cap K_1) = K_2 - (B \cap K_2)$.

This diffeomorphism map is orientation preserving.

(2) $B \cap K_1$ is drawn as in Figure 6.1. $B \cap K_2$ is drawn as in Figure 6.2.

Figure 6.1.

Figure 6.2.

The orientation of the two discs in the Figure 6.1 (resp. Figure 6.2) is compatible with the orientation which is determined naturally by the (x, y) -arrows in the Figure. We do not assume which the orientations of the annuli in the Figures are.

Suppose that K_2 is obtained from K_1 by one (1,2)-pass-move and that K'_2 is equivalent to K_2 . Then we also say that K'_2 is obtained from K_1 by one (1,2)-pass-move.

If K_1 is obtained from K_2 by one (1,2)-pass-move, then we also say that K_2 is obtained from K_1 by one (1,2)-pass-move.

2-knots K_1 and K_2 are said to be (1,2)-pass-move equivalent if there are 2-knots $\bar{K}_1 = \bar{K}_1, \bar{K}_2, \dots, \bar{K}_{p-1}, \bar{K}_p = K_2$ ($p \in \mathbf{N}, p \geq 2$) such that \bar{K}_i is obtained from \bar{K}_{i-1} ($1 < i \leq p$) by one (1,2)-pass-move.

In [13] we proved:

Theorem 6.3 ([13]) *Let K and K' be 2-knots. The following conditions (1) and (2) are equivalent.*

(1) K is (1,2)-pass-move equivalent to K' .

(2) K is ribbon-move equivalent to K' .

Let $K_<$ and $K_>$ be 2-knots. Suppose $K_<$ is ribbon-move equivalent to $K_>$. By Theorem 6.3, $K_<$ is (1,2)-pass-move equivalent to $K_>$.

In order to prove Theorem 2.1 it suffices to prove Theorem 2.1 when $K_<$ is obtained from $K_>$ by one (1,2)-pass-move in a 4-ball $B \subset S^4$.

Claim. *There are Seifert hypersurfaces $V_>$ for $K_>$ and $V_<$ for $K_<$ such that:*

$$(1) V_> - (B \cap V_>) = V_< - (B \cap V_<).$$

This diffeomorphism map is orientation preserving.

(2) $B \cap V_>$ is drawn as in Figure 6.3. $B \cap V_<$ is drawn as in Figure 6.4.

Note. We draw B as in Definition 1.1. We draw $V_>$ and $V_<$ by the bold line. The fine line means ∂B .

$B \cap V_>$ (resp. $B \cap V_<$) is diffeomorphic to $(D^2 \times [2, 3]) \amalg (D^2 \times [0, 1])$. We can regard $(D^2 \times [0, 1])$ as a 3-dimensional 1-handle which is attached to ∂B . We can regard $(D^2 \times [2, 3])$ as a 3-dimensional 2-handle which is attached to ∂B .

$B \cap V_>$ has the following properties: $B_t \cap V_>$ is empty for $-1 \leq t < 0$ and $0.5 < t \leq 1$. $B_0 \cap V_>$ is diffeomorphic to $(D^2 \times [2, 3]) \amalg (D^2 \times [0, 0.3]) \amalg (D^2 \times [0.7, 1])$. $B_{0.5} \cap K_1$ is diffeomorphic to $(D^2 \times [0.3, 0.7])$. $B_t \cap V_>$ is diffeomorphic to $D^2 \amalg D^2$ for $0 < t < 0.5$.

$B \cap V_<$ has the following properties: $B_t \cap V_<$ is empty for $-1 \leq t < -0.5$ and $0 < t \leq 1$. $B_0 \cap V_<$ is diffeomorphic to $(D^2 \times [2, 3]) \amalg (D^2 \times [0, 0.3]) \amalg (D^2 \times [0.7, 1])$. $B_{-0.5} \cap V_<$ is diffeomorphic to $(D^2 \times [0.3, 0.7])$. $B_t \cap V_<$ is diffeomorphic to $D^2 \amalg D^2$ for $-0.5 < t < 0$.

Figure 6.3.

Figure 6.4.

Proof of Claim. Put $P = (\text{the 3-manifolds in Figure 6.3}) \cap (\partial B)$. Note $P = (\text{the 3-manifolds in Figure 6.4}) \cap (\partial B)$. Put $Q = K_> \cap (S^4 - \text{Int}B^4)$. Note $Q = K_< \cap (S^4 - \text{Int}B^4)$. By applying the following Proposition to $(P \cup Q)$ and $(S^4 - \text{Int}B^4)$ the above Claim holds.

By using the obstruction theory, we have the following proposition. (We can prove it by applying §III of [17]. We can also prove it by generalizing Theorem 2,3 in P.49,50 of [9].) The author gives a proof in the Appendix.

Proposition. *Let X be an oriented compact $(m + 2)$ -dimensional manifold. Let $\partial X \neq \emptyset$. Let M be an oriented closed m -dimensional manifold which is embedded in X . Let $M \cap \partial X \neq \emptyset$. Let $[M] = 0 \in H_m(X; \mathbf{Z})$. Then there is an oriented compact $(m + 1)$ -dimensional manifold P such that P is embedded in X and that $\partial P = X$.*

Let $V_<$ be a compact 3-manifold embedded in S^4 whose boundary is $S^2 \amalg S^2$ with the following properties.

- (1) $V_< - (B \cap V_<) = V_> - (B \cap V_>) = V_< - (B \cap V_<)$.
- (2) $B \cap V_< \subset B_0$. We draw $B \cap V_<$ as in Figure 6.5.

Figure 6.5.

Let $N(\partial V_<)$ be the tubular neighborhood of $\partial V_<$ in S^4 . Let $X = \overline{S^4 - N(\partial V_<)}$. Let $V_<$ also denote $\overline{V_< \cap X}$. Let $V_< \times [-1, 1]$ be the tubular neighborhood of $V_<$ in X . Let $Y_< = \overline{X - (V_< \times [-1, 1])}$.

Suppose the following maps are inclusion. ($\varepsilon = -1, 1$.) The following two diagrams are commutative.

$$\begin{array}{ccc} V_< \times \{\varepsilon\} & \longleftarrow & V_< \times \{\varepsilon\} \\ \downarrow & & \downarrow \\ Y_< & \longrightarrow & Y_< \\ & & \\ & & V_< \times \{\varepsilon\} \longrightarrow V_> \times \{\varepsilon\} \\ & & \downarrow \quad \downarrow^{\alpha_>} \\ & & Y_< \longleftarrow Y_> \end{array}$$

By the definition of $V_{>}$, $H_1(X; \mathbf{Z}) = \mathbf{Z} \oplus \mathbf{Z}$. Let $f : \pi_1 X \rightarrow \mathbf{Z}$ be an epimorphism. Then f induces a smooth map $\bar{f} : X \rightarrow S^1$. Let $q \in S^1$ be a regular value of \bar{f} . Suppose $\bar{f}^{-1}(q) = V_{>}$. Take the covering space \tilde{X} of X associated with \bar{f} . Let $\tilde{f} : \tilde{X} \rightarrow X$ be the projection map. Put $\amalg_{j=-\infty}^{\infty} V_{>,j} = \tilde{f}^{-1}(V_{>})$. Put $\amalg_{j=-\infty}^{\infty} Y_{>,j} = \tilde{f}^{-1}(Y_{>})$. Let $\amalg_{j=-\infty}^{\infty} (V_{>,j} \times [-1, 1]) = \tilde{f}^{-1}(V_{>} \times [-1, 1])$. Suppose $\partial Y_{>,j} = (V_{>,j-1} \times \{1\}) \amalg (V_{>,j} \times \{-1\})$.

Take $V_{>,j}$, $V_{<,j}$, $\tilde{X}_{K_{>}}^{\infty}$, $\tilde{X}_{K_{<}}^{\infty}$ as in §4. Suppose the following maps are inclusion. By the above commutative diagrams, the following diagrams are commutative.

$$\begin{array}{ccc} V_{<,j} \times \{\varepsilon\} & \longleftarrow & V_{>,j} \times \{\varepsilon\} \\ \downarrow & & \downarrow \\ Y_{<,j} & \longrightarrow & Y_{>,j} \\ & & \downarrow \\ & & V_{>,j} \times \{\varepsilon\} \longrightarrow V_{<,j} \times \{\varepsilon\} \\ & & \downarrow \\ & & Y_{>,j} \longleftarrow Y_{<,j} \end{array}$$

By the definition of $V_{>}$, $V_{<}$, and $V_{>}$, it holds that $V_{>}$ (resp. $V_{<}$) is obtained from $V_{>}$ by attaching one 1-handle. By the definition of $Y_{>}$, $Y_{<}$, and $Y_{>}$, it holds that $Y_{>}$ is obtained from $Y_{>}$ (resp. $Y_{<}$) by attaching one 3-handle. Hence the above commutative diagrams induce the following commutative diagram ($\varepsilon = -1, 1$).

$$\begin{array}{ccccc} \text{Tor}H_1(V_{<,j} \times \{\varepsilon\}; \mathbf{Z}) & \xrightarrow{\beta_{<,j}^{\cong}} & \text{Tor}H_1(V_{>,j} \times \{\varepsilon\}; \mathbf{Z}) & \xrightarrow{\beta_{>,j}^{\cong}} & \text{Tor}H_1(V_{>,j} \times \{\varepsilon\}; \mathbf{Z}) \\ \downarrow \alpha_{<,j} & & \downarrow \alpha_{>,j} & & \downarrow \alpha_{>,j} \\ \text{Tor}H_1(Y_{<,j}; \mathbf{Z}) & \xrightarrow{\gamma_{<,j}^{\cong}} & \text{Tor}H_1(Y_{>,j}; \mathbf{Z}) & \xrightarrow{\gamma_{>,j}^{\cong}} & \text{Tor}H_1(Y_{>,j}; \mathbf{Z}) \end{array}$$

The above commutative diagram induces the following commutative diagram of \mathbf{Z} -homology groups:

$$\begin{array}{ccccc} \oplus_{-\infty}^{\infty} \text{Tor}H_1(V_{<,j} \times \{-1, 1\}) & \xrightarrow{\beta_{<,j}^{\cong}} & \oplus_{-\infty}^{\infty} \text{Tor}H_1(V_{>,j} \times \{-1, 1\}) & \xrightarrow{\beta_{>,j}^{\cong}} & \oplus_{-\infty}^{\infty} \text{Tor}H_1(V_{>,j} \times \{-1, 1\}) \\ \downarrow f_{<} & & \downarrow f_{>} & & \downarrow f_{>} \\ \left\{ \begin{array}{c} \oplus_{-\infty}^{\infty} \text{Tor}H_1(V_{<,j} \times [-1, 1]) \\ \oplus \\ \oplus_{-\infty}^{\infty} \text{Tor}H_1(Y_{<,j}) \end{array} \right\} & \xrightarrow{\gamma_{<,j}^{\cong}} & \left\{ \begin{array}{c} \oplus_{-\infty}^{\infty} \text{Tor}H_1(V_{>,j} \times [-1, 1]) \\ \oplus \\ \oplus_{-\infty}^{\infty} \text{Tor}H_1(Y_{>,j}) \end{array} \right\} & \xrightarrow{\gamma_{>,j}^{\cong}} & \left\{ \begin{array}{c} \oplus_{-\infty}^{\infty} \text{Tor}H_1(V_{>,j} \times [-1, 1]) \\ \oplus \\ \oplus_{-\infty}^{\infty} \text{Tor}H_1(Y_{>,j}) \end{array} \right\} \end{array}$$

By using the covering translations, the above commutative diagram is regarded as that of $\mathbf{Z}[t, t^{-1}]$ -modules. By Claim 6.3, we have exact sequences of $\mathbf{Z}[t, t^{-1}]$ -modules.

$$\begin{array}{ccc} \oplus_{-\infty}^{\infty} \text{Tor}H_1(V_{<,j} \times \{-1, 1\}) & & \oplus_{-\infty}^{\infty} \text{Tor}H_1(V_{>,j} \times \{-1, 1\}) \\ \downarrow f_{<} & & \downarrow f_{>} \\ \oplus_{-\infty}^{\infty} \left(\begin{array}{c} \text{Tor}H_1(V_{<,j} \times [-1, 1]) \\ \oplus \\ \text{Tor}H_1(Y_{<,j}) \end{array} \right) & \text{and} & \oplus_{-\infty}^{\infty} \left(\begin{array}{c} \text{Tor}H_1(V_{>,j} \times [-1, 1]) \\ \oplus \\ \text{Tor}H_1(Y_{>,j}) \end{array} \right) \\ \downarrow g_{<} & & \downarrow g_{>} \\ \text{Tor}H_1(\tilde{X}_{K_{<}}^{\infty}) & & \text{Tor}H_1(\tilde{X}_{K_{>}}^{\infty}) \\ \downarrow & & \downarrow \\ 0 & & 0 \end{array}$$

Therefore we have the following commutative diagram of $\mathbf{Z}[t, t^{-1}]$ -modules.

$$\begin{array}{ccc}
\oplus_{-\infty}^{\infty} \text{Tor}H_1(V_{<,j} \times \{-1,1\}) & \xrightarrow{a, \cong} & \oplus_{-\infty}^{\infty} \text{Tor}H_1(V_{>,j} \times \{-1,1\}) \\
\downarrow f_{<} & & \downarrow f_{>} \\
\oplus_{-\infty}^{\infty} \left(\begin{array}{c} \text{Tor}H_1(V_{<,j} \times [-1,1]) \\ \oplus \\ \text{Tor}H_1(Y_{<,j}) \end{array} \right) & \xrightarrow{b, \cong} & \oplus_{-\infty}^{\infty} \left(\begin{array}{c} \text{Tor}H_1(V_{>,j} \times [-1,1]) \\ \oplus \\ \text{Tor}H_1(Y_{>,j}) \end{array} \right) \\
\downarrow g_{>} & & \downarrow g_{>} \\
\text{Tor}H_1(\tilde{X}_{K_{<}}^{\infty}) & \xrightarrow{c, \cong} & \text{Tor}H_1(\tilde{X}_{K_{>}}^{\infty}) \\
\downarrow & & \downarrow \\
0 & & 0
\end{array}$$

In particular, $\text{Tor}H_1(\tilde{X}_{K_{<}}^{\infty}) \cong \text{Tor}H_1(\tilde{X}_{K_{>}}^{\infty})$ as $\mathbf{Z}[t, t^{-1}]$ -module. This completes the proof of Theorem 2.1.(1).

Take $V_{<,\xi}, V_{>,\xi}$ as in §4. Then there is an orientation preserving diffeomorphism $h : V_{<,\xi} \rightarrow V_{>,\xi}$ with the following properties.

(1) The following diagram is commutative

$$\begin{array}{ccc}
V_{<,\xi} & \xrightarrow{h} & V_{>,\xi} \\
& \nwarrow & \nearrow \\
& V_{\sim,\xi} &
\end{array}$$

where \nwarrow and \nearrow are inclusion.

(2) $h_* = b|_{\text{Tor}H_1(V_{<,\xi}; \mathbf{Z})} : \text{Tor}H_1(V_{<,\xi}; \mathbf{Z}) \xrightarrow{\cong} \text{Tor}H_1(V_{>,\xi}; \mathbf{Z})$.

Theorem 7.3 of [Farber] and its proof essentially say that

$\text{Tor}H_1(V_{<,\xi}; \mathbf{Z}) \xrightarrow{\iota_{<}} \text{Tor}H_1(\tilde{X}_{K_{<}}^{\infty}; \mathbf{Z})$ and $\text{Tor}H_1(V_{>,\xi}; \mathbf{Z}) \xrightarrow{\iota_{>}} \text{Tor}H_1(\tilde{X}_{K_{>}}^{\infty}; \mathbf{Z})$ are onto. Hence there are the following commutative diagram:

$$\begin{array}{ccc}
\text{Tor}H_1(V_{<,\xi}; \mathbf{Z}) & \xrightarrow{h_*, \cong} & \text{Tor}H_1(V_{>,\xi}; \mathbf{Z}) \\
\downarrow \iota_{<, \cong} & & \downarrow \iota_{>, \cong} \\
\text{Tor}H_1(\tilde{X}_{K_{<}}^{\infty}; \mathbf{Z}) & \xrightarrow{c, \cong} & \text{Tor}H_1(\tilde{X}_{K_{>}}^{\infty}; \mathbf{Z})
\end{array}$$

We can define $\text{lk}(\quad, \quad)$ of $K_{\#}$ by using $V_{\#, \xi}$ ($\# = <, >$).

Let $! = a, b$. Let $x_! \in \text{Tor}H_1(\tilde{X}_{K_{<}}^{\infty}; \mathbf{Z})$. Then there is $x'_! \in \text{Tor}H_1(V_{<,\xi}; \mathbf{Z})$ such that $\iota_{<}(x'_!) = x_!$. Then $\iota_{>} \circ h(x'_!) = c(x'_!)$. Therefore

$$\begin{aligned}
& \text{lk}(x_a, x_b) \text{ for } K_{<} \\
& = \text{lk}(x'_a, x'_b) \text{ for } \hat{V}_{<,\xi} \text{ (}\hat{V}_{<,\xi} \text{ is defined for } V_{<,\xi} \text{ as in §4.)} \\
& = \text{lk}(h(x'_a), h(x'_b)) \text{ for } \hat{V}_{>,\xi} \text{ (}\hat{V}_{>,\xi} \text{ is defined for } V_{>,\xi} \text{ as in §4.)} \\
& = \text{lk}(\iota_{>} \circ h(x'_a), \iota_{>} \circ h(x'_b)) \text{ for } K_{>} \\
& = \text{lk}(c(x'_a), c(x'_b)) \text{ for } K_{>}
\end{aligned}$$

Therefore the Farber-Levine pairing for $K_{>}$ coincides with that for $K_{<}$. This completes the proof of Theorem 2.1.(2).

We next prove Theorem 2.2. Let ν be a homomorphism $H_1(\tilde{X}_K^{\infty}; \mathbf{Z}) \rightarrow \mathbf{Z}_{\mathbf{d}}$. We consider $\tilde{\eta}(K, \nu)$. Suppose K is ribbon-move equivalent to the trivial 2-knot. Take ι and γ as in §5. Then we have the following commutative diagram.

$$\begin{array}{ccc}
H_1(\tilde{X}_K^{\infty}; \mathbf{Z}) & \xrightarrow{\nu} & \mathbf{Z}_{\mathbf{d}} \\
\uparrow \iota \circ (\gamma^{-1}) & \nearrow & \\
H_1(\hat{V}_{\xi}; \mathbf{Z}) & &
\end{array}$$

By Theorem 2.1.(1), $H_1(\tilde{X}_K^{\infty}; \mathbf{Z}) \cong \mathbf{Z} \oplus \dots \oplus \mathbf{Z}$. Hence

$$\begin{array}{ccc} \mathbf{Z} \oplus \dots \oplus \mathbf{Z} & \xrightarrow{\nu} & \mathbf{Z}_{\mathbf{d}} \\ \uparrow_{\iota \circ (\gamma^{-1})} & \nearrow & \\ H_1(\hat{V}_\xi; \mathbf{Z}) & & \end{array}$$

By an elementary discussion on homomorphisms, we have:

$$\begin{array}{ccc} \mathbf{Z} & \xrightarrow{\nu'} & \mathbf{Z}_{\mathbf{d}} \\ \uparrow_{\zeta} & \nearrow & \\ H_1(\hat{V}_\xi; \mathbf{Z}) & & \end{array}$$

The above homomorphism $H_1(\hat{V}_\xi; \mathbf{Z}) \rightarrow \mathbf{Z}$ is called ζ . Then $\nu' \circ \zeta = \nu \circ \iota \circ (\gamma^{-1})$. Then we can regard

$$\begin{aligned} \zeta &\in \text{Hom}(H_1(\hat{V}_\xi; \mathbf{Z}), \mathbf{Z}) \cong H^1(\hat{V}_\xi; \mathbf{Z}) \\ &\cong \{\text{homotopy classes of maps } \hat{V}_\xi \rightarrow K(\mathbf{Z}, 1)\} \\ \nu' \circ \zeta &\in \text{Hom}(H_1(\hat{V}_\xi; \mathbf{Z}), \mathbf{Z}_{\mathbf{d}}) \cong H^1(\hat{V}_\xi; \mathbf{Z}_{\mathbf{d}}) \\ &\cong \{\text{homotopy classes of maps } \hat{V}_\xi \rightarrow K(\mathbf{Z}_{\mathbf{d}}, 1)\} \end{aligned}$$

The above diagram induces the following diagram.

$$\begin{array}{ccc} K(\mathbf{Z}, 1) & \xrightarrow{\nu'} & K(\mathbf{Z}_{\mathbf{d}}, 1) \\ \uparrow_{\zeta} & \nearrow & \\ \hat{V}_\xi & & \end{array}$$

The above diagram induces the following homomorphism.

$$\begin{array}{ccc} \Omega^3(K(\mathbf{Z}, 1)) & \xrightarrow{\nu'} & \Omega^3(K(\mathbf{Z}_{\mathbf{d}}, 1)) \\ \downarrow \Psi & & \downarrow \Psi \\ [(\hat{V}_\xi, \zeta)] & \mapsto & [(\hat{V}_\xi, \nu' \circ \zeta)] \end{array}$$

By bordism theory $\Omega^3(K(\mathbf{Z}, 1)) \cong \Omega^3(S^1) \cong 0$. Therefore $[(\hat{V}_\xi, \nu' \circ \zeta)] = 0$. Therefore $(\hat{V}_\xi, \nu' \circ \zeta) = \partial(W, \tau)$ for a compact oriented 4-manifold W . Hence $\tilde{\eta}(\hat{V}_\xi, \nu' \circ \zeta) = \frac{1}{2}(\bar{\sigma}(W, \tau) - \sigma(W))$. Hence $\tilde{\eta}(\hat{V}_\xi, \nu' \circ \zeta) \in \mathbf{Z}$. Hence $\tilde{\eta}(K, \nu) = \pi(\tilde{\eta}(\hat{V}_\xi, \nu' \circ \zeta)) = 0$. Therefore Theorem 2.2 holds.

References

- [1] Atiyah, Patodi and Singer: Spectral asymmetry and Riemannian geometry I, II, III *Math. Proc. Camb. Phil. Soc.* 1975
- [2] A. J. Casson and C. McA. Gordon: Cobordism of classical knots *Progress in Mathematics* 62, 1975
- [3] A. J. Casson and C. McA. Gordon: On slice knots in dimension three *Proceedings of Symposia in Pure Mathematics* 32, 1978
- [4] T.D.Cochran and K. E. Orr: Not all links are concordant to boundary links *Ann. of Math.*, 138, 519–554, 1993.
- [5] P.M.Gilmer and C.Livingston: The Casson-Gordon invariant and link concordance *Topology* 31, 475-492, 1992
- [6] P.E.Conner and Floyd: Differentiable periodic maps *Ergebnisse der Mathematik* 33, 1964
- [7] M.S.Farber: Duality in an infinite cyclic covering and even dimensional knot *Math. USSR Izv* 11, 749-782, 1978
- [8] M. Kervaire: Les noeuds de dimensions supérieures *Bull.Soc.Math.Fr.* 93, 225-271, 1965
- [9] Kirby: The topology of 4-manifolds *Lecture Notes in Math 1374 (Springer Verlag)* 1989
- [10] J. Levine: Polynomial invariants of knots of codimension two *Ann. of Math.* 84, 537-554, 1966
- [11] J. Levine: Knot modules I *Trans. Amer. Math. Soc.* 229, 1-50, 1977
- [12] J. Levine: Link invariants via the eta-invariant *Comment. Math. Helveticii* 69, 82-119, 1994
- [13] E. Ogasa: Ribbon moves of 2-links preserve the μ -invariants of 2-links *University of Tokyo Preprint series, UTMS 97-35* 1997
- [14] Rolfsen: Knots and links *Publish or Perish, Inc.* 1976
- [15] D. Ruberman: Doubly slice knots and the Casson-Gordon invariants *Trans. Amer. Math. Soc.* 279, 569-588, 1983
- [16] D. Ruberman: The Casson-Gordon invariants in high-dimensional knot theory *Trans. Amer. Math. Soc.* 306, 579-595, 1988
- [17] Steenrod: Topology of Fiber bundles *Ann. of Math. Studies 50 Princeton Univ. Press* 1951

Appendix

The author gives a proof of the following proposition.

Proposition. *Let X be an oriented compact $(m + 2)$ -dimensional manifold. Let $\partial X \neq \emptyset$. Let M be an oriented closed m -dimensional manifold which is embedded in X . Let $M \cap \partial X \neq \emptyset$. Let $[M] = 0 \in H_m(X; \mathbf{Z})$. Then there is an oriented compact $(m + 1)$ -dimensional manifold P such that P is embedded in X and that $\partial P = X$.*

Proof. Let ν be the normal bundle of M in X . By Theorem 2 in P.49 of [9] ν is a product bundle. By using ν and the collar neighborhood of ∂X in X , we can take a compact oriented $(m + 2)$ -manifold $N \subset X$ with the following properties.

- (1) $N \cong M \times D^2$. (Hence $\partial N = M \times S^1$.)
- (2) $N \cap \partial X = (\partial N) \cap (\partial X) = M \cap \partial X$. (Hence $(\text{Int}N) \cap \partial X = \emptyset$.)

Take $X - (\text{Int}N)$. (Note $X - (\text{Int}N) \supset \partial X$.) There is a cell decomposition:
 $X - (\text{Int}N)$

$$= (\partial N) \cup (\partial X) \cup (1\text{-cells } e^1) \cup (2\text{-cells } e^2) \cup (3\text{-cells } e^3) \cup (\text{one } 4\text{-cell } e^4).$$

We can suppose that this decomposition has only one 0-cell e^0 which is in $(\partial N) \cap (\partial X)$.

There is a continuous map $s_0 : (\partial N) \cup (\partial X) \rightarrow S^1$ with the following properties, where p is a point in S^1 .

- (1) $s_0(\partial X) = p$. (Hence $s_0((\partial N) \cap (\partial X)) = p$ and $s_0(e^0) = p$.)
- (2) $s_0|_{\partial N} : M \times S^1 \rightarrow S^1$ is a projection map $(x, y) \mapsto y$.

Let S_F^1 be a fiber of the S^1 -fiber bundle $\partial N = M \times S^1$. Since $[M] = 0 \in H_m(X; \mathbf{Z})$, $[S_F^1]$ generates $\mathbf{Z} \subset H_1(X - \text{Int}N, \partial X; \mathbf{Z})$. (We can prove as in the proof of Theorem 3 in P.50 of [9])

Let $f : H_1(X - \text{Int}N, \partial X; \mathbf{Z}) \rightarrow H_1(X - \text{Int}N, \partial X; \mathbf{Z})/\text{Tor}$ be the natural projection map. Let $\{f([S_F^1]), u_1, \dots, u_k\}$ be a set of basis of $H_1(X - \text{Int}N, \partial X; \mathbf{Z})/\text{Tor}$. Take a continuous map

$$s_1 : (\partial N) \cup (\partial X) \cup (1\text{-cells } e^1) \rightarrow S^1$$

with the following properties.

- (1) $s_1|_{(\partial N) \cup (\partial X)} = s_0$
- (2) $s_1|_{e^0 \cup e^1} : e^0 \cup e^1 \rightarrow S^1$ satisfies the following condition: If $f([e^0 \cup e^1]) = n_0 \cdot f([S_F^1]) + \sum_{j=1}^k n_j \cdot u_j \in H_1(X - \text{Int}N, \partial X; \mathbf{Z})/\text{Tor}$ ($n_* \in \mathbf{Z}$), then $\deg(s_1|_{e^0 \cup e^1}) = n_0$.

Note that, if a circle C is nul-homologous in $(\partial N) \cup (\partial X) \cup (1\text{-cells } e^1)$, then $\deg(s_1|_C) = 0$.

Claim. *There is a continuous map*

$$s_2 : (\partial N) \cup (\partial X) \cup (1\text{-cells } e^1) \cup (2\text{-cells } e^2) \rightarrow S^1$$

such that $s_2|_{(\partial N) \cup (\partial X) \cup (1\text{-cells } e^1)} = s_1$.

Proof. It is trivial that $[\partial e^2] = 0 \in H_1((\partial N) \cup (\partial X) \cup (1\text{-cells } e^1); \mathbf{Z})$. Hence $\deg(s_1|_{\partial e^2})$ is zero. Hence $s_1|_{\partial e^2}$ extends to e^2 . Hence the above Claim holds.

The continuous map s_2 extends to a continuous map $s : X - (\text{Int}N) \rightarrow S^1$ since $\pi_l(S^1) = 0$ ($l \geq 2$). We can suppose s is a smooth map.

Let $q \neq p$. Let q be a regular value. Hence $s^{-1}(q)$ be an oriented compact manifold. $\partial\{s^{-1}(q)\} \subset \{(\partial N) \cup \partial X\}$. Since $q \neq p$, $s^{-1}(q) \cap \partial X = \emptyset$. Hence $\partial\{s^{-1}(q)\} \subset \partial N$. Furthermore we have $s^{-1}(q) \cap \partial N = \partial\{s^{-1}(q)\} = M \times \{r\}$, where r is a point in S^1 . By using N and $s^{-1}(q)$, Proposition holds.

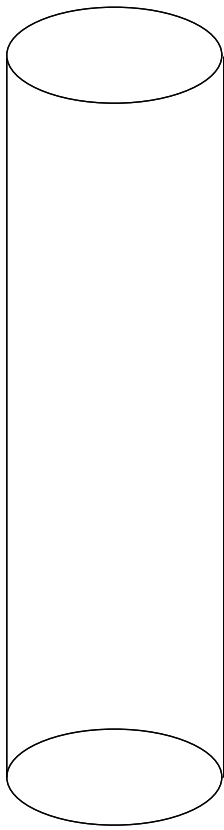

$t=-0.5$

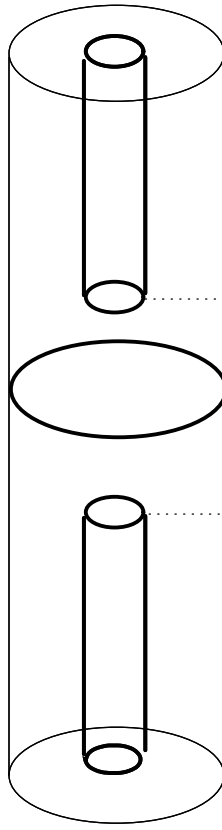

$t=0$

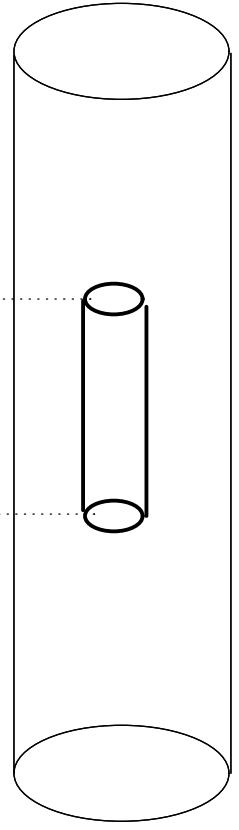

$t=0.5$

Figure 1.1

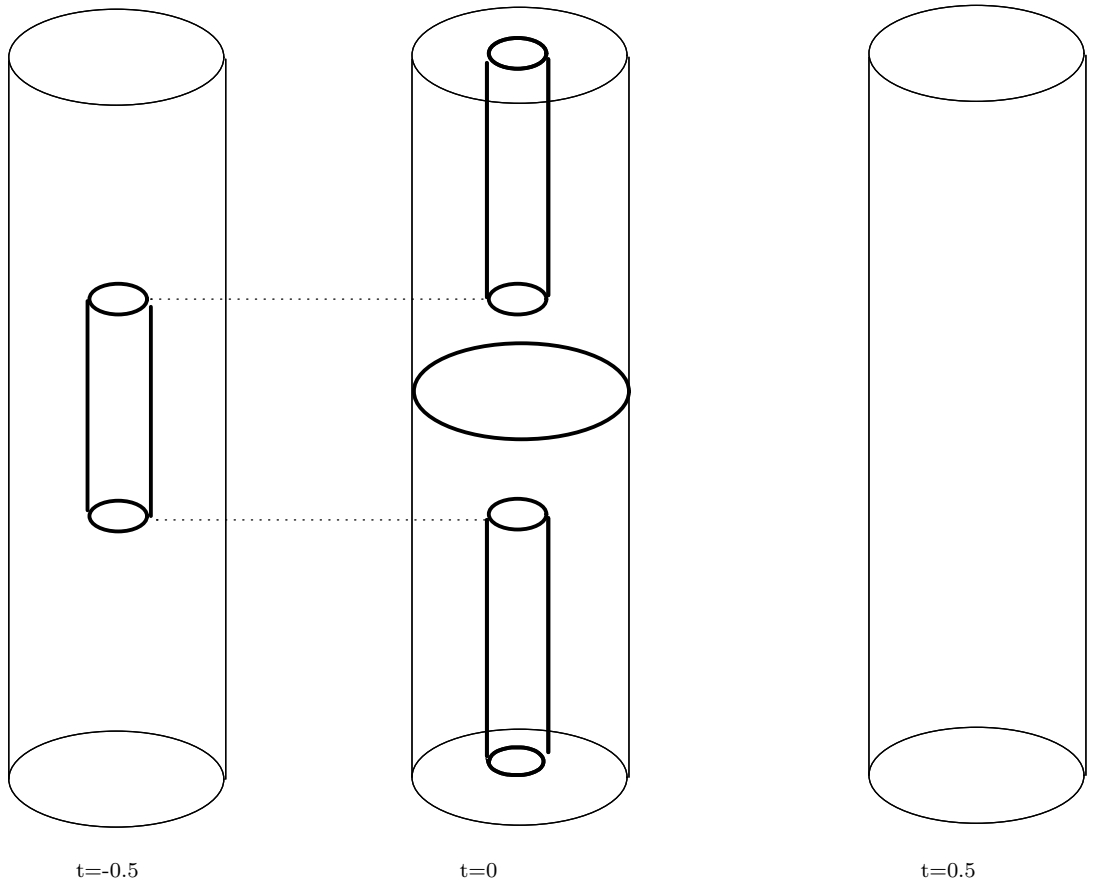
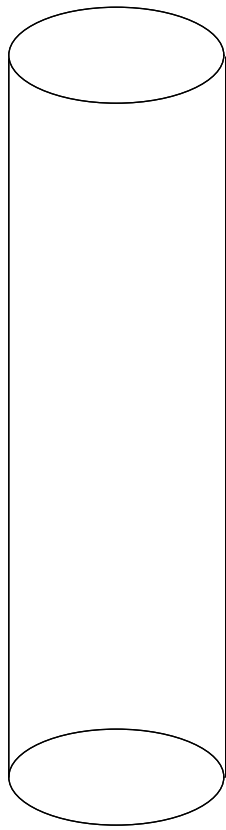
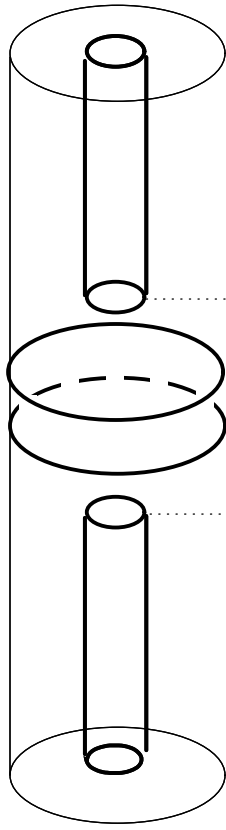

Figure 1.2



$t=-0.5$



$t=0$

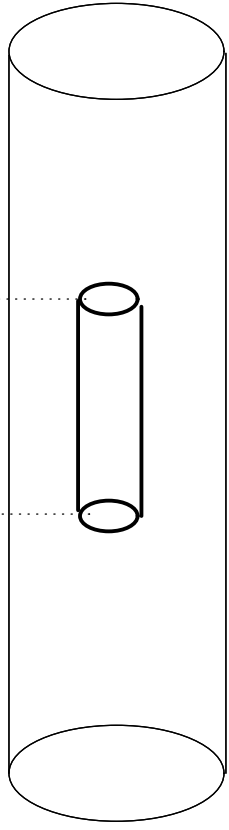

$t=0.5$

Figure 6.1

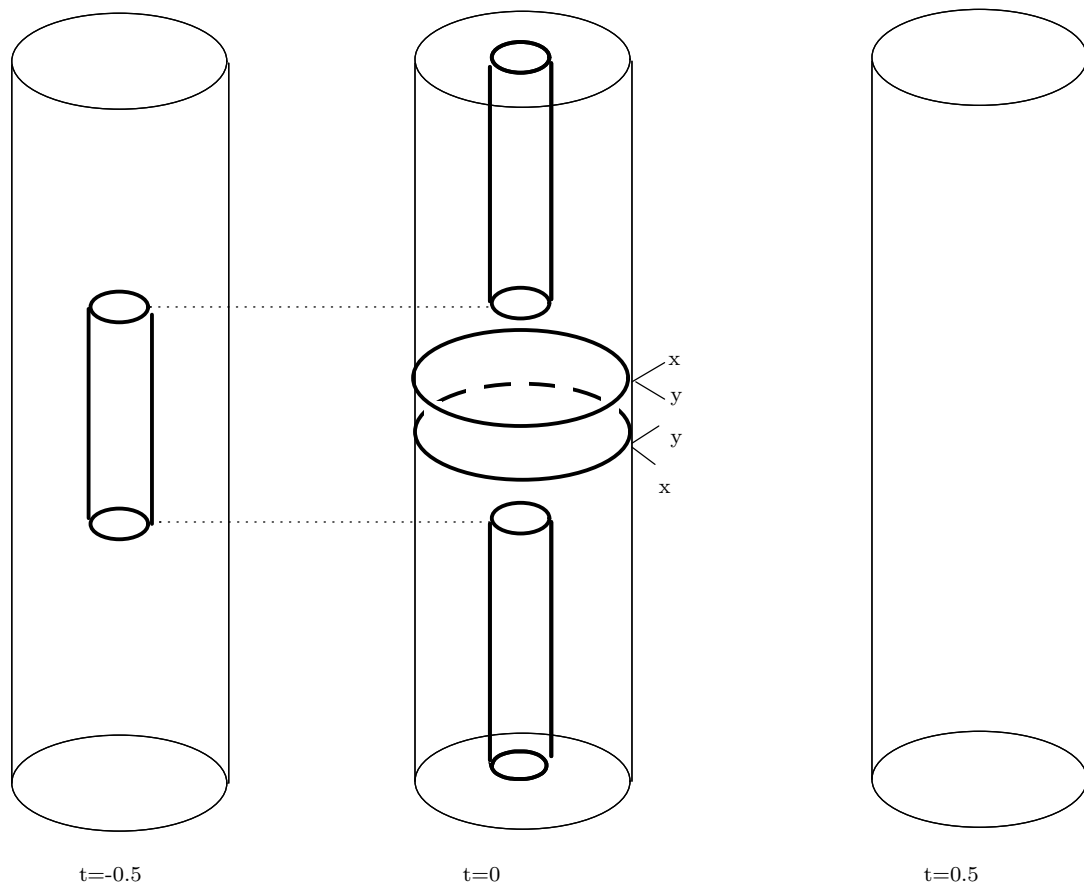
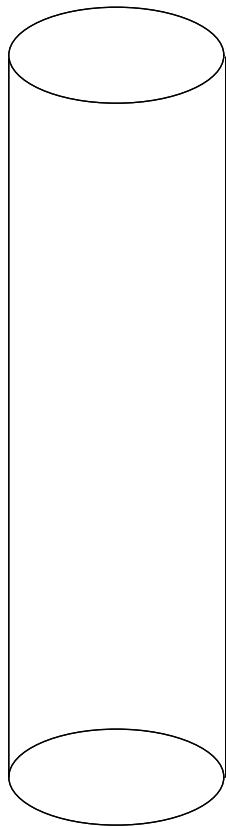
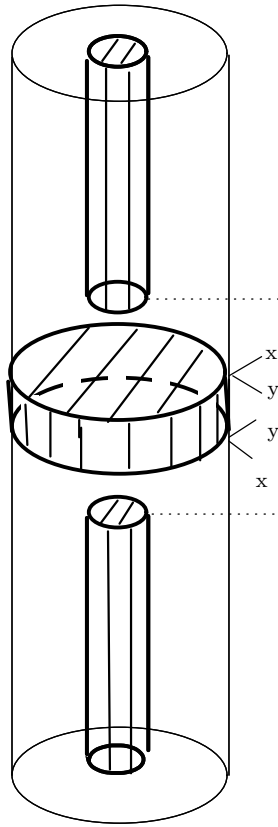

Figure 6.2



$t = -0.5$



$t = 0$

Figure 6.3

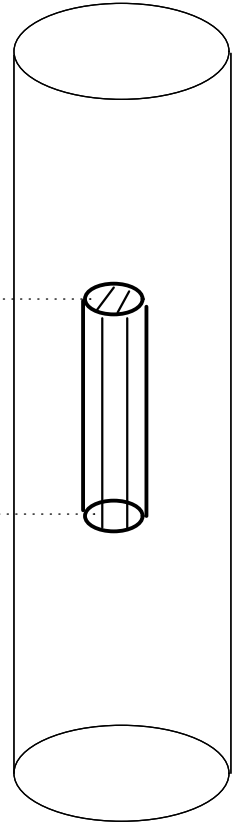

$t = 0.5$

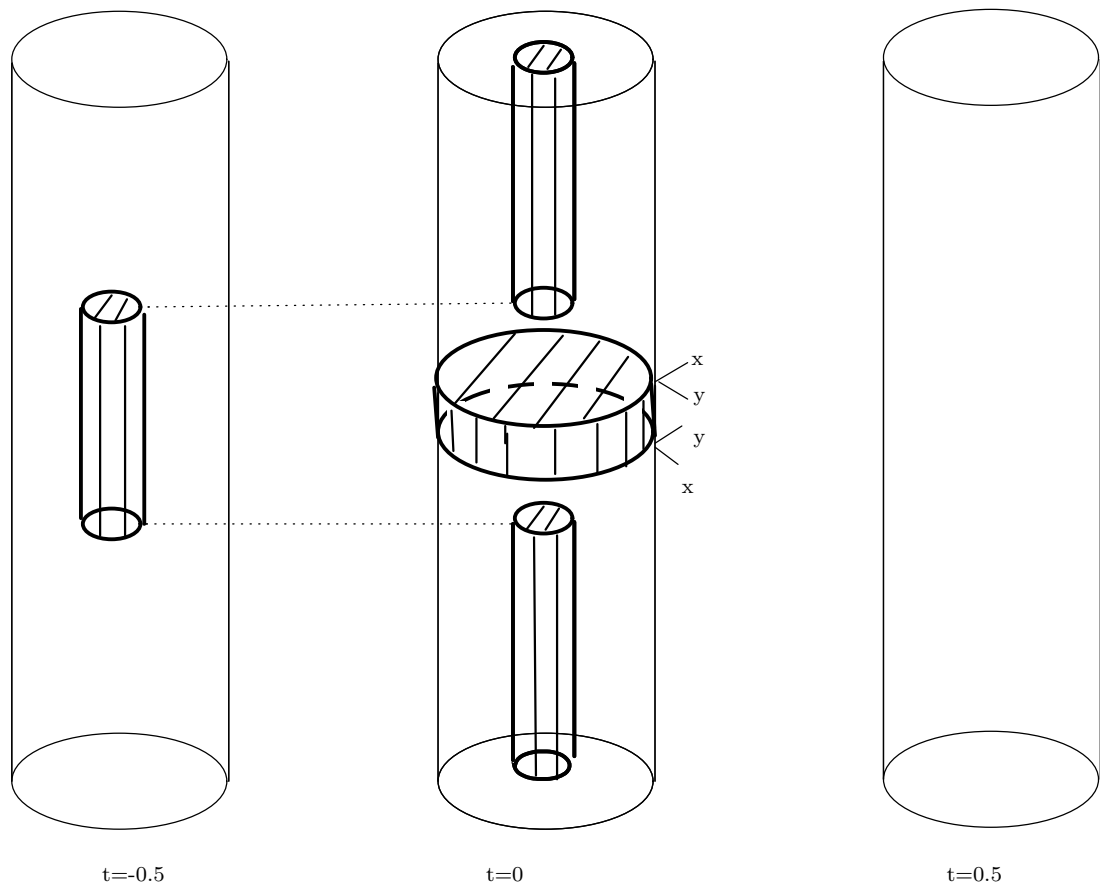
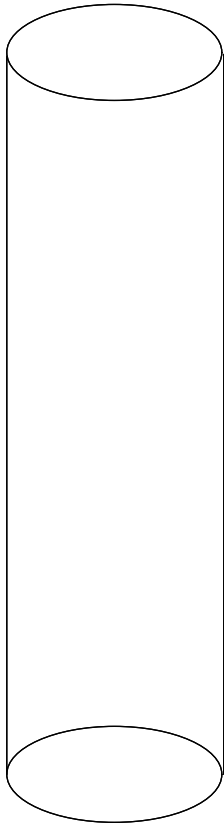
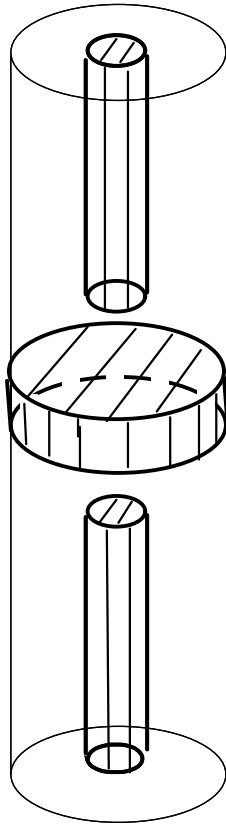

Figure 6.4



$t=-0.5$



$t=0$

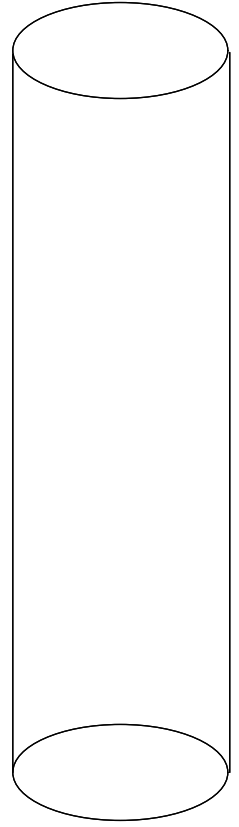

$t=0.5$

Figure 6.5