

# Seifert manifolds and $(1, 1)$ -knots

Luigi Grasselli      Michele Mulazzani

## Abstract

The aim of this paper is to investigate the relations between Seifert manifolds and  $(1, 1)$ -knots. In particular, we prove that every orientable Seifert manifold with invariants

$$\{Oo, 0 \mid -1; \underbrace{(p, q), \dots, (p, q)}_{n \text{ times}}, (l, l-1)\}$$

has the fundamental group cyclically presented by  $G_n((x_1^q \cdots x_n^q)^l x_n^{-p})$  and, moreover, it is the  $n$ -fold strongly-cyclic covering of the lens space  $L(|nlq-p|, q)$ , branched over the  $(1, 1)$ -knot  $K(q, q(nl-2), p-2q, p-q)$ , if  $p \geq 2q$ , and over the  $(1, 1)$ -knot  $K(p-q, 2q-p, q(nl-2), p-q)$ , if  $p < 2q$ .

*2000 Mathematics Subject Classification:* Primary 57M12, 57M25; Secondary 20F05, 57M05.

*Keywords:* Seifert manifolds,  $(1, 1)$ -knots, cyclic branched coverings, cyclically presented groups, Heegaard diagrams.

## 1 Introduction

Cyclic branched coverings of knots in  $\mathbf{S}^3$  with cyclically presented fundamental group have been deeply investigated in the recent years by many authors (see [1, 10, 11, 12, 17, 20, 21, 22, 23, 33]). Their results have been included in an organic and more general context in [24], where it is proved that the fundamental group of every  $n$ -fold strongly-cyclic branched covering of a  $(1, 1)$ -knot admits a cyclic presentation encoded by a genus  $n$  Heegaard diagram. In [5]

this result has been improved, obtaining a constructive algorithm which explicitly gives the cyclic presentation, starting from a representation of the  $(1, 1)$ -knot via the mapping class group of the twice punctured torus (see [6] for further details on this representation).

In [14], M. J. Dunwoody introduces a class of manifolds depending on six integers, the so-called Dunwoody manifolds, with cyclically presented fundamental groups. It is proved in [15] and [7] that the family of Dunwoody manifolds coincides with the family of strongly-cyclic coverings of lens spaces (possibly  $\mathbf{S}^3$ ), branched over  $(1, 1)$ -knots. As a consequence, any  $(1, 1)$ -knot can be represented by four integers  $a, b, c, r$ , and it will be denoted by  $K(a, b, c, r)$ .

In this paper we show that the orientable Seifert manifold with invariants

$$\{Oo, 0 \mid -1; \underbrace{(p, q), \dots, (p, q)}_{n \text{ times}}, (l, l - 1)\}$$

has the fundamental group isomorphic to the cyclically presented group  $G_n((x_1^q \cdots x_n^q)^l x_n^{-p})$ , and it is the  $n$ -fold strongly-cyclic covering of the lens space  $L(|nlq - p|, q)$ , branched over the  $(1, 1)$ -knot  $K(q, q(nl - 2), p - 2q, p - q)$ , if  $p \geq 2q$ , and over the  $(1, 1)$ -knot  $K(p - q, 2q - p, q(nl - 2), p - q)$ , if  $p < 2q$ .

## 2 Basic notions

A finite balanced presentation of a group  $\langle x_1, \dots, x_n \mid r_1, \dots, r_n \rangle$  is said to be a *cyclic presentation* if there exists a word  $w$  in the free group  $F_n$  generated by  $x_1, \dots, x_n$  such that  $r_k = \theta^{k-1}(w)$ ,  $k = 1, \dots, n$ , where  $\theta : F_n \rightarrow F_n$  denotes the automorphism defined by  $\theta(x_i) = x_{i+1}$  (subscripts mod  $n$ ),  $i = 1, \dots, n$ . This presentation (and the related group) will be denoted by  $G_n(w)$ . For further details see [18].

A knot  $K$  in a closed, connected, orientable 3-manifold  $N^3$  is called a  $(1, 1)$ -knot if there exists a Heegaard splitting of genus one  $(N^3, K) = (H, A) \cup_\varphi (H', A')$ , where  $H$  and  $H'$  are solid tori,  $A \subset H$  and  $A' \subset H'$  are properly embedded trivial arcs<sup>1</sup>, and  $\varphi : (\partial H', \partial A') \rightarrow (\partial H, \partial A)$  is an attaching homeomorphism (see Figure 1). Obviously,  $N^3$  turns out to be a lens space  $L(p, q)$ , including  $\mathbf{S}^3 = L(1, 0)$  and  $\mathbf{S}^2 \times \mathbf{S}^1 = L(0, 1)$ .

---

<sup>1</sup>This means that there exists a disk  $D \subset H$  (resp.  $D' \subset H'$ ) with  $A \cap D = A \cap \partial D = A$  and  $\partial D - A \subset \partial H$  (resp.  $A' \cap D' = A' \cap \partial D' = A'$  and  $\partial D' - A' \subset \partial H'$ ).

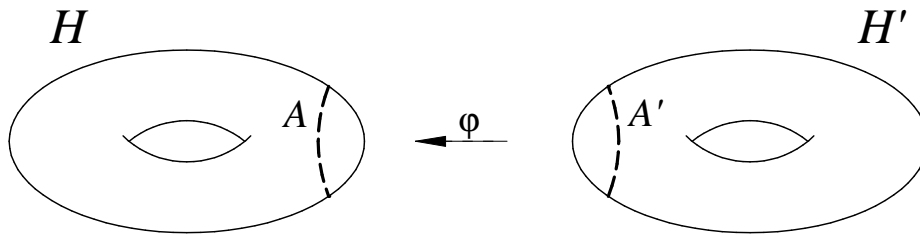

Figure 1: A  $(1, 1)$ -knot decomposition.

It is well known that the family of  $(1, 1)$ -knots contains all torus knots and all two-bridge knots in  $\mathbf{S}^3$ . Several topological properties of  $(1, 1)$ -knots have recently been investigated in many papers (see references in [6]).

An integer 4-parametric representation of  $(1, 1)$ -knots have been developed in [7] (see also [8]). Every  $(1, 1)$ -knot, with the only exception of the “core” knot  $\{P\} \times \mathbf{S}^1 \subset \mathbf{S}^2 \times \mathbf{S}^1$ , can be represented by four non-negative integers  $a, b, c, r$ , and the represented knot will be referred as  $K(a, b, c, r)$ .

A  $(1, 1)$ -knot  $K(a, b, c, r)$ , with  $a + b + c > 0$ , admits a natural  $(1, 1)$ -decomposition  $(H, A) \cup_{\varphi} (H', A')$  described by the genus one Heegaard diagram of Figure 2, where the labels  $a, b$  and  $c$  denote the correspondent number of parallel arcs, and the gluing between the circles  $C'$  and  $C''$  depends on the twist parameter  $r$  in such a way that equally labelled vertices are identified together (observe that  $r$  can be taken mod  $2a + b + c$ ).

As a simple consequence of Seifert-Van Kampen Theorem, the fundamental group of the exterior of a  $(1, 1)$ -knot (as well as its first homology group) is generated by the two loops  $\alpha, \gamma \subset \partial H$  depicted in Figure 3.

In the next section we need the following result.

**Lemma 1** (i) *If  $a$  and  $c$  are non-negative integers such that  $\gcd(a, c) = 1$ , then  $K(a, 0, c, a)$  is a  $(1, 1)$ -knot in the lens space  $L(c, a)$ .*

(ii) *If  $a, b, c$  are non-negative integers such that  $\gcd(a - c, b + c) = 1$ , then  $K(a, b, c, a)$  is a  $(1, 1)$ -knot in the lens space  $L(b + c, a + b)$ .*

(iii) *If  $a, b, c$  are non-negative integers such that  $a > 0$  and  $\gcd(a, b - c) = 1$ , then  $K(a, b, c, a + c)$  is a  $(1, 1)$ -knot in the lens space  $L(|b - c|, a)$ .*

**Proof.** As proved in [8],  $K(a, b, c, r)$  is equivalent to  $K(a, c, b, 2a + b + c - r)$  and  $K(a, 0, c, r)$  is equivalent to  $K(a, c, 0, r)$ . As a consequence,  $K(a, 0, c, r)$  is equivalent to  $K(a, 0, c, 2a + c - r)$ .

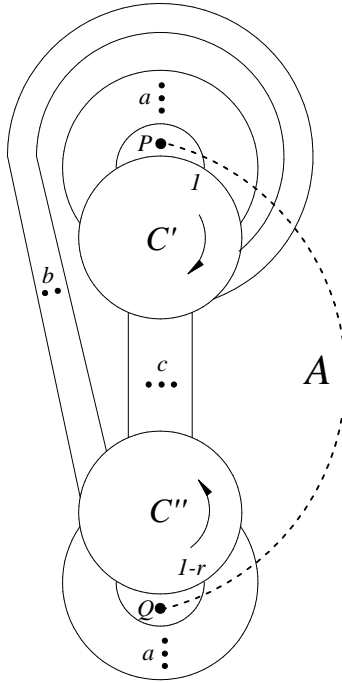

Figure 2: Heegaard diagram for  $K(a, b, c, r)$

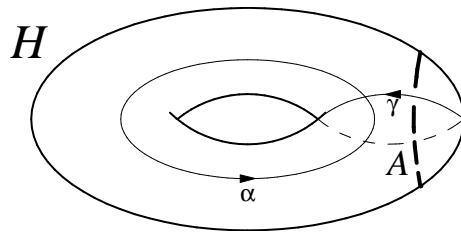

Figure 3:

(i) If  $a = 0$ , then  $c = 1$  and the result is straightforward. If  $0 < a < c$ , then applying the Singer move [29] of type IB depicted in Figure 4, we obtain the canonical Heegaard diagram of  $L(c, a)$ . If  $a \geq c$ , the Singer move depicted in Figure 5 transforms the diagram of  $K(a, 0, c, a)$  in the diagram of  $K(a - c, c, 0, a - c)$ , which is equivalent to  $K(a - c, 0, c, a - c)$ . Since  $L(c, a - c)$  is homeomorphic to  $L(c, a)$ , the result follows from the previous case  $a < c$ .

(ii) If  $b = 0$  the result follows from (i). If  $b > 0$ , by performing the Singer move of Figure 6, the diagram of  $K(a, b, c, a)$  becomes the diagram of  $K(a - 1, b + 1, c - 1, a - 1)$ . If  $a \leq c$ , after performing the move  $a$  times, we obtain the diagram of  $K(0, b + a, c - a, 0)$ , which is the canonical Heegaard diagram of  $L(b + c, a + b)$ , since  $\gcd(a + b, b + c) = \gcd(a - c, b + c) = 1$ . If  $a > c$ , after performing the move  $c$  times, we obtain the diagram of  $K(a - c, b + c, 0, a - c)$ , which is equivalent to  $K(a - c, 0, b + c, a - c)$ . Now the result follows from (i), since  $L(b + c, a - c)$  is homeomorphic to  $L(b + c, a + b)$ .

(iii) Since  $K(a, b, c, a + c)$  is equivalent to  $K(a, c, b, a + b)$ , we can always suppose  $c \leq b$ . If  $c > 0$ , then, by performing the Singer move of Figure 7, the diagram of  $K(a, b, c, a + c)$  becomes the diagram of  $K(a, b - 1, c - 1, a + c - 1)$ . After performing the move  $c$  times, we obtain the diagram of  $K(a, b - c, 0, a)$ , which is equivalent to  $K(a, 0, b - c, a)$ . The result now follows from (i). ■

Observe that, since  $K(a, b, c, a + b + c)$  is equivalent to  $K(a, c, b, a)$ ,  $K(a, b, c, a + b + c)$  is a  $(1, 1)$ -knot in the lens space  $L(b + c, a + c)$ , if  $\gcd(a - b, b + c) = 1$ .

An  $n$ -fold cyclic covering  $M^3$  of a 3-manifold  $N^3$ , branched over a knot  $K \subset N^3$ , is called *strongly-cyclic* if the branching index of  $K$  is  $n$ . This means that the fiber in  $M^3$  of each point of  $K$  consists of a single point. In this case, the homology class  $m$  of a meridian loop around  $K$  is mapped by the monodromy  $\omega : H_1(N^3 - K) \rightarrow \mathbf{Z}_n$  of the covering in a generator of  $\mathbf{Z}_n$  (up to equivalence, we can always suppose  $\omega(m) = 1$ ). Observe that a cyclic branched covering of a knot  $K$  in  $\mathbf{S}^3$  is always strongly-cyclic and is uniquely determined, up to equivalence, since  $H_1(\mathbf{S}^3 - K) \cong \mathbf{Z}$ . Obviously, this property is no longer true for a knot in a more general 3-manifold. Necessary and sufficient conditions for the existence and uniqueness of strongly-cyclic branched coverings of  $(1, 1)$ -knots have been obtained in [5].

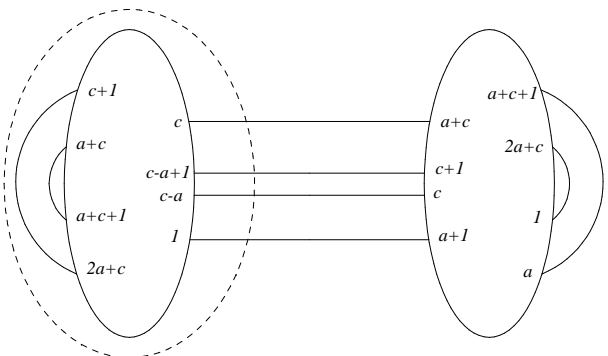

Figure 4:

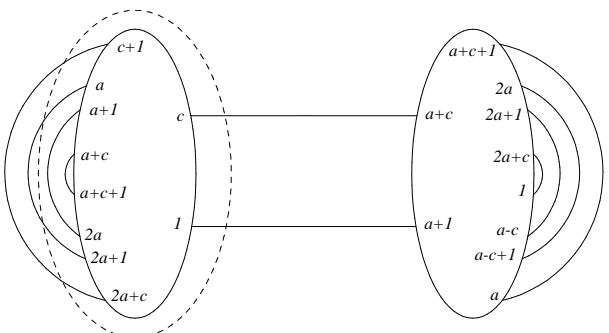
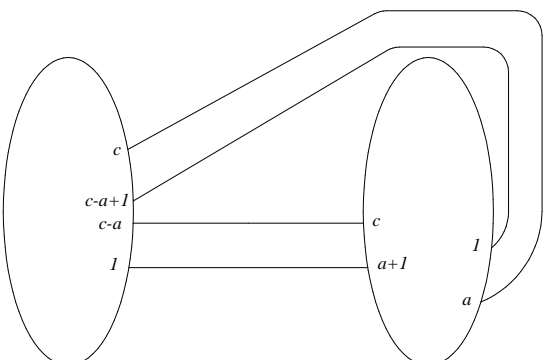
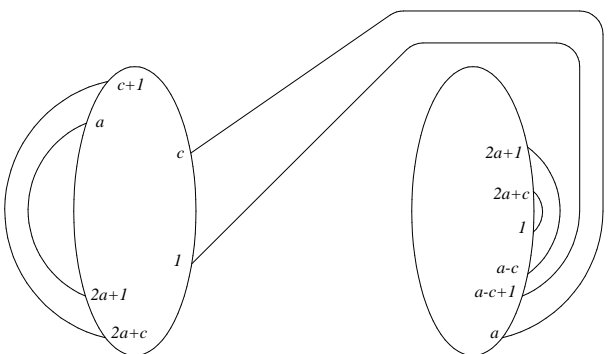

Figure 5:



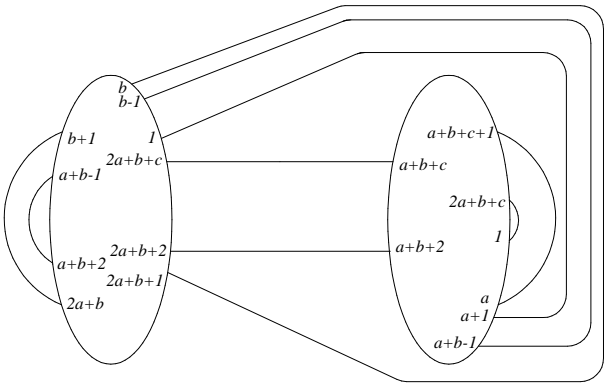
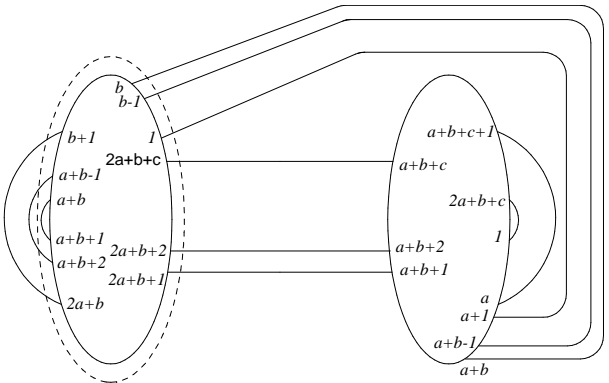

Figure 7:

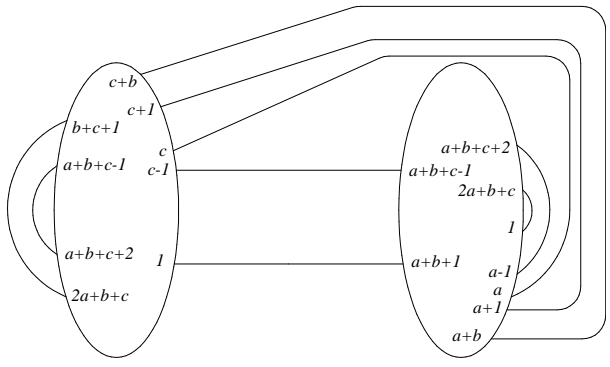
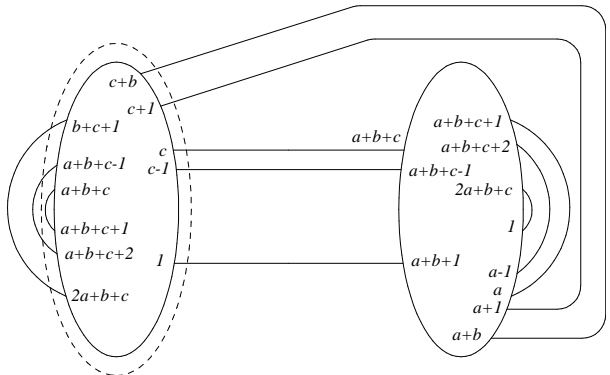

Figure 6:

### 3 Main results

Let  $n, p, q, l$  be positive integers such that  $q < p$  and  $\gcd(p, q) = 1$ . In the following we denote by  $\Sigma(n, p, q, l)$  the orientable Seifert manifold [28] with invariants

$$\{Oo, 0 \mid \underbrace{-1; (p, q), \dots, (p, q)}_{n \text{ times}}, (l, l-1)\}$$

having  $\mathbf{S}^2$  as orbit space,  $n$  exceptional fibres of type  $(p, q)$  and, for  $l > 1$ , an exceptional fibre of type  $(l, l-1)$ .

Observe that, in particular, the manifolds  $\Sigma(n, 2, 1, 1)$  are precisely the Neuwirth manifolds  $M_n$  introduced in [25], studied in [9], and generalized in [16], [31] and [27].

**Proposition 2** *The fundamental group of  $\Sigma(n, p, q, l)$  is cyclically presented by  $G_n(w)$ , where  $w = (x_1^q \cdots x_n^q)^l x_n^{-p}$ .*

**Proof.** Following [26], a standard presentation of  $G = \pi_1(\Sigma(n, p, q, l))$  is

$$\langle y_1, \dots, y_n, y, h \mid [y_i, h], [y, h], y_i^p h^q, y^l h^{l-1}, y_1 \cdots y_n y h; i = 1, \dots, n \rangle.$$

Since  $\gcd(p, q) = 1$ , there exist  $\alpha, \beta \in \mathbf{Z}$  such that  $q\beta - p\alpha = 1$ .

From the relations we have  $y^l h^{l-1} = (yh)^l h^{-1}$ . By introducing the new generator  $x = yh$ , the presentation becomes

$$\langle y_1, \dots, y_n, x, h \mid [y_i, h], [x, h], y_i^p h^q, x^l h^{-1}, y_1 \cdots y_n x; i = 1, \dots, n \rangle.$$

Now we define  $x_i = y_i^\beta h^\alpha$ , for  $i = 1, \dots, n$ . Then we have the following new presentation for  $G$ :

$$\langle y_1, \dots, y_n, x, h, x_1, \dots, x_n \mid [y_i, h], [x, h], y_i^p h^q, x^l h^{-1}, y_1 \cdots y_n x, x_i^{-1} y_i^\beta h^\alpha; i = 1, \dots, n \rangle.$$

From the relations we obtain  $x_i^q = y_i^{q\beta} h^{q\alpha} = y_i^{1+p\alpha} h^{q\alpha} = y_i (y_i^p h^q)^\alpha = y_i$  and  $x_i^p = y_i^{p\beta} h^{p\alpha} = y_i^{p\beta} h^{q\beta-1} = (y_i^p h^q)^\beta h^{-1} = h^{-1}$ .

Therefore  $G$  admits the presentation

$$\langle x, h, x_1, \dots, x_n \mid [x_i^q, x_i^{-p}], [x, x^l], x_i^{qp} x_i^{-qp}, x^l h^{-1}, x_1^q \cdots x_n^q x, x_i^{-1} x_i^{q\beta} x_i^{-p\alpha}, x_i^p h; i = 1, \dots, n \rangle,$$

which obviously becomes

$$\langle x, h, x_1, \dots, x_n \mid x^l h^{-1}, x_1^q \cdots x_n^q x, x_i^p h; i = 1, \dots, n \rangle.$$



From the relations we obtain  $x = (x_1^q \cdots x_n^q)^{-1}$  and  $h = (x_1^q \cdots x_n^q)^{-l}$ .

Therefore  $G$  admits the presentation:

$$\langle x_1, \dots, x_n \mid (x_1^q \cdots x_n^q)^l x_i^{-p}; i = 1, \dots, n \rangle,$$

which is equivalent to

$$\langle x_1, \dots, x_n \mid (x_1^q \cdots x_n^q)^l x_n^{-p}, x_i^p x_{i+1}^{-p}; i = 1, \dots, n-1 \rangle.$$

In order to prove that  $G$  is isomorphic to  $G_n(w)$ , it suffices to show that the normal closures in the free group  $F_n$  of the sets  $\{w, x_i^p x_{i+1}^{-p}; i = 1, \dots, n-1\}$  and  $\{w, \theta^i(w); i = 1, \dots, n-1\}$  coincide.

This is achieved by observing that, setting  $w_i = \theta^i(w)$ , we have:

$$w_i^{-1} x_{i+1}^q w_{i+1} x_{i+1}^{-q} = x_i^p x_{i+1}^{-p}, \text{ for } i = 1, \dots, n-2,$$

$$w_{n-1}^{-1} x_n^q w_n x_n^{-q} = x_{n-1}^p x_n^{-p},$$

$$x_1^{-q} w ((x_1^p x_2^{-p}) \cdots (x_{n-1}^p x_n^{-p}))^{-1} x_1^q = w_1,$$

$$x_i^{-q} w_{i-1} (x_{i-1}^p x_i^{-p}) x_i^q = w_i, \text{ for } i = 2, \dots, n-1.$$

■

Since a Seifert manifold with one or two singular fibers is trivially a lens space (see [26]), we will suppose  $n > 1$  and  $l > 1$  when  $n = 2$ .

**Theorem 3** *The Seifert manifold  $\Sigma(n, p, q, l)$  is the  $n$ -fold strongly-cyclic covering of the lens space  $L(|nlq - p|, q)$ , branched over the  $(1, 1)$ -knot  $K(q, q(nl - 2), p - 2q, p - q)$ , if  $p \geq 2q$ , and over the  $(1, 1)$ -knot  $K(p - q, 2q - p, q(nl - 2), p - q)$ , if  $p < 2q$ .*

**Proof.** (i) Suppose  $p \geq 2q$ . By (iii) of Lemma 1,  $K = K(q, q(nl - 2), p - 2q, p - q)$  is a  $(1, 1)$ -knot in  $L(|nlq - p|, q)$ . Now suppose that  $K$  admits the  $n$ -fold strongly-cyclic branched covering  $C_n(K)$  defined by  $\omega(\alpha) = 0$  and  $\omega(\gamma) = 1$ . In this case  $C_n(K)$  is the Dunwoody manifold  $D(q, q(nl - 2), p - 2q, n, p - q, 0)$  (see [15] and [7]). Its defining genus  $n$  Heegaard diagram, having cyclic symmetry of order  $n$ , is depicted in Figure 8, where  $a = q, b = q(nl - 2), c = p - 2q, r = p - q$ , and the circle  $C'_i$  must be glued to the circle  $C''_i$ , for  $i = 1, \dots, n$ , according to the twist parameter  $r$ . In order to check if the above diagram really represents a manifold, it is convenient to consider the cellular decomposition dual to the one associated to the diagram. In this way,  $C_n(K)$  is obtained by pairwise identification of the regions of the 2-cell tessellation of the boundary of a 3-ball, as depicted in Figure 9. The tessellation consists of  $2n$  regions,  $R'_1, \dots, R'_n$  around the North pole  $N$  and

$R''_1, \dots, R''_n$  around the South pole  $S$ , corresponding to the cycles  $C'_i$  and  $C''_i$  of the diagram. The edges of the tessellation correspond to the arcs of the diagram in the following way. The poles  $S$  and  $N$  are connected by  $n$  meridians and each meridian  $m_i$  is composed by  $nlq$  edges  $e_{i,j}$  ( $j = 1, \dots, nlq$ ) from  $S$  to  $N$ , and precisely  $q$  from  $S$  to  $B_i$ ,  $q(nl - 2)$  from  $B_i$  to  $A_i$  and  $q$  from  $A_i$  to  $N$ . Moreover, for  $i = 1, \dots, n$ , the arc  $a_i$  connecting  $B_{i-1}$  with  $A_i$  is composed by  $p - 2q$  edges  $e'_{i,j}$  ( $j = 1, \dots, p - 2q$ ). Observe that, when  $p = 2q$  (i.e.,  $p = 2$  and  $q = 1$ ), the points  $B_{i-1}$  and  $A_i$  coincide. In order to obtain  $C_n(K)$ , the region  $R'_i$  is glued to  $R''_i$ , for  $i = 1, \dots, n$ , by an orientation reversing homeomorphism in such a way that point  $S$  of  $R''_i$  matches point<sup>2</sup>  $B_{i-1}$  of  $R'_i$ . By this gluing we have:  $e_{i,j} \equiv e_{i-1,j+q}$  for  $j = 1, \dots, q(nl - 1)$ ,  $e_{i-1,j} \equiv e'_{i,j}$  for  $j = 1, \dots, q$ ,  $e'_{i,j} \equiv e'_{i,j+q}$  for  $j = 1, \dots, p - 3q$ , and  $e'_{i,p-3q+k} \equiv e_{i,q(nl-1)+k}$  for  $k = 1, \dots, q$ . As a consequence of all identifications, we have  $e_{i,j} \equiv e_{i,j+nq} \equiv \dots \equiv e_{i,j+n(l-1)q}$  for  $j = 1, \dots, nq$ , and moreover  $e_{i-1,j} \equiv e_{i,q(nl-1)+j}$  for  $j = 1, \dots, q$ . Since  $\gcd(p, q) = 1$ , all edges of the arcs  $SB_{i-1}$ ,  $B_{i-1}A_i$  and  $A_iN$  match, and we will call them  $x_i$ . Therefore, the  $q(nl - 2)$  edges of the arc  $B_iA_i$  become:  $q$  times  $x_{i+1}$ ,  $q$  times  $x_{i+2}$ ,  $\dots$ ,  $q$  times  $x_i$  ( $l - 1$  times) and then  $q$  times  $x_{i+1}$ ,  $q$  times  $x_{i+2}$ ,  $\dots$ ,  $q$  times  $x_{i-2}$  (see Figure 10). Since each edge  $x_i$  appears  $p$  times consecutively, its endpoints coincide. Moreover, since every edge  $x_i$  has  $S$  as endpoint, the cellular decomposition of  $C_n(K)$  is composed by one vertex,  $n$  edges,  $n$  regions and one 3-ball. By Seifert criterion,  $C_n(K)$  is actually a closed, orientable 3-manifold.

Moreover,  $\pi_1(C_n(K))$  admits a balanced presentation with  $x_1, \dots, x_n$  as generators and with relators obtained by walking around the boundaries of the regions  $R'_i$ . As a consequence,  $\pi_1(C_n(K)) = G_n((x_1^q \cdots x_n^q)^l x_n^{-p})$ , and therefore it is isomorphic to  $\pi_1(\Sigma(n, p, q, l))$ .

In order to prove that  $C_n(K)$  and  $\Sigma(n, p, q, l)$  are actually homeomorphic, we note that  $\pi_1(C_n(K))$  has non-trivial centre. So, either  $C_n(K)$  is prime or is the connected sum  $C_n(K) = M \# M'$ , where  $\pi_1(M')$  is trivial and  $M$  is prime, with  $\pi_1(M) = \pi_1(C_n(K))$ .

If  $\Sigma(n, p, q, l)$  is large (in the sense of [26]), then also  $M$  is a large Seifert manifold (see [4]). So  $M$  and  $\Sigma(n, p, q, l)$  are homeomorphic, with Heegaard genus at least  $n - 2$  (see [2]). If  $M'$  is not homeomorphic to  $\mathbf{S}^3$ , then its Heegaard genus is greater than two, and  $C_n(K)$  has Heegaard genus greater than  $n$ . But this is impossible since  $C_n(K)$  admits a genus  $n$  Heegaard

---

<sup>2</sup>The subscript  $i$  is considered mod  $n$ .

splitting by [24]. As a consequence,  $M' = \mathbf{S}^3$  and  $C_n(K) = \Sigma(n, p, q, l)$ .

If  $\Sigma(n, p, q, l)$  is not large, then one of the following possibilities holds: (a)  $n = 3, p = 2, q = 1 = l$ ; (b)  $n = 2, p = 2, q = 1, l > 1$ ; (c)  $n = 2, p = 3, q = 1, l = 2$ . Since for  $q = 1$  the given decomposition of  $C_n(K)$  coincides with the decomposition  $P(p, \dots, p; l)$  given in [27], the result follows from [27, Proposition 4.1].

(ii) Let  $p < 2q$ . By (ii) of Lemma 1,  $K(p - q, 2q - p, q(nl - 2), p - q)$  is a  $(1, 1)$ -knot in  $L(|nlq - p|, q)$ . Now suppose that  $K$  admits the  $n$ -fold strongly-cyclic branched covering  $C_n(K)$  defined by  $\omega(\alpha) = 1$  and  $\omega(\gamma) = 1$ . In this case  $C_n(K)$  is the Dunwoody manifold  $D(p - q, 2q - p, q(nl - 2), n, p - q, 1)$ . Its defining genus  $n$  Heegaard diagram, having cyclic symmetry of order  $n$ , is depicted in Figure 8, where  $a = p - q, b = 2q - p, c = q(nl - 2), r = p - q$ , and the circle  $C'_i$  must be glued to the circle  $C''_{i+1}$ , for  $i = 1, \dots, n$ , according to the twist parameter  $r$ . Again it is better to refer to the dual decomposition (see Figure 9). This time each meridian is composed by  $p$  edges, and precisely  $p - q$  from  $S$  to  $B_i$ ,  $2q - p$  from  $B_i$  to  $A_i$  and  $p - q$  from  $A_i$  to  $N$ . Moreover, the arc connecting  $B_{i-1}$  with  $A_i$  is composed by  $q(nl - 2)$  edges. In order to obtain  $C_n(K)$ , the region  $R'_{i-1}$  is glued to  $R''_i$  in such a way that point  $N$  of  $R'_{i-1}$  matches point  $B_{i-1}$  of  $R''_i$ .

In complete analogy with point (i), it is easy to see that the gluing gives rise to a cellular decomposition of  $C_n(K)$ , composed by one vertex,  $n$  edges,  $n$  regions and one 3-ball (see the 2-skeleton in Figure 11). So  $\pi_1(\Sigma(n, p, q, l))$  is isomorphic to  $\pi_1(C_n(K))$  and  $\Sigma(n, p, q, l)$  is homeomorphic to  $C_n(K)$  when it is large. The only small Seifert manifold occurs when  $n = q = l = 2, p = 3$ . To achieve the result, it suffices to prove that  $D = D(1, 1, 4, 2, 1, 1)$  is the 2-fold covering of  $\mathbf{S}^3$ , branched over the Montesinos knot  $\mathbf{m}(-1; 1/2, 2/3, 2/3)$  (see [3, Chapter 12]). A genus two Heegaard diagram of  $D$  is depicted in Figure 12, where the circle  $C'_1$  (resp.  $C'_2$ ) must be glued to the circle  $C''_2$  (resp.  $C''_1$ ) in such a way that equally labelled vertices match. The application of the Takahashi algorithm [32] to this diagram (as depicted in Figure 13) shows that the manifold  $D$  is the 2-fold branched covering of the knot  $K$  represented by the 3-bridge diagram of Figure 14. A Wirtinger presentation of the fundamental group of the exterior of  $K$  can be easily computed from this diagram, obtaining  $\pi_1(\mathbf{S}^3 - K) = \langle x, y, z \mid yz^{-1}xzy^{-1}xyzy^{-1}x^{-1}zy^{-1}z^{-1}, x^{-1}zyz^{-1}xzx^{-1}zy^{-1}z^{-1}xy^{-1} \rangle$ . The Alexander polynomial of  $K$  can be obtained by a standard application of Fox differential calculus (see [3, Chapter 9]), and we have  $\Delta_K(t) = 1 - 4t + 5t^2 - 4t^3 + t^4$ . By the sequence of Reidemeister moves depicted in Figures 15-17, the knot  $K$

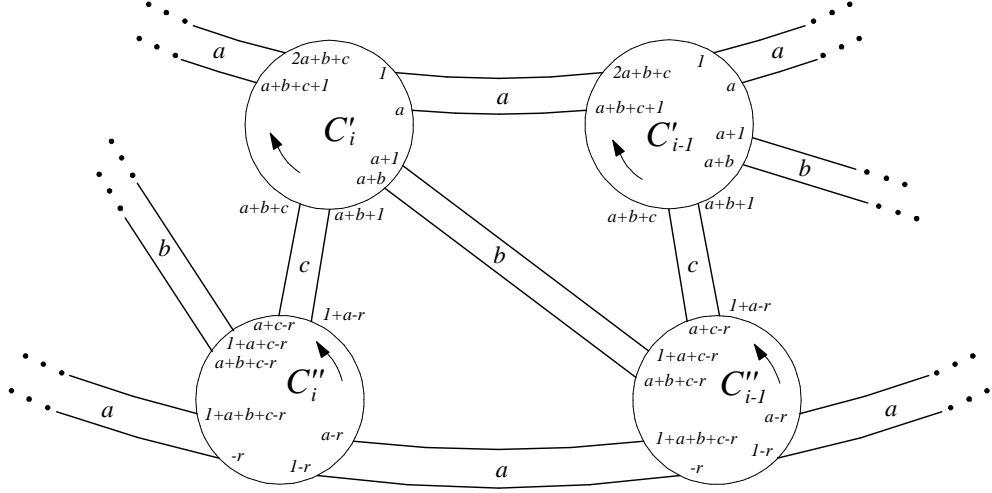

Figure 8:

admits the 9 crossing diagram of Figure 17. Since the knot  $8_{21}$  of Rolfsen's table is the only knot with crossing number  $\leq 9$  with Alexander polynomial  $1 - 4t + 5t^2 - 4t^3 + t^4$  (see [19, Table 3]), then  $K$  is precisely the knot  $8_{21}$ . Since  $8_{21}$  is the Montesinos knot  $\mathbf{m}(-1; 1/2, 2/3, 2/3)$  (see [19, Table 2], which uses a slightly different notation), the statement is proved. ■

Observe that Theorem 3 refines and extends the results of [13, Theorem 4.2] and [30, Theorem 5.1]. The proof of Theorem 3 also gives the following:

**Corollary 4** *The Seifert manifold  $\Sigma(n, p, q, l)$  is the Dunwoody manifold  $D(q, q(nl - 2), p - 2q, n, p - q, 0)$  if  $p \geq 2q$  and the Dunwoody manifold  $D(p - q, 2q - p, q(nl - 2), n, p - q, 1)$  if  $p < 2q$ .*

**Remark** Since  $\Sigma(n, p, p - 1, 1) = \Sigma(n - 1, p, p - 1, p)$ , this manifold is at the same time the  $n$ -fold strongly-cyclic covering of the lens space  $L(pn - p - n, p - 1)$ , branched over the  $(1, 1)$ -knot  $K(1, p - 2, (p - 1)(n - 2), 1)$  and the  $(n - 1)$ -fold strongly-cyclic covering of the lens space  $L(p(pn - p - n), p - 1)$ , branched over the  $(1, 1)$ -knot  $K(1, p - 2, (p - 1)(np - p - 2), 1)$ , when  $p > 2$ . Moreover, the Neuwirth manifold  $M_n = \Sigma(n, 2, 1, 1) = \Sigma(n - 1, 2, 1, 2)$  is at the same time the  $n$ -fold strongly-cyclic covering of the lens space  $L(n - 2, 1)$ , branched over the  $(1, 1)$ -knot  $K(1, n - 2, 0, 1)$  and the  $(n - 1)$ -fold strongly-cyclic covering of the lens space  $L(2n - 4, 1)$ , branched over the  $(1, 1)$ -knot  $K(1, 2n - 4, 0, 1)$ .

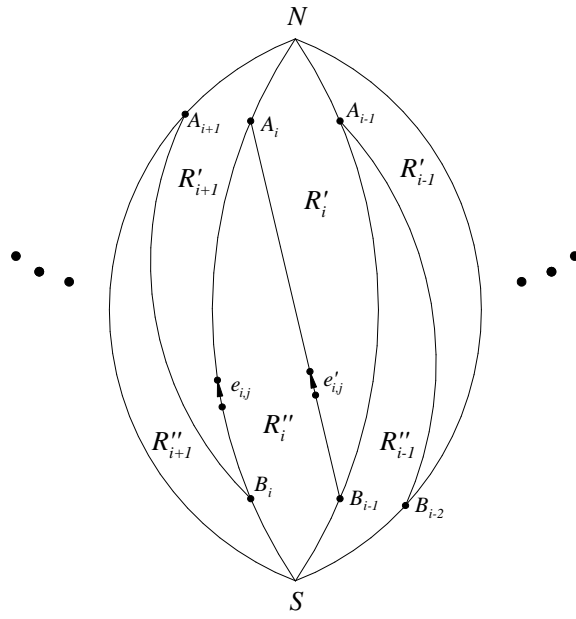

Figure 9:

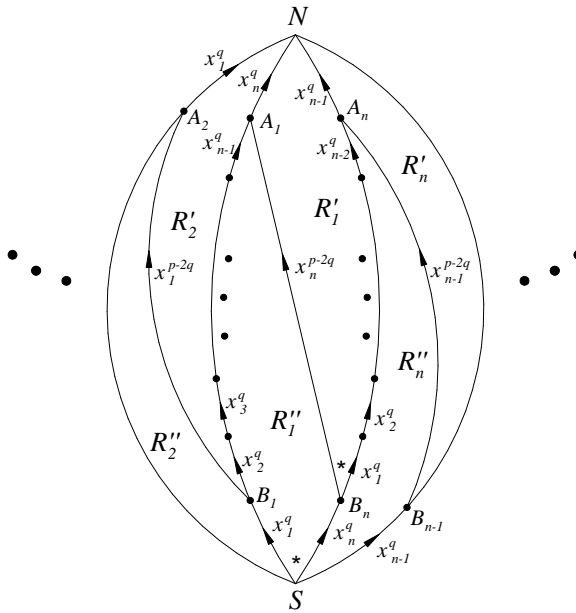

Figure 10: Case  $p \geq 2q$

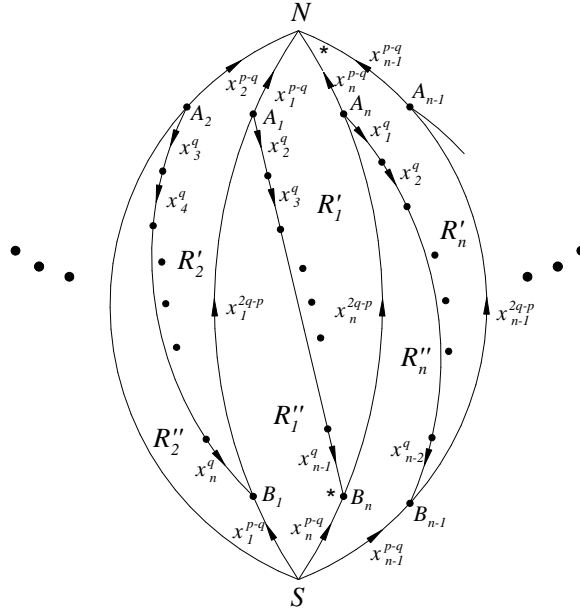

Figure 11: Case  $p < 2q$

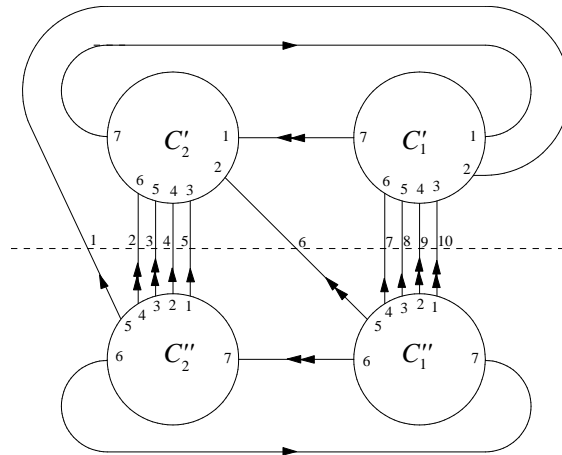

Figure 12:  $D(1, 1, 4, 2, 1, 1)$

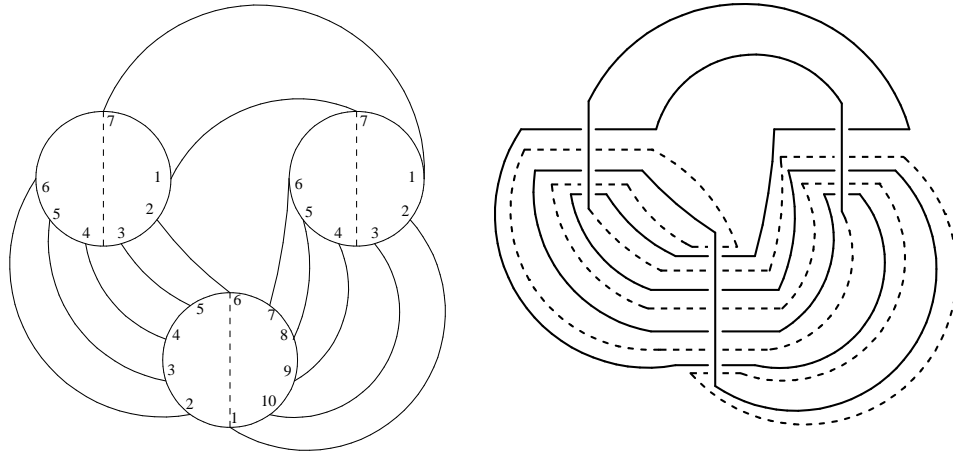

Figure 13:

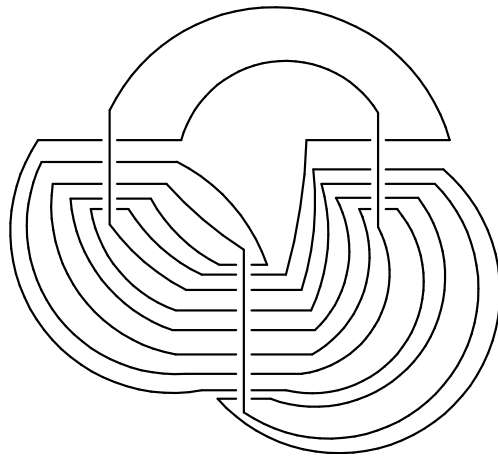

Figure 14:

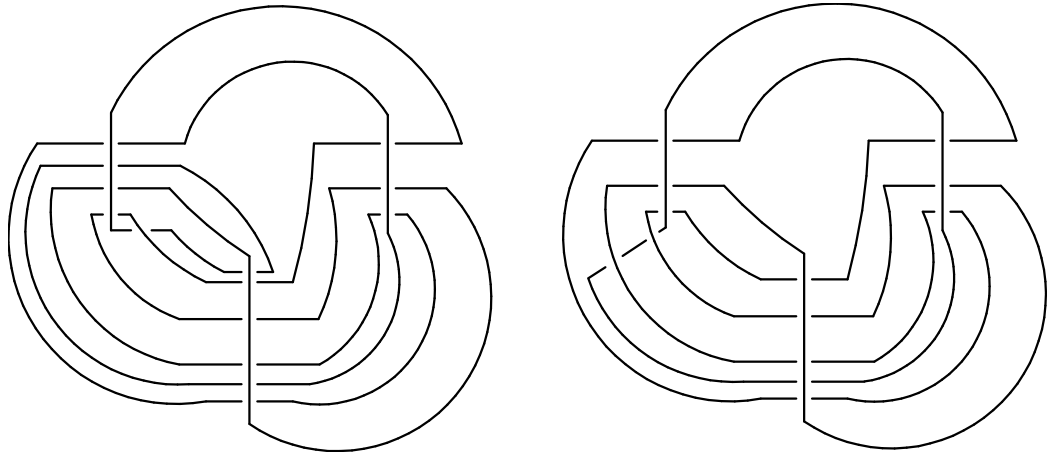

Figure 15:

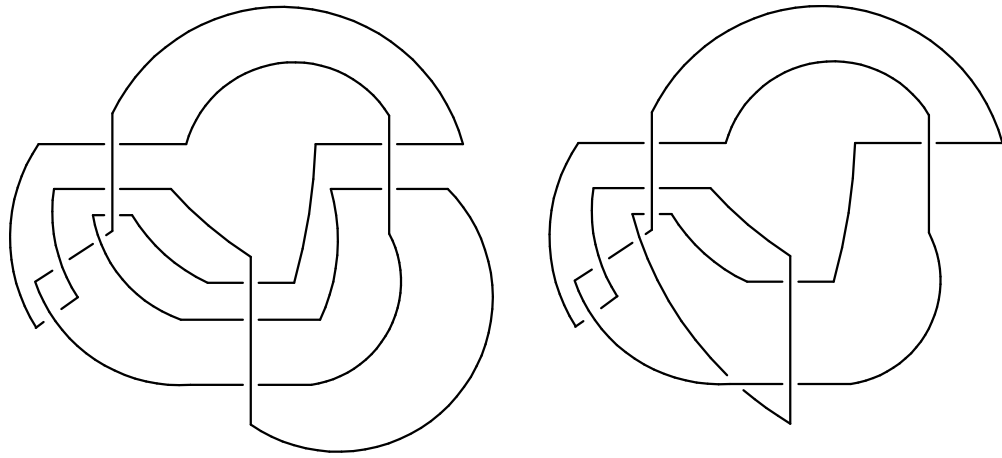

Figure 16:



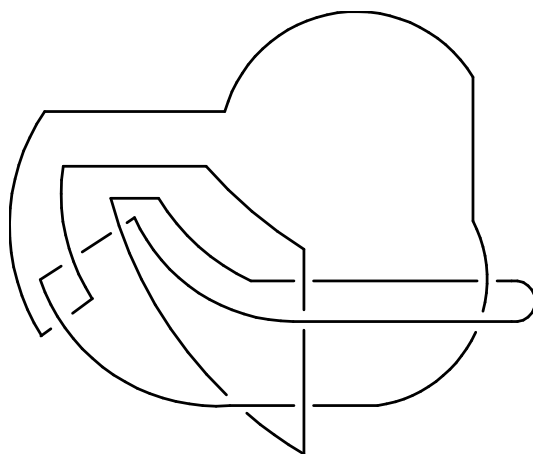

Figure 17:

### Acknowledgements

Work performed under the auspices of the G.N.S.A.G.A. of I.N.d.A.M. (Italy) and the University of Bologna, funds for selected research topics.

### References

- [1] P. Bandieri, A. C. Kim and M. Mulazzani: *On the cyclic coverings of the knot  $5_2$* . Proc. Edinb. Math. Soc. **42** (1999), 575–587.
- [2] M. Boileau and H. Zieschang: *Heegaard genus of closed orientable Seifert 3-manifolds*. Invent. Math. **76** (1984), 455–468.
- [3] G. Burde and H. Zieschang: *Knots*. De Gruyter Studies in Mathematics, 5. Walter de Gruyter, 1985.
- [4] A. Casson and D. Jungreis: *Convergence groups and Seifert fibered 3-manifolds*. Invent. Math. **118** (1994), 441–456.
- [5] A. Cattabriga and M. Mulazzani: *Strongly-cyclic branched coverings of  $(1, 1)$ -knots and cyclic presentation of groups*. Math. Proc. Camb. Philos. Soc. **135** (2003), 137–146.

- [6] A. Cattabriga and M. Mulazzani: *(1, 1)-knots via the mapping class group of the twice punctured torus*. Adv. Geom. **4** (2004), 263–277.
- [7] A. Cattabriga and M. Mulazzani: *All strongly-cyclic branched coverings of (1, 1)-knots are Dunwoody manifolds*. J. London Math. Soc. **70** (2004), 512–528.
- [8] A. Cattabriga and M. Mulazzani: *Representations of (1, 1)-knots*. to appear in Fundamenta Mathematicae, Proceedings of the Second International Conference “Knots in Poland 2003”, Vol. II (2005). arXiv:math.GT/0501234
- [9] A. Cavicchioli: *Newwirth manifolds and colourings of graphs*. Aequationes Math. **44** (1992), 168–187.
- [10] A. Cavicchioli, F. Hegenbarth and A. C. Kim: *A geometric study of Sieradsky groups*. Algebra Colloq. **5** (1998), 203–217.
- [11] A. Cavicchioli, F. Hegenbarth and A. C. Kim: *On cyclic branched coverings of torus knots*. J. Geom. **64** (1999), 55–66.
- [12] A. Cavicchioli, F. Hegenbarth and D. Repovs: *On manifold spines and cyclic presentations of groups*. In: Knot theory. Proceedings of the mini-semester, Warsaw, Poland, July 13–August 17, 1995. Warszawa: Polish Academy of Sciences, Institute of Mathematics, Banach Cent. Publ. **42** (1998), 49–56.
- [13] A. Cavicchioli, D. Repovs and F. Spaggiari: *Topological properties of cyclically presented groups*. J. Knot Theory Ramifications **12** (2003), 243–268.
- [14] M. J. Dunwoody: *Cyclic presentations and 3-manifolds*. In: Proc. Inter. Conf., Groups-Korea '94, Walter de Gruyter, Berlin-New York (1995), 47–55.
- [15] L. Grasselli and M. Mulazzani: *Genus one 1-bridge knots and Dunwoody manifolds*. Forum Math. **13** (2001), 379–397.
- [16] L. Grasselli and S. Piccarreta: *Crystallizations of generalized Newwirth manifolds*. Forum Math. **9** (1997), 669–685.

- [17] H. Helling, A. C. Kim and J. L. Mennicke: *A geometric study of Fibonacci groups*. J. Lie Theory **8** (1998), 1-23.
- [18] D. L. Johnson: *Topics in the theory of group presentations*. London Math. Soc. Lect. Note Ser., vol. 42, Cambridge Univ. Press, Cambridge, U.K., 1980.
- [19] A. Kawauchi: *A survey of knot theory*. Birkhauser Verlag, Basel, 1996.
- [20] A. C. Kim: *On the Fibonacci group and related topics*. Contemp. Math. **184** (1995), 231–235.
- [21] A. C. Kim, Y. Kim and A. Vesnin: *On a class of cyclically presented groups*. In: Proc. Inter. Conf., Groups-Korea '98, Walter de Gruyter, Berlin-New York (2000), 211–220.
- [22] G. Kim, Y. Kim and A. Vesnin: *The knot  $5_2$  and cyclically presented groups*. J. Korean Math. Soc. **35** (1998), 961–980.
- [23] C. Maclachlan and A. W. Reid: *Generalised Fibonacci manifolds*. Transform. Groups **2** (1997), 165–182.
- [24] M. Mulazzani: *Cyclic presentations of groups and cyclic branched coverings of  $(1, 1)$ -knots*. Bull. Korean Math. Soc. **40** (2003), 101–108.
- [25] L. Neuwirth: *An algorithm for the construction of 3-manifolds from 2-complexes*. Proc. Camb. Philos. Soc. **64** (1968), 603–613.
- [26] P. Orlik: *Seifert manifolds*. Lecture Notes in Mathematics, Vol. 291. Springer-Verlag, Berlin-New York, 1972.
- [27] B. Ruini, F. Spaggiari and A. Vesnin: *On spines of Seifert fibered manifolds*. Aequationes Math. **65** (2003), 40–60.
- [28] H. Seifert and W. Threlfall: *Seifert and Threlfall: a textbook of topology*. Pure and Applied Mathematics, 89. Academic Press, New York-London, 1980.
- [29] J. Singer: *Three-dimensional manifolds and their Heegaard diagrams*. Trans. Amer. Math. Soc. **35** (1933), 88-111.

- [30] F. Spaggiari: *The combinatorics of some Tetrahedron manifolds*. Discrete Math., to appear.
- [31] A. Szczepański and A. Vesnin: *Generalized Neuwirth groups and Seifert fibered manifolds*. Algebra Colloq. **7** (2000), 295–303.
- [32] M. Takahashi: *Two knots with the same 2-fold branched covering space*. Yokohama Math. J. **25** (1977), 91-99.
- [33] A. Vesnin and A. C. Kim: *The fractional Fibonacci groups and manifolds*. Sib. Math. J. **39** (1998), 655–664.

LUIGI GRASSELLI, Department of Sciences and Methods for Engineering, University of Modena and Reggio Emilia, 42100 Reggio Emilia, ITALY. E-mail: grasselli.luigi@unimore.it

MICHELE MULAZZANI, Department of Mathematics, University of Bologna, I-40127 Bologna, ITALY, and C.I.R.A.M., Bologna, ITALY. E-mail: mulazza@dm.unibo.it